







# ARCHITECT AND ENGINEER

HILLSIDE HOME . . . Eugene, Oregon



CLARE K. HAMLIN, Architect

**JANUARY**

**1953**

---

Architects in the West  
Say  
They Read the  
**ARCHITECT and ENGINEER**

In Preference to All Other  
Architectural Publications

*(Result of fact finding survey made by San Francisco Advertising  
Agency for one of their clients. Agency identified on request.)*



FOR PREFERRED READING  
ADVERTISE IN THE  
**ARCHITECT and ENGINEER**

EXBROOK 2-7182 • 68 POST STREET • SAN FRANCISCO

---

# ARCHITECT

# AND ENGINEER

+7205 VOL. 192

NO. 1

Ar 24 192

685798

ARCHITECTS' REPORTS—Published Daily

## Contents for

# JANUARY

**EDWIN H. WILDER**  
Editor

**J. WELLS HASTINGS**  
Contributing Editor

**PROF. LELAND VAUGHAN**  
Landscape Architecture

**JOHN A. BLUME**  
Structural Engineering

**MICHAEL GOODMAN**  
Planning

**JOHN S. BOLLES, A.I.A.**  
Book Reviews



### COVER PICTURE:

#### HILLSIDE HOME

Mr. & Mrs. Nils B. Hult  
Eugene, Oregon

"On the slopes of Old Baldy, in the Bailey Hill district west of Eugene, Architect Clare K. Hamlin has created for Mr. and Mrs. Nils B. Hult one of Oregon's most distinctive homes." Intimacy and simplicity are emphasized with the swimming pool, lounging area, and view of valley below a combination rare in residential home site.

For complete details of this unusual home see Page 12.

Photo by  
TOM BURNS, JR.

ARCHITECT & ENGINEER

is indexed regularly by

ENGINEERING INDEX, INC.

EDITORIAL NOTES . . . . .	4
NEWS & COMMENT ON ART . . . . .	6
COLUMBIA BASIN HOME—Built in a Day . . . . .	7
MODERN RESIDENCE—Mr. & Mrs. Francis Carroll, San Francisco . . . . .	8
BOLTON WHITE, JACK HERMANN, Architects	
HILLSIDE HOME—One of Oregon's Finest. Mr. & Mrs. Nils B. Hult, Eugene, Oregon . . . . .	12
CLARE K. HAMLIN, Architect; CARL J. RATH, General Contractor By ARTHUR W. PRIAULX	
AMONG AUSTRALIA'S HOMES—Looking at Progressive Architecture . . . . .	20
By GEORGE FARWELL	
A. I. A. ACTIVITIES . . . . .	26
WITH THE ENGINEERS . . . . .	28
PRODUCERS COUNCIL PAGE . . . . .	30
Edited by PHIL BROWN, Otis Elevator Company	
BOOK REVIEWS, Pamphlets and Catalogues . . . . .	36
ESTIMATOR'S GUIDE, Building and Construction Materials . . . . .	39
ESTIMATOR'S DIRECTORY, Building and Construction Materials . . . . .	41
BUILDING TRADES WAGE SCALES, Northern, Central & Southern California	42
CLASSIFIED ADVERTISING . . . . .	43
CONSTRUCTION CONTRACTS AWARDED and Miscellaneous Data . . . . .	44
IN THE NEWS . . . . .	46
INDEX TO ADVERTISERS . . . . .	48

ARCHITECT AND ENGINEER (Established 1905) is published on the 15th of the month by The Architect and Engineer, Inc., 68 Post St., San Francisco 4; Telephone EXbrook 2-7182. President, K. P. Kierulff; Vice-President and Manager, L. B. Penhorwood; Treasurer, E. N. Kierulff.

Los Angeles Office: Wentworth F. Green, 439 So. Western Ave., Los Angeles 5; Telephone DUnglirk 7-8135.

Entered as second class matter, November 2, 1905, at the Post Office in San Francisco, California, under the Act of March 3, 1879. Subscriptions United States and Pan America, \$3.00 a year; \$5.00 two years; foreign countries \$5.00 a year; single copy 50c. ARCHITECTS' REPORTS are published daily from this office, Vernon S. Yallop, Manager. Telephone DOuglas 2-8311.



# EDITORIAL NOTES

## ANNIVERSARY

This issue marks the beginning of another year of publication of *The Architect & Engineer*—Vol. 192, No. 1.

Each issue of *The Architect & Engineer* magazine during the past forty-seven years has been devoted to the architectural and engineering profession, to the contracting business, and to the construction industry. Each issue has recorded an account of development in the West's vast construction industry—of residential, commercial, industrial, highway, and engineering progress. Each issue has also chronicled the advance in architectural design, the progress in engineering skill, the development of construction methods and know-how, and the tremendous advancement that has been made since the turn of the century in building and construction materials.

*Architect & Engineer* magazine has championed the architect, engineer, contractor, and building material manufacturer with the public—endeavoring with each issue to further the best interests of the construction industry with the public in general and those in government service who have been charged with the responsibility of public works development.

We are proud of our function in serving these factors which are so vital to the growth and prosperity of the West, and we feel this is a fitting time to pledge anew our determination to further serve those we directly, and indirectly, represent throughout the great fields of architectural, engineering, contracting and construction industry effort.

\* \* \*

*"The future of our profession and our people is today's challenge":—Glenn Stanton, American Institute of Architects, President.*

\* \* \*

## YOU'VE JUST STARTED

With the November election fast becoming history, many voters feel they have done their duty and can afford to forget about political problems for a while. They think that electing a new Congress and a new President will solve everything automatically.

Such is not the case.

All of the problems aired during the campaign—plus a great many more—are still with us.

Instead of indulging in a general let-down, the American people now have an opportunity to improve their government by directing their energies and using their influence to see that national problems are solved.

This could, and would, happen if more persons

were to realize that issues at stake in the election were more important than the men who ran for office; that the election did not really solve any issues; that it remains for the men elected to Congress and to President Eisenhower to work out the right solutions.

It is not hard to see where the citizen can be active and most effective in the months ahead as the new budget and other important issues are considered by Congress.

First, government spending must be reduced. One way in which President Eisenhower can save money is to clamp down on the waste and extravagance that has been exposed in Washington. Economy will not come easy to the new administration unless all the people pitch in and help.

You can do your part by asking less of the federal government and by doing more things which you used to do for yourself.

Second, the Eisenhower administration will inherit a tremendous and costly system of benefits and subsidies—to farmers, veterans, colleges, aged persons, dependent children, the blind, the unemployed and many others. All of these programs are desirable, of course, but the job is to decide which of them can properly be turned back to the States, so that the size and the expense of federal government can be cut.

Third, Communism is as much with us today as it was a week before the election. And people in Europe want just as much aid from the United States today as they did yesterday.

The people who went to the polls last November performed one major requirement of good citizenship, but there is more to be done. Are you ready for the task that lies ahead?

\* \* \*

*Socialism, or so-called "parlor pinks", is in reality junior grade communism looking for a promotion.*

\* \* \*

## A DUBIOUS HONOR

By the time President Harry Truman leaves office on January 20th, his administration will have collected 59 percent of all the federal taxes collected in American history, spent 45 percent of all the federal money spent in American history, and added \$33-billion to the national debt.

One President, and his administration, has collected since April 12, 1945, nearly \$93-billion more in federal taxes than all other presidents combined in the 163-year history of the nation, including Franklin D. Roosevelt who wasn't a piker when it came to taxing the American public.





*New Sunset District Firehouse, San Francisco: Architect, J. S. Gould, A.I.A.; Structural Engineer, John A. Blume; City Hall Architect, Dodge A. R.*

## *CLAY BRICK and Architectural Skill Combine to make a Firehouse A THING OF BEAUTY*

**F**RIENDLY neighborhood acceptance is usually a major problem in site selection for a Firehouse. Colorful Clay Brick plus good design gives the structure a handsome appearance . . . that "substantial look" that blends in with nice surroundings—wins friendly acceptance. Neighbors know too

that in years to come Clay Brick will stay that way indefinitely. And taxpayers need no reminding that Clay Brick requires no painting, entails practically no upkeep. Firehouse or schoolhouse, factory or store—whatever you're planning—consider the exceptional qualities of Clay Brick.

### **CLAY BRICK & TILE ASSOCIATION**

**55 NEW MONTGOMERY STREET • SAN FRANCISCO**

*In the interest of better brick and tile construction the following companies  
have contributed to the publication of this reprint.*

KRAFTILE COMPANY  
L. P. McNEAR BRICK COMPANY  
PORT COSTA BRICK WORKS

REMILLARD - DANDINI COMPANY  
SAN JOSE BRICK AND TILE, LTD.  
STOCKTON BRICK & TILE COMPANY

UNITED MATERIALS & RICHMOND BRICK CO.

# NEWS and COMMENT ON ART



## POTTERY EXHIBIT AT DeYOUNG MEMORIAL MUSEUM BY SANDERS

An exhibition of Pottery by Herbert Sanders is currently being shown at the M. H. DeYoung Memorial Museum in Golden Gate Park, San Francisco.

Dr. Sanders, a member of the teaching staff at San Jose State College, has exhibited throughout the United States and has work in a number of American Museum collections including the Metropolitan Art Museum, the Syracuse Museum of Fine Arts, and the University of California Decorative Arts Collection. He is also the winner of a number of awards in the field of ceramics.

## NORTHWEST CRAFTSMEN EXHIBIT AT UNIVERSITY OF WASHINGTON

A juried exhibition will be held March 8 through April 8, by Northwest Craftsmen in the Henry Gallery at the University of Washington, Seattle. The event is being sponsored by the Henry Gallery, Lambda Rho Alumnae, The Seattle Clay Club, and the Seattle Weavers' Guild.

The exhibition is designed to encourage original contemporary design through competitive exhibi-

tion and will include ceramics and ceramic sculpture, jewelry, enamel work, metal work, wooden containers and tableware, woven textiles, decorated fabrics, and lamps.

## M. H. deYOUNG MEMORIAL MUSEUM

The M. H. deYoung Memorial Museum, Golden Gate Park, San Francisco, under the direction of Walter Heil, starts the new year with a group of special exhibitions in a number of art fields.

EXHIBITIONS: Restrospective Exhibition of Paintings by Jack Levine; Fifty Contemporary Portraits—Photographs by Sanford H. Roth; Paintings by Claude Venard; Angkor—Photographs by Ernest G. Rathenau; Models of Inventions by Leonardo Da Vinci; and Pottery by Herbert Sanders.

## CITY OF PARIS

The Rotunda Gallery of the City of Paris, San Francisco, under the direction of Beatrice Judd Ryan, has arranged an Exhibition of recent paintings featuring a Commedia Dell' Arte Sequence by Angna Enters and an exhibit of Ceramic Sculpture

(See Page 31)



**MASK**—from patlatch dish carved in the form of a reclining human figure. The head forms a bowl of which the mask is a cover.

Kwokiutl

## PORTLAND ART MUSEUM

West Park and Madison

ROMAN  
GLASS  
MINIATURE

Amphora, opaque blue.





*Photos Douglas Fir Plywood Association*

# COLUMBIA BASIN RANCH HOME BUILT IN A DAY

**THE BONES OF THE HOUSE**





*Photos by Dean Stone & Hugo Steccati*

TWIN PEAKS SITE OF  
**MODERN RESIDENCE**  
SAN FRANCISCO, CALIFORNIA

Architects: BOLTON WHITE  
JACK HERMANN

Landscape Architects: ECKBO, ROYSTON & WILLIAMS



**Location and Site:**

Steep lot on North slope of Twin Peaks, East of Sutro Forest. Sweeping view to the northwest, north and northeast encompassing area from Point Reyes to Oakland Bay Bridge, with views of ocean, city and San Francisco Bay.

**Site demanded ample glass areas on two sides,** i.e. North (at front for view) and South (at rear, for admitting sunlight). East and West sides are virtually blank walls. Shape of house in form of ell, with projection to rear along West side to form a sunny terrace at rear, sheltered from westerly winds.

Although Living Room is along front (North Side) it also looks across stair hall to South terrace and high stair window and light stair construction. This enables one in Living Room to look upward into terraced garden at rear.

Entrance is from downhill side, necessitating a stair up to the first floor level. This stair is along East side, up to an entrance platform from which one turns right and enters into Stair hall. Garage (2 car) is at street level, below first floor and was excavated into earth bank and retained with concrete walls. Also at this level is extra space intended to be converted, when desired, into servants

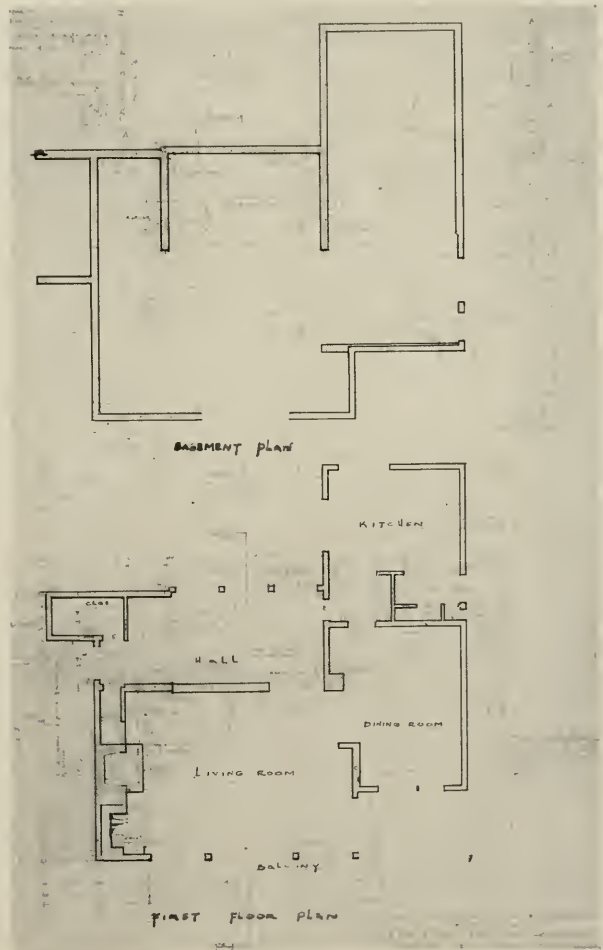

MODERN RESIDENCE . . .

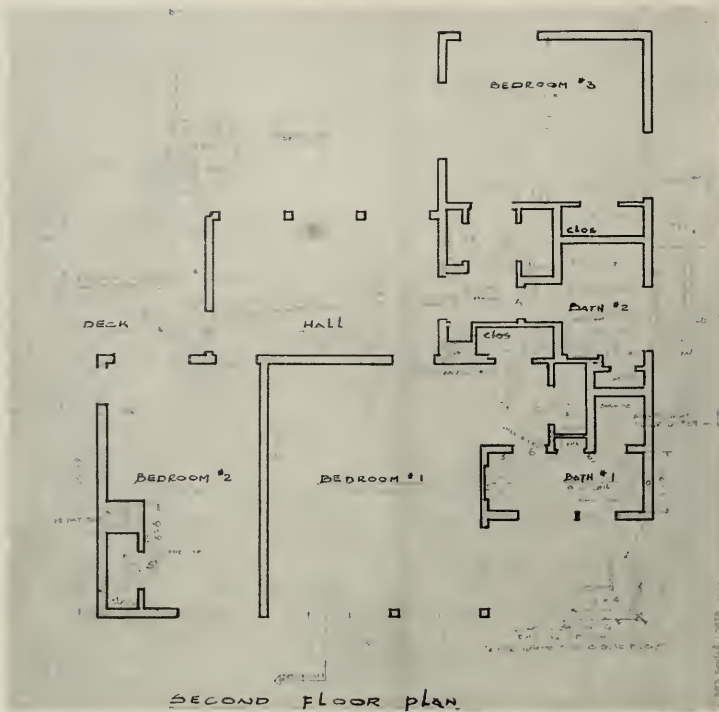

Second Floor Interior  
—Showing stairway  
to upper floor, paved  
exterior living area,  
and landscaped area  
beyond low fence.  
Glass extends from  
ground to second  
floor roof.



## MODERN RESIDENCE . . .

room and Bath. This also contains Laundry and heating equipment and is reached from Garage, or from Kitchen by exterior covered stairway along West side of house.

Main floor (1st floor) contains reception and Stair hall, Living Room, Dining Room and Kitchen. Living Room and Dining Room work together as one space, although representing two distinct spaces.

Living Room view windows have balcony outside to facilitate window washing, as well as to cut off view from Living Room down into the street below, or vice versa, and to direct one's view outward horizontally instead.

Second floor originally contained 3 bedrooms and two baths, but an additional small bedroom and brief bath were later added above entrance, over space which was formerly used as a sun deck. The South and East elevations of the house

were, perhaps, more interesting, architecturally, before this addition was made.

**Exterior Materials:** Stock Redwood V rustic laid vertically and with stock ¼ round battens set in Vs to produce textural quality. This material was given a dark stain in anticipation of the inevitable dark weathering that it would eventually reach in such an exposed location.

Trim is off white, as are all sash and doors.

**Interior:** plastered, smooth coat, and painted. Between hall and Living Room, natural oak. This is Fireplace wall and portions of dividing case beched in heavy oak treads of Stairway. Fireplace facing and hearth, travertine marble.

Floors oak. Kitchen cabinets enamelled with varnished mahogany counter tops. Kitchen and Bath floors of Linoleum.

Heating, forced warm air.

House constructed 1940. Cost—under \$10,000!!

### VIEW OF LANDSCAPED YARD





**SWEEPING CURVES ADD TO THE GRACEFULNESS**

MR. and MRS. NILS B. HULT  
**HILLSIDE HOME**  
ONE OF OREGON'S FINEST  
EUGENE, OREGON

**ARCHITECT: CLARE K. HAMLIN**  
**GENERAL CONTRACTOR: CARL J. RATH**

**By ARTHUR W. PRIAULX**

On the slopes of Old Baldy, in the Bailey Hill district west of Eugene, Architect Clare K. Hamlin has created for Mr. and Mrs. Nils B. Hult one of Oregon's most distinctive homes.

Western hospitality and informality have been achieved in this casual, ranch-type home which rests gracefully in a semi-circular floor plan on a bench which has been carved out of a hill. Built on the lower edge of a forty acre wooded hillside, the lovely home commands a breath-taking view of the upper Willamette valley and the Coast and Cascade mountain ranges from its 200-foot high vantage point above the valley floor.

The problem of Architect Hamlin was to utilize the spacious property so as to avoid a closed-in effect, to give the feeling of height, which a built-up berm in front accentuates, and to provide seclusion for the Hult family of four daughters.

The home site was carved out of the side of the gently rising hillside, and the slope of the upper banks was softened and cut back in two sections to provide a background for the central outdoor living area which contains a 20 by 40 foot modern swimming pool. A low cement retaining wall,

which slopes away gradually from the garage and guest room, provided a grass terrace above the level of the center court. Shrubs and grass cover the man-made slope above.

Principal feature of the unusual home is a solarium which serves as a circulation, play and recreation area and from which most rooms open as cul-de-sacs. The solarium occupies a large portion of the floor space on the inner curve of the home. It is made up of 48 feet of sliding glass, which can be opened to provide 24 feet of open air. During the summer months sliding plastic screens are installed to close openings to insects and dust. The solarium opens onto an inner garden court which contains the swimming pool and lawn lounging area.

A covered cement walkway extends the full length of the solarium and beneath an arcade areaway which follows the retaining wall and encloses the garden court. The low, gable-type roof of the home extends outward to shelter the walkway and the arcade covering is a shed-type roof. A surface of concrete product base, built up with gray-red crushed rock, forms the roof covering.

**PLOT PLAN**

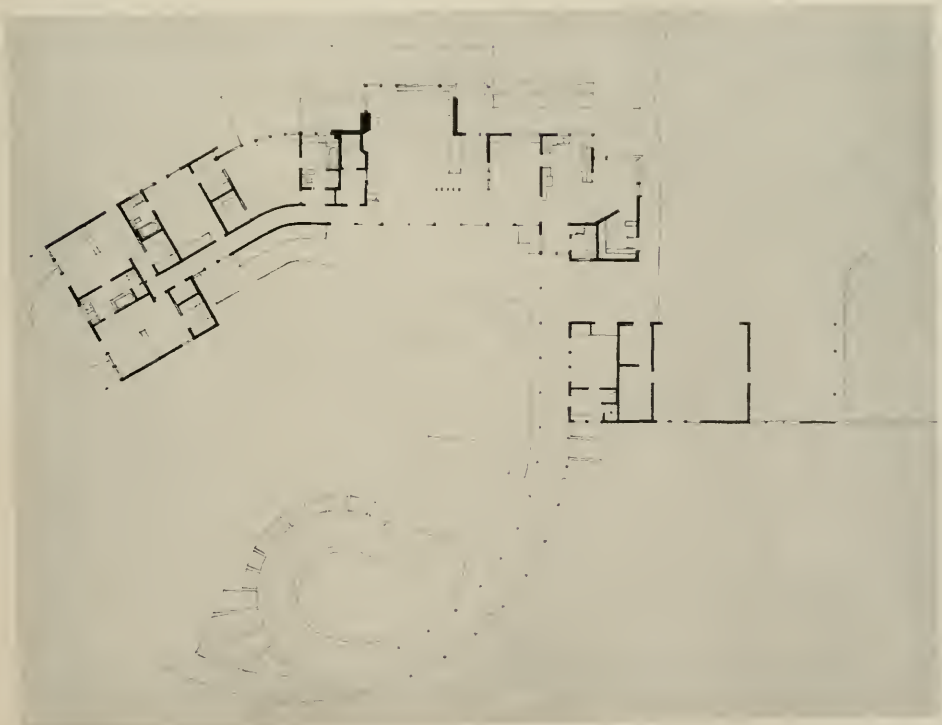



# HILLSIDE HOME . . .



Solarium ends in a panelled hallway which serves the sleeping rooms. Nearly every room has private outdoor entrance. Twin bedrooms occupy widened area at end of main house plan.

BELOW: View of breezeway indicates how architect "closed-in" some of the outdoors for inside living comfort.



An earth color scheme of greyed greens, reds and browns helps blend the home into its surroundings.

The floor plan is open type on a concrete slab and the entire building is heated with radiant heat supplemented by an additional ventilation system. All floors are covered with a composition material, except the living room and bedrooms which have wall-to-wall carpeting. The home is single story.

You get an idea of the easy informality of the home and the feeling of spaciousness when you step into the entrance. You look across the living room through the solarium glass wall directly into the garden court. A low wardrobe case separates the entry from the living room. Two striking features of the living room attract your attention. Dominant in this open living space is a fireplace wall with a 22-foot raised hearth which provides additional seating space. The other distinctive attraction is the view provided of the valley through large plate glass windows set in metal mouldings and stops. Living room ceiling is sloped, following the slant of the roof and a clerestory lighting installation facing south gives plenty of light but elimi-

nates glare. The openness of the living space is broken by a series of fir screens and glass panels and cabinets of birch wood. One entire side of the living area becomes the solarium.

Another cul-de-sac is the dining area adjoining the living room and separated by an open grill-work screen of fir lumber. Here is another room with a sweeping view of the valley, but to give a feeling of privacy, Architect Hamlin has masked the expansive plate glass window with a sliding grill built of fir, eight inches deep. This grill serves as a decorative partial wall and is used to display art objects and china pieces.

One of the most interesting sections is the kitchen and family room, which also opens off the solarium. A fireplace with a raised hearth, hooded with brick and copper, has been built at the angle intersection where two walls meet and lends an informal atmosphere to this part of the home where the entire family spends much of its time. Here has been built all the usual modern kitchen conveniences, ample storage space for dishes, food and utensils. A breakfast dining area is separated from the kitchen proper with a curved counter.

**View of gourd shaped swimming pool and the adjacent grassy area as seen from sweeping, curvacious arcade.**





**It's like living out-doors in this distinctive home. In summer time the sliding glass doors open up to join the central living rooms with the spacious lounging area.**

**This clerestory break in the low roof line is effective. The openness of the house where the solarium faces the inner court is shown from this viewpoint.**





Glass walls on two sides give the Hults a view of the Cascade Mountain range as well as the Willamette Valley from this end of the home. A utility room flows around behind the fireplace as the home angles to meet the garage.

Walls of the living, dining and kitchen areas are finished in vertical Western red cedar panels of random widths to which has been applied a dull lacquer to bring out the natural wood. Exterior walls of the home are rough sawn Western red cedar and are finished with special creosote stain to retain the natural cedar coloring.

The master bedroom adjoins the living area and has its own terrace with outside entrance off from a cement walkway which extends along the entire front of the home overlooking the valley. This bedroom is located at the outer curve of the home and a glass window wall affords another view of vast

distances. A bath and two dressing rooms serve this bedroom. A guest bedroom with bath has a beautiful picture window and also features view and privacy. Both rooms open off from a short hallway extending along the home from the solarium.

Two identical dormitory type bedrooms at the extreme west end of the home provide the four Hult daughters with a little home of their own. Each room has a double walk-in closet equipped with sliding doors, and the storage facilities for clothes have been arranged to raise as the girls grow. Each bedroom is separated by a low case which gives each girl a semi-private area of her own. A large bath with dressing room for four girls connects the two bedrooms. A feature of these rooms is a wall of full plate glass windows which extend from floor to ceiling and follow the slope of

**This corner fireplace adds a touch of New England to the kitchen and family room. Solarium begins here at right of fireplace and utility room is cleverly hidden to the left.**



## HILLSIDE HOME . . .

the gabled roof. The entire end of the home is glass and gives the young ladies a splendid view of woods and nearby farms in the valley.

Still another guest room is a completely separate unit from the home, connected only by a breezeway. It is located in the section of the home which contains the two-car garage and two-space carport as well as a storage room for wood, tools and supplies. This guest room contains a large shower and bath room and dressing room which serves the swimmers to eliminate tracking water into the home from the pool. The garage is equipped with electrically operated doors.

All bedrooms are finished in West Coast vertical, random-width panels and they, too, have been done with a dull lacquer to retain the golden yellow of the wood.

An Arizona flagstone planter and a partially exposed exterior wall of the living room fireplace breaks the low line of the home on its outer circumference just to the right of the entry way. Arizona flagstone was used for the entire fireplace and hearth in the living area, but brick was used in the kitchen fireplace. Approach to the home and turn around for cars has been black topped.

A feature of the covered arcade which is supported by four-by-four fir posts are cutouts in the terrace paving snug up against the retaining wall intended for flowers or shrubs. The robin's egg blue kidney-shaped swimming pool is attractive in its setting of green.

On the upper end of the hill property, the wants of four horse-minded Hult daughters have been satisfied with a four-stall horse barn with tack

**Living area is a cul-de-sac off the solarium. Here is the gracious, unaffected room where guests and family are at ease and where they can almost reach out and touch the friendly outdoors. Clerestory lighting breaks down shadows and eliminates dull spots along room's center.**



room and hay storage. This building follows the style of the home with cedar siding on a fir frame.

Architect Hamlin has created a very satisfactory informal home in a very unusual setting. Here the architect designed a hill to fit the home, and inversely, a home to fit the hill. While the hill has been fashioned out to make an extensive bench to accommodate the sweep of this single-story structure, all the cement slab has been cast upon solid earth. Earth removed became part of the berm which will ultimately be covered with native shrubs as will also the portion of the hill above the home cut away in the operation. A grass terrace extends along the valley side.

Most impressive effect of this home is the manner in which Hamlin has captured the illusion of depth and size by means of solarium walls and large view windows. You have the feeling that a

roof has been put over the outdoors, yet there is an intimacy and coziness about the home of Mr. and Mrs. Hult which develops a friendliness and warmth as you step into any door. Here is a home where a family can live and where friends can be entertained without stress or strain.

The over-all length of the Hult home is 165 feet. The living room is 20 by 30 feet in size. The dining room measures 12 by 12 feet and is easily expandable into solarium area for large groups. Master bedroom, including dressing rooms and bath takes up a 44 by 18 foot space. The guest bedrooms are 12 by 18 and 12 by 16 feet. The girls' bedrooms are identical, 14 by 20 feet. The kitchen area including breakfast nook and family room measures 22 by 20 feet. The solarium runs along 48 feet of the home and varies in width from six feet to ten feet.

**One of children's room, part of two identical twin-bedrooms where the family's four daughters sleep, study and play. Each room enters onto grounds and is a self-contained living unit. Full glass walls face on expansive lawns.**







## LOOKING AT PROGRESSIVE ARCHITECTURE AMONG AUSTRALIA'S HOMES

By **GEORGE FARWELL**



Some 25 years ago an architect from the United States challenged the universal Australian habit of designing houses with high-pitched roofs.

Why, he asked, should a warm and sunny climate follow a style which European countries had evolved largely to deal with snow? Why have steep gables, pseudo-Elizabethan half-timbers or the meaningless embellishments of the stucco and wrought-iron villas known as "Spanish Missions" in the early 1920's. House design in general had respectfully followed the conventions, usually im-

Modern home at Killara, northern suburb of Sydney, designed by T. O'Mahoney. Top view shows site on outcrop of sandstone rock. Any room may be entered from terrace. Below—Living room with two walls of plate glass give pleasant view of tree-lined road outside.

Architect Harry Seidler designed this home on a narrow sloping site between other houses at Northbridge. Large ground floor cement platform surrounds house.

ported from Britain with little regard for the different climatic conditions and social needs of the southern continent.

The American architect was Walter Burley Griffin, disciple of Frank Lloyd Wright, who had been such a profound influence in the United States. Griffin settled in Australia after winning a world-wide competition in 1912 with his plan for the national capital, Canberra.

The flat roofs he set on his unorthodox sandstone houses in 1930 at Castlecrag, a northern Sydney suburb, aroused much controversy, even if they delighted the colony of artists who settled there. His style was rather too romantic and individual to attract much of a following, but it was a pointer



**MODERN RANCH-HOUSE** of New Merigol, near Gilgandra, New South Wales, was designed by Sydney architects Fowell, Mansfield & MacLurcan for the hot summer condition prevailing on the Western Plains. Featured is the broad veranda, wide eaves, shutters on bedroom windows exposed to direct sunlight, cross-ventilation inside and walls and ceiling insulated against heat.





Full-length sliding glass doors for seasons weather enjoyment; clear view of water, beach, and scenery. Polished timber floor curved to follow contour of house. Pastel color interior decorations.

ed its peak elsewhere during the 20's and 30's. As in Europe, such four-square, functional and almost machine-like houses were a reaction against the over-decorative styles once so popular in all the capital cities. Others, more flexible in their design, evinced a pleasant sense of light and color.

There can be no question that, but for the war and later material shortages, housing of this kind would have developed more quickly, since most of the architects had begun practice before that time. The leading men in New South Wales, Sydney Anchor, Arthur Baldwinson, Walter Bunning and T. O'Mahony had toured Europe with the aid of travelling scholarships back in the mid-30's. They found themselves extremely stimulated by the new techniques they saw, and returned to Australia full of enthusiasm.

Since the war it appeared as if these architects were arriving at similar answers to their problems. Their designs show an inherent simplicity, the avoidance of any ornamentation for its own sake, the paring down of design of essentials. The dominant expression is in terms of long, low lines, simple shapes and outlines, plenty of glass and a skilful adaptation to natural features.

The accent is on open-air living.

As Harry Seidler, one of the younger members of the "New Architecture" movement, has expressed it: "There are few countries in the world that are blessed with such mild conditions. Except for some short periods during the winter, heating is unnecessary in New South Wales. Why do we insist on such closed-in buildings? We can have glass

Architects Bunning & Madden designed this house to take advantage of scenic beauty and land-locked waters at Newport, near Sydney. Built on curve following contours of hillside and beach. Sandstone walls; bedrooms lower level, living and dining above. Spiral stairs to top veranda which is furnished with deck chairs and lounges.





walls, from floor to ceiling and wall to wall, without experiencing any discomfort. This will flood our interiors with healthy sunlight and open them up so that they literally include the garden and bring the outdoors inside. Small rooms will immediately look twice their size."

Certainly his houses have a New Look. Seidler, who was born in Vienna, became a Canadian citizen, studied at Cambridge, England, and the University of Manitoba, then won a scholarship to Harvard and did post-graduate work under Professor Walter Gropius, by whom he was deeply influenced.

Typical of his work is one house at Turramurra, an outer Sydney suburb, surrounded by a densely timbered area. An almost square, box-like structure, it has a hollow rectangle at one end and an open well scooped out of the centre. The land slopes downward from the house level, a movement he has dramatised by the use of a long rising ramp leading to the entrance. The living room has a full glass wall, giving a wide view of the bush landscape. Linking this with the bedrooms is an open-roofed terrace, its main wall decorated with an abstract mural painted by Seidler himself.

Some critics have found such designs too calculated and geometric. Local Government authorities who have control over buildings in their area protested for other reasons. On one occasion, for instance, he had to fight a law case before he could gain acceptance for a complete wall of plate glass. In many areas building regulations decree

(See Page 33)



Rear wall, providing windows and doors for sunroom, living room, kitchen, study and two bedrooms. Glass doors fold for use of room and porch as sundeck.

**Prize winning house by Architect Sydney Ancher at Killara, is 80 ft. long with flagged terrace full length of rear. Folding glass doors divide main living room from sun-room. Ornamental garden slopes down towards creek.**



# American Institute



# of Architects

Glenn Stanton, President  
 Kenneth E. Wischmeyer, 1st Vice-president  
 Norman J. Schlossman, 2nd Vice-president  
 Clair W. Ditchy, Secretary  
 Maurice J. Sullivan, Treasurer

National Headquarters—  
 1741 New York Avenue, N. W.  
 Washington, D. C.  
 Edmund R. Purves  
 Executive Secretary

#### Arizona Chapter:

Richard Drover (Phoenix), President; Lew Place (Tucson), Vice-President; Martin J. Young, Jr. (Mesa), Secretary; Fred O. Knipe (Tucson), Treasurer; and Richard Drover, Fred Weaver and Ed Varney (Phoenix), and Martin Ray Young, Jr. (Mesa), and Gordon Luepke (Tucson), Executive Board members.

#### Central Valley of California.

John W. Bomberger, President; Nicholas Tomich, Vice-President; Albert B. Thomas, Secretary; Ted de Wolf, Treas.; Gordon Stafford, Director; Alternate to CCA, Silvio Barovetter; Sec. Office 718 Alhambra Blvd., Sacramento.

#### Coast Valleys Chapter:

Lawrence Gentry, President, Los Gatos; Herb Seipel, Vice President, Carmel; Wm. N. Green, Secretary, Los Gatos; Kurt Grass, Treasurer, San Jose; Directors: Harold C. Ahnfeldt, Palo Alto, and Victor K. Thompson, Palo Alto. Sec. Office: 125 W. Main St., Los Gatos.

#### Colorado Chapter:

James M. Hunter, President, 2049 Broadway, Boulder; Casper F. Hegner, Secretary, 1639 Grant Street, Denver 5.

#### East Bay Chapter:

Chester H. Treichel, President; Malcolm D. Reynolds, Vice-President; John E. Lloyd, Secretary; Roger Lee, Treasurer. Secretary's Office 1171 Solano Ave., Albany, California.

#### Montana Chapter:

E. Edward Scovcroft, President (Billings); J. Van Teylingen, Vice-President (Great Falls); H. C. Cheever, Secretary-Treasurer. Secretary office, Bozeman.

#### Nevada Chapter:

Walter Zick, President, Las Vegas; Russell Mills, Vice President; Reno; Keith Lockard, Secretary, Reno; Directors Edward Parsons, L. A. Ferris, David Vhary, Reno, Office of President P. O. Box 2107, Las Vegas.

#### Nevada State Board of Architects:

Russell Mills, Chairman, Reno; Aloysius MacDonald, Secretary, Las Vegas; Edward Parsons, L. A. Ferris, Reno, and Richard Stadmann, Las Vegas, Members. Office, 309 S. 5th St., Las Vegas.

#### Northern California Chapter:

Albert R. Williams, President; Donn Emmons, Vice-President; William Corlett, Secretary; Bernard J. Sabaroff, Treasurer. Helen H. Ashton, Office Sec., Offices 369 Pine Street, San Francisco.

## SEATTLE WOMEN'S GROUP FORM ORGANIZE FOR A.I.A. MEET

In anticipation of the national convention of The American Institute of Architects which will be held in Seattle next June 16-19, a group of wives of A.I.A. architects in the Seattle area, have formed an organization for the purpose of assisting in convention arrangements.

Mrs. Waldo B. Christenson, has been chosen president and will be assisted by a committee including Mrs. John S. Deitie, first vice-president; Mrs. Charles T. Pearson, second vice-president; Mrs. John T. Jacobsen, secretary; and Mrs. Leonard W. Bindon, treasurer.

## BASEBOARD HEATING PROGRAM PRESENTED PRODUCERS COUNCIL

Baseboard heating, and advanced system for providing indoor warmth, is the subject of a one-hour program, supplemented by visual aids, which is being prepared for Producers' Council presentation to architects and builders. The project is part of a program in cooperation with The American Institute of Architects to exchange information and improve building and building products.

## SEATTLE ARCHITECTS NAMED TO NATIONAL AIA COMMITTEE

William J. Bain, member of the Washington State Chapter of the A.I.A., has been named a member of the Jury of Fellows of The American Institute of Architects, according to a recent announcement.

Named with Bain to serve on AIA committees were: Stephen H. Richardson, Committee on Accounting Methods and Office Practice; Paul H. Kirk, Committee on Chapter Affairs; Waldo B. Christenson, Committee on Convention Planning and Nominating Committee, 1953; Marvin R. Patterson, Committee on Membership; Paul Thiry, Committee on Education; John T. Jacobsen, Chairman Committee on Convention Exhibits; and Francis E. Huggard, Committee on Preservation of Historic Buildings.

The national convention of The American Insti-

Remember it's

# KRAFTILE

for ★ GLAZED STRUCTURAL WALL UNITS

★ PATIO TILE

★ FACE AND ROMAN BRICK

★ ACID FLOOR BRICK

★ HEARTH BRICK

★ BRICKETTES

★ MINWAX TILE & CONCRETE FLOOR FINISH

for complete information and prompt service, phone or write

## KRAFTILE COMPANY

NILES, CALIFORNIA

NILES 3611

LOS ANGELES 13: 406 South Main Street—Mutual 7241



#### Orange County Chapter:

William Blumck, Corona del Mar, President; George Lund, Balboa, Secretary; Paul O. Davis, Corona del Mar, Treasurer. Office of Secretary, 2919 Newport Blvd., Newport Beach.

#### Oregon Chapter:

H. Abbott Lawrence, President; Holman J. Barnes, Vice-President; Donald W. Edmundson, Secretary; and Robert W. Fritsch, Treasurer. Office of Secretary, 325 Henry Bldg., Portland.

#### Pasadena Chapter:

Robert E. Langdon, Jr., President; Wallace C. Bonsall, Vice-President; Robert L. Deines, Secretary; Henry C. Burre, Treasurer; and Directors John N. Douglas, R. VanBuren Livingston, Scott Quintan and Burton Ramberger. Offices: 259 South Los Robles Ave., Pasadena 5.

#### San Diego Chapter:

Louis A. Dean, President; Donald Campbell, Vice-President; Victor L. Wulff, Jr., Secretary; Richard L. Pinnell, Treasurer. Sec. Office, S. D. Trust & Savings Bldg., San Diego.

#### San Joaquin Chapter:

David H. Horn, President; William G. Hyberg, Vice-President; Richard P. Clark, Secretary; Bryan C. Brodrick, Treasurer. Sec. Office, 335 Anglo Bank Bldg., Fresno.

#### Santa Barbara Chapter:

Wallace W. Arendt, President; Roy W. Cheesman, Vice-President; Chester Carjola, Secretary; Lulah M. Riaga, Treasurer. Sec. Offices, 129 De la Guerra Studios, Santa Barbara.

#### Southern California Chapter:

Henry L. Wright, President; U. Floyd Rible, Vice-President; Cornelius M. Deasy, Secretary; Savo M. Stoshitch; Hugh R. Davies, S. Kenneth Johnson, Kemper Nomland and Chas. E. Fry, Directors. Headquarters, 3723 Wilshire Blvd., Los Angeles 5.

#### Utah Chapter:

W. J. Monroe, Jr., President, 433 Atlas Bldg., Salt Lake City; M. E. Harris, Jr., Secretary, 703 Newhouse Bldg., Salt Lake City.

#### Washington State Chapter:

Paul Thiry, President; John S. Dettle, 1st Vice-President; Robert H. Wohleb, 2nd Vice-President; Robert H. Dietz, Secretary; and Edwin T. Turner, Treasurer. Alice Gregor Executive Secretary, 430 Central Building, Seattle 4.

#### Spokane Chapter:

B. K. Ruehl, President; Victor L. Wulff, 1st Vice-President; Philip Keene, 2nd Vice-President; Laurence G. Ewanoff, Secretary, and Carroll Martell, Treasurer. Office 315 American Legion Bldg., Spokane, Washington.

#### Tacoma Society:

E. N. Dugan, President; P. G. Ball, Vice-President; Lyle Swedberg, Secretary-Treasurer.

#### Hawaii Chapter:

Kenji Onodera, President, 3518 McCorrison St., Honolulu, T. H.; George J. Wimberly, Secretary, 315 Royal Hawaiian Ave., Honolulu, T. H.

#### CALIFORNIA COUNCIL OF ARCHITECTS

William Koblik, President, 2203 - 13th St., Sacramento; Donald Beach Kirby, Secretary, 461 Market St., San Francisco; Frederick A. Chase, Exec. Secty., 3723-A Wilshire Blvd., Room 206, Los Angeles.

#### ALLIED ARCHITECTURAL ORGANIZATIONS

##### San Francisco Architectural Club:

Joseph Scoma, President; Frank S. Gerner, Vice-President; Russell W. Pennell, Treasurer; Frank L. Barsotti, Secretary. Club Quarters: 507 Howard St., San Francisco.

##### Producers' Council—Southern California Chapter:

Bert Taylor, President, Pittsburgh Plate Glass Company; G. Robert Roden, Jr., Vice-President, Truscon Steel Company; Malcolm G. Lows, Secretary, Natural Gas Equipment Inc.; Richard Seaman, Treasurer, W. P. Fuller & Company; Vern Boget, National Director, Gladding McBean & Co.

Producers' Council—Northern California Chapter (See Special Page)

tue of Architects is scheduled to be held in Seattle, on June 16-19.

### SOUTHERN CALIFORNIA CHAPTER

Norman J. Schlossman of Chicago, second vice president of The American Institute of Architects, was a guest of honor at the Annual Meeting on January 13, taking part in the installation of the new Chapter officers which included:

Henry L. Wright, President; Ulysses Floyd Rible, Vice-president; Cornelius M. Deasy, secretary; Savo M. Stoshitch, treasurer; and Herman C. Light, three year director.

President Wright has served as a director of the Chapter for two years and is currently chairman of the schoolhouse planning committee of the California Council of Architects.

The January meeting heard Carlton B. Tibbetts, President of the Los Angeles Steel Casting Company and former president of the Los Angeles Chamber of Commerce, discuss the subject of "A NEW LOOK AT CITY GOVERNMENT." Annual reports were made and plans for the future announced by newly elected officers.

### SAN DIEGO CHAPTER

Glenn Stanton, Portland, Oregon, architect and president of the AIA, spoke at the January meeting, outlining a number of institutional activities which were of great importance to the architectural profession.

Annual reports were submitted and Donal Hord was presented with the Certificate of Honorary Associateship. Election of officers for the ensuing year will be announced next month.

### EAST BAY CHAPTER

Charles O. Matcham, Regional Director of the AIA was the principal guest of honor at the January meeting and participated in election of officers to serve for the ensuing year. Newly elected officers will be announced next month.

### WINNING NATION WIDE POPULARITY!



## NEW 9' STRAND GARAGE DOOR

### TO ACCOMMODATE TODAY'S WIDER CARS

- ★ New garage beauty
- ★ Quick installation
- ★ X-type steel bracing assures strength, durability
- ★ Galvannealed for rust protection

**EASIER OPERATING — can't warp, shrink, rot, stick**

DISTRIBUTED BY



**SAN FRANCISCO**  
400 Alabama Street  
Klonek 2-1616

**OAKLAND**  
2400 Peralta Street  
Glancourt 1-0177

**SAN JOSE**  
790 Stockton Avenue  
Cypress 2-5620

**SACRAMENTO**  
16th and A. Streets  
Gilbert 3-6586

**STOCKTON**  
870 So. California St.  
Ph. 8-8643

**FRESNO**  
2150 G Street  
280 Thorne Avenue  
Ph. 3-5166

# WITH THE ENGINEERS

Structural Engineers Association of California  
John E. Rinne, President, San Francisco; Jack S. Bar-  
rish, Vice-President, Sacramento; Leslie W. Graham,  
Secretary-Treasurer, San Francisco. Directors John J.  
Gould, R. W. Binder, M. A. Ewing, Leslie W. Graham,  
Jack S. Barrish, Harold P. King, W. T. Wheeler, John E.  
Rinne and Donald F. Shugart. Secretary's office, c/o  
Associated Structural Engineers, 417 Market St., San  
Francisco 5.

Structural Engineers Association of  
Northern California  
George A. Sedgwick, President; Michael V. Pregnoff,  
Vice-President; John M. Sardis, Secretary; William K.  
Cloud, Treasurer; Robert P. Molfett, Asst. Sec. Treas.;  
Directors, Robert D. Dalton, Robert D. Dewell, William

H. Ellison, John J. Gould and J. Albert Paquette. Offices:  
417 Market St., San Francisco.

Structural Engineers Association of  
Central California

William H. Peterson, President; Walter S. Wassum,  
Vice-President; O. T. Illerich, Sec. Treas.; Ernest D.  
Francis, M. A. Ewing, and Arthur A. Sauer, directors.  
Office O. T. Illerich, c/o Div. of Arch., Sacramento.

American Society of C. E.  
San Francisco Section

Clement T. Wiskocil, President; John S. Longwell, Vice-  
president; J. G. Wright, Vice-president; H. C. Medbery,  
Treasurer; R. D. Dewell, Secretary. Secretary's Office,  
604 Mission St., San Francisco.

## NUCLEAR ENGINEERS WILL SPEAK AT CORROSION MEET

Four prominent additions to the list of speakers for the Corrosion Short Course to be conducted on the Berkeley campus of the University of California have been announced.

Dr. C. R. Breden of the Reactor Engineering Division, Argonne National Laboratories, will speak on corrosion of stainless steel.

Dr. J. E. Draley, corrosion researcher with the Metallurgy Division of the Argonne Laboratories, will discuss corrosion of aluminum.

Dr. Leo F. Epstein of the General Electric Atomic

Power Laboratory at Schnecktady, will talk on corrosion by Liquid metals; and

Dr. Earl T. Hayes, chief of the Physical Metallurgy Branch for Region II of the Bureau of Mines will speak.

## ENGINEER TELLS OF EUROPEAN TRIP

Ralph E. Phillips, Los Angeles professional engineer, spoke at the December meeting of the Southern California Chapter of the American Society of Heating and Ventilating Engineers, on his "observations" during a recent trip to Europe.

He discussed engineering advances in Europe and related his personal experiences with European engineers, industrialists, and business executives.

## GEORGE SEDGWICK ELECTED PRESIDENT OF ENGINEERS

George Arthur Sedgwick was elected president of the Structural Engineers Association of Northern California, at the annual meeting held in December.



George A. Sedgwick  
President SEANC

Sedgwick was born in San Francisco, attended the Oakland Public Schools and the University of California, where he received his degree of B.S. in 1927, and is a licensed structural engineer. From 1928 to 1940 he was with the State of California, serving in various engineering positions with the Division of Architecture, the Bridge Department and Board of State Harbor Commissioners in San Francisco.

From 1940 to 1946, he was engaged in engineer-



Always  
Specify  
**HAWS**  
for Highest Quality

A complete line of fountains, electric water coolers, faucets, filters and accessories. • Individual or multiple installations. • A reputation for reliability since 1909. • Check in Sweet's or write for complete HAWS catalog.

**HAWS DRINKING FAUCET CO.**

1441 FOURTH STREET (Since 1909) BERKELEY 10, CALIFORNIA  
Agents and Sales Representatives in All Principal Cities

**Structural Engineers Association of Northern California**

Harold P. King, President; Ben Benioff, Vice-president; Chas. Corbit, Jr., Sec.-Treas.; Don Willse, Ex. Sec. Directors Harold P. King, Ben Benioff, Donald F. Shugart, Wm. T. Wright, Wm. T. Wheeler, Henry M. Layne and Joseph Shefflet. Office, 119-A S. Alvarado St., Los Angeles 4.

**Structural Engineers Association of Oregon**

R. Evan Kennedy, President; Guy H. Taylor, Vice-President; James R. Griffith, Secretary-Treasurer; Directors Jerome A. McDevitt, H. Loren Thompson, and Robert L. Tidball. Offices, Portland.

**Puget Sound Engineering Council (Washington)**

R. E. Kister, A. I. E. E., Chairman; E. R. McMillan, A. S. C. E., Vice Chairman; L. B. Cooper, A. S. M. E.,

Secretary; A. E. Nickerson, I. E. S., Treasurer. Offices. L. B. Cooper, c/o University of Washington, Seattle 5, Washington.

**American Society Testing Materials**

**Northern California District**

L. A. O'Leary, Chairman; P. V. Garin, Vice-chairman; H. P. Hoopes, Sec. Office Sec., 1550 Powell St., Emeryville, Calif.

**Society of American Military**

**Engineers—San Francisco Post**

Brig. Gen. Dwight W. Johns, USA, Ret., President; Cmdr. N. M. Martinsen, CEC, USN, 1st Vice President; Lt. L. L. Wise, CEC, USNR, 2nd Vice President; Robert P. Cook, Secretary; O. Spier, Treasurer; and Rear Admiral C. A. Trexel, CEC, USN (Ret.); Capt. Cushing Phillips, CEC, USN; Capt. H. F. Ransford, CEC, USN; Clyde Bentley; Lt. Col. James D. Strong, CE, USA; and J. G. Wright directors.

ing work on the Panama Canal, the Canol Project in Canada, and with several structural engineering firms. From 1946 to date, he has been in charge of structural engineering design with W. P. Day & Associates, Architects and Engineers of San Francisco, who designed the new San Francisco Air Port Building which involved some unique structural and foundation problems.

The other officers elected to serve during 1953 were: Michael V. Pregnoff, vice-president, John M. Sardis, secretary, William K. Cloud, treasurer, Robert P. Moffett, assistant secretary and assistant treasurer, with the following directors: Robert D. Dalton, Robert D. Dewell, William H. Ellison, John J. Gould and J. Albert Paquette.

**STRUCTURAL ENGINEERS ASSOCIATION NORTHERN CALIFORNIA**

C. Henning Vagtborg of the Vagtborg Lift Slab Corporation of Los Angeles, spoke before the January meeting on the subject "Lift Slab Method of Design and Construction."

Vagtborg described many phases of "lift slab" construction, illustrating his remarks with pictures of various construction where the method was used.

**INDUSTRIAL ENGINEERING TALKS OPEN TO LOS ANGELES PUBLIC**

The Lecture-Forum Series on Industrial Engineering and Management, comprising eleven lectures to be held alternate Wednesdays starting January 7 in the University Business Administration and Economics Building, Los Angeles, will be open to the public.

The series is sponsored by the U.C.L.A. School of Business Administration and College of Engineering.

**THOMAS BARON RECEIVES 1952 CHEMICAL ENGINEERING AWARD**

Thomas Baron, Shell Development Company, Emeryville, California, was chosen by the American Institute of Chemical Engineers to receive the 1952 Junior Award in Chemical Engineering, in

company with L. G. Alexander of Oak Ridge National Laboratory.

Selection of Baron and Alexander was made on the basis of their collaborative study entitled, "Momentum, Mass and Heat Transfer in Free Jets."

Award was made at a recent meeting of the American Institute of Chemical Engineers in Cleveland, Ohio.

**REGIONAL ENGINEERING SYMPOSIUM AT SAINT MARY'S COLLEGE**

The Federal Civil Defense Administration, Region VIII, will hold an Engineering Symposium at Saint Mary's College, on February 5-6-7. Region

(See Page 31)

**Always specify**  
**HAWS**  
**for Highest Quality**



**HAWS Electric Water Coolers easily adapt to remote installations of HAWS Drinking Fountains... thus serving several locations.**

• A COMPLETE LINE of coolers, fountains, faucets, equipment, filters and accessories. • A reputation for reliability since 1909. • Check in Sweets, or write for complete HAWS catalog.

**HAWS DRINKING FAUCET CO.**  
1441 FOURTH STREET (Since 1909) BERKELEY 10, CALIFORNIA  
Agents and Sales Representatives in All Principal Cities



# PRODUCER'S COUNCIL PAGE

The National Organization of Manufacturers of Quality Building Materials and Equipment  
(Northern California Chapter) affiliated with THE AMERICAN INSTITUTE OF ARCHITECTS

President, A. L. West, Jr.  
Aluminum Company of America  
621 Russ Bldg.

Vice-President, Howard W. Noleen  
E. F. Hauserman Company  
31 Geary Street

Secretary, Hillman Hudson  
Vermont Marble Company  
525 Market Street

Treasurer, Tait Smith  
Ceco Steel Products Corp.  
401 Tunnel Avenue

Edited by Phil Brown, OTIS ELEVATOR COMPANY.

## CHRISTMAS JINX - 1952

The Peacock Court and the Room of the Dons at the Mark Hopkins Hotel in San Francisco was the scene of the Annual Christmas Jinx on December 4 by the San Francisco Chapter of the Producers' Council.

Cocktails were served to the 530 members and guests from 6:00 until 7:30 p.m. followed by a very fine dinner.

The entire evening was one in which every member of the Producers' Council can be proud.

Credit for the success of this affair goes to all the participants, but particularly to President Al West, and to Roly MacNichol, who was chairman of the Jinx.

Particular appreciation should go to the men whose names appear year after year in the Producers' Council events and who, in effect, form the core of the Producers' Council and make it possible for the other members who do not take such an active part to reap the harvest of their efforts.

We think credit should go to the Mark Hopkins Hotel for the fine way in which the dining room was arranged and the manner in which the dinner was served.

The Council was honored at the Jinx by the presence of two of the original founding members of the Producers' Council, Mr. Fred Meyer, architect,

and Mr. Ray Kingsland, of the Otis Elevator Company. These gentlemen remarked of the tremendous strides taken by the Producers' Council since its founding in San Francisco twenty-three years ago. It was their opinion that this Christmas Jinx of 1952 was the finest event and social gathering that the local Chapter has ever conducted.

In reminiscing, they remarked about their first Christmas Jinx put on by the Producers' Council in the Engineers' Club in December of 1930. The total attendance of members and guests was about 50 and a ticket sold for \$1.50. The Jinx consisted of an evening dinner and a skit written by Mr. Abe Appleton, A.I.A. and Mr. Harris Allen, A.I.A. and enacted by the Council members.

Fine music is always enjoyed and the Producers' Council Quartet gave its usual sterling performance. This Quartet has become as much a part of the Annual Christmas Jinx as the play itself and its inclusion should never be overlooked.

We were extremely fortunate in having Mr. F. Bourn Hayne, architect, take the part of narrator, as there is no better person in either the architects' or Producers' ranks who could better fill the part.

This affair further points out the fine relationship existing between the Profession and Industry and we feel that every member should take it upon himself to assist in and continue these fine events.

USE QUALITY PRODUCTS



CONSULT AN ARCHITECT

## WITH THE ENGINEERS

(From Page 29)

VIII comprises the states of Arizona, Nevada, Utah and California.

Conference discussions will include such subjects as "The Architect and Engineer in Civil Defense", "Restoration of Facilities", "Streets and Highways", "Utilities", "Urban Analysis", "Engineering Equipment Stockpile".

"Emergency Plans", "Shelter Survey", "Building Code Planning", "Design of Structures in the Atomic Age", "Windowless Structures", "Lateral Stability and Blast Analysis", "Rescue and Engineering Equipment Tests", and "Review and Evaluation".

## AMERICAN SOCIETY OF SPECTROGRAPHERS MEET

The American Association of Spectrographers will hold a symposium on "Emission Spectroscopic Determination of Metals in Non-Metallic Samples," in Chicago, Ill., on May 1, 1953.

Scheduled for discussion on the program are papers dealing with the field of petroleum, geology, agriculture, pharmacy, biology, and ceramics. Complete information relative to the conference may be secured from J. P. Pagliassotti, Chm. Symposium Committee, c/o Standard Oil Company, Box 431, Whiting, Ind.

## NEWS & COMMENT ON ART

(From Page 6)

by Miriam Hoffman.

The exhibition of work by Angna Enters has recently been shown in London, New York, and Southern California.

## SAN FRANCISCO MUSEUM OF ART

The San Francisco Museum of Art, War Memorial Building, Civic Center, will open the new year with a January schedule of events including:

**EXHIBITIONS:** New Works by Oskar Fischinger; Paintings by Ward Lockwood, Henry Rasmusen, and Yehoshua Kovarsky; the Charles Stafford Duncan Memorial Exhibition; Childrens' Finger Paintings; and a special display from the Albert M. Bender Collection.

An exhibition at the Parkmerced branch will be a group of Latin American Paintings and works from the Rental Gallery.

**SPECIAL EVENTS:** Include Lecture tours on Sunday afternoon's at 3 p.m.; the Lecture Series each Monday evening at 8 o'clock; and Art discussions each Wednesday at 8 p.m. Special classes in Art will resume during January and include Art for

the Layman (Tuesday mornings), Sketch Club and Painting Classes (Friday evenings), and the Children's Classes (Saturday mornings).

## SAN FRANCISCO MUSEUM TELEVISION SERIES

The San Francisco Museum of Art has announced a group of programs relating to the subject of "art" which will be incorporated in a special television series entitled "The Home Inside and Out."

On Sunday January 25, the program will be devoted to "What Makes a Good House?" and will feature the relationship between client and architect; February 8, the program will be devoted to "What Makes a Good Garden"; February 22, the subject will be "What Makes a Good Room," and on Sunday, March 8 the program will feature "Remodeling or Enlarging a House."

The programs are televised over Station KRON-TV, Channel 4, San Francisco at 11 o'clock in the morning.

## CLAY BRICK AND TILE PRODUCERS SEE EVEN BETTER YEAR IN 1953

Modernized production and handling methods, as well as the research program conducted by the Structural Clay Products Institute, are being re-

## STOP WATER DAMAGE!



FORM BOARDS



BRICK • CONCRETE



PAINTED SURFACES

Specify

*Thompson's*  
**WATER SEAL**

for

**Waterproof Protection**  
of all porous materials

- It penetrates
- Is transparent
- Leaves no film
- Locks out moisture
- Lasts for years
- Proved by performance.

Will cover 200-400 sq. ft. to gal. depending on porosity of material. Specified by architects and used by contractors all over the West. Has State of California approval.

Write or phone for proof of performance and specification material.



Manufacturer

**BY-CHEMICAL PRODUCTS CO.**

1355 MARKET ST., SAN FRANCISCO • KING CITY • LOS ANGELES

flected in greater use of clay brick, according to Robert Harrington, manager of the Clay Brick & Tile Association of Northern California.

"Based on the consistent growth of the industry during the past year and the general bright outlook for construction, the Clay Brick & Tile producers are looking forward to an even better year in 1953", Harrington stated.

Construction participation in defense, industrial and institutional fields seems likely to continue at better than average rate, he said. Increased productivity and the recently developed 6-inch "Through-Wall" clay brick are expected to reduce overall construction costs sufficiently to enable clay brick to compete with frame construction for home building. It was estimated that over 5,000 homes will be built with "SCR brick" in 1953.

W. S. Stanley, of Remillard-Dandini Company, Oakland, is President, and Harrington manages the office which is the trade association of the brick and structural tile in Northern California and affiliated nationally with the Structural Clay Products Institute. The staff works actively to collect information on masonry construction from both the field and drafting board, locally and nationally through Structural Clay Products Institute.

The manufacturers' part in the training and en-

couragement of bricklying apprentices is handled through this office. Special attention is given to field techniques used in reinforced grouted brick masonry construction. All brick masonry (other than veneer) used in California schools, for instance, is reinforced. "One of the highest types of California construction can be seen in the school system," Harrington continued, "where maximum safety for human life is combined with most economical design." "This is accomplished by having optimum architecture, engineering construction and inspection." Harrington said that the Association is always equipped to assist anyone with information on current techniques of school design and construction in brick. The reinforcing of brick masonry is indicated on an increasing number of major industrial structures-as well, where high earthquake and blast resistance is combined with brick characteristics.

This information, such as design details, test data, wall cost data, specifications, text books and literature, is provided without obligation to all parts of the building industry. The staff also maintains both technical and promotional photographic files, presents programs before technical groups and service clubs, and represents the brick and tile industry in all building code work.

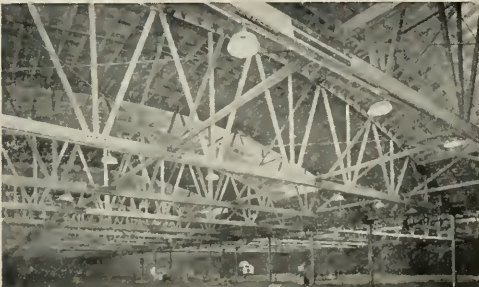

Sherman Paper Co  
Warehouse  
Los Angeles using  
32 SUMMERBELL  
Bowstring Trusses,  
115' 0" span  
Architect,  
Vincent Palmer  
General Contractor  
C. O. Goris  
Entered under patent

## Summerbell for WAREHOUSES



SUMMERBELL Bowstring Trusses are the choice of Architects and Engineers where economy is important and wide spans with unobstructed floor area are desired. This makes them ideal for warehouses and manufacturing plants. "Sawtooth" construction for overhead light and ventilation is easily added.

Glued Laminated Construction • Summerbell Bowstring Trusses  
Lamella Roofs & All Types of Timber Structures



For quality, economy and satisfaction, specify SUMMERBELL

### Summerbell ROOF STRUCTURES

825 EAST 29TH STREET • BOX 218, STATION "K" • LOS ANGELES 11

## ARCHITECT NAMED TO CELOTEX DIRECTORS

N. A. Owings, of Skidmore, Owings & Merrill, architect and engineering firm with offices in San Francisco, New York, Portland and Chicago, has been elected a member of the board of directors of Celotex Corpn.

## HOSPITAL CONSTRUCTION PROGRAM FOR ALASKA EXTENDS BID PERIOD

The multi-million dollar hospital construction proposal by the Alaska District Engineer has been extended for bid opening to January 30, at Seattle.

Program includes a seven-story, 400-bed, hospital with penthouse to be located at Elmendorf Air Force Base. Will cover 55,000 sq. ft., and of reinforced concrete and concrete masonry wall construction.

## UNIVERSITY OF CALIFORNIA CORROSION SHORT COURSE

A five-day short course in corrosion will be held at the University of California, Berkeley, on February 2-6. Speakers from industrial and governmental laboratories and academic institutions will cover basic corrosion science theory and application of corrosion mitigation measures.



## AUSTRALIAN HOMES

(From Page 25)

that structures must conform to certain minimum standards and be of stone or brick exclusively. Architects concede that such regulations are valid when aimed at jerry-builders, but protest at the way council inspectors have sometimes interfered in questions of esthetics. Of course, resistance to change is an universal factor, but prejudice on the part of both public and officialdom is giving way to the acceptance of new ideas in Australia.

Curiously enough, popular recognition of what has come to be termed the "New Architecture" was achieved not through private homes but hospitals. Architects like Stephenson and Turner, of Sydney, sent their men overseas before the war to study, then began building ultra-modern hospitals, and later factories.

One of the leading firms of architects to apply new and organic forms to public buildings was Fowell, Mansfield and Maclurcan, specialising in factories, office buildings and churches of extreme modern design. Among the best examples of private homes built by this firm are several sheep station homesteads. In the past such homesteads—out on the Western Plains of New South Wales, for instance—had no means of keeping their interiors cool. Summer temperatures out there frequently rise to 110°F. or more. The traditional homestead relied mainly on shady verandahs with sloping roofs to shut out the sun. Fowell, Mansfield and Maclurcan improved on this by the use of cross-ventilation, broadened the verandahs, introduced movable glass screens and doors, and insulated walls and ceilings by means of glass-wool fibre.

T. O'Mahony is another progressive architect with reservations about the modern trend towards glass houses, feeling that its use can be too mechanically applied. "Certainly it should be used when there is a reason for it," he said. "A special view, for example. But it is important to take into account the angle of the sun. You need to keep the direct rays out of rooms in summertime, admitting them only in winter when the sun is in a different part of the sky. This can be achieved by the use of overhanging roofs. It seems to me that in this design a type of Australian architecture is beginning to emerge. There is at least a tendency towards a character, if not yet a national style."

A house designed by O'Mahony makes skilful use of the terrain. He built it on a steep slope, high above street level, overlooking a narrow neck of Sydney Harbour at Cammeray, close to where many small yachts are moored. It was the site of an old quarry filled with earth and rubble, despite being in a closely settled area. To give it access he had to build a flight of stone steps, followed by a second steep flight made of timber with a slender, white-painted balustrade. Designed during the war, when building regulations allowed no more than 12½ squares, the house gives the impression of being much larger, because of the long, shallow living room which extends along almost the whole frontage. The house again has a floor to ceiling glass wall at the front with cream-full-length curtains, french windows and a long balcony. The interior has been treated in a very simple manner, with ceilings and walls in pastel shades. The high, piers foundation, cantilever construction, white woodwork and slender balustrade give this house a sense of extreme lightness and grace.

O'Mahony is a versatile architect, for he has designed hospitals, churches, ecclesiastical colleges, schools and factories. Like his confrere, Arthur Baldwinson who now also works in Sydney, he gained his training at the Gordon Institute of Technology in Geelong, Victoria, then won a Robert & Ada Haddon Travelling Scholarship, awarded by the Royal Victorian Institute of Architects in 1937. He visited Great Britain, Scandinavia, Italy and the United States, where he had charge of the Australian pavilion at the New York World's Fair Baldwinson, who was subjected to much the same influences, spent five years abroad and worked with Gropius before the creator of the famous Bauhaus left Britain for the United States.

The effect of travelling scholarships such as these cannot be over-estimated, for they brought Australian architects into touch with overseas trends more directly than had ever been done before.

There is the case of Sydney Ancher, who was awarded a scholarship by the New South Wales Board of Architects in 1930, spent five years in London and on the Continent, then returned home to become one of the most imaginative architects in Australia. One of his best designs, a streamlined and roomy bungalow in Killara, Sydney, won the Sulman Prize for 1945. (The Sulman Prize is a prestige award granted annually by the Trustees of the New South Wales Art Gallery for the best mural or piece of architecture).

This house, as well as another he designed on the opposite side of the road, cleverly exploited some unusual landscape features. The first was

**GOOD LIGHTING...as important as your most important tool!**



## CHECK YOUR OFFICE LIGHTING

Take a good look at your General Office. Here are workers trained at great expense to use precision "tools"—typewriter, calculators, business machines of many types.

Their ability to get the most from these "tools"—to make full use of this training and experience—is dependent upon good illumination.

Smoot-Holman efficient lighting helps eliminate costly mistakes, lost time and eye fatigue.

There is a Smoot-Holman fixture to meet every need and there is no finer lighting equipment made in the West. For the solution to your lighting problem, see your Smoot-Holman Lighting Engineer!



Shown at work on the Master Floodlight is this huge 125-ton hydraulic drawing press. A mighty important "tool" for us. It helps bring you a precision lighting product at lower cost.



**SMOOTHOLMAN COMPANY** Inglewood, Calif. Offices in Principal Western Cities • Branch and Warehouse in San Francisco

built on two blocks of land, with a 100 foot frontage and a pronounced slope down through trees towards a creek. Again, because of wartime restrictions, he was limited to 12½ squares (a square is only 100 square feet), though this has since been extended by the completion of a gaily furnished sunroom. In effect, the house is only one room wide, with the big living room, kitchen, laundry, study and two of the three bedrooms looking across a flagged terrace and ornamental garden to the creek. From the sunlit terrace the house presents an almost unbroken line of glass from floor to ceiling, some 80 feet long and gracefully surmounted by a pitched roof of grey slate. Wide eaves protect the rooms from direct sun in summer-time, but allow them to be lit up in winter.

The second house is literally built on top of a huge and curving outcrop of sandstone rock. Not only does this provide an excellent foundation, but gives the house a striking individuality. The bold lines of its concrete walls, white painted balustrade, wide sun verandah and curtained glass walls make a strong contrast with the rough brown surface of the rock.

It is so designed that from the terrace you can go directly in and out of any room. The interior is conventionally planned, except that the kitchen overlooks the tree-lined main road, so that the housewife does not feel shut away from the life around her.

Despite these bold outlines and somewhat bare walls, Ancher points out that his houses are really quite conventional. All he has done is to simplify their design, refine them and prune away non-essentials. In a word, he has streamlined them.

In some cases there has been a tendency for an architect with advanced ideas to over-emphasise the value of new forms, attempting to apply them too mechanically, without regard for interior comfort. Perhaps the best explanation of the modern architect's problems came from Arthur Baldwinson.

"We now take functionalism for granted," he said. "The austerity of early 'now' architecture has been whittled down and humanised. Such designs are still functional, but they spread warmth as well. My own method of work, for instance, is first of all to discuss what my client has in mind and the background of his way of living. I do this before getting down to plans at all. I want to know if the living room is to be used for social parties; if the housewife is wrapped up in the kitchen and

wants her life to revolve around that, or whether she wants to spend as little time there as possible. I take notes of all these things, and list my facts before getting down to drawing.

"It is not quite true to say I work from the inside outwards. That is an over-simplification. To my mind the idea is to create both from the outside and the inside. It is a complex business to turn out really satisfying work. The best architects' work may look very simple. It will be based on a simple, geometrical idea. But like Picasso's paintings, shall we say, it needs a great deal of initial thought. The too severe, mechanical approach is not at all satisfying. Today we have mastered the use of the new materials at our disposal. Functionalism is now taken for granted, and the architect is turning towards questions of aesthetics, indirectly expressing his own personality."

Without question the best of Baldwinson's work has this individuality. One house he has built on a high plateau overlooking the Pacific Ocean at Narrabeen, some 15 miles from Sydney, reveals the influence of Alvar Aalto, the Finnish architect. It is also perfectly adapted to its setting. Trees surround it on all sides, screening nearby houses. It gains the utmost advantage from the sun, which shines on the wide concrete verandah.

The house is set on concrete pillars, some ten feet above the ground, with space beneath it for car, kiddies playground, laundry and storage. The laundry, in fact, is contained in the house's brick foundation core, which is carried up through the building to provide the living room fireplace and chimney. The upper storey is designed in two distinct units. One consists of three bedrooms, bathroom and shower room; the other of a large L-shaped living room running the full length of the house, except for the kitchen which occupies one rear corner. Much of the furniture is built in. The front wall, overlooking the sea, is almost all glass, giving on to the verandah, where the occupants can dine out, even in winter. The outer walls are of dark oiled weatherboard. Comparatively inexpensive when it was built, it is now the home of the artist and really utilises the magnificent scenery out of doors.

One of Sydney's show places is a luxury out-of-town house at Newport, on the Palm Beach Peninsula some 20 miles north of the city. It was designed by Bunning and Madden.

The land slopes fairly steeply down to a small beach at the edge of Pittwater, a wide stretch of land-locked water much frequented by yachtsmen and fishermen. Little excavation was needed, except where stone steps were set in the hillside. The design of both house and frontal lawn follows the curve of the beach. Chief materials used were Hawkesbury River sandstone, which gives the curving walls a somewhat rough-hewn appearance, offset by white woodwork, balustrades on upper and lower verandahs and spiral connecting staircase. Sitting in deck chairs on the shaded upper verandah, one has something of the feeling of being on board a yacht. The entire upper storey consists of tastefully decorated and furnished living room and dining room. This is on a level with the road behind. The three bedrooms and offices are on the lower storey.

This is a house expertly designed for the maxi-

## CLASSIFIED ADVERTISING

Do YOU want to hire, buy, sell, rent, find, lose, and otherwise transact business with others in the Construction Industry? If so, your best bet is a CLASSIFIED ad in ARCHITECT & ENGINEER magazine.

SELL that used equipment at a good price; secure competent employees; buy good used equipment; obtain information on wanted materials, etc.

Rates are low 20 cents per word—cash with order—minimum 3 lines. "Position Wanted" ads are half-rate.

Forms close 20th of month preceding date of publication.

**ARCHITECT & ENGINEER**  
MAGAZINE

68 Post Street

San Francisco



mum of comfort and of dignity, and yet to bring you close to the sunlit waterway outside.

Walter Bunning, senior partner of this firm, has given many years of thought to creating essentially Australian homes. He has a strong sense of history, and has written an excellent account of Australia's architecture, from the early days up to the present, in his book "Homes in the Sun". He, too, was awarded a travelling scholarship before the war, sponsored by the New South Wales Board of Architects. After touring Europe and the United States, he worked on the construction of the British and Irish pavilions at the New York World's Fair, then took a post-graduate course in town planning at the London Polytechnic.

A country home designed by Bunning and Madden in north western New South Wales may well become a model for station homestead design, even if it is too expensive for many to follow. Emu Park, a sheep property near Warren, some 400 miles from Sydney, is situated on a level and open plain. It is extremely hot in summer. The house was built, therefore, with the idea of allowing as much air to circulate as possible. Very long and low, it has two wings, both running east and west, linked by an open covered way. Vertical glass louvers allow the air to pass freely through, and an elaborate system of cross-ventilation has been worked out. In the main wing, the roof has an overhang of five feet on the northern side.

The living room and dining room are placed at the centre of this wing, with sliding glass doors on the southern side. Between these two wings is a tiled terrace enclosing a lawn and flower garden. The house is well-insulated and also protected on the weather side from the dust storms of the summer.

The slender pillars sustaining the covered way for cars at the wide glass front doors deepen the effect of the long, low clean lines of this homestead.

This style of house is as well adapted to its setting as anything that has been designed in the hot climates of South America or the Orient. It is also a radical departure from the traditional outback home.

As Walter Bunning has expressed it: "The influence on Australian architecture until the present century has been continually English, with slight modifications to suit the climate. During this century the Spanish and Italian note has been dominant in domestic design, while American influence is clearly reflected in commercial buildings. Sound Contemporary design introduced by young architects who have travelled in Europe, Britain and America, and who favour developing an aesthetic suitable to the varied climate and character of the country, has not yet become generally accepted. But it is certain that this continent will take considerable cultural strides."

The new movement is gaining ground today. It is significant that the work of students at the university of Sydney, the New South Wales University of Technology and the several architectural schools in Victoria is almost entirely in line with that being done by leading architects in the modern vein. The developing pattern of Australian culture, which is also gaining strength from the large number of European migrants, can be expected to help produce a soundly based indigenous style of architecture before long.

## STOP

Penetration Of  
**MOISTURE**  
**WIND**  
**DUST**  
**VERMIN**

EVERLASTING  
 PROTECTION

## FORDERER CORNICE WORKS

*Manufacturers of*

Hollow Metal Products • Interior Metal Trim  
 Elevator Fronts and Cabs  
 Metal Plaster Accessories • Sanitary Metal Base  
 Flat and Roll Metal Screens  
 Metal Cabinets • Commercial Refrigerators

269 POTRERO AVE.

SAN FRANCISCO, CALIF. HEMLOCK 1-4100

## Parker, Steffens & Pearce

**BUILDERS**

135 South Park, San Francisco

Phone: EXbrook 2-6639

## BARRETT & HILP

**CONTRACTORS**

*Serving The Construction Field  
 Since 1912*

OUR FORTIETH YEAR

918 Harrison Street • San Francisco  
 Telephone DOuglas 2-0700

## JUDSON PACIFIC - MURPHY CORP.

Steel Fabricators  
and  
Erectors

REINFORCING STEEL  
STRUCTURAL STEEL  
BRIDGE CRANES

4300 EASTSHORE HWY.  
EMERYVILLE, CALIF.

Phone:  
OL 3-1717

## CLINTON CONSTRUCTION CO. OF CALIFORNIA

General Contractors

923 FOLSOM STREET • SAN FRANCISCO

SUtter 1-3440

## HOGAN LUMBER CO.

Wholesale and Retail

LUMBER

MILL WORK • SASH & DOORS

Office, Mill, Yard and Docks  
SECOND AND ALICE STREETS • OAKLAND, CALIF.  
Telephone GLencourt 1-6861



**PROTECTIVE  
BUILDING PAPER...**  
WATERPROOF, REINFORCED... USED  
AS SHEATHING PAPER, PROVIDES LIFE-LONG  
PROTECTION FROM ENTRY OF WIND, DUST AND  
MOISTURE. IDEAL FOR STUCCO-BACK, OVER  
SUBFILL, CONCRETE CURING, UNDER FLOORING,  
etc. Write for samples and complete data.

The SISALKRAFT CO.

55 New Montgomery St. San Francisco 3, California

## BOOK REVIEWS PAMPHLETS AND CATALOGUES

**HOUSING RESEARCH.** By Housing and Home Finance Agency, Washington, D. C. A series of 3 Construction Aids, 1) Plumbing Fixtures Arrangement, Price 15 cents; 2) Roof Gutters, Price 10 cents; and 3) House and Site United.

Plumbing Fixture Arrangement is a guide to simplified design of plumbing fixture arrangements to conserve critical metals and manpower, and reduce installation and operational costs. It has a number of drawings and covers a wide range of installations.

Roof Gutters is a guide to the use of alternate materials to conserve critical metals and reduce costs in roof gutter construction. Contains drawings and tables.

House and Site United is a guide to the elimination of waste in manpower and materials and to obtain a better product at reduced cost through proper planning of the house and site. The booklet contains a number of "Do's" and "Don'ts" and has plans and drawings illustrating text.

**JORDANS DICTIONARY OF CIVIL DEFENSE.** By Carlton Wallace. Published by Philosophical Library, Inc., 15 E. 40th St., New York. Price \$2.75.

This book is designed to be of value to members of the Civil Defense services and to everyone concerned with the protection of persons and property in time of war.

The author, Carlton Wallace, is an Associate Fellow of the Institute of Civil Defense, and presentation of the material is arranged alphabetically, group indexed, reference indexed. It contains 16 illustrations and 160 pages.

**PAINTING TREES AND LANDSCAPES IN WATERCOLOR.** By Ted Kautzky. Published by Reinhold Publishing Corp., 330 W. 42nd St., New York. Price \$9.95.

This book is by the same author of *WAYS WITH WATER-COLORS* and offers a companion publication containing valuable information on how to paint such important landscape components as trees, roads, puddles, rain and fog. It shows the solution of difficult problems encountered in detail.

Sixteen paintings in full color plus many sepia tone gravure studies are used successfully to show the fundamentals of good composition, value arrangement, balance, rhythm and pattern of design. Basic brush strokes for tree paintings are amply illustrated, and separate chapters are devoted to painting forests and different types of trees.

A valuable book for art students, landscape architects, interior decorators, commercial artists, amateur painters and others.

### NEW CATALOGUES AVAILABLE

Any of the catalogues or folders described here may be obtained by forwarding your request as indicated in the coupon below to the office of the ARCHITECT & ENGINEER. Merely mark the items you want and clip or paste the coupon to your letterhead.

**438. PORCELAIN ENAMEL CURTAIN WALL MATERIAL.** A technical bulletin describing "Seaporclad", new porcelain enamel curtain wall material, has been issued by the manufacturer, Seaporcel Metals, Inc. "Seaporclad" panels are of sandwich construction with skins of diversified metals laminated under high pressure to fire-resistant, thermal and sound insulating cores. The product is available with two faces of porcelain enameled steel or with one porcelain side and an opposite skin of another sheet metal material. Panels can be used to provide a single interior-exterior wall, as a veneer, ashlar, permanent or removable partition. The two-color booklet outlines the properties of the new insulated panels, provides seven detail drawings showing possible installation methods and describes its use in the construction of a hospital and a school building. A.I.A., 17-A, 8 pages, 11/52.

**439. HOLLOW CORE FLOOR SLABS FOR HEATING SYSTEMS.** A new folder on "The Flexicore Split System of Warm Air Panel Heating" features two systems that utilize the hollow cores of Flexicore precast concrete slabs to combine the benefits of both circulated air and "radiant" panel heating. The folder illustrates both the single-duct and counterflow systems with two-color diagrams of air flow and installation details. Additional diagrams detail suggested baseboard installations for the Flexicore Company, Inc. A.I.A., 4-K, 6 pages, 10/52.

**440. SURFACE MOUNTING FLUORESCENT LUMINAIRES.** A series of two- and three-lamp fluorescent luminaires for surface mounting are illustrated and described in two-color catalog. Designed for single or continuous mounting, these units are available with either louver or diffusing glass shielding, with or without luminous side panels. The catalog lists detailed specifications on these direct-type luminaires, with dimensioned drawings of the top and end views for two- and three-lamp use. For each basic fixture type, the candlepower distribution curve is given for glass or louver shielding. Coefficients of utilization are also included. A.I.A., 31-F2, 8 pp, 5-50, 11/52.

**441. HOME DRAINAGE BULLETIN.** An informative and useful illustrated bulletin, explaining proper installation of perforated drain tile, for basement and foundation drainage as well as sanitary septic tank disposal systems is now available. It has been prepared by the Bowerston Shale Company, drainage material specialists, of Bowerston, Ohio. The bulletin entitled "New Drain Tile for Homes," includes diagrams of home drainage plans and an effective septic tank disposal system. 4 pages, illus., 5/52.

**442. STEEL FRAMES FOR SLIDING GLASS DOORWALLS.** Los Angeles—A new approach to the problem of presenting essential information on horizontal sliding glass doorwalls and windows to architects and builders is contained in two brochures just released by Steelbilt, Inc. All full scale installation details have been omitted and only isometric drawings of engineering features and construction details are included. The primary objective of the literature is to enable the reader to easily evaluate the product and its adaptability to specific design and construction problems. Full scale installation details are available in a separate portfolio containing loose leaf sheets for tracings. A.I.A., 16-E, 10 pages, illus., 10/52.

**443. DOUBLE HUNG WINDOWS.** A new folder has just been published covering four points of protection against wind and rain. Features of a new extruded aluminum sill on all FLEET-LITE double, double hung windows according to the manufacturers, Fleet of America, Inc. A KOROSEAL lip along the entire bottom edge of the storm sash and interior sash seals the space between sash and sill. Pile Mohair weatherstripping on the vertical surfaces of the sill as shown in the drawing contacts the inside edge of the sash for a snug fit to block wind-blown rain, snow or dust. 10 pages, illus., 11/52.

**444. SPECIAL PURPOSE STEELS.** "Special purpose steels for architectural beauty and permanence" is the title of a new booklet recently published by Armco Steel Corporation. It covers such metals as stainless steels, porcelain enameling iron, Zincgrip and Zincgrip-Paintgrip sheets. The booklet describes the various types, properties and finishes of these metals, illustrates many applications, and gives specifications. P.O. 1352, 8 pages illus., 9/52.

**445. SPACESAVERS.** A new brochure has been published by New Castle Products describing Modernfold Doors and their Spacesaver qualities. Curved walls and flexible room units are shown with details. Complete description of the possibilities for solving modern space problems opens a new design freedom for architects. Many utilizations of these flexible folding type doors are shown with adaptations and possibilities for use as temporary walls easily moved about within the room. A.I.A., 16-M, 8 pages, illus., 10/52.

## "AMERICAN - MARSH"

CONDENSATION UNIT

Pumping  
Machinery  
for  
Every  
Purpose

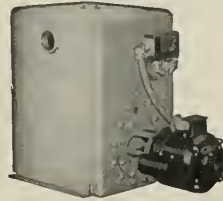

For Service  
Call  
DOuglas  
2-6794  
or  
MUtual 8322

**SIMONDS MACHINERY CO.**  
SAN FRANCISCO 816 FOLSOM  
LOS ANGELES 455 EAST 4TH

## VERMONT MARBLE COMPANY

DOMESTIC AND IMPORTED MARBLES  
GRANITE VENEER

525 MARKET STREET • SAN FRANCISCO 5

Phone: SUtter 1-6747

3522 COUNCIL STREET • LOS ANGELES 4

Phone: DUmkirk 2-7834

**The Most Complete Line of  
STEELS and STEEL BUILDING MATERIALS  
Made by a Single Producer**



See Sweet's Catalog File or write us for  
full information.

**REPUBLIC STEEL CORPORATION**

GENERAL OFFICES: CLEVELAND, OHIO

DENVER, COLORADO . . . . . CONTINENTAL OIL BUILDING  
LOS ANGELES, CALIF. . . . . GENERAL PETROLEUM BUILDING  
SAN FRANCISCO, CALIFORNIA . . . . . RIALTO BUILDING  
SEATTLE, WASH. . . . . WHITE-HENRY-STUART BUILDING

## PACIFIC MANUFACTURING CO.

High Class Interior Finish Quality  
Millwork

16 Beale St., San Francisco  
GARfield 1-7755

2215 El Camino Real, San Mateo  
S. M. 5-0687

304 Bryant Street, Palo Alto  
P. A. 3373

2610 The Alameda, Santa Clara  
S. C. 607 (Factory)

6820 McKinley Avenue, Los Angeles  
THornwall 4196

MAIN OFFICE — SANTA CLARA

**ARCHITECT AND ENGINEER**  
68 Post Street, San Francisco, Calif.

I would like to have a copy of each of the New Catalogues I have circled.

438	439	440	441
442	443	444	445

Please send to the address on my letterhead, or as I have indicated, and to my attention. (Please print your name — no literature will be sent on this coupon after February, 1953.—A. & E.)



## OREGONIAN WILL HEAD LUMBER MANUFACTURERS

Ralph R. Macartney, manager of the Weyerhaeuser Timber Co., Klamath Falls, Oregon, has been elected president of the National Lumber Manufacturers Association, at that organization's annual meeting.

Other officers named to serve with Macartney included J. R. Bemis, president of the Ozan Lumber Co., Prescott, Arizona, vice-president.

## DALLAS YOUNG ELECTED PRESIDENT CONTRACTORS

Dallas Young, vice-president and one of the founders of the contracting firm of MacDonald,

Young & Nelson, Inc., was elected president of the Northern California Chapter of the Associated General Contractors of America, Inc., at the organization's 34th Annual meeting in San Francisco, early in December.

Young has been active in AGC affairs, serving as chairman of the Membership Committee; member of the Finance, Legislative, and Building Committees; and vice chairman of the Labor Committee.

## ROMER SHAWHAN SPEAKER ON BEAUX ARTS PROGRAM

Romer Shawhan, A.I.A., managing director of the Marble Institute of America, spoke before the senior class of the Department of Architecture at Western Reserve College, Cleveland, Ohio, on the subject "The Renaissance of Marble in the Home", and "The Economy of Marble in Commercial Buildings".

The program was a preliminary to the annual Beaux Arts Institute of Design Judgment which this year will feature a hospital to be located in the center of a residential area in a city of 80,000. Author of the exercise is Charles H. McCauley, A.I.A., of Birmingham, Alabama.

## FRANK W. CORTRIGHT RESIGNS FROM NATIONAL ASSOCIATION HOME BUILDERS

Frank W. Cortright, executive vice-president of the National Association of Home Builders, will relinquish his position on March 1st and will take on a new assignment as special consultant to the association.

Cortright has been recovering from a serious illness which incapacitated him during most of 1952, and in tendering his resignation said it "unwise to attempt to continue at the same pace as during the past 11 years."

The association voted him a lifetime membership on the Executive Committee along with a three year contract in his new position.

## PIONEER AIRCRAFT ENGINEER HONORED

Sir Geoffrey de Havilland, world-famed aircraft designer, was presented with the Daniel Guggenheim medal at the annual banquet of The American Society of Mechanical Engineers, recently held in Chicago.

PAUL F. KEIM AT U.C. Paul Keim of Knappen Tippetts Abbott Engineering Co. has been appointed a Prof. in the Civil Engineering Department, University of California at Berkeley, and will teach a course to young engineers relating to contracts, specifications and human relations including the relationship of the engineer, owner, contractor, materialman, etc.

## ALLIANCE ENGINEERS

C. L. WEEKS  
Civil Engineer No. 4943

COST ENGINEERS  
QUANTITY SURVEYORS  
APPRAISERS

★ Preliminary & Final Estimates ★

602 West Santa Barbara Avenue  
Los Angeles 37, California  
ADams 3-7138

## VALUABLE NEWS SERVICE

- BUILDING MATERIAL DEALERS
- CONTRACTORS
- SUB-CONTRACTORS
- MANUFACTURERS AND REPRESENTATIVES

**ARCHITECTS REPORTS** gives advance news on construction projects in Northern California, lists: name of projects, location, architect, proposed cost and other pertinent information.

**HANDY** individual slip-reports, issued daily at a total cost of only

\$10 a month

## ARCHITECT'S REPORTS

Published Daily

The ARCHITECT and ENGINEER, Inc.

68 Post Street, San Francisco - DO 2-8311



# ESTIMATOR'S GUIDE

## BUILDING AND CONSTRUCTION MATERIALS

PRICES GIVEN ARE FIGURING PRICES AND ARE MADE UP FROM AVERAGE QUOTATIONS FURNISHED BY MATERIAL HOUSES TO SAN FRANCISCO CONTRACTORS. 3% SALES TAX ON ALL MATERIALS BUT NOT LABOR

All prices and wages quoted are for San Francisco and the Bay District. There may be slight fluctuation of prices in the interior and southern part of the state. Freight cartage, at least, must be added in figuring country work.

**BONDS**—Performance or Performance plus Labor and Material Bond(s), \$10 per \$1000 on contract price, Labor & Material Bond(s) only, \$5.00 per \$1000 on contract price.

**BRICKWORK—MASONRY—**

Common Brick—Per 1 M laid—\$150.00 up (according to class of work).  
 Face Brick—Per 1 M laid—\$200.00 and up (according to class of work).  
 Brick Steps—\$3.00 and up.  
 Common Brick Veneer on Frame Bldgs.—Approx. \$1.20 and up (according to class of work).  
 Face Brick Veneer on Frame Bldgs.—Approx. \$2.00 and up (according to class of work).  
 Common Brick—\$36.00 per M—truckload lots, delivered.  
 Face Brick—\$81.00 to \$106.00 per M, truckload lots, delivered.

**Glazed Structural Units—Walls Erected—**

Clear Glazed—  
 2 x 6 x 12 Furring ..... \$2.00 per sq. ft.  
 4 x 6 x 12 Partition ..... \$2.25 per sq. ft.  
 4 x 6 x 12 Double Faced  
 Partition ..... 3.00 per sq. ft.  
 For colored glaze add ..... .30 per sq. ft.  
 Mantel Fire Brick \$150.00 per M—F.O.B. Pittsburgh.

Fire Brick—Per M—\$111.00 to \$147.00.  
 Carriage—Approx. \$1.00 per M.  
 Paving—\$75.00.

**Building Tile—**  
 8x5x12-inches, per M. .... \$139.50  
 6x5x12-inches, per M. .... 105.00  
 3 ply per 1000 ft roll ..... 84.00  
 4x5x12-inches, per M. .... 84.00

**Hollow Tile—**  
 12x12x2-inches, per M. .... \$146.75  
 12x12x3-inches, per M. .... 156.85  
 12x12x4-inches, per M. .... 177.10  
 12x12x6-inches, per M. .... 235.30  
 F.O.B. Plant

**BUILDING PAPER & FELTS**

1 ply per 1000 ft. roll. .... \$5.30  
 2 ply per 1000 ft. roll. .... 7.80  
 3 ply per 1000 ft. roll. .... 9.70  
 Brownkin, Standard 500 ft. roll ..... 6.85  
 Sisalkraft, reinforced, 500 ft. roll. .... 8.50

**Sheathing Papers—**  
 Asphalt sheathing, 15-lb. roll. .... \$2.70  
 30-lb. roll. .... 3.70  
 Dempcourse, 216-ft. roll. .... 2.95  
 Blue Plasterboard, 60-lb. roll. .... 5.10

**Felt Papers—**  
 Deadening felt, 3/4-lb., 50-ft. roll. .... \$4.30  
 Deadening felt, 1-lb. .... 5.05  
 Asphalt roofing, 15-lbs. .... 2.70  
 Asphalt roofing, 30-lbs. .... 3.70

**Roofing Papers—**  
 Standard Grade, 108-ft. roll, Light. .... \$2.50  
 Smooth Surface, Medium. .... 2.90  
 Heavy. .... 3.40  
 M. S. Extra Heavy. .... 3.95

**BUILDING HARDWARE—**

Sash cord com. No. 7 ..... \$2.65 per 100 ft.  
 Sash cord com. No. 8 ..... 3.80 per 100 ft.  
 Sash cord spot No. 7 ..... 3.65 per 100 ft.  
 Sash cord spot No. 8 ..... 3.35 per 100 ft.  
 Sash weights, cast iron, \$100.00 ton. .... \$7.75  
 1-Ton lots, per 100 lbs. .... \$4.75  
 Less than 1-Ton lots, per 100 lbs. .... \$4.75  
 Nails, per keg, base ..... \$12.55  
 8-in. spikes ..... 12.45  
 Rim Knob lock sets ..... 1.80  
 Butts, dull brass plated on steel, 3/2x3/2 ..... .76

**CONCRETE AGGREGATES—**

The following prices net to Contractors unless otherwise shown. Carload lots only.

Gravel, all sizes	Bunter per ton	Del'd per ton
Top Sand	\$2.44	\$2.90
Concrete Mix	2.38	3.13
Crushed Rock, 1/2" to 3/4"	2.38	3.06
Crushed Rock, 3/4" to 1 1/2"	2.38	2.90
Roofing Gravel	2.81	2.90
River Sand	2.50	3.00
<b>Sand—</b>		
Lapis (Nos. 2 & 4)	3.56	3.94
Olympia (Nos. 1 & 2)	3.56	3.88
<b>Cement—</b>		
Common (all brands, paper sacks), Per Sack, small quantity (paper)		\$1.05
Carload lots, in bulk per bbl.		3.55
Cash discount on carload lots, 10c a bbl., 10th Prox., less than carload lots \$4.00 per bbl. f.o.b. warehouse or delivered.		
Cash discount 2% on L.C.L.		
Trinity White	1 to 100 sacks, \$3.50 sack warehouse or del.; \$9.56 bbl. carload lots.	
Medusa White		

**CONCRETE READY-MIX—**

Delivered in 4-yd. loads:  
 Per cubic yard, 1-8 Mix ..... \$ 9.80  
 1-7 Mix ..... 10.15  
 1-6 Mix ..... 10.70  
 1-5 Mix ..... 11.40  
 Curing Compound, clear, drums, per gal. .... 1.03

**CONCRETE BLOCKS—**

	Haydite	Be-salf
4x8x16-inches, each	\$ .19	\$ .19
6x8x16-inches, each	.23	.235
8x8x16-inches, each	.27	.27
12x8x16-inches, each	.38	.40
12x8x24-inches, each		.60

**Haydite Aggregates—**  
 3/4-inch to 1/2-inch, per cu. yd. .... \$7.75  
 3/8-inch to 3/4-inch, per cu. yd. .... 7.75  
 No. 6 to 0-inch, per cu. yd. .... 7.75

**DAMP-PROOFING and Waterproofing—**

Two-coat work, \$9.00 per square.  
 Membrane waterproofing—4 layers of saturated felt, \$10.00 per square.  
 Hot coating work, \$5.00 per square.  
 Medusa Waterproofing, \$3.50 per lb. San Francisco Warehouse.  
 Tricoval concrete waterproofing, 60c a cubic yd. and up.

**ELECTRIC WIRING—**\$15 to \$20 per outlet for conduit work (including switches).  
 Knob and tube average \$6.00 per outlet.

**ELEVATORS—**

Prices vary according to capacity, speed and type. Consult elevator companies. Average cost of installing a slow speed automatic passenger elevator in small four story apartment building, including entrance doors, about \$9,500.00.

**EXCAVATION—**

Sand, \$1.00; clay or shale, \$1.50 per yard. Trucks, \$30 to \$45 per day.  
 Above figures are an average without water. Steam shovel work in large quantities, less; hard material, such as rock, will run considerably more.

**FIRE ESCAPES—**

Ten-foot galvanized iron balcony, with stairs, \$250 installed on new buildings; \$300 on old buildings.

**FLOORS—**

Asphalt Tile, 1/8 in. guage 18c to 35c per sq. ft.  
 Composition Floors, such as Magnesite 40c-\$1.25 per sq. ft.  
 Linoleum, standard guage, sq. yd. .... \$2.75  
 Mastipave—\$1.50 per sq. yd.  
 Battleship Linoleum—1/8"—\$3.00 sq. yd.  
 Terrazo Floors—\$2.00 per sq. ft.  
 Terrazo Steps—\$2.50 per lin. ft.  
 Mastic Wear Coat—according to type—20c to 35c.  
**Hardwood Flooring—**  
 Oak Floor, g-T & G—Unfin.—  
 Clear Qtd., White ..... \$12 1/2 x 1/2 x 2 1/2 \$425  
 Clear Qtd., Red ..... 405 380 \$ \$  
 Select Qtd., Red or White. 355 340  
 Clear Pln., Red or White. 355 340 335 315  
 Select Pln., Red or White. 340 320 325 300  
 #1 Common, Red or White 315 310 305 280  
 #2 Common, Red or White 305

**Prefinished Oak Flooring—**

	Prime	Standard
1/2 x 2	\$369.00	\$359.00
1/2 x 2 1/2	380.00	370.00
1/2 x 2 1/4	390.00	381.00
1/2 x 3	375.00	365.00
1/2 x 2 1/4 & 3/4 Ranch Plank	395.00	375.00
		415.00

**Unfinished Maple Flooring—**

1/2 x 2 1/4 First Grade	\$390.00
1/2 x 2 1/4 2nd Grade	365.00
1/2 x 2 1/4 2nd & Btr. Grade	375.00
1/2 x 2 1/4 3rd Grade	240.00
1/2 x 3/4 3rd & Btr. Jrd. EM.	380.00
1/2 x 3/4 2nd & Btr. Jrd. EM.	370.00
33/32 x 2 1/4 First Grade	400.00
33/32 x 2 1/4 2nd Grade	360.00
33/32 x 2 1/4 3rd Grade	320.00
Floor Layer Wage \$2.50 hr.	

**GLASS—**

Single Strength Window Glass ..... \$ .30 per sq. ft.  
 Double Strength Window Glass ..... .45 per sq. ft.  
 Plate Glass, 1/4 polished to 75 ..... 1.60 per sq. ft.  
 75 to 100 ..... 1.74 per sq. ft.  
 1/4 in. Polished Wire Plate Glass ..... 2.50 per sq. ft.  
 1/4 in. Rgh. Wire Glass ..... .80 per sq. ft.  
 1/8 in. Obscure Glass ..... .44 per sq. ft.  
 1/8 in. Obscure Glass ..... .63 per sq. ft.  
 1/8 in. Heat Absorbing Obscure ..... .54 per sq. ft.  
 3/16 in. Heat Absorbing Wire ..... .72 per sq. ft.  
 1/8 in. Ribbed ..... .44 per sq. ft.  
 1/8 in. Ribbed ..... .63 per sq. ft.  
 1/8 in. Rough ..... .44 per sq. ft.  
 1/8 in. Rough ..... .63 per sq. ft.  
 Glazing of above additional \$15 to 30 per sq. ft.  
 Glass Blocks, set in place ..... 3.50 per sq. ft.

**HEATING—**

**Furnaces— Gas Fired**  
 Floor Furnace, 25,000 BTU ..... \$ 70.50  
 35,000 BTU ..... 77.00  
 45,000 BTU ..... 90.50  
 Automatic Control, Add ..... 39.00  
 Dual Wall Furnaces, 25,000 BTU ..... 91.50  
 35,000 BTU ..... 99.00  
 45,000 BTU ..... 117.00  
 With Automatic Control, Add ..... 39.00  
 Unit Heaters, 50,000 BTU ..... 202.00  
 Gravity Furnace, 65,000 BTU ..... 198.00  
 Forced Air Furnace, 75,000 BTU ..... 313.50  
**Water Heaters— 5-year guarantee**  
 With Thermostat Control,  
 20 gal. capacity ..... 87.50  
 30 gal. capacity ..... 103.95  
 40 gal. capacity ..... 120.00

**INSULATION AND WALLBOARD—**

Rockwool Insulation—	
(2") Less than 1,000 □ ft.	\$64.00
(2") Over 1,000 □ ft.	59.00
Cotton Insulation—Full thickness	
(3%)	\$95.50 per M sq. ft.
Sisalation Aluminum Insulation—Aluminum coated on both sides.	\$23.50 per M sq. ft.
Tileboard—4 1/4" panel	\$9.00 per panel
Wallboard—1/2" thickness	\$55.00 per M sq. ft.
Finished Plank	\$69.00 per M sq. ft.
Ceiling Tileboard	\$69.00 per M sq. ft.

**IRON—**Cost of ornamental iron, cast iron, etc., depends on designs.

**LUMBER—**

S4S No. 2 and better common	
O.P. or D.F., per M. f.b.m.	\$100.00
Rough, No. 2 common O.P. or D.F., per M. f.b.m.	95.00

**Flooring—**

	Per M Delvd.
V.G.-D.F. 8 & 8tr. 1 x 4 T & G Flooring	\$225.00
"C" and better—all	225.00
"D" and better—all	225.00
Rwd. Rustic—"A" grade, medium dry	185.00
	8 to 24 ft.

Plywood, per M sq. ft.	
1/4-inch, 4.0x8.0-515	\$135.00
1/2-inch, 4.0x8.0-515	219.00
3/4-inch, per M sq. ft.	292.00
Plywood	111 1/2¢ per sq. ft.
Platymor	25¢ per sq. ft.

**Shingles (Rwd. not available)—**

Red Cedar No. 1—\$9.50 per square; No. 2, \$7.00; No. 3, \$5.00.	
Average cost to lay shingles, \$6.00 per square.	
Cedar Shakes—1/2" to 3/4" x 24/26 in handsplit tapered or split resawn, per square.	\$15.25
3/4" to 1 1/4" x 24/26 in split resawn, per square	17.00
Average cost to lay shakes.—8.00 per square	
Pressure Treated Lumber—	
Wormized	Add \$35 per M to above
Crossed, 8-lb. treatment	Add \$45 per M to above

**MARBLE—**(See Dealers)

**METAL LATH EXPANDED—**

Standard Diamond, 3/40, Copper Bearing, LCL, per 100 sq. yds.	\$43.50
Standard Ribbed, ditto.	\$47.50

**MILLWORK—**Standard.

D. F. \$150 per 1000. R. W. Rustic \$175 per 1000 (delivered).	
Double hung box window frames, average with trim, \$12.50 and up, each.	
Complete door unit, \$15 to \$25.	
Screen doors, \$8.00 to \$12.00 each.	
Patent screen windows, \$1.25 a sq. ft.	
Cases for kitchen pantries seven ft. high, per lineal ft., upper \$9.00 to \$11.00; lower \$12.00 to \$13.00.	
Dining room cases, \$20.00 per lineal foot. Rough end finish about \$1.00 per sq. ft.	
Lebor—Rough carpentry, warehouse heavy framing (average), \$75.00 per M.	
For smaller work average, \$85.00 to \$100. per 1000.	

**PAINTING—**

Two-coat work	per yard 85¢
Three-coat work	per yard \$1.10
Cold water painting	per yard 25¢
Whitewashing	per yard 15¢

Linseed Oil, Strictly Pure (Basic 7 1/2 lbs. per gal.)	Wholesale Raw Boiled
Light iron drums	per gal. \$2.28 \$2.34
5-gallon cans	per gal. 2.40 2.46
1-gallon cans	each 2.52 2.58
Quart cans	each .71 .72
Pint cans	each .38 .39
1/2-pint cans	each .24 .24
Turpentine	Pure Gum
(Basic, 7.2 lbs. per gal.)	Spirits
Light iron drums	per gal. \$1.65
5-gallon cans	per gal. 1.76
1-gallon cans	each 1.88
Quart cans	each .54
Pint cans	each .31
1/2-pint cans	each .20

Pioneer White Lead in Oil Heavy Paste and All Purpose (Soft Paste)				
	List Price	Price to Painters		
Net Weight	per 100 lbs.	Pr. per 100 lbs.	Pr. per 100 lbs.	
Packages	lbs.	pkgs.	lbs.	pkgs.
100-lb. kegs	\$28.35	\$29.35	\$27.50	\$27.50
50-lb. kegs	30.05	15.03	28.15	14.08
25-lb. kegs	30.35	7.59	28.45	7.12
5-lb. cans*	33.35	1.34	31.25	1.25
1-lb. cans*	36.00	36	33.75	.34
500 lbs. (one delivery)	3/4¢	per pound less than above		

*Heavy Paste only.				
Pioneer Dry White Lead—Litharge—Dry Red Lead—Red Lead in Oil				
Price to Painters—Price Per 100 Pounds				
	100 lbs.	50 lbs.	25 lbs.	
Products	100 lbs.	50 lbs.	25 lbs.	
Dry White Lead	\$26.50	\$	\$	
Litharge	25.95	26.60	26.90	
Dry Red Lead	27.20	27.85	28.15	
Red Lead in Oil	30.65	31.30	31.60	
	*Pound cans, \$37 per lb.			

**PATENT CHIMNEYS—**

6-inch	\$2.50 lineal foot
8-inch	3.00 lineal foot
10-inch	4.00 lineal foot
12-inch	5.00 lineal foot

**PLASTER—**

Neat wall, per ton delivered in S. F. in paper bags, \$17.60.

**PLASTERING (Interior)—**

3 Coats, metal lath and plaster	Yard \$3.00
Keene cement on metal lath	3.50
Ceilings with 3/4 hot roll channels metal lath (lathed only)	3.00
Sailings with 3/4 hot roll channels metal lath plastered	4.50
Single partition 3/4 channel lath 1 side (lath only)	3.00
Single partition 3/4 channel lath 2 inches thick plastered	8.00
4-inch double partition 3/4 channel lath 2 sides (lath only)	5.75
4-inch double partition 3/4 channel lath 2 sides plastered	8.75
Thermas single partition; 1" channels; 2 1/4" overall partition width. Plastered both sides	7.50
Thermas double partition; 1" channels; 4 1/4" overall partition width. Plastered both sides	11.00
3 Coats over 1" Thermas nailed to one side wood studs or joists	4.50
3 Coats over 1" Thermas suspended to one side wood studs with spring sound insulation clip	5.00
Note—Channel lath controlled by limitation orders.	

**PLASTERING (Exterior)—**

2 coats cement finish, brick or concrete wall	Yard \$2.50
3 coats cement finish, No. 18 gauge wire mesh	3.50
Lime—\$4.00 per bbl. at yard.	
Practical Lime—\$4.15 per bbl. at yard.	
Rock or Grip Lath—3/4"—30¢ per sq. yd.	
1/2"—29¢ per sq. yd.	
Composition Stucco—\$4.00 sq. yard (applied).	

**PLUMBING—**

From \$200.00 per fixture up, according to grade, quality and runs.

**ROOFING—**

"Standard" tar and gravel, 4 ply.	\$13.00 per sq. for 30 sqs. or over.
Less than 30 sqs.	\$16.00 per sq.
Tile \$40.00 to \$50.00 per square.	
No. 1 Redwood Shingles in place, 4 1/2 in. exposure, per square	\$18.25
5/2 No. 1 Cedar Shingles, 5 in. exposure, per square	14.50
5/8 x 16"—No. 1 Little Giant Cedar Shingles, 5" exposure, per square.	18.25
4/2 No. 1-24" Royal Cedar Shingles 7 1/2" exposure, per square	23.00
Ro-coat with Gravel	\$5.50 per sq.

Asbestos Shingles, \$27 to \$35 per sq. laid, 1/2 to 3/4 x 25" Resawn Cedar Shakes, 10" Exposure	\$30.00
1/4 to 1 1/4 x 25" Resawn Cedar Shakes, 10" Exposure	\$35.00
1 x 25" Resawn Cedar Shakes, 10" Exposure	22.00
Above prices are for shakes in place.	

**SEWER PIPE—**

C.I. 6-in. to 24-in. B. & S. Class B and heavier, per ton	\$99.50
Vitrified, per foot: L.C.L. F.O.B. Warehouse, San Francisco.	
Standard, 8-in.	\$.66
Standard, 12-in.	1.30
Standard, 24-in.	5.41
Clay Drain Pipe, per 1,000 L.F. L.C.L., F.O.B. Warehouse, San Francisco:	
Standard, 6-in. per M.	\$240.00
Standard, 8-in. per M.	400.00

**SHEET METAL—**

Windows—Metal, \$2.50 a sq. ft. Fire doors (average), including hardware \$2.80 per sq. ft, size 12'x12'. \$3.75 per sq. ft., size 3'x6'.

**SKYLIGHTS—**(not glazed)

Galvanized iron, per sq. ft.	\$1.25
Vented hip skylights, per sq. ft.	2.25
Aluminum, pyralites, (unglazed), per sq. ft.	1.25
(installed and glazed), per sq. ft.	1.85

**STEEL—STRUCTURAL—**

\$290 per ton erected, when out of mill. \$350 per ton erected, when out of stock.

**STEEL REINFORCING—**

\$200.00 per ton, in place.	
1/4-in. Rd. (Less than 1 ton) per 100 lbs.	\$8.90
3/8-in. Rd. (Less than 1 ton) per 100 lbs.	7.80
1/2-in. Rd. (Less than 1 ton) per 100 lbs.	7.50
3/4-in. Rd. (Less than 1 ton) per 100 lbs.	7.25
7/8-in. Rd. (Less than 1 ton) per 100 lbs.	7.15
1-in. and (Less than 1 ton). 7 to 1 ton to 5 tons, deduct 25¢.	

**STORE FRONTS—**

Individual estimates recommended. See ESTIMATORS' DIRECTORY for Architectural Veneer (3), and Mosaic Tile (35).

**TILE—**

Ceramic Tile Floors—Commercial \$1.20 to \$1.60 per sq. ft.	
Cove Base—\$1.40 per lin. ft.	
Quarry Tile Floors, 6x6" with 6" base @ \$1.35 per sq. ft.	
Tile Wainscots & Floors, Residential, 4/4x4/4", @ \$1.65 to \$2.00 per sq. ft.	
Tile Wainscots, Commercial Jobs, 4/4x4/4" Tile, @ \$1.50 to \$1.65 per sq. ft.	
Asphalt Tile Floor 1/4" @ \$1.18 - .35 sq. yd.	
Light shades slightly higher.	
Cork Tile—\$.70 per sq. ft.	
Mosaic Floors—See dealers.	
Linenum tile, per □ ft.	\$.65
Rubber tile, per □ ft.	\$.55 to \$.75
Furring Tile	
Scored	F.O.B. S. F.
12 x 12, Each	\$.17
Krafftile: Per square foot	Small Large
Patio Tile—Niles Red	Lots
6 x 12 x 3/8 inch, plain	\$.40
6 x 12 x 7/8 inch, plain	.44
6 x 6 x 3/8 inch, plain	.46
6 x 6 x 7/8 inch, plain	.42

Building Tile—	
8 1/2 x 12-inches, per M	\$139.50
6 x 12 x 12-inches, per M	105.00
4 1/2 x 12-inches, per M	84.00
Hollow Tile—	
12 x 12 x 2-inches, per M	\$146.75
12 x 12 x 3-inches, per M	156.85
12 x 12 x 4-inches, per M	177.10
12 x 12 x 6-inches, per M	235.30
	F.O.B. Plant

**VENETIAN BLINDS—**

75¢ per square foot and up. Installation extra

**WINDOWS—STEEL—INDUSTRIAL**

Cost depends on design and quality required.

# ARCHITECT AND ENGINEER ESTIMATOR'S DIRECTORY

## Building and Construction Materials

EXPLANATION—Building and construction materials are shown in major classified groups for general identification purposes with names and addresses of suppliers of materials listed in detail under group classification where name first appears—main offices are shown first with branch or district offices following. The numeral appearing in listings \*(3) refers to the major group classification where complete data on the dealer, or representative, may be found.

<b>ADHESIVES (11)</b> Wall and Floor Tile Adhesives THE CAMBRIDGE TILE MFG. CO. *(351)	<b>CEMENT (10)</b> IDEAL CEMENT COMPANY (Pacific Division) San Francisco 4: 310 Sansome St., GA 1-4100 PACIFIC COAST AGGREGATES, INC. *(111)	<b>HEATING (17)</b> S. T. JOHNSON CO. Oakland 8: 940 Arlington Ave., OL 2-6000 San Francisco: 585 Potrero Ave., MA 1-2757 Philadelphia 8, Pa.: 401 N. Broad St.
<b>AIR CONDITIONING (2)</b> Air Conditioning & Cooling UTILITY APPLIANCE CORP. Los Angeles 58: 4851 S. Alameda St. San Francisco: 1355 Market St., UN 1-4908	<b>CONCRETE AGGREGATES (11)</b> Ready Mixed Concrete PACIFIC COAST AGGREGATES, INC. San Francisco: 400 Alabama St., XL 2-1616 Sacramento: 16th and A Sts., GI 3-6586 San Jose: 790 Stockton Ave., CY 2-5620 Oakland: 2400 Peralta St., GL 1-0177 Stockton: 820 So. California St., ST 8-8643	<b>SCOTT COMPANY</b> San Francisco: 243 Minna St., YU 2-0400 Oakland: 113 - 10th St., GL 1-1937 San Jose, Calif. Los Angeles, Calif.
<b>ARCHITECTURAL VENEER (3)</b> Ceramic Veneer GLADDING, McBEAN & CO. San Francisco: Harrison at 9th St., UN 1-7400 Los Angeles: 2901 Los Feliz Blvd., DL 2121 Portland: 110 S.E. Main St., EA 6179 Seattle: 1500 First Ave. S., EL 4711 Spokane: 1102 N. Monroe St., BR 3259 THE CAMBRIDGE TILE MFG. CO. *(135)	<b>CONCRETE AGGREGATES (11)</b> Lightweight Aggregates AMERICAN PERLITE CORP. Richmond: 26th & B. St. - Yd. 2, RI 4307	UTILITY APPLIANCE CORP. *(21) Electric Heaters WESIX ELECTRIC HEATER CO. San Francisco 5: 390 First St., GA 1-2211 Los Angeles: 520 W. 7th St., MI 8096 Portland: Terminal Sales Bldg., BE 2050 Seattle: Securities Bldg., SE 5028
<b>ARCHITECTURAL VENEER (3)</b> Ceramic Veneer GLADDING, McBEAN & CO. San Francisco: Harrison at 9th St., UN 1-7400 Los Angeles: 2901 Los Feliz Blvd., DL 2121 Portland: 110 S.E. Main St., EA 6179 Seattle: 1500 First Ave. S., EL 4711 Spokane: 1102 N. Monroe St., BR 3259 THE CAMBRIDGE TILE MFG. CO. *(135)	<b>DOORS (12)</b> Hollywood Doors WEST COAST SCREEN CO. Los Angeles: 1127 E. 63rd St., AD 1-1108 W. P. FULLER CO. Seattle, Tacoma, Portland NICOLA DOOR SALES CO. San Francisco: 3045 19th St. F. M. COBB CO. Los Angeles & San Diego SOUTHWESTERN SASH & DOOR Phoenix, Tucson, Arizona El Paso, Texas HOUSTON SASH & DOOR Houston, Texas	Designer of Heating THOMAS B. HUNTER San Francisco 4: 41 Sutter St., GA 1-1164
<b>BANKS - FINANCING (4)</b> CROCKER FIRST NATIONAL BANK OF S. F. San Francisco, Post & Montgomery Sts., EX 2-7700	<b>DOORS (12)</b> Screen Doors WEST COAST SCREEN DOOR CO. (See above)	<b>INSULATION AND WALL BOARD (18)</b> LUMBER MANUFACTURING CO. San Francisco: 225 Industrial Ave., JU 7-1760 PACIFIC COAST AGGREGATES, INC. *(111) SISKRAFFT COMPANY *(19)
<b>BATHROOM FIXTURES (5)</b> Ceramic THE CAMBRIDGE TILE MFG. CO. *(35)	<b>FIRE ESCAPES (13)</b> MICHEL & PFEFFER IRON WORKS, INC. South Linden & Tanforan Ave. South San Francisco: JU 4-8362	WESTERN ASBESTOS COMPANY San Francisco: 675 Townsend St., KL 2-3868 Oakland: 251 Fifth Avenue, GL 1-2345 Stockton: 733 S. Van Buren, ST 4-9421 Sacramento 1331 - T St., HU 1-0125 Fresno: 434 - P St., FR 2-1600
<b>BATHROOM FIXTURES (5)</b> Ceramic THE CAMBRIDGE TILE MFG. CO. *(35)	<b>FIREPLACES (14)</b> Heat Circulating SUPERIOR FIREPLACE CO. Los Angeles: 1708 E. 15th St., PR 8393 Baltimore, Md.: 601 No. Point Rd.	<b>IRON—Ornamental (10)</b> MICHEL & PFEFFER IRON WORKS, INC. *(13)
<b>BASS PRODUCTS (6)</b> GREENBERG'S, M. & SONS San Francisco 7: 765 Folsom, EX 2-3143 Los Angeles 23: 1258 S. Boyle, AN 3-7108 Seattle 4: 1016 First Ave. So., MA 5140 Phoenix: 3009 N. 19th Ave., Apt. 92, PH 2-7663 Portland 4: 510 Builders Exch. Bldg., AT 6443	<b>FLOORS (15)</b> Hardwood Flooring HOGAN LUMBER COMPANY Oakland: Second and Alice Sts., GL 1-6861	<b>LANDSCAPING (20)</b> Landscape Contractors HENRY C. SOTO CORP. Los Angeles: 13,000 S. Avalon Blvd., ME 4-6617
<b>BATHROOM FIXTURES (5)</b> Ceramic THE CAMBRIDGE TILE MFG. CO. *(35)	<b>FLOORS (15)</b> Hardwood Flooring HOGAN LUMBER COMPANY Oakland: Second and Alice Sts., GL 1-6861	<b>LIGHTING FIXTURES (21)</b> SMOOT-HOLMAN COMPANY Inglewood, Calif., OR 8-1217 San Francisco: 55 Mississippi St., MA 1-8474
<b>BASS PRODUCTS (6)</b> GREENBERG'S, M. & SONS San Francisco 7: 765 Folsom, EX 2-3143 Los Angeles 23: 1258 S. Boyle, AN 3-7108 Seattle 4: 1016 First Ave. So., MA 5140 Phoenix: 3009 N. 19th Ave., Apt. 92, PH 2-7663 Portland 4: 510 Builders Exch. Bldg., AT 6443	<b>FLOORS (15)</b> Hardwood Flooring HOGAN LUMBER COMPANY Oakland: Second and Alice Sts., GL 1-6861	<b>LUMBER (22)</b> Shingles LUMBER MANUFACTURING CO. *(18)
<b>BUILDING PAPERS &amp; FELTS (9)</b> ANGIER PACIFIC CORP. San Francisco 5: 55 New Montgomery St., DO 2-4416 Los Angeles: 7424 Sunset Blvd. PACIFIC COAST AGGREGATES, INC. *(111) SISKRAFFT COMPANY San Francisco 5: 55 New Montgomery St., EX 2-3066 Chicago, Ill.: 205 West Wacker Drive	<b>FLOORS (15)</b> Hardwood Flooring HOGAN LUMBER COMPANY Oakland: Second and Alice Sts., GL 1-6861	<b>MARBLE (23)</b> VERMONT MARBLE COMPANY San Francisco 5: 525 Market St., SU 1-6747 Los Angeles 4: 3522 Council St., DU 2-7834
<b>BUILDING PAPERS &amp; FELTS (9)</b> ANGIER PACIFIC CORP. San Francisco 5: 55 New Montgomery St., DO 2-4416 Los Angeles: 7424 Sunset Blvd. PACIFIC COAST AGGREGATES, INC. *(111) SISKRAFFT COMPANY San Francisco 5: 55 New Montgomery St., EX 2-3066 Chicago, Ill.: 205 West Wacker Drive	<b>FLOORS (15)</b> Hardwood Flooring HOGAN LUMBER COMPANY Oakland: Second and Alice Sts., GL 1-6861	<b>METAL LATH EXPANDED (24)</b> PACIFIC COAST AGGREGATES, INC. *(111)
<b>BUILDING HARDWARE (9a)</b> THE STANLEY WORKS San Francisco: Monadnock Bldg., YU 6-5914 New Britain, Conn.	<b>GLASS (16)</b> W. P. FULLER COMPANY San Francisco: 301 Mission St., EX 2-7151 Los Angeles, Calif. Portland, Ore.	<b>MILLWORK (25)</b> LUMBER MANUFACTURING COMPANY *(18) MULLEN MANUFACTURING COMPANY San Francisco: 60-80 Rausch St., UN 1-5815 PACIFIC MANUFACTURING COMPANY San Francisco: 16 Beale St., GA 1-7755 Santa Clara: 2610 The Alameda, SC 607 Los Angeles: 6820 McKinley Ave., TH 4196



**PAINTING (26)**

Paint  
W. P. FULLER COMPANY \* (116)

**PLASTER (27)**

Interiors - Metal Lath & Trim  
PACIFIC COAST AGGREGATES, INC. \* (111)  
Exteriors  
PACIFIC PORTLAND CEMENT COMPANY \* (28)

**PLASTIC CEMENT (28)**

IDEAL CEMENT COMPANY  
San Francisco: 31D Sansome St., GA 1-4100

**PLUMBING (29)**

THE HALSEY TAYLOR COMPANY  
Redlands, Calif.  
Warren, Ohio  
THE SCOTT COMPANY \* (171)  
HAHS DRINKING FAUCET COMPANY  
Berkeley 10: 1435 Fourth St., LA 5-3341  
CONTINENTAL WATER HEATER COMPANY  
Los Angeles 31: 1801 Pasadena Ave., CA 6178  
SIMONDS MACHINERY COMPANY  
San Francisco: B16 Folsom St., DO 2-6794  
Los Angeles: 455 East 4th St., MU 8322  
SECURITY VALVE COMPANY  
Los Angeles 31: 410 San Fernando Rd., CA 6191

**RESILIENT TILE (30)**

LE ROY OLSON CO. \* (151)

**SEWER PIPE (32)**

GLADDING, McBEAN & CO. \* (13)

**SHEET METAL (32)**

Windows  
DETROIT STEEL PRODUCTS COMPANY  
Oakland 8: 1310 - 63rd St., DL 2-8826  
San Francisco: Russ Building, DO 2-8890  
MICHEL & PFEFFER IRON WORKS, INC. \* (113)  
PACIFIC COAST AGGREGATES, INC. \* (111)

Fire Doors

DETROIT STEEL PRODUCTS COMPANY

Skylights

DETROIT STEEL PRODUCTS COMPANY

**STEEL—STRUCTURAL (33)**

COLUMBIA STEEL CO.  
San Francisco: Russ Bldg., SU 1-2500  
Los Angeles: 2087 E. Slauson, LA 1171  
Portland: 2345 N. W. Nicolai, BE 7261  
Seattle 1331 3rd Ave. Bldg., MA 1972  
Salt Lake City: Walker Bank Bldg., SL 3-6733  
HERRICK IRON WORKS  
Oakland: 18th & Campbell Sts., GL 1-1767  
JUDSON PACIFIC-MURPHY CORP.  
Emeryville: 4300 Eastshore Highway, OL 3-1717  
REPUBLIC STEEL CORP.  
San Francisco: 116 N. Montgomery St., GA 1-0977  
Los Angeles: Edison Building  
Seattle: White-Henry-Stuart Building  
Salt Lake City: Walker Bank Building  
Denver: Continental Oil Building  
SAN JOSE STEEL COMPANY  
San Jose 195 North Thirtieth St., CO 4184

**STEEL—REINFORCING (34)**

REPUBLIC STEEL CORP. \* (133)  
HERRICK IRON WORKS \* (131)  
SAN JOSE STEEL CO. \* (133)  
COLUMBIA STEEL CO. \* (133)

**CLAY TILE (35)**

THE CAMBRIDGE TILE MFG. CO.  
San Francisco 10: 470 Alabama St., UN 3-1666  
Los Angeles 19: 1335 S. La Brea, WE 3-7800  
GLADDING, McBEAN & CO. \* (13)  
KRAFTILE  
Niles, Calif.: Niles 3611  
San Francisco 5: 50 Hawthorne St., DO 2-3780  
Los Angeles 13: 406 South Main St., MU 7241

**TIMBER—REINFORCING (36)**

Trusses  
WYERHAEUSER SALES CO.  
Tacoma, Wash.  
St. Paul, Minn.  
Newark, N. J.  
Treated Timber  
J. H. BAXTER CO.  
San Francisco 4: 333 Montgomery St., DO 2-3883  
Los Angeles 13: 601 West Fifth St., MI 6294

**WALL TILE (37)**

THE CAMBRIDGE TILE MFG. CO. \* (135)  
GLADDING, McBEAN & CO. \* (13)  
KRAFTILE COMPANY \* (135)

**WINDOWS STEEL (38)**

DETROIT STEEL PRODUCTS CO. \* (132)  
MICHEL & PFEFFER IRON WORKS, INC. \* (113)  
PACIFIC COAST AGGREGATES, INC. \* (111)

**GENERAL CONTRACTORS (39)**

BARRETT & HILP  
San Francisco: 918 Harrison St., DO 2-0700  
Los Angeles: 234 W. 37th Place, AD 3-8161  
DINWIDDIE CONSTRUCTION COMPANY  
San Francisco: Crocker Building, YU 6-2718  
CLINTON CONSTRUCTION COMPANY  
San Francisco: 923 Folsom St., SU 1-3440  
MATCOCK CONSTRUCTION COMPANY  
San Francisco: 604 Mission St., GA 1-5516  
PARKER, STEFFENS & PEARCE  
San Francisco: 135 So. Park, EX 2-6639  
STOLTE, INC.  
Oakland: 8451 San Leandro Blvd., TR 2-1064  
SWINERTON & WALBERG COMPANY  
San Francisco: 225 Bush St., GA 1-2900  
Oakland: 1723 Webster St., HI 4-4322  
Los Angeles, Sacramento, Denver  
P. J. WALKER COMPANY  
San Francisco: 391 Sutter St., YU 6-5916  
Los Angeles: 714 W. Olympic Blvd., RI 7-5521

**TESTING LABORATORIES (ENGINEERS & CHEMISTS (40))**

ABBOT A. HANKS, INC.  
San Francisco: 624 Sacramento St., GA 1-1697  
ROBERT W. HUNT COMPANY  
San Francisco: 251 Kearny St., EX 2-4634  
Los Angeles: 3050 E. Slauson, JE 9131  
Chicago, New York, Pittsburgh  
PITTSBURGH TESTING LABORATORY  
San Francisco: 651 Howard St., EX 2-1747

**BUILDING TRADES WAGE (JOB SITES) NORTHERN, CENTRAL AND SOUTHERN CALIFORNIA**

ATTENTION: The following are the PREVAILING hourly rates of compensation being paid and in effect by employers by agreement between employees and their union; or as recognized and determined by the U. S. Department of Labor. (September 1, 1952.)

CRAFT	San Francisco	Alameda	Contra Costa	Fresno	Sacramento	San Joaquin	Santa Clara	Solano	Los Angeles	San Bernardino	San Diego	Santa Barbara	Kern
ASBESTOS WORKERS	\$2.585	\$2.585	\$2.585	\$2.585	\$2.585	\$2.585	\$2.585	\$2.585	\$2.25	\$2.25	\$2.25	\$2.25	\$2.25
BOILERMAKERS	2.68	2.68	2.68	2.68	2.68	2.68	2.68	2.68	3.00	3.00	2.75	3.00	3.00
BRICKLAYERS	2.25	2.25	2.25	2.25	2.25	2.25	2.25	2.25	1.94	1.94	1.94	1.94	1.94
BRICKLAYERS, HODCARRIERS	2.45	2.45	2.45	2.40	2.40	2.40	2.45	2.45	2.57	2.57	2.57	2.57	2.57
CARPENTERS	2.60	2.60	*2.39	*2.39	*2.39	*2.39	*2.39	*2.39	2.57	2.57	2.57	2.57	2.57
CEMENT FINISHERS	*2.42	*2.42	*2.42	*2.42	*2.42	*2.42	*2.42	*2.42	2.57	2.57	2.57	2.57	2.57
ELECTRICIANS	3.00	3.00	3.00	3.00	3.00	3.00	3.00	3.00	2.25	2.25	2.25	2.25	2.25
ELEVATOR CONSTRUCTORS	2.75	2.70	2.65	2.75	2.915	2.915	2.915	2.915	1.975	1.975	1.975	1.975	1.975
ENGINEERS: MATERIAL HOIST	2.58	2.56	2.56	2.56	2.56	2.56	2.56	2.56	2.78	2.78	2.78	2.78	2.78
GLAZIERS	2.30	2.30	2.30	2.30	2.25	2.30	2.30	2.30	2.16	2.16	2.16	2.16	2.12
IRONWORKERS: ORNAMENTAL	*2.55	2.55	2.55	2.55	2.55	2.55	2.55	2.55	2.70	2.70	2.70	2.70	2.70
REINFORCING	*2.45	2.45	2.45	2.45	2.45	2.45	2.45	2.45	2.70	2.70	2.70	2.70	2.70
STRUCTURAL	*2.70	2.70	2.70	2.70	2.70	2.70	2.70	2.70	2.70	2.70	2.70	2.70	2.70
LABORERS: BUILDING	1.85	1.85	1.85	1.85	1.85	1.85	1.85	1.85	1.94	1.94	1.94	1.94	1.94
CONCRETE	1.85	1.85	1.85	1.85	1.85	1.85	1.85	1.85	1.94	1.94	1.94	1.94	1.94
LATHERS	3.00	3.00	3.00	3.00	3.00	3.00	3.00	3.00	1.94	1.94	1.94	1.94	1.94
MARBLE SETTERS	2.70	2.70	2.70	2.70	2.70	2.70	2.70	2.70	2.125	2.125	2.125	2.125	2.125
MOSAIC & TERRAZZO	7.6125	2.6125	2.6125	2.6125	2.6125	2.6125	2.6125	2.6125	2.25	2.25	2.25	2.25	2.25
PAINTERS	*2.40	2.40	2.40	2.40	2.40	2.40	2.40	2.40	2.40	2.40	2.40	2.40	2.40
PILEDRIVERS	*2.5575	*2.5575	*2.5575	*2.5575	*2.5575	*2.5575	*2.5575	*2.5575	2.38	2.38	2.425	2.22	2.22
PLASTERERS	3.125	3.165	3.175	3.175	3.00	3.00	3.125	3.00	2.38	2.38	2.38	2.38	2.38
PLASTERERS, HODCARRIERS	2.90	2.90	2.90	2.90	2.90	2.90	2.90	2.90	2.125	2.125	2.125	2.125	2.125
PLUMBERS	2.90	2.90	2.90	2.90	2.90	2.90	2.90	2.90	2.075	2.075	2.075	2.075	2.075
ROOFERS	2.50	2.50	2.50	2.50	2.50	2.50	2.50	2.50	2.90	2.90	2.90	2.90	2.90
SHEET METAL WORKERS	2.475	2.475	2.3125	2.43	2.50	2.50	2.40	2.415	2.475	2.475	1.90	2.00	2.00
SPRINKLER FITTERS	2.75	2.70	2.70	2.475	2.425	2.425	2.75	2.75	2.25	2.25	2.175	2.00	2.475
STRAKMITTERS	2.75	2.70	2.70	2.75	2.475	2.475	2.75	2.75	2.25	2.25	2.175	2.00	2.475
TEAM DRIVERS—1/2 Ton or less	1.89	1.99	1.99	1.89	1.89	1.89	1.74	1.89	2.90	2.90	2.90	2.90	2.90
TILESETTERS	2.955	2.955	2.955	2.955	2.955	2.955	2.955	2.955	2.65	2.65	2.65	2.65	2.65

Prepared and compiled by

CENTRAL CALIFORNIA CHAPTER ASSOCIATED GENERAL CONTRACTORS OF AMERICA, with the assistance and cooperation of secretaries of General Contractors Associations and Builders Exchanges of Northern California, and the above information for southern California is furnished by the Labor Relations Department of the Southern California Chapter, ASSOCIATED GENERAL CONTRACTORS OF AMERICA.



## BUILDING INDUSTRY CONFERENCE BOARD ANNUAL ACHIEVEMENT AWARD

The Annual Achievement Award of the Building Industry Conference Board of San Francisco,

was given to James B. Black, president of the Pacific Gas & Electric Company for 1952.



**JAMES B. BLACK**  
President, PG&E

Made for the most outstanding achievement in the industry, following nomination by Board members, this year's selection represents the results of a special committee survey of all candidates. Chairman of the Com-

The Building Industry Conference Board is comprised of representatives of: Northern California Chapter, American Institute of Architects, Producers Council of Northern California, San Francisco Section the American Society of Civil Engineers, Building Owners and Managers Association of San Francisco, Structural Engineers Association of Northern California, Associated Home Builders of San Francisco, Inc., Central California Chapter of American Society of Heating and Ventilating Engineers, San Francisco Federal Savings and Loan Association, Consulting Engineers Association of California, and the Association of Landscape Architects.

## FOUNDATION FOR METAL RESEARCH AMERICAN SOCIETY FOR METALS

In recognition of the grave shortage of engineering students in the United States and the urgent importance of metals research to the security of the free world, the American Society for Metals recently established an initial fund of \$650,000 for the

establishment of a Foundation for Education and Research.

Objective of the new Foundation will be the advancement and dissemination of scientific knowledge, particularly with respect to the technology of metals, for the use and benefit of the public at large, either through education and research, or through the support of educational and research activities in established organizations and institutions.

**HOLLYWOOD JUNIOR**  
COMBINATION  
SCREEN and METAL SASH DOOR  
★  
The "WEATHER-WISE"  
DOOR!!

**A VENTILATING SCREEN DOOR  
A SASH DOOR  
A PERMANENT OUTSIDE DOOR  
ALL 3 IN 1!**

Discriminating home owners and architects have chosen Hollywood Junior as the TRIPLE DOOR VALUE in the COMBINATION SCREEN and METAL SASH DOOR field! A sturdy dependable door, constructed of quality materials, HOLLYWOOD JUNIOR'S EXCLUSIVE PATENTED FEATURES have outmoded old-fashioned screen doors and other doors of its type entirely! . . . . .

**IT GUARANTEES YOU YEAR 'ROUND  
COMFORT, CONVENIENCE and ECONOMY**

WE ALSO MANUFACTURE A COMPLETE LINE OF  
SHUTTERS, C. C. DOORS, SCREENS, SCREEN DOORS, LOUVRE DOORS

**WEST COAST SCREEN CO.**

1145 EAST 63rd STREET      ★      LOS ANGELES, CALIFORNIA

ADAMS 11118

★ ● WRITE FOR FREE ILLUSTRATED LITERATURE ● ★

# CLASSIFIED ADVERTISING

RATE: 20c PER WORD . . . CASH WITH ORDER

MINIMUM \$5.00

**SUPT., BLDG. DEPT.,** wanted to head Bldg. Dept. of City of Burbank in L. A. C., Calif. Sal. \$683 mo. 5 yrs. admin. exp. in chg. of bldg. proj. is req. Full info. may be secured from Pers. Bd. City Hall, Burbank, Calif.

**BUILDERS!** You can make more money; get information you need before it is published elsewhere: Subscribe to the daily ARCHITECTS REPORTS, only \$10.00 per month. Complete information from ARCHITECTS REPORTS, 68 Post Street, San Francisco. Phone DOuglas 2-8311.

**PHOTOGRAPHY.** For the best in construction photography, including exterior and interior, aerial, and progress views . . . you

will find as many others have that it's the SKELTON STUDIOS, 875 O'Farrell St., San Francisco. Telephone PRospect 6-1841.

**COLLECTIONS:** For more than a generation —ready to serve you with competent legal staff, your interests protected at all times, efficient service, bonded agents everywhere, no collection no charge. California Material Dealers Service Co., 925 Hearst Bldg., San Francisco. Phone GARfield 1-5634. Ernest T. Langley, Mgr.

Registered **ARCHITECT**, residential and commercial, 17 years experience, seeks association with medium sized firm. Independent work, design, specifications, supervision,

client contact. BOX J-3, Architect & Engineer, 68 Post Street, San Francisco, Calif.

**ARCHITECTURAL SLIDING SLEEL SASH.** One lot only — new, half price. 13 units, assorted sizes. 353 square feet total. 3 at 7 ft. x 5 ft.; 4 at 7 ft. x 4 1/2 ft.; 1 at 6 ft. x 4 1/2 ft.; 2 at 6 ft. x 4 ft.; 1 at 7 ft. x 3 1/2 ft.; 1 at 4 1/2 ft. x 3 ft.; 1 at 3 ft. x 3 ft. Phone DElaware 3-7378, San Francisco.

**3-BEDROOM HOMES (New) FOR SALE:** Double garage, hardwood floors, fireplace, tile kitchen and bath. MOVE-IN-NOW, low down payment. Rideout & Buchanan streets, E. Marysville [California] near Camp Beale. RONNE, RONNE & RONNE, 520 9th St., Sacramento, or Phone HUDson 1-0235.

## CONSTRUCTION CONTRACTS AWARDED AND MISCELLANEOUS PERSONNEL DATA

**THREE SCHOOL BUILDINGS.** Brawley, Imperial County. Brawley Union School District, owner. 6 classroom, music, arts and 2 administration units, 3 kindergartens, \$291,400. ARCHITECT: Walker, Kalonzes & Klingerman, Los Angeles. Frame & Stucco construction, composition roofing, insulation, steel sash, cement and asphalt tile floors, tile toilets, metal toilet partitions. GENERAL CONTRACTOR: Cotton Construction Co., Chula Vista.

**MISSION ELEMENTARY SCHOOL.** Oceanside, San Diego County. Oceanside-Libby Union School District, owner. 16 classrooms, 3 kindergartens, multi-purpose and administration rooms, kitchen and mechanical room, 36,000 sq. ft., \$548,900. ARCHITECT: Sam Hamill, San Diego. Masonry and stucco construction, composition roofing, slab and asphalt tile floor, radiant heating, steel sash. GENERAL CONTRACTOR: L. C. Anderson Co., San Diego.

**SCHOOL.** Los Angeles, Los Angeles County. Los Angeles Board of Education, owner. \$115,590. ARCHITECT: A. S. Nibecker, Jr., Los Angeles. GENERAL CONTRACTOR: Hudson Construction Co., Los Angeles.

**VANALDEN SCHOOL.** Los Angeles, Los Angeles County. Los Angeles Board of Education, owner. \$113,430. ARCHITECT: A. S. Nibecker, Jr., Los Angeles. Frame and stucco construction. GENERAL CONTRACTOR: Mead & O'Donnell, Los Angeles.

**WOODLAKE AVE. SCHOOL.** Los Angeles,

Los Angeles County. Los Angeles Board of Education, owner. \$119,025. ARCHITECT: A. S. Nibecker, Jr., Los Angeles. Frame & stucco construction. GENERAL CONTRACTOR: Mead & O'Donnell, Los Angeles.

**NEW ELEMENTARY SCHOOL.** Watsonville, Santa Clara County. Watsonville Elementary School, owner. 6 classrooms, administration, kindergarten and toilet rooms, \$145,820. ARCHITECT: John Lyon Reid, San Francisco. Frame & stucco construction. GENERAL CONTRACTOR: T. H. Rosewall, Watsonville.

**NEWCASTLE SCHOOL.** Los Angeles, Los Angeles County. Los Angeles Board of Education, owner. \$112,781. ARCHITECT: A. S. Nibecker, Jr., Los Angeles. Frame & stucco construction. GENERAL CONTRACTOR: Mead & O'Donnell, Los Angeles.

**156th STREET SCHOOL.** Los Angeles, Los Angeles County. Los Angeles Board of Education, owner. 10 classrooms, 2 kindergartens, administration unit & toilets, \$114,940. ARCHITECT: A. S. Nibecker, Jr., Los Angeles. Frame & stucco construction, composition roofing, asphalt tile, wood sash, heating and ventilating. GENERAL CONTRACTOR: Otis Oliver, Gardena.

**COMMUNICABLE DISEASE UNIT.** Los Angeles, Los Angeles County. Los Angeles County Board of Supervisors, owner. 8 story, \$2,786,430. ARCHITECT: Adrian Wilson & Paul R. Williams, Los Angeles. Reinforced concrete construction. GENERAL CONTRACTOR: Robert E. McKee, Inc., Los Angeles.

**WAREHOUSE & 8 SMALL BUILDINGS.** Avon, Contra Costa County. Tide Water Associated Oil Co., owner. \$160,000. STRUCTURAL ENGINEER: Hamilton & Williams, Oakland. Warehouse structural steel frame & protected metal construction. GENERAL CONTRACTOR: Vezey Construction Co., Oakland.

**HIGH SCHOOL ADDITION.** Los Gatos, Santa Clara County. Los Gatos Union High School District, owner. Academic wing, boys gym building, industrial arts building, \$739,500. ARCHITECT: Sobey & Green, Los Gatos & John Lyon Reid, San Francisco. Reinforced concrete & frame construction. GENERAL CONTRACTOR: W. R. Kalsched & Co.

**AGRICULTURAL BUILDING.** Stockton, San Joaquin County. Stockton Board of Education, owner. 1 story, 12,000 sq. ft., \$155,107. ARCHITECT: Mayo & Johnson, Stockton. Reinforced concrete & frame construction. GENERAL CONTRACTOR: Nomellini Construction Co., Stockton.

**SUNSET ELEMENTARY SCHOOL.** Arcata, Humboldt County. Arcata Elementary School District, owner. 7 classrooms, administration, kitchen, kindergarten, multi-purpose, toilet rooms, \$235,454. ARCHITECT: Frank T. Georgeson, Eureka. Frame & stucco construction. GENERAL CONTRACTOR: A. C. Johnson & Sons, Eureka.

**NEW SOUTHWEST GRAMMAR SCHOOL.** San Bruno, San Mateo County. San Bruno Park Elementary School District, owner. 12 classrooms administration, multi-purpose, library arts & crafts room kitchen & toilet rooms, \$52,000. ARCHITECT: Leslie C. Irwin, San Francisco. Tilt-up concrete construction. GENERAL CONTRACTOR: A. F. Stewart, Berkeley.

**SUBURBAN PARK SCHOOL.** Menlo Park, San Mateo County. Ravenswood Elementary

School District, owner. 8 classrooms, administration, kindergarten & toilet rooms, \$164,000. ARCHITECT: Arthur D. Janssen, Menlo Park. Frame & stucco construction. GENERAL CONTRACTOR: M. A. Little, Jr., San Mateo County.

**AUTOMOBILE SALES & SERVICE BUILDING.** San Rafael, Marin County. Del Long Chevrolet, Inc., owner. \$70,000. ARCHITECT: Leonard H. Ford, Walnut Creek. 1 story, 12,000 sq. ft., concrete block, wood roof trusses. GENERAL CONTRACTOR: Chas. O. Jones Co., San Francisco.

**A. P. GIANNINI HIGH SCHOOL.** San Francisco, City & County of S. F., owner. 33 classrooms, administration, 17 industrial arts rooms, library, cafeteria, gymnasium, auditorium & toilet rooms, \$2,851,615. ARCHITECT: H. A. Thomassen & Aleck Wilson, San Francisco. STRUCTURAL ENGINEER: H. J. Brunner, San Francisco. MECHANICAL ENGINEER, Harry S. Haley, San Francisco. ELECTRICAL ENGINEER: Lyle E. Patton, San Francisco. Reinforced concrete construction, 2 story, except auditorium & home-making wing. GENERAL CONTRACTOR: Cahill Bros., San Francisco.

**APARTMENT BUILDING.** Los Angeles, Los Angeles County. Morris Steinberg, owner. 3 story, 37 family, 51 room, 96x129 ft., \$140,000. STRUCTURAL ENGINEER: W. G. Chandler, Los Angeles. Frame & stucco construction, redwood siding, composition roofing, rubber tile covered floors, forced air furnaces, gas wall heaters, stall showers, tile baths, electric bathroom heaters, steel beams, steel sash, concrete block walls, elevators. OWNER BUILDS.

**REST HOME BUILDING.** Berkeley, Alameda County. ARCHITECT: Melton V. Mowbray, Jr., San Leandro. 18 beds, 1 story, part basement, frame & stucco construction, concrete slab floor, radiant heating, asphalt tile floors, \$36,247. GENERAL CONTRACTOR: F. P. Lathrop Construction Co., Berkeley.

**CONSTRUCT FIRE STATION NO. 20.** Los Angeles, Los Angeles County. Los Angeles City Board of Public Works, owner. \$153,647. ARCHITECT: H. C. Chambers and Lester Hibbard, Los Angeles. GENERAL CONTRACTOR: John L. Meek, Los Angeles.

**HEALTH AND RECEIVING HOSPITAL.** Los Angeles, Los Angeles County. Los Angeles City Board of Public Works, owner. 9 stories, offices, laboratories, clinics, X-Ray rooms, auditorium, garage, \$3,665,100. ARCHITECT: Lunden, Hayward & O'Connor. STRUCTURAL ENGINEER: Paul E. Jeffreys & Murray Erick. MECHANICAL & ELECTRICAL ENGINEERS: Ralph E. Phillips, Inc., Los Angeles. Reinforced concrete frame building, freight and passenger elevators, steel stud partitions, lath & plaster. GENERAL CONTRACTOR: Robert E. McKee, Inc., Los Angeles.

**GYMNASIUM BUILDING.** Ukiah, Mendocino County. Ukiah Union High School District, owner. \$297,466. ARCHITECT: C. A. Caulkins, Jr., Santa Rosa. Frame & stucco construction. GENERAL CONTRACTOR: Barrett & Hulp, San Francisco.

**OFFICE & FACTORY BUILDING.** Upland, San Bernardino County. Western Moulding Co., owner. 1 story, 10,000 sq. ft., \$200,000. ARCHITECT: McClellan M. Donald & Markwith. Los Angeles. Paneled walls, wood trusses, composition roofing, steel sash, drywall interior, concrete and asphalt tile covering, framed archway, asphalt tile ceilings. GENERAL CONTRACTOR: Buttriss & McClellan, Los Angeles.

**SUPER MARKET BUILDING.** West Sacramento, Sacramento County. William Fong & Associates, owner. \$1,000,000. ARCHITECT: Wallace & Associates, Sacramento. 1 story,

# FLOORS

FOR EVERY PURSE  
OR PURPOSE

HOSPITALS • COMMERCIAL BUILDINGS • WINERIES • CANNERIES • FOOD PROCESSING • INDUSTRIAL BUILDINGS • WAREHOUSES RESTAURANTS • SCHOOLS

Territories open for Qualified  
Representatives

Specifications and information  
available on request

Free Consultation Service

## LeROY OLSON COMPANY

3070 Seventeenth Street,  
San Francisco, California



80 x 194, concrete block & frame construction. GENERAL CONTRACTOR: Lyman W. Beutler, Sacramento.

**WELLS SCHOOL BUILDINGS.** Rosemead, Los Angeles County. Rosemead School District, owner. 1 story, \$168,350. ARCHITECT: Marsh, Smith & Powell, Los Angeles. Frame & stucco construction. GENERAL CONTRACTOR: Stiglbauer Bros., Downey.

**COUNTY HOSPITAL ADDITION.** Woodland, Yolo County. County of Yolo, owner. 120 beds, clinic, psychiatric rooms, boiler room; \$407,500. ARCHITECT: W. D. Peugh, San Francisco. Concrete floors, reinforced concrete tilt-up walls, 1 story, basement, wood roof, 1 freight elevator. GENERAL CONTRACTOR: Joseph Bettancourt, San Bruno.

**PECK AVENUE SCHOOL.** Manhattan Beach, Los Angeles County. Manhattan Beach School District, owner. 8 classrooms, home-making unit, shop, multi-use unit and administrative unit, frame and stucco construction, composition roofing, structural steel work, cement and asphalt tile floors, acoustical work, steel sash, sheet metal, terrazzo toilet floors, metal toilet partitions, heating and ventilating. ARCHITECT AND ENGINEER: Daniel, Mann, Johnson and Mendenhall, Los Angeles.

**FORT ORD ELEMENTARY SCHOOL.** Fort Ord, Monterey County. Monterey Unified School District, owner. 24 classrooms, administration, multi-purpose, kitchen & toilet rooms, \$464,691. ARCHITECT: Thomas S. Elston, Jr., Carmel. Frame & stucco construction. GENERAL CONTRACTOR: Tomblinson & Huck, Salinas.

**GROVER CLEVELAND ELEMENTARY SCHOOL.** Stockton, San Joaquin County. Stockton Board of Education, owner. 12 classrooms, office & toilet rooms, \$161,384. ARCHITECT: Victor Galbraith, Stockton. Frame & stucco construction. GENERAL CONTRACTOR: Namellini Construction Co., Stockton.

**HIGH SCHOOL.** Victorville, San Bernardino County. Victor Valley High School District, owner. 1 story, \$362,963. ARCHITECT: Marsh, Smith & Powell, Los Angeles. Reinforced concrete. GENERAL CONTRACTOR: T. A. Stanfield.

**PAROCHIAL SCHOOL.** Gilroy, Santa Clara County. Roman Catholic Archbishop of S.F., owner. Administration, 8 classrooms, toilet rooms, \$173,293. ARCHITECT: Vincent Buckley, San Francisco. Frame & stucco construction. GENERAL CONTRACTOR: Howson Bros., Gilroy.

**NEW ELEMENTARY SCHOOL.** Heber, Imperial County. Heber Elementary School District, owner. 5 classrooms, administration unit, and multi-use room, \$273,365. CONSULTING ENGINEERS: Bowen, Rule and Bowen, Los Angeles. Reinforced concrete and frame construction, quarte and vermiculite walls, composition roofing, cement slab and asphaltic tile floors, acoustic ceiling, insulation, terrazzo toilet floors, metal toilet partitions, radiant heating, steel sash, sheet metal. GENERAL CONTRACTOR: Baker Construction Co., Pasadena.

**BOTTLING PLANT & WAREHOUSE.** Oakland, Alameda County. Bireley's Beverages, owner. 1 story, \$100,000. ARCHITECT: Andrew P. Anderson, Oakland. 25,000 sq. ft., reinforced concrete tilt-up construction, wood roof, steel sash. GENERAL CONTRACTOR: Robert D. Bardell, Oakland.

**POLICE FACILITIES BUILDING.** Los Angeles, Los Angeles County. Los Angeles City Board of Public Works, owner. 8 stories, 273,148 sq. ft., administrative; 39,930 sq. ft., jail, 95,748 sq. ft., garage with squad rooms, locker rooms, traffic department, court rooms, store rooms, various offices, auditorium, training department, record

bureau, detention rooms, \$6,142,548. ARCHITECT: Welton Becker, J. E. Stanton, Los Angeles. STRUCTURAL ENGINEERS: Murray Erick, Paul Jeffers, Los Angeles. MECHANICAL AND ELECTRICAL ENGINEERS: Ralph E. Phillips, Inc., Los Angeles. Reinforced concrete construction, masonry, structural steel, lathing and plastering, metal partitions, metal windows and doors, tile marble slate, acoustic tile, resilient flooring and wall covering, terrazzo plumbing, heating, elevators, steel rolling shutters and grilles, fencing, insulation, steel decking and building panels. GENERAL CONTRACTORS: Ford J. Twaits Co. and Morrison-Knudsen Co. (joint venture), Los Angeles.

**DEFENSE HOUSING PROJECT.** Yuma Test Station, Arizona. Public Housing Administration, owner. 100 single dwellings transported, administration, maintenance building, central laundry \$449,700. ARCHITECT: C. Louis Kelley and Charles Pocke, Phoenix. Reconditioning and re-erecting.

**EASTERLY ELEMENTARY SCHOOL ADDITION.** Fresno, Fresno County. Easterly Elementary School District, owner. 8 classrooms & toilet rooms, \$154,200. ARCHITECT: Coates & Metz, Fresno. Frame & stucco construction. GENERAL CONTRACTOR: Ellberg & Conklin, Kingsbury.

**ANACAPA JUNIOR HIGH SCHOOL.** Ventura, Ventura County. Ventura High School District, owner. 5 classrooms wings, 5 classrooms each wing, shop building, home-making library, administrative office, multi-use unit, music room, 18,000 sq. ft. gymnasium, \$1,492,590. ARCHITECTS AND ENGINEERS: Daniel, Mann, Johnson & Mendenhall, Los Angeles. Reinforced concrete

construction, structural steel, steel sash, laminated beams, masonry, lathing and plastering, sheet metal composition roofing, shower stall and dressing rooms, metal toilet partitions, terrazzo tile, acoustic tile, asphalt and plastic floor tile, aluminum louvers, heating and ventilating refrigerator rooms, insulation. GENERAL CONTRACTOR: Barrington & Boike, Santa Paula.

**NEWSPAPER BUILDING.** Monterey, Monterey County. Monterey Peninsula Herald, owner. 1 story & mezzanine, \$229,500. ARCHITECT: Wurster, Bernardi & Emmons, San Francisco. Concrete block & structural steel frame construction. GENERAL CONTRACTOR: Stolle, Inc., Monterey.

**ADDITION TO HOSPITAL BUILDING.** Hawthorne, Los Angeles County. Board of Directors of the Hawthorne Community Hospital, owner. 25,227 sq. ft., 42 beds, surgical facilities, \$423,500. ARCHITECT: Merrill Baird, Glendale. 3 story, type 1 reinforced concrete construction, built-up composition roofing, asphalt tile and terrazzo floors, plaster walls, acoustical tile ceilings, steel sash, air conditioning, 1 elevator, ceramic tile, laminated counter tops. GENERAL CONTRACTOR: Steed Bros., Alhambra.

**VETERANS MEMORIAL BUILDING.** Nevada City, Nevada County. County of Nevada, owner. \$6,000. ARCHITECT: George Sellon, Sacramento. Frame & stucco construction. GENERAL CONTRACTOR: Do Roza-Ribal, Inc., Dutch Flat.

**SWEETWATER HIGH SCHOOL.** National City, San Diego County. Sweetwater Union High School District, owner. Classrooms building, shop addition, and multi-use building, \$357,569. ARCHITECT: Kistner, Curtis & Foster, San Diego. GENERAL CONTRACTOR: O. L. Carpenter, San Diego.

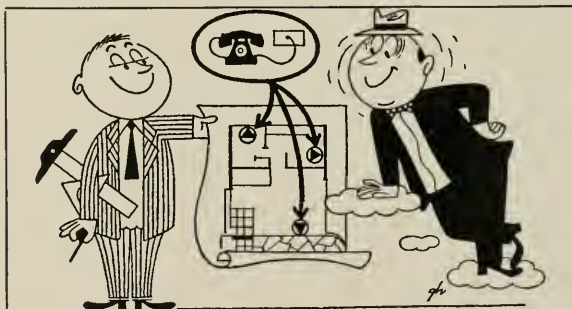

## Built-in telephone facilities mean happier clients for you

That's why so many building plans today include built-in telephone facilities. Clients like the idea of having conduit for concealed telephone wiring, and extra telephone outlets conveniently located to take care of future telephone installations and changes. Modern homes are hardly complete without the low-in-cost, high-in-satisfaction advantages of planned telephone facilities.

Just call Pacific Telephone's free Architects and Builders service. They'll be glad to help you plan telephone facilities for better living tomorrow in the homes you are building today.

*Put built-in telephone facilities in your plans*



**Pacific Telephone**

# IN THE NEWS

## SANTA MONICA HOSPITAL

Plans for construction of a \$1,000,000 addition to the Santa Monica Hospital have been announced with architects A. R. Walker, Gus W. Kalionzes and C. A. Klingerman commissioned to design plans and specifications.

The addition will be a 3-story wing with the first two floors bed area and the third floor devoted to operating and surgical section.

## SERVICE BUILDING FOR SAN LEANDRO

Architect Edw. D. Cerruti of Oakland, has been authorized by the Alameda County Board of Supervisors, to draft plans for the addition of a kitchen and warehouse service building to the Fairmont Hospital in San Leandro.

Cost of the 2-story reinforced concrete and structural steel building is estimated at \$1,200,000.

## SWIMMING POOL FOR SACRAMENTO

The City of Sacramento is completing plans for the construction of a swimming pool and bath house building to be built in South Side Park, Sacramento, which will be ready for use by early spring.

Harry J. Devine, Sacramento, is the architect.

## PUBLIC HEALTH BUILDINGS UC

The Board of Regents of the University of California recently authorized the architectural firm of Masten & Hurd of San Francisco, to draft plans and specifications for a new School of Public Health building to be built on the Berkeley campus at an estimated cost of \$1,125,000.

The structure will be of three and six story, reinforced concrete construction.

## SAN FRANCISCO FIRE HOUSES

Bonds have been issued in the amount of \$4,750,000 to finance the reconstruction and construction of fire houses throughout the City of San Francisco.

Approximately 19 new fire houses will be built and some 23 existing buildings will be modernized and rebuilt.

## RESTAURANT IN PARADISE

Architects Thomas P. Dunlap and James A. Murphy of Chico, recently designed a restaurant building to be built at Paradise, Butte county.

The building will be of 1-story construction and will cost about \$9,980.

## KERN COUNTY HOSPITAL

Architect C. B. Allard and W. J. Thomas, draftsmen, of Bakersfield have been authorized by the Kern County board of supervisors to determine the amount of repairs necessary to rehabilitate buildings at the County Hospital which were damaged during the recent earthquakes.

## MASONIC LODGE BUILDING

The Fairfax Masonic Hall Association Fairfax has announced construction of a new Masonic Lodge Building for Kern Hill

in Marin county.

Estimated cost of the 1 and 2 story frame and stucco building is \$60,000 according to Forrest Gist, Architect for the project.

## NEW ELEMENTARY SCHOOL FOR PIXLEY

Architects Coats & Metz of Fresno, are designing a new Elementary School Building for the Pixley Elementary School District, Tulare county.

The new building will include 14-classrooms, administration facilities, two-kindergartens, multi-purpose rooms, domestic science rooms, and toilet rooms, and will cost approximately \$568,795.

## COUNTY HOSPITAL ADDITION

The architectural firm of Masten & Hurd, San Francisco, are architects for a 2-story frame and reinforced concrete foundation and floor, addition being built to the Contra Costa county County Hospital.

Approximately \$535,500 is being spent on the project.

## NEW HIGH SCHOOL GYMNASIUM

The Board of the Ukiah Union High School District, recently started construction of a new \$284,000 Gymnasium Building at the Ukiah High School, which will be of frame and stucco construction.

Architect C. A. Caulkins, Jr., of Santa Rosa, is the architect.

## LOW RENT HOUSING SAN FRANCISCO

The Housing Authority of the City and County of San Francisco has announced the selection of architects Paul A. Ryan and John M. Lee, San Francisco, to draft plans for construction of the new Harbor Slope low rent housing project for San Francisco.

Site of the project, which will comprise some 226 units, is the Hunters Point district. Estimated cost is \$2,250,000.

## STOCKTON PLANS NEW LIBRARY

The City of Stockton has commissioned architect Peter L. Sala of Stockton, to design a new Library Building to be built on Oak street.

The new building will contain 80,000 sq. ft., will be of reinforced concrete construction, and will cost an estimated \$1,465,000.

## NEW JR. HIGH FOR FRESNO

The Fresno Board of Education completed plans recently for construction of a new Fort Miller Junior High School in Fresno.

Costing approximately \$1,300,000 the new school will include 12-classrooms, administration, music, art, science, floor and clothing rooms, wood and metal shops, and gymnasium and toilet rooms.

Franklin & Simpson of Fresno are the architects.

## SAN MATEO BUILDER ELECTED PRESIDENT

Alvin M. Smith of San Mateo has been elected president of the Home Builders Association of San Mateo, succeeding A. F. Calkins. Smith is making an announcement at the next meeting of the Council, which will be held Monday, Fred F. Winters, president, Frank Calkins, secretary, treasurer, and Alvin M. Smith, clerk and executive committee members. The Council is a governing agency for statewide problems of the Associated Home Builders of San Francisco, Associated Home Builders of Sacramento, General Contractors and Builders Association of Contra Costa County, Peninsula General Contractors and Builders Association, Marin Builders Association, Home Builders Institute of Los Angeles, and the Associated Home Builders of the Greater East Bay.

dining agency for statewide problems of the Associated Home Builders of San Francisco, Associated Home Builders of Sacramento, General Contractors and Builders Association of Contra Costa County, Peninsula General Contractors and Builders Association, Marin Builders Association, Home Builders Institute of Los Angeles, and the Associated Home Builders of the Greater East Bay.

## ARCHITECT SELECTED

Russell G. De Lappe of Berkeley has been selected as the architect for two new elementary school to be built in Woodland for the Woodland Elementary School District.

Cost of the project will approximate \$246,000.

## REHABILITATION OF CAMP BEALE

The Corps of Engineers, U. S. Army, Sacramento office, recently announced a plan for rehabilitation of sixty three buildings and fifteen warehouses at the Beale Air Force Base near Marysville.

Included in the project is laying of new water and sewer lines, and bituminous surfacing of walks. Estimated cost of work is \$451,188.

## SCHOOL BONDS APPROVED

Electors of the Washington Union High School District of Centerville, Alameda county, recently approved a special school bond election of \$1,500,000 with funds to be used for the construction of an addition to the Washington Union High School in Centerville.

## PLASTERING INDUSTRY ANNUAL CONVENTION

The 27th Annual Convention of the California Lathing and Plastering Industry will be held in the Palace Hotel in San Francisco, February 19-21.

The conference is sponsored by the California Lathing & Plastering Contractors Association and according to Arthur T. Raitt, managing director, a full three day program of business sessions and entertainment are being provided.

## ARCHITECT FOR HIGH SCHOOL

Architects Birge M. Clark and Walter Stromquist of Palo Alto, have received a commission from the Board of Trustees of the Mt. View Union High School District in Los Altos, Santa Clara county, to design a new High School building for Los Altos. The structure of frame and stucco, will cost an estimated \$1,000,000.

## ELECTED PRESIDENT SACRAMENTO BUILDERS

Richard Ronne, home builder of Sacramento and northern California, has been elected president of the Associated Home Builders of Sacramento for the year 1953.

The organization comprises membership of over 200 general contractors, contractors and builders of the industry.

Ronne, builder of homes in Sacramento, Grass Valley, Marysville, Colusa and Santa Cruz is a national director of the National Association of Home Builders.

## STANLEY WORKS NAMES SALES REPRESENTATIVE

George F. Martin, sales manager of The Stanley Works, recently announced the appointment of R. L. A. Smith as sales representative for the Berkeley division in



## CLASSIFIED ADVERTISING

Will Bring Results

—USE—

## ARCHITECT and ENGINEER

68 Post St. San Francisco

## MULLEN MFG. COMPANY

BANK, STORE AND OFFICE  
FIXTURES—CABINET WORK  
OF GUARANTEED QUALITY  
CHURCH SEATING

Office and Factory

60-80 RAUSCH ST., Bet. 7th and 8th Sts.  
San Francisco

Telephone UNderhill 1-5815

## STATIONERY SCHOOL & OFFICE SUPPLIES

Printing Engraving  
Announcements

## CENTER STATIONERY

468 McAllister

San Francisco UN 1-3703

*Fine*  
**ENGRAVINGS**



**POOR  
RICHARD**

PHOTO ENGRAVING CO.

320-324 COMMERCIAL STREET  
SAN FRANCISCO, CALIF.

Washington, D.C., Delaware and Maryland. Jones will cover the territory previously handled by Carl S. Bauman who was appointed to the position of assistant general sales manager of The Stanley Works in July 1952.

### ARCHITECT SELECTED

Architect L. F. Richards of Santa Clara, has been selected by the Santa Clara Elementary School District to draft plans and specifications for the construction of a new Intermediate School in Santa Clara at an estimated cost of \$400,000.

Richards is also designing two new fire-house buildings for the City of Santa Clara.

### NEW MANAGER FOR MARIN BUILDERS

Carl Brown, assistant to the executive president of the Associated Home Builders of Northern California, has been appointed secretary-manager of the Marin Builders Association of San Rafael.

Brown has been closely identified with the construction industry since his graduation from College of the Pacific, and for many years was the head of his own firm.

### LANDSCAPE COURSE FOR GARDENERS

Two new courses in landscape gardening are being offered in the spring semester on the Davis campus of U.C., according to Robert B. Deering, chairman of the department of landscape gardening.

Principles and practices in the use of decorative plant materials will be taught, including plant materials for interiors, and plant materials in garden design.

### ARCHITECT SELECTED

The Board of Supervisors of Yuba county recently selected architect Russell G. DeLappe of Berkeley, to draft plans and specifications for the construction of a new Detention Home.

The new building will be built in Marysville, with work to start in the immediate future.

### WORK STARTS ON RESEARCH UNIT

Construction on the \$826,000 Cancer Research Unit, which will be a 4-story wing on the \$20,000,000 Medical Center on the Los Angeles campus of the University of California, was started recently with completion of the unit scheduled for January of 1954.

Architect for the 20,000 sq. ft. addition is Welton Becket & Associates of Los Angeles.

### NAMED TECHNICAL STAFF DIRECTOR

Raymond A. Stoesser has been named Director of the newly formed Technical Staff of American Radiator & Standard Sanitary Corp., according to an announcement by Theodore E. Mueller, president.

Stoesser has been serving as general supervisor of factories for American Standard affiliates in Europe, and has been associated with the firm since 1924 in a variety of manufacturing positions.

### ARCHITECT SELECTED

Architect Henry H. Gutterson of San Francisco, has been commissioned by the First Church of Christ Scientist of Santa Rosa (Calif.) to design plans and specifications for a new Church to be built in Santa Rosa.

## DINWIDDIE CONSTRUCTION COMPANY

## BUILDERS

CROCKER BUILDING  
SAN FRANCISCO



## HERRICK IRON WORKS STRUCTURAL STEEL REINFORCING STEEL

18TH AND CAMPBELL STS.  
OAKLAND, CALIF.  
Phone GLencourt 1-1767

Phone GARfield 1-1164

## Thomas B. Hunter DESIGNER OF HEATING

AIR CONDITIONING  
VENTILATING AND WIRING  
SYSTEMS, MECHANICAL  
AND ELECTRICAL EQUIP-  
MENT OF BUILDINGS



41 SUTTER STREET  
ROOM 710

San Francisco California

Subscribe  
Now —

## ARCHITECT and ENGINEER

\$3.00  
Per Year

# ARCHITECT and ENGINEER

Please enter my subscription for  
..... year.... My check in the  
amount of \$..... is attached.  
1 year . . . . \$3.00  
2 years . . . . 5.00

Name.....  
City.....  
State.....

## ABBOT A. HANKS, INC. Engineers & Chemists

INSPECTING — TESTING — CONSULTING  
CONCRETE • STEEL • MATERIALS  
CHEMICAL AND TESTING  
LABORATORIES  
• RESEARCH AND INVESTIGATION •  
TESTS OF STRUCTURAL MATERIALS  
DESIGN OF CONCRETE MIXES  
SHOP AND ERECTION INSPECTION OF  
STRUCTURES AND EQUIPMENT  
INVESTIGATION OF STRUCTURES  
AND MATERIALS  
TESTS AND INVESTIGATION OF  
FOUNDATION SOILS  
FIRE RESISTANCE AND INSULATION  
TESTS

624 Sacramento Street, San Francisco

## PITTSBURGH TESTING LABORATORY

ENGINEERS AND CHEMISTS

Testing and Inspection of Concrete,  
Steel and Other Structural Materials

Design of Concrete Mixes

Offices in all principal cities

651 Howard St., San Francisco 5  
EXbrook 2-1747

## MATTOCK CONSTRUCTION COMPANY



**BUILDERS**



604 MISSION STREET  
SAN FRANCISCO

## Index to Advertisers

ALLIANCE Engineers .....	38
AMERICAN Perlite Corp.....	46
ANGIER Pacific Corp.....	35
ARCHITECTS Reports .....	38
BARRETT & HILP, Contractors.....	35
BY-CHEMICAL Products Co.....	31
CAMBRIDGE Tile Mfg. Company .....	*
CENTER Stationery .....	47
CLAY Brick & Tile Association.....	5
CLASSIFIED Advertising .....	43
CLINTON Construction Company.....	36
CROCKER First National Bank.....	34
DINWIDDIE Construction Company....	47
FORORDERER Cornice Works.....	35
GLADDING, McBean & Company.....	2
GREENBERG'S, M. Sons.....	*
HANKS, Abbot A., Inc.....	48
HAW'S Drinking Faucet Co.....	28 & 29
HERRICK Iron Works.....	47
HOGAN Lumber Co.....	36
HUNT, Robert W., Company.....	48
HUNTER, Thos. B.....	47
IDEAL Cement Co.....	Back Cover
JOHNSON, S. T. Co.....	*
JUDSON, Pacific-Murphy Corp.....	36
KRAFTILE Company .....	26
MARBLE Institute of America.....	2
MATTOCK Construction Co.....	48
MICHEL & Pfeffer Iron Works, Inc.....	1
MODERN Building Specialties Co.....	45
MULLEN Mfg. Co.....	47
OLSON, Leroy Co.....	44
PACIFIC Coast Aggregates.....	27
PACIFIC Manufacturing Co.....	37
PACIFIC Telephone & Telegraph Co.	45
PARKER, Steffens & Pearce.....	35
PITTSBURGH Testing Laboratory.....	48
POOR Richard Engraving Co.....	47
PORCELAIN Enamel (Architectural Division) Publicity Bureau.....	Inside Back Cover
REMILLARD-Dandini Co. ....	48
REPUBLIC Steel Corporation.....	37
SCOTT Company .....	48
SIMONDS Machinery Company .....	37
SISALKRAFT Company .....	36
SMOOT-Holman Company .....	33
SOTO, Henry C., Corp., Landscape Engineers .....	33
STANLEY Works, The .....	32
SUMMERBELL Roof Structures .....	32
U. Binds .....	2
UTILITY Appliances Corp'n.....	*
VERMONT Marble Company .....	37
WELBY E. and Heater Co. ....	*
WEST COAST Green Co. ....	43

\*Indicates Alternate Months

## ROBERT W. HUNT CO.

ENGINEERS  
INSPECTING TESTING

STRUCTURAL MATERIALS  
CONCRETE MIX DESIGN  
CHEMICAL ANALYSIS  
EQUIPMENT

PRINCIPAL CITIES  
UNITED STATES • EUROPE  
SAN FRANCISCO LOS ANGELES  
PORTLAND SEATTLE

## REMILLARD-DANDINI Co.

Brick and  
Masonry Products



400 MONTGOMERY STREET  
SAN FRANCISCO, CALIF.

## Scott Company

HEATING • PLUMBING  
REFRIGERATION



San Francisco  
Oakland  
San Jose  
Los Angeles

FOR ADVANCE  
INFORMATION  
ON  
BUILDERS  
CONTRACTORS  
ENGINEERS

Get  
ARCHITECTS  
REPORTS  
68 Post St. Phone  
San Francisco DO 2-8311

# ARCHITECT AND ENGINEER

SAN MATEO COUNTY SANATORIUM — West Elevation



STONE & MULLOY, ARCHITECTS — and S. P. Marraccini, Architect

FEBRUARY

1953





Time



Tested

**SMOOT-HOLMAN COMPANY**

Through the years SMOOT-HOLMAN has continued its progress in better standards of quality and service, ever mindful of the user's benefit. Your lighting standards may be kept in step with production and merchandising trends through the use of SMOOT-HOLMAN lighting. For service and economy ask your Architect and Engineer to specify and your Electrical Contractor to install our quality luminaires.



**SMOOT-HOLMAN**  
EST. 1914  
A DIVISION OF

INGLEWOOD CALIFORNIA

BRANCH OFFICE AND WAREHOUSE  
SAN FRANCISCO





# ARCHITECT

Vol. 192 No. 2

# AND ENGINEER

ARCHITECTS' REPORTS—Published Daily

## Contents for

# FEBRUARY

EDITORIAL NOTES . . . . .	6
NEWS & COMMENT ON ART . . . . .	8
PIONEERS MEMORIAL HOSPITAL—On the Mohave Desert, Brawley, Calif. Architects: Walker, Kalionzes and Klingerman . . . . .	10
NEW VETERANS' HOSPITALS . . . . . By Dr. W. Schweisheimer . . . . .	12
SAN MATEO COUNTY SANATORIUM, Redwood City, California . . . . . Architects: Stone & Mulloy, and S. P. Marraccini, Architect; General Contractor: Howard J. White, Inc. . . . .	14
SOUTHERN CALIFORNIA GAS COMPANY—New Operating Bases . . . . . Architects: Allison and Ribla . . . . .	22
HOSPITAL ROOM TEMPERATURE AN AID TO RECOVERY . . . . . By Dr. Darrell Boyd Harmon, Austin, Texas . . . . .	26
BANK OF AMERICA BRANCH, Sacramento, California . . . . . Architect: L. J. Hendy, A.I.A.; General Contractor: Capital Company . . . . .	28
A. I. A. ACTIVITIES . . . . .	30
WITH THE ENGINEERS . . . . .	32
PRODUCERS COUNCIL PAGE . . . . . Edited by Phil Brown, Otis Elevator Company . . . . .	34
BOOK REVIEWS, Pamphlets and Catalogues . . . . .	40
ESTIMATOR'S GUIDE, Building and Construction Materials . . . . .	43
ESTIMATOR'S DIRECTORY, Building and Construction Materials . . . . .	45
BUILDING TRADES WAGE SCALES, Northern, Central & Southern California . . . . .	46
CLASSIFIED ADVERTISING . . . . .	47
CONSTRUCTION CONTRACTS AWARDED and Miscellaneous Data . . . . .	48
IN THE NEWS . . . . .	50
INDEX TO ADVERTISERS . . . . .	52

**EDWIN H. WILDER**  
Editor

**J. WELLS HASTINGS**  
Contributing Editor

**PROF. LELAND VAUGHAN**  
Landscape Architecture

**JOHN A. BLUME**  
Structural Engineering

**MICHAEL GOODMAN**  
Planning

**JOHN S. BOLLES, A.I.A.**  
Book Reviews



### COVER PICTURE:

**SAN MATEO COUNTY  
SANATORIUM**  
California

**STONE & MULLOY, ARCHITECTS**  
and S. P. Marraccini, Architect

Structure was designed primarily for treatment of tuberculosis, with conversion to general hospital if desired later.

Comprises four floors and pent house. Reinforced concrete construction. See page 14 for complete details.

Photos by  
**JOHN BLACK and Associates**

*ARCHITECT & ENGINEER*  
is indexed regularly by  
*ENGINEERING INDEX, INC.*

ARCHITECT AND ENGINEER (Established 1905) is published on the 15th of the month by The Architect and Engineer, Inc., 68 Post St., San Francisco 4; Telephone EXbrook 2-7182. President, K. P. Kierulff; Vice-President and Manager, L. B. Penhorwood; Treasurer, E. N. Kierulff.

Los Angeles Office: Wentworth F. Green, 439 So. Western Ave., Los Angeles 5; Telephone DUnkirk 7-8135.

Entered as second class matter, November 2, 1905, at the Post Office in San Francisco, California, under the Act of March 3, 1879. Subscriptions United States and Pan America, \$3.00 a year; \$5.00 two years; foreign countries \$5.00 a year; single copy 50c. ARCHITECTS' REPORTS are published daily from this office, Vernon S. Yallop, Manager. Telephone DOuglas 2-9311.



# EDITORIAL NOTES

## NOW TO CUT TAXES

There is a lot in the air about federal tax reduction these days. Needless to say, everybody—or nearly everybody—is much in favor of something definite being done to lessen the "tax take".

Still, major tax reductions will depend on major reductions in spending, and that will take a lot of doing by everybody, not just the federal administration.

Communities, groups, and individuals will have to break the habit of running to the federal treasury whenever they want some kind of a new project. And it is interesting, and encouraging, to note that some never did get out of the truly American habit of paying their own way as they went along, rather than seeking federal assistance.

Cutting federal taxes by reducing federal spending is not going to be easily accomplished, and remember YOU are the one that will bring such a situation about, if it is done.

\* \* \*

*"The Chapters are the grass roots of The Institute, offering the best possible opportunities for recruitment, counseling, and public relations":—Dr. Edwin S. Burdell.*

\* \* \*

## MEASURING PROGRESS

All of us like from time to time to look back over the years and see whether or not we as individuals are making progress. As citizens, we are all interested too in whether or not the country as a whole is making progress toward improved living conditions.

We are all interested in finding out whether, if we are progressing as individuals or as a nation, we might not increase our rate of progress. Particularly, we all want to know whether our feet are firmly planted on the highroad to a better future or whether we are merely running faster and faster on a treadmill in order to stay in the same place.

Last year the American economy turned out goods and services with a gross national product value of somewhere near \$340-billion. In 1939 the gross national product value was \$91-billion.

At first glance, one might conclude that with an increase of three and three quarters in gross national product value during the past twelve or thirteen years the American people are three and three-quarters times more prosperous now. But the facts are quite different for three reasons: 1) since 1939, the government plays as a consumer of goods and services, has vastly expanded; 2) we have had a great inflation of prices; 3) the population has increased rapidly.

The vast expansion in the share of government

take of goods and services, at current prices, is about 5.7 times, and much of the great rise during recent years has not represented increased living standards because of rising prices. Although gross national product value is the figure most widely used, it is not a very good measure of changes in human well-being, for it includes government purchases as well as private consumer purchases. Most government spending today is in military items which do not directly improve consumers' living standards. People can not eat jet planes nor dress in parachutes.

A better measure of economic well being is total "personal consumption expenditures". This figure reflects the durable and nondurable goods and services upon which consumers actually spend the bulk of their incomes. Since rising living standards are measured in terms of goods and services, account must be taken of the fact that the dollar is worth less than pre-war and that the population has increased over twenty-five million people.

Thus in spite of the tremendous and unprecedented scientific and technical advances of the past few years individual economic well-being has not progressed as it should and is, as a matter of fact, only half that of earlier years.

\* \* \*

*Bridal bouquets, corsages and other floral displays utilize about 8,000 tons of florist wire annually, according to an estimate by one wire manufacturer to the American Iron & Steel Institute.*

\* \* \*

## MODERNIZATION ON A PLAN

Getting the advice of a good architect has become a generally accepted procedure for the average American who builds a new home.

Years later when the house needs some remodeling, the same home owner may be inclined to proceed without a proper plan in his modernization program. He does not seem to realize that to get the most for his modernization dollar in value and comfort, as in the initial construction, he should proceed according to an established plan.

Modernization may call for a picture window, new siding, additional floor space, altering partitions, another full or partial floor or a new roof, side-wall insulation, and a host of other possibilities.

There are so many important factors that enter into the consideration of any modernization plan that the safest policy to follow to secure the desired results is to consult with an architect—it is the most satisfactory, and the most economical.

# Porcelain

## ENAMEL VENEER

FLOOD BUILDING - Powell and Market Street, San Francisco  
where the picturesque Powell Street Cable Car  
is reversed for its return journey  
up famed Nab Hill

Architect:  
F. W. Woolworth Co.  
Construction Department  
Contractor:  
Swinerton & Walberg Co.



**THE PROBLEM:** To create, in modern, functional simplicity, a new look on large external areas of a building originally keyed to the ornate moods of 1907.

**THE SPECIFICATION:** PORCELAIN ENAMEL VENEER for paneling, canopy fascia and identification.

**THE LOGIC:** This medium offers complete design freedom and an almost infinite array of timeless, locked-in colors. When you create in PORCELAIN ENAMEL VENEER, your intent will be expressed with unfading exactness for generations.



- **WRITE TODAY** for detailed information—and specify Porcelain Enamel Veneer, inside and out

*Architectural Division*

PORCELAIN ENAMEL PUBLICITY BUREAU  
P. O. BOX 186, EAST PASADENA STATION, PASADENA 8, CALIFORNIA  
ROOM 601, FRANKLIN BUILDING, OAKLAND 12, CALIFORNIA



# NEWS and COMMENT ON ART



## M. H. deYOUNG MEMORIAL MUSEUM

The M. H. deYoung Memorial Museum, Golden Gate Park, San Francisco, under the direction of Walter Heil, announces the following schedule of exhibits and special events for the month of February:

**EXHIBITIONS**—Valentines of Past Times, from the Collection of Eugene E. Thurston; Paintings by Joseph Floch; Four American Painters—William Brice, Robert Chuey, Channing Peake and Howard Warshaw; American Institute of Architects 1953 Honor Awards showing the outstanding works of Bay Area architects since 1933; and Angkor, a group of Photographs by Ernest G. Rathenau.

**SPECIAL EVENTS** will include Painting for Pleasure and Exercises in Perception for adults each Saturday morning. Painting Workshop each Thursday and Saturday afternoons. The Classes for Children are held Thursday and Friday afternoons, and on Saturday mornings.

## PRESENTING LECTURE SERIES ON IDEAS BEHIND CONTEMPORARY ART

Ernest Mundt, director of the California School of Fine Arts, San Francisco, is presenting a series of weekly lectures on the subject "Ideas Behind Contemporary Art."

The lectures are offered under auspices of the Women's Auxiliary of the San Francisco Art As-



See  
Opposite  
Page  
for  
Details

sociation, and covers the entire realm of fine arts in Western Europe and America from the Classic Revival in 1890 to the present day.

#### CITY OF PARIS

The Rotunda Gallery of the City of Paris, San Francisco, under the direction of Beatrice Judd Ryan, is presenting an Exhibition of Paintings with Clay by Joy Cain; a number of Oils by Amy Flemming and a group of Watercolors by Richard Stephens during February.

The special display of Pictures For The Month will feature a group of Oils and Watercolors by Wayne Thiebaud.

#### SAN FRANCISCO MUSEUM OF ART

The San Francisco Museum of Art, War Memorial Building, Civic Center, is offering the following special exhibitions and events during February:

EXHIBITIONS: The 72nd Annual Painting and Sculpture Exhibition of the San Francisco Art Association; Marsden Hartley Retrospective Exhibition; Photographs by Berenice Abbott; Tools for Gardening; How To Read A Photograph; and Selections for the Museum Collections.

The exhibition at the Parkmerced Branch will comprise a special group selected from the Rental Gallery.

SPECIAL EVENTS include Lecture Tours each Sunday at 3 p.m.; Discussions on Art each Wednesday evening at 8 o'clock; Workshop Classes Thursday mornings, 10 to noon; and Classes in Art for the Layman on Tuesday at 10 a.m., Friday evenings at 7:30, and Saturday mornings.

The Art In Your Life series, being presented over

TV every other Sunday at 11 a.m., will feature "What Makes a Good Garden" on Feb. 8th, and "What Makes a Good Room?" on Feb. 22nd.

#### SAN FRANCISCO ART ASSOCIATION ELECTS OFFICERS FOR NEW YEAR

Francis V. Keesling, Jr., was re-elected president of the San Francisco Art Association at the recent annual meeting of the organization.

Other officers elected included F. Paschal Gallo, George D. Hart, Mrs. Clarence Lindner, Charles Kendrick, and F. M. McAuliffe. David Park, Bay area painter, was an Artist Representative on the Board as was Nell Sinton.

#### LES FAUVES EXHIBITION PLANNED FOR SPRING

Brayton Wilbur, president of the San Francisco Museum of Art, announced recently plans had been completed for the Museum's major exhibition of the spring season—"Les Fauves." The exhibition will be open to the public beginning March 13.

The term Les fauves is credited to a French critic, who at the famous Autumn Salon of 1905 in Paris, remarked on the startling work of a group of mostly unknown and young painters surrounding a classic type piece of sculpture: "Donatello au milieu des fauves!" The expression was so apt that it is used now as an identification of the pictures.

#### ANNUAL PAINTING AND SCULPTURE PRIZE WINNERS ARE ANNOUNCED

The 72nd Annual Painting and Sculpture Exhibition of the San Francisco Art Association, being

(See Page 42)

---

## M. H. de YOUNG MEMORIAL MUSEUM

Golden Gate Park — San Francisco

### "VALENTINES OF THE PAST"

About 1850

(From the Thurston Collection)

Several hundred English and American valentines, dating from 1807 to the 1890's, including hand made, and epitomizing the sentiments of the period, are being exhibited during February.



ENTRANCE DRIVEWAY to the new Pioneers Memorial Hospital

# PIONEERS MEMORIAL HOSPITAL

ON THE MOJAVE DESERT

BRAWLEY, CALIFORNIA

ARCHITECTS: WALKER,  
KALIONZES and  
KLINGERMANN

COST \$15,000 PER BED



A completely airtight, air-conditioned hospital . . . this was the order that Walker, Kalionzes and Klingerman of Los Angeles received to build the Pioneers Memorial Hospital on the Mojave Desert three miles south of Brawley in Imperial County. The building was constructed at a maximum cost of \$15,000 per bed.

Although prices in Imperial valley was approximately 20% higher than elsewhere, the two-story 88-bed hospital was built at a lower per-bed cost than the average hospital today. Not long after its completion, it won the Modern Hospital of the Month award given by the Modern Hospital Publishing Company.

Windows were a problem in architectural skill as the building had to be completely air tight and air conditioned. Wind storms blew fine sand at the rate of 45 miles per hour into every crack and crevice. The land on which the Pioneers Memorial Hospital was constructed originally had been used for agricultural purposes and loose soil conditions prevailed on the site. With a temperature range from 21 degrees in the winter to 121 degrees in the summer and a humidity of 80 or 90, it was essential that all rooms be sealed and that no residual deposits of silt from the Old Salton Sea be permitted to blow in.

To accomplish this aluminum horizontal sliding windows were used, which incorporate a stainless steel weatherstrip spring, set in continuous strips



**Lounge of the nurses' quarters, adjacent to hospital has view of outdoor patio, and gives impression of being out-of-doors.**

around the entire perimeter of the sash. Once the windows were installed the glass was protected by hung louvers so that no solar heat or sky glare could invade the room.

By minimizing the untoward climatic conditions the windows made the desert hospital as comfortable and safe as one in the very heart of a metropolis. Adjacent is a nurses' home with accommodations for 28 people.

#### **EXTERIOR:**

**Specially designed windows were used to seal in air conditioning, give visual access to outdoors, and prevent dust of nearby Salton Sea from drifting in during strong gusts of wind.**

*Photos by  
Lowenthal*





VETERANS ADMINISTRATION HOSPITAL — Omaha, Nebraska

# NEW VETERANS HOSPITALS

By DR. W. SCHWEISHEIMER

The modern veterans hospitals which have been built in the United States during the last few years, or which are being built, present the most interesting as well as varied architectural aspects. They have not been planned according to a single scheme and consequently are as multi-form as the American country is.

Veterans Administration currently is operating

150 hospitals and more are under construction. The total bed capacity of the 150 hospitals in operation was almost 116,000 beds. Though the hospitals are architecturally different, they have, of course, facilities and departments which are the same in all hospitals.

A typical modern veterans hospital is the new \$10,000,000 Veterans Administration Hospital in

Shreveport, Louisiana. The 10-story main hospital building towers 150 feet into the air. Clustered around it are a heating plant, nurses' home, attendants building, two duplex apartments and a single residence for staff quarters.

The hospital employs 550 people. The medical staff includes 30 full-time doctors and 95 nurses. Part-time medical and consultant services are provided by leading doctors and specialists from the Shreveport area. The hospital has a capacity of 450 beds. Private rooms are available for seriously-ill veterans. Wards for the less seriously ill range from 2 to 16 beds.

One interesting innovation is a system of vacuum pipes with outlets at every bed so that much medical equipment which formerly was hand-operated may be plugged into the vacuum sockets for automatic functioning. Beds, generally, are grouped as follows: 262 beds for general medical patients; 36 beds for surgical cases; 72 beds for neurosis patients; 72 beds for psychiatric patients; 10 beds for isolation.

One wing in the main building is occupied by V-A out-patient clinics. These clinics give more than 120,000 examinations and treatments a year for veterans whose ailments do not require hospitalization. The surgical wing on the third floor is the only air-conditioned section of the hospital. Eight large operating rooms are lined with specially-treated glass and insulated floor to prevent operating room explosions. Two smaller operating rooms are located in the out-patient clinic.



**VETERANS HOSPITAL — Clarksburg, West Virginia**

Medical conference and lecture rooms are included in the main building.

A great volume of medical charts and records is constantly shuttling back and forth between files, clinics, conference rooms and wards in a modern hospital. To handle this traffic rapidly and efficiently, V-A has installed a system of pneumatic tubes in the Shreveport hospital. Thirty-one stations throughout the hospital are connected by tubes with a central record room. A doctor's request for records on a patient can be answered almost instantly.

Three teletype machines are connected to a national network so that the Shreveport Hospital can communicate instantly with headquarters in Washington, area medical officers in St. Louis, the Dis-

(See Page 42)

**VETERANS ADMINISTRATION HOSPITAL — Shreveport, Louisiana**







SOUTHEAST ELEVATION SHOWING MAIN ENTRANCE

SAN MATEO COUNTY  
SANATORIUM

REDWOOD CITY, CALIFORNIA

ARCHITECTS: STONE & MOLLOY  
and S. P. Marraccini

GENERAL CONTRACTOR: HOWARD J. WHITE, Inc.

# . . . SANATORIUM — San Mateo

The San Mateo County Sanatorium is located off Edgewood Road outside the limits of Redwood City. Construction started in the spring of 1950 and was completed in the spring of 1952.

Structure is reinforced concrete, including ground, first, second and third floors and pent-house structures.

The building was designed primarily for the treatment of tuberculosis patients, though thought was given to the possibility that this disease may at some time be greatly reduced or entirely eliminated. The plan has, therefore, been developed to allow for simple conversion to more general hospital needs.

The ground floor is devoted primarily to service facilities. Boiler Room, Maintenance Shop, Mechanical and Electrical Equipment Rooms, Locker Rooms and Toilets for employees, Laundry Collection and Laundry Sterilization, Storage Areas and Housekeeping Supplies comprise the large part of this floor. A Morgue and Autopsy Room is also at this level with a separate entrance screened from view of the rest of the Hospital.

The main hospital entrance is at the first floor level. A separate one story wing provides public waiting space, toilets for the public, manager's and business office space. Extending in a southerly direction from the core of the building is the

## PLOT PLAN . . .

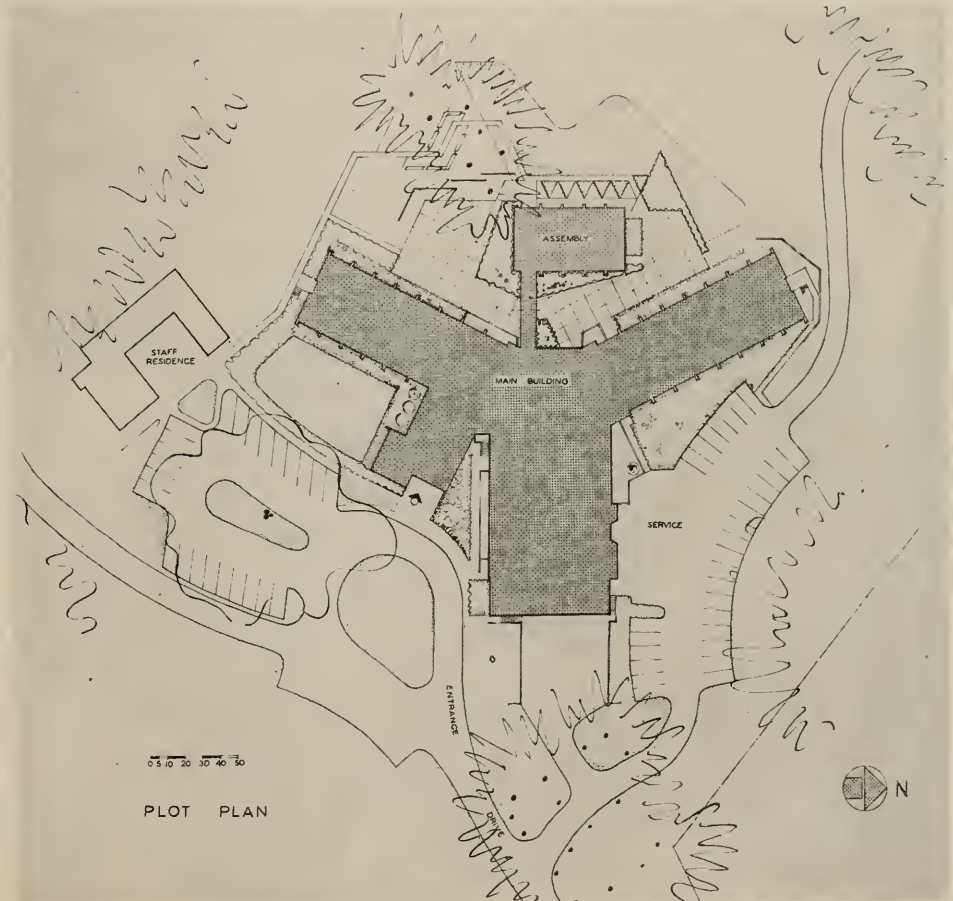

# SANATORIUM — San Mateo . . .



**GROUND  
FLOOR  
PLAN**

Administrative section. Here are located the various offices for the staff, with the Doctors' entrance at the end of the wing leading to the existing Residence Building. Contained in this wing are also the admitting Examining Rooms, Viewing Room, Laboratory and Pharmacy.

The corresponding wing on this floor contains occupational and physical therapy suites, classrooms and libraries—all important in the modern treatment and rehabilitation of patients suffering from this particular disease. Nurses' lockers and resident rooms are also contained in this wing.



**GENERAL  
VIEW**

**From east showing  
the main entrance  
(lower left) and  
central elevator  
tower in center  
of building.**



FIRST FLOOR PLAN

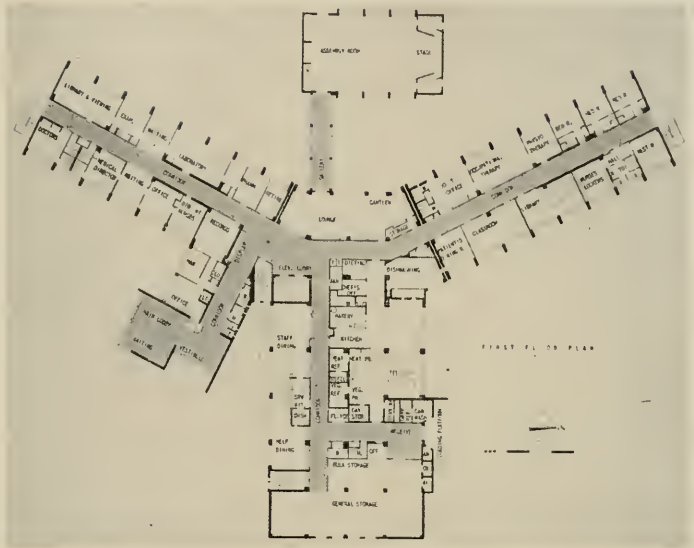

The core of the building at this floor leads to the staff and help dining rooms, the central kitchens and ancillary service and storage elements.

From the central lounge on this floor, a gallery leads to a separate assembly room building, used for religious services, meetings, entertainments,

social functions, etc. Simple stage productions are possible as well as projection of films.

The basic theory of centralized services and complete visual control of nursing areas is seen in the second floor plan. All service areas necessary for patient care are concentrated around the

NURSES STATION AT CENTRAL CORE









## SANATORIUM — San Mateo . . .

central nurses station. The nurse on duty at this station has a clear view of all bedroom doors, the day room, and elevator and stair entrances. Charting and medicine preparation rooms are directly off this station.

Serving pantries nearby receive prepared trays from the kitchen below by means of automatic tray lifts and are delivered to the patients within a minute or two after leaving the make-up tray belt in the kitchen. The second floor nursing units being devoted to female patients, a beauty shop is provided for visiting specialists. The floor above has similar barber shop facilities for male patients.

Identical nursing units of twenty-five beds each extend in both directions from the central nurses station. Rooms are somewhat larger than normal in consideration of length of stay, space for visitors, and accommodations for patients' personal property. Specially designed bed side tables provide adequate space within easy reach for a variety of personal possessions. All rooms will accommodate two patients.

A patients' call system is provided for direct conversation between patient and nurse on duty,

greatly reducing the work of the nurse and providing reassurance for the patient. A four channel central radio system is available to each patient as well as controls to connect to central phonograph recordings or assembly room entertainment.

Each nursing wing contains its own Utility Rooms, Bath and Shower Rooms and Sputum Rooms.

Each patient bedroom contains stainless steel recessed lavatories and built in individual wardrobes. Between each pair of rooms, toilets are provided and dental basins.

The stem wing on the second floor contains all the medical facilities and surgical suite. Medical facilities are grouped on one side of double corridor plan, surgical on the other, with commonly used X-ray and Fluoroscopic Facilities between. In the surgical section are found a Recovery Room, Sterile and Unsterile Storage, Central Sterile and Operating Room Suite. This surgical area is expandable to provide enlarged facilities in the event of the conversion of the hospital to more general hospital use.

The medical side of this wing contains pneumo-

**ASSEMBLY ROOM . . . viewed towards the projection booth  
with chair storage behind doors at rear.**



## . . . SANATORIUM — San Mateo

thorax room, eye, ear, nose, throat and dental treatment rooms. The patients' waiting room here serves both these medical facilities and the X-ray Department in the center of the wing.

The third floor duplicates many of the nursing features of the second floor, with the addition of four wards of four beds each with common bath and toilet facilities and separate day room. This section of the hospital is adaptable to future expansion by taking in the present walking deck and continuing out over the future surgical department expansion at the second floor level.

At roof level, more walking decks are provided as well as pantry facilities served by dumbwaiter from the main kitchen.

Equipment of the hospital throughout has been planned for the most efficient possible use of personnel. In addition to the aforementioned delivery of trays to upper floor serving pantries, down travel tray lifts are provided for delivering pre-rinsed soiled dishes to the central dish washing room on the first floor. There, conveyor belts carry trays to sorting area and automatic dishwashing, glass washing and sterilization machines. Dumb-

waiter service is provided to all floor pantries as well as the tray lifts. Soiled linen chutes and rubbish chutes discharge to collection centers at Ground Floor. The grouping of all services at the central core reduce personnel traffic to a minimum.

Materials throughout have been selected for minimum maintenance and long life. Window sills and stools are heavy gauge alumilited aluminum. All toilet rooms, utility rooms, sputum rooms, gown rooms and surgery areas have glazed ceramic tile walls or wainscots and terrazzo floors. (The Surgery areas have conductive terrazzo floors to provide safe conditions for the use of certain explosive types of anaesthetic gases.) All external wall angles in traffic areas have large radius extruded aluminum corner beads to protect them from damage from wheeled traffic. Kitchen, pantry and dishwashing areas have walls of glazed structural clay tile and floors of quarry tile. Floors throughout the rest of the building are of resilient tile. Ceilings throughout most of the building are mineral acoustical tile, with cement asbestos type perforated acoustical panels in wet and service areas.

(See Page 38)

### MAIN LOBBY AND WAITING ROOM . . .





PHOTOS by FRED R. D'APPRICH

VAN NUYS BASE

NEW OPERATING BASES OF THE  
SOUTHERN CALIFORNIA GAS CO.

ARCHITECTS: ALLISON and RIBLE

ARCHITECT AND ENGINEER



GENERAL VIEW  
OF THE  
HAWTHORNE AVE.  
BASE AT  
REDONDO BEACH



The three projects for a public utility company, described and pictured here are interesting examples of the fulfillment of a rigid building program for each project established by the client. The programs required within the limits of a fixed appropriation, simple, straightforward buildings

without ornamentation, maximum usable area and economy of construction, operation and maintenance. The client was keenly aware of the advantages of employing an experienced architect to attain the best results possible under such programs.

ANOTHER VIEW OF THE VAN NUYS BASE





**EXTERIOR  
ALHAMBRA  
BASE**

Showing detail  
of brick wall  
surrounding  
new plant.

**BELOW**

View of utility  
yard and service  
area.



**LOCKER  
ROOM**

is equipped with complete and modern facilities including individual steel lockers, showers, and toilets for employees.





## SOUTHERN CALIFORNIA GAS CO. . . .

These three projects, operating bases for the field forces of the Southern California Gas Company, were designed by Allison and Rible, Architects, of Los Angeles. The Van Nuys base serves the western area of Los Angeles County; the Alhambra base serves the eastern area; the Hawthorne Avenue base in Redondo Beach, which is now under construction, will serve the southern area.

Each base supplies all the routine needs of the field forces and contains office areas, conference room, shower and locked spaces, storerooms, garage and auto repair shops, gasoline and oil tanks and pumps, truck sheds and outside equipment storage facilities. The sites, completely fenced and paved, also provide adequate parking areas for employees and equipment.

The Van Nuys base has exterior walls of reinforced concrete blocks. The other two bases have walls of reinforced modular size brick. The architectural treatment provides a harmonizing link between the three bases.

Generous roof overhangs and exterior sun louvers furnish effective protection from sun heat and glare at the Van Nuys base where temperatures are normally higher.

Framing is of structural steel and wood combined. Roofing is composition and gravel and flashings are of galvanized sheet metal. Windows are of projected type steel with screens and venetian blinds.

Office partitions are movable wood partitions glazed with patterned glass. Masonry of exterior walls is exposed on the inside and painted. Ceilings are covered with acoustical tile in the office portions. Ceilings are plastered and walls and floors in shower and toilet areas are tiled. Show-

ers have partitions of marble; toilet partitions are of factory enamelled steel.

Office floors are covered with asphalt tile. Chalkboards, projection screens and darkening shades in the conference room are planned for group instruction of personnel.



Doors in office portion are of flush wood solid-core construction. Doors to automobile service areas are of wood overhead lift type.

Heating is by forced air. Lighting fixtures are incandescent.

Complete facilities for servicing the Company trucks are provided. The gasoline island, covered with aluminum and glazed, contains pumps, and air and water hoses.

Hydraulic lift at platform affords ease in lifting heavy equipment to truck and platform level.

Materials throughout have been selected for economy in maintenance. Colors used are in keeping with the practical, industrial character of the buildings.

---

# HOSPITAL ROOM TEMPERATURE AN AID TO RECOVERY

By **DARELL BOYD HARMON**  
Austin, Texas

Temperature of hospital rooms can be as important to the patient's recovery as it is to his comfort, delegates to the American Hospital Association's 54th annual convention in Philadelphia were told recently.

Dr. Darell Boyd Harmon, of Austin, Texas, a na-

tionally known psychophysicist, pointed out that scientifically proper room temperatures can strongly support normal therapeutic procedures in a patient's recovery. Speaking at a luncheon-meeting, Dr. Harmon told some 200 hospital administrators, architects, consultants and public health officials

that "comfort is only one of many temperature factors affecting the patient's well-being."

Actually, Dr. Harmon continued, there are three distinct stages in a typical non-surgical patient's hospitalization that require precise room temperature regulation. These, he said, were the acute infection stage, the beginning of recovery and, lastly, the convalescent stage.

"Once infection sets in," Dr. Harmon explained, "the body, through Nature, attacks. This is done by increasing the metabolic rate—or in other words, by inducing fever to 'burn-up' the germ invaders. To obtain the most biological advantages from a fever it must be kept within known limits for the particular infection—an operation requiring careful room temperature regulation. A cool room, for instance, will draw too much heat away from the patient's body—with possible fatal results. On the other hand, a room too hot will bottle the fever up within the patient, causing it to reach dangerous degrees. For each infection there is a safe, known temperature level and the room temperature should be regulated to support this level."

After the infection crises has passed the Texas psychophysicist said that a more moderate temperature was desirable until, finally during the convalescing stage, a still cooler temperature should be maintained.

The actual room temperature range from the infection to the convalescing period is about 15 degrees, Dr. Harmon pointed out. The ratio might be 80°, to 72° to 65° from start to finish.

He said that comparable patterns could be related to surgery as well as non-infectious and non-surgical diseases.

---

## NEW HOSPITAL PLANNING BOOK

Just published by American-Standard is an attractive, new book of plumbing fixtures for Hospital Planning.

Designed to help hospital administrators, architects, engineers, and plumbers in the selection of plumbing fixtures and fittings for modern hospitals, this up-to-date manual is most conveniently arranged.

Divided into two main parts, Sections A and B, the book includes in the first section floor plans of the different departments of a typical hospital. The obstetrical, pediatric, and surgical sections are shown, for example, as are the administration division, laundry, kitchen, and various treatment rooms. Developed by the U. S. Public Health Serv-

ice as a guide for efficient hospital planning, the floor plans indicate the fixture requirements of the individual hospital departments.

Section B shows various plumbing fixtures like lavatories, special hospital-type sinks, baths, water closets, and therapeutic equipment in a wide variety of units. A full description is included with each fixture and fitting, giving the sizes available, type of support, and other pertinent information.

Especially handy to use, this catalogue is arranged so that the floor plan pages in Section A refer to specific pages in the second section for a selection of the particular fixtures recommended.

Its smart-looking light brown cover featuring a Caduceus emblem placed on the cross of service helps make this catalogue an attractive addition to a reference library.

---

### LONG BEACH ARCHITECTURAL DESIGN CONTEST ANNOUNCED

Announcement has been made of the 1953 Architectural Design Contest, sponsored by the Community Planning Committee of the Long Beach Junior Chamber of Commerce.

Purpose of the contest is to bring long over-due recognition to the architects who do work for the city, by stimulation of public interest in an appreciation of the functions of architecture in relation to surrounding building.

The contest has been divided into two major considerations, 1) Classifications which include a) Residences—contemporary and period, b) Commercial—remodel and new, c) Churches and d) Public Buildings. Classification 2) incorporates a consideration of a) Location, b) Contest Entry, and c) rules for submission of material.

Judges of the contest will be three architects selected from the Los Angeles Chapter of the A.I.A.

---

### ARCHITECTURAL FIRM ENLARGES ASSOCIATES

Ernest J. Kump, A.I.A. architect of San Francisco, recently announced the formation of a partnership with James D. Fessenden, A.I.A. architect and Delp W. Johnson, A.I.A. architect.

The firm will continue under the name of Kump Associates and will maintain offices at 576 Sacramento Street, San Francisco.

---

### ARCHITECT SELECTED FOR SHOPPING CENTER

Albert C. Martin & Associates, Los Angeles architects, have been appointed official architects for site planning and development of Lakewood Center and Lakewood Park commercial developments.

Martin & Associates did the original site planning for the 154 acre development.



DIGNITY AND CREATIVE NEWNESS TRIBUTE TO EXCELLENT DESIGN

DYNAMICALLY NEW CHARACTER

WITHOUT MAJOR CONSTRUCTION

# BANK OF AMERICA BRANCH

Sacramento, California

ARCHITECT: L. J. HENDY, A.I.A.

GENERAL CONTRACTOR: CAPITAL COMPANY

To the layman admirer, there is little to indicate that Bank of America's strikingly handsome and dynamically modern 12th and K Street Branch in Sacramento is not an entirely new building.

Yet, the changeover from the comparatively drab structure that formerly stood there was accomplished without major construction in eleven months time on a moderate budget and while

banking went on as usual. Excellent architectural design, and extensively utilizing architectural porcelain enamel veneer, made this possible.

Architects of the Capital Company, Bank Planning Division, used handsome and unique horizontal louvres and paneling to cover large window areas of the building's two upper floors. The job leaves no evidence that these floors are devoted to



housing automobiles of guests of Sacramento's famed Senator Hotel.

In addition, paneling was used in re-creating the street level facade of the building and to create facsimile gold-fronted, brown side-shadowed letters that spell "Bank Of America" on both street sides of the building. The parapet cap of the building is fully grouted with plastic type Portland Cement to make a structurally sound unit capable of sustaining scaffolding.

The highly decorative louvres and paneling are finished in buff, as are the street floor panels. Remainder of the upper story area is stucco, done in complementary buff and sprayed with glistening mica flakes.

The upper story area was furred out with metal studs, lath and plaster to create a plane surface. On the street floor level, time and cost were reduced by the use of metal strips to correct surface irregularities. Costly and time consuming cutting or filling was thus avoided.

During this same period, and while the bank continued to serve customers, the interior also underwent alteration. The banking area was 100% enlarged. All new bank equipment and new vaults were installed, along with mechanical refrigeration air conditioning.

A lacquer comprised of multi-colored aggregates in solution—which sprayed from a common  
(See Page 47)

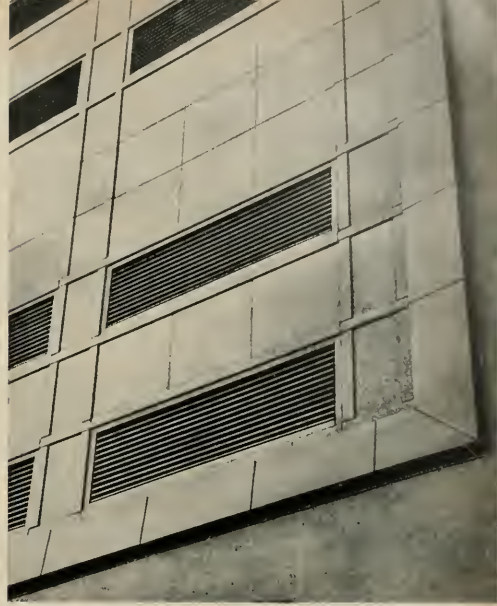

**Close-up shows design detail of attractive louvres which cover once unsightly garage window area.**

**Originally remodeled when taken over by the Bank of America in 1928 and subsequently enlarged in 1933, this is how the building appeared until its rejuvenation. Basically of brick, the building once housed a model "T" Ford auto agency.**



*Photos*

*Opposite page and  
top this page  
—Hainlin Studio*

*Other by McCurry*



Glenn Stanton, President  
 Kenneth E. Wischmeyer, 1st Vice-president  
 Norman J. Schlossman, 2nd Vice-president  
 Clair W. Ditchy, Secretary  
 Maurice J. Sullivan, Treasurer

National Headquarters—  
 1741 New York Avenue, N. W.  
 Washington, D. C.  
 Edmund R. Purves  
 Executive Secretary

**Arizona Chapter:**  
 Richard Drover (Phoenix), President; Lew Place (Tucson), Vice-President; Martin J. Young, Jr. (Mesa), Secretary; Fred O. Knips (Tucson), Treasurer; and Richard Drover, Fred Weaver and Ed Varney (Phoenix), and Martin Ray Young, Jr. (Mesa), and Gordon Luepke (Tucson), Executive Board members.

**Coast Valleys Chapter:**  
 Kurt Gross, President; Harold Ahnfeldt, Vice-President; Frank C. Treseder, Secretary; Jerome Kasavan, Treasurer. Directors, Hollis Logue and Gifford Sobey, Offices, 82 S. 3rd St., San Jose.

**Central Valley of California:**  
 John W. Bomberger, President; Nicholas Tomich, Vice-President; Albert B. Thomas, Secretary; Ted de Wolf, Treas.; Gordon Stafford, Director; Alternate to CCA, Silvia Barovetto; Sec. Office 718 Alhambra Blvd., Sacramento.

**Colorado Chapter:**  
 James M. Hunter, President, 2049 Broadway, Boulder; Casper F. Heaner, Secretary, 1659 Grant Street, Denver 5.

**East Bay Chapter:**  
 Chester H. Treichel, President; Malcolm D. Reynolds, Vice-President; John E. Lloyd, Secretary; Roger Leo, Treasurer. Secretary's Office 1171 Solano Ave., Albany, California.

**Idaho Chapter:**  
 Frederick C. Hummel, President; Jack Woodmansee, Vice-President; Jed Jones III, Sec.-Treas. Offices 1324 Idaho Street, Boise, Idaho.

**Montana Chapter:**  
 E. Edward Scowcroft, President (Billings); J. Van Teylingen, Vice-President (Great Falls); H. C. Cheever, Secretary-Treasurer. Secretary office, Bozeman.

**Nevada Chapter:**  
 Walter Zick, President, Las Vegas; Russell Mills, Vice President, Reno; Keith Lockard, Secretary, Reno; Edward Parsons, L. A. Ferris, David Vinay, Reno. Office of President P. O. Box 2107, Las Vegas.

**Nevada State Board of Architects:**  
 Russell Mills, Chairman, Reno; Aloysius MacDonald, Secretary, Las Vegas; Edward Parsons, L. A. Ferris, Reno, and Richard Stadlesman, Las Vegas, Members. Office, 309 S. 5th St., Las Vegas.

**Northern California Chapter:**  
 Albert R. Williams, President; Donn Emmons, Vice-President; William Corlett, Secretary; Bernard J. Sabaroff, Treasurer. Helen H. Ashton, Office Sec., Offices 369 Pine Street, San Francisco.

## NORTHERN CALIFORNIA CHAPTER

The first of the 1953 scheduled meetings was devoted to Membership with three outstanding national architects taking part in the program.

Pietro Belluschi, F.A.I.A., Dean of the College of Architecture at the Massachusetts Institute of Technology, was the principal speaker and ap-

pearing with him were Edward D. Stone, A.I.A., Associate Architect in the design of The Museum of Modern Art in New York City, and Richard J. Neutra, F.A.I.A., of Los Angeles and well known for his design of contemporary houses.

Belluschi, Stone and Neutra were in San Francisco to act as jurors in the Northern California Chapter Honor Awards program in conjunction with The American Institute of Architects. Announcement of the winners will be made at a presentation dinner on February 26th at the M. H. deYoung Memorial Museum, following which the winning projects will be on display to the public.

The A.I.A. Award of Merit for 1952 was also presented to Mario Corbett and Vernon DeMars—Corbett for design of the Thomsen house in Vina, California, and DeMars as associate architect in design of an apartment house in Cambridge, Massachusetts.

Remember it's

## KRAFTILE

- for ★ GLAZED STRUCTURAL WALL UNITS  
 ★ PATIO TILE  
 ★ FACE AND ROMAN BRICK  
 ★ ACID FLOOR BRICK  
 ★ HEARTH BRICK  
 ★ BRICKETTES  
 ★ MINWAX TILE & CONCRETE FLOOR FINISH

For complete information and prompt service, phone or write

## KRAFTILE COMPANY

NILES, CALIFORNIA NILES 3611

LOS ANGELES 13: 404 South Main Street—MUtual 7241

## WASHINGTON STATE CHAPTER

The February meeting was highlighted by an "open" consideration of residential construction. Some twenty slides of "residential construction" were shown and the membership invited to serve as architectural critics.

Waldo Christenson, Convention Chairman, reported considerable activity in connection with the A.I.A. Convention this spring. Considerable activity has also centered around legislative matters pertaining to the architectural profession.

NEW MEMBERS: Robert A. Eckert, and Robert E. Fansler are new Junior Associates.

## SOUTHERN CALIFORNIA CHAPTER

The February meeting was a joint conference

**Orange County Chapter:**  
William Blurock, Corona del Mar, President; George Lund, Balboa, Secretary; Paul O. Davis, Corona del Mar, Treasurer. Office of Secretary, 2919 Newport Blvd., Newport Beach. Oregon Chapter:

**H. Abbott Lawrence, President; Holman J. Barnes, Vice-President; Donald W. Edmundson, Secretary; and Robert W. Fritsch, Treasurer. Office of Secretary, 325 Henry Bldg., Portland.**

**Pasadena Chapter:**  
Robert E. Langdon, Jr., President; Wallace C. Bonnell, Vice-President; Robert L. Daines, Secretary; Henry C. Burge, Treasurer; and Directors John N. Douglas, R. VanBuren Livingston, Scott Quintan and Burton Romberger. Offices: 259 South Los Robles Ave., Pasadena 5.

**San Diego Chapter:**  
Donald Campbell, President; Victor L. Wulff, Jr., Vice-President; Richard L. Pinnel, Secretary; Edward G. Holliday, Treasurer; Louis A. Dean, Director. Office Sec., San Diego Trust & Savings Bldg.

**San Joaquin Chapter:**  
David H. Horn, President; William G. Hyberg, Vice-President; Richard P. Clark, Secretary; Bryon C. Brodrick, Treasurer. Sec. Office, 355 Anglo Bank Bldg., Fresno.

**Santa Barbara Chapter:**  
Wallace W. Arendt, President; Roy W. Cheesman, Vice-President; Chester Carjola, Secretary; Lutah M. Riggs, Treasurer. Sec. Offices, 129 De La Guerra Studios, Santa Barbara.

**Southern California Chapter:**  
Henry L. Wright, President; U. Floyd Bird, Vice-President; Cornelius M. Deasy, Secretary; Savo M. Steshich; Hugh R. Davies; S. Kenneth Johnson, Kemper Nomland and Chas. E. Fry, Directors.  
Headquarters, 3723 Wilshire Blvd., Los Angeles 5.

**Utah Chapter:**  
W. J. Monroe, Jr., President, 433 Atlas Bldg., Salt Lake City; M. E. Harris, Jr., Secretary, 703 Newhouse Bldg., Salt Lake City.

**Washington State Chapter:**  
Paul Thiry, President; John S. Dettie, 1st Vice-President; Robert H. Wahlen, 2nd Vice-President; Robert H. Dietz, Secretary; and Edwin T. Turner, Treasurer. Alice Gregor Executive Secretary, 430 Central Building, Seattle 4.

**Spokane Chapter:**  
B. K. Ruelh, President; Victor L. Wulff, 1st Vice-President; Philip Keene, 2nd Vice-President; Laurence G. Ewanoff, Secretary; and Carroll Martell, Treasurer. Office 515 American Legion Bldg., Spokane, Washington.

**Tacoma Society:**  
E. N. Dugan, President; P. G. Ball, Vice-President; Lyle Swedberg, Secretary-Treasurer.

**Hawaii Chapter:**  
Kenji Onodera, President, 3518 McCarriston St., Honolulu, T. H.; George J. Wimberly, Secretary, 315 Royal Hawaiian Ave., Honolulu, T. H.

**CALIFORNIA COUNCIL OF ARCHITECTS**  
William Koblik, President, 2203 - 13th St., Sacramento; Donald Beach Kirby, Secretary, 461 Market St., San Francisco; Frederick A. Chase, Exec. Secty., 3723-A Wilshire Blvd., Room 205, Los Angeles.

**ALLIED ARCHITECTURAL ORGANIZATIONS**

**San Francisco Architectural Club:**  
Joseph Scama, President; Frank S. Gerner, Vice-President; Russell W. Pennell, Treasurer; Frank L. Borsotti, Secretary. Club Quarters: 507 Howard St., San Francisco.

**Producers' Council—Southern California Chapter:**  
Bert Taylor, President, Pittsburgh Plate Glass Company; G. Robert Roden, Jr., Vice-President, Truscon Steel Company; Malcolm G. Lowe, Secretary, Natural Gas Equipment Inc.; Richard Seaman, Treasurer, W. P. Fuller & Company; Vern Bogot, National Director, Gladding McBean & Co.

**Producers' Council—Northern California Chapter (See Special Page)**

with the Southern California Chapter of the Producers' Council, with 1953 officers of the Southern California Chapter A.I.A. being the guests of honor.

Henry L. Wright, President, announced the following Committee Directors Kenneth Johnson, Charles Light and Kemper Nomland. Committee Chairmen included Program, Robert Field; By-Laws, John J. Landon; Membership, Winstor Cordes; Investment Advisory, George Allison; Legal, Ben O'Connor; Collaboration with National Association of Home Builders, Edward Fickett; Ethics and Practice, Whiting Thompson; Architectural Exhibits, Morris Verger; Fellowship, Eugene Weston; Education, Van Lee Schmidt.

Bulletin, Vincent Palmer; Lecture, Wm. Wollett; Public Relations, Roland Russell; Competitions, Walter Reichardt; Examinations Service, R. M. Crosby; Building Code, Russell Collins; Legislation, Stanley Gould; Public Works, Walter Hagedohm; Housing and Urban Planning, Wm. Ruck; Technical and Materials, A. C. Zimmerman; Junior Associates, Robert Dickinson and Civilian Defense, John Absmeir.

**IDAHO CHAPTER**

The annual meeting of the Idaho Chapter A.I.A. was recently held in Boise, with the following officers named to serve during the ensuing year:

Frederick C. Hummel of the firm of Hummel, Hummel & Jones, architects in Boise, President; Jack Woodmansee, was elected Vice-president; and Jedd Jones, III, named Secretary-Treasurer.

Offices of the secretary of the Chapter are maintained at 1324 Idaho Street in Boise.

**PASADENA CHAPTER**

Dr. Paul E. Webb, principal of the Los Angeles High School, was the principal speaker at the February meeting. He recently returned from Japan

where he reorganized the Japanese school system for the U. S. Government, and his comments were illustrated with many colored slides.

Committee Chairmen appointed by President Robert E. Langdon, Jr., to serve during 1953 include: Coordinating Director, Van Livingston; Pro-

(See Page 35)

**Give Your Clients  
BETTER LIGHT, BETTER SIGHT  
with  
CECO  
STEEL  
WINDOWS**



- ★ Residential
- ★ Commercial
- ★ Industrial

Take a look at the modern buildings of today . . . everywhere you'll find more view, more vision steel windows . . . made by CECO. For slender-framed CECO Windows admit more daylight . . . permit 100% controlled ventilation. Can't stick or warp . . . weathertight and fire-resistive! Cost less to install!

**Distributed by**



**Pacific Coast  
Aggregates, Inc.**

**CONTACT THE NEAREST PCA OFFICE**

SAN FRANCISCO	OAKLAND	SAN JOSE
SACRAMENTO	STOCKTON	FRESNO



# WITH THE ENGINEERS

## Structural Engineers Association of California

John E. Rinne, President, San Francisco; Jack S. Barrish, Vice-President, Sacramento; Leslie W. Graham, Secretary-Treasurer, San Francisco. Directors John J. Gould, R. W. Binder, M. A. Ewing, Leslie W. Graham, Jack S. Barrish, Harold P. King, W. T. Wheeler, John E. Rinne and Donald F. Shugart. Secretary's office, c/o Associated Structural Engineers, 417 Market St., San Francisco 5.

## Structural Engineers Association of Northern California

George A. Sedgwick, President; Michael V. Pregnoff, Vice-President; John M. Sardis, Secretary; William K. Cloud, Treasurer; Robert P. Moffett, Asst. Sec.-Treas.; Directors, Robert D. Dalton, Robert D. Dewell, William

H. Ellison, John J. Gould and J. Albert Paquette. Offices: 417 Market St., San Francisco.

## Structural Engineers Association of Central California

William H. Peterson, President; Walter S. Wassum, Vice-President; O. T. Illerich, Sec.-Treas.; Ernest D. Francis, M. A. Ewing, and Arthur A. Sauer, directors. Office O. T. Illerich, c/o Div. of Arch., Sacramento.

## American Society of C. E. San Francisco Section

Clement T. Wiskocil, President; John S. Longwell, Vice-president; J. G. Wright, Vice-president; H. C. Medbery, Treasurer; R. D. Dewell, Secretary. Secretary's Office, 604 Mission St., San Francisco.

## STRUCTURAL ENGINEERS ASSOCIATION OF NORTHERN CALIFORNIA

The February meeting was a joint meeting with the American Welding Society specially arranged to hear Van Rensselaer P. Saxe, Consulting Engineer of Baltimore, Md., speak on the subject of "Welded Structures." Saxe is well known for many articles on welded structures and is the originator of the Saxe Welded Erection System.

Saxe illustrated his talk with numerous color slides showing many phases of general design, simplicity and economy, safety, practicability, uni-

versal use, and speed of fabrication and repair.

**NEW MEMBERS:** Neil B. Flood and Arthur W. Kaufman, Members, Robert C. Clark, Affiliate, and William C. Johnson, Raymond Lundgren and Thomas A. Mullaney, Junior Members.

## STRUCTURAL ENGINEERS ASSOCIATION OF SOUTHERN CALIFORNIA

Officers elected at the recent annual meeting to serve for 1953, started the new year with the February meeting devoted to a consideration of the Design of Welded Structures with Van Rensse-



Always specify

**HAWS**

for Highest Quality

Sanitary Drinking Fountains

Electric Water Coolers

Drinking Faucets, Equipment, Filters and Accessories

• A reputation for reliability since 1909. Check in Sweets or write for HAWS catalog.

**HAWS DRINKING FAUCET CO.**

1441 FOURTH STREET (Since 1909) BERKELEY 10, CALIFORNIA  
Agents and Sales Representatives in All Principal Cities



**NEW OFFICERS (Left to right)**—Harold P. King, 1952 President; Ben Benioff, 1953 President; William T. Wright, Vice-President; and C. M. Corbit, Jr., re-elected Secretary-Treasurer.

laer P. Saxe, consulting engineer of Baltimore, Maryland, the principal speaker. Saxe illustrated his talk with a number of color slides.

**NEW MEMBERS:** William M. Mahoney, Herbert P. Ringer, Eben Stromquist, and John Vandenberg are new Associate Members. C. L. Lodjic, is a new Affiliate Member, and Manlio Roy has been chosen a Junior Member.

## FEMINEERS

The 1953 officers of the Femineers, wives of



**Structural Engineers Association of Southern California**

Ben Benioff, President; William T. Wright, Vice-President; Charles M. Corbit, Jr., Sec-Treas. Directors: Ben Benioff, William T. Wright, Harold P. King, Henry M. Layne, Joseph Sheffet, Robert J. Kadew and Harold Omsted. Offices, 121 S. Alvarada St., Los Angeles 4.

**Structural Engineers Association of Oregon**

R. Evan Kennedy, President; Guy H. Taylor, Vice-President; James R. Griffith, Secretary-Treasurer; Directors Jerome A. McDevitt, H. Loren Thompson, and Robert L. Tidball. Offices, Portland.

**Puget Sound Engineering Council (Washington)**

R. E. Kister, A. I. E. E., Chairman; E. R. McMillan, A. S. C. E., Vice Chairman; L. B. Cooper, A. S. M. E.,

Secretary; A. E. Nickerson, I. E. S., Treasurer. Offices L. B. Cooper, c/a University of Washington, Seattle 5, Washington.

**American Society Testing Materials Northern California District**

L. A. O'Leary, Chairman; P. V. Garin, Vice-chairman; H. P. Hoopes, Sec. Office Sec., 1550 Powell St., Emeryville, Calif.

**Society of American Military Engineers—San Francisco Post**

Brig. Gen. Dwight W. Johns, USA, Ret., President; Cmdr. N. M. Martinsen, CEC, USN, 1st Vice President; Lt. L. L. Wise, CEC, USNR, 2nd Vice President; Robert P. Cook, Secretary; O. Spier, Treasurer; and Rear Admiral C. A. Trexel, CEC, USN (Ret.); Capt. Cushing Phillips, CEC, USN; Capt. H. F. Ransford, CEC, USN; Clyde Bentley; Lt. Col. James D. Strong, CE, USA; and J. G. Wright directors.

members of the American Society of Civil Engineers, and Structural Engineers Association of Northern California, were elected at the recent annual meeting of the organization.

Mrs. Edward F. McKeon was chosen President; Mrs. Arthur B. Smith, Jr., Vice-President; Mrs. Leslie Graham, Treasurer; Mrs. Victor Sandner, Secretary; and Mrs. G. A. Sedgwick, Mrs. J. R. Guptill, Mrs. Eric Moorehead, Mrs. Arnold Oliit, Mrs. A. C. Horner, and Mrs. E. W. Paddock were named to the Board of Directors.

**AMERICAN SOCIETY OF CIVIL ENGINEERS—LOS ANGELES**

The Los Angeles Junior Forum of the American Society of Civil Engineers, one of the oldest and most active group of its kind, recently installed officers for the ensuing year.



Jack Howe, retiring president, pins traditional presidential badge on new president Dick Gerke, with vice-president Hal Halldin (right) and Hugh MacDonald, sec.-treas., indicating approval.

Richard C. Gerke, Sales Engineer with the fabricated structural steel division of Bethlehem Pacific Steel Corp., was named president. Harold A. Halldin with the architect-engineer firm of Daniel, Mann, Johnson and Mendenhall, was elected vice-president, and Hugh C. MacDonald, representative of the Associated Brick Manufacturers of Southern California was chosen secretary-treasurer.

**UNIVERSITY OF CALIFORNIA OFFERS EXTENSION COURSE IN ENGINEERING**

The University Extension, University of California, is offering a spring course in Design of Small Buildings for Lateral Forces, to include design of one- and two-story industrial and commercial buildings to resist wind earthquake forces, under the instruction of Henry J. Degenkolb, Structural Engineer with the firm of John J. Gould, Consulting Engineers, San Francisco.

"Advanced Soil Mechanics with Application in Highway Engineering," including consideration of foundations of buildings and bridges; stability of

(See Page 35)

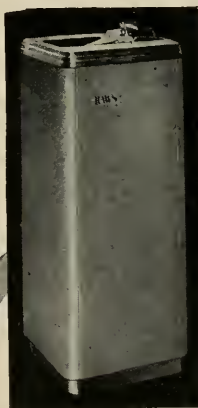

Always Specify

**HAW'S**  
for Highest Quality

- Sanitary Drinking Fountains • Electric Water Coolers • Drinking Faucets, Equipment, Filters and Accessories.

A reputation for reliability since 1909. Check in Sweet's or write for complete HAW'S catalog.

**HAW'S DRINKING FAUCET CO.**  
1441 FOURTH STREET (Since 1909) BERKELEY 10, CALIFORNIA  
Agents and Sales Representatives in All Principal Cities

# PRODUCER'S COUNCIL PAGE

The National Organization of Manufacturers of Quality Building Materials and Equipment  
(Northern California Chapter) affiliated with THE AMERICAN INSTITUTE OF ARCHITECTS

President, A. L. West, Jr.  
Aluminum Company of America  
821 Russ Bldg.

Vice-President, Howard W. Noleen  
E. F. Hauserman Company  
31 Geary Street

Secretary, Hillman Hudson  
Vermont Marble Company  
525 Market Street

Treasurer, Tait Smith  
Ceco Steel Products Corp.  
401 Tunnel Avenue

Edited by Phil Brown, OTIS ELEVATOR COMPANY.

## COUNCIL ACTIVITIES

For the past year, the executive committee has felt that there is an excellent opportunity to expand the activities and coverage of the Producers' Council. Part of this expansion is concerned with the presentation of our various informational programs to the northern California Chapters of the A.I.A.

These Chapters of the A.I.A. are at present seeking programs from building material manufacturers for presentation at their meetings.

Actually this is a golden opportunity for the members of the Producers' Council to carry the message of their individual products to the architects of the East Bay and Valley Chapters, and it will give us the opportunity to greatly strengthen the position of the Producers' Council in the eyes of all of the Northern California Chapters which go to make up the California Council of Architects.

The reasons for this, of course, are obvious and this program should have the backing of everyone in the Council.

Herb Duncan, Chairman of the Educational Committee, will need the assistance and co-operation of all of the member companies in making these programs available and conducting the actual presentations. Many of the members of the Producers' Council are traveling up and down the Valley at various times and by means of a little forethought and planning, we are sure that these Valley meetings could be attended not only by the company making the presentation, but also by other representatives who are in the area.

We are sure that our schedules are not so rigid that they cannot be moved up or postponed one or two days so that our dates to be out of town could be arranged to coincide with the date of a particular presentation at one of the Valley Chapters.

This would not only be of assistance to the individual making the presentation, but would present a fine opportunity for some good fellowship among the Council Members.

## 1953 PROGRAMS

On January 12 the Gladding, McBean Co. presented a fine new film entitled "For Now and Forever." Mr. Ray Brown is to be congratulated for getting our informational meetings off to such a fine start for this year, and we are sure that the programs to follow will be equally well done.

All programs are being screened for composition and presentation with the thought of improving our informational meetings.

The schedule for the year is as follows:  
February 2, W. P. Fuller & Company.  
March 2, Natural Gas Equipment, Inc.  
April 6, American Lumber & Treating Co.  
April 29, Armstrong Cork Company (Dinner Meeting).

May 1, Table Top Exhibit.  
June 1, Golf Tournament.  
July 6, Reynolds Metals Company.  
August, unassigned.  
September, United States Plywood Corp.  
October, unassigned.  
November, unassigned.  
December, annual Christmas Jinks.

USE QUALITY PRODUCTS



CONSULT AN ARCHITECT

## WITH THE ENGINEERS

(From Page 33)

earth dams and deep cuts; pressure on retaining walls, etc., will also be given with Dimitri P. Krynine, instructor.

A third course in "Analysis of Indeterminate Structures" is being given by Richard J. Woodward, partner of Clyde & Associates, Foundation Engineers, Oakland and Berkeley, as instructor. Instruction will include solution of rigid rectangular, box or gabled frames and of rings and sewers; and arches by the conventional arch method.

## STRUCTURAL ENGINEERS ASSOCIATION OF CALIFORNIA

The organization recently went on record as opposing legislation proposed in the California State Legislature, and sponsored by the Delano Chamber of Commerce, which would create a Division of Architecture in the Department of Education with the responsibility of furnishing plans and specification and supervision of public school buildings.

A similar measure was defeated four years ago, according to a report from John J. Gould, Chairman of the Legislative Committee of the SEAC.

## SOCIETY OF AMERICAN MILITARY ENGINEERS—San Francisco

Prof. Robert J. Kerner, Sather Professor of History and Director of the Institute of Slavic Studies at the University of California, spoke at the February meeting on the subject "Time's on the Side of Moscow."

Prof. Kerner has written many books on European conditions and factors and is a recognized authority on the subject.

Plans are underway for the March meeting in the Presidio Officers Club to be a dance.

## A.I.A. ACTIVITIES

(From Page 31)

grams, Bob Cook; Construction Industry, Ken Gordon; Coordinating Director Scott Quintin for Governmental Relations, Breo Freeman; Practice of Architecture, George Cannon. Coordinating Director Burt Romberger for Public Relations, Culver Heaton; Exhibits, Gene Fickes; Information Please, Burt Romberger. Coordinating Director Bonnie Bon-sail for Education and Registration, Dorothy and Wilbur Harrison, co-chairmen; and Membership, Don Neptune.

The Chapter has launched a five-point program for 1953 which includes 1) Maintain the reputation of the architectural profession, 2) Improve education and broaden horizons, 3) help junior associates to become licensed, 4) enlarge public

relations program, and 5) take advantage of cooperation offered by the Womens' Architectural League.

## SAN FERNANDO VALLEY CHAPTER

Martin Snell has been elected president of the San Fernando Valley Chapter of the A.I.A. for 1953.

Named to serve with Snell as officers of the Chapter were Alec Murrey, Director; Henry Withey, Director; Robert Stacey-Judd, Treasurer and Albert Hawk, Secretary.

## UNIVERSITY OF COLORADO

The department of Architecture and Architectural Engineering of the University of Colorado, Boulder, is conducting a School Plant Planning Workshop during the second term of the 1953 Summer Session, according to Thomas L. Hansen, A.I.A. Head of the Department.

The course is to consist of lectures and seminars devoted to school plant design in relation to educational programs, to meet the needs of superintendents, principals, members of school boards, and others interested in school building programs.

One or two field trips are scheduled to Denver and others in the immediate vicinity of Boulder,

## STOP WATER DAMAGE!



FORM BOARDS



BRICK - CONCRETE



PAINTED SURFACES

Specify  
*Thompson's*  
**WATER SEAL**  
for  
**Waterproof Protection**  
of all porous materials

- It penetrates • Is transparent
- Leaves no film • Lacks out moisture
- Lasts for years • Proved by performance.

Will cover 200-400 sq. ft. to gal. depending on porosity of material. Specified by architects and used by contractors all over the West. Has State of California approval.

Write or phone for proof of performance and specification material.



Manufacturer

**BY-CHEMICAL PRODUCTS CO.**

1355 MARKET ST., SAN FRANCISCO • KING CITY • LOS ANGELES



to review recently constructed school buildings. Programs will be supplemented by lectures given by visiting practicing architects, representatives of building material manufacturers associated with the Producers' Council of America.

The course will begin on July 27th and extend thru August 14th. For complete information write Professor Thomas L. Hansen, A.I.A., Head of the Department of Architecture and Architecture Engineering of the University of Colorado at Boulder.

### UNIVERSITY OF SOUTHERN CALIFORNIA

Seventy-five students of the School of Architecture at the University of Southern California recently completed and reported to city officials their studies of detailed city-planning research for the cities of Fontana and Rialto.

Under the direction of Prof. Simon Eisner, the project included research, maps showing land-use inventories and population distribution, together with personal interviews with various key city officials.

### CALIFORNIA COUNCIL OF ARCHITECTS

John J. Landon, Los Angeles architect and past president of the Southern California Chapter A.I.A., and Ulysses Floyd Rible, Los Angeles architect,

have been elected delegates-at-large to the California Council of Architects.

Also named to serve as members of the Council are Henry L. Wright, president, and Charles E. Fry, immediate past president of the Chapter.

### OREGON CHAPTER

Francis Jacobberger, F.A.I.A., was the main speaker at the January meeting, held in the City of Portland.

Mary Alice Hutchins, chairman of the Exhibitions Committee, reported excellent progress in plans for the A.I.A. Show to be staged in February at the Auditorium of Meier & Frank Company. More than forty registrations for space had been received.

**NEW MEMBERS:** Robert Bernard Martin, Corporate Member. Raymond A. Case, and Donald Harry Lindgren, Associate Members; and Elton V. Kern, and John M. Amundson, Junior Associates.

### STATE POLYTECHNIC COLLEGE HOLD OPEN HOUSE

Open house will be observed at the California State Polytechnic College, San Luis Obispo, in April, with a public showing of "educational progress."



## Summerbell for schools

**SUMMERBELL** dependable glued laminated construction plays an increasingly important part in modern school design because it combines strength and safety with flexibility. That's why **SUMMERBELL** is the choice of leading school Architects, Engineers and school authorities.



**SUMMERBELL** glued laminated curved beams. Primarily, California, School Districts, Colleges, Courts & Hospitals, Architects and Engineers. Albert Reingard, General Contractor.



Glued Laminated Construction • Summerbell Bowstring Trusses  
Lombello Roofs & All Types of Timber Structures

For quality, economy and satisfaction, specify **SUMMERBELL**

## Summerbell ROOF STRUCTURES

825 EAST 29TH STREET • BOX 218, STATION "K" • LOS ANGELES 11



**MODEL HOTEL AND MODEL QUEEN**—Architectural Engineering students at the California State Polytechnic College show a student project, model hotel building, to Cecilia Fava, Sacramento State College co-ed. Students Jack Knighton, Roy Chan and George Dinsmore participate in welcome to Queen Cecilia who will reign over all-male Cal Poly student body during Poly Royal in April.

Engineering, agricultural and liberal arts exhibits will engulf the campus with twenty-eight major departments of the college taking part. Highlight of the annual event is a two-day livestock show in which agricultural students will exhibit their project beef, sheep, swine, poultry and dairy stock.

All "Poly Royal" events are open to the public.

This year's show has been dedicated to J. I. Thompson, member of the California State Bureau of Agricultural Education Since 1931.

### LOS ANGELES ARCHITECTURAL MEMORIAL LIBRARY FORMED

A memorial for the late Mrs. Robert Alexander has been established in the Library of Architecture and Allied Arts of Los Angeles, according to a recent announcement.

The memorial will be used for the purchase of books for the library.

Mrs. Alexander served as librarian for the past two years, during which time she greatly augmented the services of the library and made it one of the most outstanding in the nation.

### WOMENS' ARCHITECTURAL LEAGUE OF SOUTHERN CALIFORNIA

Otto S. Snoffer, public relations representative of the Los Angeles Department of Water and Power, was the principal speaker at the February meeting of the Womens' Architectural League of Los Angeles.

A motion picture film entitled "Twin Titans" was shown.

### SOUTHERN CALIFORNIA HOME SHOW GETS NEW PRESIDENT

Frank E. Hess, leading figure in the develop-

ment of Southern California, has been named president of the Construction Industries Exposition and Home Show for 1953.

Four new vice presidents were also appointed, including Vern R. Huck, D. J. Missimer, Howard Dyer, and Donald Reed.

### BERT TAYLOR RESIGNS

Bert Taylor, president of the Southern California Chapter of the Producers Council, Inc., has resigned to accept a position with a large national firm in Dallas, Texas.

### MOSAIC TILE COMPANY MAKES APPOINTMENTS

J. A. Falconer, associated with the Mosaic Tile Company for the past fifteen years, has been named General Manager in charge of manufacturing and administration of the firm's west coast factories and warehouses, according to Thomas B. Jordan, Western Manager.

Other Mosaic personnel changes include appointment of Louis Grossman as salesman in the Jordan Tile Manufacturing Company Corona plant; Frank Dyer, recently in charge of the tile setting school at West Coast University, appointed to the Hollywood Showroom and Warehouse, and Mike Adams, a recent graduate of the University of Oregon, has been appointed a salesman.



# BRONZE PRODUCTS

by GREENBERG

Your best and nearest source for standard and special Bronze products



STABILITY since 1854

## M. GREENBERG'S SONS

765 Folsom St • San Francisco • Calif • EXbrook 2-3143

Manufacturers of Fire Hydrants and Fire Protection  
Brass Goods • Industrial, Navy and Maritime  
Bronze Valves and Fittings • Plumbing and  
Hardware Brass Specialties • Bronze Plaques,  
Letters and Name Plates.

LOS ANGELES • SEATTLE • PORTLAND • SPOKANE • SALT LAKE CITY • DENVER • EL PASO • NEW YORK • HARTFORD • WASHINGTON, D. C.

## SANATORIUM - SAN MATEO

(From Page 21)

Cabinet work is hardwood. Counter tops in work areas are stainless steel, as are sinks and built-in lavatories. All flush hardwood doors where wheeled traffic may pass are fitted with steel edge guards.

The architectural concrete exterior of the building has been finished with a cement type paint. Brick has been used for warmth of appearance for the reinforced walls of the entrance wing, as well as for panels between columns below windows at the first floor level. Sash throughout are steel, combination casement and hopper type. Entrance doors and glazed walls of entrance wing are Satin alumilite finish aluminum.

Adequate parking areas have been provided on the grounds for public staff, and service employees, and various entries for deliveries, morgue, employees, staff, nurses and general public have been carefully segregated.

This hospital as built is considered the most advanced building of its type in existence. The most up to date care of tubercular patients has been provided for. Two years of preliminary study and research preceded the development of the program and the final design. Studies were made of all existing facilities of this type, and the leading

experts in the field throughout the country were consulted. This background, in conjunction with close cooperation of the Health Department authorities of San Mateo County made possible a hospital which assures the very best and most advanced type of treatment with the desirable minimum of personnel to operate the facility and economic operation over the years.

The hospital was planned for a normal capacity of one hundred beds, but is easily capable of handling 120 beds within their original building. With minimum revisions to the building, the capacity can easily be increased in an emergency to 150 beds or over with no structural change.

The contract price for construction and fixed equipment, exclusive of Radiographic equipment was \$1,331,550. Total area is 77,544 square feet.

### ALASKA ARMY CONSTRUCTION GAINS 1953 MOMENTUM

The Corps of Engineers for the Alaska District, recently announced a schedule of two-hundred and sixty-four Alaska defense construction projects will be submitted to competitive bidding before next April.

Bid opening dates are now proposed as firm on one-hundred and thirty-seven of the jobs. Total value of the program is \$240 million dollars.

### KRAFTILE PREDICTS BUILDING INCREASES AHEAD

C. W. Kraft, president of Kraftile Company, Niles, California, is looking forward to the largest year in his company's history during 1953, and predicts an increase in sales of 35 per cent.

The anticipated increase is in line with one enjoyed by the entire industry, Mr. Kraft pointed out. He continued:

"The unique chemical properties of structural wall units, one of the youngest of all clay products, have increased its use three-fold in the past ten years. Chemical plants, dairies, breweries, printing plants, industrial and institution buildings now are being designed with interior walls of structural wall units for sanitation, cleanliness, easy, low-cost maintenance and many special purposes offered by no other building material.

"Wall units should not be confused with ordinary wall tile, which is less than one-half inch thick and does not support its own weight. This relatively new material, developed in the past two decades, is a structural unit usually at least 4 inches thick. It holds its own weight and that of ceilings, roofs, joists or other loads placed on it.

"Used in industry, its special values have been established by research and by experience. It aids in humidity control, since moisture condenses and runs off its surface. In factories processing textiles,

**SAN MATEO COUNTY**

**Sanatorium**



*built by*

**HOWARD J. WHITE, Inc.**

**Palo Alto, Calif.**



drugs, chemicals and foodstuffs, it helps control lint, dust and dirt, and does not absorb acid fumes or odors. Bacterial growth is prevented on the walls in meat packing plants and research laboratories.

"Usable shop space need not be left idle to provide for cumbersome cleaning and painting equipment required with other types of wall finishes.

"Installation and modernization of shower rooms, and locker rooms for employees is an example of one of the market factors that is increasing demand for structural wall units. Even more important is the rapidly growing trend toward in-plant feeding facilities for employees. The number of employee cafeterias, restaurants or lunchrooms has increased tremendously in recent years and we believe even more will be installed within the next few years."

### STRUCTURAL CONCRETE ASSOCIATION HOLDS ORGANIZATION MEETING

E. S. McKittrick of Alhambra, California, has been elected president of the Structural Concrete Association at the organization's recent inaugural meeting.

William J. Moran and Harold Roach, both prominent leaders in the construction industry in Southern California, were chosen vice-presidents. Robert G. Swan, was named secretary, and Corwin Wickersham, elected treasurer.

The Board of Directors include Emil Wohl, Chairman, Los Angeles; E. S. McKittrick, William J. Moran, Arthur Menke, Carl H. Wittenberg and John A. Alexander of Los Angeles; Harry H. Hilp, San Francisco; Robert M. Golden, San Diego, and H. A. Anderson of Portland.

The organization was formed to provide a source of mutual assistance to members in technical and legal problems arising in the design and construction of structural concrete projects.

### PRODUCERS COUNCIL OF SOUTHERN CALIFORNIA

G. Robert Roden, Jr., vice-president of the Producers Council, Southern California Chapter, has been named president of the organization and will serve for the balance of the fiscal year.

He succeeds Bert Taylor, who resigned and is moving to Dallas, Texas, where he has accepted a position as national sales manager for the Universal Corporation.

### ERROR

A recent issue of ARCHITECT & ENGINEER stated that Frank Lloyd Wright was a "F.A.I.A." This was an error as architect Frank Lloyd Wright is not a member of The American Institute of Architects, and can not therefore be a "Fellow."

## ORDERER CORNICE WORKS

*Manufacturers of*

Hollow Metal Products • Interior Metal Trim  
Elevator Fronts and Cabs  
Metal Plaster Accessories • Sanitary Metal Base  
Flat and Roll Metal Screens  
Metal Cabinets • Commercial Refrigerators

269 POTRERO AVE.

SAN FRANCISCO, CALIF.

HEMLOCK 1-4100

## Parker, Steffens & Pearce

BUILDERS

135 South Park, San Francisco

Phone: EXbrook 2-6639

## BARRETT & HILP

CONTRACTORS

*Serving The Construction Field  
Since 1912*

OUR FORTIETH YEAR

918 Harrison Street • San Francisco  
Telephone DOuglas 2-0700



**Brown's**  
STANDARD

The resilient building paper creped to S-T-R-E-T-C-H

Quality Products Since 1895  
**ANGIER PACIFIC CORPORATION**  
55 NEW MONTGOMERY ST. • 7434 SUNSET BOULEVARD  
SAN FRANCISCO 5, CALIF. • LOS ANGELES 46, CALIF.

A complete line of Angier products available from your building material dealer

## STOP

Penetration Of  
MOISTURE  
WIND  
DUST  
VERMIN

EVERLASTING  
PROTECTION

# CLINTON CONSTRUCTION CO.

OF CALIFORNIA

**General Contractors**

923 FOLSOM STREET • SAN FRANCISCO

SUffer 1-3440

# HOGAN LUMBER CO.

Wholesale and Retail

## LUMBER

MILL WORK • SASH & DOORS

Office, Mill, Yard and Docks

SECOND AND ALICE STREETS • OAKLAND, CALIF.

Telephone GLencourt 1-6861



**COSTS 50%  
LESS THAN "BULK" or  
"BLANKET" TYPES OF INSULATION**  
... AND, IN ADDITION, ACTS AS A VAPOR-  
BARRIER (MEETS FHA REQUIREMENTS). COSTS  
LESS TO APPLY. WRITE FOR SAMPLES AND  
FULL INFORMATION ON ALL USES!

**The SISALKRAFT CO.**

55 New Montgomery St. San Francisco 5, California

# JUDSON PACIFIC - MURPHY CORP.

Steel Fabricators  
and  
Erectors

REINFORCING STEEL

STRUCTURAL STEEL

BRIDGE CRANES

4300 EASTSHORE HWY.  
EMERYVILLE, CALIF.

Phone:  
OL 3-1717

## BOOK REVIEWS PAMPHLETS AND CATALOGUES

**FOOD WASTE DISPOSAL UNITS.** Housing Research No. 4, U.S. Government Printing Office, Washington, D.C. Price \$ .30.

As part of its continuing research on plumbing systems, the HHFA sponsored tests by the National Bureau of Standards of several disposal units now in common use. Tests were run and observations made to: study the pressure and flow conditions in the fixture drains as they are effected by the use of food-waste disposal units; determine the minimum rate of flow of water required for efficient transportation of solids in the drain; determine the effect of the units on self-siphonage sinks; and determine the ability of the units to grind various types of food waste.

The tests conclude that food waste disposal units, when properly used, do not have harmful effects on plumbing systems, water consumption, and drainage pipes.

**PRACTICES AND PRECEPTS OF MARKETING PREFABRICATED HOUSES;** U.S. Government Printing Office, Washington, D.C. Price \$ .35.

A comprehensive analysis of the methods by which prefabricated houses are sold, sponsored by the HHFA's Division of Housing Research and prepared under contract with Cornell University.

The 58-page study is divided into two parts. Section I, "Existing Marketing Practices," concentrates on retailing aspects with description of retail outlets—size, type and other criteria; Retailer-Customer relations, covering dealer' activities in selling, advertising and sales promotion; General Problems of the Retailer—land development, building codes, labor relations; and Retailer-Manufacturer Relations.

Section II, stresses importance of planning marketing programs—analysis of national and local markets, product, channels of distribution, sales policies, finance policies, and erection and service policies.

## NEW CATALOGUES AVAILABLE

*Any of the catalogues or folders described here may be obtained by forwarding your request as indicated in the coupon below to the office of the ARCHITECT & ENGINEER. Merely mark the items you want and clip or paste the coupon to your letterhead.*

**446. DUMBWAITER AND ELEVATOR CATALOG.** A newly revised catalog with illustrations and description of electric and manually operated dumbwaiters, dumbwaiter doors, elevators, residence lifts and stair-travelers. Also contains dumbwaiter specifications and dimensioned layouts for electric and manual dumbwaiters and electric sidewalk elevators. Sedgwick Machine Works, Inc., 90 Eighth Avenue, New York 11, N. Y.

**447. KITCHEN HOSTESS BREAKFAST NOOKS.** A complete line of ready built breakfast nooks has been designed for easy installation in the kitchen by Bianco Mfg. Co. The line will be marketed nationally under the registered name Kitchen Hostess. Distributors and dealers are now being appointed. A catalog, completely illustrated, in color, describing the various styles of Kitchen Hostess Nooks and suggesting kitchen layouts is just off the press. Bianco Mfg. Co., St. Louis 4, Mo.

**448. HARDBOARD SIDING.** "Mascnite Siding" is the title of a four-page illustrated bulletin which describes in detail the approved methods of application. Sketches and tabulated data provide full information on preparation, shadow strips, nails, corner treatments and finishing. They are available free by writing Mascnite Corporation, 111 West Washington St., Chicago 2, Ill.

**449. CONCRETE CURING PAPERS.** A folder covering the qualities of two reinforced, reusable papers for concrete curing is available from the Angier Corporation. These two papers, Burlamat and Protectamat, are described and the uses outlined with a chart showing the properties each has for water-proofing, wet strength, sulphur, shrink resistance, reinforcement re-usability. For copies of the folder write Angier-Pacific Corp., 55 New Montgomery St., San Francisco.

**450. ADHESIVES TO SET CLAY TILE.** The use of adhesives in installing clay floor and wall tile in commercial, industrial, institutional and home construction is given industry-wide recognition by clay tile manufacturers in a specification now being released by the Tile Council of America to architects and tile contractors throughout the nation. A commercial standard for water-resistant organic adhesives used in such work was issued in July by the U. S. Department of Commerce. Clay tile can be installed with adhesives in both new construction and remodeling work. This method can often reduce installation time and cost, eliminate some of the weight and mass of the completed work and cut down the muss and fuss in remodeling, according to experienced installers. In new building, adhesives are particularly suited to dry wall construction. A.I.A. 23A, Tile Council of America, 10 East 40th Street, New York 16, N. Y.

**451. FIBERGLAS ROOF INSULATION.** A new folder on Fiberglas roof insulation has been published by Owens-Corning Fiberglas Corporation. At first glance the folder appears to be of standard 8½ by 11-inch size but actually it opens up to a huge 33 by 25-inch sheet that has more than 40 photographs of outstanding installations of Fiberglas roof insulation throughout the United States. Under the photographs are listed 350 more outstanding jobs along with the names of architects, general contractors and roofing contractors. Fiberglas roof insulation is used in industrial plants, schools, stores and shopping centers, hospitals and public buildings. Data concerning thermal conductance and application specifications also are included in the folder. Owens-Corning Fiberglas Corp., Toledo 1, Ohio.

**452. MOVABLE STEEL PARTITIONS.** A new colorfully illustrated 8-page brochure is now available which describes, with photographs and detailed drawings, flush and semi-flush type partitions, panel and industrial type partitions, Mobilwalls, Mobilrails and Mobilscreens, and wainscot for complete steel interiors. Included, too, is descriptive data on steel-tile acoustic ceiling. Detailed drawings illustrate basic types of each of these Mobilwall steel partitions and give complete information on how movable steel partitions can be used to increase efficiency and enhance the appearance of offices, factories, laboratories, hospitals, schools and government buildings. A.I.A. 35-H-6, Mobilwalls Brochure, Virginia Metal Products Corp., 1112 First National Bank Building, Pittsburgh, Penna.

**453. COLORBESTOS SIDING SHEETS.** A new eight-page brochure in full color has just been published containing complete information, illustrations, and data on "Colorbestos Siding Sheets," the new building material developed by Johns-Manville which, for the first time, combines pattern and color in a large size asbestos sheet for the exterior of houses. Using short text and many colored photographs, this brochure shows how Colorbestos is being used by architects and builders to meet the modern trend in house design. Close-up pictures show the seven strong colors and vertical ribbed pattern of the material. Several completed houses are illustrated together with details showing how Colorbestos is handled around the doors, windows, gable ends, soffits, and similar places. A.I.A. 12-F-1. The brochure, which is entitled, "Colorbestos Siding Sheets," is available by writing to Johns-Manville, 22 East 40th Street, New York 16, New York.

**454. GAS HEATERS.** A complete revision of literature to include new designs and data of its line of gas heaters has been prepared by Reznor Manufacturing Company of Mercer, Pennsylvania. Heading the list is a 20-page general catalog, No. GN-52, in which the Reznor line is classified into four types of heaters which it manufactures. This factual general catalog gets into the "meat" of the subject with a minimum of selling copy. A.I.A. 30-C-43 and 30-B-1. Reznor Manufacturing Company, Mercer, Penna.

# VERMONT MARBLE COMPANY

DOMESTIC AND IMPORTED MARBLES  
GRANITE VENEER

525 MARKET STREET • SAN FRANCISCO 5

Phone: SUtter 1-6747

3522 COUNCIL STREET • LOS ANGELES 4

Phone: DUkirk 2-7834

The Most Complete Line of  
**STEELS and STEEL BUILDING MATERIALS**  
Made by a Single Producer



See Sweet's Catalog File or write us for  
full information.

**REPUBLIC STEEL CORPORATION**

GENERAL OFFICES: CLEVELAND, OHIO

DENVER, COLORADO . . . . . CONTINENTAL OIL BUILDING  
LOS ANGELES, CALIF. . . . . GENERAL PETROLEUM BUILDING  
SAN FRANCISCO, CALIFORNIA . . . . . RIALTO BUILDING  
SEATTLE, WASH. . . . . WHITE-HENRY-STUART BUILDING

# PACIFIC MANUFACTURING CO.

High Class Interior Finish Quality  
Millwork

16 Beale St., San Francisco  
GARfield 1-7755

2215 El Camino Real, San Mateo  
S. M. 5-0687

304 Bryant Street, Palo Alto  
P. A. 3373

2610 The Alameda, Santa Clara  
S. C. 607 (Factory)

6820 McKinley Avenue, Los Angeles  
THornwall 4196

MAIN OFFICE — SANTA CLARA

# "AMERICAN - MARSH"

CONDENSATION UNIT

Pumping  
Machinery  
for  
Every  
Purpose

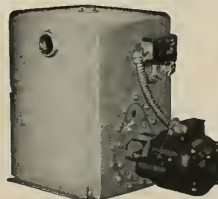

For Service  
Call  
DOuglas  
2-6794  
or  
MUtual 8322

**SIMONDS MACHINERY CO.**  
SAN FRANCISCO 816 FOLSOM  
LOS ANGELES 455 EAST 4TH

**ARCHITECT AND ENGINEER**  
68 Post Street, San Francisco, Calif.

I would like to have a copy of each of the New Catalogues I have circled.

446      447      448      449      450  
451      452      453      454

Please send to the address on my letterhead, or as I have indicated, and to my attention. (Please print your name — no literature will be sent on this coupon after March 1953.—A. & E.)



## VETERANS' HOSPITALS

(From Page 13)

tract Office in Dallas and other V-A installations. By plugging in various circuits, teletype conferences between doctors and officials in different cities may be arranged.

More than 50 fire alarm stations and fire hoses are provided. Automatic sprinkler protection has been installed in dangerous areas and enclosed stair wells with fireproof steel doors give safe exits for patients and staff members.

The four channel radio system is piped through a control panel in the radio room where a radio information specialist operates four long-range receivers, two built-in phonograph turn tables and a microphone for news and announcements. The programs distributed on the four radio channels are closely supervised by the medical staff so that inappropriate entertainment will not be piped to certain wards to the detriment of the patients.

Another of these modern V-A hospitals is that in Omaha, Nebraska. Beds are provided for 486 patients, of which 89 are for psychiatric patients. Clinics in this building include facilities for out-patients with 13 examining rooms; pharmacy; a dental unit with five chairs; X-ray department with three X-ray rooms, one deep therapy and superficial therapy; orthopedic brace shop; research laboratory; laboratories for chemistry, bac-

teriology and animal operating, etc.; medical illustration laboratories where drawings and photos used for medical education are prepared; medical rehabilitation which provides physiotherapy and occupational therapy. The operating suite contains seven major and one minor operating room.

Utility shops are located within the main building and a separate building is provided for garage and laundry and one for boiler house. Living quarters for internes and residents are located within the main building. Separate quarters buildings are provided for the manager, for staff, nurses and attendants.

## NEWS & COMMENT ON ART

(From Page 9)

shown at the San Francisco Museum of Art during February, is featuring some 200 works selected by the juries for exhibition.

Prize winners in this year's event include: Ernest Briggs, the \$300 Anne Bremer Memorial Prize for Painting; Hugh Townley, the \$300 San Francisco Art Association Emanuel Walter Purchase prize; John Haley, the \$250 San Francisco Art Association Prize for Painting; Robert Neuman, the \$100 Artists' Council Prize; Dick Sears, the \$75 Artists' Council Prize; Theodore Polos, \$100 William L. Gerstle Memorial Prize for Composition in Painting.

Kyle Morris, \$100 Henry F. Swift Award in Memory of Helen Forbes; Charles Griffin Farr, \$100 Bank of America Prize for Painting; Lundy Siegrist, \$100 Anglo-California National Bank Prize for Painting; Leonard Edmundson, \$100 Bank of California Prize for Painting; Zygmund Sazevich, \$100 Crocker First National Bank Prize for Sculpture; Robert C. Thomas, \$100 American Trust Company Prize for Sculpture; Horst B. Trave, \$100 San Francisco Bank Prize for Painting; Stefan A. Novak, \$75 Wells Fargo and Union Trust Company Prize for Sculpture; Bart Perry, \$100 Schwabacher-Frey Company Prize; William W. Underhill, \$50 Edgar Walter Memorial Prize for Sculpture.

The Jury of Selection for Painting comprised James McCray, Chairman, Erle Loran, Alexander Nepote, Dorr Bothwell and Emiko Nakano. The Jury of Awards included McCray, Loran and Nepote. The Jury for Sculpture was Adaline Kent, Chairman, Gurdon Woods and Jeremy Anderson.

## ARCHITECT APPOINTED

George Edson Danforth, on the architecture staff at the Illinois Institute of Technology in Chicago, has been appointed professor of architecture at Western Reserve University, according to a recent announcement by John S. Millis, president.

## VALUABLE NEWS SERVICE

- BUILDING MATERIAL DEALERS
- CONTRACTORS
- SUB-CONTRACTORS
- MANUFACTURERS AND REPRESENTATIVES

**ARCHITECTS REPORTS** gives advance news on construction projects in Northern California, lists: name of projects, location, architect, proposed cost and other pertinent information.

**HANDY** individual slip-reports, issued daily at a total cost of only \$10 a month

## ARCHITECT'S REPORTS

Published Daily

The ARCHITECT and ENGINEER, Inc.

68 Post Street, San Francisco - DO 2-8311

# ESTIMATOR'S GUIDE

## BUILDING AND CONSTRUCTION MATERIALS

PRICES GIVEN ARE FIGURING PRICES AND ARE MADE UP FROM AVERAGE QUOTATIONS FURNISHED BY MATERIAL HOUSES TO SAN FRANCISCO CONTRACTORS. 3% SALES TAX ON ALL MATERIALS BUT NOT LABOR

All prices and wages quoted are for San Francisco and the Bay District. There may be slight fluctuation of prices in the interior and southern part of the state. Freight cartage, at least, must be added in figuring country work.

**BONDS—Performance or Performance plus Labor and Material Bond(s), \$10 per \$1000 on contract price. Labor & Material Bond(s) only, \$5.00 per \$1000 on contract price.**

**BRICKWORK—MASONRY—**

Common Brick—Per 1 M laid—\$150.00 up (according to class of work).  
Face Brick—Per 1 M laid—\$200.00 and up (according to class of work).  
Brick Steps—\$3.00 and up.  
Common Brick Veneer on Frame Bldgs.—Approx. \$1.20 and up (according to class of work).  
Face Brick Veneer on Frame Bldgs.—Approx. \$2.00 end up (according to class of work).  
Common Brick—\$36.00 per M—truckload lots, delivered.

Face Brick—\$81.00 to \$106.00 per M, truckload lots, delivered.

**Glazed Structural Units—Walls Erected—**

Clear Glazed—  
2 x 6 x 12 Furring .....\$2.00 per sq. ft.  
4 x 6 x 12 Partition ..... 2.25 per sq. ft.  
4 x 6 x 12 Double Faced  
Partition ..... 3.00 per sq. ft.  
For colored glaze add. .... 30 per sq. ft.

Mantel Fire Brick \$150.00 per M—F.O.B. Pittsburgh.

Fire Brick—Per M—\$111.00 to \$147.00.  
Cartage—Approx. \$10.00 per M.  
Paving—\$75.00.

**Building Tile—**  
8x8x12-inches, per M .....\$139.50  
6x5x12-inches, per M ..... 105.00  
4x5x12-inches, per M ..... 84.00

**Hollow Tile—**  
12x12x2-inches, per M .....\$146.75  
12x12x3-inches, per M ..... 156.85  
12x12x4-inches, per M ..... 177.10  
12x12x6-inches, per M ..... 235.30  
F.O.B. Plant

**BUILDING PAPER & FELTS**

1 ply per 1000 ft. roll .....\$5.30  
2 ply per 1000 ft. roll ..... 7.80  
3 ply per 1000 ft. roll ..... 9.70  
Brownskin, Standard 500 ft. roll ..... 6.85  
Sisalcraft, reinforced, 500 ft. roll ..... 8.50

**Sheathing Papers—**  
Asphalt sheathing, 15-lb. roll .....\$2.70  
30-lb. roll ..... 3.70  
Dampcourse, 216-ft. roll ..... 2.95  
Blue Sinkerboard, 60-lb. roll ..... 5.10

**Felt Papers—**  
Deadening felt, 3/4-lb., 50-ft. roll .....\$4.30  
Deadening felt, 1-lb. .... 5.05  
Asphalt roofing, 15-lbs. .... 2.70  
Asphalt roofing, 30-lbs. .... 3.70

**Roofing Papers—**  
Standard Grade, 108-ft. roll, Light .....\$2.50  
Smooth Surface, Medium ..... 2.90  
Heavy ..... 3.40  
M. S. Extra Heavy ..... 3.95

**BUILDING HARDWARE—**

Sesh cord com. No. 7 .....\$2.65 per 100 ft.  
Sesh cord com. No. 8 ..... 3.90 per 100 ft.  
Sesh cord spot No. 7 ..... 3.65 per 100 ft.  
Sesh cord spot No. 8 ..... 3.35 per 100 ft.  
Sesh weights, cast iron, \$100.00 ton. ....\$3.75  
1-Ton lots, per 100 lbs. .... \$4.75  
Less than 1-ton lots, per 100 lbs. .... \$1.55  
Nails, per keg, base .....\$12.55  
Bin spikes ..... 12.45  
Rim Knob lock sets ..... 1.80  
Butts, dull brass plated on steel, 3/2x3 1/2 ..... .76

**CONCRETE AGGREGATES—**

The following prices net to Contractors unless otherwise shown. Carload lots only.

	Bunker per ton	Del'd per ton
Gravel, all sizes	\$2.44	\$2.90
Top Sand	2.38	3.13
Concrete Mix	2.38	3.06
Crushed Rock, 1/4" to 3/4"	2.38	2.90
Crushed Rock, 3/4" to 1 1/2"	2.38	2.90
Roofing Gravel	2.81	2.90
River Sand	2.50	3.00

Sand—  
Lepis (Nos. 2 & 4) ..... 3.56 3.94  
Olympia (Nos. 1 & 2) ..... 3.56 3.88

**Cement—**  
Common (all brands, paper sacks), Per Sack, small quantity (paper) .....\$1.05  
Carload lots, in bulk per bbl. .... 3.55  
Cash discount on carload lots, 10c a bbl., 10th Prox., less than carload lots \$4.00 per bbl. f.o.b. warehouse or delivered.  
Cash discount 2% on L.C.L.

Trinity White { 1 to 100 sacks, \$3.50 sack  
warehouse or del.;  
Medusa White { 100 to 500 sacks, \$3.50 sack  
warehouse or del.

**CONCRETE READY-MIX—**

Delivered in 4-yd. loads:  
Per cubic yard, 1-8 Mix .....\$ 9.80  
1-7 Mix ..... 10.15  
1-6 Mix ..... 10.70  
1-5 Mix ..... 11.40

Curing Compound, clear, drums, per gal. .... 1.03

**CONCRETE BLOCKS—**

	Haydite	Be-salt
4x8x16-inches, each	\$ .19	\$ .19
6x8x16-inches, each	.23	.235
8x8x16-inches, each	.27	.27
12x8x16-inches, each	.38	.40
12x8x24-inches, each	.....	.60

**Haydite Aggregates—**  
3/4-inch to 1/2-inch, per cu. yd. ....\$7.75  
1/2-inch to 3/8-inch, per cu. yd. .... 7.75  
No. 6 to 0-inch, per cu. yd. .... 7.75

**DAMP-PROOFING and Waterproofing—**

Two-coat work, \$9.00 per square.  
Membrane waterproofing—4 layers of saturated felt, \$10.00 per square.  
Hot coating work, \$5.00 per square.  
Medusa Waterproofing, \$3.50 per lb. San Francisco Warehouse.  
Tricoisel concrete waterproofing, 60c a cubic yd. and up.

**ELECTRIC WIRING—\$15 to \$20 per outlet for conduit work (including switches).  
Knob and tube average \$6.00 per outlet.**

**ELEVATORS—**

Prices vary according to capacity, speed and type. Consult elevator companies. Average cost of installing a slow speed automatic passenger elevator in small four story apartment building, including entrance doors, about \$9,500.00.

**EXCAVATION—**

Sand, \$1.00; clay or shale, \$1.50 per yard.  
Trucks, \$30 to \$45 per day.  
Above figures are an average without water. Steam shovel work in large quantities, less; hard material, such as rock, will run considerably more.

**FIRE ESCAPES—**

Ten-foot galvanized iron balcony, with stairs, \$250 installed on new buildings; \$300 on old buildings.

**FLOORS—**

Asphalt Tile, 1/8 in. gauge 18c to 35c per sq. ft.  
Composition Floors, such as Magnesite 40c-\$1.25 per sq. ft.  
Linoleum, standard gauge, sq. yd. ....\$2.75  
Mastipave—\$1.50 per sq. yd.  
Battleship Linoleum—1/8"—\$3.00 sq. yd.  
Terrazo Floors—\$2.00 per sq. ft.  
Terrazo Steps—\$2.50 per lin. ft.  
Mastic Wear Coat—according to type—20c to 35c.  
Hardwood Flooring—  
Oak Floor.—T & G—Unfin.—

	1 1/2 x 2	1/2 x 2	3/4 x 2	1 x 2
Clear Old, White	\$4.25	\$4.05	\$	\$
Select Old, Red or White	355	340		
Clear Pln., Red or White	355	340	335	315
Select Pln., Red or White	340	330	325	300
#1 Common, Red or White	315	310	305	280
#2 Common, Red or White	305			

**Refinished Oak Flooring—**

	Prime	Standard
1/2 x 2	\$369.00	\$359.00
3/4 x 2 1/2	360.00	370.00
1 x 2 1/2	390.00	400.00
1 1/2 x 2 1/2	375.00	355.00
1 1/2 x 3	395.00	375.00
1 1/2 x 2 1/4 & 3/4 Ranch Plank		415.00

**Unfinished Maple Flooring—**

3/8 x 2 1/4 First Grade	\$390.00
3/8 x 2 1/4 2nd Grade	365.00
3/8 x 2 1/4 2nd & Btr. Grade	375.00
3/8 x 2 1/4 3rd Grade	380.00
3/8 x 3/4 3rd & Btr. Jtd. EM	390.00
3/8 x 3/2 2nd & Btr. Jtd. EM	400.00
33/32 x 2 1/4 First Grade	360.00
33/32 x 2 1/4 2nd Grade	320.00
33/32 x 2 1/4 3rd Grade	320.00

Floor Layer Wage \$2.60 hr.

**GLASS—**

Single Strength Window Glass .....\$ .30 per sq. ft.  
Double Strength Window Glass ..... .45 per sq. ft.  
Plate Glass, 1/4 polished to 75 ..... 1.60 per sq. ft.  
75 to 100 ..... 1.74 per sq. ft.  
1/4 in. Polished Wire Plate Glass ..... 2.50 per sq. ft.  
1/4 in. Rgh. Wire Glass ..... .80 per sq. ft.  
1/2 in. Obscure Glass ..... .44 per sq. ft.  
1/2 in. Obscure Glass ..... .63 per sq. ft.  
1/2 in. Heat Absorbing Obscure ..... .54 per sq. ft.  
1/2 in. Heat Absorbing Wire ..... .72 per sq. ft.  
1/2 in. Ribbed ..... .44 per sq. ft.  
1/2 in. Ribbed ..... .63 per sq. ft.  
1/2 in. Rough ..... .44 per sq. ft.  
1/2 in. Rough ..... .30 per sq. ft.  
Lazing of above additional \$15 to 35 per sq. ft.  
Glass Blocks, set in place ..... 3.50 per sq. ft.

**HEATING—**

**Furnaces— Gas Fired**  
Floor Furnace, 25,000 BTU .....\$ 70.50  
35,000 BTU ..... 77.00  
45,000 BTU ..... 90.50  
Automatic Control, Add ..... 39.00  
Dual Wall Furnaces, 25,000 BTU ..... 91.50  
35,000 BTU ..... 99.00  
45,000 BTU ..... 117.00  
With Automatic Control, Add ..... 39.00  
Unit Heaters, 50,000 BTU ..... 202.00  
Gravity Furnace, 65,000 BTU ..... 198.00  
Forced Air Furnace, 75,000 BTU ..... 313.50  
**Water Heaters— 5-year guarantee**  
With Thermostat Control, ..... 87.50  
20 gal. capacity ..... 103.95  
30 gal. capacity ..... 119.00  
40 gal. capacity ..... 120.00

## INSULATION AND WALLBOARD—

Rockwool Insulation—	
(2") Less than 1,000 sq. ft.	\$64.00
(2") Over 1,000 sq. ft.	59.00
Cotton Insulation—Full thickness (3")	\$95.50 per M sq. ft.
Silestone Aluminum Insulation—Aluminum coated on both sides	\$23.50 per M sq. ft.
Tileboard—4"x6" panel	\$9.00 per panel
Wallboard—1/2" thickness	\$55.00 per M sq. ft.
Finished Plank	\$67.00 per M sq. ft.
Ceiling Tileboard	\$69.00 per M sq. ft.

IRON—Cost of ornamental iron, cast iron, etc., depends on designs.

## LUMBER—

S4S No. 2 and better common O.P. or D.F., per M, f.b.m.	\$100.00
Rough, No. 2 common O.P. or D.F., per M, f.b.m.	95.00

## Flooring—

V.G.-D.F. 8 & 8tr. 1 x 4 T & G Flooring	\$225.00
"C" and better—all	225.00
"D" and better—all	225.00
Rwd. Rustic—"A" grade, medium dry, 8 to 24 ft.	185.00

Plywood, per M sq. ft.	
1/4-inch, 4,0x8-0-515	\$135.00
1/2-inch, 4,0x8-0-515	219.00
3/4-inch, per M sq. ft.	292.00
Plyscrod	11 1/2¢ per ft.
Plyform	25¢ per ft.

Shingles (Rwd. not available)—	
Red Cedar No. 1—\$9.50 per square; No. 2, \$7.00; No. 3, \$5.00.	
Average cost to lay shingles, \$6.00 per square	
Cedar Shakes—1/2" to 3/4" x 24/26 in handsplit tapered or split resawn, per square	\$15.25
3/4" to 1 1/4" x 24/26 in split resawn, per square	17.00
Average cost to lay shakes, 8.00 per square	
Pressure Treated Lumber—	
Wolmanized	Add \$35 per M to above
Cresoted,	
8 lb. treatment	Add \$45 per M to above

## MARBLE—(See Dealers)

METAL LATH EXPANDED—	
Standard Diamond, 3/40, Copper Bearing, L.C.L. per 100 sq. yds.	\$43.50
Standard Ribbed, ditto.	\$47.50

MILLWORK—Standard, D. F. \$150 per 1000, R. W. Rustic \$175 per 1000 (delivered).

Double hung box window frames, average with trim, \$12.50 and up, each.	
Complete door unit, \$15 to \$25.	
Screen doors, \$8.00 to \$12.00 each.	
Patent screen windows, \$1.25 e sq. ft.	
Cases for kitchen pantries seven ft. high, per lineal ft., upper \$9.00 to \$11.00; lower \$12.00 to \$13.00.	

Dining room cases, \$20.00 per lineal foot.	
Rough end finish about \$1.00 per sq. ft.	
Labor—Rough carpentry, warehouse heavy framing (average), \$75.00 per M.	
For smaller work average, \$85.00 to \$100. per 1000.	

## PAINTING—

Two-coat work	per yard 85¢
Three-coat work	per yard \$1.10
Cold-water painting	per yard 25¢
Whitewashing	per yard 15¢

Unsead Oil, Strictly Pure (Basis 7 1/2 lbs. per gal.)	Wholesale	Bolled
Light iron drums	per gal. \$2.28	\$2.34
5-gallon cans	per gal. 2.40	2.46
1-gallon cans	each 2.52	2.58
Quart cans	each .71	.72
Pint cans	each .38	.39
1/2-pint cans	each .24	.24
Turpentine	Pure Gum	
(Basis, 7.2 lbs. per gal.)	Spilts	
Litred iron drums	per gal. \$1.65	
5-gallon cans	per gal. 1.76	
1-gallon cans	each 1.88	
Quart cans	each .54	
Pint cans	each .31	
1/2-pint cans	each .20	

## Pioneer White Lead in Oil Heavy Paste and All-Purpose (Soft-Paste)

Net Weight	per 100 Pkgs.	Price to Painters
Packages	lbs.	pkgs.
100-lb. kegs	\$28.35	\$29.35
50-lb. kegs	30.05	15.03
25-lb. kegs	30.35	7.59
5-lb. cans*	33.35	1.34
1-lb. cans*	36.00	.36
500 lbs. (one delivery)		3¢ per pound less than above.

\*Heavy Paste only.  
Pioneer Dry White Lead—Litharge—Dry Red Lead—Red Lead in Oil

Price to Painters—Price per 100 Pounds			
Products	100 lbs.	50 lbs.	25 lbs.
Dry White Lead	\$26.30	\$7.	\$4.
Litharge	25.95	26.80	26.90
Dry Red Lead	27.20	28.85	28.15
Red Lead in Oil	30.65	31.30	31.60
Pound cans, \$37 per lb.			

## PATENT CHIMNEYS—

6-inch	\$2.50 lineal foot
8-inch	\$3.00 lineal foot
10-inch	4.00 lineal foot
12-inch	5.00 lineal foot

## PLASTER—

Neat wall, per ton delivered in S. F. in paper bags, \$17.60.

## PLASTERING (Interior)—

3 Coats, metal lath and plaster	Yard \$3.00
Keene cement on metal lath	3.50
Ceilings with 3/4" hot roll channels metal lath (lathed only)	3.00
Ceilings with 3/4" hot roll channels metal lath plastered	4.50
Single partition 3/4" channel lath 1 side (lath only)	3.00
Single partition 3/4" channel lath 2 inches thick plastered	8.00
4-inch double partition 3/4" channel lath 2 sides (lath only)	5.75
4-inch double partition 3/4" channel lath 2 sides plastered	8.75
Thermax single partition; 1" channels; 2 1/4" overall partition width. Plastered both sides	7.50
Thermax double partition; 1" channels; 4 1/4" overall partition width. Plastered both sides	11.00
3 Coats over 1" Thermax nailed to one side wood studs or joists	4.50
3 Coats over 1" Thermax suspended to one side wood studs with spring sound insulation clip	5.00
Note—Channel lath controlled by limitation orders.	

## PLASTERING (Exterior)—

2 coats cement finish, brick or concrete wall	Yard \$2.50
3 coats cement finish, No. 18 gauge wire mesh	3.50
Time—\$4.00 per bbl. at yard.	
Proceded Lime—\$14.15 per bbl. at yard.	
Rock or Grip Lath—3/8"—30¢ per sq. yd.	
"—29¢ per sq. yd.	
Composition Stucco—\$4.00 sq. yerd (applied).	

## PLUMBING—

From \$200.00 per fixture up, according to grade, quality and runs.

## ROOFING—

"Standard" tar end gravel, 4 ply	\$13.00
per sq. for 30 sqs. or over.	
Less than 30 sqs. \$16.00 per sq.	
Tile \$40.00 to \$50.00 per square.	
No. 1 Redwood Shingles in place.	
4 1/2 in. exposure, per square	\$18.25
5/2 No. 1 Cedar Shingles, 5 in. exposure, per square	14.50
5/8 x 16"—No. 1 Little Giant Cedar Shingles, 5" exposure, per square	18.25
4/2 No. 1-24" Royal Cedar Shingles 7 1/2" exposure, per square	23.00
Re-coat with Gravel \$5.50 per sq.	

Asbestos Shingles, \$27 to \$35 per sq. laid.	
1/2 to 3/4 x 25" Resawn Cedar Shakes, 10" Exposure	\$30.00
3/4 to 1 1/4 x 25" Resawn Cedar Shakes, 10" Exposure	\$35.00
1 x 25" Resawn Cedar Shakes, 10" Exposure	22.00
Above prices are for shakes in place.	

## SEWER PIPE—

C.I., 6-in. to 24-in. B. & S. Class B and heavier, per ton	\$99.50
Vitrified, per foot: L.C.L. F.O.B. Warehouse, San Francisco.	
Standard, 8-in.	\$.66
Standard, 12-in.	1.30
Standard, 24-in.	5.41
Clay Drain Pipe, per 1,000 L.F. L.C.L., F.O.B. Warehouse, San Francisco:	
Standard, 6-in. per M.	\$240.00
Standard, 8-in. per M.	400.00

## SHEET METAL—

Windows—Metal, \$2.50 e sq. ft.	
Fire doors (average), including hardware \$2.80 per sq. ft., size 12'x12', \$3.75 per sq. ft., size 3'x6'.	

## SKYLIGHTS—(not glazed)

Galvanized iron, per sq. ft.	\$1.25
Vented hip skylights, per sq. ft.	2.25
Aluminum, puttysless, (unglazed), per sq. ft.	1.25
(installed end glazed), per sq. ft.	1.85

## STEEL—STRUCTURAL—

\$290 per ton erected, when out of mill. \$350 per ton erected, when out of stock.

## STEEL REINFORCING—

\$200.00 per ton, in place.	
1/2-in. Rd. (Less than 1 ton) per 100 lbs.	\$8.90
3/4-in. Rd. (Less than 1 ton) per 100 lbs.	7.80
1/2-in. Rd. (Less than 1 ton) per 100 lbs.	7.50
3/8-in. Rd. (Less than 1 ton) per 100 lbs.	7.25
3/4" & 7/8-in. Rd. (Less than 1 ton)	7.15
1-in. & up (Less than 1 ton)	7.10
1 ton to 5 tons, deduct 25¢.	

## STORE FRONTS—

Individual estimates recommended. See ESTIMATORS DIRECTORY for Architectural Veneer (3), and Mosaic Tile (35).

## TILE—

Ceramic Tile Floors—Commercial	\$1.20 to \$1.60 per sq. ft.
Cove Base—\$1.40 per lin. ft.	
Quarry Tile Floors, 6x6" with 6" base @ \$1.35 per sq. ft.	
Tile Wainscots & Floors, Residential, 4 1/4 x 4 1/4", @ \$1.65 to \$2.00 per sq. ft.	
Tile Wainscots, Commercial Jobs, 4 1/4 x 4 1/4", Tile, @ \$1.50 to \$1.65 per sq. ft.	
Asphalt Tile Floor 1/4" x 7 1/2" x 7 1/2" \$ .18 - \$ .35 sq. yd.	
Light shades, slightly mauer.	
Cork Tile—\$.70 per sq. ft.	
Mosaic Floors—See dealers	
Non-slip tile, per sq. ft.	\$.65
Rubber tile, per sq. ft.	\$.55 to \$.75
Furring Tile	
Scored 12 x 12 Each	F.O.B. S. F. \$.17
Kraffite: Per square foot	Small Large
Pat. Tile—Niles Red	Lots Lots
12 x 12 x 3/8-inch, plain	\$ .40 \$ .36
6 x 12 x 3/8-inch, plain	.44 .39
6 x 6 x 3/8-inch, plain	.46 .42

## Building Tile—

8 1/2 x 12 inches, per M	\$139.50
6 1/2 x 12 inches, per M	105.00
4 1/2 x 12 inches, per M	84.00
Hollow Tile—	
12 x 12 1/2 inches, per M	\$146.75
12 x 2 1/2 inches, per M	154.85
12 x 2 1/4 inches, per M	177.10
12 x 1 1/2 inches, per M	235.30
F.O.B. Plant	

## VENETIAN BLINDS—

75¢ per square foot end up. Installation extra

## WINDOWS—STEEL—INDUSTRIAL

Cost depends on design and quality required.



# ARCHITECT AND ENGINEER

# ESTIMATOR'S DIRECTORY

## Building and Construction Materials

**EXPLANATION**—Building and construction materials are shown in major classified groups for general identification purposes with names and addresses of suppliers of materials listed in detail under group classification where name first appears—main offices are shown first with branch or district offices following. The numeral appearing in listings \*(3) refers to the major group classification where complete data on the dealer, or representative, may be found.

<b>ADHESIVES (1)</b> Wall and Floor Tile Adhesives THE CAMBRIDGE TILE MFG. CO. *(35)	<b>CEMENT (10)</b> IDEAL CEMENT COMPANY (Pacific Division) San Francisco 4: 310 Sansome St., GA 1-4100 PACIFIC COAST AGGREGATES, INC. *(111)	<b>HEATING (17)</b> S. T. JOHNSON CO. Oakland 8: 940 Arlington Ave., OL 2-6000 San Francisco: 585 Potrero Ave., MA 1-2757 Philadelphia 8, Pa.: 401 N. Broad St.
<b>AIR CONDITIONING (2)</b> Air Conditioning & Cooling UTILITY APPLIANCE CORP. Los Angeles 58: 4851 S. Alameda St. San Francisco: 1355 Market St., UN 1-4908	<b>CONCRETE AGGREGATES (11)</b> Ready Mixed Concrete PACIFIC COAST AGGREGATES, INC. San Francisco: 400 Alabama St., KL 2-1616 Sacramento: 16th and A Sts., GI 3-6586 San Jose: 790 Stockton Ave., CY 2-5620 Oakland: 2400 Peralta St., GL 1-0177 Stockton: 820 So. California St., ST 8-8643	<b>SCOTT COMPANY</b> San Francisco: 243 Minna St., YU 2-0400 Oakland: 113 - 10th St., GL 1-1937 San Jose, Calif. Los Angeles, Calif.
<b>ARCHITECTURAL VENEER (3)</b> Ceramic Veneer GLADDING, McBEAN & CO. San Francisco: Harrison at 9th St., UN 1-7400 Los Angeles: 2901 Los Feliz Blvd., OL 2121 Portland: 110 S.E. Main St., EA 6179 Seattle: 1500 First Ave. S., EL 4711 Spokane: 1102 N. Monroe St., BR 3259 THE CAMBRIDGE TILE MFG. CO. *(35)	<b>Lightweight Aggregates</b> AMERICAN PERLITE CORP. Richmond: 26th & B. St. - Yd. 2, RI 4307	<b>UTILITY APPLIANCE CORP. *(2)</b> Electric Heaters WESIX ELECTRIC HEATER CO. San Francisco: 390 First St., GA 1-2211 Los Angeles: 520 W. 7th St., MI 8096 Portland: Terminal Sales Bldg., BE 2050 Seattle: Securities Bldg., SE 5028
<b>Porcelain Veneer</b> PORCELAIN ENAMEL PUBLICITY BUREAU Oakland 12: Room 601 Franklin Building Pasadena 8: P. O. Box 186, East Pasadena Station	<b>DOORS (12)</b> Hollywood Doors WEST COAST SCREEN CO. Los Angeles: 1127 E. 63rd St., AD 1-1108 W. P. FULLER CO. Seattle, Tacoma, Portland	<b>Designer of Heating</b> THOMAS B. HUNTER San Francisco 4: 41 Sutter St., GA 1-1164
<b>Granite Veneer</b> VERMONT MARBLE COMPANY San Francisco 5: 525 Market St., SU 1-6747 Los Angeles: 3522 Council St., DU 2-7834	<b>NICOLAI DOOR SALES CO.</b> San Francisco: 3045 19th St. F. M. COBB CO. Los Angeles & San Diego SOUTHWESTERN SASH & DOOR Phoenix, Tucson, Arizona El Paso, Texas HOUSTON SASH & DOOR Houston, Texas	<b>INSULATION AND WALL BOARD (18)</b> LUMBER MANUFACTURING CO. San Francisco: 225 Industrial Ave., JU 7-1760 PACIFIC COAST AGGREGATES, INC. *(111) SISALKRAFT COMPANY *(9)
<b>Marble Veneer</b> VERMONT MARBLE COMPANY San Francisco 5: 525 Market St., SU 1-6747 Los Angeles: 3522 Council St., DU 2-7834	<b>Screen Doors</b> WEST COAST SCREEN DOOR CO. (See above)	<b>WESTERN ASBESTOS COMPANY</b> San Francisco: 675 Townsend St., KL 2-3868 Oakland: 251 Fifth Avenue, GL 1-2345 Stockton: 733 S. Van Buren, ST 4-9421 Sacramento 1331 - T St., HU 1-0125 Fresno: 434 - P St., FR 2-1600
<b>BANKS - FINANCING (4)</b> CROCKER FIRST NATIONAL BANK OF S. F. San Francisco, Post & Montgomery Sts., EX 2-7700	<b>FIRE ESCAPES (13)</b> MICHEL & PFEFFER IRON WORKS, INC. South Linden & Tanforan Ave. South San Francisco: JU 4-8362	<b>IRON—Ornamental (10)</b> MICHEL & PFEFFER IRON WORKS, INC. *(13)
<b>BATHROOM FIXTURES (5)</b> Metal THE CAMBRIDGE TILE MFG. CO. *(35)	<b>FIREPLACES (14)</b> Heat Circulating SUPERIOR FIREPLACE CO. Los Angeles: 1708 E. 15th St., PR B399 Baltimore, Md.: 601 No. Point Rd.	<b>LANDSCAPING (20)</b> Landscape Contractors HENRY C. SOTO CORP. Los Angeles: 13,000 S. Avalon Blvd., ME 4-6617
<b>Ceramic</b> THE CAMBRIDGE TILE MFG. CO. *(35)	<b>FLOORS (15)</b> Hardwood Flooring HOGAN LUMBER COMPANY Oakland: Second and Alice Sts., GL 1-6861	<b>LIGHTING FIXTURES (21)</b> SMOOT-HOLMAN COMPANY Inglewood, Calif., OR 8-1217 San Francisco: 55 Mississippi St., MA 1-8474
<b>BRASS PRODUCTS (6)</b> GREENBERG'S, M. & SONS San Francisco 7: 765 Folsom, EX 2-3143 Los Angeles 23: 1258 S. Boyle, AN 3-7108 Seattle 4: 1016 First Ave. So., MA 5140 Phoenix: 3009 N. 19th Ave., Apt. 92, PH 2-7663 Portland 4: 510 Builders Exch. Bldg., AT 6443	<b>Floor Tile</b> GLADDING, McBEAN & CO. *(13) KRAFTILE *(35) Floor Tile (Ceramic Mosaic) THE CAMBRIDGE TILE MFG. CO. *(35) Floor Treatment & Maintenance HILLYARD SALES CO. (Western) San Francisco: 470 Alabama St., MA 1-7766 Los Angeles: 923 E. 3rd, TR 8282 Seattle: 3440 E. Marginal Way	<b>LUMBER (22)</b> Shingles LUMBER MANUFACTURING CO. *(18)
<b>BRICKWORK (7)</b> Face Brick GLADDING, McBEAN & CO. *(13) KRAFTILE *(35) REMILLARD-DANOJNI CO. San Francisco 4: 400 Montgomery St., EX 2-4988	Diversified (Magnesite, Asphalt Tile, Composition, etc.) LE ROY OLSON CO. San Francisco 10: 3070 - 17th St., HE 1-0188 Sleepers (composition) LE ROY OLSON CO.	<b>MARBLE (23)</b> VERMONT MARBLE COMPANY San Francisco 5: 525 Market St., SU 1-6747 Los Angeles 4: 3522 Council St., DU 2-7834
<b>BRONZE PRODUCTS (8)</b> GREENBERG'S, M. & SONS *(16)	<b>GLASS (16)</b> W. P. FULLER COMPANY San Francisco: 301 Mission St., EX 2-7151 Los Angeles, Calif. Portland, Ore.	<b>METAL LATM EXPANDED (24)</b> PACIFIC COAST AGGREGATES, INC. *(111)
<b>BUILDING PAPERS &amp; FELTS (9)</b> ANGIER PACIFIC CORP. San Francisco 5: 55 New Montgomery St., DO 2-4416 Los Angeles: 7424 Sunset Blvd. PACIFIC COAST AGGREGATES, INC. *(111) SISALKRAFT COMPANY San Francisco 5: 55 New Montgomery St., EX 2-3066 Chicago, Ill.: 205 West Wacker Drive		<b>MILLWORK (25)</b> LUMBER MANUFACTURING COMPANY *(18) MULLEN MANUFACTURING COMPANY San Francisco: 60-80 Rausch St., UN 1-5815 PACIFIC MANUFACTURING COMPANY San Francisco: 16 Beale St., GA 1-7755 Santa Clara: 2610 The Alameda, SC 607 Los Angeles, 6820 McKinley Ave., TH 4196
<b>BUILDING HARDWARE (9a)</b> THE STANLEY WORKS San Francisco: Monadnock Bldg., YU 6-5914 New Britain, Conn.		

**PAINTING (26)**

Paint  
W. P. FULLER COMPANY \* (16)

**PLASTER (27)**

Interiors - Metal Lath & Trim  
PACIFIC COAST AGGREGATES, INC. \* (11)  
Exteriors  
PACIFIC PORTLAND CEMENT COMPANY \* (28)

**PLASTER CEMENT (28)**

IDEAL CEMENT COMPANY  
San Francisco: 310 Sansome St., GA 1-4100

**PLUMBING (29)**

THE HALSEY TAYLOR COMPANY  
Redlands, Calif.  
Warren, Ohio  
THE SCOTT COMPANY \* (17)  
HAWES DRINKING FAUCET COMPANY  
Berkeley 10: 1435 Fourth St., LA 5-3341  
CONTINENTAL WATER HEATER COMPANY  
Los Angeles 31: 1801 Pasadena Ave., CA 6178  
SIMONDS MACHINERY COMPANY  
San Francisco: 816 Folsom St., DO 2-6794  
Los Angeles: 455 East 4th St., MU 8322  
SECURITY VALVE COMPANY  
Los Angeles 31: 410 San Fernando Rd., CA 6191

**RESILIENT TILE (30)**

LE ROY OLSON CO. \* (15)

**SEWER PIPE (32)**

GLADDING, McBEAN & CO. \* (31)

**SHEET METAL (32)****Windows**

DETROIT STEEL PRODUCTS COMPANY  
Oakland 8: 1310 - 63rd St., OL 2-8826  
San Francisco: Russ Building, DO 2-0890  
MICHEL & PFEFFER IRON WORKS, INC. \* (13)  
PACIFIC COAST AGGREGATES, INC. \* (11)

**Fire Doors**

DETROIT STEEL PRODUCTS COMPANY

**Skylights**

DETROIT STEEL PRODUCTS COMPANY

**STEEL-STRUCTURAL (33)**

COLUMBIA STEEL CO.  
San Francisco: Russ Bldg., SU 1-2500  
Los Angeles: 2087 E. Slauson, LA 1171  
Portland: 2345 N. W. Nicolai, BE 7261  
Seattle 1331 3rd Ave. Bldg., MA 1972  
Salt Lake City: Walker Bank Bldg., SL 3-6733  
HERRICK IRON WORKS  
Oakland: 18th & Campbell Sts., GL 1-1767  
JUDSON PACIFIC-MURPHY CORP.  
Emeryville: 4300 Eastshore Highway, OL 3-1717  
REPUBLIC STEEL CORP.  
San Francisco: 116 N. Montgomery St., GA 1-0977  
Los Angeles: Edison Building  
Seattle: White-Henry-Stuart Building  
Salt Lake City: Walker Bank Building  
Denver: Continental Oil Building  
SAN JOSE STEEL COMPANY  
San Jose 195 North Thirtieth St., CO 4184

**STEEL-REINFORCING (34)**

REPUBLIC STEEL CORP. \* (33)  
HERRICK IRON WORKS \* (33)  
SAN JOSE STEEL CO. \* (33)  
COLUMBIA STEEL CO. \* (33)

**CLAY TILE (35)**

THE CAMBRIDGE TILE MFG. CO.  
San Francisco 10: 470 Alameda St., UN 3-1666  
Los Angeles 19: 1335 S. La Brea, WE 3-7800  
GLADDING, McBEAN & CO. \* (3)  
KRAFTILE  
Niles, Calif.: Niles 3611  
San Francisco 5: 50 Hawthorne St., DO 2-3780  
Los Angeles 13: 406 South Main St., MU 7241

**TIMBER-REINFORCING (36)****Trusses**

WYERHAEUSER SALES CO.  
Tacoma, Wash.  
St. Paul, Minn.  
Newark, N. J.

**Treated Timber**

J. H. BAXTER CO.  
San Francisco 4: 333 Montgomery St., DO 2-3883  
Los Angeles 13: 601 West Fifth St., MI 6294

**WALL TILE (37)**

THE CAMBRIDGE TILE MFG. CO. \* (35)  
GLADDING, McBEAN & CO. \* (3)  
KRAFTILE COMPANY \* (35)

**WINDOWS STEEL (38)**

DETROIT STEEL PRODUCTS CO. \* (32)  
MICHEL & PFEFFER IRON WORKS, INC. \* (13)  
PACIFIC COAST AGGREGATES, INC. \* (11)

**GENERAL CONTRACTORS (39)**

BARRETT & HILP  
San Francisco: 918 Harrison St., DO 2-0700  
Los Angeles: 234 W. 37th Place, AD 3-8161  
DINWIDDIE CONSTRUCTION COMPANY  
San Francisco: Crocker Building, YU 4-2718  
CLINTON CONSTRUCTION COMPANY  
San Francisco: 923 Folsom St., SU 1-3440  
MATTOCK CONSTRUCTION COMPANY  
San Francisco: 604 Mission St., GA 1-5516  
PARKER, STEFFENS & PEARCE  
San Francisco: 135 So. Park, EX 2-6639  
STOLTE, INC.  
Oakland: 8451 San Leandro Blvd., TR 2-1D64  
SWINERTON & WALBERG COMPANY  
San Francisco: 225 Bush St., GA 1-2980  
Oakland: 1723 Webster St., HI 4-4322  
Los Angeles, Sacramento, Denver  
P. J. WALKER COMPANY  
San Francisco: 391 Sutter St., YU 6-5916  
Los Angeles: 714 W. Olympic Blvd., RI 7-5251

**TESTING LABORATORIES****(ENGINEERS & CHEMISTS (40))**

ABBOT A. HANKS, INC.  
San Francisco: 624 Sacramento St., GA 1-1697  
ROBERT W. HUNT COMPANY  
San Francisco: 251 Kearny St., EX 2-4634  
Los Angeles: 3050 E. Slauson, JE 9131  
Chicago, New York, Pittsburgh  
PITTSBURGH TESTING LABORATORY  
San Francisco: 651 Howard St., EX 2-1747

**BUILDING TRADES WAGE (JOB SITES) NORTHERN, CENTRAL AND SOUTHERN CALIFORNIA**

ATTENTION: The following are the PREVAILING hourly rates of compensation being paid and in effect by employers by agreement between employees and their union; or as recognized and determined by the U. S. Department of Labor. (September 1, 1952.)

CRAFT	San Francisco		Alameda		Contra Costa		Fresno		Sacramento		San Joaquin		Santa Clara		Solano		Los Angeles		San Bernardino		San Diego		Santa Barbara		Kern				
	\$2.585	\$2.585	\$2.585	\$2.585	\$2.585	\$2.585	\$2.585	\$2.585	\$2.585	\$2.585	\$2.585	\$2.585	\$2.585	\$2.585	\$2.585	\$2.585	\$2.25	\$2.25	\$2.25	\$2.25	\$2.25	\$2.25	\$2.25	\$2.25	\$2.25				
ASBESTOS WORKERS	2.48	2.68	2.48	2.68	2.48	2.68	2.48	2.68	2.48	2.68	2.48	2.68	2.48	2.68	2.48	2.68	2.48	2.68	2.48	2.68	2.48	2.68	2.48	2.68	2.48	2.68			
BOILERMAKERS	3.25	3.25	3.25	3.00	3.00	3.00	3.00	3.00	3.00	3.00	3.00	3.00	3.00	3.00	3.00	3.00	3.00	3.00	3.00	3.00	3.00	3.00	3.00	3.00	3.00	3.00			
BRICKLAYERS, HODCARRIERS	2.45	2.45	2.45	2.00	2.00	2.00	2.40	2.25	2.45	2.45	2.45	2.45	2.45	2.45	2.45	2.45	2.45	2.25	2.25	2.25	2.25	2.25	2.25	2.25	2.25	2.25			
CARPENTERS	2.40	2.60	*2.39	*2.39	*2.39	*2.39	*2.39	*2.39	*2.39	*2.39	*2.39	*2.39	*2.39	*2.39	*2.39	*2.39	2.57	2.57	2.57	2.57	2.57	2.57	2.57	2.57	2.57	2.57	2.57		
CEMENT FINISHERS	2.57	2.57	2.57	2.57	2.57	2.57	2.57	2.57	2.57	2.57	2.57	2.57	2.57	2.57	2.57	2.57	2.57	2.57	2.57	2.57	2.57	2.57	2.57	2.57	2.57	2.57	2.57		
ELECTRICIANS	3.00	3.00	3.00	3.00	3.00	3.00	3.00	2.75	3.00	2.75	3.00	2.75	3.00	2.75	3.00	2.75	2.75	2.75	2.75	2.75	2.75	2.75	2.75	2.75	2.75	2.75			
ELEVATOR CONSTRUCTORS	2.75	2.70	2.45	2.75	2.915	2.915	2.915	2.915	2.915	2.915	2.915	2.915	2.915	2.915	2.915	2.915	2.915	2.25	2.25	2.25	2.25	2.25	2.25	2.25	2.25	2.25			
ENGINEERS: MATERIAL HOIST	2.54	2.54	2.54	2.54	2.54	2.54	2.54	2.54	2.54	2.54	2.54	2.54	2.54	2.54	2.54	2.54	1.9875	1.9875	1.9875	1.9875	1.9875	1.9875	1.9875	1.9875	1.9875	1.9875	1.9875		
GLAZIERS	2.30	2.30	2.30	2.30	2.30	2.30	2.25	2.30	2.30	2.30	2.30	2.30	2.30	2.30	2.30	2.30	2.16	2.16	2.16	2.16	2.16	2.16	2.16	2.16	2.16	2.16	2.16		
IRONWORKERS: ORNAMENTAL	2.55	2.55	2.55	2.55	2.55	2.55	2.55	2.55	2.55	2.55	2.55	2.55	2.55	2.55	2.55	2.55	2.70	2.70	2.70	2.70	2.70	2.70	2.70	2.70	2.70	2.70	2.70		
REINF. RODMEN	*2.45	2.45	2.45	2.45	2.45	2.45	2.45	2.45	2.45	2.45	2.45	2.45	2.45	2.45	2.45	2.45	2.38	2.38	2.38	2.38	2.38	2.38	2.38	2.38	2.38	2.38	2.38		
STRUCTURAL	*2.70	2.70	2.70	2.70	2.70	2.70	2.70	2.70	2.70	2.70	2.70	2.70	2.70	2.70	2.70	2.70	2.70	2.70	2.70	2.70	2.70	2.70	2.70	2.70	2.70	2.70	2.70	2.70	
LABORERS: BUILDING	1.85	1.85	1.85	1.85	1.85	1.85	1.85	1.85	1.85	1.85	1.85	1.85	1.85	1.85	1.85	1.85	1.94	1.94	1.94	1.94	1.94	1.94	1.94	1.94	1.94	1.94	1.94	1.94	
CONCRETE	1.85	1.85	1.85	1.85	1.85	1.85	1.85	1.85	1.85	1.85	1.85	1.85	1.85	1.85	1.85	1.85	1.94	1.94	1.94	1.94	1.94	1.94	1.94	1.94	1.94	1.94	1.94	1.94	
LATHERS	3.00	3.00	3.00	3.00	3.00	3.00	3.00	2.75	3.00	2.75	3.00	2.75	3.00	2.75	3.00	2.75	2.8125	3.125	3.125	3.125	3.125	3.125	3.125	3.125	3.125	3.125	3.125	3.125	
MARBLE SETTERS	2.70	2.70	2.70	2.70	2.70	2.70	2.70	2.70	2.70	2.70	2.70	2.70	2.70	2.70	2.70	2.70	2.70	2.25	2.25	2.25	2.25	2.25	2.25	2.25	2.25	2.25	2.25	2.25	
MOSAIC & TERRAZZO	2.6125	2.6125	2.6125	2.6125	2.6125	2.6125	2.6125	2.6125	2.6125	2.6125	2.6125	2.6125	2.6125	2.6125	2.6125	2.6125	2.40	2.40	2.40	2.40	2.40	2.40	2.40	2.40	2.40	2.40	2.40	2.40	
PAINTERS	*2.60	2.60	2.60	2.60	2.60	2.60	2.60	2.60	2.60	2.60	2.60	2.60	2.60	2.60	2.60	2.60	2.40	2.38	2.56	2.425	2.20	2.20	2.20	2.20	2.20	2.20	2.20	2.20	
PLEDRIVERS	*2.5575	*2.5575	*2.5575	*2.5575	*2.5575	*2.5575	*2.5575	*2.5575	*2.5575	*2.5575	*2.5575	*2.5575	*2.5575	*2.5575	*2.5575	*2.5575	3.00	3.125	3.125	3.125	3.125	3.125	3.125	3.125	3.125	3.125	3.125	3.125	
PLASTERERS	3.125	3.165	3.125	3.125	3.125	3.125	3.00	3.00	3.125	3.00	3.00	3.125	3.00	3.00	3.125	3.00	2.875	2.25	2.25	2.25	2.25	2.25	2.25	2.25	2.25	2.25	2.25	2.25	
PLASTERERS, HODCARRIERS	2.90	2.90	2.875	2.75	2.75	2.75	2.75	2.75	2.75	2.75	2.75	2.75	2.75	2.75	2.75	2.75	2.90	2.90	2.90	2.90	2.90	2.90	2.90	2.90	2.90	2.90	2.90	2.90	2.90
PLUMBERS	2.50	2.50	2.50	2.50	2.50	2.50	2.50	2.50	2.50	2.50	2.50	2.50	2.50	2.50	2.50	2.50	2.45	2.45	2.45	2.45	2.45	2.45	2.45	2.45	2.45	2.45	2.45	2.45	2.45
ROOFERS	2.475	2.475	2.475	2.475	2.475	2.475	2.475	2.475	2.475	2.475	2.475	2.475	2.475	2.475	2.475	2.475	2.475	2.475	2.475	2.475	2.475	2.475	2.475	2.475	2.475	2.475	2.475	2.475	2.475
SHEET METAL WORKERS	2.75	2.70	2.70	2.625	2.625	2.625	2.625	2.625	2.625	2.625	2.625	2.625	2.625	2.625	2.625	2.625	2.75	2.25	2.25	2.25	2.25	2.25	2.25	2.25	2.25	2.25	2.25	2.25	2.25
SPRINKLER FITTERS	2.75	2.90	2.90	2.75	2.875	2.875	2.875	2.875	2.875	2.875	2.875	2.875	2.875	2.875	2.875	2.875	2.90	2.90	2.90	2.90	2.90	2.90	2.90	2.90	2.90	2.90	2.90	2.90	2.90
STEAMFITTERS	1.89	1.99	1.99	1.89	1.89	1.89	1.89	1.89	1.89	1.89	1.89	1.89	1.89	1.89	1.89	1.89	1.89	2.65	2.65	2.65	2.65	2.65	2.65	2.65	2.65	2.65	2.65	2.65	2.65
TRUCK DRIVERS-1/2 Ton or less	2.955	2.955	2.955	2.955	2.955	2.955	2.955	2.955	2.955	2.955	2.955	2.955	2.955	2.955	2.955	2.955	2.65	2.65	2.65	2.65	2.65	2.65	2.65	2.65	2.65	2.65	2.65	2.65	2.65
TILESETTERS	2.955	2.955	2.955	2.955	2.955	2.955	2.955	2.955	2.955	2.955	2.955	2.955	2.955	2.955	2.955	2.955	2.65	2.65	2.65	2.65	2.65	2.65	2.65	2.65	2.65	2.65	2.65	2.65	2.65

\* 6 Hour Day \*\* 7 Hour Day

\*\*\* Before C.I.S.C. for 15c increase.

Prepared and compiled by:

CENTRAL CALIFORNIA CHAPTER ASSOCIATED GENERAL CONTRACTORS OF AMERICA, with the assistance and cooperation of secretaries of General Contractors Associations and Builders Exchanges of Northern California; and the above information for southern California is furnished by the Labor Relations Department of the Southern California Chapter, ASSOCIATED GENERAL CONTRACTORS OF AMERICA

## PEAK VOLUME OF BUSINESS WAS ESTABLISHED DURING PAST YEAR

The construction industry established a new peak of over \$42-billion in volume during 1952, and may well exceed this figure by \$1-billion in 1953, according to Harold R. Berlin, vice-president of Johns-Manville Corpn.

Berlin, general manager of the company's building products division, pointed out recently that construction is now second to "defense" as the nation's leading industry.

"A significant development in the home building industry is its dependence on 'internal migration' and mobility of people to a greater degree than on family formation for its most dynamic impulses.

"The mass exodus from cities to suburbs in 168 standard metropolitan areas during the period from 1940-1950, was some 9,200,000."

In making his analysis of the construction industry, Berlin, divided 1952 into four major divisions; 1) Private new residential, with an expenditure of \$11-billion, representing 1,100,000 new homes; 2) Private Non-Residential, about \$10.7-billion; 3) Public, with \$10.6-billion in governmental, and 4) Modernization with about \$10-billion being spent in this classification.

## BANK OF AMERICA BRANCH

(From Page 29)

source, break upon the surface being finished—was used on interior walls. The result is an effective mottle of attractive pastels. This paint substance dries in less than two hours. Ink, oil and other foreign matter can be wiped off with a damp cloth. The interior ceiling is of acoustic tile.

Entirely new window treatment on the bank level floor was enhanced by use of extruded aluminum sills.

Creating "new looks" for banking institutions is not a novelty for the Capital Company. They have utilized modern architectural trends and ma-

terials in redesigning Central Bank Branches in Oakland and San Leandro and a Bank of America Branch at Fresno.

But at Sacramento, the entirely new character so rapidly and economically given to a building basically of brick—which once housed a Model "T" Ford Agency—will stand as a particular tribute to designers and builders . . . to the Bank of America and to the city.

### HOLLYWOOD JUNIOR COMBINATION SCREEN and METAL SASH DOOR ★ The "WEATHER-WISE" DOOR!!

**A VENTILATING SCREEN DOOR  
A SASH DOOR  
A PERMANENT OUTSIDE DOOR  
ALL 3 IN 1!**

Discriminating home owners and architects have chosen Hollywood Junior as the TRIPLE DOOR VALUE in the COMBINATION SCREEN and METAL SASH DOOR field. A sturdy dependable door, constructed of quality materials, HOLLYWOOD JUNIOR'S EXCLUSIVE PATENTED FEATURES have outmoded old-fashioned screen doors and other doors of its type entirely! . . . . .

**IT GUARANTEES YOU YEAR 'ROUND  
COMFORT, CONVENIENCE and ECONOMY**

WE ALSO MANUFACTURE A COMPLETE LINE OF  
SHUTTERS, C. C. DOORS, SCREENS, SCREEN DOORS, LOUVRE DOORS

## WEST COAST SCREEN CO.

1145 EAST 43rd STREET      ★      L. S. ANGELES, CALIFORNIA  
ADAMS 11108

★      ★      WRITE FOR FREE ILLUSTRATED LITERATURE      ★      ★



# CLASSIFIED ADVERTISING

RATE: 20c PER WORD . . . CASH WITH ORDER

MINIMUM \$5.00

**SUPT., BLDG. DEPT.,** wanted to head Bldg. Dept. of City of Burbank in L. A. C., Calif. Sal. \$683 mo. 5 yrs. admin. exp. in chg. of bldg. proj. is req. Full info. may be secured from Pers. Bd. City Hall, Burbank, Calif.

**BUILDERS!** You can make more money; get information you need before it is published elsewhere; Subscribe to the daily ARCHITECTS REPORTS, only \$10.00 per month. Complete information from ARCHITECTS REPORTS, 68 Post Street, San Francisco. Phone Douglas 2-8311.

**PHOTOGRAPHY.** For the best in construction photography, including exterior and interior, aerial, and progress views . . . you will find as many others have that it's the SKELTON STUDIOS, 875 O'Farrell St., San Francisco. Telephone PRospect 6-1841.

**COLLECTIONS:** For more than a generation—ready to serve you with competent legal staff, your interests protected at all times, efficient service, bonded agents everywhere, no collection no charge. California Material Dealers Service Co., 925 Hearst Bldg., San Francisco, Phone GArfield 1-5634. Ernest T. Langley, Mgr.

**Registered ARCHITECT,** residential and commercial, 17 years experience, seeks association with medium sized firm. Independent work, design, specifications, supervision, client contact. BOX J-3, Architect & Engineer, 68 Post Street, San Francisco, Calif.

**ARCHITECTURAL SLIDING SLEEL SASH.** One lot only — new, half price. 13 units, assorted sizes, 353 square feet total. 3 at

7 ft. x 5 ft.; 4 at 7 ft. x 4½ ft.; 1 at 6 ft. x 4½ ft.; 2 at 6 ft. x 4 ft.; 1 at 7 ft. x 3½ ft.; 1 at 4½ ft. x 3 ft.; 1 at 3 ft. x 3 ft. Phone DELaware 3-7378, San Francisco.

**3-BEDROOM HOMES (New) FOR SALE:** Double garage, hardwood floors, fireplace, tile kitchen and bath. MOVE-IN-NOW, low down payment, Rideout & Buchanan streets, E. Marysville (California) near Camp Beale. RONNE, RONNE & RONNE, 520 9th St., Sacramento, or Phone HUDson 1-0235.

**MODERN FRESCO PAINTINGS ON SLABS** by SIMEON PELENC—Received A.I.A. and Government awards. Approximate size 3 x 4 ft. Suitable for exterior or interior decoration. HELEN PELENC, 1101 Francisco St., San Francisco.



## CONSTRUCTION CONTRACTS AWARDED AND MISCELLANEOUS PERSONNEL DATA

**SANITARY SEWER SYSTEM.** Sewage treatment plant, Salida, Stanislaus County. Salida Sanitary District, owner. \$185,112. ENGINEER: Lawrence Adams, Modesto. Treatment plant, reinforced concrete construction Imhoff tank, oxidation ponds, beds, inlet channel gate structures, etc. GENERAL CONTRACTOR: McGuire & Hester, Oakland.

**TEMPORARY COURTS BUILDING.** Bakersfield, Kern County. County of Kern, owner. 1 story, 24,000 sq. ft., courtrooms, courts, clerk, district attorney offices and law library, \$150,136. ARCHITECT: Robert M. Eddy, Bakersfield. Steel construction, steel roof, concrete, evaporative coolers. GENERAL CONTRACTOR: Earl Hudson, Bakersfield.

**GOODWIN AVE. SCHOOL ADDITION.** Redwood City, San Mateo County. Redwood City Elementary School District, owner. 2 units, 10 classrooms, music, art, speech & toilet rooms, \$247,502. ARCHITECT: Arthur D. Janssen, Menlo Park. Frame & stucco construction. GENERAL CONTRACTOR: Moore & Roberts, San Francisco.

**HOSPITAL ADDITIONS AND ALTERATIONS.** Santa Monica, Los Angeles County. California Lutheran Hospital Society, owner. 3 story wing, 86 beds, surgical facilities, \$526,285. ARCHITECT: Walker, Kalionzes & Klingerman, Los Angeles. Brick and gypsum block masonry construction, concrete work, millwork and metal framing, lathing, plastering, and metal trim, steel and aluminum windows, kalamein doors, fire doors,

hollow metal frames and pressed steel frames, sheet metal, aluminum louvers, composition roofing, insulation, tile work, oxychloride cement terrazzo work, resilient flooring, air conditioning, electrical elevators. GENERAL CONTRACTORS: Choinier & Gumbiner, Los Angeles.

**ELECTRIC-ELECTRONICS SHOP BUILDING.** Mare Island, Solano County. U. S. Navy, owner. 2 & 5 story composite structure of 3 adjoining major integrated structural elements, 350,000 sq. ft., \$4,800,000. ARCHITECT: W. D. Peugh, San Francisco. Foundations of spread footing type, exterior walls partly reinforced concrete, insulated metal siding & concrete masonry blocks. GENERAL CONTRACTOR: Grove, Sheperd, Wilson & Kruege, Inc., San Francisco.

**NEW SCHOOL PLANT.** Topanga, Los Angeles County. Topanga School District, owner. 11 classrooms, multi-purpose building, kindergarten, administrative unit, 19,000 sq. ft., \$234,025. ARCHITECT: Thomas J. Russell, Long Beach. Brick exterior walls. GENERAL CONTRACTOR: Wohl-Galhoun Co., Los Angeles.

**NEW SCHOOL PLANT.** Lakewood Village, Los Angeles County. Long Beach Board of Education, owner. 14 classrooms, 28,000 sq. ft., \$259,800. ARCHITECT: Francis J. Heusel. STRUCTURAL ENGINEER: J. H. Davies, Long Beach. Frame & stucco construction, composition & gravel roofing, transom sash, concrete slab and asphalt tile, convector type heating, ceramic tile toilet rooms. GENERAL CONTRACTOR: Smith-Campbell Co., Long Beach.

**POTRERO TERRACE ANNEX LOW RENT HOUSING PROJECT.** San Francisco. Housing Authority of the City & County of S. F., owner. 172 units, \$1,577,777. ARCHITECT: Ward & Boles, San Francisco. 23 buildings, 3-1 story & basement, 20-2 story & basement, frame & stucco construction. GENERAL CONTRACTOR: Biltwell Construction Co., San Francisco.

**COTTON WAREHOUSE BUILDING ON PIER 92.** San Francisco. Board of State Harbor Commissioners, owner. 1 story, 180 x 400, \$362,547. CHIEF ENGINEER: S. S. Gorman, San Francisco. Structural steel frame, corrugated galvanized steel walls, wood roof, composition roofing, douglas fir piles, steel sash. GENERAL CONTRACTOR: Barrett & Hilo San Francisco.

**FREEMAN MEMORIAL HOSPITAL.** Inglewood, Los Angeles County. Sisters of St. Joseph of Carondelet, owner. 4 stories, \$1,448,000. ARCHITECT AND ENGINEER: Albert C. Martin & Assocs., Los Angeles. Reinforced concrete construction. GENERAL CONTRACTOR J. A. McNeil Co., Inc., Alhambra.

**BLEACHERS AND FIELD LIGHTING.** Los Banos, Merced County. Westside Union High School District, owner. High school bleachers, \$112,960. ARCHITECT: Benjamin J. Lippold, Fresno. Reinforced concrete. GENERAL CONTRACTOR: Walker & Walker, Fresno.

**GYMNASIUM AND INDUSTRIAL ARTS BUILDING.** Whittier, Los Angeles County. Whittier Union High School District, owner. 18,000 sq. ft., \$628,200. ARCHITECT: William H. Harrison, Los Angeles. Reinforced brick construction. GENERAL CONTRACTOR: Kemp Bros., Los Angeles.

**COLD STORAGE BUILDING.** Patterson, Stanislaus County. Patterson Frozen Foods, owner. 1 story, 104 x 120, \$100,000. STRUC-

TURAL ENGINEER: James E. Smith. Structural steel frame, fibreglass insulation, quinite exterior, plastered interior, wood roof, composition roofing. GENERAL CONTRACTOR: Fibreglass Engineer & Supply Co., San Francisco.

**TUBERCULOSIS HOSPITAL AND SENILE WARD.** Phoenix, Arizona. Board of Directors, Arizona State Hospital, owner. 2 additions, 500 beds, 2 stories, \$1,214,092. ARCHITECT: Weaver & Drover, Phoenix. Steel and masonry construction, concrete and tile floors, asphalt tile, metal lath, plaster, metal sash, central heating, refrigerated cooling, insulation. GENERAL CONTRACTOR: Daum-Donaldson, Phoenix.

### LIVERMORE HIGH PLANS ADDITION

The Board of the Livermore Joint Union High School District are completing plans for the addition of 8-classrooms, a library and toilet rooms to the present High School building in Livermore.

Cost of the reinforced concrete, frame and stucco building is estimated at \$200,000. John C. Warnecke, San Francisco, is the architect.

### LOW RENT HOUSING PROJECT AT FRESNO

The Housing Authority of the City of Fresno recently announced plans for the construction of a 150-dwelling unit and community center building as a low-rent housing project in the city at an estimated cost of \$1,200,000.

Robert W. Stevens, and Benjamin F. Lippold, both of Fresno, are the architects for the work.

**LOW RENT HOUSING PROJECTS.** Broderick, Yolo, Knights Landing & Esparto, Yolo County. Housing Authority of the County of Yolo, owner. 80 units & maintenance building, \$603,940. ARCHITECT: J. P. Milano, Berkeley. 1 story, duplex, 2 & 3 bedrooms, frame construction. GENERAL CONTRACTOR: Williams & Burrows, Burlingame; Jay Bailey Co., Woodland.

**EASTSIDE PRIMARY SCHOOL.** McFarland, Kern County. McFarland Union School District, owner. 6 classrooms, double toilet, kindergarten, administration rooms, kitchen, cafeteria, \$138,800. ARCHITECT: Wright, Metcalf & Parsons, Bakersfield. Frame and stucco construction, 18,000 sq. ft., composition roofing, concrete and asphalt tile, radiant heating, air conditioning, insulation, steel sash, sheet metal, steel roof trusses, wood roof trusses, linoleum, ceramic tile. GENERAL CONTRACTOR: Willard K. Michael, Bakersfield.

**CHURCH & PARISH HALL.** Lafayette, Contra Costa County. Roman Catholic Archbishop of S. F., owner. St. Perpetua Parish, \$119,287. ARCHITECT: Vincent G. Roney, San Francisco. 10,000 sq. ft., frame and stucco construction, tile roof. GENERAL CONTRACTOR: Midstate Construction Co., San Francisco.

**ELEMENTARY SCHOOL BUILDING.** Sausalito, Marin County. Sausalito Elementary School District, owner. 8 classrooms, multi-purpose, toilet rooms, \$254,661. ARCHITECT: Hurl, Trudell & Berger, San Francisco. Frame and stucco construction. GENERAL CONTRACTOR: William Horstmeyer Co., San Francisco.

**AVON HEIGHTS ELEMENTARY SCHOOL.** Concord, Contra Costa County. Mt. Diablo Unified School District, owner. 21 classrooms, administration, kindergarten, multi-purpose kitchen, library and toilet rooms, \$448,164. ARCHITECT: Anderson & Simonds, Reynolds & Chamberlain, Conifer & Willie & John Lynn Reid, Oakland. Frame and stucco

## SLEEPERS

**UNI-BOND—PRECAST—  
PERMANENT—NEVER ROT—  
PERMANENTLY  
NAIL PENETRABLE  
FIRE PROOF  
SECURELY BONDED TO  
THE CONCRETE SLAB**

**Make Solid Non-Squeaking  
Permanent Wood Flooring**

Used in spring floor construction for Gymnasiums and dance floors, also under solid wood floor construction. Spaced on any centers desired. Specifications and information available on request.

Territories open for qualified representatives. Free consultation service.

**LeROY OLSON  
COMPANY**

3070 Seventeenth Street,  
San Francisco, California

construction. GENERAL CONTRACTOR: L. Nellson, Orinda.

**DEFENSE TRAILER HOUSING PROJECT**, 29 Palms, California. Public Housing Administration, owner. 250 trailer sites, utility connections, storage building and laundry building, \$226,000. ARCHITECT: J. Dewey Harnish, Ontario. Site and utility improvements, paving roads and walks. GENERAL CONTRACTOR: Campbell Construction & Equipment Co., San Francisco.

**AUDITORIUM AND CAFETERIA BUILDING**, Dr. James Hogan Junior High School, Vallejo, Solano County. Vallejo Unified School District, owner. \$471,650. ARCHITECT: Harry J. Devine, Sacramento. Reinforced concrete and frame construction. GENERAL CONTRACTOR: Herbert A. Crocker Co., San Rafael.

**WARD BUILDING "B"**, San Leandro, Alameda County. County of Alameda, owner. 160 beds and emergency unit, \$1,049,330. ARCHITECT: Will G. Corlett & A. W. Anderson & Winfield Hyde Assoc., Oakland. 3 story, reinforced concrete construction, tile roof, steel sash, 2 elevators, asphalt tile & linoleum floors. GENERAL CONTRACTOR: W. H. Wisheropp Co., Oakland.

**NEW FORT MILLER JUNIOR HIGH SCHOOL**, Fresno, Fresno County. Fresno Board of Education, owner. 12 classrooms, administration, music, art, science, food and clothing, wood and metal shops, gymnasium, combination auditorium and cafeteria, library and toilet rooms, \$1,103,225. ARCHITECT: Franklin & Simpson. Frame and stucco, concrete floors, radiant heating, asphalt tile floors, acoustical tile ceilings. GENERAL CONTRACTOR: Clarence Ward Construction Co., Fresno.

**ELEMENTARY SCHOOL**, Holbrook, Arizona. Navajo Co. Board of Supervisors, owner. 1 story, 10 classrooms, nurses room, teachers room, boiler room, multi-purpose room, toilets, kitchen, offices, \$169,233. ARCHITECT: Lescher & Mahoney, Phoenix. Brick construction, rigid asbestos shingles, asphalt tile, hot water heat, insulation, plaster, sheet metal, steel sash, acoustical tile. GENERAL CONTRACTOR: Borst Construction Co., Phoenix.

**CAPWELLS DEPARTMENT STORE BLDG.**, Walnut Creek, Contra Costa County. McDonald Products Co., owner. 2 story, 100,000 sq. ft., \$1,000,000. ARCHITECT: Welton Beckett & Assoc., Los Angeles. Reinforced concrete construction, escalators, elevators, air conditioning system. GENERAL CONTRACTOR: Dinwiddie Construction Co., San Francisco.

**EXHIBITION BUILDING, TWO ANIMAL EXHIBIT BUILDINGS**—San Jose, Santa Clara County. County of Santa Clara, owner. \$579,323. ARCHITECT: C. J. Ryland, Monterey. Concrete block and laminated wood arches, and transite roof. GENERAL CONTRACTOR: Geo. Bianchi, San Jose.

**CHEMICAL PROCESSING PLANT**, Richland, Washington. U. S. Atomic Energy Commission, owner. \$40,000,000. ARCHITECT & ENGINEER: Vitro Corp. of America, New York City. Construction covers 2 year period. GENERAL CONTRACTOR: Blaw-Knox Co. Chemical Division, Pittsburgh, Pa.

**LOW RENT HOUSING PROJECT**, Gonzales, Monterey County. Housing Authority of the County of Monterey, owner. 20 units, \$165,500. ARCHITECT: Butler, Halm & Waterman, Salinas. Frame and stucco construction. GENERAL CONTRACTOR: Richards Construction Co., Studio City.

**WAREHOUSE & OFFICE**, San Francisco. John M. Stahl, owner. 1 story and mezzanine, 175 x 183, office mezzanine, 40 x 175,

\$160,000. ARCHITECT: Wurster, Bernardi & Emmons, San Francisco. Reinforced concrete, tilt-up construction, structural steel frame, steel sash, composition roofing. GENERAL CONTRACTOR: Midstate Builders, San Francisco.

**COUNTY JAIL ADDITION**, Madera, Madera County. Madera County Board of Supervisors, owner. 2 story and basement, 6,378 sq. ft., \$165,267. ARCHITECT: Horn & Mortland, Fresno. Reinforced concrete to replace condemned portion of existing jail demolition of condemned portion. GENERAL CONTRACTOR: R. W. Brown Construction Co., Madera.

**BLOOMFIELD ELEMENTARY SCHOOL ADDITION**, Arcata, Humboldt County. Arcata Elementary School District, owner. 6 classrooms, administration, kindergarten, multi-purpose, kitchen and toilet rooms, \$243,675. ARCHITECT: Frank T. Georgeson, Eureka. Frame construction. GENERAL CONTRACTOR: C. S. Phillips, Petaluma.

**HAMILTON ELEMENTARY SCHOOL ADDITION**, Campbell, Santa Clara County. Campbell Union Elementary School District, owner. 10 classrooms and toilet rooms. ARCHITECT: Higgins & Root, San Jose. Frame and stucco construction. GENERAL CONTRACTOR: Samuel E. Barth, San Jose.

**DAVID X. MARKS MEN'S RESIDENCE HALL**, Los Angeles, Los Angeles County. University of Southern California, owner. 3 story, house 50 students, 14,920 sq. ft., lounge fireplace, dining room, kitchen, offices, library, rooms housing students, basement, playground, laundry facilities, \$250,000. ARCHITECT: J. E. Stanton and William F. Stockwell, Los Angeles. Reinforced concrete and brick construction, stone trim,

wood sash, cement block, plaster partitions, built-up roof, radiant and forced air heating, multiple showers. GENERAL CONTRACTOR: C. W. Driver, Inc., Los Angeles.

**CAFETERIA BUILDING**, Culver City, Los Angeles County. Culver City Unified School District, owner. 25,300 sq. ft., \$338,600. ARCHITECT: Daniel, Mann, Johnson & Mendenhall, Los Angeles. Frame and stucco, composition roofing, wood beams, brick veneer work, steel sash, cement slab, asphalt tile floors, acoustical work, terrazzo work. GENERAL CONTRACTOR: Beckner Construction Co., Los Angeles.

**BLUE LAKE ELEMENTARY SCHOOL**, Blue Lake, Humboldt County. Blue Lake Union Elementary School District, owner. 9 classrooms, administration, multi-purpose, kindergarten, kitchen and toilet rooms, \$316,000. ARCHITECT: Frank T. Georgeson, Eureka. Frame and stucco construction. GENERAL CONTRACTOR: Ausland & Dodson, Grants Pass, Ore.

**OFFICE BUILDING**, Phoenix, Arizona. Dr. J. N. Harber, owner, 100 x 135 ft., 2 story, \$250,000. ARCHITECT: Weaver & Drover, Phoenix. Concrete lift, slab type construction, slab roofing and floors, air conditioning, insulation, composition roofing, sheet metal, steel sash, tile work, gas fired heating. GENERAL CONTRACTOR: Kitchell-Phillips Constructors, Inc.

**HOUSING PROJECT**, Live Oaks, Sutter County. Housing Authority of the County of Sutter, owner. 30 units, \$214,994. ARCHITECT: Jos. P. Milano, Berkeley. 15 duplexes, 1 story, 2, 3 & 4 bedrooms, wood and frame construction. GENERAL CONTRACTOR: Arthur J. Anderson & Jay Bailey Construction Co., Woodland.

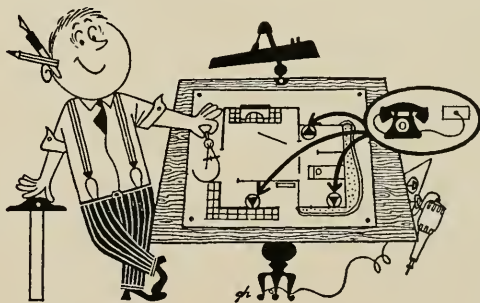

## Built-in telephone facilities will add an "extra" touch to your building plans

It's so easy to make planned telephone facilities a part of your building plans. And clients will appreciate the extra finish that built-in conduit for concealed wiring and conveniently located telephone outlets lend to their home. The cost of installing such facilities is surprisingly low... and it costs nothing to make them a part of your building plans.

Just call Pacific Telephone's free Architects and Builders service. They'll be glad to help you plan telephone facilities for better living tomorrow in the homes you build today.

*Put built-in telephone facilities in your plans*



**Pacific Telephone**



# IN THE NEWS

## OFFERS COURSE IN LIGHT CONSTRUCTION

San Jose State College is offering a course in light building construction in the winter quarter, according to Dr. Ralph J. Smith, head of the engineering department. The courses will be concerned with production and cost control methods used in mass production of housing and the attendant problems of community land planning, site selection, financing, design, and incorporation of technological advances in building operations.

Classes will be held Monday and Wednesday evenings, and will include a series of 18-lectures by leaders in the housing industry and associated professions.

## NAMED TO PLUMBING RESEARCH COMMITTEE

Robert A. Wood, Chief of Engineering Division of the City and County of Los Angeles, has been named a member of the Committee on Plumbing Research of the Building Research Advisory Board, Washington, D.C.

Also named to serve as a member of the BRAE's Committee on Plumbing Problems of War or Disaster is Stephen I. Smoot, Sec.-Treas. Western Plumbing Officials Association of Los Angeles.

The committees were appointed to coordinate and finance a plumbing research program designed to meet the nation's need in an all out mobilization.

## MAGNIFICENT TEXAS

Howdy Howard, of Texas, is building 30-homes in the Northaven Hills section of Dallas to be known as Holiday Homes. Each home will sell for \$40,000 to \$110,000.

BUT, in addition Howdy is equipping each garage with a nice new Cadillac, and the new home owner will find choice meats in the food freezer and groceries on the pantry shelf and in the refrigerator; house completely carpeted and draped, all thrown in as a bonus.

The smaller Holiday homes will have three bedrooms, living room, dining room, two-and-a-half baths, large patio and two-car garage. The larger homes will have four-bedrooms, a den and swimming pool.

## COMMERCIAL STANDARD ON WOOD SHINGLES

Commercial Standard bulletin CS31-52, covering wood shingles is available for distribution according to the Commodity Standards Division of the Office of Industry and Commerce, U. S. Department of Commerce.

Shingles covered by this standard are Western red cedar; Tidewater red cypress; California Redwood. Report covers minimum specifications for the highest commercial grade of sawn wood shingles in grades 1. Also covers length, width, thickness, grain, color, packing, and grading tolerances.

## MEDICAL PROJECT FOR SAN FERNANDO VALLEY

A development combining a general hospital and medical building with private offices for doctors and representing a cost of \$2,000,000, is scheduled for construction on a site on Van Nuys Blvd in the San Fernando Valley.

The project, offering the facilities of a medical center, is being designed by Architects Paul R. Williams and Howard W. Frank of Los Angeles.

## CORONA del MAR BUILDS NEW SCHOOL

A new elementary school is being built in Corona del Mar, at an estimated cost of \$244,975. It is located on a new 17-acre tract, will contain 16-classrooms, two kindergarten rooms, combination cafeteria-auditorium, and an administration unit.

Architects Lind, Plegier & Associates report the new school will be ready for use by September 1953.

## ARCHITECT FOR COMMUNITY HOSPITAL

Architects Stone & Mulloy of San Francisco have been commissioned by the Shafter-Wasco Community Hospital District, Kern county, to draw plans and specifications for the construction of a new Community Hospital to be built in Shafter.

Facilities will provide for a 25-bed hospital.

## NEW WAREHOUSE FOR STOCKTON

The Macco Warehouse Company of Stockton has been granted a Certificate of Necessity and will start immediate construction of two new warehouses next to the Port of Stockton in the City of Stockton.

The buildings will be 150 ft. by 800 ft., reinforced concrete construction and will cost an estimated \$1,125,000.

## FEDERAL FUNDS FOR HIGH SCHOOL

The Vallejo Unified School District has been notified that some \$800,000 of federal funds have been allocated for the construction of a new Junior High School in the Chabot Housing Project near Vallejo.

## ARCHITECT SELECTED

Architect Ernest L. McCoy of Bakersfield has been selected by the Richland Elementary School District board to draft plans and specifications for the construction of a new Elementary School in Shafter, Kern county.

Cost of the additional facilities to the present school building is estimated at \$700,000. Funds for the work were raised through acceptance of a special bond issue by voters of the district.

## STUDY OF BUILDING MATERIALS READIED

A three-day conference to discuss the vast range of basic materials available to manufacturers will be held in New York City on June 16-18, and will supplement the 1st Exposition of Basic Materials for Industry scheduled for the Grand Central Palace, June 15-19.

The combined events will provide the first clearing house of information ever attempted for the entire field of materials for hard goods manufacturing.

## WORLD TRADE CENTER PLANNED

The State Board of Harbor Commissioners, which has jurisdiction of the San Francisco water front, recently announced plans for construction of a World Trade Center in the area just north of the Ferry Building in San Francisco.

The project will cost an estimated \$2,000,000 and will involve the remodeling of the dock and wharf to include a 3-story building containing 142,000 sq. ft. of floor space. When completed the development would be leased to the San Francisco World

Trade Center of which Leland W. Cutler is president.

William G. Merchant of San Francisco has been chosen architect for the project.

## ADDITION TO MONTEREY ENGINEERING SCHOOL

The U. S. Navy has announced construction of additional buildings at the Naval Post Graduate School in Monterey to be used in conjunction with the Navy's Engineering School.

It is estimated the new building will cost \$1,740,000.

## HOSPITAL BONDS ARE APPROVED

Voters of the Sequoia Hospital District of San Mateo county, recently approved issuance of \$800,000 in bonds with funds to be used in the construction of an addition to the Sequoia Hospital in Redwood City.

Construction will comprise addition of a 98-bed wing to the present hospital which will be of concrete construction and 3 stories in height.

Stone & Mulloy, and S. D. Marracini (associated) are the architects.

## WILL SURVEY THE NAVY STRUCTURES

Under a contract between the Bureau of Yards and Docks of the Department of the Navy and the National Academy of Sciences, the Building Research Advisory Board is undertaking a survey of temporary and semi-permanent buildings on Naval establishments.

Purpose of the survey is to assist the Bureau of Yards and Docks in establishing new standards for temporary construction in present and future building programs. Emphasis will be placed on examination of design, construction, materials, details and other pertinent engineering features.

The study will include site improvements, utilities and fire protection.

## SCHOOL BONDS APPROVED

Voters of the Menlo Park Elementary School District approved a school bond issue of \$200,000 recently with funds to be used for the construction of an addition to the Oaknoll Elementary School building in Menlo Park, San Mateo county.

Architect on the project is Kingsford Jones of Menlo Park.

## STEEL FIRM BUYS ROEBLING'S SONS

A wholly-owned subsidiary of the Colorado Fuel & Iron Corp. has contracted for the purchase of the manufacturing business, plants and inventories of John A. Roebling's Sons Company, according to a recent announcement by Charles Allen, Jr., chairman of the Board of the CFI and Charles R. Tyson, president of Roebling.

The Roebling business will be operated as a subsidiary of the CFI under the Roebling name.

## SIMPLIFIED PRACTICE RECOMMENDATION

Simplified Practice Recommendation R3-52, covering the Metal Lath and Metal Plastering Accessories, are available through the Commodity Standards Division of the Office of Industry and Commerce, U.S. Department of Commerce, Washington, D.C.

The recommendation covers various types of metal lath, expanded and sheet, and various metal plastering accessories, giving



## MULLEN MFG. COMPANY

BANK, STORE AND OFFICE  
FIXTURES—CABINET WORK  
OF GUARANTEED QUALITY  
CHURCH SEATING

Office and Factory  
60-80 RAUSCH ST., Bet. 7th and 8th Sts.  
San Francisco  
Telephone UNDERhill 1-5815

STATIONERY  
SCHOOL & OFFICE  
SUPPLIES

Printing Engraving  
Announcements

CENTER STATIONERY

468 McAllister  
San Francisco UN 1-3703

## CLASSIFIED ADVERTISING

Will Bring Results

—USE—

## ARCHITECT and ENGINEER

68 Post St. San Francisco

*Fine*  
**ENGRAVINGS**



**POOR  
RICHARD**  
PHOTO ENGRAVING CO.  
320-324 COMMERCIAL STREET  
SAN FRANCISCO, CALIF.

weight per sq. yd. and sheet size for several kinds of metal lath, and essential information such as size, weight, gage, and length for various kinds of plastering accessories such as channels, corner beads, cornerite, strip lath and similar items.

The revision brings the recommendation into line with current practice as to nomenclature, packaging, weight tolerances, and other details. Basic purpose has been to maintain the unit weights of metal lath, and this has not been changed.

### SCHOOL BONDS VOTED

Voters of the San Carlos Elementary School District, San Mateo county, recently approved \$575,000 in school bonds, with funds to be used in constructing a new Elementary School and making additions to present school buildings.

### NEW VAC-ON ELECTRIC SWITCH IS ANNOUNCED

A new, inexpensive vacuum switch that shuts off power when liquid supply runs dry has been announced by JAYCON Associates of Minneapolis, Minn.

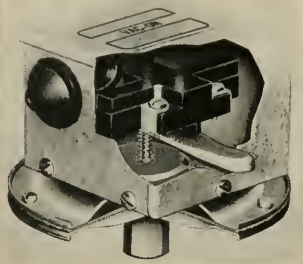

Designed for use with electric motors and gasoline engines, the VAC-ON switch has many uses as a circuit-breaker or control, and also serves as a warning control where operating conditions depend on a vacuum. Switch is mounted on the suction line and wired to power supply—when suction falls below a predetermined pressure switch automatically cuts off motor or engine.

Complete details, prices, from JAYCON, 404 N. Washington Ave., Minneapolis, Minn.

### NEWSPAPER BUILDS NEW PRINTING PLANT

The Monterey Peninsula Herald, Monterey California, has awarded a contract for the construction of a new 1-story, with mezzanine, concrete block and structural building in the City of Monterey at a cost of \$229,000.

The new building has been designed for the uses of a newspaper publishing business by architects Wurster, Bernardi & Emmons of San Francisco, and will be one of the outstanding type of buildings housing a newspaper on the West Coast.

### SCHOOL OF PUBLIC HEALTH BUILDING

The Board of Regents of the U.C. recently announced work would start in the immediate future on the construction of a new School of Public Health Building on the Berkeley campus.

Construction will include a combination three and six story, reinforced concrete building, estimated to cost \$1,125,000.

Masten & Hurd, architectural firm of San Francisco, are designing the building.



## HERRICK IRON WORKS

### STRUCTURAL STEEL REINFORCING STEEL

18TH AND CAMPBELL STS.  
OAKLAND, CALIF.  
Phone GLencourt 1-1767

Phone GARfield 1-1164

## Thomas B. Hunter

DESIGNER OF HEATING

AIR CONDITIONING  
VENTILATING AND WIRING  
SYSTEMS, MECHANICAL  
AND ELECTRICAL EQUIP-  
MENT OF BUILDINGS



41 SUTTER STREET  
ROOM 710

San Francisco California

Subscribe  
Now —

## ARCHITECT and ENGINEER

\$3.00  
Per Year

## DINWIDDIE CONSTRUCTION COMPANY

## BUILDERS

CROCKER BUILDING  
SAN FRANCISCO

**ABBOT A. HANKS, INC.**  
**Engineers & Chemists**

INSPECTING — TESTING — CONSULTING  
CONCRETE • STEEL • MATERIALS  
CHEMICAL AND TESTING  
LABORATORIES  
• RESEARCH AND INVESTIGATION •  
TESTS OF STRUCTURAL MATERIALS  
DESIGN OF CONCRETE MIXES  
SHOP AND ERECTION INSPECTION OF  
STRUCTURES AND EQUIPMENT  
INVESTIGATION OF STRUCTURES  
AND MATERIALS  
TESTS AND INVESTIGATION OF  
FOUNDATION SOILS  
FIRE RESISTANCE AND INSULATION  
TESTS

624 Sacramento Street, San Francisco

**PITTSBURGH**  
**TESTING LABORATORY**

**ENGINEERS AND CHEMISTS**

Testing and Inspection of Concrete,  
Steel and Other Structural Materials

Design of Concrete Mixes

Offices in all principal cities

651 Howard St., San Francisco 5  
EXbrook 2-1747

**MATTOCK**  
**CONSTRUCTION**  
**COMPANY**



**BUILDERS**



604 MISSION STREET  
SAN FRANCISCO

**ARCHITECT**  
and  
**ENGINEER**

Please enter my subscription for  
..... year .. My check in the  
amount of \$..... is attached.  
1 year . . . . \$3.00  
2 years . . . . 5.00

Name .....

City .....

State .....

**Index to Advertisers**

ALLIANCE Engineers ..... 38  
AMERICAN Perlite Corp..... 46  
ANGIER Pacific Corp..... 39  
ARCHITECTS Reports ..... 42  
BARRETT & HILP, Contractors..... 39  
BY-CHEMICAL Products Co..... 35  
CAMBRIDGE Tile Mfg.  
Company ..... \*  
CENTER Stationery ..... 51  
CLAY Brick & Tile Association..... 5  
CLASSIFIED Advertising ..... 43  
CLINTON Construction Company..... 40  
CROCKER First National Bank..... 34  
DINWIDDIE Construction Company..... 51  
FORDERER Cornice Works..... 39  
GLADDING, McBean & Company..... 2 & 3  
GREENSBURG'S, M. Sons..... 37  
HANKS, Abbot A., Inc..... 52  
HAWES Drinking Faucet Co..... 32 & 33  
HERRICK Iron Works..... 51  
HOGAN Lumber Co..... 40  
HUNT, Robert W., Company..... 52  
HUNTER, Thos. B..... 51  
IDEAL Cement Co..... Back Cover  
JOHNSON, S. T. Co..... \*  
JUDSON, Pacific-Murphy Corp..... 36  
KRAFTILE Company ..... 31  
MARBLE Institute of America..... 4  
MATTOCK Construction Co..... 52  
MICHEL & Pfeiffer Iron Works, Inc..... 1  
MODERN Building Specialties Co..... 45  
MULLEN Mfg. Co..... 51  
OLSON, Leroy Co..... 48  
PACIFIC Coast Aggregates..... 31  
PACIFIC Manufacturing Co..... 41  
PACIFIC Telephone & Telegraph Co. 49  
PARKER, Stelfens & Pearce..... 39  
PITTSBURGH Testing Laboratory..... 52  
POOR Richard Engraving Co..... 51  
PORCELAIN Enamel  
(Architectural Division)  
Publicity Bureau ..... 7  
REMILLARD-Dandini Co. .... 52  
REPUBLIC Steel Corporation..... 41  
SCOTT Company ..... 52  
SIMONDS Machinery Company..... 41  
SISALKRAFT Company ..... 36  
SMOOTH-Holman  
Company..... Inside Front Cover  
SOTO, Henry C., Corp.,  
Landscape Engineers ..... 33  
STANLEY Works, The..... 32  
SUMMERBELL Roof Structures..... 36  
U. S. Bonds. .... Inside Back Cover  
UTILITY Appliances Corp'n..... \*  
VERMONT Marble Company..... 41  
WESIX Electric Heater Co. .... \*  
WEST Coast Screen Co. .... 47  
WHITE, Howard J., Inc. .... 38  
\*Indicates Alternate Months

**REMILLARD-DANDINI Co.**

**Brick and  
Masonry Products**



400 MONTGOMERY STREET  
SAN FRANCISCO, CALIF.

**Scott Company**

**HEATING • PLUMBING  
REFRIGERATION**



San Francisco  
Oakland  
San Jose  
Los Angeles

**FOR ADVANCE  
INFORMATION  
ON  
BUILDERS  
CONTRACTORS  
ENGINEERS**

Get

**ARCHITECTS  
REPORTS**

68 Post St. Phone  
San Francisco DO 2-8311

**ROBERT W. HUNT CO.**

**ENGINEERS  
INSPECTING TESTING**

**STRUCTURAL MATERIALS  
CONCRETE MIX DESIGN  
CHEMICAL ANALYSIS  
EQUIPMENT**

PRINCIPAL CITIES  
UNITED STATES • EUROPE  
SAN FRANCISCO LOS ANGELES  
PORTLAND SEATTLE

# ARCHITECT AND ENGINEER

CITIZENS NATIONAL TRUST & SAVINGS BANK—Los Angeles



STILES CLEMENTS, Architects-Engineers

MARCH

1953





Mayfoir School, Fresno  
Franklin & Simpson, Architects



## *Steel Windows & Doors*

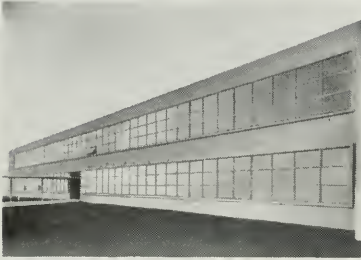

Willow Glen High School, San Jose  
Morsh, Smith & Powell, Architects

ARISTON Steel Windows and Doors are especially designed and constructed to meet the particular requirements of each job.

Michel & Pfeffer engineers are always available to assist architects in their preliminary and final plans.

# *Arislide*

## *Horizontal Sliding Doors*

- Fully Spring Bronze Weatherstripped
- Roller-bearing Bottom Rollers
- Smooth, Quiet Operation
- Bronze Handles and Foot Bolt
- Stainless Steel Capped Track



WRITE FOR LITERATURE: INQUIRIES INVITED

## **Michel & Pfeffer Iron Works**

N. K. JUVET, Manager Steel Window Division

Since 1912

So. East Corner of So. Linden and Tenforan Avenues

South San Francisco • Telephone Juniper 4-8362

# ARCHITECT

VOL. 192

No. 3

# AND ENGINEER

ARCHITECTS' REPORTS—Published Daily

**EDWIN H. WILDER**  
Editor

**J. WELLS HASTINGS**  
Contributing Editor

**PROF. LELAND VAUGHAN**  
Landscape Architecture

**JOHN A. BLUME**  
Structural Engineering

**MICHAEL GOODMAN**  
Planning

**JOHN S. BOLLES, A.I.A.**  
Book Reviews



**CITIZENS NATIONAL TRUST  
& SAVINGS BANK**  
Los Angeles

Designed by the architectural office of Stiles Clements, Architects & Engineers, to serve the needs of a fast growing Southern California university community.

Additional pictures and story appear on page 8.

—Photos by Rothschild.

**ERNEST McAVOY**  
Advertising Manager

*ARCHITECT & ENGINEER*  
is indexed regularly by  
*ENGINEERING INDEX, INC.*

## Contents for

# MARCH

EDITORIAL NOTES . . . . .	2
PUBLIC RELATIONS FOR ARCHITECTS—"Press Relations in Pasadena" . . . . . By Culver Heaton, A.I.A., Pasadena, California	3
NEWS & COMMENT ON ART . . . . .	4
DESIGN OF WELDED STRUCTURES—Described by Van Rensselaer Saxe to Structural Engineers of Southern California . . . . . By Don Wiltse, Executive Secretary	5
CONSULTING ENGINEER DISCUSSES SAN FRANCISCO BUILDING SITES . . . . . Charles H. Lee, Consulting Engineer	5
SOUTHERN CALIFORNIA PRODUCERS' COUNCIL— Meets with A.I.A. Architects . . . . .	6
BONUS LIGHT FROM GROUND REFLECTIONS— And Lumen Method For Calculating Daylight For Interiors . . . . . R. L. Biesele, Jr., and J. W. Griffith	6
GOLDEN GATE PLAYGROUND—Recreation Center, Oakland, Calif. . . . . Reynolds & Chamberlain, Architects	7
CITIZENS NATIONAL TRUST and SAVINGS BANK— New University-Westwood Branch, West Los Angeles, Calif. . . . . Stiles Clements, Architects & Engineers	8
TOWN CHALET—Motor Court, Sherwood Forest Theme; Longview, Wash. . . . . Mr. and Mrs. John R. Erickson, Owners Architect, Lawrence B. Rice. By Arthur W. Prialux	12
THE NEW ATKINS STORE—Modernization of Building, San Mateo, Calif. . . . . Burke, Kober and Nicolais, Architects. Mattock Construction Co., General Contractor	18
A. I. A. ACTIVITIES . . . . .	26
WITH THE ENGINEERS . . . . .	28
PRODUCERS COUNCIL PAGE . . . . . Edited by Phil Brown, Otis Elevator Company	30
BOOK REVIEWS, Pamphlets and Catalogues . . . . .	36
ESTIMATOR'S GUIDE, Building and Construction Materials . . . . .	39
ESTIMATOR'S DIRECTORY, Building and Construction Materials . . . . .	41
BUILDING TRADES WAGE SCALES, Northern, Central & Southern California	42
CLASSIFIED ADVERTISING . . . . .	43
CONSTRUCTION CONTRACTS AWARDED and Miscellaneous Data . . . . .	44
IN THE NEWS . . . . .	46
INDEX TO ADVERTISERS . . . . .	48

**ARCHITECT AND ENGINEER** (Established 1905) is published on the 15th of the month by The Architect and Engineer, Inc., 68 Post St., San Francisco 4; Telephone EXbrook 2-7182. President, K. P. Kierulff; Vice-President and Manager, L. B. Penhorwood; Treasurer, E. N. Kierulff.

Los Angeles Office: Wentworth F. Green, 439 So. Western Ave., Los Angeles 5; Telephone DUnkirk 7-8135.

Entered as second class matter, November 2, 1905, at the Post Office in San Francisco, California, under the Act of March 3, 1879. Subscriptions United States and Pan America, \$3.00 a year; \$5.00 two years; foreign countries \$5.00 a year; single copy 50c. **ARCHITECTS' REPORTS** are published daily from this office, Vernon S. Yallop, Manager. Telephone DOuglas 2-9311.



# EDITORIAL NOTES

## MORE HIGHWAYS NEEDED

A vivid realization of the need for immediate construction of many miles of new highway throughout the nation is obtained by considering that if every motor vehicle owner went out for a ride some Sunday afternoon, there would be a passenger car or truck every twelve yards on every paved street and highway in the nation. A recent study of automobile usage and driver habits shows 1952 ended with a total motor vehicle registration of 53,363,000 vehicles and a total of hard surface road mileage of 356,211 miles.

There is little wonder that in the more concentrated population areas, every day and almost every hour of every day, highway traffic is reaching the bumper-to-bumper category. Accidents are increasing at an alarming rate, causing insurance rates to rise, and time consuming traffic jams and delays are presenting an ever growing problem to traffic engineers, planners, and public highway users.

Highway users are becoming more and more aware of the seriousness of the situation; traffic jams cost millions of dollars in wasted time, and since it is estimated there will be sixty-five and one-half million cars and trucks registered throughout the nation by 1960, there is little chance that today's acute highway problems will diminish any.

The only answer is a rapidly expanded national highway system with a planned program including parking, and intermediate freeway facilities. The time to start such a program should not be delayed.

\* \* \*

*The public weighs the value of a profession by what it produces.*

\* \* \*

## ONE OF YOUR ASSETS!

Has it ever occurred to you that in addition to your professional and technical knowledge; the good will your office has developed through satisfactory service to clients; the time and effort you expend in support of local, regional and national professional association activities; and a host of other personal considerations pertaining to the direct conduct of your professional endeavor, that there are "allied" activities vitally important to the success of your business and profession.

One of these "allied" interests which works tirelessly day-in and day-out, month-in and month-out, and year-in and year-out for the development of your profession is ARCHITECT & ENGINEER magazine. There is not a single issue published

containing specific news and information about you and your profession, that is not distributed to potential clients. The "story" of your business and profession is constantly heralded among prospective users of your service—without one cent cost to you.

Much of the valuable service ARCHITECT & ENGINEER magazine renders to you and your office is because of a close relationship between you and the public—being a "regional" magazine, it is possible to publish a great many "localized" news items that would otherwise never be done. No attempt is made to compete with national publications in presentation of featured articles, however, no national publication presents your efforts in detail comparable to ARCHITECT & ENGINEER magazine.

A recent governmental survey shows that running one's own business is "a hazardous way to make a living," and that fifty per cent of business ventures started between 1946 and 1951 failed, and in some categories only twenty-one per cent reached a fifth birthday. Perhaps a number of failures would not have occurred had the principals involved been aided and supported by "allied" interests.

ARCHITECT & ENGINEER magazine is this year observing its forty-sixth year of continuous publication—nearly a half century of promotion for your profession and your business interests . . . truly, "one of your assets."

\* \* \*

## HOW LONG PROSPERITY?

Times are booming.

People are earning more than ever before in America's history.

Almost everybody who can work has a job.

The big question is—how long will this prosperity last? A good many economists look for prosperity to last through the year, unless there are major developments in foreign affairs, or radical departures in the current defense spending, but, even then the experts feel that no major recession looms.

Some economists believe the present boom can not last—that we are in for another "bust."

Others take the position that depressions are not inevitable and that business and government have learned a lot since the "thirties" about licking the boom and bust theory.

Government and forward-looking management, working together, can resist almost any factors which might otherwise become a national problem.



SOME EXCELLENT POINTS ON

# Public Relations For Architects

“PRESS RELATIONS IN PASADENA”

By **CULVER HEATON, Architect**  
**Chairman, Public Relations Committee,**  
**Pasadena Chapter, A.I.A.**

PART I

When the Public Relations Committee of the Pasadena Chapter set out to improve its relations with the local newspaper it learned all of its lessons the hard way. This article is prepared with the hope that other chapters may be able to save themselves some bruises.

In the geometry of press relations the following was found true:

## **Axiom No. 1**

The Lord and Editors **do** help those who help themselves.

### **Conversely**

The Lord and Editors **do not** like those who are trying to get in the paper when the item is not newsworthy.

## **Axiom No. 2**

**Editors** do not realize that architecture is the most newsworthy of all the arts.

### **Conversely**

**Architects** do not realize that architecture is the most newsworthy of the arts.

---

*EDITORIAL NOTE—This article on Public Relations, as applied to the architectural profession, and the subsequent part which will appear next month, was written by Culver Heaton, one of Southern California's most prominent architects and a resident of Pasadena, for publication in THE JOURNAL of The American Institute of Architects. Permission to reproduce this splendid article in ARCHITECT & ENGINEER magazine has been granted by the A.I.A., and every architect and every person interested in the practice of architecture should read this Pasadena report by Architect Heaton.—The EDITOR.*

## **Axiom No. 3**

**Editors** are interested in Building a Better Pasadena.

**Conversely** (But the Editors are not aware that) **architects** are interested in Building a Better Pasadena.

## **THEOREM**

If both Editor and Architect are interested in Building a Better Pasadena, and if architects have outstanding newsworthy material, then the two will make a good team.

1. To prove this theorem it is first necessary for the architect to take the chip off his shoulder. The world (or the Editor) does not owe him a living, and it is further apparent that the burden

of proof falls upon the architect.

2. Berating the Editor, when he fails to credit the architect at the dedication of a new building, only increases the antagonism.

3. Since nothing was achieved in the past by opposing, the Committee decided that it would be a good idea to get on the team and work **with** the Editor.

4. There are as many Sidewalk Superintendents as there are Monday-Morning Quarterbacks, and as soon as the Architects were on the team the Editor was surprised to find that they were a valu-

(See Page 25)



**CULVER HEATON**  
**Architect A.I.A.**

# NEWS and COMMENT ON ART



## SAN FRANCISCO MUSEUM OF ART

The San Francisco Museum of Art, War Memorial Building, Civic Center, is offering the following calendar of events for the month of March:

EXHIBITIONS: The 72nd Annual Painting and Sculpture Exhibition of the San Francisco Art Association; Contemporary Color Lithographs, an exhibit of the American Federation of Arts; How To Read a Photograph; Les Fauves; Marsden Hartley Retrospective Exhibition; Tools for Gardening; Prints by Henri Matisse, and special showing in the Rental Gallery.

Landscapes of the Bay Area will highlight the exhibition at the Parkmerced Branch, together with A Study of Les Fauves.

SPECIAL EVENTS will include Concerts, Folk Dance, Photochrome Club, panel on "Let's Build a House Lecture Tours, and Workshop Classes which include "Art for the Layman," "Sketch Club," "Painting Classes," and the "Children's Class."

## CITY OF PARIS

The Rotunda Gallery of the City of Paris, San Francisco, under the direction of Beatrice Judd Ryan, is presenting the 11th Annual Pacific Coast Textile Exhibition of Hand Woven and Hand Print-

ed Fabrics during March. The exhibit comprises the work of thirty-four designers.

Recent Prints by Dorr Bothwell will feature the Pictures of The Month display.

## MURALS FOR CONTEMPORARY ARCHITECTURE

Of particular interest to Southern California architects is the show of Joseph Young, muralist and mosaic worker recently returned from Europe, which is currently being shown at the Falk-Raboff Gallery, 9020 Beverly Boulevard.

Winner of three major national art awards, Young has impressed eastern art critics as one of America's most promising muralists. His present exhibition features encaustics done on Japanese paper.

## M. H. deYOUNG MEMORIAL MUSEUM

The M. H. deYoung Memorial Museum, Golden Gate Park, San Francisco, under the direction of Walter Heil, features an outstanding group of exhibits for March.

EXHIBITS: Paintings by Joseph Floch; Four American Painters, William Brice, Robert Chuey, Canning Peake, and Howard Warshaw; American Institute of Architects 1935 Honor Awards. A pres-

(See Page 38)

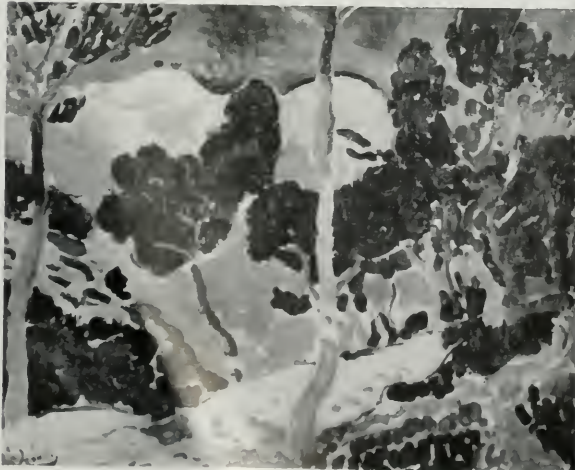

## SAN FRANCISCO MUSEUM OF ART

WAR MEMORIAL, CIVIC CENTER

Landscape, oil, by Andre Derain.

Collection of the  
San Francisco Museum of Art,  
Harriet Lane Levy Bequest.

# DESIGN OF WELDED STRUCTURES

DESCRIBED BY VAN RENNELAER SAXE

TO STRUCTURAL ENGINEERS ASSOCIATION — Southern California

By **DON WILTSE**, Executive Secretary

Members and guests of the Structural Engineers Association of Southern California, recently heard Van Rensselaer P. Saxe, Consulting Engineer of Baltimore, Maryland, discuss the subject of "Design of Welded Structures."

Saxe retired as president of the Standard Concrete Steel Company to open offices as a Consulting Engineer in 1920. His first welded structure was designed and constructed in 1928. In the following years his office designed and supervised construction of over 1200 welded structures of all types, and his discussion in Los Angeles was well illustrated with slides taken during the construction of many of these projects.

Among the points discussed by Saxe were the savings in steel which could result from a welded design maintaining comparable erection times with usually a lower cost, and the simplicity of design of welded structures.

Early experimental work developed a field assembly system of seats and clips which eliminated much shop handling by eliminating the necessity for punching operations, and allowed the welding application of both seats and clips to be done on skids outside the shop by a layout man and a welder working together. In 1929 this method was first used on a substantial structure, the Chesapeake Building at Loch Raven School in Maryland, in preference to an alternate riveted design.

The system has been under constant improvement since this time, and recently the first automatic adjustable connection clip was introduced for the erection of multiple story buildings. This new clip permits an adjustment of  $\frac{1}{4}$ " in making connections of beams to column flanges, and helps to overcome difficulties resulting from column variations from a true straight condition, caused by tolerances permitted in mill-rolled columns.

Saxe feels that the simplicity of welded connections can result in a minimum 5% saving in tonnage on many jobs. The Sun Papers Publishing Plant in Baltimore required 2214 tons of steel on the welded design used, against an estimated 2550

tons for a riveted alternate design. Welded design saved an estimated 337 tons on the Veterans Hospital in Minneapolis—and good construction time was made under adverse conditions involving snow and even a cyclone!

Welding lends itself quite readily to use where the principles of continuous design are applied to a steel frame building. The savings resulting from use of beams of smaller section than would be required for simple beam moments include not only a lighter dead load due to the steel, but less fire proofing and other similar items.

Saxe indicates that the design of welded struc-

(See Page 43)

---

## CONSULTING ENGINEER DISCUSSES SAN FRANCISCO BUILDING SITES

"Every building site presents a different situation to the foundation engineer, and every foundation a new problem in stability and settlement analysis," Charles H. Lee, San Francisco consulting engineer, said recently in reviewing the city's geologic situation.

Addressing the Spring Convention of the American Society of Civil Engineers, in the Fairmont Hotel, Lee Said:

"Not alone are there hills high above general level, but below the surface are deep buried valleys and canyons. Surrounding all are steep submerged slopes leading to the depths of the Bay of San Francisco, the Golden Gate and the Pacific Ocean."

Pressure for downtown office space "has led to the erection of tall buildings having great load concentration," said Lee. He said that "this area is located astride the original bay shore line in the transition zone between estuary muds and soft alluvial deposits of sand, sandy clay and clay. He added that "the variable subsoils within this area present a serious foundation problem involving both individual buildings and other existing buildings in the vicinity."

With the full occupation of the flatter land, said

(See Page 34)



# SOUTHERN CALIFORNIA PRODUCERS COUNCIL JOINT MEETING WITH AIA ARCHITECTS

A joint meeting of the Southern California Chapters of The American Institute of Architects and the Producers Council, Southern California, recently honored 1953 officers and directors of the AIA



*Among those taking part were: Left to right, Cornelius Deasy, Secretary, A.I.A.; Vern Boget, Gladding McBean & Co., National Director of the Producers' Council; Rex Thompson, Undersheriff of Los Angeles County, guest speaker of the occasion; Bob Roden, Truscon Steel Company, acting President of the Producers' Council, Southern California; Henry L. Wright, President, A.I.A.; Charles O. Matcham, Regional Director, A.I.A.; and Mrs. Herman Charles Light, President of the Women's Architectural League.*

## **BONUS LIGHT FROM GROUND REFLECTIONS AND LUMEN METHOD FOR CALCULATING DAYLIGHT FOR INTERIORS**

Two papers dealing with efficient daylighting of schools, hospitals, offices, and industrial areas, summarizing research at Southern Methodist University, Dallas, were presented before the Illuminating Engineering Society recently in Chicago.

R. L. Biese, Jr., an international authority on school daylighting, as research professor of engineering at SMU during the last two years has conducted research which led to development of a new method for daylighting design and prediction of daylight for interiors. In these studies he had a quarter-size model school classroom and the largest artificial sky now in use for experimental purposes.

J. W. Griffin, research associate at SMU, discussed the "bonus light" or contribution of day-

light reflected from ground areas into a building through large window areas.

On the basis of more than 400 tests conducted by his research staff, Mr. Biese arrived at a formula similar to the Harrison-Anderson equations for artificial lighting, enabling an architect to work out average, minimum and maximum daylighting for a given room, under specified sun, sky and ground conditions.

Initial graphic presentation of results were worked out for clear glass so that coefficients may be adjusted for the transmission factor of the glazing materials and allowances made for obstruction of daylight by muntins, Mullions, mortar joints and sash. Glass companies now furnish accurate data on light transmission of various types of glazing.

"We call this the lumen method of daylighting design," explained Mr. Biese. "It is relatively simple, employing a technique already familiar to engineers and architects. It points the way to construction of tables for many types of window con-

(See Page 33)

(Excerpt of two papers given at a Chicago Illuminating Engineering Society Meeting.)



## RECREATION CENTER

# GOLDEN GATE PLAYGROUND

Oakland, California

REYNOLDS & CHAMBERLAIN, ARCHITECTS

Construction of the new \$165,000 Golden Gate Playground and Recreation Center at 62nd street and San Pablo Avenue in Oakland, now well under way, is timed for dedication and public opening late this spring.

Long in the planning stage by the Oakland Recreation Commission, actual construction was delayed for a considerable time by federal control of critical materials, although funds for project development were authorized in the city's 1944 Bond Election issue.

The play area has been enlarged from its original design to three and one-half acres by the elimination of one block of 62nd Street, which had separated the old playground from the Golden

Gate Junior High School. The plans as shown above, include a turfed baseball diamond (1); a turfed and night-lighted soft-ball field (2); a junior area of play equipment, a tot-lot, horseshoe and handball and shuffleboard courts, all lighted. Approximately 22,000 sq. ft. of the outdoor recreation area will be paved.

The one story clubhouse (4) is of contemporary design with flat roof, wide overhangings and extensive glass areas. Exterior is of concrete block veneer and stucco with beamed pergola and porches. The structure has a recreation-social hall 32 ft. by 48 ft. with exposed beam ceiling; a 15 ft. by 22 ft. card room with acoustical ceiling and a

(See Page 34)



SOUTHERN CALIFORNIA—Modern Branch Bank

NEW UNIVERSITY-WESTWOOD BRANCH

Citizens National Trust and  
Savings Bank

WEST LOS ANGELES, CALIFORNIA

ARCHITECTS  
STILES CLEMENTS and  
ENGINEERS



**Officers Platform**

**On the main floor  
has unobstructed  
view of customer  
area and yet is  
secluded.**



**BELOW—General View  
Of the main lobby,  
general banking  
facilities at right and  
rear left; officers  
platform fore-front  
at left.  
Stairway leads to  
mezzanine where em-  
ployee facilities  
are located.**



## SAVINGS BANK . . .



**Installment, Loan and Trust Departments are conveniently situated at the rear of main floor.**

The Citizens National Trust and Savings Bank of Los Angeles, officially opened the doors of its new University-Westwood Branch recently. The completely air conditioned structure, of concrete, glass and stone, was designed by Stiles Clements, Architects-Engineers, to offer modern and complete banking services for West Los Angeles patrons, in comfortable and convenient surroundings.

The building itself is reinforced concrete with a full concrete basement and first floor. The mezzanine is framed in wood and supported by a steel truss. Surmounting the mezzanine area is the air conditioning equipment room. The roof of the building is of wood construction supported on clear span wood bowstring trusses which give a clear spacious feeling to the main floor and leaves it uncluttered by awkward columns.

An elevator gives easy customer access from the first floor to the basement with its safe deposit vault and escrow department. The basement is a large work room with a record vault and adjoining locker and toilet facilities for the employees, working therein.

The main floor is devoted entirely to serving the customer and is entered from the street through a two story wall of glass. This wall of glass with a draw drape of gauze, gives an inviting view to the passerby of the cool and pleasant interior, lush



### **Reception Area**

**For the convenience of bank patrons a special reception area has been provided with a friendly and comfortable atmosphere.**

interior planting and carpeted waiting area. Even the natural light in this spacious room has been carefully controlled by a bank of vertical louvers along the westerly side of the building. The main floor also contains the building's third vault.

Across the rear bay of the first floor is a mezzanine, which contains lockers and toilet rooms for the first floor employees. Here too, is an attractive employee's lounge, with a complete kitchen unit.

The Architects have also give careful thought to the exterior treatment with regards to texture and contrast by relieving the severeness of plain concrete with strong vertical louvers, large expanses of glass and greenstone, and luxuriant planting. Yet these materials have been handled in such a way as to retain the more formal and solid look usually associated with banking institutions. Even the Citizen's signs have been very carefully worked into the overall design.

It is with such a building as this, thoughtfully and carefully conceived and executed, that Citizens National Bank hopes to continue its phenomenal growth in serving the Southern California area.



**MODERN ELEVATOR — Service to banking facilities in basement.**

**Partial view of basement, showing safe deposit department and vault.**







A Rare Setting — Nestled Among Group of Ancient Oaks.

SHERWOOD FOREST THEME MOTOR COURT

# TOWN CHALET

LONGVIEW, WASHINGTON

OWNERS: MR. AND MRS. JOHN R. ERICKSON

Apartment Plan

ARCHITECT:

LAWRENCE B. RICE

ARCHITECT AND ENGINEER



When Architect Lawrence B. Rice designed the Town Chalet motor court at Longview, Washington, he came up with a novel solution to an old problem. Owners Mr. and Mrs. John R. Erickson wanted the structure to echo the environment of

a rare setting in a grove of ancient oaks. They wanted western woods used wherever possible.

In industrial Longview where chemical fumes and salt air have caused some problems with exterior paint, Architect Rice decided to do away

**RUSTIC, woody flavor is emphasized in this court yard view of the Town Chalet. This is but one wing. Balcony lends privacy to each unit.**



# TOWN CHALET . . .



**A BACHELOR  
STYLE UNIT**

Another attractive type of an apartment is the "Bachelor". It does not have the accordion folding wall. Note the spaciousness.

**SIDING** of hemlock on the inner court of the building is two-inch tongue and groove. Used vertically in lower floor and horizontally on the second floor.





**COMPACT APARTMENT  
FOR TRANSIENTS**

**Is streamlined, yet a complete living unit, like a home condensed. Sliding accordion door permits separation of sleeping and living space.**



with painted walls. To accomplish this he built the structure out of two by six, tongue and-groove hemlock which had been treated with salts. For contrast, the lower portion of two rear walls have been finished with half by four inch cedar siding laid vertically.

The salts-treated hemlock at first had a yellow tint and this is gradually turning to a darker copper tinted yellow with soft autumn browns. The cedar siding has been stained to retain the natural color of this western wood. A bright green trim around windows and on barge boards sets off the unusual

structure which appears to blend in with its Sherwood forest setting. Neither the treated hemlock nor the stained cedar will ever have to be painted.

Architect Rice solved other problems in this off-the-beaten path design job. To utilize a triangular

**CONTRAST** in two-story wall developed by use of stained cedar siding on first floor and golden-yellow hemlock, treated with salts, for the second level. Both finishes are permanent and will need no repainting.



## TOWN CHALET . . .



### DINING AND KITCHEN

Of the owner's apartment is both functional and attractive. Full width windows serving both rooms gives occupants full view of the motor court.

shaped piece of ground 319 by 277 by 249 feet, he laid out the building on a flattened out V pattern, which follows closely along two sides of the triangle and well to the back to allow a maximum off-street parking for all guests.

Town Chalet is a combination owner's home of five spacious and well conceived rooms and a 12-unit apartment motel. Economy in this \$70,000 building was achieved by building the twelve units identical in size and furnishings on a 20 by 20 foot module.

A touch of the Monterey is the two-story balcony treatment of the apartment section of the structure. Second floor apartments, identical in design and

floor plan to the lower level, are reached by a stairway which goes up from the inside of the courtyard.

Each apartment has a living room, bedroom, kitchenette and bath with shower. A plastic door separation folds back to throw bedroom and living room together into one space, or can be used as a wall when occupants desire the privacy of two rooms. The kitchenette is equipped with stove and refrigerator.

Bane of many two-story hotels and apartment buildings is noise, especially from the floors above. The architect has gone to elaborate pains to eliminate noise from any direction and has built an apartment unit which provides a maximum of quiet for the guests.

On the first floor apartments, ceilings are of acoustical tile. Sidewalls have been insulated with fibre-glass batts between the studs. The sheetrock walls were put on with furring nails



### OWNER'S APARTMENT

Is five-room space without doors. Rooms and varied function space for different aspects of living are divided by cupboards, shelving, or brick fireplace.

which hold the sheetrock away from the studs a fraction of an inch to prevent sound transmission from the studs. In the apartments above the same precautions have been taken with sidewalls. The floor above is built up of three-quarter by one inch cross joists laid on the regular joists, then a subfloor of three-quarter-inch plywood and over this has been laid asphalt tile except in the living room where a carpeting covers the floor. Carpeting has also been used in the living rooms in the first floor apartments. A cement slab carries the entire structure and over this asphalt tile has been laid.

The ceilings of the second floor apartments are exposed two-inch decking with a V pattern showing from the bottom side and six by twelve-inch exposed fir beams. These have been finished with a clear stain to retain the natural color and grain of the wood which makes an effective western tone for the upper apartments.

The roof is made up of a moisture barrier layer of two-inch insulation board laid on the fir decking and then a three-ply built up asphalt roofing has been applied.

The effect of this well-insulated roof has been to eliminate any penetration of summer heat into the second floor apartments.

The structure is electrically heated with four unit heaters located at proper places in each

apartment. Each apartment has been individually decorated with its own color scheme, and wall colors run from delicate pastels to bright and exciting shades. On the lower floor, wall paper has been used in some of the apartments to get variety.

All windows are trimp set steel casement sash which provide ideal cross ventilation, for any of the windows may be opened.

Mr. and Mrs. Erickson traveled one entire year throughout the United States to discover what the ideal motor court apartment should contain. Into the four hundred square feet of floor space of each apartment they have combined all the best features of hundreds of apartments. They decided each unit should be completely equipped with kitchenette as well as other telescoped home features. The separation door wall gives space when needed and also privacy.

One feature the Ericksons decided must be included in their project was a utility room where guests could do their own washing. A tiny laundry with washer and dryer is one of the most popular attractions at Town Chalet.

A large central domestic hot water heating system with circulating pump insures each guest has plenty of hot water. Utility and linen rooms have been built on each floor.

Two studio type apartments, with separation

(See Page 31)

**This Unit is standard for the second floor. Note exposed beams, with V-ceiling exposed and hemlock walls to match western theme. A clear stain retains the natural color and grain of the wood.**







Typical Western Design for Modern Store

THE NEW  
ATKINS STORE

MODERNIZATION OF BUILDING

SAN MATEO, CALIFORNIA

BURKE,  
ARCHITECTS: KOBER and  
NICOLAIS

GENERAL CONTRACTOR: MATTOCK CONST. CO.

The problem presented to the architectural firm of Burke, Kober & Nicolais of Los Angeles, by the owners of this particular property in the City of San Mateo, was to try and solve the problem of converting a gasoline service station site on one of the city's main downtown corners and an adjoining old concrete building that was originally designed for and had been used for a number of years as a combination garage and bus depot, and a small connecting retail store into a modern, single unit, attractive men's and women's apparel establishment that would add to the attractiveness of the area and be a stimulation to general business activity.

This modernization project had to be accomplished without the construction of any additional building to fill-in the old service station corner lot, as the owners did not wish to make any new additions or launch a major new construction program at the time. After a thorough study of the situation, including the relationship of the site to retail trade in downtown San Mateo and the type of remodeled structure which would offer a maximum in customer appeal for the occupant, the architects conceived the novel idea of projecting the show windows of the remodeled building outward into the filling station area and then supplemented these with a detached exterior merchandise show window island which is located between

the main part of the building and the sidewalk. It was believed by all concerned that such an unusual use of the "open-area", embellished with appropriate landscaping of plants and shrubbery, together with seasonal floral displays if desired, could convert the otherwise unattractive and bare concrete paved corner into an interesting architectural approach to a new retail store. Also that such a program would contribute favorably to the general attractiveness of site and serve as a stimulation of business in the area.

The detached "island" show window affords an individual display of merchandise in a manner appealing to foot and street traffic, and allows for a close inspection of men's and women's apparel items in a leisurely, "window-shopping" manner. Timely items and seasonable merchandise can be emphasized in this individual show-window, irrespective and without relation to any items which may be shown in the store's general display windows, thereby affording a greater flexibility to merchandising effort of the store.

The architects found that it would not be necessary to make many major alterations to the existing concrete building to accomplish the desired result. The side street openings, previously used for entry and exit of automobiles and large commercial passenger buses, were easily converted into attractive, modern, show window spaces

**BEFORE REMODEL . . . Old building was bus-garage combination.**



## MODERN STORE . . .

which were particularly attractive because of their spaciousness and close proximity to pedestrian traffic on the sidewalks. The customer entrance to the redesigned building faces towards the open area of the previous service station, and is readily recognized by both sidewalk and street traffic that passes the busy intersection daily. This entrance, accomplished by cutting a hole in the side of the old building, is featured by a projecting roof which is supported on ornamental, painted metal.

To present an attractive appearance to the public and in order to offer individuality among adjacent buildings and surrounding area, the face of the building was painted a rich brown which is contrasted with a white trim and letters of the sign designating the name of the store. To offer another item of distinctiveness the architects selected stone-crete for use on the lower portion of the patio facade. This also adds a desired textured surface.

The spacious merchandise display windows have been designed with use of redwood in a driftwood finish which not only harmonizes with the

Mustang Brown color of the building, but forms a background which is attractive to the overall window display area.

Because of the acute sun problem which existed at certain seasons in the year and were a major factor in the orientation of the building, plus the problems of the unique isolated display windows where the conventional awnings were extremely difficult to apply, the glass used in the display windows contains a gold tint. This use of slightly colored glass not only solves the problem of excessive sunlight, but also adds an attractiveness to the building in daytime and at night when overhead, indirect lighting is used to light-up the displays.

Flagstone has been used as an exterior facing on the lower portion of the building and around the base of the merchandise display windows.

On the interior the problem was to make use of the existing physical conditions of the old building which for the most part was just a building shell with exposed trusses. The utility use of the re-

**CLOSE-UP of unique merchandise display windows facing street.**





**SECTION**

Of interior store  
designed for display  
and the convenience  
of customers.

Auxiliary use of lights  
in display case, fully  
carpeted floor, and a  
partial wall covering  
of paper.



Scientific lighting combines large overhead center fixture in this display area together with ceiling spot-lights and hidden lights in mirror areas.





**EXTERIOR** of remodeled building emphasizes simplicity together with attractive window display appeal and lighting of store interior.

**BELOW:** Store interior offers spaciousness for convenience of merchandise display, plenty of overhead lighting and open-design entrance.



**The New  
ATKINS STORE**

The following firms, participants in the remodeling of the building, have display advertisements in this issue:

Mattock Construction Co., General Contractors; N. E. Andersen, Masonry Contractor; Izmirian, Heating, Sheet Metal & Roofing; A. Von Poppel, Lathing & Plastering Contractor; H. E. Casey Co., Concrete & Cement Finishing.

modeled building as a modern store where latest merchandising methods were to be employed necessitated the separation of the interior into individual men's and women's stores with both units readily accessible from the one entrance.

The interior design intention, therefore, was to create small intimate units within the two major classifications. These individual divisions to serve the needs of shoe, hats, sportswear and numerous women's departments. Each were to be separately treated but tied together with a general color trend and with a unity of decorative wood of mahogany with a definite grey filler. Illustrations shown on these pages indicate how thoroughly this was accomplished by the architect.

The women's shop is carpeted, wall-to-wall, in a Sphinx grey color. The walls have been done in a honeysuckle yellow, while in the coat and suit department the walls have been covered with a special paper in a modern flower design. The furniture is upholstered in coarse textured fabrics and the merchandising background of the interiors are of a bronze clair green color.

The floor of the men's furnishings departments, with the exception of the clothing section, have been covered with a brown marbelized asphalt tile and various color accents are picked up with use of coarse textured fabrics in Pertinent Reds. The floors of the clothing department have been covered with wall-to-wall carpeting and the walls of the men's sportswear department have been attractively highlighted by use of another special

**CONCRETE &  
CEMENT FINISHING**

ON  
ATKINS-FORMAN BUILDING

BY

**H. E. CASEY COMPANY**

TRANSIT MIX CONCRETE  
835 WOODSIDE WAY SAN MATEO

**MATTOCK CONSTRUCTION  
COMPANY**

**BUILDERS**



SAN MATEO OFFICE

Phone: DI 4-0524



SAN FRANCISCO OFFICE

GA 1-5516

**LATHING & PLASTERING**

ATKINS-FORMAN BUILDING  
SAN MATEO

by

**A. VAN POPPEL**

LATHING AND PLASTERING CONTRACTOR  
1013 S. Claremont Street San Mateo, Calif.





**INTERIOR  
VIEW**

Showing use of walls and fixtures to present feeling of individual store departments.

## IZMIRIAN

229 S. RAILROAD, SAN MATEO

TOPS  
IN  
HEATING  
SHEET METAL AND ROOFING

Example: The Atkins & Forman Building  
San Mateo

## BRICK AND STONE WORK

on

ATKINS-FORMAN BUILDING  
SAN MATEO

by

**N. E. ANDERSEN**  
MASONRY CONTRACTOR

1124 RHINETTE STREET, BURLINGAME, CALIF.

Phone: Diamond 3-3905

wallpaper. Carpeting of the clothing department is in a Desert Green base and as a pleasing contrast a Sun Bright yellow has been used for the coarse textured furniture fabrics.

The shoe department is uniquely featured with an overall latticed canopy which has been done in an Adobe Green color, and in keeping with the main design specially made shoe chairs have been provided which have been manufactured in a mahogany to match the decorative wood used throughout the entire shoe department.

Considerable attention has been given to lighting because of the nature of the building. For the most part it has been concentrated on proper use of louvered units which are square in shape, and a combination of incandescent and fluorescent lighting to meet particular lighting needs in specialized areas of the store.

A striking contrast of lighting, however, is in the women's shop where Swedish modern chandeliers have been used. These fixtures are accented by use in the main body with a Spice Coral color.

The completed project is an outstanding example of modern conversion of an otherwise limited type commercial building into an up-to-the-minute retail store that blends in perfectly with surrounding structures and is in keeping with the trends of the community.

*PHOTO CREDITS—Photographs on pages 18 and 22 are through courtesy of Foreman's Inc., Commercial Photographers.*

# PUBLIC RELATIONS FOR ARCHITECTS

## PRESS RELATIONS IN PASADENA, CALIFORNIA — HEATON

(From Page 3)

ably, and had endless vital news copy that interested the community.

5. **Therefore**, with their differences resolved, both the Editor and Architects worked together to make Pasadena a better place to live.

### Objective to be Achieved

The Committee decided that it hoped to achieve the following through its newspaper activities:

1. Acquaint the general public with the meaning of the term "Architect."

2. Establish in the public mind that the A.I.A. represents the highest of ethical and professional standards.

3. Illustrate the Architects' part in making Pasadena a better place in which to live.

4. Emphasize that the Architect is a financial necessity to a project as well as decorative asset.

5. By constant repetition establish the fact that the employment of an Architect is normal, rather than exceptional, practice.

These objectives are rather numerous, but our program has many facets and not all of the objectives are involved in each release.

### Rules of the Game

Before you can get on a team it is best to know the rules of the game. The gentlemen of the press have a code that must not be violated. Five of the main points are listed.

1. **Consistency**—Do not promise material that you cannot deliver. The paper is carefully proportioned between advertising and news copy, and the Editor must be able to plan on having the copy regularly before the deadline. At this point a word of warning: That which is everyone's responsibility is apt not to get done. For each undertaking have one individual entirely responsible, not the entire committee.

2. **Loyalty**—Do not try to exploit every paper in town. Do not release to competitive papers. We have found our loyalty more than repaid by cooperation from the publisher.

3. **Public Interest**—All material must be keyed to public interest, and not to the Architect's ego. The Architect's object is to make his town a better place in which to live, and all releases should show how the Architects have an indispensable part in accomplishing this end.

4. **Pictures**—Never have more than three persons in a picture. Do not all look at the camera, but look at a logical center of interest. Present the picture using 8" x 10" glossy prints taken by

a staff photographer, or a commercial photographer that knows his business.

5. **Text**—Be brief and to the point, and expect the material to be rewritten. Determine the reporter's style and present the information accordingly. Use the term "Architect" in the first sentence. Refer to the individual as "Architect John Doe," thus emphasizing the profession rather than the individual.

### Material Available

The material which Architects have available for editors is limited only by the Architects' in-

(See Page 35)

---

### ARCHITECTURAL EXHIBIT AT DeYOUNG MEMORIAL MUSEUM

A review of outstanding buildings constructed in the San Francisco Bay Area during the past twenty years is being currently exhibited at the M. H. DeYoung Memorial Museum, in Golden Gate Park.

The work represents sixteen Awards of Honor and twenty-seven Awards of Merit received by Bay Area members of The American Institute of Architects for architectural design, and according to Jury of Awards the exhibit is indicative of the fact that "this region is known the world over as a focal point in the evolution of contemporary architecture."

### SOUTHERN CALIFORNIA ARCHITECTS NAMED COUNCIL DELEGATES AT LARGE

John J. Landon, Whiting Thompson and William G. Balch, members of the Southern California Chapter AIA have been named delegates-at-large to the California Council of Architects.

Henry L. Wright, Chapter president and Charles E. Fry, immediate past president will also serve as delegates.

---

### ENGINEER GIVEN AMERICAN CONCRETE INSTITUTE AWARD

F. Thomas Collins, consulting engineer of San Gabriel, California, was recently awarded the American Concrete Institute Construction Practice Award for his paper entitled "Tilt-up Construction in Western United States".

The award was established in 1944 by the ACI to recognize the man on the job for his resourcefulness in translating design into a completed structure.

# American Institute



# of Architects

Glenn Stanton, President  
 Kenneth E. Wischmeyer, 1st Vice-president  
 Norman J. Schlossman, 2nd Vice-president  
 Clair W. Ditchy, Secretary  
 Maurice J. Sullivan, Treasurer

National Headquarters—  
 1741 New York Avenue, N. W.  
 Washington, D. C.  
 Edmund R. Purves  
 Executive Secretary

Arizona Chapter:  
 Richard Drover (Phoenix), President; Lew Place (Tucson), Vice-President; Martin J. Young, Jr. (Mesa), Secretary; Fred O. Knipe (Tucson), Treasurer; and Richard Drover, Fred Weaver and Ed Varney (Phoenix), and Martin Ray Young, Jr. (Mesa), and Gordon Luepke (Tucson), Executive Board members.

Idaho Chapter:  
 Frederick C. Hummel, President; Jack Woodmansee, Vice-President; Jed Jones III, Sec.-Treas. Offices 1324 Idaho Street, Boise, Idaho.

Montana Chapter:  
 E. Edward Scowcroft, President (Billings); J. Van Teylingen, Vice-President (Great Falls); H. C. Cheever, Secretary-Treasurer. Secretary office, Bozeman.

Coast Valleys Chapter:  
 Kurt Gross, President; Harold Ahnfeldt, Vice-President; Frank C. Treseder, Secretary; Jerome Kasavan, Treasurer. Directors, Hollis Logue and Gifford Sobey. Offices, 82 S. 3rd St., San Jose.

Nevada Chapter:  
 Walter Zick, President; Las Vegas; Russell Mills, Vice President; Reno; Keith Lockard, Secretary, Reno; Directors Edward Parsons, L. A. Ferris, David Vhay, Reno. Office of President P. O. Box 2107, Las Vegas.

Central Valley of California:  
 John W. Bomberger, President; Nicholas Tamich, Vice-President; Albert B. Thomas, Secretary; Ted de Wolf, Treas.; Gordon Stafford, Director; Alternate to CCA, Silvio Barovetto; Sec. Office 718 Alhambra Blvd., Sacramento.

Nevada State Board of Architects:  
 Russell Mills, Chairman, Reno; Aloysius MacDonald, Secretary, Las Vegas; Edward Parsons, L. A. Ferris, Reno, and Richard Stadiegan, Las Vegas, Members. Office, 309 S. 5th St., Las Vegas.

Colorado Chapter:  
 James M. Hunter, President, 2049 Broadway, Boulder; Casper F. Hegner, Secretary, 1659 Grant Street, Denver 5.

Northern California Chapter:  
 Albert R. Williams, President; Donn Emmons, Vice-President; William Corlett, Secretary; Bernard J. Sabaroff, Treasurer. Helen H. Ashton, Office Sec., Offices 369 Pine Street, San Francisco.

East Bay Chapter:  
 Chester H. Treichel, President; Malcolm D. Reynolds, Vice-President; John E. Lloyd, Secretary; Roger Lee, Treasurer. Secretary's Office 1171 Solano Ave., Albany, California.

## OREGON CHAPTER

Lloyd Keefe, City Planning Director for Portland, was the principal speaker at the February meeting held in Portland on the 17th.

Keefe presented the latest proposal for the relief of traffic and reclamation of declining downtown areas, and illustrated his talk with charts, graphs, figures and sketches.

*Remember it's*

# KRAFTILE

- for ★ GLAZED STRUCTURAL WALL UNITS
- ★ PATIO TILE
- ★ FACE AND ROMAN BRICK
- ★ ACID FLOOR BRICK
- ★ HEARTH BRICK
- ★ BRICKETTES
- ★ MINWAX TILE & CONCRETE FLOOR FINISH

For complete information and prompt service, phone or write

## KRAFTILE COMPANY

NILES, CALIFORNIA

NILES 3611

LOS ANGELES 13: 406 South Main Street—Mutual 7241

The annual Producers' Council Parade of Products was held the middle part of February at the Multnomah Hotel, with an exceptionally large number of new materials and products being shown.

NEW MEMBERS. Recent new members include: Wilbert P. Lei; John W. Foster; and Charles Gilman Davis, all Corporate Members.

## WOMENS ARCHITECTURAL LEAGUE OF PASADENA

Mrs. A. C. Zimmerman, President of the Pasadena Women's Architectural League and Secretary-treasurer of the Central Committee of Women's Architectural Leagues of California, recently conferred with Mrs. Lew Place of Tucson, Arizona, relative to the possibilities of organizing a Chapter of the Women's Architectural League in Arizona.

Purpose of the Women's Architectural League is the unification and advancement of architecture and the stimulation of greater public understanding of the profession's aims and its capacity to be of service to the community.

## 1953 A.I.A. CONVENTION SEATTLE

Chairman Waldo Christenson of the Washington State Chapter, A.I.A., has announced the appointment of two new 1953 A.I.A. Convention committeemen. Robert Durham will serve as head of the Transportation Committee, and Robert B. Price will head the Tacoma activities.

Other members of a general steering committee include: Waldo B. Christenson, Chairman; William J. Bain, Hospitality; Roger Gotteland, Foreign Guests; Victor N. J. Jones, Reservations; Hugo W. Osterman, Finance; J. Lister Holmes, Exhibitions;



**Orange County Chapter:**

William Blurock, Corona del Mar, President; George Lund, Balboa, Secretary; Paul O. Davis, Corona del Mar, Treasurer. Office of Secretary, 2919 Newport Blvd., Newport Beach.

**Oregon Chapter:**

H. Abbott Lawrence, President; Holman J. Barnes, Vice-President; Donald W. Edmundson, Secretary; and Robert W. Fritsch, Treasurer. Office of Secretary, 325 Henry Bldg., Portland.

**Pasadena Chapter:**

Robert E. Langdon, Jr., President; Wallace C. Bonsall, Vice-President; Robert L. Deines, Secretary; Henry C. Burge, Treasurer; and Directors John N. Douglas, R. VanBuren Livingston, Scott Quintin and Burton Romberger. Offices: 259 South Los Robles Ave., Pasadena 5.

**San Diego Chapter:**

Donald Campbell, President; Victor L. Wulff, Jr., Vice-President; Richard L. Pinnel, Secretary; Edward G. Holliday, Treasurer; Louis A. Dean, Director. Office Sec., San Diego Trust & Savings Bldg.

**San Joaquin Chapter:**

David H. Horn, President; William G. Hyberg, Vice-President; Richard P. Clark, Secretary; Bryon C. Brodrick, Treasurer. Sec. Office, 335 Anglo Bank Bldg., Fresno.

**Santa Barbara Chapter:**

Wallace W. Arendt, President; Roy W. Cheesman, Vice-President; Chester Carjola, Secretary; Luth M. Riggs, Treasurer. Sec. Offices, 129 De la Guerra Studios, Santa Barbara.

**Southern California Chapter:**

Henry L. Wright, President; U. Floyd Rible, Vice-President; Cornelius M. Beasy, Secretary; Savo M. Stoshitch; Hugh R. Davies, S. Kenneth Johnson, Kemper Nomland and Chas. E. Fry, Directors. Headquarters, 3723 Wilshire Blvd., Los Angeles 5.

**Utah Chapter:**

W. J. Monroe, Jr., President, 433 Atlas Bldg., Salt Lake City; M. E. Harris, Jr., Secretary, 703 Newhouse Bldg., Salt Lake City.

**Washington State Chapter:**

Paul Thiry, President; John S. Dettie, 1st Vice-President; Robert H. Wohleb, 2nd Vice-President; Robert H. Dietz, Secretary; and Edwin T. Turner, Treasurer. Alice Gregor Executive Secretary, 430 Central Building, Seattle 4.

**Spokane Chapter:**

E. K. Ruchi, President; Victor L. Wulff, 1st Vice-President; Philip Keene, 2nd Vice-President; Laurence G. Evanoil, Secretary, and Carroll Martell, Treasurer. Office 515 American Legion Bldg., Spokane, Washington.

**Tacoma Society:**

E. N. Dugan, President; P. G. Ball, Vice-President; Lyle Swedberg, Secretary-Treasurer.

**Hawaii Chapter:**

Kenji Onodera, President, 3518 McCarriston St., Honolulu, T. H.; George J. Wimberly, Secretary, 315 Royal Hawaiian Ave., Honolulu, T. H.

**CALIFORNIA COUNCIL OF ARCHITECTS**

William Kahik, President, 2203 - 13th St., Sacramento; Donald Beach Kirby, Secretary, 461 Market St., San Francisco; Frederick A. Chase, Exec. Secty., 3723-A Wilshire Blvd., Room 206, Los Angeles.

**ALLIED ARCHITECTURAL ORGANIZATIONS**

**San Francisco Architectural Club:**

Joseph Scama, President; Frank S. Gerner, Vice-President; Russell W. Pennell, Treasurer; Frank L. Barsotti, Secretary. Club Quarters: 537 Howard St., San Francisco.

**Producers' Council—Southern California Chapter:**

Bert Taylor, President, Pittsburgh Plate Glass Company; G. Robert Roden, Jr., Vice-President, Truscon Steel Company; Malcolm G. Lowe, Secretary, Natural Gas Equipment Inc.; Richard Seaman, Treasurer, W. P. Fuller & Company; Vern Bogert, National Director, Gladding McBean & Co.

Producers' Council—Northern California Chapter (See Special Page)

George W. Stoddard, Special Events; John T. Jacobson, Products Exhibit; James J. Chiarelli, Arts & Crafts; Wendell Lovett, Student Activities; J. Emil Anderson, Architectural Guild; B. Marcus Pritecca, Special Entertainment; John S. Dettie, Decorations & Motifs; Paul Thiry, Fellows; and Robert H. Dietz, Secretary.

The Awards of Honor included:

For houses under 1500 square feet: The Mrs. P. K. Gilman house, Kent Woodlands, designed by George T. Rockrise; the E. B. Wienand house, San

(See Page 32)

**SAN DIEGO CHAPTER**

The regular February meeting was held at the Barbara Worth Country Club in El Centro, California, with El Centro architects Frank Hyde and Terry Whittington serving as hosts. Both are members of the San Diego Chapter and have an enviable record of attendance at San Diego meetings.

Considerable discussion was given to the Delano Chamber of Commerce activity in connection with two measures introduced at the current session of the California State Legislature which relate to the practice of architecture in California.

Don Campbell has been named California Council of Architects, Convention Chairman.

**NORTHERN CALIFORNIA CHAPTER**

The Honor Awards Program, sponsored by the three Bay Area Chapters of The American Institute of Architects, was presented with a gala Awards Dinner at the M. H. deYoung Memorial Museum, San Francisco, on February 26th.

Principal speaker was Richard J. Neutra, F.A.I.A., Chairman of the Honor Award Jury, and presentation of awards was made by Douglas Haskell, A.I.A. The Honor Award Jury was comprised of Pietro Belluschi, Richard J. Neutra, and Edward D. Stone, all nationally famous architects.

**SPECIFY THE GARAGE DOOR  
DESIGNED FOR TODAY'S WIDER CARS!**

**STRAND**

**9'**

**ALL-STEEL  
GARAGE  
DOORS**



**Help Your Clients Beat The High Cost of Banged-Up Fenders!**

- NEW BEAUTY — Horizontal-line styling!
- EXTRA DURABILITY—Rugged, all-steel. Galvannealed for rust protection.
- LOW INSTALLATION COST — One-piece door leaf; no field assembly. Hardware is factory assembled.

DISTRIBUTED BY

**PCA Pacific Coast  
Aggregates, Inc.**

CONTACT THE NEAREST P.C.A. OFFICE

<b>SAN FRANCISCO</b>	<b>OAKLAND</b>	<b>SAN JOSE</b>
<b>SACRAMENTO</b>	<b>STOCKTON</b>	<b>FRESNO</b>

# WITH THE ENGINEERS

## Structural Engineers Association of California

John E. Rinne, President, San Francisco; Jack S. Barrish, Vice-President, Sacramento; Leslie W. Graham, Secretary-Treasurer, San Francisco. Directors John J. Gould, R. W. Binder, M. A. Ewing, Leslie W. Graham, Jack S. Barrish, Harold P. King, W. T. Wheeler, John E. Rinne and Donald F. Shugart. Secretary's office, c/o Associated Structural Engineers, 417 Market St., San Francisco 5.

## Structural Engineers Association of Northern California

George A. Sedgwick, President; Michael V. Pregnoff, Vice-President; John M. Scardis, Secretary; William K. Cloud, Treasurer; Robert P. Moffett, Asst. Sec.-Treas.; Directors, Robert D. Dalton, Robert D. Dewell, William H. Ellison, John J. Gould and J. Albert Paquette. Offices: 417 Market St., San Francisco.

## Structural Engineers Association of Central California

William H. Peterson, President; Walter S. Wassum, Vice-President; O. T. Illerich, Sec.-Treas.; Ernest D. Francis, M. A. Ewing, and Arthur A. Sauer, directors. Office O. T. Illerich, c/o Div. of Arch., Sacramento.

## American Society of Civil Engineers Los Angeles Section

Trent R. Dames, President; Stephenson B. Barnes, Vice-President; John M. Server, Vice-President; C. Martin Duke, Secretary, and John Merrell, Jr., Treasurer. Office of Secretary, 3066 Engineering Building, University of California, Los Angeles 24.

## American Society of C. E. San Francisco Section

Clement T. Wiskocil, President; John S. Longwell, Vice-president; J. G. Wright, Vice-president; H. C. Medbery, Treasurer; R. D. Dewell, Secretary. Secretary's Office, 604 Mission St., San Francisco.

## SCHWALEN PRESIDENT ARIZONA ENGINEERS

Harold C. Schwalen, University of Arizona Professor of Agricultural Engineering, was recently elected president of the Arizona Section of the American Society of Civil Engineers.

Other officers are Dario Travaini, 1st vice-president; Hanen H. Williams, 2nd vice-president and Wilbur L. Heckler, secretary-treasurer.

## AMERICAN SOCIETY OF CIVIL ENGINEERS LOS ANGELES SECTION

David Lee Narver, Jr., Associate Member of the A.S.C.E. and Project Engineer for Holmes & Nar-

ver, Inc., addressed the February meeting in Los Angeles and discussed some of the experiences and problems that confronted his firm when the Atomic Energy Commission gave them a contract for the construction and maintenance of the A. E. C.'s test site on Eniwetok Atol, 5300 miles from Los Angeles in the Central Pacific.

The contract involved the building of a town to provide for the physical and mental comforts of 8500 men, and the construction of many unique structures to be used in the test of atomic weapons.

Narver also told of the organization of the joint task force which conducted the test and told how design, logistic and construction problems were encountered and solved. One of the largest problems was the production of enormous quantities of fresh water on the 20 by 16 mile atol whose highest elevation is 14 feet. A colored motion picture covering the A. E. C.'s joint task force Greenhouse was shown.

Speaking on the same program was G. H. Puliam, Special Investigator for the State Board of Registration for Civil and Professional Engineers. He discussed enforcement provisions of the Registration Act and the Board's interpretation of the law, citing many incidents in the performance of his duties.

## STRUCTURAL ENGINEERS ASSOCIATION OF SOUTHERN CALIFORNIA

A program on earthquakes and parapets was presented at the March meeting with G. E. Morris, G. F. Hope, and H. L. Manley of the Los Angeles City Building Department, leading the discussions.

The first part of the program dealt with the effect of the Arvin and Bakersfield earthquakes, with particular reference to structures constructed after 1933. The second portion dealt with the work being done in the City of Los Angeles to eliminate the greatest danger to life during earthquakes, unsafe cornices and parapet walls.

Following the Arvin and Bakersfield earth-



*Always specify* **HAWS**

**FOR HIGHEST QUALITY**

- Sanitary Drinking Fountains
- Electric Water Coolers
- Drinking Faucets, Equipment, Filters and Accessories

*A reputation for reliability since 1909.  
Check in Sweet's or write for HAWS catalog.*

**HAWS DRINKING FAUCET CO.**  
1441 FOURTH STREET (Since 1909) BERKELEY 10, CALIFORNIA  
Agents and Sales Representatives in All Principal Cities

Structural Engineers Association of Southern California

Ben Benioff, President; William T. Wright, Vice-President; Charles M. Corbit, Jr., Sec-Treas. Directors: Ben Benioff, William T. Wright, Harold P. King, Henry M. Layne, Joseph Sheffet, Robert J. Kadow and Harold Omsted. Offices, 121 S. Alvarado St., Los Angeles 4.

Structural Engineers Association of Oregon

R. Evan Kennedy, President; Guy H. Taylor, Vice-President; James R. Griffith, Secretary-Treasurer; Directors Jerome A. McDevitt, H. Loren Thompson, and Robert L. Tidball. Offices, Portland.

Puget Sound Engineering Council (Washington)

R. E. Kister, A. I. E. E., Chairman; E. R. McMillan, A. S. C. E., Vice Chairman; L. B. Cooper, A. S. M. E.,

Secretary; A. E. Nickerson, I. E. S., Treasurer. Offices, L. B. Cooper, c/o University of Washington, Seattle 5, Washington.

American Society Testing Materials

Northern California District

L. A. O'Leary, Chairman; P. V. Garin, Vice-chairman; H. P. Hoopes, Sec. Office Sec., 1550 Powell St., Emeryville, Calif.

Society of American Military Engineers—San Francisco Post

Brig. Gen. Dwight W. Johns, USA, Ret., President; Cmdr. N. M. Martinsen, CEC, USN, 1st Vice President; Lt. L. L. Wise, CEC, USNR, 2nd Vice President; Robert P. Cook, Secretary; O. Spier, Treasurer; and Rear Admiral C. A. Trelax, CEC, USN (Ret.); Capt. Cushing Phillips, CEC, USN; Capt. H. F. Ransford, CEC, USN; Clyde Bentley; Lt. Col. James D. Strong, CE, USA; and J. G. Wright directors.

quakes, engineers from the Department of Building and Safety visited both cities and obtained first hand information on the effects of the shocks on buildings. The results of these studies were graphically shown with colored slides.

The Report of the Special Committee on Welding Practice has been released and covers a thorough study on the subject with special attention being given to Specifications, Drawings and the Check List.

NEW MEMBERS—Milton A. Abel, John D. B. Allison, Jr., Thomas Don Beason, Rupert C. Brittain, Kenneth S. Iwata, Coleman W. Jenkins, and Charles F. Moran, ASSOCIATES. John E. Soehrens, MEMBER.

## FEMINEERS

The "Femineers", wives of members of the American Society of Civil Engineers, and Structural Engineers Association of Northern California, were told many of the intricacies of landscaping and gardening by John Aitkin at the regular February meeting, held in the Elks Club, San Francisco.

Aitkin is associated with the McDonnell Nursery of Oakland and Walnut Creek.

Mrs. August E. Waegemann, was in charge of reservations for the meeting.

## SOCIETY OF AMERICAN MILITARY ENGINEERS—SAN FRANCISCO POST

"Communist Military Indoctrination in Korea" was the subject of an address by Major General Haydon L. Boatner at the March meeting in San Francisco.

Major General Boatner was former commander of the prisoner of war camps at Korea, and many of his experiences in conduct of these camps were related at the meeting, which was held jointly with the American Society of Civil Engineers, San Francisco Section.

## ENGINEERS HOLD LEGISLATIVE DINNER IN SACRAMENTO

A "Get acquainted with your legislators" dinner was held in the Sutter Club in Sacramento this month in conjunction with the current legislative session now in progress.

The meeting was sponsored by the Structural Engineers Association of Southern California and the Legislative Committee members plus a number of others, flew to Sacramento from Los Angeles via chartered airplane.

Arrangements were in charge of Joe Sheffet.

# HAWS

## has the ANSWER

...for every specification requiring a public source of refreshing, sanitary drinking water.

**RESTAURANT WATER COOLERS**  
**ELECTRIC WATER COOLERS**  
**DRINKING FOUNTAINS**  
**DRINKING FAUCETS**



Single and multiple units to fit your requirements. Beauty to match the decor of any design. The utility you demand. Backed by a reputation for reliability since 1909.

See Sweets or write for the new HAWS Catalog

# HAWS

## DRINKING FAUCET CO.

1443 FOURTH STREET - BERKELEY 10, CALIFORNIA



# PRODUCER'S COUNCIL PAGE

The National Organization of Manufacturers of Quality Building Materials and Equipment  
(Northern California Chapter) affiliated with THE AMERICAN INSTITUTE OF ARCHITECTS

President, A. L. West, Jr.  
Aluminum Company of America  
521 Russ Bldg.

Vice-President, Howard W. Noleen  
E. F. Hauserman Company  
31 Geary Street

Secretary, Hillman Hudson  
Vermont Marble Company  
825 Market Street

Treasurer, Tait Smith  
Ceco Steel Products Corp.  
401 Tunnel Avenue

Edited by Phil Brown, OTIS ELEVATOR COMPANY.

## UNIVERSITY OF CALIFORNIA MATERIALS COURSE

It has long been the hope of the Education Committee within the Producers' Council that one of the leading Universities would include a materials course in their curriculum for architectural students. This hope is about to be realized as the University of California at Berkeley is programming a fully accredited Materials Course. The instructor for this course will be Mr. Leonard Michaels who recently came to this country from his architectural practice in England.

Even though we had nothing to do with the actual programming of this course, it will afford us a splendid opportunity to reach the young under-graduate architects at the University.

The Department of Architecture at U. C. is looking to us for our assistance and particularly in the forming of a Materials Library. We have been requested to supply motion pictures, slides and as many samples of our products as we can. A circular letter will be issued by Herb Duncan, Chairman of the Education Committee that will explain what is desired and to whom the samples should be sent.

Herb also reports that although he does not have a 100 per cent reply to his request regarding the programs the Council members would be willing to put on in the outlying Chapters of the A. I. A., he has received replies which include at least one manufacturer of all the various types of equipment that are represented in the Producers' Council.

Herb is planning to release a list of the type of films, talks and programs that are available. This list will be distributed to the various A. I. A. Chap-

ters who can select the length and type of program they care to hear at their meetings.

## COUNCIL TALKS

We have had an opportunity during the past few months to present talks on the founding of the Producers' Council and its activities in the building industry.

During the latter part of January, Mr. Clark Wayland of Western Asbestos Company, presented such a talk to the annual meeting of the Associated General Contractors at the St. Francis Hotel.

On February 27 and 28 Mr. Jim Christie of the Zurn Manufacturing Company of Los Angeles, presented a talk on the founding of the Council and its principles to the yearly meeting of the California Council of Architects at the Statler Hotel in Los Angeles.

On February 10 President Al West talked to the meeting of the Coast Valley Chapter in San Jose.

All of these talks covered briefly the facts that the Council is a part of the A. I. A. and that it was originally founded at the request of the A. I. A. It is thought that by presenting the facts of our founding and present relationships with the profession, that we can strengthen our hand with the younger architects coming along in the profession, especially the Valley Chapters where the Producers' Council has not been active in the past. The Council, of course, has always wanted to extend their coverage to these territories outside the Bay Area but it has simply been an impossibility due to a lack in man power.

As we now have about 77 member companies, it will be possible to divide the burden of these responsibilities and do a very fine job.

USE QUALITY PRODUCTS



CONSULT AN ARCHITECT

## TOWN CHALET — Longview

(From Page 17)

wall eliminated, have been built at each end of the upper floor level.

The balcony not only gives a pleasing distinction to Town Chalet, but it serves the second floor apartments both economically and functionally. The balcony roof is merely an extension of the regular roof, and the balcony is protected with a cedar fence set diagonally and topped with a fir hand railing. The balcony provides ready access to any apartment, but being outside the building it does not have to be heated, nor does it take up enclosed space in the building which a hallway would occupy.

The exterior of the structure has several striking and unusual features. A row of decorative posts, of three-by-twelve inch fir, set perpendicular to the slope of the roof, which is away from the courtyard, break the severe lines of the building. A plastic screen has been used two stories high at the inside break of the building to shut off the wind from the open stairway.

Method of application of the hemlock by Architect Rice on the walls facing the courtyard is rather interesting. Along the lower half of the wall the two-by-six hemlock has been laid vertically, directly on the studs, using nailing blocks. Sheathing has been eliminated by using the two inch thickness. On the upper half of the wall the hemlock has been laid horizontally to give variety.

On the two rear walls, the lower half is covered with cedar siding, which has been laid vertically over sheathing. The treated hemlock was used on the upper half and here, too, it was laid horizontally.

The over-all result is a typically northwestern design, which is ideal for a Sherwood forest setting, unbelievably, right in the center of Longview. The effect of the yellows, golds, light and soft browns and forest green colors is altogether charming. Even the birch doors have been left in their natural grain, having been treated only with clear lacquer.

Within a year or two, when the cedar wall assumes its permanent shade, its dark brown native color will form a striking contrast with the golf and green-yellow tints of the treated hemlock on the upper story.

A tiny basement serves as a furniture repair and storage room as well as providing space for the hot water heating system and the electric panels.

The Erickson apartment is actually a separate five-room home which has been built in such a manner that the courtyard of the Town Chalet can

be seen from either the living room or the kitchen.

Although connected with the apartment structure, its brick veneer siding sets it off from the rest of the project. The Erickson home rests on a concrete slab which has been covered with an asphalt tile floor, with carpeting in the living room.

This apartment contains living room, dining room, kitchen, two bedrooms and bath. Probably the most interesting feature is the effective way in which Architect Rice has used segregation screens of cabinet work and diffused glass in place of walls to serve as a break between rooms. It is an open-plan design with illusion of expanse built up by eliminating firm walls.

Ericksons can convert their motor court from a transient into a permanent resident project without problems. Anticipating such a possibility, because the Town Chalet is off main-traveled highways, the apartments were made completely self-contained, and suitable for either permanent or transient type guests. Telephone wiring has been installed in each apartment, and the installation of a telephone for a guest staying any length of time requires only the insertion of a jack.

Architect Rice has created a sound, workable idea in his full scale module of a motor court apartment. Cost has been held down in this struc-

## STOP WATER DAMAGE!



FORM BOARDS



BRICK - CONCRETE



PAINTED SURFACES

Specify

*Thompson's*  
**WATER SEAL**

for

**Waterproof Protection**  
of all porous materials

- It penetrates • Is transparent
- Leaves no film • Locks out moisture
- Lasts for years • Proved by performance.

Will cover 200-400 sq. ft. to gal. depending on porosity of material. Specified by architects and used by contractors all over the West. Has State of California approval.

Write or phone for proof of performance and specification material.



Manufacturer

**BY-CHEMICAL PRODUCTS CO.**

1355 MARKET ST., SAN FRANCISCO • KING CITY • LOS ANGELES

ture by building identical units. Yet, by clever application of available color schemes and decoration plans, none of the apartments have the appearance of being cast in the same mold. Use of wall paper on some walls is also an effective medium of breaking the mold.

Space utilization, without sacrifice of free moving room or any unsatisfactory telescoping of facilities or creature comforts, is apparent in the Town Chalet apartments. Very noticeable is the impression made on a visitor as he drives into the courtyard. There is a country club feel to the building, and it carries into the apartments. All this has been attained on an economy budget, which makes the accomplished result all the more remarkable.

## A.I.A. ACTIVITIES

(From Page 27)

Francisco, by Frederick L. Conter and John Hans Ostwald, and the Leisure house, Mill Valley, by Worley K. Wong and John Carden Campbell.

For houses over 1500 square feet: The William Foster house, Orinda, by Henry Hill and the Charles G. Sawyer house, Carmel, by Anshen and Allen.

Apartment building: Bay Hill apartments, San

Francisco, by Henry Hill. Church building: Corpus Christi Church, San Francisco, by Mario J. Ciampi. School building: Mira Vista Elementary School, Richmond School District, by John Carl Warnecke.

Office and administrative buildings: Red Cross Building, San Francisco, by Gardner A. Dailey, and Schuckl Building, Sunnyvale, by Wurster, Bernardi and Emmons.

Commercial buildings: American Seed and Nursery Co., San Francisco, by Francis Joseph McCarthy; Cargoes, San Francisco, by Skidmore, Owings and Merrill, and Allied Arts Guild Sales Building, Menlo Park, by Germano Milono.

Hotels and restaurants: Roland's Cocktail Lounge, San Francisco, by Mario L. Gaidano. Industrial buildings: Del Monte Laundry, Monterey, by Gardner A. Dailey and Skidmore, Owings & Merrill. Garden structures: MacDonald Garden House, Hillsborough, by Germano Milono.

Photographs of the winning entries and of 108 other structures in the finals were put on exhibit at the deYoung Museum and will remain at the museum for a month.

## WASHINGTON STATE CHAPTER

Thirty-nine new members were welcomed at the March 5th meeting as part of a program which included the showing of two motion pictures on new techniques of construction and a general "review" of the architectural profession.

One of the motion pictures was devoted to the tilt slab technique of concrete construction, and the other was devoted to consideration of the tilt-up slab technique. Both methods have received a great deal of attention in the building trades and architectural profession.

Considerable attention was devoted to items dealing with the 1953 A.I.A. Convention to be held in Seattle, June 16-19.

## PASADENA CHAPTER

The regular March meeting was a joint meeting with the Producers' Council and the annual display of product materials in the form of a "quiz show" the theme of which was "Know Your Materials". Special awards were given those who could describe the greatest number of "products".

The first Honorary Associationship has been presented to Assemblyman A. I. Stewart. The award was made by President Bob Langdon in appreciation of Stewarts "contributions to the public welfare over a period covering many years." Stewart served as a member of the Board of Directors of Pasadena for more than twenty-four years and as director of the Professional and Vocational Standards department of the State of California helped to establish California's high standards in the

# Summerbell

## for PUBLIC



BUILDINGS

Floral Display Building,  
Los Angeles County Fair  
Association, Pomona,  
California.  
Architects,  
Gable & Wyrant,  
Structural Engineer,  
Harold P. King.

SUMMERBELL glued laminated construction gives the Architect and Engineer unlimited freedom in designing public buildings with striking beauty and unobstructed spaciousness. Members are produced in the exact size and shape required. Glued laminated construction retains its dimensional stability as well as its natural beauty, plus greater fire resistance.

Glued Laminated Construction • Summerbell Bowstring Trusses  
Lamello Roofs & All Types of Timber Structures



For quality, economy and satisfaction, specify **SUMMERBELL**

## Summerbell ROOF STRUCTURES

825 EAST 29TH STREET • BOX 218, STATION "K" • LOS ANGELES 11



licensing and practice of members of various professions and vocations.

**NEW MEMBERS.** Ernie Wilson, Ed Davies and Chester Sorenson are recent Chapter Members.

### ELECTED PRESIDENT WOMEN'S ARCHITECTURAL LEAGUE

Mrs. Herman Charles Light has been elected president of the Women's Architectural League of California for the year 1953. She succeeds Mrs. Henry L. Wright who now heads the WAL Central Committee.

Other newly elected officers include: Mrs. C. Day Woodford, vice president; Mrs. Arthur Gallion, corresponding secretary; Mrs. W. Glenn Balch, recording secretary, and Mrs. Stanley R. Gould, treasurer.

### SOUTHERN CALIFORNIA CHAPTER

C. Haines Finnell, Director of Public Relations for the Union Oil Company of California, and vice chairman of the national Oil Industry Information Committee of the American Petroleum Institute, and chairman of the Public Relations Sub-committee of the Western Oil and Gas Association, spoke at the March meeting on the subject of "Public Relations."

Nominees for delegates to the Seattle A.I.A. Convention to be held in June were proposed.

### SAN FRANCISCO ARCHITECTURAL CLUB

The 1953 Architectural Seminar is being offered by the San Francisco Architectural Club, Inc., 507 Howard Street, with courses in "Structural Engineering for Architects," and the Architectural Design Atelier (for members only).

The structural engineering program offers a four-semester, two-year course designed to prepare students for the structural section of the examination of the California State Board of Architectural Examiners. Each semester will consist of a minimum of fifteen class meetings, one each week.

The second semester will cover: graphic statics, stresses in trusses for vertical and lateral loads, design of steel trusses, design of timber trusses, details of connections, timber connections and welded connections. The third semester will offer: reinforced concrete, materials and mixes; continuous structures; slabs, beams, and columns; flat slabs; and retaining walls.

The fourth semester will cover such subjects as foundations, soil pressures, spread footings, combined footings, pile footings, lateral forces, design for wind and earthquake forces.

The course is under the general supervision of George A. Sedgwick, Structural Engineer. Assisting him are Clyde E. Bentley, Consulting Engineer; Leo E. Dwyer, Mechanical Engineer; Felix Rosen-

thal, M.A.; Michael J. Sweeney, Architect, Specifications Writer; Clyde F. Trudell, Architect; George A. Downs, A.I.A., Architect; Michael Goodman, A.I.A. Architect; and William Corlett, A.I.A., Architect.

### BONUS LIGHT

(From Page 6)

struction or design.

"This new method takes into account the exact behavior of interreflections and ground reflections, in spaces such as classrooms, offices, hospitals, small industrial spaces, and similar areas where reflected light is important."

As an example, Mr. Biesele worked out in detail a complete problem in seven steps showing the daylight delivered to the work plane in a typical room under stated conditions.

In his discussion of "The Importance of Ground Reflection in Daylighting" Mr. Griffith concluded that "light from below the horizon is bonus light. It is a dividend from something whose only cost is good design practice."

Griffith reported on extensive studies made at SMU showing how strategic location of concrete parking areas, sidewalks, light colored school playground areas, and even the horizontal louvers of

Edison's First Successful Incandescent Lamp, 1879

# IS YOUR LIGHTING OBSOLETE?



Recent surveys indicate that less than 25% of all lighting installations are adequate, based on present day standards. Present high salaries and competitive markets call for strictest economy and proper illumination may increase production or sales up to 50%. SMOOT-HOLMAN'S line of luminaires: incandescent, fluorescent and slimline may economically suit your lighting problem.

ILLUMINATION EQUIPMENT  
**SMOOT-HOLMAN**  
LINDSEYWOOD, CALIFORNIA  
ESTABLISHED 1914

ILLUMINATION EQUIPMENT  
BRANCH OFFICE AND  
WAREHOUSE SAN FRANCISCO

Venetian blinds may be used to pass indirect lighting into the far corners of a room.

He said in some conditions of sun and ground there may be more light entering vertical windows from below than from the sky.

Tests have shown that ground reflections from grass fields and lawns run 18 to 23 per cent, dead grass 28 to 32 per cent, fresh snow 100 per cent, old snow 59 per cent, concrete 55 per cent, macadam 18 per cent and gravel from 15 to 35 per cent.

It was explained that ground light reaches the work plane by interreflectance from upper walls and ceilings and, therefore, may improve the uniformity of illumination and the brightness ratios by producing more light on work areas farthest from the windows than is received directly from the sky. Maximum input of daylight from ground and sky is achieved by large window areas of clear glass. Data from the studies will enable engineers and architects to more closely evaluate daylighting requirements and results.

## SAN FRANCISCO BUILDING SITES

(From Page 5)

Lee, there developed a demand for the steeper hill slopes for residential and institutional sites.

"These areas," the speaker went on, "present a

problem of stability, arising from the necessity of disturbing the natural slope by cutting and filling. Where proper precautions have not been taken, disastrous slides have resulted. The economic development of these areas to provide safety and stability is one of the difficult current foundation problems."

Reaching back into far ages for Nature's engineering of the area, Lee said:

"It is probable the flooding of the Bay of San Francisco resulted from the rise of the ocean level which occurred with the melting of the great continental ice fields at the end of the last glacial advance. This occurred some 15,000 or 25,000 years ago and produced a rise in ocean level variously estimated at about 330 feet. There may also have been minor crustal movements.

"With the original mouth of the great river at the west of the Golden Gate, as seems probable, the effect of the 330-foot rise was to flood the valley of San Francisco Bay and all its tributary stream systems to the present bay level. The valley thus was drowned by salt water invasion and became a trap for most of the sediments discharged into it by tributary streams."

Lee is Chairman of Soils Mechanics and Foundations Committee of the San Francisco Section of the American Society of Civil Engineers.

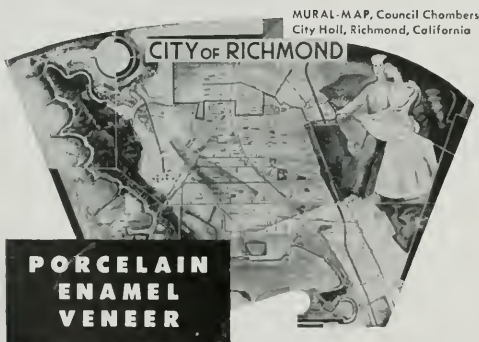

**Dramatize** your next design with the fired-in richness and complete flexibility of permanent PORCELAIN ENAMEL VENEER. Be it mural, map or expressive concept... PORCELAIN ENAMEL adapts, enhances, belongs.

Architect: Milton Pflueger

Muralist: Sargent Johnson

*Architectural Division*

PORCELAIN ENAMEL PUBLICITY BUREAU  
P. O. BOX 186, EAST PASADENA STATION, PASADENA 8, CALIFORNIA  
ROOM 601, FRANKLIN BUILDING, OAKLAND 12, CALIFORNIA

## GOLDEN GATE PLAYGROUND

(From Page 7)

well equipped kitchen. A large room opens onto an enclosed terrace with barbecue grill and dining tables at one end and ping-pong tables at the other. These ping-pong tables are an innovation of the recreation department and are made entirely of steel which needs no painting and stands up well under the heaviest usage. The director's office overlooks all play areas. Floors throughout are of asphalt tile and wall finishes are of masonry, plywood or plaster as use demands. All lighting fixtures are of modern design.

A 400 sq. ft. locker room adjoining the baseball field houses showers, wash rooms, and team lockers. It is constructed of 16 inch concrete blocks.

The backstops for the baseball and softball diamonds are constructed of vertical grain Douglas Fir with special designed movable wings of chain link fencing to control foul balls. These wings are placed seven feet above the ground.

Basketball backstop boards are of waterproof

plywood with adjustable brackets, another new design inaugurated by the Recreation Department. Bleachers are unique in that they use a 14 inch diameter rear column which eliminates the need for lateral bracing. This design gives a very rigid construction and will be a boon and time saver to clean-up and maintenance of the grounds.

## ARCHITECT - PRESS RELATIONS

(From Page 25)

genuity and the amount of effort they are willing to expend. Six of the major fields are listed below.

1. **Preliminary Designs**—Anything new is news, particularly when it is building a better community. When the Architect presents the pictures and write-up, including a credit line, he will find the newspaper grateful and cooperative. The article should cite the architectural problem and its interesting solution, thus making the public more observant and appreciative when the building is completed. When this task is left to the owner, in all probability the credit line will be forgotten and the write-up will cover the cost of the building and little more. The omission of the credit is then the Architect's fault by default, and **not the editor's**. When the owner employs an advertising agency the Architect should volunteer his help, which will be accepted since the writer will need help on the nomenclature. In return for this help he will be glad to include proper credits after the Architect has explained its importance. **Do not be timid.**

2. **During Construction**—This field has barely been touched. In items the Architect considers commonplace, the Editor finds a wealth of interest to his thousands of Sidewalk-Superintendent readers. The possibilities are endless—an interesting camera angle of a pile-driver at work; a crane lifting a steeple onto a tower; a steeple-jack attaching the cross; a lift-slab or tilt-up job; any interesting excavation equipment; the installation of floor pans for warm-air radiant heating job is good for a story relating it to the Roman Baths. Anything that is unusual or interesting to the general public the newspapers want and will depend on you to call it to their attention. All such stories show the indispensable part the Architect plays in the community.

3. **Completed Work**—The opening of any public or business building is of vital interest to the newspaper, since it will doubtless result in advertising. The Architect should offer his services in preparing the write-up as outlined under **Preliminary Designs** and if the owner has special advertising for the opening, additional news copy will be required to fill out the page. Advertising agents consider that Architects add prestige to projects, and will often do an article on the Architect for the project.

(To Be Concluded Next Month)

## Parker, Steffens & Pearce

BUILDERS

135 South Park, San Francisco

Phone: EXbrook 2-6639

## BARRETT & HILP CONTRACTORS

*Serving The Construction Field  
Since 1912*

OUR FORTIETH YEAR

918 Harrison Street • San Francisco  
Telephone DOuglas 2-0700

## CLASSIFIED ADVERTISING

Do YOU want to hire, buy, sell, rent, find, lose, and otherwise transact business with others in the Construction Industry? If so, your best bet is a CLASSIFIED ad in ARCHITECT & ENGINEER magazine.

SELL that used equipment at a good price; secure competent employees; buy good used equipment; obtain information on wanted materials, etc.

Rates are low 20 cents per word—cash with order—minimum 3 lines. "Position Wanted" ads are half-rate. Forms close 20th of month preceding date of publication.

## ARCHITECT & ENGINEER MAGAZINE

68 Post Street

San Francisco

## FORDERER CORNICE WORKS

*Manufacturers of*

Hollow Metal Products • Interior Metal Trim  
Elevator Fronts and Cabs  
Metal Plaster Accessories • Sanitary Metal Base  
Flat and Roll Metal Screens  
Metal Cabinets • Commercial Refrigerators

269 POTRERO AVE.

SAN FRANCISCO, CALIF.

HEMLOCK 1-4100



# HOGAN LUMBER CO.

Wholesale and Retail

## LUMBER

MILL WORK • SASH & DOORS

Office, Mill, Yard and Docks

SECOND AND ALICE STREETS • OAKLAND, CALIF.

Telephone GLencaurt 1-6861

# ALLIANCE ENGINEERS

C. L. WEEKS

Civil Engineer No. 4943

COST ENGINEERS  
QUANTITY SURVEYORS  
APPRAISERS

★ Preliminary & Final Estimates ★

602 West Santa Barbara Avenue  
Los Angeles 37, California  
ADams 3-7138

# JUDSON PACIFIC-MURPHY CORP.

Steel Fabricators  
and  
Erectors

REINFORCING STEEL  
STRUCTURAL STEEL  
BRIDGE CRANES

4300 EASTSHORE HWY.  
EMERYVILLE, CALIF.

Phone:  
OL 3-1717

# CLINTON CONSTRUCTION CO. OF CALIFORNIA

General Contractors

923 FOLSOM STREET • SAN FRANCISCO

SUtter 1-3440

## BOOK REVIEWS PAMPHLETS AND CATALOGUES

**MANUAL OF MILLWORK.** Woodwork Institute of California, 681 Market St., San Francisco. Price \$5.00.

A comprehensive compilation of specification of qualities, methods, and workmanship requisite to the production of Architectural Millwork prepared by the Woodwork Institute of California.

Contains technical information, specifications data, production standards, and a directory of members of the Institute.

The standards were determined by a Technical Committee representing mills, and may be accepted in full confidence as presenting the best of sound and practical methods in the production of good millwork.

**FONDATION ENGINEERING.** By Peck, Hanson & Thornburn. John Wiley & Sons, Inc., 440 4th Ave., New York 16. Price \$6.75.

Foundation Engineering, written by Ralph B. Peck, Walter E. Hanson, and Thomas H. Thornburn, develops and utilizes knowledge of soil mechanics and presents a vast store of practical engineering information essential to the foundation engineer. Subject matter has been rigidly selected to meet demands of the present or future designer and constructor of foundations.

The book is arranged in four parts which develop the material in logical sequence: Part "A" is suitable for a text in basic soil mechanics; Part "B" contains descriptive matter concerning foundation practice; Part "C" develops in the reader the ability to select the most appropriate foundation for whatever sub-surface conditions he may meet; Part "D" presents the elements of structural design in commonly used foundations and retaining structures.

Emphasis is placed on the ordinary types of foundation which the reader is most likely to deal in practice.

**AN APPROACH TO URBAN PLANNING.** By Gerald Breese and Dorothy E. Whiteman. Princeton University Press, Princeton, N. J. Price \$2.00.

The book has been compiled under editorial sponsorship of The Bureau of Urban Research of Princeton University and contains a wealth of information on the study of urban problems incidental to the haphazard growth of American urban areas and basic principles of solution.

Analysis is made in seven major classifications with a number of papers presented by outstanding experts in the field. Notes on the contributors and a list of suggested papers, books and pamphlets for further reading is included in the book.

## NEW CATALOGUES AVAILABLE

Any of the catalogues or folders described here may be obtained by forwarding your request as indicated in the coupon below to the office of the ARCHITECT & ENGINEER. Merely mark the items you want and clip or paste the coupon to your letterhead.

**455. DUST FILTER BULLETIN.** A new illustrated dust filter bulletin dealing with all the aspects of dust control as achieved by the Hersey-type dust filter has just been released by The Day Company, of Minneapolis, manufacturers of the Day "AC" Dust Filter. The company feels that this bulletin fills a long felt need in view of the great number of "AC" dust filters now in use throughout this country and in Canada. It presents a practical approach to dust control problems and stresses the advantages of Day "AC" Filters with the Hersey principle, which is a continuous-automatic method of cleaning the filter cloth with high pressure reverse jet air. By this method filter shut-downs for cleaning or rapping are eliminated, it is pointed out. Bulletin No. 528, The Day Company, 810 Third Ave. N. E., Minneapolis 13, Minn.

**456. NEW SKYLIGHT GLASS BLOCK.** Pittsburgh Corning announces its new SKYTROL Glass Block. This new block is specially designed for use in skylights both structurally and optically. This light-diffusing glass block is a 12" x 12" square, 4" thick. The design and daylighting advantages of skylights have been recognized for hundreds of years. However, problems of condensation, glare, heat gain and loss have been a serious stumbling block to the popularity of skylights. The Pittsburgh Corning skylight block was designed to overcome these problems. The normally good insulating value of the

glass block has been increased by the addition of a fibrous glass screen sealed in the block, creating a double cavity. This screen not only gives a better insulating characteristic to the block (U=0.43), but offers better daylighting control by diffusing the light. The screen in addition to the skylight block's internal prisms and Scot-Lite Edge assure evenly diffused daylight from a panel of uniform illumination. The Pittsburgh Corning SKYTROL Glass Block is designed to relieve the common problems associated with skylight construction.

**457. SWIMMING POOL CONSTRUCTION PORTFOLIO.** A complete construction portfolio (A.I.A. file 35-F-2) is now available to architects and builders. It is published by Landon Inc., pioneer California swimming pool engineering and equipment firm. The portfolio includes bulletin B-1 "How To Build a Swimming Pool", "Public Pool Bulletin C-1", and engineered typical plans for form poured, gunite and concrete block pools. The kit also includes a Landon Equipment Catalog, cost estimating forms and price list order forms. The portfolio is available to architects, builders and building material dealers without charge. Write Landon Inc., 5920 Sepulveda Boulevard, Van Nuys, California.

**458. NEW PLASTIMENT BOOKLET.** The theory and practice of obtaining a good concrete is the subject of a new booklet, "Plastiment Concrete Densifier," published by Sika Chemical Corporation, of Passaic, New Jersey. Beginning with the gel mechanics of cement-water reaction, the booklet discusses the factors affecting cement hydration and basic quality of concrete, and how these factors can be controlled to reduce cracking and increase concrete hardness and impermeability. The booklet covers 8 pages of engineering information, illustrated with drawings, tests, photographs and descriptions of outstanding engineering projects constructed with Plastiment concrete. A.I.A. File No. 7, 8 pages illus., 2/10/52.

**459. ENGINEERING TEST REPORT ON INSULATED PIPE.** Durant Insulated Pipe Company offers a 6 page report on simulated operating tests made on D. I. P. The bulletin contains details on methods, temperature recordings and results of recent tests made by an independent engineering firm to determine (1) temperatures developed in and near D. I. P. conduit buried 48" underground, and (2) effects of water and high temperature on D. I. P. casing. Copies are available from the Western Division at Palo Alto, California, or from the Eastern Division (Durant International Corporation) at Williamstown, N. J.

**460. GYPSUM LATH AND SHEATHING.** Two new illustrated pamphlets dealing with gypsum lath and gypsum sheathing have been prepared by the Gypsum Association and may be obtained on request from the Association. The pamphlets describe the uses, physical properties and recommended methods of installation of these fireproof materials. Also included are detailed architectural specifications. Requests for the free pamphlets should be addressed to the Gypsum Association, 20 North Wacker Dr., Chicago 6, Ill.

**461. ADVANCEMENTS IN WOOD RESEARCH.** Developments in timber engineering and research that enable architects and engineers to use lumber more advantageously with resulting economies in time, material and labor, are described in the new 32-page booklet, "Advancements in Wood Research and Timber Engineering", just issued by Timber Engineering Company, affiliate of National Lumber Manufacturers Association. The colorful new booklet is a profusely illustrated, comprehensive story of Tecco's overall activities in timber engineering, timber connector sales, and wood research. A copy is available on request to Timber Engineering Company, 1319 - 18th Street, N. W., Washington 6, D. C.

**462. SELECTION AID MANUAL FOR AIR DIFFUSERS.** A new 64-page Selection Manual No. 45, 1953, containing comprehensive technical data for simplifying choice of proper air diffusers in air conditioning systems has been announced by Anemostat Corporation of America, 10 East 39th Street, New York, N. Y. Now in its third revised edition, the Anemostat Manual contains a complete new section on Duct Take-off Design. Generously illustrated with photographs, tables on performance data, and case examples, the manual shows how proper locations and correct number of required units are determined.

**ARCHITECT AND ENGINEER**

68 Post Street, San Francisco, Calif.

I would like to have a copy of each of the New Catalogues I have circled.

455      456      457      458      459  
460      461      462

Please send to the address on my letterhead, or as I have indicated, and to my attention. (Please print your name — no literature will be sent on this coupon after April, 1953—A. & E.)

**The Most Complete Line of  
STEELS and STEEL BUILDING MATERIALS  
Made by a Single Producer**



See Sweet's Catalog File or write us for full information.

**REPUBLIC STEEL CORPORATION**

GENERAL OFFICES: CLEVELAND, OHIO

DENVER, COLORADO . . . . . CONTINENTAL OIL BUILDING  
LOS ANGELES, CALIF. . . . . GENERAL PETROLEUM BUILDING  
SAN FRANCISCO, CALIFORNIA . . . . . RIALTO BUILDING  
SEATTLE, WASH. . . . . WHITE-HENRY-STUART BUILDING

**PACIFIC  
MANUFACTURING CO.**

**High Class Interior Finish Quality  
Millwork**

16 Beale St., San Francisco  
GARfield 1-7755

2215 El Camino Real, San Mateo  
S. M. 5-0687

304 Bryant Street, Palo Alto  
P. A. 3373

2610 The Alameda, Santa Clara  
S. C. 607 (Factory)

6820 McKinley Avenue, Los Angeles  
THornwall 4196

MAIN OFFICE — SANTA CLARA

**"AMERICAN - MARSH"  
CONDENSATION UNIT**

Pumping  
Machinery  
for  
Every  
Purpose

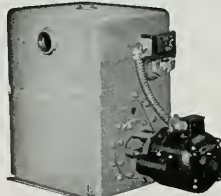

For Service  
Call  
DOuglas  
2-6794  
or  
MUtual 8322

**SIMONDS MACHINERY CO.**  
SAN FRANCISCO 816 FOLSOM  
LOS ANGELES 455 EAST 4TH

**VERMONT  
MARBLE COMPANY**

**DOMESTIC AND IMPORTED MARBLES  
GRANITE VENEER**

525 MARKET STREET • SAN FRANCISCO 5  
Phone: SUTter 1-6747

3522 COUNCIL STREET • LOS ANGELES 4  
Phone: DUmkirk 2-7834

## NEWS & COMMENT ON ART

(From Page 4)

entation of outstanding works of Bay Area Architects since 1933.

Paintings, Drawings and Gouaches by Henry Koerner, and Early American Silver, from the Mark Bortman Collection.

### TERMINATION OF BENDER GRANTS IN ART

The Board of Trustees of the Albert M. Bender Memorial Fund recently announced termination of the Grants-in-Aid in the fields of painting, literature, and photography.

The residuum of the Trust Fund has been given to the San Francisco Art Association and will be known as the Albert M. Bender Revolving Fund.

### CALIFORNIA SCHOOL OF FINE ARTS

A Film Seminar which includes the screening and analysis of important motion pictures no longer available to the general public, is being offered by the California School of Fine Arts, 800 Chestnut Street, San Francisco.

Two sessions are planned, the first will start the latter part of February, and the second will start on April 24, and will be held each Friday evening

for a period of nine weeks.

Classes are under the direction of Robert Katz, former assistant chief of Production Planning International Motion Picture Division of the United States Department of State, and formerly deputy chief of Long Range Operations of the Office of War Information.

### CALIFORNIA PAINTERS EXHIBIT de YOUNG MEMORIAL MUSEUM

William Brice, Robert Chue, Channing Peake and Howard Warsaw, four of California's outstanding artists, have an exhibit of twenty-eight paintings at the M. H. deYoung Memorial Museum, Golden Gate Park, San Francisco.

The exhibition was organized by the Frank Perls Gallery in Beverly Hills and represents the artists' works during the last five years.

### BOOK DISPLAY AT CALIFORNIA SCHOOL OF FINE ARTS

An exhibition of books designed by J. B. Goetz, production manager of the University of California Press in Berkeley, is being exhibited at the California School of Fine Arts, 800 Chestnut Street, San Francisco.

Books by Goetz have won awards in the Fifty Best Books of the Year annual competition, in the Western Book Show, the Jacket Designers' Guild competition and in national competitions for text book designing.

### FESTIVAL OF CONTEMPORARY ART UNIVERSITY OF OREGON

The art presented in the current Festival of Contemporary Art at the University of Oregon, under the direction of Bertram E. Jessup, Associate Professor of Philosophy, is not just an exhibition of art which happens to have been produced in our time, but is an exhibition of art which could not have been produced at any other time.

The program includes a wide variety of selection in the fields of visual arts, dance, music, literature and aesthetics, drama, and motion picture. Exhibits and events are held in various halls and auditoriums at the University.

### CONTRACTORS IN MIAMI STUDY NATION'S NEEDS

General contractors of the nation attending the 34th Annual Convention of The Associated General Contractors of America in Miami this month, will focus their attention sharply on the twin task of carrying forward defense construction and an expanded program of civilian projects.

More than 80 per cent of the contract construction work in this country is performed annually by A.G.C.'s more than 6200 members.

## VALUABLE NEWS SERVICE

- BUILDING MATERIAL DEALERS
- CONTRACTORS
- SUB-CONTRACTORS
- MANUFACTURERS AND REPRESENTATIVES

**ARCHITECTS REPORTS** gives advance news on construction projects in Northern California, lists: name of projects, location, architect, proposed cost and other pertinent information.

**HANDY** individual slip-reports, issued daily at a total cost of only

\$10 a month

## ARCHITECT'S REPORTS

Published Daily

The ARCHITECT and ENGINEER, Inc.

68 Post Street, San Francisco - DO 2-8311



# ESTIMATOR'S GUIDE

## BUILDING AND CONSTRUCTION MATERIALS

PRICES GIVEN ARE FIGURING PRICES AND ARE MADE UP FROM AVERAGE QUOTATIONS FURNISHED BY MATERIAL HOUSES TO SAN FRANCISCO CONTRACTORS. 3% SALES TAX ON ALL MATERIALS BUT NOT LABOR

All prices and wages quoted are for San Francisco and the Bay District. There may be slight fluctuation of prices in the interior and southern part of the state. Freight cartage, at least, must be added in figuring country work.

**BONDS**—Performance or Performance plus Labor and Material Bond(s), \$10 per \$1000 on contract price. Labor & Material Bond(s) only, \$5.00 per \$1000 on contract price.

**BRICKWORK—MASONRY—**

Common Brick—Per 1 M laid—\$150.00 up (according to class of work).  
Face Brick—Per 1 M laid—\$200.00 and up (according to class of work).  
Brick Steps—\$3.00 and up.  
Common Brick Veneer on Frame Bldgs.—Approx. \$1.20 and up (according to class of work).  
Face Brick Veneer on Frame Bldgs.—Approx. \$2.00 and up (according to class of work).  
Common Brick—\$36.00 per M truckload lots, delivered.  
Face Brick—\$81.00 to \$106.00 per M, truckload lots, delivered.

**Glazed Structural Units—Walls Erected—**

Clear Glazed—  
2 x 6 x 12 Furring..... \$2.00 per sq. ft.  
4 x 6 x 12 Partition..... 2.25 per sq. ft.  
4 x 6 x 12 Double Faced Partition..... 3.00 per sq. ft.  
For colored glaze add .30 per sq. ft.  
Mantel Fire Brick \$150.00 per M—F.O.B. Pittsburg.

Fire Brick—Per M—\$111.00 to \$147.00.  
Cartage—Approx. \$10.00 per M.  
Paving—\$75.00.

**Building Tile—**

8x5/2x12-inches, per M ..... \$139.50  
6x5/2x12-inches, per M ..... 105.00  
4x5/2x12-inches, per M ..... 84.00

**Hollow Tile—**

12x12x2-inches, per M ..... \$146.75  
12x12x3-inches, per M ..... 156.85  
12x12x4-inches, per M ..... 177.10  
12x12x6-inches, per M ..... 235.30  
F.O.B.—Plant

**BUILDING PAPER & FELTS—**

1 ply per 1000 ft. roll ..... \$5.30  
2 ply per 1000 ft. roll ..... 7.80  
3 ply per 1000 ft. roll ..... 9.70  
Brownkin, Standard 500 ft. roll ..... 6.85  
Siskroff, reinforced, 500 ft. roll ..... 8.50

**Sheathing Papers—**

Asphalt sheathing, 15-lb. roll ..... \$2.70  
Dampcourse, 216-ft. roll ..... 2.95  
Blue Paperboard, 60-lb. roll ..... 5.10

**Felt Papers—**

Deadenng felt, 3/4-lb., 50-ft. roll ..... \$4.30  
Deadenng felt, 1-lb. .... 5.05  
Asphalt roofing, 15-lbs. .... 2.70  
Asphalt roofing, 30-lbs. .... 3.70

**Roofing Papers—**

Standard Grade, 108-ft. roll, Light ..... \$2.50  
Smooth Surface, Medium ..... 2.90  
Heavy ..... 3.40  
M. S. Extra Heavy ..... 3.95

**BUILDING HARDWARE—**

Sash cord com. No. 7 ..... \$2.65 per 100 ft.  
Sash cord com. No. 8 ..... 3.00 per 100 ft.  
Sash cord spot No. 7 ..... 3.85 per 100 ft.  
Sash cord spot No. 8 ..... 3.35 per 100 ft.  
Sash weights, cast iron, \$100.00 ton.  
1-Ton lots, per 100 lbs. .... \$3.75  
Less than 1-ton lots, per 100 lbs. .... 4.75

Nails, per keg, base. .... \$12.55  
8-in, spikes ..... 12.45  
Rim Knob lock sets ..... \$1.80  
Butts, dull brass plated on steel, 3/2x3/2 ..... .76

**CONCRETE AGGREGATES—**

The following prices net to Contractors unless otherwise shown. Carload lots only.

	Bunker per ton	Del'd per ton
Gravel, all sizes.....	\$2.44	\$2.90
Top Sand.....	2.38	3.13
Concrete Mix.....	2.38	3.04
Crushed Rock, 1/2" to 3/4".....	2.38	2.90
Crushed Rock, 3/4" to 1 1/2".....	2.38	2.90
Roofing Gravel.....	2.81	2.90
River Sand.....	2.50	3.00
<b>Sand—</b>		
Lapis (Nos. 2 & 4).....	3.56	3.94
Olympia (Nos. 1 & 2).....	3.56	3.88

**Cement—**

Common (all brands, paper sacks), Per Sack, small quantity (paper) ..... \$1.05  
Carload lots, in bulk, per bbl.) ..... 3.55  
Cash discount on carload lots, 10c a bbl., 10th Prox., less than carload lots, \$4.00 per bbl. f.o.b. warehouse or delivered.  
Cash discount 2%, on L.C.L.  
Trinity White, { 1 to 100 sacks, \$3.50 sack  
warehouse or del.; \$9.56  
Medusa White, { bbl. carload lots.

**CONCRETE READY-MIX—**

Delivered in 4-yd. loads:  
Per cubic yard, 1-8 Mix..... \$ 9.80  
1-7 Mix..... 10.15  
1-6 Mix..... 10.70  
1-5 Mix..... 11.40  
Curing Compound, clear, drums, per gal. .... 1.03

**CONCRETE BLOCKS—**

	Haydite \$-19	8a-salt \$-19
4x8x16-inches, each.....	.23	.25
6x8x16-inches, each.....	.27	.27
12x8x16-inches, each.....	.38	.40
12x8x24-inches, each.....	.....	.60
<b>Haydite Aggregates—</b>		
3/4-inch to 3/8-inch, per cu. yd.....	\$7.75	
3/8-inch to 1/2-inch, per cu. yd.....	7.75	
No. 6 to 0-inch, per cu. yd.....	7.75	

**DAMP-PROOFING and Waterproofing—**

Two-coat work, \$9.00 per square.  
Membrane waterproofing—4 layers of saturated felt, \$10.00 per square.  
Hot coating work, \$5.00 per square.  
Medusa Waterproofing, \$3.50 per lb. San Francisco Warehouse.  
Tricocon concrete waterproofing, 60c a cubic yd. and up.

**ELECTRIC WIRING—**\$15 to \$20 per outlet for conduit work (including switches). Knob and tube average \$6.00 per outlet.

**ELEVATORS—**

Prices vary according to capacity, speed and type. Consult elevator companies. Average cost of installing a slow speed automatic passenger elevator in small four story apartment building, including entrance doors, about \$9,500.00.

**EXCAVATION—**

Sand, \$1.00; clay or shale, \$1.50 per yard. Trucks, \$3.00 to \$45 per day.

Above figures are an average without water. Steam shovel work in large quantities, less; hard material, such as rock, will run considerably more.

**FIRE ESCAPES—**

Ten-foot galvanized iron balcony, with stairs, \$250 installed on new buildings; \$300 on old buildings.

**FLOORS—**

Asphalt Tile, 1/8 in. gauge 18c to 35c per sq. ft.  
Composition Floors, such as Magnesite, 40c-\$1.25 per sq. ft.  
Linoleum, standard gauge, sq. yd.... \$2.75  
Masticpave—\$1.50 per sq. yd.  
Battleship Linoleum—1/8"—\$3.00 sq. yd.  
Terrazo Floors—\$2.00 per sq. ft.  
Terrazo Steps—\$2.50 per lin. ft.  
Mastic Wear Coat—according to type—20c to 35c.

**Hardwood Flooring—**

**Oak Flooring—T & G—Unfin.**

	\$2x2 1/2	1 1/2 x 2	3/4 x 2	1/2 x 2
Clear Old, White.....	\$425	\$405	\$405	\$425
Clear Old, Red.....	405	380	380	405
Select Old, Red or White.....	355	340	340	355
Clear Pln., Red or White.....	355	340	335	315
Select Pln., Red or White.....	340	330	325	300
#1 Common, Red or White 315	310	310	305	280
#2 Common, Red or White 305	305	305	305	280

**Prefinished Oak Flooring—**

	Prime	Standard
1/2 x 2.....	\$369.00	\$359.00
1/2 x 2 1/2.....	380.00	370.00
3/4 x 2.....	390.00	381.00
2 1/4.....	375.00	355.00
2 1/2.....	395.00	375.00
2 3/4 x 3 1/4 Ranch Plank.....	415.00	

**Unfinished Maple Flooring—**

1 1/2 x 2 1/4 1st Grade.....	\$390.00
1 1/2 x 2 1/4 2nd Grade.....	365.00
1 1/2 x 2 1/4 2nd & Btr. Grade.....	375.00
1 1/2 x 2 1/4 3rd Grade.....	380.00
1 1/2 x 3 1/4 3rd & Btr. Jtd. EM.....	390.00
1 1/2 x 3 1/4 2nd & 1st. Jtd. EM.....	400.00
33/32 x 2 1/4 2nd Grade.....	360.00
33/32 x 2 1/4 3rd Grade.....	320.00
Floor Layer Wage \$2.60 hr.	

**GLASS—**

Single Strength Window Glass.....	\$ .30 per ft.
Double Strength Window Glass.....	.45 per ft.
Plate Glass, 1/4 polished to 75.....	1.60 per ft.
75 to 100.....	1.74 per ft.
1/4 in. Polished Wire Plate Glass.....	2.50 per ft.
1/4 in. Rgt. Wire Glas.....	.80 per ft.
1/4 in. Obscure Glass.....	.44 per ft.
3/8 in. Obscure Glass.....	.63 per ft.
1/2 in. Heat Absorbing Obscure.....	.54 per ft.
1/2 in. Heat Absorbing Wire.....	.72 per ft.
3/8 in. Ribbed.....	.44 per ft.
1/2 in. Ribbed.....	.63 per ft.
3/8 in. Rough.....	.44 per ft.
1/2 in. Rough.....	.63 per ft.
3/8 in. Rough.....	.44 per ft.
Glazing of above additional \$ .15 to	.30 per ft.
Glass Blocks, set in place.....	3.50 per ft.

**HEATING—**

**Furnaces—Gas Fired**

Floor Furnace, 25,000 BTU.....	\$ 70.50
35,000 BTU.....	77.00
45,000 BTU.....	90.50
Automatic Control, Add.....	39.00
Dual Wall Furnaces, 25,000 BTU.....	91.50
35,000 BTU.....	99.00
45,000 BTU.....	117.00
With Automatic Control, Add.....	39.00
Unit Heaters, 50,000 BTU.....	202.00
Gravity Furnace, 65,000 BTU.....	198.00
Forced Air Furnace, 75,000 BTU.....	313.50

**Water Heaters—1-year guarantee**  
With Thermostat Control,  
20 gal. capacity..... 87.50  
30 gal. capacity..... 103.95  
40 gal. capacity..... 120.00

**INSULATION AND WALLBOARD—**

Rockwool Insulation—	
(2") Less than 1,000 sq. ft. . . . .	\$64.00
(2") Over 1,000 sq. ft. . . . .	59.00
Cotton Insulation—Full thickness	
(3%) . . . . .	\$95.50 per M sq. ft.
Sisalation Aluminum Insulation—Aluminum	
coated on both sides . . . . .	\$23.50 per M sq. ft.
Tileboard—4'x6' panel . . . . .	\$9.00 per panel
Wallboard—1/2" thickness . . . . .	\$55.00 per M sq. ft.
Finished Plank . . . . .	69.00 per M sq. ft.
Ceiling Tileboard . . . . .	69.00 per M sq. ft.

**IRON—**Cost of ornamental iron, cast iron, etc., depends on designs.

**LUMBER—**

S4S No. 2 and better common	
O.P. or D.F., per M. f.b.m. . . . .	\$100.00
Rough, No. 2 common O.P. or	
D.F., per M. f.b.m. . . . .	95.00

**Flooring—**

V.G.-D.F. B & Btr. 1 x 4 T & G Flooring	Per M Delvd.	\$275.00
"C" and better—all		225.00
"D" and better—all		225.00
Rwd. Rustic—"A" grade, medium dry, 8 to 24 ft		185.00

Plywood, per M sq. ft.	
1/2-inch, 4.0x8-515 . . . . .	\$135.00
1/2-inch, 4.0x8-515 . . . . .	219.00
3/4-inch, per M sq. ft. . . . .	292.00
Physcord . . . . .	11 1/2¢ per ft.
Plyform . . . . .	25¢ per ft.

**Shingles (Rwd. not available)—**

Red Cedar No. 1—\$9.50 per square; No. 2, \$7.00; No. 3, \$5.00.	
Average cost to lay shingles, 56.00 per square.	
Cedar Shakes—1/2" to 3/4" x 24/26 in handsplit tapered or split resawn, per square . . . . .	\$15.25
3/4" to 1 1/4" x 24/26 in split resawn, per square . . . . .	17.00
Average cost to lay shakes, \$8.00 per square.	

**Pressure Treated Lumber—**

Wolmanized . . . . .	Add \$35 per M to above
Crested, 8-lb. treatment . . . . .	Add \$45 per M to above

**MARBLE—**(See Dealers)

**METAL LATH EXPANDED—**

Standard Diamond, 3/40, Copper	
Bearing, LCL, per 100 sq. yds. . . . .	\$43.50
Standard Ribbed, ditto . . . . .	\$47.50

**MILLWORK—**Standard.

D. F. \$150 per 1000, R. W. Rustic \$175 per 1000 (delivered).
Double hung bow window frames, average with trim, \$12.50 and up, each.
Complete door unit \$15 to \$25.
Screen doors, \$8.00 to \$12.00 each.
Patent screen windows, \$1.25 a sq. ft.
Cases for kitchen pantries seven ft. high per lineal ft., upper \$9.00 to \$11.00; lower \$12.00 to \$13.00.
Dining room cases, \$20 per lineal foot
Rough and finish about \$1.00 per sq. ft.
Labor—Rough carpentry warehouse heavy framing (average), \$75.00 per M.
For smaller work average, \$5.00 to \$10.00 per 1000.

**PAINTING—**

Two-coat work . . . . .	per yard 85¢
Three-coat work . . . . .	per yard \$1.10
Cold water painting . . . . .	per yard 25¢
Whitewashing . . . . .	per yard 15¢

<b>Linseed Oil, Strictly Pure</b>		<b>Wholesale</b>
(Basis 7 1/2 lbs. per gal)		<b>Raw</b>
Light row drums . . . . .	per gal	\$2.28
5-gallon cans . . . . .	per gal	2.40
1-gallon cans . . . . .	each	2.52
Quart cans . . . . .	each	2.72
1/2 pint cans . . . . .	each	3.38
1/4 pint cans . . . . .	each	2.24
<b>Turpentine</b>		<b>Pure Gum</b>
(Basis 7 1/2 lbs. per gal)		<b>Spirits</b>
Light row drums . . . . .	per gal	\$1.65
5-gallon cans . . . . .	per gal	1.76
1-gallon cans . . . . .	each	1.88
Quart cans . . . . .	each	2.00
1/2 pint cans . . . . .	each	2.12

**Pioneer White Lead in Oil Heavy Paste and All-Purpose (Soft-Paste)**

Net Weight Packages	List Price		Price to Painters	
	Per 100 lbs.	Pr. per pkg.	Per 100 lbs.	Pr. per pkg.
100-lb. kegs	\$28.35	\$29.35	\$27.50	\$27.50
50-lb. kegs	30.05	15.03	28.15	14.08
25-lb. kegs	30.35	7.50	28.45	7.12
5-lb. cans*	33.35	1.34	31.25	1.25
1-lb. cans*		.36	33.75	.34
500 lbs. (one delivery)	3/4¢ per pound less than above.			

\*Heavy Paste only.  
**Pioneer Dry White Lead—Litharge—Dry Red Lead Red Lead in Oil**

Dry White Lead	Price to Painters—Price Per 100 Pounds		
	100 lbs.	50 lbs.	25 lbs.
Litharge . . . . .	\$26.30	\$5	\$
Dry Red Lead . . . . .	25.95	26.60	26.90
Dry Red Lead . . . . .	27.20	27.85	28.15
Red Lead in Oil . . . . .	30.65	31.30	31.60

1 Pound cans, \$37 per lb.

**PATENT CHIMNEYS—**

6-inch . . . . .	\$2.50 lineal foot
8-inch . . . . .	3.00 lineal foot
10-inch . . . . .	4.00 lineal foot
12-inch . . . . .	5.00 lineal foot

**PLASTER—**

Neat wall, per ton delivered in S. F. in paper bags, \$17.60.

**PLASTERING (Interior)—**

3 Coats, metal lath and plaster	Yard	\$3.00
Keene cement on metal lath		3.50
Ceilings with 3/4 hot roll channels metal lath (lathed only)		3.00
Ceilings with 3/4 hot roll channels metal lath plastered		4.50
Single partition 3/4 channel lath 1 side (lath only)		3.00
Single partition 3/4 channel lath 2 inches thick plastered		8.00
4-inch double partition 3/4 channel lath 2 sides (lath only)		5.75
4-inch double partition 3/4 channel lath 2 sides plastered		8.75
Thermax single partition; 1" channels; 2 1/4" overall partition width. Plastered both sides		7.50
Thermax double partition; 1" channels; 4 3/4" overall partition width. Plastered both sides		11.00
3 Coats over 1" Thermax nailed to one side wood studs or joists		4.50
3 Coats over 1" Thermax suspended to one side wood studs with spring used isolation clip		5.00

Note—Channel lath controlled by limitation orders.

**PLASTERING (Exterior)—**

2 coats cement finish, brick or concrete wall	Yard	\$2.50
3 coats cement finish, No. 18 gauge wire mesh		3.50
Lime—\$4.00 per bb. at yard.		
Processed Lime—\$4.15 per bbl. at yard		
Rock or Grip Lath—3/4"—30¢ per sq. yd		
1 1/2"—29¢ per sq. yd.		
Composition Stucco—\$4.00 sq. yd. (applied).		

**PLUMBING—**

From \$200.00 per fixture up according to grade, quality and runs.

**ROOFING—**

Standard tar and gravel 4 p y	\$13.00
per sq for 30 sqs. or over.	
Less than 30 sqs. \$16.00 per sq	
Tile \$40.00 to \$50.00 per square	
No. 1 Redwood Shingles in place	\$18.25
4 1/2 in. exposure per square	
5 2 No. 1 Cedar Shingles 5 in exposure per square	4.50
5 8 x 16"—No. 1 Little Giant Cedar Shingles 5" exposure per square	18.25
4 2 No. 1 24" Royal Cedar Shingles 7 1/2" exposure per square	23.00
Per sq with Gravel \$5.00 per sq.	

Asbestos Shingles, \$27 to \$35 per sq. laid	
1/2 to 3/4 x 25" Resawn Cedar Shakes, 10" Exposure . . . . .	\$30.00
3/4 to 1 1/4 x 25" Resawn Cedar Shakes, 10" Exposure . . . . .	\$35.00
1 x 25" Resawn Cedar Shakes, 10" Exposure . . . . .	\$22.00

Above prices are for shakes in place.

**SEWER PIPE—**

C.I., 6-in. to 24-in. B. & S. Class B and heavier, per top . . . . .	\$99.50
Vitrified, per foot: L.C.L. F.O.B. Warehouse, San Francisco.	
Standard, 8-in. . . . .	\$ .66
Standard, 12 in. . . . .	1.30
Standard, 24-in. . . . .	5.41
Clay Drain Pipe, per 1,000 L.F.	
L.C.L., F.O.B. Warehouse, San Francisco:	
Standard, 6-in. per M . . . . .	\$240.00
Standard, 8-in. per M . . . . .	400.00

**SHEET METAL—**

Windows—Metal, \$2.50 a sq. ft.	
Fire doors (average), including hardware \$2.80 per sq. ft., size 12'x12', \$3.75 per sq. ft., size 3'x6'.	

**SKYLIGHTS—**(not glazed)

Galvanized iron, per sq. ft. . . . .	\$1.25
Vented hip skylights, per sq. ft. . . . .	2.25
Aluminum, puttless, (unglazed), per sq. ft. . . . .	1.25
(installed and glazed), per sq. ft. . . . .	1.85

**STEEL—STRUCTURAL—**

\$290 per ton erected, when out of mill. \$350 per ton erected, when out of stock.

**STEEL REINFORCING—**

\$200.00 per ton, in place.	
1/4-in. Rd. (Less than 1 ton) per 100 lbs. . . . .	\$8.90
3/8-in. Rd. (Less than 1 ton) per 100 lbs. . . . .	7.80
1/2-in. Rd. (Less than 1 ton) per 100 lbs. . . . .	7.50
5/8-in. Rd. (Less than 1 ton) per 100 lbs. . . . .	7.25
3/4-in. & 7/8-in. Rd. (Less than 1 ton) . . . . .	7.15
1 in. & up (Less than 1 ton) . . . . .	7.10
1 ton to 5 tons, deduct 25¢.	

**STORE FRONTS—**

Individual estimates recommended. See ESTIMATORS DIRECTORY for Architectural Veneer (3), and Mosaic Tile (35).

**TILE—**

Ceramic Tile Floors—Commercial \$1.20 to \$1.60 per sq. ft.	
Cove tile—\$1.40 per lin. ft.	
Quarry Tile Floors, 6x6" with 6 base @ \$1.35 per sq. ft.	
Tile Wainscots & Floors Resawed 4 1/4x4 1/4, @ \$1.65 to \$2.00 per sq. ft.	
Tile Wainscots, Commercial Jobs 4 1/4x4 1/4 Tile, @ \$1.50 to \$1.65 per sq. ft.	
Asphalt Tile Floor 18" x 18" . . . . . \$ 8 - 5 - 35 sq. yd.	
Light shades slightly higher.	
Cork Tile, \$ .70 per sq. ft.	
Mosaic Floors—See dealers.	
Linoleum tile, per sq. ft. . . . .	\$ .65
Rubber tile, per sq. ft. . . . .	\$ .55 to \$ .75

**Furring Tile**

Scored . . . . .	F.O.B. S. F.	\$ 12
2 x 12, each . . . . .		17
<b>Kraftite:</b> Per square foot	Small Lots	Large Lots
Patco Tile—Niles Red		
12 x 12 x 3/8 inch plain		40
6 x 12 x 3/8 inch plain		44
6 x 6 x 3/8 inch plain		46

**Building Tile—**

8 1/2 x 12 inches, per M . . . . .	\$ 39.50
6 1/2 x 12 inches, per M . . . . .	105.00
4 1/2 x 12 inches, per M . . . . .	84.00
<b>Hollow Tile—</b>	
12 x 2 1/2 inches, per M . . . . .	\$146.75
2 x 2 1/2 inches, per M . . . . .	156.85
2 x 2 1/4 inches, per M . . . . .	177.10
12 1/2 x 2 1/2 inches, per M . . . . .	235.30

F. O. B. Plant

**VENETIAN BLINDS—**

75 per square foot and up. Installation extra.

**WINDOWS—STEEL—INDUSTRIAL—**

Cost depends on design and materials required.

# ARCHITECT AND ENGINEER ESTIMATOR'S DIRECTORY

## Building and Construction Materials

**EXPLANATION**—Building and construction materials are shown in major classified groups for general identification purposes with names and addresses of suppliers of materials listed in detail under group classification where name first appears—main offices are shown first with branch or district offices following. The numeral appearing in listings \*(3) refers to the major group classification where complete data on the dealer, or representative, may be found.

### ADHESIVES (1)

Wall and Floor Tile Adhesives  
THE CAMBRIDGE TILE MFG. CO. \*(35)

### AIR CONDITIONING (2)

Air Conditioning & Cooling  
UTILITY APPLIANCE CORP.  
Los Angeles 58: 4851 S. Alameda St.  
San Francisco: 1355 Market St., UN 1-4908

### ARCHITECTURAL VENEER (3)

Ceramic Veneer  
GLADDING, McBEAM & CO.  
San Francisco: Harrison at 9th St., UN 1-7400  
Los Angeles: 2901 Los Feliz Blvd., OL 2121  
Portland: 110 S.E. Main St., EA 6179  
Seattle: 1500 First Ave. S., EL 4711  
Spokane: 1102 N. Monroe St., BR 3259  
THE CAMBRIDGE TILE MFG. CO. \*(35)

Porcelain Veneer  
PORCELAIN ENAMEL PUBLICITY BUREAU  
Oakland 12: Room 601 Franklin Building  
Pasadena 8: P. O. Box 186, East Pasadena Station

Granite Veneer  
VERMONT MARBLE COMPANY  
San Francisco 5: 525 Market St., SU 1-6747  
Los Angeles: 3522 Council St., DU 2-7834

Marble Veneer  
VERMONT MARBLE COMPANY  
San Francisco 5: 525 Market St., SU 1-6747  
Los Angeles: 3522 Council St., DU 2-7834

### BANKS - FINANCING (4)

CROCKER FIRST NATIONAL BANK OF S. F.  
San Francisco, Post & Montgomery Sts., EX 2-7700

### BATHROOM FIXTURES (5)

Metal  
THE CAMBRIDGE TILE MFG. CO. \*(35)

Ceramic  
THE CAMBRIDGE TILE MFG. CO. \*(35)

### BRASS PRODUCTS (6)

GREENBERG'S, M. & SONS  
San Francisco 7: 765 Folsom, EX 2-3143  
Los Angeles 23: 125B S. Boyle, AN 3-7109  
Seattle 4: 1016 First Ave. So., MA 5140  
Phoenix: 3009 N. 19th Ave., Apt. 92, PH 2-7663  
Portland 4: 510 Builders Exch. Bldg., AT 6443

### BRICKWORK (7)

Face Brick  
GLADDING, McBEAM & CO. \*(43)  
KRAFTILE \*(35)  
REMILLARD-DANDINI CO.  
San Francisco 4: 400 Montgomery St., EX 2-4988

### BRONZE PRODUCTS (8)

GREENBERG'S, M. & SONS \*(16)

### BUILDING PAPERS & FELTS (9)

ANGIER PACIFIC CORP.  
San Francisco 5: 55 New Montgomery St., DO 2-4416  
Los Angeles: 7424 Sunset Blvd.  
PACIFIC COAST AGGREGATES, INC. \*(11)  
SISALKRAFT COMPANY  
San Francisco 5: 55 New Montgomery St., EX 2-3066  
Chicago, Ill.: 205 West Wacker Drive

### BUILDING HARDWARE (9a)

THE STANLEY WORKS  
San Francisco: Monadnock Bldg., YU 6-5914  
New Britain, Conn.

### CEMENT (10)

IDEAL CEMENT COMPANY (Pacific Division)  
San Francisco 4: 310 Sansome St., GA 1-4100  
PACIFIC COAST AGGREGATES, INC. \*(11)

### CONCRETE AGGREGATES (11)

Ready Mixed Concrete  
PACIFIC COAST AGGREGATES, INC.  
San Francisco: 400 Alabama St., KL 2-1616  
Sacramento: 16th and A Sts., GI 3-6886  
San Jose: 790 Stockton Ave., CY 2-5620  
Oakland: 2400 Peralta St., GL 1-0177  
Stockton: 820 So. California St., ST B-8643

Lightweight Aggregates  
AMERICAN PERLITE CORP.  
Richmond: 26th & B. St. - Yd. 2, RI 4307

### DOORS (12)

Hollywood Doors  
WEST COAST SCREEN CO.  
Los Angeles: 1127 E. 63rd St., AD 1-1108  
W. P. FULLER CO.  
Seattle, Tacoma, Portland  
NICOLAI DOOR SALES CO.  
San Francisco: 3045 19th St.  
F. M. COBB CO.  
Los Angeles & San Diego  
SOUTHWESTERN SASH & DOOR  
Phoenix, Tucson, Arizona  
El Paso, Texas  
HOUSTON SASH & DOOR  
Houston, Texas

Screen Doors  
WEST COAST SCREEN DOOR CO.  
(See above)

### FIRE ESCAPES (13)

MICHEL & PFEFFER IRON WORKS, INC.  
South Linden & Tanforan Ave.,  
South San Francisco: JU 4-8362

### FIREPLACES (14)

Heat Circulating  
SUPERIOR FIREPLACE CO.  
Los Angeles: 1708 E. 15th St., PR 8393  
Baltimore, Md.: 601 No. Point Rd.

### FLOORS (15)

Hardwood Flooring  
HOGAN LUMBER COMPANY  
Oakland: Second and Alice Sts., GL 1-6861

Floor Tile  
GLADDING, McBEAM & CO. \*(43)  
KRAFTILE \*(35)

Floor Tile (Ceramic Mosaic)  
THE CAMBRIDGE TILE MFG. CO. \*(35)

Floor Treatment & Maintenance  
HILLIARD SALES CO. (Western)  
San Francisco: 470 Alabama St., MA 1-7766  
Los Angeles: 923 E. 3rd, TR 8282  
Seattle: 3440 E. Marginal Way  
Diversified (Magnesite, Asphalt Tile, Composition, Etc.)  
LE ROY OLSON CO.  
San Francisco 10: 3070 - 17th St., HE 1-0188  
Sleepers (Composition)  
LE ROY OLSON CO.

### GLASS (16)

W. P. FULLER COMPANY  
San Francisco: 301 Mission St., EX 2-7151  
Los Angeles, Calif.  
Portland, Ore.

### HEATING (17)

S. T. JOHNSON CO.  
Oakland 8: 940 Arlington Ave., OL 2-6000  
San Francisco: 585 Potrero Ave., MA 1-2757  
Philadelphia 8, Pa.: 401 N. Broad St.

SCOTT COMPANY  
San Francisco: 243 Minna St., YU 2-0400  
Oakland: 113 - 10th St., GL 1-1937  
San Jose, Calif.  
Los Angeles, Calif.

UTILITY APPLIANCE CORP. \*(2)

Electric Heaters

WEST COAST ELECTRIC HEATER CO.  
San Francisco 5: 350 First St., GA 1-2211  
Los Angeles: 520 W. 7th St., MI 8096  
Portland: Terminal Sales Bldg., BE 2050  
Seattle: Securities Bldg., SE 5028

Designer of Heating  
THOMAS B. HUNTER  
San Francisco 4: 41 Sutter St., GA 1-1164

### INSULATION AND WALL BOARD (18)

LUMBER MANUFACTURING CO.  
San Francisco: 225 Industrial Ave., JU 7-1760  
PACIFIC COAST AGGREGATES, INC. \*(11)  
SISALKRAFT COMPANY \*(9)

WESTERN ASBESTOS COMPANY  
San Francisco: 675 Townsend St., KL 2-3868  
Oakland: 251 Fifth Avenue, GL 1-2345  
Stockton: 733 S. Van Buren, ST 4-9421  
Sacramento 1331 - F St., HU 1-0125  
Fresno: 434 - P St., TR 2-1600

### IRON—Ornamental (10)

MICHEL & PFEFFER IRON WORKS, INC. \*(13)

### LANDSCAPING (20)

Landscape Contractors  
HENRY C. SOTO CORP.  
Los Angeles: 13,000 S. Avalon Blvd., ME 4-6617

### LIGHTING FIXTURES (21)

SHOOT-HOLMAN COMPANY  
Inglewood, Calif., OR 8-1217  
San Francisco: 55 Mississippi St., MA 1-8474

### LUMBER (22)

Shingles  
LUMBER MANUFACTURING CO. \*(18)

### MARBLE (23)

VERMONT MARBLE COMPANY  
San Francisco 5: 525 Market St., SU 1-6747  
Los Angeles 4: 3522 Council St., DU 2-7834

### METAL LATH EXPANDED (24)

PACIFIC COAST AGGREGATES, INC. \*(11)

### MILLWORK (25)

LUMBER MANUFACTURING COMPANY \*(18)  
MULLEN MANUFACTURING COMPANY  
San Francisco: 60-80 Rausch St., UN 1-5815  
PACIFIC MANUFACTURING COMPANY  
San Francisco: 16 Beale St., GA 1-7755  
Santa Clara: 2610 The Alameda, SC 607  
Los Angeles: 6820 McKinley Ave., TH 4196



**PAINTING (26)**

Paint  
W. P. FULLER COMPANY \* (116)

**PLASTER (27)**

Interiors - Metal Lath & Trim  
PACIFIC COAST AGGREGATES, INC. \* (111)  
Exteriors  
PACIFIC PORTLAND CEMENT COMPANY \* (28)

**PLASTIC CEMENT (28)**

IDEAL CEMENT COMPANY  
San Francisco: 310 Sansome St., GA 1-4100

**PLUMBING (29)**

THE HALSEY TAYLOR COMPANY  
Redlands, Calif.  
Warren, Ohio  
THE SCOTT COMPANY \* (17)  
HAWKS DRINKING FAUCET COMPANY  
Berkeley 10: 1435 Fourth St., LA 5-3341  
CONTINENTAL WATER HEATER COMPANY  
Los Angeles 31: 1801 Pasadena Ave., CA 6178  
SIMONDS MACHINERY COMPANY  
San Francisco: 816 Folsom St., DO 2-6794  
Los Angeles: 455 East 4th St., MU 8322  
SECURITY VALVE COMPANY  
Los Angeles 31: 410 San Fernando Rd., CA 6191

**RESILIENT TILE (30)**

LE ROY OLSON CO. \* (115)

**SEWER PIPE (32)**

GLADDING, McBEAN & CO. \* (13)

**SHEET METAL (32)**

Windows

DETROIT STEEL PRODUCTS COMPANY  
Oakland 8: 1310 - 63rd St., OL 2-8826  
San Francisco: Russ Bldg., DO 2-0890  
MICHEL & PFEFFER IRON WORKS, INC. \* (113)  
PACIFIC COAST AGGREGATES, INC. \* (111)

Fire Doors

DETROIT STEEL PRODUCTS COMPANY

Skylights

DETROIT STEEL PRODUCTS COMPANY

**STEEL—STRUCTURAL (33)**

COLUMBIA STEEL CO.  
San Francisco: Russ Bldg., SU 1-2500  
Los Angeles: 2087 E. Slauson, LA 1171  
Portland: 2345 N. W. Nicolai, BE 7261  
Seattle 1331 3rd Ave. Bldg., MA 1972  
Salt Lake City: Walker Bank Bldg., SL 3-6733  
HERRICK IRON WORKS  
Oakland: 18th & Campbell Sts., GL 1-1767  
JUDSON PACIFIC-MURPHY CORP.  
Emeryville: 4300 Eastshore Highway, OL 3-1717  
REPUBLIC STEEL CORP.  
San Francisco: 116 N. Montgomery St., GA 1-0977  
Los Angeles: Edison Building  
Seattle: White-Henry-Stuart Building  
Salt Lake City: Walker Bank Building  
Denver: Continental Oil Building  
SAN JOSE STEEL COMPANY  
San Jose 195 North Thirtieth St., CC 4184

**STEEL—REINFORCING (34)**

REPUBLIC STEEL CORP. \* (33)  
HERRICK IRON WORKS \* (33)  
SAN JOSE STEEL CO. \* (33)  
COLUMBIA STEEL CO. \* (33)

**CLAY TILE (35)**

THE CAMBRIDGE TILE MFG. CO.  
San Francisco 10: 470 Alabama St., UN 3-1666  
Los Angeles 19: 1335 S. La Brea, WE 3-7800  
GLADDING, McMEAN & CO. \* (13)  
KRAFTILE  
Niles, Calif.: Niles 3611  
San Francisco 5: 50 Hawthorne St., DO 2-3780  
Los Angeles 13: 406 South Main St., MU 7241

**TIMBER—REINFORCING (36)**

Trusses

MYERHAEUSER SALES CO.  
Tacoma, Wash.  
St. Paul, Minn.  
Newark, N. J.

Treated Timber

J. H. BAXTER CO.  
San Francisco 4: 333 Montgomery St., DO 2-3883  
Los Angeles 13: 601 West Fifth St., MI 6294

**WALL TILE (37)**

THE CAMBRIDGE TILE MFG. CO. \* (135)  
GLADDING, McBEAN & CO. \* (3)  
KRAFTILE COMPANY \* (35)

**WINDOWS STEEL (38)**

DETROIT STEEL PRODUCTS CO. \* (32)  
MICHEL & PFEFFER IRON WORKS, INC. \* (113)  
PACIFIC COAST AGGREGATES, INC. \* (111)

**GENERAL CONTRACTORS (39)**

BARRETT & HILP  
San Francisco: 918 Harrison St., DO 2-0700  
Los Angeles: 234 W. 37th Place, AD 3-8161  
DINWIDDIE CONSTRUCTION COMPANY  
San Francisco: Crocker Building, YU 6-2718  
CLINTON CONSTRUCTION COMPANY  
San Francisco: 923 Folsom St., SU 1-3440  
MATCOCK CONSTRUCTION COMPANY  
San Francisco: 604 Mission St., GA 1-5516  
PARKER, STEFFENS & PEARCE  
San Francisco: 135 So. Park, EX 2-6639  
STOLTE, INC.  
Oakland: 8451 San Leandro Blvd., TR 2-1064  
SWINERTON & WALBERG COMPANY  
San Francisco: 225 Bush St., GA 1-2980  
Oakland: 1723 Webster St., HI 4-4322  
Los Angeles, Sacramento, Denver  
P. J. WALKER COMPANY  
San Francisco: 391 Sutter St., YU 6-5916  
Los Angeles: 714 W. Olympic Blvd., RI 7-5521

**TESTING LABORATORIES**

**(ENGINEERS & CHEMISTS (40))**

ABBOT A. HANKS, INC.  
San Francisco: 624 Sacramento St., GA 1-1697  
ROBERT W. HUNT COMPANY  
San Francisco: 251 Kearny St., EX 2-4634  
Los Angeles: 3050 E. Slauson, JE 9131  
Chicago, New York, Pittsburgh  
PITTSBURGH TESTING LABORATORY  
San Francisco: 651 Howard St., EX 2-1747

**BUILDING TRADES WAGE (JOB SITES) NORTHERN, CENTRAL AND SOUTHERN CALIFORNIA**

ATTENTION: The following are the PREVAILING hourly rates of compensation being paid and in effect by employers by agreement between employees and their union; or as recognized and determined by the U. S. Department of Labor. (September 1, 1952.)

CRAFT	San Francisco	Alameda	Contra Costa	Fresno	Sacramento	San Joaquin	Sanja Clara	Solano	Los Angeles	San Bernardino	San Diego	Santa Barbara	Kern
ASBESTOS WORKERS	\$2.585	\$2.585	\$2.585	\$2.585	\$2.585	\$2.585	\$2.585	\$2.585	\$2.25	\$2.25	\$2.25	\$2.25	\$2.25
BOILERMAKERS	2.68	2.68	2.68	2.68	2.68	2.68	2.68	2.68	2.57	2.57	2.57	2.57	2.57
BRICKLAYERS	3.25	3.25	3.25	3.00	3.25	3.00	3.45	3.25	3.00	3.00	2.75	3.00	3.00
BRICKLAYERS, HOCCARRIERS	2.45	2.45	2.45	2.00	2.40	2.25	2.45	2.45	1.94	1.94	1.94	1.94	1.94
CARPENTERS	2.60	2.60	*2.39	*2.39	*2.39	*2.39	*2.39	*2.39	2.75	2.75	2.75	2.75	2.75
CEMENT FINISHERS	2.57	2.57	2.57	2.57	2.57	2.57	2.57	2.57	2.57	2.57	2.57	2.57	2.57
ELECTRICIANS	3.00	3.00	3.00	3.00	3.00	2.75	3.00	2.75	2.75	2.75	2.75	2.75	2.75
ELEVATOR CONSTRUCTORS	2.75	2.75	2.45	2.75	2.915	2.915	2.915	2.915	2.56	1.9875	1.9875	1.9875	1.9875
ENGINEERS: MATERIAL HOIST	2.56	2.56	2.56	2.56	2.56	2.56	2.56	2.56	2.25	2.25	2.25	2.25	2.25
GLAZIERS	2.30	2.30	2.30	2.30	2.25	2.30	2.30	2.30	2.16	2.16	2.16	2.16	2.16
IRONWORKERS: ORNAMENTAL	2.55	2.55	2.55	2.55	2.55	2.55	2.55	2.55	2.45	2.45	2.45	2.45	2.45
REINF. RODMEN	*2.45	2.45	2.45	2.45	2.45	2.45	2.45	2.45	2.38	2.38	2.38	2.38	2.38
STRUCTURAL	*2.70	2.70	2.70	2.70	2.70	2.70	2.70	2.70	2.70	2.70	2.70	2.70	2.70
LABORERS: BUILDING	1.85	1.85	1.85	1.85	1.85	1.85	1.85	1.85	1.85	1.84	1.84	1.84	1.84
CONCRETE	1.85	1.85	1.85	1.85	1.85	1.85	1.85	1.85	1.94	1.94	1.94	1.94	1.94
LATHERS	3.00	3.00	3.00	3.00	3.00	2.75	3.00	2.8125	3.125	3.125	3.125	3.125	3.125
MARBLE SETTERS	2.70	2.70	2.70	2.70	2.70	2.70	2.70	2.70	2.70	2.25	2.25	2.25	2.25
MOSAIC & TERRAZZO	2.6125	2.6125	2.6125	2.6125	2.6125	2.6125	2.6125	2.6125	2.4125	2.40	2.40	2.40	2.40
PAINTERS	**2.60	2.60	2.60	2.60	2.60	2.60	2.60	2.60	2.38	2.56	2.475	2.475	2.22
PILEDRIVERS	*2.5575	*2.5575	*2.5575	*2.5575	*2.5575	*2.5575	*2.5575	*2.5575	2.54	2.38	2.38	2.38	2.38
PLASTERERS	3.125	3.165	3.125	3.125	3.00	3.00	3.125	3.00	3.125	3.125	3.125	3.125	3.125
PLASTERERS, HOCCARRIERS	2.60	2.60	2.60	2.60	2.60	2.60	2.60	2.60	2.50	2.875	2.25	2.30	2.00
PLUMBERS	2.90	2.90	2.875	2.75	2.75	2.75	2.75	2.75	2.90	2.90	2.90	2.90	2.90
ROOFERS	3.50	2.50	2.50	2.25	2.50	2.50	2.50	2.50	2.65	2.00	1.90	2.00	2.00
SHEET METAL WORKERS	2.475	2.475	2.3125	2.43	2.43	2.43	2.43	2.43	2.415	2.475	2.475	2.175	2.00
SPRINKLER FITTERS	2.75	2.70	2.70	2.425	2.675	2.50	2.625	2.50	2.75	2.25	2.25	2.25	2.25
STEAMFITTERS	2.75	2.70	2.70	2.75	2.675	2.675	2.675	2.675	2.75	2.75	2.75	2.75	2.75
TRUCK DRIVERS—/; Ton or less	1.89	1.89	1.89	1.89	1.89	1.74	1.89	1.89	1.89	1.89	1.89	1.89	1.89
TILESETTERS	2.955	2.955	2.955	2.955	2.955	2.955	2.955	2.955	2.955	2.65	2.65	2.65	2.65

\* 6 Hour Day. \*\* 7 Hour Day. \*\*\* Before C.I.S.C. for 15c increase.

Prepared and compiled by:

CENTRAL CALIFORNIA CHAPTER, ASSOCIATED GENERAL CONTRACTORS OF AMERICA, with the assistance and cooperation of secretaries of General Contractors Associations and Builders Exchanges of Northern California; and the above information for Southern California is furnished by the Labor Relations Department of the Southern California Chapter, ASSOCIATED GENERAL CONTRACTORS OF AMERICA

## WELDED STRUCTURES

(From Page 5)

tures is becoming a relatively simple matter these days. Not only are such aids as tables of Standard Connections equivalent to Series "A" and "B" riveted connections becoming available, but the A. W. S. Code for Arc Welding in Building Construction now recommends that the allowable tension on V Butt Welds be taken as equivalent to that allowed for the base metal. The method of balancing Moduli further simplifies the design of continuous beams.

Except for locations in an explosive atmosphere, welding is universally applicable. The method finds favor not only in work on existing buildings where beams may be conveniently strengthened by the addition of welded cover plates, but particularly in hospitals or apartment house areas where noise of construction is a factor. Inspection laboratories may now give equal assurance as to the quality of either welded or riveted work, and an adequate criteria for welding is conveniently provided by reference to the A. W. S. Code in job specifications. Saxe has encountered little difficulty in keeping welded structures plumb, though he does recommend a positive steel-to-steel connection rather than field bolts to resist the inherent tendency of shrinkage. Many other tips on the design, detailing and erection of welded structures were brought out in connection with the numerous slides.

During the course of his present series of talks throughout the Western United States, Saxe is undoubtedly stimulating a good deal of thought and discussion on the merits of welding in structural steel design.

### PASADENA ARCHITECT APPOINTED TO RESEARCH COUNCIL BOARD

Whitney R. Smith of the Pasadena Chapter AIA, has been named chairman of the Housing Research Council of Southern California, Inc. He is a past president of the Pasadena Citizens Council

for Planning and a present member of the Planning Commission of the City of South Pasadena.

Other new officers include: Henry C. Burge, vice chairman; John J. Kewell, secretary; Clinton C. Ternstrom treasurer and Paul R. Hunter corresponding secretary.

The Housing Research Council will study housing in general under the Urban Redevelopment Act, and will analyze Southern California's tract housing.



**HOLLYWOOD JUNIOR**  
**COMBINATION**  
**SCREEN and METAL SASH DOOR**  
 ★  
**The "WEATHER-WISE"**  
**DOOR!!**

**A VENTILATING SCREEN DOOR**  
**A SASH DOOR**  
**A PERMANENT OUTSIDE DOOR**  
**ALL 3 IN 1!**

Discriminating home owners and architects have chosen Hollywood Junior as the TRIPLE DOOR VALUE in the COMBINATION SCREEN and METAL SASH DOOR field! A sturdy dependable door, constructed of quality materials, HOLLYWOOD JUNIOR'S EXCLUSIVE PATENTED FEATURES have outmoded old-fashioned screen doors and other doors of its type entirely! . . . . .

**IT GUARANTEES YOU YEAR 'ROUND**  
**COMFORT, CONVENIENCE and ECONOMY**

WE ALSO MANUFACTURE A COMPLETE LINE OF  
**SHUTTERS, C. C. DOORS, SCREENS, SCREEN DOORS, LOUVRE DOORS**

**WEST COAST SCREEN CO.**  
 1145 EAST 63rd STREET      ★      LOS ANGELES, CALIFORNIA  
 ADAMS BLDG.

★   ★   ★ **WRITE FOR FREE ILLUSTRATED LITERATURE** ★   ★   ★

# CLASSIFIED ADVERTISING

RATE: 20c PER WORD . . . CASH WITH ORDER

MINIMUM \$5.00

**BUILDERS!** You can make more money; get information you need before it is published elsewhere; Subscribe to the daily ARCHITECTS REPORTS, only \$10.00 per month. Complete information from ARCHITECTS REPORTS, 68 Post Street, San Francisco. Phone DOuglas 2-8311.

**PHOTOGRAPHY.** For the best in construction photography, including exterior and interior, aerial, and progress views . . . you will find as many others have that it's the SKELTON STUDIOS, 875 O'Farrell St., San Francisco. Telephone PRospect 6-1841.

**ARCHITECTURAL DRAFTSMAN WANTED;** Experienced in working drawings and details

for hospitals, schools, and commercial work. Excellent working conditions. Permanent position. W. D. Holdredge, P. O. Box 412, San Luis Obispo, Calif.

**Registered ARCHITECT,** residential and commercial, 17 years experience, seeks association with medium sized firm. Independent work, design, specifications, supervision, client contact. BOX J-3, Architect & Engineer, 68 Post Street, San Francisco, Calif.

**ARCHITECTURAL SLIDING SLEEL SASH.** One lot only — new, half price. 13 units, assorted sizes. 353 square feet total. 3 at 7 ft. x 5 ft.; 4 at 7 ft. x 4½ ft.; 1 at 6 ft. x 4½ ft.; 2 at 6 ft. x 4 ft.; 1 at 7 ft. x 3½ ft.;

1 at 4½ ft. x 3 ft.; 1 at 3 ft. x 3 ft. Phone DElaware 3-7378, San Francisco.

**YOUNG ARCHITECT** — Wanted with some evenings and weekends free during April to assist business couple building S. F. view home. Ideas are formulated, but need professional services at reasonable rate. Address replies to Suite 485, 703 Market St., S. F.

**MODERN FRESCO PAINTINGS ON SLABS** by SIMEON PELENC—Received A.I.A. and Government awards. Approximate size 3 x 4 ft. Suitable for exterior or interior decoration. HELEN PELENC, 1101 Francisco St., San Francisco.

## CONSTRUCTION CONTRACTS AWARDED AND MISCELLANEOUS PERSONNEL DATA

**OFFICE BUILDING**, Beverly Hills, Los Angeles County. ARCHITECT: Douglas Honnold, Los Angeles. 4 story and basement, 49,700 sq. ft., reinforced brick construction, concrete roof slab, built-up composition roofing, structural steel, elevator, plaster partitions, toilets, \$600,000. GENERAL CONTRACTOR: George M. Holstein, Beverly Hills.

**HIGH SCHOOL BUILDING**, Herlong, Lassen County. Housing & Home Financing Agency, owner. \$284,900. ARCHITECT: Robt. C. Kaestner, Visalia. 1 story frame, some structural steel. GENERAL CONTRACTOR: O'Connor Bros., Red Bluff.

**OFFICE BUILDING**, Los Angeles, Los Angeles County. Insurance Company of North America, owner. 4 story, 100 x 100 ft., \$600,000. ARCHITECT: Robert Montgomery Brown, Philadelphia. STRUCTURAL ENGINEER: Paul Jelfers, Los Angeles. Reinforced concrete construction, concrete joist construction, asphalt tile floors, ceramic tile work, acoustical work, lath and plastering, architectural metal work, elevator, dumb waiter, brick masonry work, plumbing heating, hollow metal doors, steel sash, metal toilet partitions. GENERAL CONTRACTOR: McDonald, Young & Nelson, Inc., San Francisco.

**SYLVAN ELEMENTARY SCHOOL**, Modesto, Stanislaus County. Sylvan Union Elementary School District, owner. 3 classrooms,

multi-purpose, kitchen and toilet rooms, \$163,744. ARCHITECT: Swartz & Hyberg, Fresno. Frame and stucco construction. GENERAL CONTRACTOR: Floyd G. Borchardt, Stockton.

**INTERMEDIATE SCHOOL AND ADMINISTRATION BUILDING**, Colton, California. Colton School District, owner. 1 story, 9 classrooms, administration building, multi-purpose unit, kitchen, music room, shower and locker unit, shops, homemaking building, science building, library, arts and crafts unit, toilet facilities, and utility rooms, \$718,152. ARCHITECT: Kistner, Wright & Wright, Los Angeles. Frame and stucco construction. GENERAL CONTRACTOR: J. P. Henck, Skyforest.

**POTRERO TERRACE ANNEX LOW RENT HOUSING PROJECT**, San Francisco. Housing Authority of the City of S. F., owner. 172 units, \$1,577,777. ARCHITECT: Ward & Boles, San Francisco. Frame and stucco construction. GENERAL CONTRACTOR: Biltwell Construction Co., San Francisco.

**HIGH SCHOOL ADDITION**, Livermore, Alameda County. Livermore Joint Union High School District, owner. 8 classrooms, library and toilet rooms, \$174,997. ARCHITECT: John C. Warnecke, San Francisco. Reinforced concrete and frame construction, some structural steel. GENERAL CONTRACTOR: E. A. Hathaway & Co., San Jose.

**TELEPHONE BUILDING**, Canoga Park, Los Angeles County. Pacific Telephone & Telegraph Co., owner. 1 story, 128x192 ft., \$246,000. ARCHITECT: Allison & Ribble, Los Angeles. Reinforced concrete and masonry construction, composition roofing, cement slab floor, air conditioning, tile work, Terrazzo, electrical, plumbing, metal sash. GENERAL CONTRACTOR: Contracting Engineers Co., Los Angeles.

**AGRICULTURAL SHOP BUILDING**, Auberry, Fresno County. Sierra Joint Union High School District, owner. \$138,425. ARCHITECT: Franklin & Simpson, Fresno. GENERAL CONTRACTOR: Lewis C. Nelson & Son, Selma.

**FACTORY BUILDING**, Venice, Los Angeles County. Sam Avedon, owner. 1 story, 180x180 ft., \$125,000. STRUCTURAL ENGINEER: Earl M. Bennelsen, Alhambra. Reinforced, pre-cast concrete exterior wall, composition roofing, gutters, roman brick veneer, metal louvers over steel sash, bowstring trusses, rotary roof vents, metal canopy, concrete slab floor, wood columns, wood overhead doors, asphaltic concrete paving. GENERAL CONTRACTOR: William J. Moran Co., Alhambra.

**SEWAGE DISPOSAL PLANT AND SEWER SYSTEM**, Ivanhoe, Tulare County. Ivanhoe Pub. Utilities Dist., owner. \$163,418. ENGINEER: H. W. Jorgensen, Fresno. GENERAL CONTRACTOR: Schallock & Glanville, Bakerfield.

**WAREHOUSE & OFFICE BUILDING**, San Francisco. S. F. Warehouse, owner. 1 story, \$150,000. STRUCTURAL ENGINEER: Ellison & King, San Francisco. Reinforced concrete construction, wood roof. GENERAL CONTRACTOR: Bartel & Hill, San Francisco.

**FT. MILLER JUNIOR HIGH SCHOOL**, Fresno, Fresno County. Fresno Unified City School District, owner. 12 classrooms, administra-

tion, music, art, science units, wood and metal shops, gymnasium, library, and cafeteria, \$1,300,000. ARCHITECT: Franklin & Simpson, Fresno. Frame and stucco construction, slab floors, radiant heating. GENERAL CONTRACTOR: Clarence Ward Construction Co., Fresno.

**SHOPPING CENTER ADDITION**, West Pittsburg. Shore Acres Investment Co., owner. 16 stores, \$114,800. ARCHITECT: Young & Lloyd, Albany. 1 story, structural steel frame, frame and stucco and poured gypsum roof deck. OWNER BUILDS.

**REDWAY ELEMENTARY SCHOOL, SOUTH FORK HIGH SCHOOL, MIRANDA, SEWAGE DISPOSAL PLANT AT MIRANDA**, Miranda, Humboldt County. Southern Humboldt Unified School District, owner. 10 classrooms, administration, multi-purpose, kitchen and toilets, South Fork High School, \$466,262. ARCHITECT: Ernest F. Winkler, San Francisco. Frame construction. GENERAL CONTRACTOR: Walter L. Olsen, Santa Rosa.

**WAREHOUSE AND OFFICE**, Los Angeles, Los Angeles County. Harper & Reynolds Corp., owner. 122,000 sq. ft., 1 story \$563,130. ARCHITECT: Burke & Kober & Nicolais, Los Angeles. Reinforced concrete and connecting concrete tilt-up warehouse building, concrete brick pipe shed, composition roofing, wood trusses, concrete floor, metal sash, terrazzo, decorative tile entrance, asphalt tile floor, air-conditioning. GENERAL CONTRACTOR: Hardwick & Son, Hollywood.

**NEW WASHINGTON SCHOOL, ADD. TO JEFFERSON SCHOOL**, Lindsay, Tulare County. Lindsay Elementary School District, owner. 16 classrooms, administration, multi-purpose, kindergarten and toilet rooms, \$431,800. ARCHITECT: Robert C. Kaestner, Visalia. Frame and stucco construction. GENERAL CONTRACTOR: Trewhitt, Shields & Fisher, Fresno.

**MANUFACTURING CENTER**, Anaheim, Orange County. Anaheim Holding Company, owner. 10,000 sq. ft., men's and women's toilet facilities, \$180,000. CIVIL ENGINEER: E. Zepelin-Speinge, Newport Beach, reinforced masonry, bowstring trusses, built-up roofing, slab floor, metal sash, concrete work. GENERAL CONTRACTOR: B. L. Metcalf, Orange.

**INSURANCE OFFICE BUILDING**, San Bruno, San Mateo County. Providence Washington Insurance Co., owner. 1 story, \$300,000. ARCHITECT: Angus McSweeney, San Francisco; reinforced concrete construction. GENERAL CONTRACTOR: Williams & Burrows, South San Francisco.

**COURT HOUSE ADDITION**, Yreka, Siskiyou County. County of Siskiyou, owner. 2 story, basement, \$193,054. ARCHITECT: Robert Keeney, Medford, Ore. Reinforced concrete construction. GENERAL CONTRACTOR: Ausland & Dedson, Ashland, Ore.

**LOW RENT HOUSING PROJECT**, Benicia, Solano County. Housing Authority of the City of Benicia, owner. 75 units & management and maintenance bldg., \$66,794. ARCHITECT: Jos. P. Milano, Berkeley. Frame and stucco construction, asphalt shingle roof, asphalt tile floors, 37 duplexes, and 1/2 bedroom residences. GENERAL CONTRACTOR: William & Burrows Burlingame.

**MANZANITA ELEMENTARY SCHOOL**, Redding, Shasta County. Redding Elementary School District, owner. 9 classrooms, administration, kindergarten, and toilet rooms, \$210,000. ARCHITECT: Clarence Felciano, Santa Rosa. Frame and stucco construction. GENERAL CONTRACTOR: Hank Const. Co., Layayette.

**SUNDAY SCHOOL & FELLOWSHIP HALL**, Los Gatos, Santa Clara County. First Pres-

# FLOORS

**FOR EVERY PURSE  
OR PURPOSE**

HOSPITALS • COMMERCIAL BUILDINGS • WINERIES • CANNERIES • FOOD PROCESSING • INDUSTRIAL BUILDINGS • WAREHOUSES RESTAURANTS • SCHOOLS

Territories open for Qualified  
Representatives

*Specifications and information  
available on request*

*Free Consultation Service*

**LeROY OLSON  
COMPANY**

3070 Seventeenth Street,  
San Francisco, California



byterian Church, owner. 1 story, \$152,312. ARCHITECT, Ponsford & Price, Oakland. Frame and stucco construction. GENERAL CONTRACTOR: Pendergraft & Day, Cupertino.

**SEWAGE TREATMENT PLANT.** Fresno, Fresno County, City of Fresno, owner, \$163,996. ENGINEER, Homer W. Jorgensen, Fresno. Reinforced concrete construction. GENERAL CONTRACTOR: Midwest Construction Co., Sacramento.

**BRANCH BANK BUILDING.** San Carlos, San Mateo County. American Trust Co., owner. 1 story, 69 x 103, \$156,497. ARCHITECT, Leo J. Sharps & Irving F. Brown, San Mateo. Reinforced concrete and frame construction. GENERAL CONTRACTOR: Wells P. Goodenough, Palo Alto.

**NEW CORONADO ELEMENTARY SCHOOL.** Richmond, Contra Costa County. Richmond Board of Education, owner. 12 classrooms, administration, 2 kindergartens, kitchen, multi-purpose, toilet rooms, \$299,977. ARCHITECT, Charles F. Strothoff, San Francisco. Frame and stucco construction. GENERAL CONTRACTOR: Robert S. Miller, Richmond.

**SITE No. 3 ELEMENTARY SCHOOL.** Mt. View, Santa Clara County. Whisman Elementary School District, owner. 7 classrooms, administration, multi-purpose, toilet rooms, kitchen, \$263,333. ARCHITECT, John M. Evans, San Jose. Frame and stucco construction. GENERAL CONTRACTOR, Barnhart Construction Co., Santa Clara.

**300 CAR COLD STORAGE BUILDING.** Terra Bella, Tulare County. E. Merqotan, owner. 1 story, 135x300, \$239,000. ENGINEER, Thomas S. Kendall, San Gabriel. Wood frame and gunite construction, composition roofing, loose fill, insulation, cold storage doors, concrete slab floors. GENERAL CONTRACTOR, Lindquist & Lindquist, Visalia.

**MANZANITA ELEMENTARY SCHOOL.** Redding Shasta County. Redding Elementary School District, owner. 9 classrooms, administration, kindergarten, and toilet rooms, \$210,000. ARCHITECT, Clarence Felciano, Santa Rosa. Frame and stucco construction. GENERAL CONTRACTOR: Hancock Construction Co., Lafayette.

**CHURCH.** Santa Cruz, Santa Cruz County. Assembly of God Church, owner. \$85,000. ARCHITECT, Clarence C. Cuff, Sacramento. Frame and stucco construction. OWNER BUILDS.

**EL PORTAL ELEMENTARY SCHOOL.** San Pablo, Contra Costa County. San Pablo Elementary School District, owner. 15 classrooms, administration, multi-purpose, 2 kindergartens, 2 playcourts and shelters, kitchen, lunch room, library and toilet rooms, \$473,474. ARCHITECT, Schmidts & Hardman, Berkeley. Frame and stucco construction. GENERAL CONTRACTOR: Zuckerman Construction Co., Walnut Creek.

**TWO ELEMENTARY SCHOOLS.** Sunnyvale, Santa Clara County. Sunnyvale Elementary School District, owner. A—8 classrooms, administration, 2 kindergartens, multi-purpose, kitchen & toilet rooms, \$270,250; B-10 classrooms, administration, kitchen, 2 kindergartens & toilet rooms, \$298,000. ARCHITECT: Donald Powers Smith, San Francisco. Frame & stucco construction. GENERAL CONTRACTOR: A—Carl N. Swenson Co., San Jose; B—Achterman & Alesen, San Jose.

**PAPER BOX MANUFACTURING PLANT.** East Los Angeles, Los Angeles County. Container Division, International Paper Company, owner. Factory, office section lunch room, \$1,500,000. ENGINEER: D. R. Edwards, Maywood. Steel frame construction, pre-cast tilt-up wall construction, saw-

tooth roof, and steel decking, composition roofing, metal sash, slab floor, protected metal work, insulation, sliding and rolling doors, sprinkler system. GENERAL CONTRACTOR: George A. Fuller Co., Los Angeles.

**PIERRA LINDA ELEMENTARY SCHOOL ADDITION.** San Carlos, San Mateo County. San Carlos Elementary School District, owner. 8 classrooms, 2 shower & locker rooms, toilet rooms, \$163,750. ARCHITECT, John Lyon Reid, San Carlos. Frame and stucco construction. GENERAL CONTRACTOR, B & R Construction Co., San Francisco.

**CABRILLO JUNIOR HIGH SCHOOL GYMNASIUM.** Ventura, Ventura County. Ventura Union High School District, owner. \$403,535. ARCHITECT, Harold E. Burket, Ventura. 20,000 sq. ft., frame and stucco construction, wood trusses, asbestos composition roofing, maple floor in gymnasium, cement floor in shower, metal sash, acoustical work, folding partition, ceramic tile and glazed structural units, radiant heating in showers. GENERAL CONTRACTOR, George MacLeod, Ventura.

**EDUCATION & ACTIVITIES BUILDINGS.** Stockton, San Joaquin County. First Baptist Church, owner. 1 story, 12,000 sq. ft., \$231,776. ARCHITECT, Donald Powers Smith, San Francisco. Concrete block and frame construction. GENERAL CONTRACTOR, Craft Construction Co., Stockton.

**ELEMENTARY SCHOOL.** Santa Barbara, Santa Barbara County. Santa Barbara School District, owner. 8 classrooms, kindergarten, multi-purpose and administrative unit, \$314,490. ARCHITECT, Howell & Arendt, Santa Barbara; STRUCTURAL ENGINEER, Donald F. Shugart, Pasadena. Frame and stucco construction, tile concrete slab and asphalt tile floors, structural

steel, tile sheet metal, fixed and louvered glass. GENERAL CONTRACTOR, J. W. Bailey Construction Co., Santa Barbara. **CHURCH.** Concord, Contra Costa County. Roman Catholic Archbishop of S. F.—owner. 800 seating capacity. Queen of All Saints Parish, \$244,611. ARCHITECT: Vincent G. Raney, San Francisco. Reinforced Concrete and wood roof trusses. GENERAL CONTRACTOR: R. F. Johnson & Son, El Cerrito.

**ALTER OFFICE BUILDING.** Los Angeles, Los Angeles County. S. S. Slate, owner, \$225,000. ARCHITECT, Albert Criz and Associates, Los Angeles. Removal and construction of new partitions, stairways and elevators, concrete work, plastering, asphalt tile, heating and ventilating, plumbing. GENERAL CONTRACTOR, Contracting Engineers Co., Los Angeles.

## MINIATURE BUILDINGS

at Moderate Prices  
Custom Built to Scale

Homes, industrial plants, housing projects, and other architectural structures accurately reproduced. Effectively used for sales promotion, exhibits and engineering purposes.

Send us your plans for estimate, without obligation.

### ARCHITECTURAL MODEL MATERIALS, INC.

4208 West Armitage Ave.  
Chicago 39, Illinois

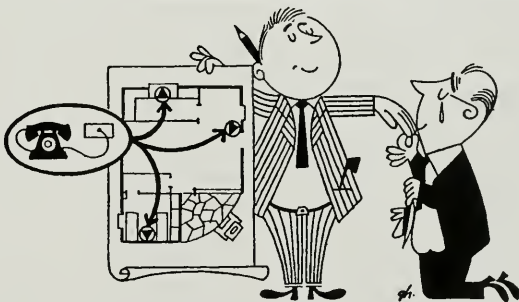

## Your clients will like the "extra" finish of built-in telephone facilities

You can make planned telephone facilities a part of your building plans so easily. And the popularity of conduit for concealed telephone wiring and conveniently located telephone outlets shows that clients like the extra finish they give to a new home. Appealing, too, is the fact that planned facilities allow them to change the position of their telephone, or add a new instrument later without marring the beauty of their home with exposed wiring.

Just call Pacific Telephone's free Architects and Builders service. They'll be glad to help you plan for better living tomorrow in the homes you are building today.

Put built-in telephone facilities in your plans



Pacific Telephone

# IN THE NEWS

## SCHOOL AUDITORIUM AND CAFETERIA

The Vallejo Unified School District is building a \$471,650 auditorium and cafeteria building to be used in conjunction with the Dr. James Hogan Junior High School in Vallejo.

Harry J. Devine of Sacramento is the architect.

## LOW RENT HOUSING PROJECT FOR S. F.

The Housing Authority of the City and County of San Francisco recently announced the construction soon of a 172 unit low rent housing project to be built in the Potrero Terrace Annex district of the city.

Twenty-three buildings are included in the project which will cost an estimated \$1,577,777.

Ward & Boles of San Francisco are the architects.

## ENGINE TESTING PLANT AT SACRAMENTO

The director of procurement of the Sacramento Air Material Area, recently announced the construction of high horsepower conventional reciprocating engine test facilities at the McClellan Air Force Base near Sacramento.

Cost of the project will approximate \$1,885,952, according to air force officials.

## REBUILD HIGH SCHOOL DESTROYED BY FIRE

Restoration of the Willits Union High School, which was considerably damaged by fire recently, has been started according to school district officials.

Among facilities to be rebuilt currently are classrooms, auditorium, shops and a bank room.

J. Clarence Feliciano, Santa Rosa, is the architect.

## NEW ARMORY FOR FRESNO

The Corps of Engineers, U. S. Army, San Francisco headquarters has announced the immediate construction of a 600-man Armory Building to be built in Fresno, at a cost of \$322,813.

Construction will include concrete ramp, vehicle storage shed, sanitary sewer system, drainage system, paving and sidewalks.

## COUNTY FAIR EXHIBIT BLDG.

The Santa Clara County Fair board has authorized the construction of three new exhibit buildings at the fair grounds in San Jose, at a cost of \$685,000. One of the buildings will be a general exhibit structure while the other two will be designed for use of livestock.

C. J. Ryland of Monterey is the architect.

## MARINE CORPS TRAINING CENTER

The new Marine Corps Artillery Training Center at Twentynine Palms, designed by Neptune & Gregory, Architects and Engineers, is one of the most notable construction projects in southern California representing an expenditure of \$1,161,200.

Planned to house 1000 men, the project includes 76-barracks, 1000 6-battalion administration buildings, 1000 mess halls, 6 construction buildings, 2 storehouses, 10 BOQ's, 10 mess halls, 10

regimental and camp command buildings, post exchange and various other service facilities.

It is one of the first complete military installations on the West Coast where pre-cast concrete has been used extensively.

## SANTA PAULA HAS NEW SCHOOL UNIT

The first new school to be built in Santa Paula during the past 26-years was dedicated recently when the new Glen City school plant was opened for grammar school use.

The new school consists of classrooms, and a combination cafeteria and auditorium.

Robert Raymond of Santa Paula is the architect.

## SCHOOL ADDITION AT ARCATA

The Arcata Elementary School District (Humboldt county) is constructing a \$243,675 addition to the Bloomfield Elementary School in Arcata, consisting of 6-classrooms, administration offices, kindergarten, multi-purpose facilities, and kitchen and toilets.

Frank T. Georgeson of Eureka is the architect.

## FAIR GROUNDS SITE FOR COURT BUILDING

The Board of Supervisors of Kern county has decided to utilize the County Fair Grounds as a site for construction of a new Courts Building.

The new building will be of 1-story, steel, steel roof and concrete floors and will contain 24,000 sq. ft. of floor area devoted to court rooms, court clerk office, offices of the district attorney and a law library. Cost is estimated at \$150,000.

Robert N. Eddy of Bakersfield is the architect.

## VICTORY GENERAL HOSPITAL FOR SAN FERNANDO VALLEY

Architects Reiner C. Nielsen and Gene E. Moffatt, Los Angeles, have designed the new Victory General Hospital which is to be built in North Hollywood in the immediate future for a group of San Fernando Valley doctors at an estimated cost of \$425,000.

The hospital will contain 25,000 sq. ft. of area and facilities for 50-beds and a clinic. Facilities will also be available for emergency cases.

## RANCH TYPE HOMES FOR LOS ANGELES

Construction of 51 homes in Rolling Meadows, Los Angeles county, will feature the "ranch type," plus a sprinkling of "Bermuda type," and will sell for \$18,500 to \$19,500. All homes will be 3-bedroom with double garage.

James R. Friend, Architect of San Pedro and Long Beach, is the architect for the project.

## NEW BUILDINGS FOR SAN FRANCISCO AIRPORT

Another important addition to San Francisco's Municipal Airport, near South San Francisco, will be the construction of a group of six warehouses and shop buildings for United Air Lines.

More than 214,000 sq. ft. of additional space will be added to present United Air facilities at the airport with completion of the new buildings.

## ELEMENTARY SCHOOL BONDS

Electors of the Franklin M. Kinley Elementary School District of Santa Clara

county, near San Jose, recently approved a special school bond in the amount of \$250,000 for the purpose of constructing a new Elementary School building.

The firm of Kress & Gibson, Architects of San Jose, have been commissioned to design the building.

## LOW RENT HOUSING PROJECT AT BENICIA

The Housing Authority of the City of Benicia, Solano county, are completing plans for the construction of a 75-unit Low Rent housing project to be built in Benicia. A housing and maintenance building will also be constructed as part of the program. Total cost is estimated at \$727,000.

Joseph P. Milano of Berkeley, is the architect.

## NEW FIRE STATION FOR EMERALD BAY

The Orange County Planning Commission has approved an application to build a new county fire station on Sunset Ridge Drive on the inland portion of Emerald Bay, just north of Laguna Beach.

Construction will start immediately.

## NEW FOUNDRY FOR OAKLAND

The General Metals Corp. of Oakland, has announced plans for the construction of a \$5,000,000 cast steel foundry to be built in Alameda county.

The new plant will contain 125,000 sq. ft. and will be of structural steel and reinforced concrete construction.

According to McClellan, MacDonald & Markwith, Los Angeles, architects, the plant will represent one of the most modern foundry and steel manufacturing operations on the West Coast when completed.

## RENO COUNTY HOSPITAL

The Washoe county board of supervisors recently authorized the architectural firm of Stone & Mulloy of San Francisco, to design a 2-story addition to the County Hospital in Reno, Nevada.

The new building will provide for 32 beds and will be of reinforced concrete construction with a brick veneer exterior.

## ELECTRONIC SHOP FOR VALLEJO

The U.S. Navy, Department of Public Works, has announced the construction of a new Electric-Electronics Shop building in Vallejo at the Mare Island Naval Shipyard.

The new building will comprise two to five story wings, with adjacent structures with a total floor space of 350,000 sq. ft. It will cost an estimated \$4,800,000.

W. D. Peugh, San Francisco, is the architect.

## ELEMENTARY SCHOOL FOR NEVADA CITY

Trustees of the Nevada City (Calif.) Elementary School District have authorized the architectural firm of Koblik & Fisher of Sacramento, to draft plans and specifications for the construction of an addition to the Elementary School in Nevada City.

## DEPARTMENT STORE FOR SAN MATEO

Mayor's Department Store, San Francisco, has announced plans to construct a new 2-story and basement department store building in the Hillside Shopping Center near San Mateo. The building will contain 200,000 sq. ft. of floor space and will represent a modern trend in architectural

# MULLEN MFG. COMPANY

BANK, STORE AND OFFICE  
FIXTURES—CABINET WORK  
OF GUARANTEED QUALITY  
CHURCH SEATING

Office and Factory

60-80 RAUSCH ST., Bet. 7th and 8th Sts.

San Francisco

Telephone UNDERhill 1-5815

## CLASSIFIED ADVERTISING

Will Bring Results

—USE—

## ARCHITECT and ENGINEER

68 Post St. San Francisco

STATIONERY  
SCHOOL & OFFICE  
SUPPLIES

•  
Printing Engraving  
Announcements

•  
CENTER STATIONERY

468 McAllister

San Francisco UN 1-3703

*Fine*  
**ENGRAVINGS**



**POOR  
RICHARD**

**PHOTO ENGRAVING CO.**  
320-324 COMMERCIAL STREET  
SAN FRANCISCO, 11

design, according to architects Welton Becket & Associates of Los Angeles.

Cost of the construction will approximate \$4,000,000.

### WALNUT CREEK GETS NEW STORE BUILDING

The Broadway Shopping Center, near Walnut Creek in Contra Costa County, will soon have the addition of a \$1,000,000 department store, according to an announcement by the MacDonald Products Company of San Francisco, who have stated the completed building would be occupied by Capwell's Department Store of Oakland.

The new building will be 2-story in height and will contain 100,000 sq. ft. of floor space; escalators, air conditioning, etc.

Welton Becket & Associates of Los Angeles are the Architects.

### NEW TEMPLE FOR SACRAMENTO

A new Temple for B'Nau Israel is being built in Sacramento, according to a recent announcement. Cost of the building is \$175,000.

The firm of Koblik & Fisher of Sacramento, are the architects.

### ADDITION TO COUNTY JAIL

A 2-story and basement addition is being built on the Madera County Court House which will serve as an addition to the county jail. It is of reinforced concrete construction and will contain 6,378 sq. ft.

Horn & Mortland of Fresno are the architects. Cost of the project will be about \$116,000.

### GOLF HOUSE PLANNED

The North Ridge Country Club of Carmichael, near Sacramento, has announced plans for the construction of a new Golf Club House in the immediate future.

Architects Franceschi & Mullen of Sacramento have been selected to design the building.

### RODEO GROUNDS FOR LOS BANOS

The Merced County Livestock Association of Los Banos, Merced county, has announced plans for the construction of a race track, grandstand, and Rodeo Grounds at the Fairgrounds in Los Banos.

C. J. Ryland of Monterey is the architect.

### NEW HIGH SCHOOL FOR WESTWOOD

The Westwood Unified School District recently announced plans for the construction of a new \$1,100,000 High School Building in Westwood, Lassen County, consisting of a 1-story reinforced concrete and structural steel structure containing 48,000 sq. ft.

Architect Clayton Kantz of Redding is designing the new building.

### CHARLES L. WOOD NAMED DIRECTOR ALLIANCE ENGINEERS

Charles L. Wood, formerly with the Federal Civil Defense Administration in Washington, D. C., has been named Director of the Technical Staff for the Alliance Engineers of Los Angeles, according to an announcement by Charles L. Weeks, President.

Wood has been associated with the construction and engineering industry in Washington, D. C., Florida and Central America in administrative and technical advisory capacities since 1939.

Phone GARfield 1-1164

## Thomas B. Hunter

DESIGNER OF HEATING

AIR CONDITIONING  
VENTILATING AND WIRING  
SYSTEMS, MECHANICAL  
AND ELECTRICAL EQUIP-  
MENT OF BUILDINGS



41 SUTTER STREET  
ROOM 710

San Francisco

California

Subscribe  
Now —

**ARCHITECT  
and  
ENGINEER**

\$3.00  
Per Year

**DINWIDDIE  
CONSTRUCTION  
COMPANY**

•  
**BUILDERS**

•  
CROCKER BUILDING  
SAN FRANCISCO



**HERRICK  
IRON WORKS**  
STRUCTURAL STEEL  
REINFORCING STEEL

18TH AND CAMPBELL STS.  
OAKLAND, CALIF.

Phone GLencourt 1-1767



**MATTOCK  
CONSTRUCTION  
COMPANY**



**BUILDERS**



604 MISSION STREET  
SAN FRANCISCO

**ARCHITECT  
and  
ENGINEER**

Please enter my subscription for  
..... year.... My check in the  
amount of \$..... is attached.  
1 year . . . . \$3.00  
2 years . . . . 5.00

Name.....

City.....

State.....

**ABBOT A. HANKS, INC.  
Engineers & Chemists**

INSPECTING — TESTING — CONSULTING  
CONCRETE • STEEL • MATERIALS  
CHEMICAL AND TESTING  
LABORATORIES  
• RESEARCH AND INVESTIGATION •  
TESTS OF STRUCTURAL MATERIALS  
DESIGN OF CONCRETE MIXES  
SHOP AND ERECTION INSPECTION OF  
STRUCTURES AND EQUIPMENT  
INVESTIGATION OF STRUCTURES  
AND MATERIALS  
TESTS AND INVESTIGATION OF  
FOUNDATION SOILS  
FIRE RESISTANCE AND INSULATION  
TESTS

624 Sacramento Street, San Francisco

**PITTSBURGH  
TESTING LABORATORY**

**ENGINEERS AND CHEMISTS**

Testing and Inspection of Concrete,  
Steel and Other Structural Materials

Design of Concrete Mixes

Offices in all principal cities

651 Howard St., San Francisco 5  
EXbrook 2-1747

**Index to Advertisers**

ALLIANCE Engineer .....	36
ARCHITECTURAL Model Materials Inc. ....	45
ANDERSEN, N. E.....	24
ARCHITECTS Reports .....	38
BARRETT & HILP, Contractors.....	35
By-CHEMICAL Products Co.....	31
CAMBRIDGE Tile Mfg. Company .....	*
CASEY, H. E. Co.....	23
CENTER Stationery .....	47
CLAY Brick & Tile Association.....	*
CLASSIFIED Advertising .....	43
CLINTON Construction Company.....	36
CROCKER First National Bank.....	*
DINWIDDIE Construction Company....	47
FORDERER Cornice Works.....	35
GLADDING, McBean & Company.....	*
GREENSBURG'S, M. Sons.....	*
HANKS, Abbot A., Inc.....	48
HAWS Drinking Faucet Co.....	28 & 29
HERRICK Iron Works.....	47
HOGAN Lumber Co.....	36
HUNT, Robert W., Company.....	48
HUNTER, Thos. B.....	47
IDEAL Cement Co.....	Back Cover
IZMIRIAN Roofing & Sheet Metal Works.....	24
JOHNSON, S. T. Co.....	*
JUDSON, Pacific-Murphy Corp.....	36
KRAFTILE Company .....	26
MARBLE Institute of America.....	*
MATTOCK Construction Co.....	23 & 48
MICHEL & Pfeffer Iron Works, Inc. .....	Inside Front Cover
MULLEN Mfg. Co.....	47
OLSON, Leroy Co.....	44
PACIFIC Coast Aggregates.....	27
PACIFIC Manufacturing Co.....	37
PACIFIC Telephone & Telegraph Co.	45
PARKER, Steffens & Pearce.....	35
PITTSBURGH Testing Laboratory.....	48
POOR Richard Engraving Co.....	47
PORCELAIN Enamel Architectural Division) Publicity Bureau .....	34
REMILLARD-Dandini Co. ....	48
REPUBLIC Steel Corporation.....	37
SCOTT Company .....	48
SIMONDS Machinery Company.....	37
SMOOT-Holman Company .....	33
SUMMERBELL Roof Structures.....	32
U. S. Bonds.....	Inside Back Cover
UTILITY Appliance Corp'n. ....	*
VAN Poppel, A.....	23
VERMONT Marble Company .....	37
WEST Coast Screen Co.....	43

\*Indicates Alternate Months

**FOR ADVANCE  
INFORMATION**

**ON  
BUILDERS  
CONTRACTORS  
ENGINEERS**

Get

**ARCHITECTS  
REPORTS**

68 Post St. Phone  
San Francisco DO 2-8311

**ROBERT W. HUNT CO.**

**ENGINEERS  
INSPECTING TESTING**

**STRUCTURAL MATERIALS  
CONCRETE MIX DESIGN  
CHEMICAL ANALYSIS  
EQUIPMENT**

PRINCIPAL CITIES  
UNITED STATES • EUROPE  
SAN FRANCISCO LOS ANGELES  
PORTLAND SEATTLE

**REMILLARD-DANDINI Co.**

**Brick and  
Masonry Products**



400 MONTGOMERY STREET  
SAN FRANCISCO, CALIF.

**Scott Company**

**HEATING • PLUMBING  
REFRIGERATION**



San Francisco  
Oakland  
San Jose  
Los Angeles

# ARCHITECT AND ENGINEER

THE GREENBRAE ELEMENTARY SCHOOL . . . California



WILLIAM CORLETT, A.I.A., Architect

APRIL

1953

*“... helping to keep  
the business cycle  
on an even keel ...”*



**HARRY B. HIGGINS**  
President, Pittsburgh Plate Glass Company

*“The employees of Pittsburgh Plate Glass Company since 1946, have purchased \$9,488,510 in United States Savings Bonds through the Payroll Savings Plan. This accumulation of assets will be of inestimable value in helping to keep the business cycle on an even keel by maintaining purchasing power for the future.”*

Payroll Savings—the plan that protects—pays the employer triple benefits:

- it makes a good employee a better one—a serious saver with a definite plan for personal security.
- as enrollment on the plan goes to 60%, 70% employee participation, productivity increases, absenteeism decreases and accident records go down.
- and as Mr. Higgins points out, the systematic purchase of Defense Bonds through the Payroll Savings Plan is building a tremendous reserve of purchasing power.

Let's point up the third employer benefit with a few figures:

- On September 30, 1951, individuals held Series E Bonds totaling \$34.6 Billion—more than \$4.6 greater than on V-J Day.
- During the five calendar years (1946-1950) Defense Bonds sales provided:

—Cash to retire \$3 Billion A-D Savings Bonds (maturing Series).

—Cash to meet \$24 Billion redemptions of E, F and G Bonds.

—\$6 Billion (after providing cash for the payments enumerated above) that the U.S. Treasury could use to pay off bank-held debt.

And the figures are getting better every day—between January 1, 1951 and November 1, 1951, 1,200,000 employed men and women joined the Payroll Savings Plan.

If the employee participation on your Payroll Savings Plan is less than 60%, phone, wire or write to Savings Bond Division, U.S. Treasury Department, Suite 700, Washington Building, Washington, D.C. Your State Director will be glad to show you how you can participate in the triple benefits of the Payroll Savings Plan.

*The U.S. Government does not pay for this advertising. The Treasury Department, in thanks, for their patriotic donation, the Advertising Council and*





# ARCHITECT

Vol. 193

No. 1

# AND ENGINEER

ARCHITECTS' REPORTS—Published Daily

## Contents for

# APRIL

**EDWIN H. WILDER**  
Editor

**J. WELLS HASTINGS**  
Contributing Editor

**PROF. LELAND VAUGHAN**  
Landscape Architecture

**JOHN A. BLUME**  
Structural Engineering

**MICHAEL GOODMAN**  
Planning

**JOHN S. BOLLES, A.I.A.**  
Book Reviews



### COVER PICTURE

**GREENBRAE  
ELEMENTARY  
SCHOOL**

Marin County  
California

William Corlett, A.I.A.  
Architect

Walter Steilberg,  
Consulting Engineer

G. M. Simonson,  
Electrical and  
Mechanical Engineer

For complete details of this typical "western" style, modern school see additional pictures and story on Page 20.

*Photos by Ernest Braun*

**ERNEST McAVOY**  
Advertising Manager

ARCHITECT & ENGINEER

is indexed regularly by

ENGINEERING INDEX, INC.

EDITORIAL NOTES . . . . .	4
NEWS & COMMENT ON ART . . . . .	6
PUBLIC RELATIONS FOR ARCHITECTS—"Press Relations in Pasadena". . . . .	7
By Culver Heaton, A.I.A., Pasadena, California — Part II. Conclusion	
SHARP COMPETITION AHEAD FOR CONSTRUCTION INDUSTRY, According to A. G. C. Survey . . . . .	8
ENCINITA ELEMENTARY SCHOOL, Rosemead, California . . . . .	10
Marsh, Smith & Powell, Architects	
GROWTH SCHOOL—An Answer to Community Expansion. Eugene, Ore. . . . .	12
Clare K. Hamlin, Architect. By Arthur W. Prialux	
GREENBRAE ELEMENTARY SCHOOL, Marin County, California . . . . .	20
William Corlett, A.I.A., Architect; Walter Steilberg, Consulting Engineer; G. M. Simonson, Electrical-Mechanical Engineer	
CALIFORNIA CAPITOL—New East Wing, Sacramento, California . . . . .	25
By Anson Boyd, State Architect of California	
A. I. A. ACTIVITIES . . . . .	28
WITH THE ENGINEERS . . . . .	30
PRODUCERS COUNCIL PAGE . . . . .	32
Edited by Phil Brown, Otis Elevator Company	
BOOK REVIEWS, Pamphlets and Catalogues . . . . .	38
ESTIMATOR'S GUIDE, Building and Construction Materials . . . . .	41
ESTIMATOR'S DIRECTORY, Building and Construction Materials . . . . .	43
BUILDING TRADES WAGE SCALES, Northern, Central & Southern California . . . . .	44
CLASSIFIED ADVERTISING . . . . .	45
CONSTRUCTION CONTRACTS AWARDED and Miscellaneous Data . . . . .	46
IN THE NEWS . . . . .	48
INDEX TO ADVERTISERS . . . . .	50

ARCHITECT AND ENGINEER (Established 1905) is published on the 15th of the month by The Architect and Engineer, Inc., 68 Post St., San Francisco 4; Telephone EXbrook 2-7182. President, K. P. Kierullf; Vice-President and Manager, L. B. Penhorwood; Treasurer, E. N. Kierullf.

Los Angeles Office: Wentworth F. Green, 439 So. Western Ave., Los Angeles 5; Telephone DUnkirk 7-8135.

Entered as second class matter, November 2, 1905, at the Post Office in San Francisco, California, under the Act of March 3, 1879. Subscriptions United States and Pan America, \$3.00 a year; \$5.00 two years; foreign countries \$5.00 a year; single copy 50c.

ARCHITECTS' REPORTS are published daily from this office, Vernon S. Yallop, Manager. Telephone DOuglas 2-8311.



# EDITORIAL NOTES

## NATIONAL A.I.A. CONVENTION

Indications are that the Seattle Chapter of the A.I.A. is hard at work in preparation for the annual convention of The American Institute of Architects which is scheduled to be held in Seattle during June.

The theme of this year's meeting is "New Country—New Architecture" a most appropriate basis for viewing the architectural profession throughout the West where unshackled with generations of tradition, custom and use, architects have been free to use their initiative in creating architectural precedent.

Results of this freedom are evidenced by the growing public interest in all parts of America and many foreign countries in "Western Architecture and Western Living". The "Ranch type home" is appearing in almost every nook and corner of the country and western influences are being felt in national architectural thinking.

The June conference will bring architects to the West Coast from all parts of the world. Many of these visitors will take advantage of the opportunity while in "the west" to view first hand much of the construction they have been reading about. Western architects, western architecture and western construction will go "on parade" in June.

\* \* \*

*Andrew Jackson, "Old Hickory", was the first president to have a bathtub installed in the White House.*

\* \* \*

## TAX CUTS

There is a lot of debate these days about whether tax cuts should precede or follow a balanced Federal budget. One of the clearest statements on this problem comes from the National City Bank of New York.

According to officials of the bank "Despite the tendency in much of the current discussion to put expenditure reduction and tax reduction in separate compartments, in reality they are mutually interdependent. Certainly no sound basis exists for tax reduction unless expenditures are drastically reduced. On the other hand, much of the necessary incentive to carry through on expenditure reductions will be lost unless such reductions are going to be reflected in tax cuts pretty promptly.

"The ideal procedure is to have the two move along together. Some individuals may feel it necessary to keep the pressure on reducing expenditures by not letting tax reduction go ahead too fast. Others may feel that by demanding tax reduc-

tion they are bringing pressure for reduction of expenditures . . . hence, there is the risk of getting people lined up in opposing camps when essentially they are working for the same end. The danger is in each side getting 'frozen in' with fixed ideas while the situation is still fluid."

\* \* \*

*Personal income of Americans has more than tripled since '39—BUT, Uncle Sam's tax take is 21 times what it was in '39.*

\* \* \*

## NEW COMPETITION

There is a new kind of competition among American business that makes monopoly almost impossible—the creature of science.

In the construction industry alone during the past few years there has been a tremendous development of "new products" and new application of old products. It is becoming more and more impossible, and unprofitable, for apparent monopolies to exist in the construction industry. Often the so-called "monopolist" loses a part of the market he is trying to control to a "substitute" product which has been created in some commercial research plant.

Steel, aluminum, magnesium, titanium, laminated wood, plastics and many other items used in the construction of almost any type of structure, are in a strong competitive market. Let the price, or quality, of one product fail to satisfy customers and very quickly a substitute will be found and there goes your monopoly.

Advertising plays an important part in this cycle and manufacturers of building materials and products who are reluctant to place their products on the pedestal of public inspection through advertising are soon forgotten.

\* \* \*

*Money spent for advertising actually reduces the cost of consumer goods as advertising creates a volume of sales sufficient to lower production costs.*

\* \* \*

## PLANE PROGRESS

Mundy I. Peale, chairman of the board of governors of the Aircraft Industries Association and President of Republic Aviation Corp. believes every American citizen should interest himself in the matter of the allotment in the 1954 Federal budget for research and development of new military aircraft.

With the globe shrunken to a few hours air travel from almost any given point, the concern of Peale is well founded.



architects · skidmore, owings & merrill  
 designing engineers · strobel & salzman  
 structural engineer · donald r. warren

COLORFUL  
 CLAY  
 BRICK  
*provides*  
*"that substantial look"*  
*for*

**H·J·HEINZ**  
 BABY FOOD PLANT  
 AT TRACY

**CLAY BRICK & TILE ASSOCIATION**  
 SERVING NORTHERN CALIFORNIA  
 Affiliated with Structural Clay Products Institute  
 55 NEW MONTGOMERY STREET, SAN FRANCISCO

*In the interest of better brick and tile construction the following companies have contributed to the publication of this advertisement.*

- |   |                                 |
|---|---------------------------------|
| KRAFTILE COMPANY                          | REMILLARD-DANDINI COMPANY       |
| L. P. McNEAR BRICK COMPANY                | SAN JOSE BRICK AND TILE, LTD.   |
| PORT COSTA BRICK WORKS                    | STOCKTON BRICK AND TILE COMPANY |
| UNITED MATERIALS & RICHMOND BRICK COMPANY |                                 |

Inside or Outside A CLAY BRICK WALL... BEST FINISH OF ALL



# NEWS and COMMENT ON ART

## SAN FRANCISCO MUSEUM OF ART

The San Francisco Museum of Art, War Memorial Building, Civic Center, offers the following special exhibits and events during April.

EXHIBITIONS: Les Fauves; Rental Gallery; Etchings by John Marin; Four Sculptors of the West; Retrospective Exhibition of Paintings and Drawings by Gifford Beal; Contemporary Japanese Prints and Pottery; Prints by Henri Matisse from 1925-1952; and Seven Designers, winners in the recent National Competition.

The Parkmerced Branch offers "A Study of the Fauves," through April 15th; and "How To Read a Photograph."

SPECIAL EVENTS include a special group of Concerts, Lecture Tours, Discussions in Art, and Classes in Art including "Art for the Layman," "Sketch Club," Painting Classes, and Children's Classes. Adult and Children classes in Painting are also being held at the Parkmerced Branch.

## ADVERTISING ART AND DESIGN CLASSES OFFERED

In recognition of San Francisco's growing importance as a center for national advertising and industrial design, the California School of Fine Arts has established a department of Design for Industry, integrated with the full curriculum of the school.

The course offers full professional training based

upon highest academic standards for those seeking a career in these related fields.

Faculty includes Glenn Grohe, cover designer and magazine illustrator; Paul Forster, illustrator and commercial artist; Dorr Bothwell, design developer; Joe Wallace, advanced advertising layout; Edmond Gross, designer and commercial artist; M. Halberstadt, commercial and industrial photographer; Squire Knowles, advertising art and industrial design; Chuck Wertman, lettering for commercial art; Baldassare Armato, lettering, and others.

## CITY OF PARIS ART GALLERY

The Rotunda Gallery of the City of Paris, San Francisco, under the direction of Beatrice Judd Ryan, presents a Memorial Exhibition and Sale of Paintings and Sketches by Nelson Poole early in April. Paintings of India by Frieda Hauswirth Das, Oils by Fay Morgan Taylor, and Oils and Casine by Ralph Cornell Seigle will be on special exhibition all during the month.

Pictures of the Month will feature a select group of Distinctive Prints by Robert Gilberg.

## JAMES D. PHELAN AWARD WINNERS

Thirty-eight watercolors, including four award winners and two honorable mentions selected  
(See page 40)

POLYCHROME TRIPTYCH — Yeishi, 1756-1829



PORTLAND  
ART  
MUSEUM

From the Japanese  
Print Collection

SOME EXCELLENT POINTS ON

# Public Relations For Architects

## "PRESS RELATIONS IN PASADENA"

By **CULVER HEATON, Architect**  
**Chairman, Public Relations Committee,**  
**Pasadena Chapter, A.I.A.**

### PART II

4. **A.I.A. Activities**—Conventions and meetings should always be written from the public's point of view: "Architects Study Effect of Earthquake," etc. Not just a list of architects attending. Always apply this subject to your own community: "Architects Consider New Pasadena Ordinance to Reduce Hazard in Quake . . ."

5. **Women's Architectural League**—This is one department where the Editor likes names, but even so, the releases should be slanted to community betterment, and photographs should stress architecture—"Women's Architectural League Plans Tour of Greene and Greene Homes."

6. **Special Projects**—The first project undertaken was a weekly column in the Sunday paper, "So

You're Going To Build?" It consists of 300 to 500 words on any phase of building, and always illustrates the importance of the Architect. It has been going for over two years and has developed a large reading audience. To date two architects have done the writing, each continuing for one year. This material is now being used by several other chapters in California.

The Education Committee of the Pasadena Chapter did a great deal of research and catalogued the one hundred best architectural examples constructed between 1900 and 1950. Photographs and descriptive material were prepared, together with maps which divided the examples into nine logical tours by areas. This work was completed for a brochure to be distributed by the Chamber of Commerce, but certain technical difficulties arose. As a second project the Public Relations Committee edited this material into nine successive feature articles for the Sunday paper which were enthusiastically received by the Editor. On each Sunday afternoon there was a continuous flow of traffic on the route of the tour. At the completion of the series, the staff of the newspaper expressed



**CULVER HEATON**  
**Architect A.I.A.**

---

*Note: Part I, which appeared in the March issue of Architect and Engineer, dealt with the objectives to be obtained by a public relations program, the "rules of the game" and the material available. The article offers an exceptionally sound approach to any professional-public-press program.—ED.*

sincere regret that the feature was not a continuing one.

At the present time the Committee is launched on a new project, this time at the request of the management of the newspaper. The present Sunday Real Estate Section is gradually to be transformed to a major section featuring the "Home and Interiors." The key story is an illustrated visit to a home designed by an Architect.

#### Advertising

The new program with the press brought the Public Relations Committee such fine results that it was apparent that the newspaper was a logical medium. Keeping the "Objectives" already listed in mind, we decided really to get on the team and experiment with paid advertising. (I wish to emphasize that the idea of paid advertising was originated by the Chapter, not the newspaper.) The fact that the Chapter feels this program is worthwhile is apparent, since we continue to expend \$1,000 per year for this purpose. Part of these funds come from the regular budget, part from special contributions from the architects, and the balance from paid advertising in our Chapter monthly bulletin. All newspaper advertising is on a profession-wide level; individuals are never mentioned.

On special occasions such as the Community Chest, or Red Cross campaigns, we have daily advertisements which read,

**"Always interested in 'Building' a Better Pasadena, the Pasadena Chapter of The A.I.A. urges you to contribute generously to the Community Chest."**

In September of each year an Art Fair is held in Pasadena's Civic Plaza. The Chapter always has a prominent booth and runs advertisements in the paper urging people to attend the Art Fair. Thus you can see that we are continually seeking

opportunities to repeat "A.I.A.," so that it will become as well known as LS/MFT.

#### Results (To Architects)

As a result of this program with the Pasadena **Star-News**, the word "Architect" has become a household term that is used and properly pronounced by the entire community. The term "artist's sketch" has disappeared from the press and has been replaced by "Architect John Doe's drawing."

In keeping the Committee's records we have long since stopped recording the number of times that the word "Architect" appeared. The graph shows the number of news articles each quarter dealing with Architects. These do not include the paid advertising. It is interesting to observe the increase shown after we were "on the team." Also indicated is the point at which the management of the **Star-News** recognized our newsworthiness by requesting our Committee to assist in the development of the new Sunday feature on architecturally designed homes. I feel that a high point in our press relations was achieved when the **Star-News** of its own accord took space from the political campaign and the Korean situation to write an outstanding editorial on the contributions of the late Myron Hunt, F.A.I.A., in Building a Better Pasadena.

#### Results (To the Newspaper)

As a result of the architects' pioneering in the field, other organizations have seen the logic of public relations and have started a program of paid advertising. Among these are the Building Contractors' Association, Plumbing Contractors' Association, Plastering Contractors' Association, and numerous other organizations.

The **Star-News** has also gained the Chapter as a valuable ally who furnishes a large volume of interesting news copy and feature articles.

---

## SHARP COMPETITION AHEAD FOR CONSTRUCTION INDUSTRY ACCORDING TO A. G. C.

Ushered in by the removal of government controls and the general availability of materials, a period of abundant work characterized by intense competition, sharp bidding and lower prices for completed construction jobs is at hand for the construction industry, according to a national survey by The Associated General Contractors of America.

Prices of materials are expected to be relatively stable with increases in some lines, and there is

evidence that labor's demand for wage raises, including fringe benefits in some areas, will be strongly resisted by employers, it was reported.

The survey, covering prospects for the next six months, was made among the association's 80 national directors and 122 chapters throughout the country and Alaska, representing more than 6,200 member-firms of A.G.C. who annually perform more than 80 per cent of the contract construction in the nation as well as a large volume of work



overseas.

### Greater Volume Seen

Member-firms of the association engage in all types of construction, such as industrial, commercial, institutional and residential building; highway, street and airport construction and other types of earth-moving and paving operations; and heavy engineering work such as dams, water-works and sewers, pipelines, dredging, canals, bridges and docks.

The survey, made by telegraph, indicated strongly that the amount of work coming on the market for the next six months of 1953 would be greater than in the comparable period last year for all three general classifications of construction—building, highway and heavy—which the association considers to be all inclusive.

This was considered highly significant in view of the fact that an all-time record of \$42.3 billion in total construction including maintenance and repair operations was put in place by the industry in 1952. The survey findings support official forecasts of a new peak of \$44 billion for the industry in 1953.

### "Intensely Intense"

Almost without exception—the actual ratio was 93 per cent—respondents to the survey, reported a sharp rise in competition, characterized by some as the greatest they had ever experienced. Many of the respondents said it was the most severe since 1940. One contractor from the Middlewest expressed himself thus: "Intensity of competition is intensely intense and no fun or profit on a market such as this.

Another Midwest contractor reported: "Competition has been terrific. Building jobs in this area so far have gone at cost or less." A builder in the Middle Atlantic area wired: "Competition extremely keen. Builders reducing prices to alarming and distressingly low limits." One reply from this region was terse: "Competition terrific." This work came from the Southwest: "Competition more intense in this area than ever before. Work has been going cheap the first part of year."

Other replies were equally emphatic, using such adjectives as "vicious," "rough," "terrible," "keen," "discouraging," "heavy," "tight," etc., to describe the competitive situation in their areas.

### Key to Paradox

The apparent paradox — more work but also more competition per job — was interpreted by A.G.C. officials as a sign that more and more contractors were returning to the market who had not been bidding formerly because of uncertainties caused by controls — uncertainties which translated themselves into costly on-the-job delays for the contractor.

Contractors were being encouraged to bid,

A.G.C. spokesmen said, by substantial assurance that they could now proceed on job schedules at a pace set by themselves for maximum efficiency and economy. They were apparently bidding on many jobs simultaneously, it was believed, and "loading up" on projects which they were able to complete in rapid-fire order with newly-developed techniques and equipment.

Highway and heavy engineering projects especially lend themselves to mechanization on a large scale and the introduction of new machines in these fields in recent years as well as new speed techniques developed in other branches of construction during World War II under the pressure of the heavy volume of defense work have greatly increased the capacity of the industry, A.G.C. officials said.

They also cited the general feeling of optimism among contractors fostered by forecasts of a record year and the belief that a better business climate now prevailed in the country, as an additional factor beckoning contractors to increased activity.

### Highways to Lead

The greatest increase was foreseen in highway construction according to the survey, with 86 per cent of the respondents stating that work in this category of construction would be at the same high volume or greater than in the comparable period of 1952. Sixty-two per cent of the respondents said highway construction would be greater, 24 per cent said it would be the same and 14 per cent said it would be less.

Fifty-four per cent said building activity would be greater in the next six months of this year than in the comparable months of 1952, while 24 per cent said it would be at the same level; giving a total of 78 per cent of the respondents who forecast a volume in this branch of construction higher or equal to the same period last year.

In the field of heavy construction, 64 per cent said it would be greater or the same. This was made up of 41 per cent who forecast a greater volume of heavy construction and 24 per cent who anticipated a volume equal to the 1952 period. Thirty-five per cent looked for a decline in heavy construction.

With the exception of an estimated decline in heavy construction in the Middle Atlantic and Southwestern States, the story foretold by the survey of gains in all three categories of construction activity was a uniform one throughout the country. The Southwest showed the greatest conservatism in its predictions while all the replies from New England predicted gains without exception. The South, Midwest and Pacific Coast areas showed the greatest optimism.

(See page 36)



Encinita

# ELEMENTARY SCHOOL

ROSEMEAD, CALIFORNIA

ARCHITECTS & ENGINEERS  
 MARSH,  
 SMITH &  
 POWELL

Los Angeles in its growth, promotes the expansion of nearby communities as well. Rosemead is such a suburban area—fifteen miles east of the big city.

A community of moderate, comfortable homes, slowly losing its early character as a poultry and orchard section, Rosemead's school population required this addition of the Encinita School.

#### COURT VIEW

Exposed overhead beam projection offers protection to students using walk-way during adverse weather conditions.

*Photos by Julius Shulman*



**SITE:**—A community park, a new high school, and the Encinita School occupy a super block on the westerly edge of the community. The school site of 7.7 acres is supplemented by the park with its paved, open air roller skating court.

**PLAN:**—The typical California finger plan has proved to be successful. The intimate, quiet patios are landscaped and give a beauty to the classroom surroundings that recalls the approach to the school from the street. Five parallel classroom wings are connected at the east by the main Communicating Shelter, and at the west end, they lead directly to the playground.

**CLASSROOMS:**—A word might be said about

the classrooms. They are the typical 32' x 30' California plan. The section, however, is different. Recognizing the difficulty of getting good daylight into the interior of 30' wide rooms, these classrooms employ a high and low window method of day lighting. An alcove on the north side of each room is approximately 10' deep and 7'-6" in height. The balance of the room is 12' high and is daylighted by two clerestories, thus giving quite a uniform light from three sources.

**KINDERGARTENS:**—The double kindergarten has the added feature, by means of a folding partition, of being usable as a small auditorium. This use is only temporary until the new cafeteria auditorium is built.

**PLAYGROUND AREA . . . activities and noise minimized in classrooms.**







ONE OF EUGENE, OREGON, GROWTH SCHOOLS . . . Complete in itself.

# GROWTH SCHOOL

AN ANSWER TO

# COMMUNITY EXPANSION

EUGENE, OREGON

ARCHITECT: CLARE K. HAMLIN

By ARTHUR W. PRIAULX

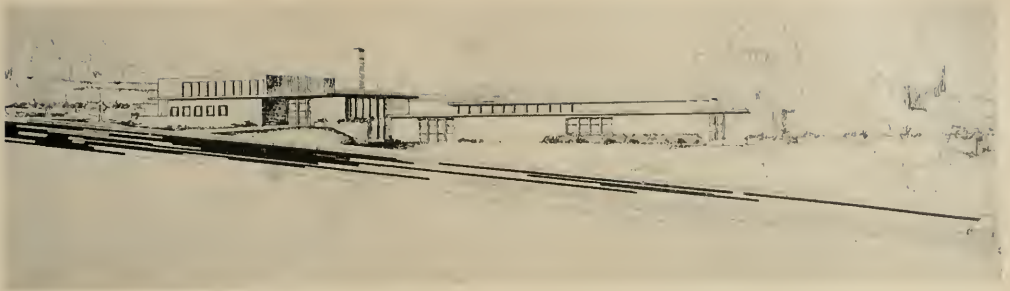

**ADAMS GROWTH SCHOOL . . . showing completed and projected portions.**

The most significant contribution to school planning and design in the post-war era. That is what some school authorities are calling the collaboration of Architect Clare K. Hamlin and City School Superintendent Clarence Hines, both of Eugene, Oregon.

Oregon's second largest city, like most Pacific slope communities, has had unprecedented growth. Population has nearly doubled since the war. Stress pains and problems of all sorts have been created by this expansion. Hard hit has been Eugene's school system. Buildings were inadequate and sorely over-taxed. Worst of all, a tidal wave of primary students—vanguard of the war-baby crop—engulfed the city's school system.

School building needs were lop-sided, heavy to primary grades. But, the problem would progress as these war-babies stepped along in school. Need for school rooms for advanced grades could be postponed.

Clarence Hines thought of the newlyweds with

their "starter home." Why not a "starter school" or a "growth school" as he prefers to call his invention? He took his problem to Architect Hamlin.

Hines told Hamlin the school system was close to its bonded debt limit. What was needed were four growth schools which could be added to each year from a serial tax levy which would raise \$250,000 a year for five years.

Hamlin designed identical master plans for two schools and variations for the other two, with the floor plan of the completed school in the shape of a three-fingered hand.

Started in July, 1949, was the central core of the Adams Street School and the Harris Street School. They contained a general purpose room, which doubled as auditorium, recreation room and lunch room. Adjoining was a cafeteria and kitchen. Also in the central core was the heating plant, two administrative rooms for office and principal, a toilet bank and four classrooms, all identical. The two schools are built on almost identical sloping hills

**ONE SIDE  
OF SCHOOL**

**Is all glass and rooms  
open onto closed  
courtyards where  
classes are held dur-  
ing good weather.**

*Photos by  
TOM BURNS, JR.*





**COVERED ARCADE:** Shelters children when they travel from central heart of structure to either wing.

to allow for two levels. A lower level in the administrative section contains first aid room and teacher's rest room and lounging room.

The palm of the hand is the main block of the building, built of masonry with brick fingers. The fingers extending parallel from the core contain the classrooms and are frame construction.

The schools have grown every year. In 1950, the second unit was added. It consisted of two more classrooms plus a toilet bank and janitor's room, which formed the start of the upper finger or wing.

In 1951 two more classrooms were added on the upper wing and in 1952 two more were projected on the same finger with the addition of another toilet bank. Planned for 1953 are two more classrooms, to be added to the four in center finger. The first four classrooms built in 1949 formed the first unit of the center wing or finger. In 1954 another arcade will be built and the third wing started parallel to the center finger and to its right down the hill. Additions of two classrooms a year are planned until 1956. But, these are minimum plans and if the school population continues to grow, the fingers can be extended.

A basic plan has been followed throughout the unusual structures. Each classroom is identical—

**Core of school from lower level. Play field opens directly into first aid room. Final wing of school will connect with core by covered arcade.**





30 by 36 feet in size. All rooms are entered from a single-loaded corridor which parallels the classrooms along each wing. Each room has an exit into the corridor and also an exit into a play and outdoor classroom area. These areas are separated from those of adjoining rooms by a screened shoulder-high wooden mask to give teaching privacy.

Similar to the Harris and Adams schools are two other growth schools also designed by Architect Hamlin. Both are located outside the city limits of Eugene in the fast-growing suburban districts, but are a part of the Eugene city school system. The Washington grade school was started in 1950 and has been increased each year since then. The Howard grade school follows pretty much the basic plan of the other three and has been expanded each year under a carefully worked out plan to care for advancing grades.

The growth schools are being built at a cost of about \$8.50 a square foot—low by most present-day standards. Actually, the state average in Oregon per school room for construction costs today is \$17,000. Hines figures to get a completed 18-room growth school house built over an eight-year period for about \$14,800. Here's the way it works out. His core unit with 10 classrooms (including first four built in 1949 and two each for next three years) has cost \$172,000. That means an average of \$17,200 a classroom. But, the next eight



**HEART of Growth School viewed from front entrance. Stairs at left lead down to teachers and first aid rooms. Principal's office opens at extreme right. Glass doors in foreground enter into play area. One corridor for center wing extends away from center. Hallway to left enters arcade to upper wing and auditorium.**

**BELOW: View shows two wings completed, upper and center.**





**STANDARD** corridor built as single loaded section paralleling each classroom wing. Note fir panelling used along walls to withstand heavy use.

**BELOW:** Each wing is separate structure, ample room has been left around each section of school to allow plenty of light. Play areas do not face from any wing.

rooms will cost only \$96,000. So, the average cost per classroom will be \$14,800 when the 18-room school house is completed.

Hines doesn't take any credit for inventing the novel financing and design problems solved in the growth schools. He says this type of school building program is realistic and practical. By paying for each growth section each year, bonding costs are saved. So is depreciation on unused portion of building erected and the rooms for the advanced grades remain idle for several years until the students grew into them. It would be like buying two cars and letting one sit in the garage and eat itself away in depreciation, he says.

Equally as important as the financing problems solved are the human and student equations answered. The school authorities were able to say to each parent of a beginning first, second or third grader first enrolled at either of the four schools: "Your child will not have to change schools. He will be able to complete his full six years of elementary training in the school where he first enrolls."

Students graduate to a junior high school after six years in the elementary grades, Superintendent Hines points out, so the growth schools serve the young students until they are ready for the next highest ranking school.

The child thus has less feeling of insecurity which arises when he changes schools before



**Tables and benches erected by pulling down from wall. Auditorium serves school and communities for variety of uses.**

graduation. Miss Glendora Burbank, principal at Adams Street School, believes the growth school will develop its own particular teaching philosophy. She likes the idea of eliminating insecurity, of contributing to a student's stability, and she thinks her school has developed a rather striking esprit de corps among the students not usually found in the grade level. She would like to see the covered play area or gymnasium built at the same time as the central core in future growth schools, rather than the last unit to be constructed. Pupils who attend these growth schools during the growth period lose out on this important aspect of school life—indoor play space during winter months—under the present order of completion of school facilities.

So successful has the growth school plan been that now the city and adjoining county schools are using the idea to enlarge older schools. Growth sections of uniformly designed school rooms are added in wings or fingers just the same as the original growth buildings.

Architect Hamlin developed a basic classroom which could be added to a wing with the least possible inconvenience to the students and teacher in the room nearest the addition.

The classroom rests on a concrete slab covered with asphalt tile. The fingers containing the class-



rooms are frame, studded walls. A V-joint, horizontal Douglas fir panelling covers the walls in the entire teaching space. Wood was used by Architect Hamlin because it will take the beating administered by countless students, and the maintenance is low. The exterior of each classroom wing has been finished in cedar siding stained to eliminate maintenance and upkeep costs.

Heating is a combination of radiant hot water coils along the wall at floor level and forced-air fanned coils higher in the walls.

Bilateral lighting gives almost perfect diffusion. High windows in nine-foot bays form one solid

#### **AUDITORIUM**

**Multi-purpose room; hot dishes served from counter kitchen at left rear.**

**Tables and benches fold into wall. Collapsible stage also.**





## OREGON GROWTH SCHOOL . . .

wall of light and a high clerestory installation on the opposite wall above the single-loaded corridors add to uniformity of light admission into the room. Window glass is 3/16 inch sheet crystal.

Artificial light is provided by indirect concentric ring type of incandescent lights hung down pendant style with the light reflected back against the bright ceiling of acoustical tile.

A built-up composition asbestos felt roof is laid over the roof surface of shiplap and is supported by two-by-fourteen inch fir joists laid on thirteen and one-half inch centers. To provide adequate insulation from heat and cold, a rigid one inch layer of modern-type insulation material was laid directly on the solid shiplap roof deck and then covered with the asbestos roofing. Every detail of design has been adapted to enable easy expansion with a minimum of expense. Electric wiring along the corridors can be reached with a minimum of trouble. It has been placed in an inverted trough. When the cover is removed, the various supply conduits are easily gotten at for servicing.

All corridors as well as classrooms have been finished with horizontal Douglas fir panelling with a tight V-joint. Natural color of wood has been retained by use of a clear rez finish throughout.

These long corridors get plenty of rough usage and fir was installed to withstand the constant wear.

The auditorium and all-purpose room has been cleverly designed to provide for easy transformation from cafeteria to gymnasium to auditorium. Tables can be pulled out from the wall, so can the stage and other furniture.

Another feature of the growth schools developed by Hines and Hamlin in their long-range planning is the ease with which each building can be extended beyond the originally planned 18 rooms. If the need is still apparent for more primary and grade school classrooms after 1956, the growth schools can be enlarged to 24 rooms or even more. The basic floor plan is flexible and wings can be run out from the main core of the building as far as ground space permits.

Each classroom wing has been designed as a self-contained unit with its own toilet banks and small storage rooms for janitor's supplies. This cuts down traffic between each wing and from wings to main building core. The upper wing is joined to the main core by a covered arcade and is reached from the core level by steps from the arcade. In effect, each wing is a separate building and is dependent on the core only for heat from

**WINDOW WALL**—with door to outside play area. Rooms well lighted, airy, clean.



the central system. Ultimate plans call for a gymnasium to be located at the far end of the lower wing away from the office and administrative section.

These first four growth schools have been trial horses. Much has been learned by both architect and school authorities. Undoubtedly future growth schools, whether undertaken by Eugene or other communities, will take into consideration need for covered playground facilities early in the life of the school, probably about the time the first unit is constructed. There seems also merit in the suggestion of Adams Street School Principal Burbank, that the gymnasium be advanced on the growth timetable.

School officials have attempted at all times to keep construction costs at a minimum in these rather remarkable growth schools. Competition has been encouraged and contracts let each year for the additions. Result has been that five contractors, H. L. Shields and Son, E. E. Setergren, W. S. Hardie and Son, W. H. Shields, and Gale M. Roberts, have at various times built portions of these schools.

Biggest problem confronting school officials, believes Hines, is getting the public to realize the needs. The growth school is the answer to lack of money. At the end of eight or ten years, you have your school, but it is all paid for from current tax income, the school official pointed out. School districts can keep out of debt and save the cost of renting money over a period of years. Interest charges can be spent each year for school facili-



Teachers Lounge—part of basement level provide facilities for relaxation.

ties. Where school districts are faced with bonded debt limits, the growth schools may be the only answer.

Probably the most interesting feature of the growth school as worked out in Eugene, is the low cost per classroom unit in the growth school compared to the average classroom cost for the state of Oregon. Undoubtedly, much of this saving must be credited to Architect Hamlin for developing a design for the wings so that additional classrooms could be added with little additional cost for connecting roof, floor and wall lines and joining up utilities and corridors.

The pay-as-you-go growth school, in the eight

(See page 40)

**Sinks, Cabinets and other conveniences have been built into each classroom in standard location to left of corridor entrance.**

**Each room is a complete teaching unit.**





# Greenbrae Elementary School

MARIN COUNTY, CALIFORNIA

ARCHITECT: WILLIAM CORLETT, A.I.A.

CONSULTING ENGINEER: WALTER STEILBERG

ELECTRICAL & MECHANICAL ENGINEER, G. M. SIMONSON

OWNER: KENTFIELD ELEMENETARY SCHOOL DISTRICT

CONSTRUCTION COST: \$14.04 Per Sq. Ft.



## STRUCTURE:

The lower grade classroom wing, which was previously constructed in 1950, utilizes an open Web Steel Joist at 4 ft.-0" centers, spanning 36 ft.-0" from 8 inch WF corridor columns at 12 ft. centers to the south wall, with the remainder of the structural frame in wood set on concrete footings and radiant heated concrete slabs. The construction cost of this was \$11.00 per sq. ft.

The upper grade classroom wing utilizes a 12 in. WF beam at midspan at the classroom and on 8 in. WF beam at the north and south walls with 20 x 10 wood joist at 16 in. centers spanning 12 ft.-0". The remainder of the structure is wood frame set on concrete footings, concrete floor slab radiant heated 3/8 in. plywood wall surfaces, and acoustical tile ceilings. Steel sash and vertical redwood siding on diagonal sheathing, and built-up composition roofing on diagonal sheathing complete the structure.

The Administration Building utilizes a 4 in. x 12 in. exposed wood ceiling joist at 4 ft.-0" centers. It has a wood frame, plywood interior walls, acoustical tile ceilings, vertical redwood exterior siding, and steel sash.

The Multi-Use Room utilizes laminated wood

arches on 16 ft.-0" centers spanning 50 ft.-0", and 6 in. x 10 in. purline at 6 ft.-0" and sheathed with 2 in. x 6 in. T&G, straight layed. The wood frame has 3/8 in. plywood interiors, a 12 ft. x 50 ft. specially designed heat reducing glass skylight, built-up composition roof with special surfacing, and a vertical redwood exterior siding. Concrete slab floors are covered with asphalt tile, and warm heat supplies in a space above the kitchen return on east wall.

The covered corridors are exposed 2 in. x 6 in. T&G sheathing spanning 8 ft.-0" to a 4 in. x 8 in. wood girder which is supported on pipe columns at 10 ft.-0" centers.

## CONSTRUCTION SUMMARY:

The six classrooms, Administration building, Multi-use Room, and Kitchen addition abandoned the use of Open Web Steel joist as a roof framing because of the uncertain availability of steel. To comply with the N.P.A. restrictions in effect at the time of construction, steel used in the new addition was limited to twenty-two tons. The Multi-Use Room laminated wood arches, although slightly more expensive than steel per arch, proved simpler to tie into the roof membrane and were immediately available on a competitive bidding basis.

# GREENBRAE ELEMENTARY SCHOOL

KENTFIELD ELEMENTARY SCHOOL DISTRICT · GREENBRAE · MARIN COUNTY .

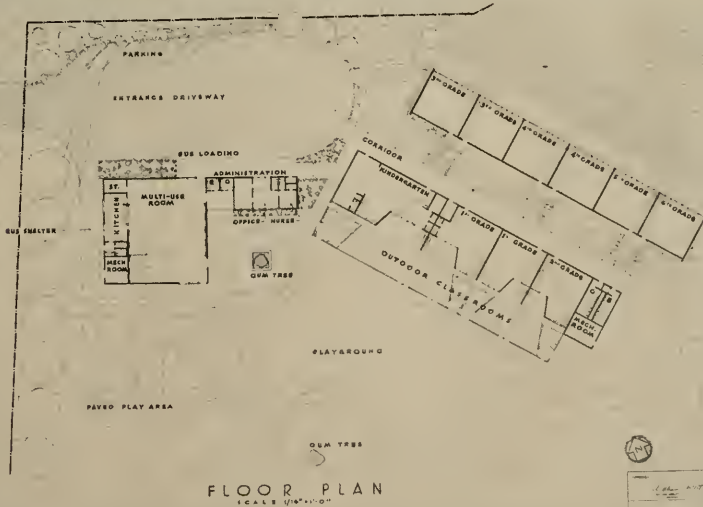

WILLIAM CORLETT AIA  
GREENBRAE ELEMENTARY SCHOOL  
GREENBRAE · MARIN COUNTY

# GREENBRAE SCHOOL . . .



**Typical Classroom . . .** windows facing hill, acoustical tile ceilings, display boards at rear, movable desks and seat combinations, indirect lighting and asphalt tile floors.

**Multi-Use Building (below) . . .** Auditorium and Cafeteria, exposed laminated wood trusses, skylight, partial glass ends of building, portable tables and asphalt tile floors.



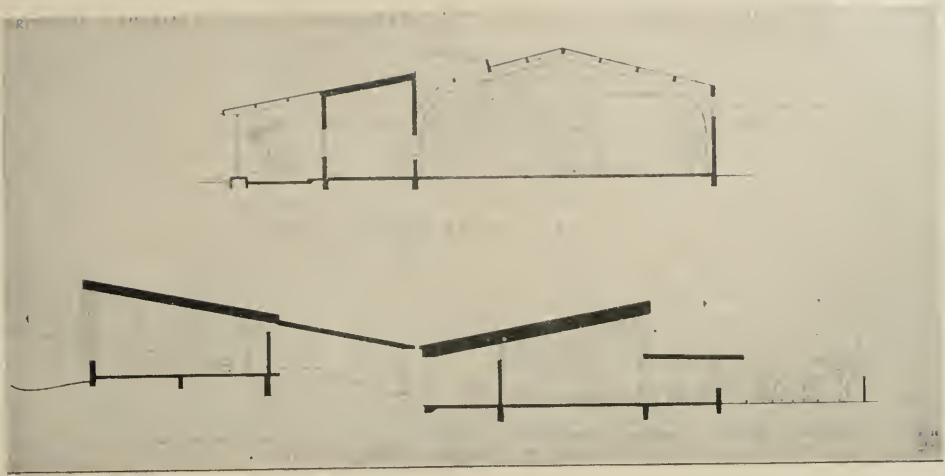

Section . . . through classroom buildings.

**SITE UTILIZATION:**

The seven and one-half acre school site was donated to the school district by the surrounding residential tract with the deed restriction that no building facility or playground apparatus could be placed within fifty feet of any property line. This

stipulation eliminated the intended placement of the Multi-Use Building at the northwest corner of the site, but set up the design layout which clearly separates automobile and bus traffic from the playground area.

The Kindergarten and lower grade classrooms

**PLAYGROUND AREA—showing location of buildings for maximum lighting.**





## GREENBRAE SCHOOL . . .

were placed on a relatively level portion of the site so as to allow the development of individually fenced outdoor classrooms. The long dimension, 36 feet, of the lower grade classrooms is set at right angles to the thereby reduced length corridor.

The Upper-grade classrooms, which measure 30 ft. x 32 ft., were more readily placed on sloping northeast portion of the site which is unusable as a playground.

Two existing handsome gum trees were considered in the placement of the building units and the development of an outdoor eating court east of the Multi-Use Room. A magnificent view of Mt. Tamalpais to the southwest of the site influenced fenestration on the project.

### INTERIOR TREATMENT:

The kindergarten and lower grade classrooms incorporate the use of low ceilinged, 7 ft.-0", activity alcoves. The alcove roof over hang, 4 ft.-0", controls the south light as well as provides a covered adjacent area for the outdoor classrooms. Classroom walls are of  $\frac{3}{8}$  inch stained plywood, and all ceilings are surfaced with an acoustical

tile. Concentric-ring incandescent fixtures light the classrooms.

The 50 ft. x 64 ft. Multi-Use Room contains ten cafeteria tables with benches which fold into wall recesses when the room is being used as an auditorium or for community folk dancing. A 10 ft. x 16 ft. folding platform 18 in. high may be set up at the north end of the room if desired. Ample storage is provided for the chairs. The kitchen will serve 350 meals, cafeteria style. The room will seat 350 persons for simple stage presentations or musical programs.

### CONSTRUCTION COST:

The construction cost was \$14.04 per square foot.

### SUMMARY:

The design of the Greenbrae Elementary School is an effort of the architect to "Residential-ize" the character of the school in keeping with the architect-designed surrounding tract residences, as well as to avoid the "Shoe-box" character of structure forced upon so many school projects by increasing building costs.

ENTRANCE—showing location of building in relation to terrain of site.





**Air View of Sacramento—Showing buildings within a short radius of the State Capitol grounds . . . new Annex to right of original Capitol Building with dome.**

# CALIFORNIA CAPITOL

## NEW EAST WING

Sacramento, California

By **ANSON BOYD**

**STATE ARCHITECT OF CALIFORNIA**

The erection of a new State Capitol, or an addition to one already built, is always a complex problem. In California this is particularly true due to the immense volume of business done by the Legislature, the Governor, and the Constitutional

Officers. This business has been further enlarged by the rapidly growing responsibilities of this government caused by the spectacular growth of the state's population. This is perhaps the greatest growth that history has recorded as having taken

## NEW EAST WING . . .



*R. A. Munroe, Photographer  
Division of Highways,  
State of California*

place so quickly in any given area of the earth's surface.

The Legislature and the other State officials in the Capitol obviously could not cease operations while a new building was being constructed. The first phase of the problem required that an addition must be built right through the regular flow of business, through at least two sessions of the State Legislature, and that the transition of expansion minimize insofar as possible the normal disturbances of moving.

The second phase of the problem was that of engineering. Much of the area under and around Capitol Park was at one time or other the bed of a river, or a slough, during the geologic history of this part of the country. Most of the surrounding concrete buildings are built on pile foundations driven thirty or more feet below the ground level. The placing of an addition to the Capitol on a pile foundation was inadvisable so close to the foundations of the original Capitol Building. To obviate this difficulty, a structural steel frame on a huge inverted waffle type foundation was decided upon and developed, and a lightweight concrete structure was decided upon.

One of the net results of this intricate engineering problem was the necessary reduction of the dead weight of the entire building to about one-half the weight of a standard reinforced concrete structure of the same size.

The third broad phase of the whole problem was



**Elevator Lobby  
and  
Main Corridor  
on the  
First Floor.**



financial. The Capitol addition was estimated in round numbers at slightly under \$7,500,000. It has been completed within this figure, and there is a balance of money left unexpended. There may be other Capitol buildings which have been built within the basic original estimate, but if so we are not aware of these.

The alternative methods of meeting the problem of expanding the Capitol would have been first to erect an entirely new Capitol structure. This could not have been done on the site of the existing Capitol for the reasons previously stated, namely: that the principal offices of the Government, including the Legislature, must meet and do business continuously. The erection of a new Capitol, for instance within the present Capitol Park, along lines roughly comparable to other State Capitols built during the last fifty years, would have cost somewhere within the neighborhood of \$30,000,000.

The second alternative method would have been the purchase of a large tract somewhere in the city of twenty to thirty blocks of property, the clearing of same and the development of large and monumental State governmental center at a cost of probably in considerable excess of \$100,000,000.

The new East Wing to the State Capitol is a working type office building. Its cost at the time



GOVERNOR'S STUDY . . .

of award of contract was in straight dollar comparison about 75 per cent of that of the Headquarters building which were being built by various large corporations in the State of California at the same time.

Various phases of the planning, designing, building and completion of the new wing were carried out by the architectural designing, mechanical engineering, electrical engineering, structural engi-

(See page 45)

## *Artistry in Steel*

### TOLAND

recently completed the largest decorative metal contract on the West Coast in the State Capitol Annex, Sacramento . . . Miles of aluminum, plus nickel silver (white bronze), stainless steel and miscellaneous iron — a symphony of outstanding ornamental craftsmanship.

**C. E. TOLAND & SON**  
ORNAMENTAL METAL CRAFTSMEN

SAN FRANCISCO

# American Institute



# of Architects

Glenn Stanton, President  
Kenneth E. Wischmeyer, 1st Vice-president  
Norman J. Schlossman, 2nd Vice-president  
Clair W. Ditchy, Secretary  
Maurice J. Sullivan, Treasurer

National Headquarters—  
1741 New York Avenue, N. W.  
Washington, D. C.

Edmund R. Purves  
Executive Secretary

Arizona Chapter:  
Richard Drover (Phoenix), President; Lew Place (Tucson), Vice-President; Martin J. Young, Jr. (Mesa), Secretary; Fred O. Knipe (Tucson), Treasurer; and Richard Drover, Fred Weaver and Ed Varney (Phoenix), and Martin Ray Young, Jr. (Mesa), and Gordon Luepke (Tucson), Executive Board members.

Coast Valleys Chapter:  
Kurt Gross, President; Harold Ahnfeldt, Vice-President; Frank C. Treseder, Secretary; Jerome Kasavan, Treasurer. Directors, Hollis Logue and Gifford Sabey. Offices, 82 S. 3rd St. San Jose.

Central Valley of California:  
John W. Bomberger, President; Nicholas Tomich, Vice-President; Albert B. Thomas, Secretary; Ted de Wall, Treas.; Gordon Stafford, Director; Alternate to CCA, Silvio Barovetto; Sec. Office 718 Alhambra Blvd., Sacramento.

Colorado Chapter:  
James M. Hunter, President, 2048 Broadway, Boulder; Casper F. Hegner, Secretary, 1659 Grant Street, Denver 5.

East Bay Chapter:  
Chester H. Treichel, President; Malcolm D. Reynolds, Vice-President; John E. Lloyd, Secretary; Roger Lee, Treasurer. Secretary's Office 1171 Solano Ave., Albany, California.

Idaho Chapter:  
Frederick C. Hummel, President; Jack Woodmansee, Vice-President; Jed Jones III, Sec.-Treas. Offices 1324 Idaho Street, Boise, Idaho.

Montana Chapter:  
E. Edward Sawcroft, President (Billings); J. Van Tavlingem, Vice-President (Great Falls); H. C. Cheever, Secretary-Treasurer. Secretary office, Bozeman.

Nevada Chapter:  
Walter Zick, President, Las Vegas; Russell Mills, Vice President, Reno; Keith Lockard, Secretary, Reno; Directors Edward Parsons, L. A. Ferris, David Vhay, Reno. Office of President P. O. Box 2107, Las Vegas.

Nevada State Board of Architects:  
Russell Mills, Chairman, Reno; Aloysius MacDonald, Secretary, Las Vegas; Edward Parsons, L. A. Ferris, Reno, and Richard Stadleman, Los Vegas, Members. Office, 309 S. 5th St., Las Vegas.

Northern California Chapter:  
Albert R. Williams, President; Donn Emmons, Vice-President; William Corlett, Secretary; Bernard J. Sabaroff, Treasurer. Helen H. Ashton, Office Sec., Offices 369 Pine Street, San Francisco.

## SAN DIEGO CHAPTER

Philip W. Helsley, Civil Engineer and head of the San Diego Testing Laboratory, spoke at the March meeting on the subject "Technical and Practical Phases of Controlled Fill for Building and Road Foundations," giving a number of practical illustrations on various phases of proper preparation for construction projects.

Remember it's

**KRAFTILE**

- for ★ GLAZED STRUCTURAL WALL UNITS
- ★ PATIO TILE
- ★ FACE AND ROMAN BRICK
- ★ ACID FLOOR BRICK
- ★ HEARTH BRICK
- ★ BRICKETTES
- ★ MINWAX TILE & CONCRETE FLOOR FINISH

For complete information and prompt service, phone or write

**KRAFTILE COMPANY**

NILES, CALIFORNIA

NILES 3611

LOS ANGELES 15: 406 South Main Street—MUual 7241

Member Louis Dean has been elected treasurer of the California Council of Architects for 1953.

Standing committee chairmen, appointed by president to serve during 1953 include: Membership, Louis A. Dean; Practice, H. Louis Bodmer; Construction Industries, Jack R. Lewis; Governmental Relations, George C. Hatch; Legislative, Wm. P. Lodge; Education and Research, Clarence J. Paderewski; Public Information, Sam W. Hamill; Allied Arts, Robert Mosher; Civic Design, Lloyd Ruocco; Exhibits, Wm. L. Wilkinson, Jr.; Historical Buildings, Ray Alderson; Fellows, Wm. Templeton Johnson; Special Events, Delmar Mitchell; Archives, Robert T. Parfet; and delegates to the San Diego Art Council, Robert Mosher and Sim Bruce Richards.

## OREGON CHAPTER

The April meeting was a special meeting in Eugene with the Student Chapter. An inspection was made of student work at the School of Architecture, followed by a dinner in the Erb Memorial Student Union and an address by Buckminster Fuller on the subject, "Experiments in Design."

The regular business meeting was held on April 21 in Portland.

## A. I. A. GOLD MEDAL WINNER ANNOUNCED

William Adams Delano, F.A.I.A. of New York City, will be awarded the 1953 Gold Medal of The American Institute of Architects at the Institute's annual convention in Seattle, Washington, June 16-19.

Other outstanding awards will include the Fine Arts Medal to Donald Hord, sculptor; the Craftsmanship Medal will be given to Emil Frei of St.

Orange County Chapter:  
William Blurock, Corona del Mar, President; George Lund, Balboa, Secretary; Paul O. Davis, Corona del Mar, Treasurer. Office of Secretary, 2919 Newport Blvd., Newport Beach.

Oregon Chapter:  
H. Abbott Lawrence, President; Holman J. Barnes, Vice-President; Donald W. Edmundson, Secretary; and Robert W. Tritsch, Treasurer. Office of Secretary, 325 Henry Bldg., Portland.

Pasadena Chapter:  
Robert E. Langdon, Jr., President; Wallace C. Bonstill, Vice-President; Robert L. Deines, Secretary; Henry C. Burge, Treasurer; and Directors John M. Douglas, R. VanBuren Livingston, Scott Quaintin and Burton Remberger. Offices: 259 South Los Robles Ave., Pasadena 5.

San Diego Chapter:  
Donald Campbell, President; Victor L. Wulff, Jr., Vice-President; Richard L. Finkel, Secretary; Edward G. Helliwig, Treasurer; Louis A. Dean, Director. Office Sec., San Diego Trust & Savings Bldg.

San Joaquin Chapter:  
David H. Horn, President; William G. Hyberg, Vice-President; Richard P. Clark, Secretary; Bryan C. Brodrick, Treasurer. Sec. Office, 335 Anglo Bank Bldg., Fresno.

Santa Barbara Chapter:  
Wallace W. Arendt, President; Roy W. Chesman, Vice-President; Chester Carjala, Secretary; Lutch M. Riggs, Treasurer. Sec. Offices, 129 De la Guerra Studios, Santa Barbara.

Southern California Chapter:  
Henry L. Wright, President; U. Floyd Ribla, Vice-President; Cornelius M. Dasey, Secretary; Savo M. Stoshitch; Hugh R. Davies, S. Kenneth Johnson, Kemper Namland and Chas. E. Fry, Directors.  
Headquarters, 3723 Wilshire Blvd., Los Angeles 5.

Utah Chapter:  
W. J. Monroe, Jr., President, 433 A'las Bldg., Salt Lake City; M. E. Harris, Jr., Secretary, 703 Newhouse Bldg., Salt Lake City.

Washington State Chapter:  
Paul Thiry, President; John S. Dettie, 1st Vice-President; Robert H. Wahleib, 2nd Vice-President; Robert H. Dietz, Secretary; and Edwin T. Turner, Treasurer. Alice Gregor Executive Secretary, 430 Central Building, Seattle 4.

Spokane Chapter:  
B. K. Ruehl, President; Victor L. Wulff, 1st Vice-President; Philip Keene, 2nd Vice-President; Laurence G. Evanoff, Secretary; and Carroll Martell, Treasurer. Office 515 American Legion Bldg., Spokane, Washington.

Tacoma Society:  
E. N. Dugan, President; P. G. Ball, Vice-President; Lyle Swedberg, Secretary-Treasurer.

Hawaii Chapter:  
Kenji Onodera, President, 3518 McCorry St., Honolulu, T. H.; George J. Wimberly, Secretary, 315 Royal Hawaiian Ave., Honolulu, T. H.

CALIFORNIA COUNCIL OF ARCHITECTS  
Charles E. Fry, President, Los Angeles; Malcolm D. Reynolds, Oakland, Vice-President; Lawrence Gentry, Los Altos, Secretary; Louis A. Dean, San Diego, Treasurer; Fred A. Chase, Executive Secretary, 3723-A Wilshire Blvd., Los Angeles.

#### ALLIED ARCHITECTURAL ORGANIZATIONS

San Francisco Architectural Club:  
Joseph Scomea, President; Frank S. Gerner, Vice-President; Russell W. Pennell, Treasurer; Frank L. Barsotti, Secretary. Club Quarters: 507 Howard St., San Francisco.

Producers' Council—Southern California Chapter:  
Bert Taylor, President, Pittsburgh Plate Glass Company; G. Robert Roden, Jr., Vice-President, Truscon Steel Company; Malcolm G. Lowe, Secretary, Natural Gas Equipment Inc.; Richard Seaman, Treasurer, W. P. Fuller & Company; Vern Boget, National Director, Gladding McBean & Co.  
Producers' Council—Northern California Chapter (see Special Page)

### WASHINGTON STATE CHAPTER

The April meeting was held in Tacoma with Ex-State Treasurer Tom Martin speaking on the subject "State Development". Prior to the dinner meeting members were treated to a demonstration

(See page 33)

Louis; the Edward C. Kemper Award will go to Gerrit J. de Gelleke, F.A.I.A. of Milwaukee, Wisconsin; and two Honorary Memberships will be awarded, one to Gurdon M. Butler of Tucson, Arizona, and the other to Frank Creedon, long time Federal official.

### CALIFORNIA COUNCIL OF ARCHITECTS

Architect Charles E. Fry of Los Angeles, and immediate past president of the Southern California Chapter AIA, was elected president of the California Council of Architects at the annual meeting held in the Hotel Statler. He succeeds William Koblik, architect of Sacramento.

Malcolm D. Reynolds, architect of Oakland, was elected vice president; Lawrence Gentry, architect of Los Altos, was named secretary; and Louis A. Dean, architect of San Diego, was chosen treasurer.



CHARLES E. FRY  
President

Other items taken under consideration at the Council's meeting were a number of measures introduced at the current session of the California State Legislature pertaining to the construction industry and the practice of architecture. A full report of all legislative bills, with recommendations, has been sent to Chapter presidents for transmittal to A.I.A. members throughout the state.

William Hempel, architect of Palo Alto, was named Council Liaison Officer with the Central Committee of the Women's Architectural League.

## 12 BIG REASONS WHY ANTI-HYDRO ASSURES DURABLE CONCRETE

1. Increases slump of concrete!
2. Permits use of less water in concrete mix!
3. Permits control of hardening time of concrete!
4. Produces early strength concrete with portland cement!
5. Steps up the strength of concrete!
6. Reduces shrinkage over untreated concrete!
7. Produced 100% watertight concrete in government tests!
8. Protects steel reinforcing from corrosion!
9. Effects a perfect bond between mortars and concrete!
10. Cuts cost of cement finishers' time!
11. Internally cures, hardens, dust-proofs concrete floors!
12. Offers field inspection service on jobs to be guaranteed!



DISTRIBUTED BY

**PCA** Pacific Coast  
Aggregates, Inc.

CONTACT THE NEAREST P.C.A. OFFICE  
SAN FRANCISCO OAKLAND SAN JOSE  
SACRAMENTO STOCKTON FRESNO



# WITH THE ENGINEERS

## Structural Engineers Association of California

John E. Rinne, President, San Francisco; Jack S. Barrish, Vice-President, Sacramento; Leslie W. Graham, Secretary-Treasurer, San Francisco. Directors John J. Gould, R. W. Binder, M. A. Ewing, Leslie W. Graham, Jack S. Barrish, Harold P. King, W. T. Wheeler, John E. Rinne and Donald F. Shugart. Secretary's office, c/o Associated Structural Engineers, 417 Market St., San Francisco 5.

## Structural Engineers Association of Northern California

George A. Sedgwick, President; Michael V. Pregnoff, Vice-President; John M. Sordis, Secretary; William K. Cloud, Treasurer; Robert P. Moffett, Asst. Sec.-Treas.; Directors, Robert D. Dalton, Robert D. Dewell, William H. Ellison, John J. Gould and J. Albert Paquette. Offices: 417 Market St., San Francisco.

## Structural Engineers Association of Central California

William H. Peterson, President; Walter S. Wassum, Vice-President; O. T. Illich, Sec.-Treas.; Ernest D. Francis, M. A. Ewing, and Arthur A. Sauer, directors. Office O. T. Illich, c/o Div. of Arch., Sacramento.

## American Society of Civil Engineers Los Angeles Section

Trent R. Dames, President; Stephenson B. Barnes, Vice-President; John M. Server, Vice-President; C. Martin Duke, Secretary, and John Merrell, Jr., Treasurer. Office of Secretary, 3066 Engineering Building, University of California, Los Angeles 24.

## American Society of C. E. San Francisco Section

J. G. Wright, President; J. E. Rinne, Vice-President; Howard C. Wood, Vice-President; John S. Longwell, Past President; H. C. Medbery, Secretary, and Richard C. Clark, Treasurer. Office Secretary, S. F. Water Dept., Millbrae.

## AMERICAN SOCIETY OF CIVIL ENGINEERS LOS ANGELES SECTION

Fr. Thaddeus H. Kreye, O.F.M., St. Anthony's Seminary was the principal speaker at a recent meeting of the Los Angeles Section of the American Society of Civil Engineers held at the University of Southern California. Fr. Thaddeus is Director of the Santa Barbara Mission Restoration and has been engaged in the restoration of several of the 21 historical missions established by the Franciscan Order. He outlined the history of the Mission, emphasizing its structural detail.

Fr. Thaddeus related the severe damage to the front of the church during the 1925 earthquake and the subsequent restoration in 1927. Need for restoration became critical in 1949 when results of reactive aggregate in P. C. Concrete and failure to follow construction plans caused severe structural failures. He described plans and progress of the present restoration.

At the Jr. Forum preceding the section meeting Elwyn H. King, Jr., A.S.C.E. described his welding design that won the 1952 Lincoln Electric Award.

Meetings are held the second Wednesday of each month. April and May meetings will be held at the University of Southern California campus.

## STRUCTURAL ENGINEERS ASSOCIATION NORTHERN CALIFORNIA

Henry Schweim, secretary of the Gypsum Association, was the principal speaker at the April meeting held in the Engineers Club, San Francisco. He spoke on the subject "Gypsum Roof Construction," and covered the history of gypsum roof construction, various types, adaptability and methods of use with slides.

The California Legislative Council of Professional Engineers reported some 107 bills in the California State Legislature of special interest to the Professional Engineers and Land Surveyors.

It was announced the Annual Picnic will be held on July 18 at the Sonoma Mission Inn, Sonoma, California.

## STRUCTURAL ENGINEERS ASSOCIATION OF OREGON

The following officers were named at the annual meeting to serve for the ensuing year:

Lewis R. Ellingwood, President; Robert M. Bonney, Vice President; Sully A. Ross, Secretary-Treasurer.

Named as directors were, William J. Dorner, Roger V. Gillam, Leslie E. Poole, and Rowland S.



Always  
Specify  
**HAWS**  
for Highest Quality

A complete line of fountains, electric water coolers, faucets, filters and accessories. • Individual or multiple installations. • A reputation for reliability since 1909. • Check in Sweet's or write for complete HAWS catalog.

**HAWS DRINKING FAUCET CO.**

1441 FOURTH STREET (Since 1909) BERKELEY 10, CALIFORNIA  
Agents and Sales Representatives in All Principal Cities

**Structural Engineers Association of Southern California**

Ben Benicoff, President; William T. Wright, Vice-President; Charles M. Corbit, Jr., Sec-Treas. Directors: Ben Benicoff, William T. Wright, Harold P. King, Henry M. Layne, Joseph Sheffet, Robert J. Kadow and Harold Omsted. Offices, 121 S. Alvarado St., Los Angeles 4.

**Structural Engineers Association of Oregon**

Lewis R. Elingwood, President; Robert M. Bonney, Vice-President; Sully A. Ross, Secretary-Treasurer. Directors William J. Dörner, Roger V. Gillam, Leslie E. Poole, Rowland S. Rosé. Offices 706 Board of Trade Bldg., 310 S.W. 4th Ave., Portland 4.

**Society of American Military Puget Sound Engineering Council (Washington)**

R. E. Kister, A. I. E. E., Chairman; E. R. McMillan,

A. S. C. E., Vice Chairman; L. B. Cooper, A. S. M. E., Secretary; A. E. Nickerson, I. E. S., Treasurer. Offices L. B. Cooper, c/o University of Washington, Seattle 5, Washington.

**American Society Testing Materials Northern California District**

L. A. O'Leary, Chairman; P. V. Garin, Vice-chairman; H. P. Hoopes, Sec. Office Sec., 1550 Powell St., Emeryville, Calif.

**Society of American Military Engineers San Francisco Post**

CDR N. M. Martinsen, President; L. L. Wise, 1st Vice-President; Col. Paul Berrigan, 2nd Vice-President; R. M. Hamilton, Secretary; Thomas Hurley, Treasurer. Directors, RADM C. A. Trexel, J. G. Wright, LTCOL C. S. Lindsey, C. E. Bentley, F. R. Fowler, BRIGEN D. F. Johns, and RADM L. N. Moeller.

Rose, in addition to the above named officers.

Unusual pier construction by the Port of Portland for the new Swan Island dry docks and lateral tests of full scale lumber-sheathed diaphragms were the subject of recent meeting discussions.

**SOCIETY OF AMERICAN MILITARY ENGINEERS—SAN FRANCISCO POST**

"The Role of Research in the Development of Supersonic Aeroplanes" was the subject of a talk by Dr. Smith J. DeFrance, director of the Ames Aeronautical Laboratory, at the April meeting, held in the Presidio Officers Club, San Francisco.

Named at the annual election to serve as officers for the ensuing year were CRD N. M. Martinsen, President; L. L. Wise, Vice-President; Col. Paul Berrigan, 2nd Vice-President; R. M. Hamilton, Secretary; and Thomas Hurley, Treasurer.

**FEMINEERS**

The "Femineers", wives of members of the American Society of Civil Engineers, and Structural Engineers Association of Northern California, held a bridge and canasta card party at the Elks Club in San Francisco recently.

Mrs. August E. Waegemenn was in charge of reservations.

**STRUCTURAL ENGINEERS ASSOCIATION OF SOUTHERN CALIFORNIA**

"The Technical Aspects of Subsidence in the Harbor Area" was the subject of a talk by Robert Shoemaker and J. H. Davies at the April meeting. Shoemaker is chief harbor engineer, Long Beach Harbor Department and Davies a consulting engineer of Long Beach. Color motion pictures and lantern slides were shown to illustrate points of the discussion.

New members include Milton A. Abel, John D. B. Allison, Jr., Thomas Don Beason, Rupert C. Brittain, Kenneth S. Iwata, Coleman W. Jenkins, Charles F. Moran, and John E. Soehrens. Membership in the Chapter now stands at 405 members.

**ENGINEER LEAVES FOR EGYPT**

I. C. Steele, civil engineer, left San Francisco this month via air for Cairo, Egypt, where he will participate with a group of internationally famous engineers in a study of the possibility of constructing a dam across the Nile River above the present Aswan Dam.

Steele is a national director of the American Society of Civil Engineers, and former president of the San Francisco Section.

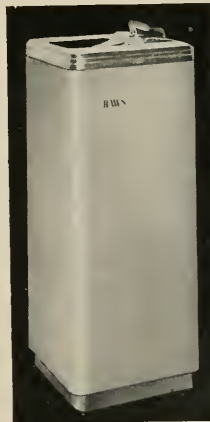

Always Specify **HAWS** for Highest Quality

A complete line of coolers, fountains, faucets, equipment, filters and accessories. A reputation for reliability since 1909. Check in Sweet's or write for complete HAWS catalog.

**HAWS DRINKING FAUCET CO.**

1441 FOURTH STREET (Since 1909) BERKELEY 10, CALIFORNIA  
Agents and Sales Representatives in All Principal Cities

# PRODUCER'S COUNCIL PAGE

The National Organization of Manufacturers of Quality Building Materials and Equipment  
(Northern California Chapter) affiliated with THE AMERICAN INSTITUTE OF ARCHITECTS

President, A. L. West, Jr.  
Aluminum Company of America  
621 Russ Bldg.

Vice-President, Howard W. Noleen  
E. F. Hauserman Company  
31 Geary Street

Secretary, Hillman Hudson  
Vermont Marble Company  
525 Market Street

Treasurer, Tait Smith  
Ceco Steel Products Corpn.  
401 Tunnel Avenue

Edited by Phil Brown, OTIS ELEVATOR COMPANY.

## BUSINESS MEETING:

On March 16, the Producers' Council held a business meeting at the request of President Al West.

For the past two years there has been considerable criticism about the size of the attendance at the annual Christmas Jinx.

Prior to 1952, it was the desire of the Producers' Council to increase the attendance at the Annual Jinx and spread the spirit of good fellowship to as many of the architects and their associates as possible. We were so successful at this, that we now find ourselves in the position where the attendance is so large that it is literally choking the activity to a point where it is losing its effectiveness as a well intended social function.

There has been little criticism of the type of material presented or in the dinner served and the locations.

It is purely a question of too many people.

This is the opinion of a large number of architects and, of course, this is shared with the members of the Producers' Council. From the Council's standpoint, the crowd is not only too large from a social standpoint, but our expenses associated with the cocktail hour have assumed tremendous proportions.

It was due to these conditions that could possibly eliminate or curtail the annual Christmas Jinx

that President Al West decided to call the business meeting.

There were only 33 members in attendance and after considerable debate a resolution carried to place the eventual fate of the Annual Christmas Jinx in the hands of the Executive Council.

If anyone that did not attend this business meeting has any views that he feels should be expressed to the Executive Council, they are urged to do so. Decisions of this nature affect the entire council and the Executive Organization feels that any decision on a matter such as this must be suitable to the entire organization.

The method of paying our dues also was discussed at this meeting and it was the unanimous consent of the group that we should continue to "pay as we go" and not pay a lump sum to cover the expenses for the entire year.

## PRODUCT DISPLAY:

The Producers' Council's Annual Table Top Product Display is scheduled for May 27th and will be held in the Fairmont Hotel. Mr. Tom Brewer, Beil & Gossett Company, is chairman of the committee handling the details. Tom asks that all the members begin giving consideration to the type of display they plan to present so that the last minute rush can be avoided.

USE QUALITY PRODUCTS



CONSULT AN ARCHITECT



## A.I.A. ACTIVITIES

(From page 29)

of Pre-Stressing of Concrete at the Anderson's plant near Tacoma.

Reports indicate that the architects exhibit at the College of Puget Sound was well received and plans are already underway for a similar exhibit next year.

## PASADENA CHAPTER

George E. Brandow, structural engineer of the firm of Brandow & Johnston, spoke at the April meeting on the subject of "Life-Slab Construction." He illustrated his comment with a motion picture and slides showing actual construction scenes.

Announcement was made that the First Federal Savings and Loan of Pasadena was sponsoring an advertising campaign urging the public to "employ the services of a Pasadena builder or architect."

Members were urged to note that the regular May meeting will be held the second Tuesday in May, rather than the first Tuesday.

## LOS ANGELES ARCHITECTURAL FIRM WINS SCHOOL AWARD

The architectural and engineering firm of Daniel, Mann, Johnson & Mendenhall were recently awarded "honorable mention" for excellent design of the Alice M. Birney Elementary School at Rivera, in a nation-wide contest sponsored by the School Executives magazine.

Presentation of the award was one of the features at the annual meeting of the National Association of School Administrators held recently in Atlantic City.

## PAINTING FIRM CELEBRATES 70th ANNIVERSARY

Executives and senior employees of the D. Zelinsky and Sons, pioneer painting and decorating contractors of San Francisco, celebrated the 70th anniversary of the founding of the firm at a recent Fairmont Hotel banquet.

David Zelinsky, founder of the company, and 32 employees who have been with the firm ten years or longer were honored guests. Gold wrist watches were presented to the employees, some of whom were flown from the Los Angeles office of the company to San Francisco for the occasion.

Receiving employee awards were: Fernando R. Afonso, Max Anixter, Anita Barker, Bruno Brautigam, Otto Briemele, Jr., Edward Dauer, J. Howard Devert, Louis F. Durbin, Charles Erickson, Charles H. Geiser, J. T. Grennan, Walter Haglund, Paul Harsh, H. A. Hawkins, William Jensvold, John J. McBriar, B. J. McCloskey, Earl Misner, Dorothy Whitley Mooney, John Mulder, George S. Nelson,

Wendall Reichmuth, William R. Rich, Herman Rist, Frank M. Tollner and A. C. Willbee.

Hosts of the occasion included Mr. and Mrs. Frederick G. Zelinsky, Mr. and Mrs. Edward G. Zelinsky, Mr. and Mrs. Robert D. Zelinsky, Mrs. Mervyn G. Zelinsky, Mrs. Milton Weingarten and Mrs. Herbert Zelinsky.

## WOMENS ARCHITECTURAL LEAGUE HEARS FASHION DIRECTOR

Miss Winifred Warring, noted fashion director of Robinson's Department Stores, spoke before the

### E. H. MOORE

*Announces the withdrawal of*

### JAMES E. ROBERTS

*From the firm of*

### MOORE & ROBERTS

*which firm on and after March 1, 1953*

*will be known as*

### E. H. MOORE & SONS

*General Contractors*

**693 MISSION STREET • SAN FRANCISCO**

## STOP WATER DAMAGE!



**FORM BOARDS**



**BRICK • CONCRETE**



**PAINTED SURFACES**

Specify

## Thompson's WATER SEAL

for

## Waterproof Protection of all porous materials

- It penetrates • Is transparent
- Leaves no film • Locks out moisture
- Lasts for years • Proved by performance.

Will cover 200-400 sq. ft. to gal. depending on porosity of material. Specified by architects and used by contractors all over the West. Has State of California approval.

Write or phone for proof of performance and specification material.



Manufacturer

## BY-CHEMICAL PRODUCTS CO.

1355 MARKET ST., SAN FRANCISCO • KING CITY • LOS ANGELES



# Summerbell for SCHOOLS

Elementary School, Santa Paula, California.  
Architect, R. S. Raymond.  
Structural Engineer, R. J. Valentine.  
General Contractors, Barringer & Botke.  
Note clerestory windows made possible  
by "sawtooth" design.

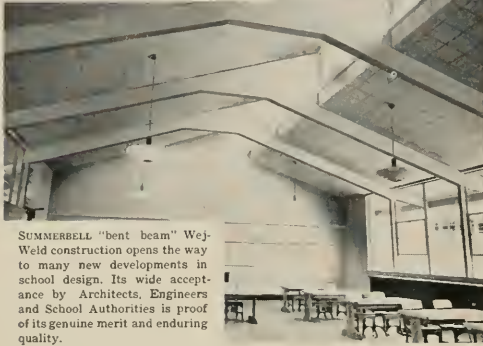

SUMMERBELL "bent beam" Wej-Weld construction opens the way to many new developments in school design. Its wide acceptance by Architects, Engineers and School Authorities is proof of its genuine merit and enduring quality.

Glued Laminated Construction • Summerbell Bowstring Trusses  
Lomello Roofs & All Types of Timber Structures

For quality, economy and satisfaction, specify **SUMMERBELL**

## Summerbell ROOF STRUCTURES

825 EAST 29TH STREET • BOX 218, STATION "K" • LOS ANGELES 11

Los Angeles Womens Architectural League recently on the subject of "Spring and Summer Fashions."

The meeting was held in the Assistance League tea room in Hollywood.

### E. H. MOORE FORMS OWN CONTRACTING FIRM

The general contracting firm of Moore & Roberts, Inc. has been dissolved and E. H. Moore announces



E. H. MOORE  
"Deck"

the original company will continue under the name of E. H. Moore & Sons.

Contracts of the former firm will be completed by the new organization which will remain at 693 Mission Street, San Francisco. All personnel of the former firm are also being retained in the Moore organization.

The Moore firm has been operating since March when they started taking new business. E. H. Moore and James E. Roberts began business during the depression days and have since completed more than \$100,000,000 in contracts of various

# BRONZE PRODUCTS by GREENBERG

Your best and nearest source for standard and special Bronze products



STABILITY since 1854

## M. GREENBERG'S SONS

765 Folsom St. • San Francisco • Calif. • EXbrook 2-3143

Manufacturers of Fire Hydrants and Fire Protection  
Brass Goods • Industrial, Navy and Maritime  
Bronze Valves and Fittings • Plumbing and  
Hardware Brass Specialties • Bronze Plaques,  
Letters and Name Plates

LOS ANGELES • SEATTLE • PORTLAND • SPOKANE • SALT LAKE CITY • DENVER • EL PASO • NEW YORK • HARTFORD • WASHINGTON, D. C.

ARCHITECT AND ENGINEER

types of construction, including work for the Army, Navy, and Housing Authorities in Pacific Coast states.

Bill Harr, associated with the firm previously, has been named chief estimator and general manager of the new firm.

### A.I.A. CONVENTION SECRETARY NAMED

Arthur B. Holmes, formerly executive director of the New Jersey Society and New Jersey Chapter of The American Institute of Architects, has been named A.I.A. Convention Secretary in charge of arrangements for the Seattle, Washington meeting, according to a recent announcement by Edmund R. Purves, Executive Director of the Institute.

### OREGON WOMENS ARCHITECTURAL LEAGUE PRESENTS TRAVELER

The Womens Architectural League of Oregon presented Dean Sydney W. Little at their regular April meeting.

He spoke on his recent European travels and augmented his remarks with the showing of an interesting group of three dimensional color slides.

### WOODWORK INSTITUTE OF CALIFORNIA ELECTS ROBERT HOGAN PRESIDENT

At the annual meeting of the Woodwork Institute of California, recently held in San Francisco, Robert Hogan of the Hogan Lumber Company, Oakland, was elected president of the Institute for 1953, succeeding Larry J. Woodson of San Francisco.



**ROBERT HOGAN**  
President

Reports of Institute activities during the year as submitted by Russell Bjorn, Manager-Director, indicated the organization had accomplished a number of outstanding objectives during the past year, highlight of which was the publication of a Manual of

Millwork containing standards of the industry as adopted by the Woodwork Institute members.

Cooperating in the compilation of the Manual were Sherman S. Karns, Chairman of the Committee and Chief Engineer of the Hollenbeck-Bush Planning Mill Co., Fresno; George E. Lefler, Chief Draftsman, Pacific Manufacturing Company, San Jose; A. M. Smith, Production Manager, Union Planing Mill Co., Stockton; and Erick A. Ahlborn, Chief Estimator, Sierra Mill and Lumber Co., Sacramento.

Other officers named to serve with Hogan included J. L. Pierce, 1st Vice-President, Pacific Manu-



LUIS PURSEL, A. I. A., ARCHITECT FREDERICK CONSTRUCTION CO., CONTRACTOR

### Fresh, colorful, fade-proof beauty of PORCELAIN ENAMEL VENEER

... provides any building a cleaner, more welcoming entrance. Other advantages include limitless flexibility in fabrication, firesafety, strength and durability.

★ Write, today, for details ...

*Architectural Division*  
**PORCELAIN ENAMEL PUBLICITY BUREAU (Dept. AE)**  
 P. O. BOX 102, EAST PASADENA STATION, PASADENA 8, CALIFORNIA  
 ROOM 511, FRANKLIN BUILDING, CARLAND 12, CALIFORNIA

**WITHOUT light WHAT WOULD nature BE?**

HERE IS BEAUTY . . .  
 Life, form, line, mass and color exist. Likewise to enhance your display areas or increase production light is vital . . .

SHOOT-HOLMAN standards have been highest and quality at its best. We are proud to announce our new recessed triffer series (M). Available about June 1 in 48" fluorescent with Rapid Start ballast. Standard lamp lengths 48", 72" and 96". Write for further technical information about this versatile unit.

**SHOOT-HOLMAN**  
 ILLUMINATION EQUIPMENT  
 BRANCH OFFICES AND  
 WAREHOUSES SAN FRANCISCO

G-148-24      D-148-24      L-148-24



**GOULD**

## SOLVES SCHOOL SPACE PROBLEM

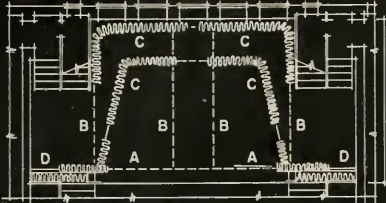

School stage and four classrooms  
**PROBLEM:** To get maximum use of space in small overcrowded school.

**SOLUTION:** a) Gould Monarch Stage Curtain Track across proscenium. b) Separators—Gould Brass Channel Track recessed in plaster ceiling. c) Double cyclorama of Gould's flexible Heavy-Duty Aluminum I-Beam, with drop-out pieces at the crossings. Entire cyclorama track removable, and curtains transferable to separator tracks. d) Gould 1200 Steel Channel Track at auditorium doors and all windows. **MORAL:** Gould drapery hardware is a design tool, saving expense, providing many helpful solutions to today's problems.

Sweet's File Arch. 19c GO Sweet's File Builder 4f GO

Write today for complete catalog; our advisory service invites consultation.



THE **GOULD MERSEREAU CO., INC.**

35 WEST 44th ST., NEW YORK 36, N. Y.



**SINCE 1903**  
 one of the  
*great names*  
 in the  
**Oil Burner Industry!**

... your best bet

when you're looking for low-cost  
**automatic HEAT!**

There's a Johnson Burner engineered to fit every heating job . . . whether it's for a 5-room house or a 50-story skyscraper, for a hotel, a hospital, a school or an industrial plant. No heating equipment you can buy will prove more dependable, more economical to operate or more faithful in its performance. Ask your heating engineer . . . he knows. There's a Johnson dealer near you.

... *Johnson Oil Burners* ...  
 S. T. JOHNSON CO.  
 940 Arlington Ave., Oakland 8, Calif.  
 Church Road, Bridgeport, Pennsylvania

facturing Co.; Rex Sporleder, 2nd Vice-President, and James Moore, Long Bell Lumber Company, Treasurer. Directors also include Ernie F. Atkinson, Clinton Mill & Manufacturing Co.; Arthur Bernhauer, Fresno Planing Mill; Stanley Gustafson, Sierra Mill & Lumber Co.; Hollis Jones, Western Door & Sash Co.; Jack Little, Union Planing Mill; Seth Potter, Stockton Box Company; Larue J. Woodson, and Tom Work, The Work Mill & Cabinet Co., Inc.

### JELICK NAMED DIRECTOR OF CONCRETE INSTITUTE

Jay E. Jellick, manager Portland Cement Information Bureau with general offices in San Francisco, was elected to a three-year term as a director of the American Concrete Institute at the Institute's recent Boston convention.

The organization also announced that officers for 1953 would include Henry L. Kennedy, manager, Cement Division, Dewey & Almy Chemical Co., Cambridge, Mass., a consulting engineer specializing in reinforced concrete design and construction.

### CONSTRUCTION INDUSTRY

(From page 9)  
**Schools Up**

**Pacific Coast**—Higher volume in all categories, with 80 per cent of the replies foreseeing an increase in highway activity and 60 per cent foretelling an increase in building work. Building, it was predicted, would decline in Alaska for the first half of the year.

There were some shifts in types of projects reported here and there in the country. However, nationally, the "heavies!" trends were: 18 per cent of the replies indicated a shift to commercial work; 15 per cent said school construction would go up over the comparable six months of last year, and 8 per cent reported that institutional work would increase.

**Rocky Mountain States**—Increase predicted in all categories with a rise in building construction more confidently expected than in highway or heavy. Building construction is expected to rise by 25 per cent in Wyoming with schools accounting for a good share of the building increase. Building will also be up in Colorado. School construction and public works to increase in Nevada.

#### New England Optimistic

The picture by area, with noteworthy features: **New England**—Replies were 100 per cent for gains in building, highway and heavy construction over the comparable six months of 1952. The A.G.C. of New Hampshire and Vermont predicted more than a 100 per cent increase in heavy construction and a 15 per cent increase in highway construction in its area. The Rhode Island chapter

said prospects in all three categories for the next six months were "excellent."

**Middle Atlantic**—Building and highway work to increase, heavy to decrease. The decline in heavy construction was predicted by 55 per cent of the replies. Sixty-nine per cent of the respondents looked for a greater volume of highway work.

Several of the replies noted a shift to commercial, institutional and school construction away from industrial. Competition was reported "terrific" in this area and one report said prices for completed projects "have not advanced and in most cases are lower than a year ago."

#### **Building to Increase in South**

**South**—Increases were predicted in all categories, with as high as 63 per cent of the replies for an increase in building construction. Here as elsewhere it should be borne in mind in evaluating the survey that the period of comparison was a time of record output for the construction industry.

West Virginia reported a building increase of 50 per cent ahead, with a shift to school construction. Industrial construction was expected to rise in Louisiana. Throughout the South, somewhat of a trend to commercial and industrial construction was foreseen.

**Midwest**—Greater volume of construction expected in all categories. A definite trend to commercial and school building with a lighter shift to public works, hospital and institutional work and a moderate decline in industrial.

**Southwest**—More building and highway work. Fifty per cent of the replies from this area predicted a decline in heavy work. A record volume of building construction was deemed possible in West Texas where in the field of heavy construction the emphasis was expected to be on public works. Somewhat of a trend to schools and commercial activity was reported from West Texas, Amarillo, Houston and Corpus Christi.

#### **Materials Relatively Stable**

A relatively stable price structure for materials was reported from all sections of the country, with some contractors declaring that various materials had declined or were expected to decline in price. Likewise, there were reports of increases in some items and the expectation of further increases. The Middlewest and Middle Atlantic areas appeared to have the most stable price structures with pressure for higher prices strongest in the Southwest.

Pressure for higher wage rates was reported by 83 per cent of those answering the survey. Seventeen per cent said wages were likely to remain stable while 7.5 per cent reported pressure for fringe benefits such as health and welfare insurance. There were strong indications that employers generally would make determined efforts "to hold the line" on demands for wage increases.

## **BARRETT & HILP** **CONTRACTORS**

*Serving The Construction Field  
Since 1912*

**OUR FORTIETH YEAR**

918 Harrison Street • San Francisco  
Telephone DOuglas 2-0700

## **CLASSIFIED ADVERTISING**

Do YOU want to hire, buy, sell, rent, find, lose, and otherwise transact business with others in the Construction Industry? If so, your best bet is a CLASSIFIED ad in ARCHITECT & ENGINEER magazine.

SELL that used equipment at a good price; secure competent employees; buy good used equipment; obtain information on wanted materials, etc.

Rates are low 20 cents per word—cash with order—minimum 3 lines. "Position Wanted" ads are half-rate. Forms close 20th of month preceding date of publication.

## **ARCHITECT & ENGINEER** **MAGAZINE**

68 Post Street

San Francisco

## **FORDERER CORNICE WORKS**

*Manufacturers of*

Hollow Metal Products • Interior Metal Trim  
Elevator Fronts and Cabs  
Metal Plaster Accessories • Sanitary Metal Base  
Flat and Roll Metal Screens  
Metal Cabinets • Commercial Refrigerators

**269 POTRERO AVE.**

**SAN FRANCISCO, CALIF.**

**HEMLOCK 1-4100**

## **Parker, Steffens & Pearce** **BUILDERS**

**135 South Park, San Francisco**

**Phone: EXbrook 2-6639**

# ALLIANCE ENGINEERS

C. L. WEEKS  
Civil Engineer No. 4943

**COST ENGINEERS  
QUANTITY SURVEYORS  
APPRAISERS**

★ Preliminary & Final Estimates ★

602 West Santa Barbara Avenue  
Los Angeles 37, California  
ADams 3-7138

# JUDSON PACIFIC-MURPHY CORP.

*Steel Fabricators  
and  
Erectors*

**REINFORCING STEEL  
STRUCTURAL STEEL  
BRIDGE CRANES**

4300 EASTSHORE HWY.  
EMERYVILLE, CALIF.

Phone:  
OL 3-1717

# CLINTON CONSTRUCTION CO. OF CALIFORNIA

**General Contractors**

923 FOLSOM STREET • SAN FRANCISCO

SUtter 1-3440

# HOGAN LUMBER CO.

*Wholesale and Retail*

**LUMBER**

**MILL WORK • SASH & DOORS**

*Office, Mill, Yard and Docks*  
SECOND AND ALICE STREETS • OAKLAND, CALIF.

Telephone GLencourt 1-6861

# BOOK REVIEWS PAMPHLETS AND CATALOGUES

**SCHOOL BUILDINGS—1945-1951.** By Bruce Martin, A.A.Dip.-(Hons), A.R.I.B.A., Crosby Lockwood & Son, Ltd., 39 Thurloe St., South Kensington, London, S.W.7. Price \$25/-

Contains a Foreword by S. A. W. Johnson-Marshall, B.A.R.C.H. (Liverpool), Chief Architect for the Ministry of Education. The book deals with the postwar years problem of school building and the question of replacing destroyed, damaged and obsolescent buildings and the problem of increased school populations and changing educational methods.

The book includes a large number of plans and photographs taken during construction and completion of schools. Included are schools in England, United States, Scotland, Switzerland, Sweden, and Holland.

**FATHER OF AIR CONDITIONING—Willis Haviland Carrier.** By Margaret Ingels. Country Life Press, Garden City, N. Y. Price \$2.50.

Depicts the life of the late Dr. Willis H. Carrier, tells of the company he founded (Carrier Corpn.), and describes the industry he pioneered.

Written in non-technical terms, the book covers the period 1500 to 1952 in a comprehensive chronological table, and tells of the boyhood of Dr. Carrier, his education, start in business, and early trials and tribulations in the then infant air conditioning industry.

Also included is an appendix listing books and articles by Dr. Carrier. 170 Pages.

**PLASTERING SKILL AND PRACTICE.** By Van Den Branden and Knowles. American Technical Society, 848 E. 58th St., Chicago, Ill. Price \$4.90.

The authors Felicien Van Den Branden, plastering instructor at the Building Trades Apprentice School, Detroit, Michigan; and Mark Knowles, Head Plastering Instructor of the same school, present a modern guide to an ancient trade in this book.

It is written to initiate the novice and to up-date the journeyman in the techniques, both new and old, in the plastering trade, and methods to meet varying problems are those which have earned recognition as the best by virtue of two tests: 1) economy of time spent in labor, and 2) quality of the results. Likewise, trade terms vary among different sections of the country, but the basic practices are everywhere the same.

Many photographs and illustrations are included to clarify written text with step-by-step procedures described. Such post-war innovations as the plastering of structural steel members and the versatile, eye-plastering acoustic plasters, are included by the authors.

## NEW CATALOGUES AVAILABLE

*Architects, Engineers, Contractors, Planning Commission members—the catalogues, folders, new building products material, etc., described below may be obtained by directing your request to the name and address given in each item. Mention you read the item in ARCHITECT & ENGINEER magazine—we will appreciate it.*

**Aluminum Hardware Brochure.** An attractive brochure describing the new Yale line of anodized aluminum hardware for schools, hospitals, and other institutional and commercial use has been published by The Yale & Towne Manufacturing Company. Pictured in the brochure are samples and specifications of the Yale aluminum hardware line, including locksets, auxiliary mortise locks, door pulls, door stops, door holders, sash fasteners, pushplates, flushbolts, and letter hole trim. For copies of the brochure write to: Advertising Department, Yale Lock and Hardware Division, The Yale & Towne Manufacturing Company, Stamford, Conn.

**Fiberglass Sound Control.** Two new booklets on Fiberglass sound control products have been published by the Owens-Corning Fiberglass Corporation, Toledo, Ohio, and now are available upon request. Each has 12 pages of information about the various acoustical and sound control products manufactured by the firm. One contains numerous pictures showing the use of Fiberglass in offices, retail businesses, hospitals, school and industrial plants. The other includes technical data concerning noise reduction coefficients, application details and



specifications for textured, perforated and Sonofaced acoustical tile, ceiling board, Noise-Stop baffles, Aerocar, preformed insulation and insulating wool. Copies of the new booklets may be obtained by writing Owens-Corning Fiberglas Corporation, Toledo 1, Ohio.

**New Architects Catalogue on STANLEY Automatic Door Controls.** gives complete details on the application of both Magic Carpet and Magic Eye type of door controls for use in markets, restaurants, stores and industrial operations, including operators for swinging, sliding, bi-folding and bi-parting doors. Contains many drawings and photographs of actual installations. A.I.A. File No. 16-D. Available, The Stanley Works, New Britain, Conn.; or Modern Building Specialties Co., 655 Folsom St., San Francisco (Exclusive Agents for Northern California).

**Steel Structural Sections. Catalog No. SS-1.** A new development making possible low cost steel framework for smaller buildings, residences, stores, schools, factories and warehouses. New catalog contains many illustrations of light-steel frameworks actually erected for industrial and residential buildings; illustrations of single and double studs, joints, track and bridging. Gives complete framing details for assembly and welding, also details for doors, windows, roofs and clear spans. Tables of physical and structural properties, loading tables, full specifications and other technical data. A.I.A. File No. 13-G. Available, Penn Metal Co., Inc., 205 E. 42nd St., New York 17.

**Plumbing Fixture Protection.** Describes plumbing fixture protection during building construction so that they will reach the consumer in perfect condition; Pamphlet has been prepared by the Enameled Cast Iron Plumbing Fixture Association and the Vitreous China Plumbing Fixtures Association as part of an extensive educational program. Manufacturers of plumbing fixtures are seeking the cooperation of all crafts to protect fixtures, diminish damage during the dwelling construction, and reduce annoyance and misunderstanding so that the owner may take justifiable pride in the flawless condition of these most useful fixtures. Illustrations show the proper way to protect fixtures during construction. A.I.A. File No. 29-H. Available, Enameled Cast Iron Plumbing Fixtures Ass'n., 1709 M St., N. W., Washington 6, D. C.

**Swimming Pool Painting.** A new chlorinated rubber paint has been developed as a solution to swimming pool painting problems. Results of a recent survey shows the new product "Ramuc" provides a smooth tile-like coat to the submerged surface of the pool; overcomes aggressive chemical action, and stands up under submersion and atmospheric changes. Describes color preference in use by hotels, country clubs, municipalities, and private pool owners, such as sea green, sky blue, turquoise blue, light blue and white. Complete details about "Ramuc" and inertial swimming pool service program are available at no cost by writing the Inertol Co., Inc., 485 Frelinghuysen Ave., Newark 5, New Jersey—or Inertol Co., Inc., 25 South Park St., San Francisco.

**Air Cooled Heat Exchangers.** A new 12-page, illustrated bulletin on air-cooled heat exchangers for a wide variety of industrial cooling and condensing applications. The new units, known as "Fin-Fan" heat exchangers, are of the forced draft type and are designed to cool liquids or gases at pressures up to 5,000 PSI and temperatures as high as 1,500 degrees F. These air-cooled units are being installed to replace or augment water cooled heat exchangers in many plants faced with the necessity of dissipating great heat loads from everyday processes. Available, Fluor Corp'n., 2500 S. Atlantic Blvd., Los Angeles 22.

**Engineered Timbers.** A new booklet entitled "Modern Construction with Engineered Timbers" has been published as a guide and source of authoritative information on this subject; consists of 12-pages printed in color showing how timber is used in conjunction with other suitable materials as a modern engineering material with known structural values. Glued lamination of beams, arches and trusses. Technical data includes sizes and properties of glued laminated beams; typical purlin sizes; standard thicknesses of laminations and limiting curvatures; arch section dimensions for various roof slopes, spans and loadings; dimensions, sizes and weights of bowstring and parallel chord trusses. A.I.A. File No. 19-B-3. Available, Timber Structures, Inc., P. O. Box 3782, Portland 8, Oregon.

**Schoolroom Lighting.** A new 9-page illustrated pamphlet entitled "Why Chalkboard Lighting in Schoolrooms", dealing with the problems of chalkboard lighting in schools has been written by Leonard V. James, noted illuminating engineering consultant, and for many years chairman of the American Standards Association Committee on standard practice for school lighting. The booklet thoroughly discusses every factor having to do with proper lighting in schools, including the effect of glare to the eyes, the light distribution over the chalkboard, the tasks of the chalkboard, and numerous others. Despite tremendous improvements made in school lighting in recent years the average classroom still has insufficient light at the chalkboard. Available, Solar Light Mfg. Co., 1357 So. Jefferson St., Chicago 7, Ill.

## PACIFIC MANUFACTURING CO.

High Class Interior Finish Quality Millwork

16 Beale St., San Francisco  
Garfield 1-7755  
2215 El Camino Real, San Mateo  
S. M. 5-0687  
304 Bryant Street, Palo Alto  
P. A. 3373  
2610 The Alameda, Santa Clara  
S. C. 607 (Factory)  
6820 McKinley Avenue, Los Angeles  
THarnall 4196  
MAIN OFFICE — SANTA CLARA

## "AMERICAN - MARSH" CONDENSATION UNIT

Pumping  
Machinery  
for  
Every  
Purpose

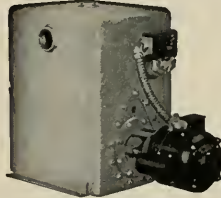

For Service  
Call  
DOuglas  
2-6794  
or  
MUtual 8322

SIMONDS MACHINERY CO.  
SAN FRANCISCO 816 FOLSOM      LOS ANGELES 455 EAST 4TH

## VERMONT MARBLE COMPANY

DOMESTIC AND IMPORTED MARBLES  
GRANITE VENEER

525 MARKET STREET • SAN FRANCISCO 5  
Phone: SUtter 1-6747  
3522 COUNCIL STREET • LOS ANGELES 4  
Phone: DUmkirk 2-7834

The Most Complete Line of  
STEELS and STEEL BUILDING MATERIALS  
Made by a Single Producer



See Sweet's Catalog File or write us for full information.

REPUBLIC STEEL CORPORATION

GENERAL OFFICES: CLEVELAND, OHIO

DENVER, COLORADO . . . . . CONTINENTAL OIL BUILDING  
LOS ANGELES, CALIF. . . . . GENERAL PETROLEUM BUILDING  
SAN FRANCISCO, CALIFORNIA . . . . . RIALTO BUILDING  
SEATTLE, WASH. . . . . WHITE-HENRY-STUART BUILDING

## GROWTH SCHOOL

(From page 17)

to ten-year period required to complete it, will actually save the district money. There is a net saving of above five percent in interest, providing the entire school was built at once and money borrowed. There is a saving of depreciation obsolescence by building the rooms just as they are needed.

Another factor favoring the growth school is the widespread adoption of the single-story school idea with its lower cost and lighter construction. One-story frame buildings lend themselves to this type of design and inexpensive expansion and additions such as practiced in these buildings.

## NEWS & COMMENT ON ART

(From page 6)

from the paintings submitted for the 1953 James D. Phelan Awards are on display at the M. H. de-Young Memorial Museum in Golden Gate Park in San Francisco.

"Sunset Beach" by Rexford Brandt of Corona Del Mar was awarded the \$500 first prize; "Elements of Meaning" by Leonard Edmondson of Pasadena, \$400 second prize; and the third prize of \$300 was divided between "804" by Robert Irwin of Los Angeles, and "San Francisco" by Hubert Buel of

Mill Valley. "Clouds, Kids and Kites" by Joan Irving was awarded first honorable mention, and "Atop Telegraph Hill" by Betty Suzanne Brun, was given second honorable mention.

The James D. Phelan Awards in Literature and Art was created by the estate of the late San Francisco Mayor and California Senator.

## M. H. deYOUNG MEMORIAL MUSEUM

The M. H. deYoung Memorial Museum, Golden Gate Park, San Francisco, under the direction of Walter Heil, offers the following exhibitions and events during April:

EXHIBITIONS—Early American Silver, from the Mark Bortman Collection; a Retrospective Exhibition of Paintings and Drawings by Henry Koerner; Sculpture by Beatrice Stone; Four American Painters; and the 1953 Honor Awards of The American Institute of Architects, an exhibition of the outstanding works of Bay Area Architects since 1933.

SPECIAL EVENTS—include Classes in Art Enjoyment for Adults, Painting Workshop, and for the children classes in the Elements of Art, Form in Art and Nature, and Picture Making.

The Museum also offers Permanent Exhibitions and Gallery Tours.

## WINNER OF ABRAHAM ROSENBERG TRAVELING SCHOLARSHIP NAMED

Jack Jefferson, student of the California School of Fine Arts, San Francisco, has been awarded the 1953 Abraham Rosenberg Traveling Fellowship, according to an announcement by Francis V. Keesling, Jr., president of the San Francisco Art Association.

Jefferson has exhibited paintings at the California Palace of the Legion of Honor, at the Henry Gallery in Seattle, and at the University of Iowa.

His winning project included a design for six large mural paintings based on themes derived from study in the Bay Area.

## SAN FRANCISCO MUSEUM OF ART TELEVISION SERIES

The television programs produced by the San Francisco Museum of Art entitled "Art In Your Life," and which are broadcast every other Sunday morning at 10:45 over Station KRON, Channel 4, San Francisco, will highlight the following subjects during coming programs:

"This Is Jazz," Sunday, May 3rd—jazz is a form of modern musical expression that is not fully comprehended and this program will seek to clarify jazz expression through a discussion and demonstration with jazz musicians.

"Life' Takes A Picture Story"—a new kind of

(See page 45)

## VALUABLE NEWS SERVICE

- BUILDING MATERIAL DEALERS
- CONTRACTORS
- SUB-CONTRACTORS
- MANUFACTURERS AND REPRESENTATIVES

**ARCHITECTS REPORTS** gives advance news on construction projects in Northern California, lists: name of projects, location, architect, proposed cost and other pertinent information.

**HANDY** individual slip-reports, issued daily at a total cost of only

\$10 a month

## ARCHITECT'S REPORTS

Published Daily

The ARCHITECT and ENGINEER, Inc.

68 Post Street, San Francisco - DO 2-8311

# ESTIMATOR'S GUIDE

## BUILDING AND CONSTRUCTION MATERIALS

PRICES GIVEN ARE FIGURING PRICES AND ARE MADE UP FROM AVERAGE QUOTATIONS FURNISHED BY MATERIAL HOUSES TO SAN FRANCISCO CONTRACTORS. 3% SALES TAX ON ALL MATERIALS BUT NOT LABOR

All prices and wages quoted are for San Francisco and the Bay District. There may be slight fluctuation of prices in the interior and southern part of the state. Freight charge, at least, must be added in figuring country work.

**BONDS**—Performance or Performance plus Labor and Material Bond(s), \$10 per \$1000 on contract price. Labor & Material Bond(s) only, \$5.00 per \$1000 on contract price.

**BRICKWORK—MASONRY**

Common Brick—Per 1 M laid—\$150.00 up (according to class of work).  
Face Brick—Per 1 M laid—\$200.00 and up (according to class of work).  
Brick Steps—\$3.00 and up.  
Common Brick Veneer on Frame Bldgs.—Approx. \$1.20 and up (according to class of work).  
Face Brick Veneer on Frame Bldgs.—Approx. \$2.00 and up (according to class of work).  
Common Brick—\$36.00 per M truckload lots, delivered.  
Face Brick—\$81.00 to \$106.00 per M, truckload lots, delivered.

**Glazed Structural Units—Walls Erected**  
Clear Glazed—  
2 x 6 x 12 Furring.....\$2.00 per sq. ft.  
4 x 6 x 12 Partition.....2.25 per sq. ft.  
4 x 6 x 12 Double Faced  
Partition.....3.00 per sq. ft.  
For colored glaze add .30 per sq. ft.  
Mantel Fire Brick \$150.00 per M—F.O.B. Pittsburgh.

Fire Brick—Per M—\$111.00 to \$147.00.  
Carriage—Approx. \$10.00 per M.  
Paving—\$75.00.

**Building Tile**—  
8x5 1/2x12-inches, per M.....\$139.50  
6x5 1/2x12-inches, per M.....105.00  
4x5 1/2x12-inches, per M.....84.00

**Hollow Tile**—  
12x12x2-inches, per M.....\$146.75  
12x12x3-inches, per M.....156.85  
12x12x4-inches, per M.....177.10  
12x12x6-inches, per M.....235.30  
F.O.B. Plant

**BUILDING PAPER & FELTS**

1 ply per 1000 ft. roll.....\$5.30  
2 ply per 1000 ft. roll.....7.80  
3 ply per 1000 ft. roll.....9.70  
Brownin, Standard 500 ft. roll.....6.85  
Sisal/krait, reinforced, 500 ft. roll.....8.50

**Sheathing Papers**—  
Asphalt sheathing, 15-lb. roll.....\$2.70  
30-lb. roll.....3.70  
Dampcourse, 216-ft. roll.....2.95  
Blue Plasterboard, 60-lb. roll.....5.10

**Felt Papers**—  
Deadening felt, 3/4-lb., 50-ft. roll.....\$4.30  
Deadening felt, 1-lb.....5.05  
Asphalt roofing, 15-lb.....2.70  
Asphalt roofing, 30-lb.....3.70

**Roofing Papers**—  
Standard Grade, 108-ft. roll, Light.....\$2.50  
Smooth Surface, Medium.....2.90  
Heavy.....3.40  
M. S. Extra Heavy.....3.95

**BUILDING HARDWARE**

Sesh cord com. No. 7.....\$2.65 per 100 ft.  
Sesh cord com. No. 8.....3.00 per 100 ft.  
Sesh cord spot No. 7.....3.65 per 100 ft.  
Sesh cord spot No. 8.....3.35 per 100 ft.  
Sesh weights, cast iron, \$100.00 ton.....  
1-Ton lots, per 100 lbs.....\$3.75  
Less than 1-ton lots, per 100 lbs.....4.75  
Nails, per keg, base.....\$12.55  
8-in. spikes.....12.45  
Rim Knob lock sets.....\$1.80  
Butts, dull brass plated on steel, 3/32x3/2......76

**CONCRETE AGGREGATES**

The following prices net to Contractors unless otherwise shown. Carload lots only.

	Bunker per ton	Del'd per ton
Gravel, all sizes.....	\$2.44	\$2.90
Top Sand.....	2.38	3.13
Concrete Mix.....	2.38	3.06
Crushed Rock, 1/4" to 3/4".....	2.38	2.90
Crushed Rock, 3/4" to 1 1/2".....	2.38	2.90
Roofing Gravel.....	2.81	2.90
River Sand.....	2.50	3.00
<b>Sand</b> —		
Lapis (Nos. 2 & 4).....	3.56	3.94
Olympia (Nos. 1 & 2).....	3.56	3.88

**Cement**—  
Common (all brands, paper sacks),  
Per Sack, small quantity (paper).....\$1.05  
Carload lots, in bulk, per bbl.).....3.85  
Cash discount on carload lots, 10c a bbl., 10th prox., less that carload lots, \$4.00 per bbl. f.o.b. warehouse or delivered.  
Cash discount 2% on L.C.L.

Trinity White.....{ 1 to 100 sacks, \$3.50 sack  
warehouse or del.; \$9.56  
Medusa White.....{ bbl. carload lots.

**CONCRETE READY-MIX**

Delivered in 4-yd. loads:  
Per cubic yard, 1-8 Mix.....\$ 9.80  
1-7 Mix.....10.15  
1-6 Mix.....10.70  
1-5 Mix.....11.40  
Curing Compound, clear, drums,  
per gal.....1.03

**CONCRETE BLOCKS**

	Hay-dite	Bas-salt
4x8x16-inches, each.....	\$.19	\$.19
6x8x16-inches, each.....	.23	.235
8x8x16-inches, each.....	.27	.27
12x8x16-inches, each.....	.38	.40
12x8x24-inches, each.....	.....	.60
<b>Haydite Aggregates</b> —		
3/4-inch to 3/8-inch, per cu. yd.....	\$7.75	
3/8-inch to 1/2-inch, per cu. yd.....	7.75	
No. 6 to 0-inch, per cu. yd.....	7.75	

**DAMP-PROOFING and Waterproofing**

Two-coat work, \$9.00 per square.  
Membrane waterproofing—4 layers of saturated felt, \$10.00 per square.  
Hot coating work, \$5.00 per square.  
Medusa Waterproofing, \$3.50 per lb. San Francisco Warehouse.  
Trisolac concrete waterproofing, 60c a cubic yd. and up.

**ELECTRIC WIRING**—\$15 to \$20 per outlet for conduit work (including switches).  
Knob and tube average \$6.00 per outlet.

**ELEVATORS**

Prices vary according to capacity, speed and type. Consult elevator companies. Average cost of installing a slow speed automatic passenger elevator in small four story apartment building, including entrance doors, about \$9,500.00.

**EXCAVATION**

Sand, \$1.00; clay or shale, \$1.50 per yard. Trucks, \$30 to \$45 per day.  
Above figures are an average without water. Steam shovel work in large quantities, less; hard material, such as rock, will run considerably more.

**FIRE ESCAPES**

Ten-foot galvanized iron balcony, with stairs, \$250 installed on new buildings; \$300 on old buildings.

**FLOORS**

Asphalt Tile, 1/8 in. gauge 18c to 35c per sq. ft.  
Composition Floors, such as Magnesite, 40c-\$1.25 per sq. ft.  
Linoleum, standard gauge, sq. yd....\$2.75  
Mastipave—\$1.50 per sq. yd.  
Battleship Linoleum—1/8"—\$3.00 sq. yd.  
Terrazo Floors—\$2.00 per sq. ft.  
Terrazo Steps—\$2.50 per lin. ft.  
Mastic Wear Coat—according to type—20c to 35c.

**Hardwood Flooring**

**Oak Flooring—T & G—Unfin.**

	Prime	Standard
Clear Qtd., White.....	\$3x2/4 1/2x2 3/8x2 5/8x2	\$405 \$
Clear Qtd., Red.....	405	380
Select Qtd., Red or White.....	355	340
Clear Pin., Red or White.....	355	340
Select Pin., Red or White.....	340	325
#1 Common, Red or White.....	315	310
#2 Common, Red or White.....	305	280

**Refinished Oak Flooring**

1/2 x 2.....	\$369.00	\$359.00
1/2 x 2 1/2.....	380.00	370.00
1/2 x 2 1/4.....	390.00	381.00
1/2 x 2 1/2.....	375.00	355.00
1/2 x 3/4.....	395.00	375.00
1/2 x 2/4 & 3/4 Ranch Plank.....		415.00

**Unfinished Maple Flooring**

1/2 x 2 1/4 First Grade.....	\$390.00
1/2 x 2 1/4 2nd Grade.....	365.00
1/2 x 2 1/4 2nd & Btr. Grade.....	375.00
1/2 x 2 1/4 3rd Grade.....	240.00
1/2 x 3/4 3rd & Btr. Jtd. EM.....	380.00
1/2 x 3/2 2nd & Btr. Jtd. EM.....	390.00
33/32 x 2 1/4 First Grade.....	400.00
33/32 x 2 1/4 2nd Grade.....	360.00
33/32 x 2 1/4 3rd Grade.....	320.00
Floor Layer Wage \$2.60 hr.	

**GLASS**

Single Strength Window Glass.....\$.30 per sq. ft.  
Double Strength Window Glass......45 per sq. ft.  
Plate Glass, 1/4 polished to 75.....1.60 per sq. ft.  
75 to 100.....1.74 per sq. ft.  
1/4 in. Polished Wire Plate Glass.....2.90 per sq. ft.  
1/4 in. Rgh. Wire Glass......80 per sq. ft.  
1/8 in. Obscure Glass......44 per sq. ft.  
1/8 in. Obscure Glass......63 per sq. ft.  
1/8 in. Heat Absorbing Obscure......54 per sq. ft.  
1/8 in. Heat Absorbing Wire......72 per sq. ft.  
3/8 in. Ribbed......44 per sq. ft.  
3/8 in. Ribbed......63 per sq. ft.  
1/2 in. Rough......44 per sq. ft.  
1/2 in. Rough......63 per sq. ft.  
Glazing of above additional \$.15 to \$1.00 per sq. ft.  
Glass Blocks, set in place.....3.50 per sq. ft.

**HEATING**

**Furnaces—Gas Fired**  
Floor Furnace, 25,000 BTU.....\$ 70.50  
35,000 BTU.....77.00  
45,000 BTU.....80.50  
Automatic Control, Add.....39.00  
Dual Wall Furnace, 25,000 BTU.....91.50  
35,000 BTU.....99.00  
45,000 BTU.....117.00  
With Automatic Control, Add.....39.00  
Unit Heaters, 50,000 BTU.....202.00  
Gravity Furnace, 45,000 BTU.....198.00  
Forced Air Furnace, 75,000 BTU.....313.50  
**Water Heaters—5-year guarantee**  
With Thermostat Control,  
20 gal. capacity.....87.50  
30 gal. capacity.....103.95  
40 gal. capacity.....120.00



**INSULATION AND WALLBOARD—**

Rockwool Insulation—	
(2") Less than 1 000 sq. ft.	\$64.00
(2") Over 1,000 sq. ft.	59.00
Cotton Insulation—Full-thickness	
(3%)	\$95.50 per M sq. ft.
Sisolation Aluminum Insulation—Aluminum coated on both sides.	\$23.50 per M sq. ft.
Tileboard—4'x6' panel	\$9.00 per panel
Wallboard—1/2" thickness	\$55.00 per M sq. ft.
Finished Plank	69.00 per M sq. ft.
Ceiling Tileboard	69.00 per M sq. ft.

**IRON**—Cost of ornamental iron, cast iron, etc., depends on designs.

**LUMBER—**

545 No. 2 and better common	
O.P. or D.F., per M. f.b.m.	\$100.00
Rough, No. 2 common O.P. or D.F., per M. f.b.m.	95.00

**Flooring—**

	Per M Delvd.
V.G.-D.F. B & Bfr. 1 x 4 T & G Flooring	\$225.00
"C" and better—all	225.00
"D" and better—all	225.00
Rwd. Rustic—"A" grade, medium dry, 8 to 24 ft.	185.00

Plywood, per M sq. ft.	
1/4-inch, 4,088,0515	\$136.00
1/2-inch, 4,088,0515	219.00
3/4-inch, per M sq. ft.	292.00
Plyscord	11 1/2c per ft.
Plyform	25c per ft.

**Shingles** (Rwd. not available)—  
Red Cedar No. 1—\$9.50 per square; No. 2, \$7.00; No. 3, \$5.00.

Average cost to lay shingles, \$6.00 per square.  
Cedar Shakes—1/2" x 24/26 in handsplit tapered or split resawn, per square \$15.25  
3/4" to 1 1/4" x 24/26 in split resawn, per square 17.00

Average cost to lay shakes, \$8.00 per square.  
**Pressure Treated Lumber—**  
Wormalized. Add \$35 per M to above  
Cresoted. Add \$45 per M to above

**MARBLE—**(See Dealers)

**METAL LATH EXPANDED—**

Standard Diamond, 3.40, Copper	
Bearing, LCL, per 100 sq. yds.	\$43.50
Standard Ribbed, ditto	\$47.50

**MILLWORK—**Standard.

D. F. \$150 per 1000, R. W. Rustic \$175 per 1000 (delivered).

Double hung box window frames, average with trim, \$12.50 and up, each.

Complete door unit \$15 to \$25.

Screen doors, \$5.00 to \$12.00 each.

Patent screen windows, \$1.25 a sq. ft.

Cases for kitchen pantries seven ft. high, per lineal ft., upper \$9.00 to \$11.00; lower \$12.00 to \$13.00.

Dining room cases, \$20 per lineal foot. Rough and finish about \$1.00 per sq. ft.

Labor—Rough carpentry, warehouse heavy framing (average), \$75.00 per M.

For smaller work average, \$85.00 to \$100 per 1000.

**PAINTING—**

Two-coat work	per yard	85c
Three-coat work	per yard	\$1.10
Cold water painting	per yard	25c
Whitewashing	per yard	15c

<b>Linseed Oil, Strictly Pure</b> (Basis 7 1/2 lbs per gal)	
Light iron drums	per gal. \$2.29
5-gallon cans	per gal. 2.40
1-gallon cans	each 2.52
Quart cans	each 2.71
Pint cans	each 3.11
1/2 pint cans	each 3.24

<b>Turpentine</b> (Basis 7 1/2 lbs. per gal.)	
Light iron drums	per gal. \$1.66
5-gal. cans	per gal. 1.74
1-gallon cans	each 1.88
Quart cans	each 2.14
Pint cans	each 2.33
1/2 pint cans	each 2.51

**Pioneer White Lead in Oil Heavy Paste and All-Purpose (Soft-Paste)**

Net Weight	Per 100	Pr. per	Price to Painters
Packages	lbs.	pkg.	lbs.
100-lb. kegs	\$28.35	\$29.35	\$27.50
50-lb. kegs	30.05	15.03	28.15
25-lb. kegs	30.35	7.50	28.45
5-lb. cans*	33.35	1.34	31.25
1-lb. cans*	36.00	.36	33.75
500 lbs., (one delivery)	3/4c per pound less than above.		

\*Heavy Paste only.  
**Pioneer Dry White Lead—Litharge—Dry Red Lead Red Lead in Oil**

	Price to Painters—Price Per 100 Pounds
	100 50 25
	lbs. lbs. lbs.
Dry White Lead	\$26.30
Litharge	25.95 26.60 26.90
Dry Red Lead	27.20 27.85 28.15
Red Lead in Oil	30.65 31.30 31.60
	5 lb. cans, \$3.77 per lb.

**PATENT CHIMNEYS—**

6-inch	\$2.50 lineal foot
8-inch	3.00 lineal foot
10-inch	4.00 lineal foot
12-inch	5.00 lineal foot

**PLASTER—**

Neat wall, per ton delivered in S. F. in paper bags, \$17.60.

**PLASTERING (Interior)—**

3 Coats, metal lath and plaster	Yard \$3.00
Keene cement on metal lath	3.50
Ceilings with 3/4 hot roll channels metal lath (lathed only)	3.00
Ceilings with 3/4 hot roll channels metal lath plastered	4.50
Single partition 3/4 channel lath 1 side (lath only)	3.00
Single partition 3/4 channel lath 2 inches thick plastered	8.00
4-inch double partition 3/4 channel lath 2 sides (lath only)	5.75
4-inch double partition 3/4 channel lath 2 sides plastered	8.75
Thermax single partition: 1" channels; 2 1/4" overall partition width. Plastered both sides	7.50
Thermax double partition: 1" channels; 4 1/4" overall partition width. Plastered both sides	11.00
3 Coats over 1" Thermax nailed to one side wood studs or joists	4.50
3 Coats over 1" Thermax suspended to one side wood studs with spring sound insulation clip	5.00
Note—Channel lath controlled by limitation orders.	

**PLASTERING (Exterior)—**

2 coats cement finish, brick or concrete wall	Yard \$2.50
3 coats cement finish, No. 18 gauge wire mesh	3.50
Lime—\$4.00 per bbl. at yard.	
Processed Lime—\$4.15 per bbl. at yard.	
Rock or Grip Lath—3/8"—30c per sq. yd.	
1/2"—29c per sq. yd.	
Composition Stucco—\$4.00 sq. yd. (applied).	

**PLUMBING—**

From \$200.00 per fixture up, according to grade, quality and runs.

**ROOFING—**

'Standard' tar and gravel, 4 ply	\$13.00
per sq. for 30 sqs. or over.	
Less than 30 sqs.	\$16.00 per sq.
Tile \$40.00 to \$50.00 per square.	
No. 1 Redwood Shingles in place, 4 1/2 in exposure, per square	\$18.25
5/2 No. 1 Cedar Shingles, 5 in. exposure, per square	14.50
5/8 x 16"—No. 1 Little Giant Cedar Shing as 5" exposure, per square	18.25
4/2 No. 1 24" Royal Cedar Shingles 7 1/2" exposure, per square	23.00
Roofing with Gravel \$5.50 per sq.	

Asbestos Shingles, \$27 to \$35 per sq. laid, 1/2 to 3/4 x 25" Resawn Cedar Shakes, 10" Exposure	\$30.00
3/4 to 1 1/4 x 25" Resawn Cedar Shakes, 10" Exposure	\$35.00
1 x 25" Resawn Cedar Shakes, 10" Exposure	\$22.00

**SEWER PIPE—**

C.I. 6-in. to 24-in. B. & S. Class B and heavier, per top	\$99.50
Vitrified, per foot: L.C.L. F.O.B. Warehouse, San Francisco.	
Standard, 8-in.	\$.66
Standard, 12 in.	1.30
Standard, 24 in.	5.41
Clay Drain Pipe, per 1,000 L.F. L.C.L. F.O.B. Warehouse, San Francisco:	
Standard, 6-in. per M.	\$240.00
Standard, 8-in. per M.	400.00

**SHEET METAL—**

Windows—Metal, \$2.50 a sq. ft. Fire doors (average), including hardware \$2.80 per sq. ft., size 12'x12'. \$3.75 per sq. ft., size 3'x6'.

**SKYLIGHTS—**(not glazed)

Galvanized iron, per sq. ft.	\$1.25
Vented hip skylights, per sq. ft.	2.25
Aluminum, puttyless, (unglazed), per sq. ft.	1.25
(installed and glazed), per sq. ft.	1.85

**STEEL—STRUCTURAL—**

\$290 per ton erected, when out of mill. \$350 per ton erected, when out of stock.

**STEEL REINFORCING—**

\$200.00 per ton, in place.	
1/4-in. Rd. (Less than 1 ton) per 100 lbs.	\$8.90
3/8-in. Rd. (Less than 1 ton) per 100 lbs.	7.80
1/2-in. Rd. (Less than 1 ton) per 100 lbs.	7.50
5/8-in. Rd. (Less than 1 ton) per 100 lbs.	7.25
3/4-in. & 7/8-in. Rd. (Less than 1 ton)	7.15
1 in. & up (Less than 1 ton)	7.10
1 ton to 5 tons, deduct 25c.	

**STORE FRONTS—**

Individual estimates recommended. See ESTIMATORS DIRECTORY for Architectural Veneer (3), and Mosaic Tile (35).

**TILE—**

Ceramic Tile Floors—Commercial \$1.20 to \$1.60 per sq. ft.	
Cove Base—\$1.40 per lin. ft.	
Quarry Tile Floors, 6x6" with 6" base @ \$1.35 per sq. ft.	
Tile Wainscots & Floors, Residential, 4 1/4 x 4 1/4", @ \$1.65 to \$2.00 per sq. ft.	
Tile Wainscots, Commercial Jobs, 4 1/4 x 4 1/4" Tile, @ \$1.50 to \$1.65 per sq. ft.	
Asphalt Tile Floor 1/2" x 3", \$ .18 - \$ .35 sq. yd. Light shades slightly higher.	
Cork Tile—\$ .70 per sq. ft.	
Mosaic Floors—See dealers.	
Linoleum tile, per sq. ft.	\$ .65
Rubber tile, per sq. ft.	\$.55 to \$.75

**Furring Tile**

Scored	F.O.B. S. F.
12 x 12, each	\$.17
Kraftite: Per square foot	
Patio Tile—Niles Red	Small Lots
12 x 12 x 7/8-inch, plain	Large Lots
6 x 12 x 7/8-inch, plain	\$ .40
6 x 6 x 7/8-inch, plain	\$.46
Building Tile	
8 1/2 x 12-inches, per M	\$139.50
6 5/8 x 12-inches, per M	105.00
4 5/8 x 12-inches, per M	84.00
Hollow Tile	
12x12 1/2 inches, per M	\$146.75
12x12 3/4 inches, per M	156.85
12x12 1/4 inches, per M	177.10
12x12 1/8 inches, per M	235.30
	F.O.B. Plant

**VENETIAN BLINDS—**

75c per square foot and up. Installation extra.

**WINDOWS—STEEL—INDUSTRIAL—**

Cost depends on design and quality required.

# ARCHITECT AND ENGINEER ESTIMATOR'S DIRECTORY

## Building and Construction Materials

**EXPLANATION**—Building and construction materials are shown in major classified groups for general identification purposes with names and addresses of suppliers of materials listed in detail under group classification where name first appears—main offices are shown first with branch or district offices following. The numeral appearing in listings \*(3) refers to the major group classification where complete data on the dealer, or representative, may be found.

### ADHESIVES (1)

Wall and Floor Tile Adhesives  
THE CAMBRIDGE TILE MFG. CO. \*135

### AIR CONDITIONING (2)

Air Conditioning & Cooling  
UTILITY APPLIANCE CORP.  
Los Angeles 58: 4951 S. Alameda St.  
San Francisco: 1355 Market St., UN 1-4908

### ARCHITECTURAL VENEER (3)

Ceramic Veneer  
GLADDING, McBEAN & CO.  
San Francisco: Harrison at 9th St., UN 1-7400  
Los Angeles: 2901 Los Feliz Blvd., DL 2121  
Portland: 110 S. E. Main St., EA 6179  
Seattle: 1500 First Ave. S., EL 4711  
Spokane: 1102 N. Monroe St., BR 3259  
THE CAMBRIDGE TILE MFG. CO. \*135

Porcelain Veneer  
PORCELAIN ENAMEL PUBLICITY BUREAU  
Oakland 12: Room 601 Franklin Building  
Pasadena 8: P. D. Box 186, East Pasadena Station

Granite Veneer  
VERMONT MARBLE COMPANY  
San Francisco 5: 525 Market St., SU 1-6747  
Los Angeles: 3522 Council St., DU 2-7834

Marble Veneer  
VERMONT MARBLE COMPANY  
San Francisco 5: 525 Market St., SU 1-6747  
Los Angeles: 3522 Council St., DU 2-7834

### BANKS - FINANCING (4)

CROCKER FIRST NATIONAL BANK OF S. F.  
San Francisco, Post & Montgomery Sts., EX 2-7700

### BATHROOM FIXTURES (5)

Metal  
THE CAMBRIDGE TILE MFG. CO. \*135

Ceramic  
THE CAMBRIDGE TILE MFG. CO. \*135

### BRASS PRODUCTS (6)

GREENBERG'S, M. & SONS  
San Francisco 7: 765 Folsom, EX 2-3143  
Los Angeles 23: 125B S. Boyle, AN 3-7108  
Seattle 4: 1016 First Ave. So., MA 5140  
Phoenix: 3009 N. 19th Ave., Apt. 92, PH 2-7663  
Portland 4: 51D Builders Exch. Bldg., AT 6443

### BRICKWORK (7)

Face Brick  
GLADDING, McBEAN & CO. \*131

KRAFTILE \*135

REMILLARD-DANDINI CO.  
San Francisco 4: 400 Montgomery St., EX 2-4988

### BROWN PRODUCTS (8)

GREENBERG'S, M. & SONS \*167

### BUILDING PAPERS & FELTS (9)

ANGIER PACIFIC CORP.  
San Francisco 5: 55 New Montgomery St., DO 2-4416  
Los Angeles: 7424 Sunset Blvd.  
PACIFIC COAST AGGREGATES, INC. \*111

SISALKRAFT COMPANY  
San Francisco 5: 55 New Montgomery St., EX 2-3066  
Chicago, Ill.: 205 West Wacker Drive

### BUILDING HARDWARE (9a)

THE STANLEY WORKS  
San Francisco: Monadnock Bldg., YU 6-5914  
New Britain, Conn.

### CEMENT (10)

IDEAL CEMENT COMPANY (Pacific Division)  
San Francisco 4: 310 Sansome St., GA 1-4100  
PACIFIC COAST AGGREGATES, INC. \*113

### CONCRETE AGGREGATES (11)

Ready Mixed Concrete  
PACIFIC COAST AGGREGATES, INC.  
San Francisco: 400 Alabama St., KL 2-1616  
Sacramento: 16th and A Sts., GI 3-6586  
San Jose: 790 Stockton Ave., CY 2-5620  
Oakland: 2400 Peralta St., GL 1-0177  
Stockton: 820 So. California St., ST 8-8643

### Lightweight Aggregates

AMERICAN PERLITE CORP.  
Richmond: 26th & B. St. - Yd. 2, RI 4307

### DOORS (12)

Hollywood Doors  
WEST COAST SCREEN CO.  
Los Angeles: 1127 E. 63rd St., AD 1-1108  
W. P. FULLER CO.  
Seattle, Tacoma, Portland  
NICOLAI DOOR SALES CO.  
San Francisco: 3045 19th St.  
F. M. COBB CO.  
Los Angeles & San Diego

SOUTHWESTERN SASH & DOOR  
Phoenix, Tucson, Arizona  
El Paso, Texas  
HOUSTON SASH & DOOR  
Houston, Texas

### Screen Doors

WEST COAST SCREEN DOOR CO.  
(See above)

### FIRE ESCAPES (13)

MICHEL & PFEFFER IRON WORKS, INC.  
South Linden & Tanforan Ave.  
South San Francisco: JU 4-8362

### FIREPLACES (14)

Heat Circulating  
SUPERIOR FIREPLACE CO.  
Los Angeles: 170B E. 15th St., PR 8393  
Baltimore, Md.: 601 No. Point Rd.

### FLOORS (15)

Hardwood Flooring  
HOGAN LUMBER COMPANY  
Oakland: Second and Alvie Sts., GL 1-6861

Floor Tile  
GLADDING, McBEAN & CO. \*131  
KRAFTILE \*135

Floor Tile (Ceramic Mosaic)  
THE CAMBRIDGE TILE MFG. CO. \*135

Floor Treatment & Maintenance  
HILLYARD SALES CO. (Western)  
San Francisco: 470 Alabama St., MA 1-7766  
Los Angeles: 923 E. 3rd, TR 8282

Seattle: 3440 E. Marginal Way  
Diversified (Magnesite, Asphalt Tile, Composition, Etc.)  
LE ROY OLSON CO.

San Francisco 10: 3070 - 17th St., HE 1-0188  
Sleepers (Composition)  
LE ROY OLSON CO.

### GLASS (16)

W. P. FULLER COMPANY  
San Francisco: 301 Mission St., EX 2-7151  
Los Angeles, Calif.  
Portland, Ore.

### HEATING (17)

S. T. JOHNSON CO.  
Oakland 8: 940 Arlington Ave., DL 2-6000  
San Francisco: 585 Potrero Ave., MA 1-2757  
Philadelphia 8, Pa.: 401 N. Broad St.

SCOTT COMPANY  
San Francisco: 243 Minna St., YU 2-0400  
Oakland: 113 - 10th St., GL 1-1937  
San Jose, Calif.  
Los Angeles, Calif.

### UTILITY APPLIANCE CORP. \*121

### Electric Heaters

WESIX ELECTRIC HEATER CO.  
San Francisco 5: 390 First St., GA 1-2211  
Los Angeles: 520 W. 7th St., MI 8096  
Portland: Terminal Sales Bldg., BE 2050  
Seattle: Securities Bldg., SE 5028

### Designer of Heating

THOMAS B. HUNTER  
San Francisco 4: 41 Sutter St., GA 1-1164

### INSULATION AND WALL BOARD (18)

LUMBER MANUFACTURING CO.  
San Francisco: 225 Industrial Ave., JU 7-1760  
PACIFIC COAST AGGREGATES, INC. \*111  
SISALKRAFT COMPANY \*191

WESTERN ASBESTOS COMPANY  
San Francisco: 675 Townsend St., KL 2-3868  
Oakland: 251 Fifth Avenue, GL 1-2345  
Stockton: 733 S. Van Buren, ST 4-9421  
Sacramento 1331 - T St., HU 1-0125  
Fresno: 434 - P St., TR 2-1600

### IRON—Ornamental (10)

MICHEL & PFEFFER IRON WORKS, INC. \*1131

### LANDSCAPING (20)

Landscape Contractors  
HENRY C. SOTO CORP.  
Los Angeles: 13,000 S. Avalon Blvd., ME 4-6617

### LIGHTING FIXTURES (21)

SMOOT-HOLMAN COMPANY  
Inglewood, Calif., DR 8-1217  
San Francisco: 55 Mississippi St., MA 1-8474

### LUMBER (22)

Shingles  
LUMBER MANUFACTURING CO. \*1181

### MARBLE (23)

VERMONT MARBLE COMPANY  
San Francisco 5: 525 Market St., SU 1-6747  
Los Angeles 4: 3522 Council St., DU 2-7834

### METAL LATH EXPANDED (24)

PACIFIC COAST AGGREGATES, INC. \*1111

### MILLWORK (25)

LUMBER MANUFACTURING COMPANY \*1181  
MULLEN MANUFACTURING COMPANY  
San Francisco: 60-80 Rausch St., UN 1-5815  
PACIFIC MANUFACTURING COMPANY  
San Francisco: 16 Beale St., GA 1-7755  
Santa Clara: 2610 The Alameda, SC 607  
Los Angeles, 6820 McKinley Ave., TH 4196

**PAINTING (26)**

Paint  
W. P. FULLER COMPANY \*(161)

**PLASTER (27)**

Interiors - Metal Lath & Trim  
PACIFIC COAST AGGREGATES, INC. \*(11)  
Exteriors  
PACIFIC PORTLAND CEMENT COMPANY \*(28)

**PLASTIC CEMENT (28)**

IDEAL CEMENT COMPANY  
San Francisco: 370 Sansome St., GA 1-4100

**PLUMBING (29)**

THE HALSEY TAYLOR COMPANY  
Redlands, Calif.  
Warren, Ohio  
THE SCOTT COMPANY \*(17)  
HAWES DRINKING FAUCET COMPANY  
Berkeley 10: 1435 Fourth St., LA 5-3341  
CONTINENTAL WATER HEATER COMPANY  
Los Angeles 31: 1801 Pasadena Ave., CA 6178  
SIMONS MACHINERY COMPANY  
San Francisco: 816 Folsom St., DO 2-6794  
Los Angeles: 455 East 4th St., MU 8322  
SECURITY VALVE COMPANY  
Los Angeles 31: 410 San Fernando Rd., CA 6191

**RESILIENT TILE (30)**

LE ROY OLSON CO. \*(151)

**SEWER PIPE (32)**

GLADDING, McBEAN & CO. \*(31)

**SHEET METAL (32)**

Windows  
DETROIT STEEL PRODUCTS COMPANY  
Oakland 8: 1310 - 63rd St., OL 2-8826  
San Francisco: Russ Building, DO 2-0890  
MICHEL & PFEFFER IRON WORKS, INC. \*(131)  
PACIFIC COAST AGGREGATES, INC. \*(11)  
Fire Doors  
DETROIT STEEL PRODUCTS COMPANY  
Skylights  
DETROIT STEEL PRODUCTS COMPANY

**STEEL—STRUCTURAL (33)**

COLUMBIA STEEL CO.  
San Francisco: Russ Bldg., SU 1-2500  
Los Angeles: 2087 E. Slauson, LA 1721  
Portland: 2345 N. W. Nicolai, BE 7261  
Seattle 1331 3rd Ave. Bldg., MA 1972  
Salt Lake City: Walker Bank Bldg., SL 3-6733  
HERRICK IRON WORKS  
Oakland: 18th & Campbell Sts., GL 1-1767  
JUOSSON PACIFIC-MURPHY CORP.  
Emeryville: 4300 Eastshore Highway, DL 3-1717  
REPUBLIC STEEL CORP.  
San Francisco: 116 N. Montgomery St., GA 1-0977  
Los Angeles: Edison Building  
Seattle: White-Henry-Stuart Building  
Salt Lake City: Walker Bank Building  
Denver: Continental Oil Building  
SAN JOSE STEEL COMPANY  
San Jose 195 North Thirtieth St., CO 4184

**STEEL—REINFORCING (34)**

REPUBLIC STEEL CORP. \*(331)  
HERRICK IRON WORKS \*(131)  
SAN JOSE STEEL CO. \*(131)  
COLUMBIA STEEL CO. \*(131)

**CLAY TILE (35)**

THE CAMBRIDGE TILE MFG. CO.  
San Francisco 10: 470 Alabama St., UN 3-1666  
Los Angeles 19: 1335 S. La Brea, WE 3-7800  
GLADDING, McBEAN & CO. \*(31)  
KRAFTILE  
Niles, Calif.: Niles 3611  
San Francisco 5: 50 Hawthorne St., DO 2-3780  
Los Angeles 13: 406 South Main St., MU 7241

**TIMBER—REINFORCING (36)**

Trusses  
WYERHAEUSER SALES CO.  
Tacoma, Wash.  
St. Paul, Minn.  
Newark, N. J.  
Treated Timber  
J. H. BAXTER CO.  
San Francisco 4: 333 Montgomery St., DO 2-3883  
Los Angeles 13: 601 West Fifth St., MI 6294

**WALL TILE (37)**

THE CAMBRIDGE TILE MFG. CO. \*(135)  
GLADDING, McBEAN & CO. \*(31)  
KRAFTILE COMPANY \*(135)

**WINDOWS STEEL (38)**

DETROIT STEEL PRODUCTS CO. \*(32)  
MICHEL & PFEFFER IRON WORKS, INC. \*(131)  
PACIFIC COAST AGGREGATES, INC. \*(111)

**GENERAL CONTRACTORS (39)**

BARRETT & HILP  
San Francisco: 918 Harrison St., DO 2-0700  
Los Angeles: 234 W. 37th Place, AD 3-8161  
DINWIDDIE CONSTRUCTION COMPANY  
San Francisco: Crocker Building, YU 6-2718  
CLINTON CONSTRUCTION COMPANY  
San Francisco: 923 Folsom St., SU 1-3440  
MATTOCK CONSTRUCTION COMPANY  
San Francisco: 604 Mission St., GA 1-5516  
PARKER, STEFFENS & PEARCE  
San Francisco: 135 So. Park, EX 2-6639  
STOLTE, INC.  
Oakland: 8451 San Leandro Blvd., TR 2-1064  
SWINERTON & WALBERG COMPANY  
San Francisco: 225 Bush St., GA 1-2980  
Oakland: 1723 Webster St., HI 4-4322  
Los Angeles, Sacramento, Denver  
P. J. WALKER COMPANY  
San Francisco: 391 Sutter St., YU 6-5916  
Los Angeles: 714 W. Olympic Blvd., RI 7-5521

**TESTING LABORATORIES**

(ENGINEERS & CHEMISTS (40))  
ABBOT A. HANKS, INC.  
San Francisco: 624 Sacramento St., GA 1-1697  
ROBERT W. HUNT COMPANY  
San Francisco: 251 Kearny St., EX 2-4634  
Los Angeles: 3050 E. Slauson, IE 9131  
Chicago, New York, Pittsburgh  
PITTSBURGH TESTING LABORATORY  
San Francisco: 651 Howard St., EX 2-1747

**BUILDING TRADES WAGE (JOB SITES) NORTHERN, CENTRAL AND SOUTHERN CALIFORNIA**

ATTENTION: The following are the PREVALING hourly rates of compensation being paid and in effect by employers by agreement between employees and their union; or as recognized and determined by the U. S. Department of Labor. (September 1, 1952.)

CRAFT	San Francisco	Alameda	Contra Costa	Fresno	Sacramento	Joanquin	Santa Clara	Solano	Los Angeles	San Bernardino	San Diego	Santa Barbara	Kern
ASBESTOS WORKERS	\$2,585	\$2,585	\$2,585	\$2,585	\$2,585	\$2,585	\$2,585	\$2,585	\$2.25	\$2.25	\$2.25	\$2.25	\$2.25
BOILERMAKERS	2.68	2.68	2.68	2.68	2.68	2.68	2.68	2.68	3.00	3.00	2.75	3.00	3.00
BRICKLAYERS	3.25	3.25	3.25	3.00	3.25	3.00	3.45	3.25	1.94	1.94	1.94	1.94	1.94
BRICKLAYERS, HODCARRIERS	2.45	2.45	2.45	2.00	2.40	2.25	2.45	2.45	2.57	2.57	2.57	2.57	2.57
CARPENTERS	2.60	2.60	*2.39	*2.39	*2.39	*2.39	*2.39	*2.39	2.57	2.57	2.57	2.57	2.57
CEMENT FINISHERS	2.57	2.57	2.57	2.57	2.57	2.57	2.57	2.57	2.57	2.57	2.57	2.57	2.57
ELECTRICIANS	3.00	3.00	3.00	3.00	3.00	2.75	3.00	2.75	2.75	2.75	2.75	2.75	2.75
ELEVATOR CONSTRUCTORS	2.75	2.70	2.45	2.75	2.915	2.915	2.915	2.915	2.25	2.25	2.25	2.25	2.25
ENGINEERS: MATERIAL HOIST	2.56	2.56	2.56	2.56	2.56	2.56	2.56	2.56	1.9875	1.9875	1.9875	1.9875	1.9875
GLAZIERS	2.30	2.30	2.30	2.30	2.25	2.30	2.30	2.30	2.16	2.16	2.16	2.16	2.16
IRONWORKERS: ORNAMENTAL	2.55	2.55	2.55	2.55	2.55	2.55	2.55	2.55	2.70	2.70	2.70	2.70	2.70
REINFORCING RODMEN	*2.45	2.45	2.45	2.45	2.45	2.45	2.45	2.45	2.38	2.38	2.38	2.38	2.38
STRUCTURAL	*2.70	2.70	2.70	2.70	2.70	2.70	2.70	2.70	2.70	2.70	2.70	2.70	2.70
LABORERS: BUILDING	1.85	1.85	1.85	1.85	1.85	1.85	1.85	1.85	1.94	1.94	1.94	1.94	1.94
CONCRETE	1.85	1.85	1.85	1.85	1.85	1.85	1.85	1.85	1.94	1.94	1.94	1.94	1.94
LATHERS	3.00	3.00	3.00	3.00	3.00	2.75	3.00	2.8125	3.125	3.125	3.125	3.125	3.125
MARBLE SETTERS	2.70	2.70	2.70	2.70	2.70	2.70	2.70	2.70	2.25	2.25	2.25	2.25	2.25
MOSAIC & TERRAZZO	2.6125	2.6125	2.6125	2.6125	2.6125	2.6125	2.6125	2.6125	2.40	2.40	2.40	2.40	2.40
PAINTERS	**2.60	2.60	2.60	2.60	2.60	2.60	2.60	2.60	2.38	2.56	2.425	2.22	2.22
PILEDRIVERS	*2.5575	*2.5575	*2.5575	*2.5575	*2.5575	*2.5575	*2.5575	*2.5575	3.00	3.125	3.125	3.125	3.125
PLASTERERS	3.125	3.165	3.125	3.125	3.00	3.00	3.125	3.00	2.75	2.75	2.75	2.75	2.75
PLASTERERS, HODCARRIERS	2.60				2.50	2.50	2.50	2.50	2.875	2.25	2.30	2.00	2.00
PLUMBERS	2.90	2.90	2.875	2.75	2.75	2.75	2.75	2.75	2.90	2.90	2.90	2.90	2.90
ROOFERS	2.50	2.50	2.50	2.25	2.50	2.50	2.50	2.50	2.65	2.00	1.90	2.00	2.00
SHEET METAL WORKERS	2.475	2.475	2.3125	2.43	2.50	2.50	2.40	2.415	2.475	2.475	2.175	2.00	2.475
SPRINKLER FITTERS	2.75	2.70	2.70	2.625	2.625	2.625	2.75	2.75	2.25	2.25	2.25	2.25	2.25
STEAMFITTERS	2.75	2.90	2.90	2.75	2.625	2.625	2.75	2.75	2.90	2.90	2.90	2.90	2.90
TRUCK DRIVERS—1/2 Ton or less	1.89	1.99	1.99	1.89	1.89	1.74	1.89	1.89	2.65	2.65	2.65	2.65	2.65
TILESETTERS	2.95	2.95	2.95	2.95	2.95	2.95	2.95	2.95	2.65	2.65	2.65	2.65	2.65

\* 6 Hour Day. \*\* 7 Hour Day. \*\*\* Before C.I.S.C. for 15c Increase.

Prepared and compiled by:

CENTRAL CALIFORNIA CHAPTER, ASSOCIATED GENERAL CONTRACTORS OF AMERICA, with the assistance and cooperation of secretaries of General Contractors Associations and Builders Exchanges of Northern California; and the above information for southern California is furnished by the Labor Relations Department of the Southern California Chapter, ASSOCIATED GENERAL CONTRACTORS OF AMERICA.



**ALASKA DISTRICT ENGINEERS  
AWARDS HOUSING CONTRACT**

The Alaska District Engineers, Anchorage, recently awarded a contract to L. E. Baldwin of Seattle, for the construction of 47- eight family quarters at the Elmendorf Air Force Base at a price of \$5,844,300.

The contract was awarded following release by the Bureau of the Budget of \$68-millions in Alaskan defense construction.

**CALIFORNIA NEW CAPITOL**

(From page 27)

neering, estimating section, and construction services unit and laboratory divisions of the Division of Architecture, State of California.

It is interesting to note in observing some of the outstanding features of the new Capitol wing, the use of many types of building materials including nickel silver, aluminum, stainless steel, bronze and iron, many of which were installed by C. E. Toland & Son, ornamental metal craftsmen of San Francisco. Toland has fabricated and meticulously installed a rare symphony of these new materials, and the new Capitol project involved some 200 tons of steel and miscellaneous iron; 175,000 pounds of extruded and cast aluminum, with modeling and casting of aluminum spandrels and grilles in sizes never before attempted by a California fabricator. Truly an outstanding achievement without precedent in the West.

**NEWS & COMMENT ON ART**

(From page 40)

photographic artistry developed by Life magazine and a "picture story" will be followed from assignment to publication. Sunday, May 17th.

"Design For Eating," Sunday, May 31st — The kitchen and dining room have a new look because they have been changed by modern designers. Dinnerware, cooking utensils, serving accessories,

and flatware.

"Fernand Leger," Sunday, June 13th — In conjunction with exhibition of the work of this famous 20th Century French painter, a special program has been planned.

"Can We Integrate The Arts?", Sunday, June 27th — An architect, landscape architect, interior designer, sculptor and painter will debate the manner in which all of the professions represented can work together effectively.

**HOLLYWOOD JUNIOR  
COMBINATION  
SCREEN and METAL SASH DOOR  
★  
The "WEATHER-WISE"  
DOOR!!**

**A VENTILATING SCREEN DOOR  
A SASH DOOR  
A PERMANENT OUTSIDE DOOR  
ALL 3 IN 1!**

Discriminating home owners and architects have chosen Hollywood Junior as the TRIPLE DOOR VALUE in the COMBINATION SCREEN and METAL SASH DOOR field! A sturdy dependable door, constructed of quality materials, HOLLYWOOD JUNIOR'S EXCLUSIVE PATENTED FEATURES have outmoded old-fashioned screen doors and other doors of its type entirely! . . . . .

**IT GUARANTEES YOU YEAR 'ROUND  
COMFORT, CONVENIENCE and ECONOMY**

WE ALSO MANUFACTURE A COMPLETE LINE OF  
SHUTTERS, C. C. DOORS, SCREENS, SCREEN DOORS, LOUVRE DOORS

**WEST COAST SCREEN CO.**  
1145 EAST 63rd STREET \* LOS ANGELES, CALIFORNIA  
ATLANS 1118

★ \* WRITE FOR FREE ILLUSTRATED LITERATURE \* ★

**CLASSIFIED ADVERTISING**

RATE: 20c PER WORD . . . CASH WITH ORDER

MINIMUM \$5.00

**BUILDERS!** You can make more money; get information you need before it is published elsewhere: Subscribe to the daily ARCHITECTS REPORTS, only \$10.00 per month. Complete information from ARCHITECTS REPORTS, 68 Post Street, San Francisco. Phone Douglas 2-8311.

**PHOTOGRAPHY.** For the best in construction photography, including exterior and interior, aerial, and progress views . . . you will find as many others have that it's the SKELTON STUDIOS, 875 O'Farrell St., San Francisco. Telephone PRospect 6-1841.

**ARCHITECTURAL DRAFTSMAN WANTED;** Experienced in working drawings and details

for hospitals, schools, and commercial work. Excellent working conditions: Permanent position. W. D. Holdredge, P. O. Box 412, San Luis Obispo, Calif.

Registered ARCHITECT, residential and commercial, 17 years experience, seeks association with medium sized firm. Independent work, design, specifications, supervision, client contact. BOX J-3, Architect & Engineer, 68 Post Street, San Francisco, Calif.

**ARCHITECTURAL SLIDING SLEEL SASH.** One lot only — new, half price, 13 units, assorted sizes, 353 square feet total. 3 at 7 ft. x 5 ft.; 4 at 7 ft. x 4 1/2 ft.; 1 at 6 ft. x 4 1/2 ft.; 2 at 6 ft. x 4 ft.; 1 at 7 ft. x 3 1/2 ft.;

1 at 4 1/2 ft. x 3 ft.; 1 at 3 ft. x 3 ft. Phone DElaware 3-7378, San Francisco.

**YOUNG ARCHITECT** — Wanted with some evenings and weekends free during April to assist business couple building S. F. view home. Ideas are formulated, but need professional services at reasonable rate. Address replies to Suite 485, 703 Market St., S. F.

**MODERN FRESCO PAINTINGS ON SLABS** by SIMEON PELENC—Received A.I.A. and Government awards. Approximate size 3 x 4 ft. Suitable for exterior or interior decoration. HELEN PELENC, 1101 Francisco St., San Francisco.

## CONSTRUCTION CONTRACTS AWARDED AND MISCELLANEOUS PERSONNEL DATA

**STORE BUILDING**, Long Beach, Los Angeles County. Clyde L. Edwards, owner. 4700 sq. ft., \$115,000. ENGINEER: George D. Roalfe, Long Beach. Frame and stucco construction, composition roofing, plate glass, split brick bulkheads, pipe columns, glass panel doors, concrete slab floor, 100,000 BTU suspended heater, toilet rooms. OWNER BUILDS.

**LOW RENT HOUSING PROJECT**, Fresno, Fresno County. Housing Authority, City of Fresno, owner. 150 dwelling units and community building, \$987,289. ARCHITECT, Robt. W. Stevens, Fresno; Beni. F. Lippold, Fresno. Frame and stucco, plywood interior, insulation, rigid asbestos shingle roof. GENERAL CONTRACTOR, Harris Construction Co., Fresno.

**CAFETERIA AND APPLIED SALESMANSHIP BUILDING**, Long Beach, Los Angeles County. Long Beach Board of Education, owner. 1 story, \$122,000. ARCHITECT, Kenneth S. Wing, Long Beach. Frame and stucco construction, composition roofing, wood awning type sash, skylights, slab and asphalt tile floors, interior plaster, acoustic work, forced air heating, insulated partitions. GENERAL CONTRACTOR, Brewer-Webb Construction Co., Long Beach.

**ROBLA ELEMENTARY SCHOOL**, Robla, Sacramento County. Robla Elementary School District, owner. 20 classrooms, administration, multi-purpose, kindergarten, kitchen, toilet rooms, \$200,000. ARCHITECT, Geo. C. Sellon, Sacramento. Frame

and stucco construction. GENERAL CONTRACTOR: Edwin J. Mackey, Sacramento. **HENDERSON SCHOOL**, Barstow, California. Borstow Union School District, owner. 17 classrooms, 2 kindergartens, administration and health unit, multi-purpose kitchen unit, toilets and covered passages. ARCHITECT, Kistner, Wright and Wright, Los Angeles. Frame and stucco construction. GENERAL CONTRACTOR, Brunzell Construction Co., Culver City.

**NEW CAFETERIA BUILDING AT CENTRAL UNION HIGH SCHOOL**, Fresno, Fresno County. Central Union High School District, owner. \$143,777. ARCHITECT, Walter Wagner, Fresno. Wood & masonry, composition roofing, insulation, 5,900 sq. ft., includes double line complete kitchen, stainless steel equipment, snack bar. GENERAL CONTRACTOR, Larsen-Ratio Construction Co., Fresno.

**TWENTY DWELLINGS**, Long Beach, Los Angeles County. Larchmont Development Co., owner. 1100 sq. ft., 4 and 5 room dwellings, \$170,193. ARCHITECT: William A. Lockett and Richard L. Popper, Long Beach. Frame & stucco construction, composition shingle roofing, aluminum casement sash, dual wall furnaces, tub and stall showers, overhead garage doors. GENERAL CONTRACTOR: M. J. Brock & Sons, Inc., Los Angeles.

**PASSENGER CONCOURSE**, So. San Francisco Airport, San Mateo County. City & County of San Francisco Public Utilities Commission, owner. 1 & 2 story, \$1,246,000. ARCHITECT: W. P. Day & Assocs., San Francisco. Structural steel frame, wood deck, porcelain enameled exterior, composition roofing, concrete foundations, concrete floors, slab. GENERAL CONTRACTOR: Carl N. Swenson Co., San Jose.

**OFFICE AND WAREHOUSE**, Los Angeles, Los Angeles County. Continental Assurance Co., owner. 400 x 650 ft., 2 story, \$1,150,000. ARCHITECT: Earl G. Boehm, Rivera. Reinforced concrete construction, composition roof, concrete slab, asphalt tile, terrazzo and ceramic tile floors, metal toilet partitions, air conditioning unit, sawtooth skylights, steel canopies, pipe columns, elevator, vaults, pre-cast concrete panel walls, columns and girders, steel stairs, metal roll-up doors. GENERAL CONTRACTOR: William P. Neil Construction and Maintenance Co., Los Angeles.

**SURGICAL WING ADDITION TO HOSPITAL**, Inglewood, Los Angeles County. Centinela Valley Community Hospital, owner. 3 major surgical units, offices, locker rooms, washup rooms, waiting rooms, dark room, 9000 sq. ft., \$350,000. ARCHITECT: Walker, Kallonzes & Klingerman, Los Angeles. Reinforced concrete construction, composition roofing, insulation, non-conductive floors, tile walls ceiling height in surgical rooms, steel sash, air-conditioning. GENERAL CONTRACTOR: Myers Bros., Los Angeles.

**APARTMENT BUILDING**, Los Angeles, Los Angeles County. Wagner Construction Co., owner. 2 story, 48 family, 200x114 ft., \$250,000. ARCHITECT: Martin Stern, Jr., Beverly Hills. Frame & stucco construction, redwood siding, crushed rock composition roof, concrete, carpeted, hardwood, linoleum and rubber tile floors, tile bath tubs and stall showers, glass enclosed bath tubs, corru-

gated and plate glass, stone veneer, steel casements, metal kitchen cabinets. GENERAL CONTRACTOR: Wagner Construction Co., Beverly Hills.

**EASTERN ELEMENTARY SCHOOL**, Sacramento, Sacramento County. Arden-Carmichael Union Elementary School District, owner. 9 classrooms, administration, kindergarten, multi-purpose, kitchen & toilet rooms, \$271,627. ARCHITECT: John Lyon Reid, San Francisco. 1 story, 18,500 sq. ft., frame & stucco construction. GENERAL CONTRACTOR: Coastwide Construction Co., Stockton.

**NEW SCHOOL PLANT**, Norwalk, Los Angeles County. Alameda School District, owner. 6 classroom, elementary and 2 room kindergarten, 10,400 total sq. ft., \$172,204. ARCHITECT: Jerome S. DeHerte, Compton. Frame & stucco construction, composition roofing, steel sash, concrete slab, asphalt tile, radiant heating, ceramic tile toilet rooms, metal toilet partitions. GENERAL CONTRACTOR: Gerstenberger & Piersen, Los Angeles.

**CHURCH & RECTORY**, Visalia, Tulare County. Roman Catholic Diocese, Monterey-Fresno, owner. St. Mary's Parish, \$214,800. ARCHITECT: Laurence D. Viole, North Hollywood. Frame & stucco construction, tile roof, metal sash, asphalt tile floors. GENERAL CONTRACTOR: Trewhitt, Shields & Fisher, Fresno.

**ANIMAL HOSPITAL**, Pasadena, Los Angeles County. Dr. E. Crosby Howe, Pasadena, owner. 1500 sq.ft. frame, stucco, masonry animal hospital; composition gravel roofing, concrete slab floors, asphalt tile, office reception and surgical rooms, interior stucco and plaster, steel sash, toilet units, concrete block walls, asphalt paving, \$12,000. ARCHITECT: Kenneth A. Gordon, Altadena.

**LOW RENT HOUSING PROJECT**, Bakersfield, Kern County. Housing Authority of Kern County, owner. 184 units of 1-2-3 & 4 bedroom frame and stucco residences; administration building, maintenance shops, \$1,302,000. ARCHITECT: Robert N. Eddy, Bakersfield. GENERAL CONTRACTOR: Fred S. Macomber, Los Angeles.

**STORE BUILDING**, San Francisco. Woolworth & Co., owner. 2-Story, class 3, reinforced concrete and frame. ENGINEER: John J. Gould, San Francisco. GENERAL CONTRACTOR: Swinerton & Walberg.

**ELEMENTARY SCHOOL BUILDING**, Biggs, Butte County. Biggs Elementary School District, 4-Classroom, administration, kindergarten, toilet rooms, frame and stucco construction, \$100,100. ARCHITECT: Lawrence G. Thomson, Chico. GENERAL CONTRACTOR: Fred Chapek, Dorville, Gallino & Kohler, Sacramento.

**HIGH SCHOOL ADD'N**, San Andreas, Calaveras County. Calaveras Joint Union High School District, San Andreas, owner. Home making, commercial, science, gymnasium and swimming pool, \$396,500. Frame and stucco. ARCHITECT: Ernst & Lloyd, Stockton. GENERAL CONTRACTOR: Floyd G. Borchardt, Stockton.

**INDUSTRIAL BUILDING**, Los Angeles. E. R. Mollner, Pasadena, owner. Brick, industrial, 40x115 ft., composition roof, concrete slab and asphalt tile floors, interior plaster work, steel sash, toilets, overhead doors, rotary roof ventilators asphalt paving. ARCHITECT: Saul H. Brown, North Hollywood. ENGINEER: H. V. Lamberti, Los Angeles. GENERAL CONTRACTOR: George S. Stoll, Hollywood.

**HIGH SCHOOL ADD'N**, Fortuna, Humboldt County. Fortuna Union High School District, Fortuna, owner. 7-Classrooms, toilets, 1-story, frame and redwood exterior, composition shingle roof, asphalt tile floors, ceramic

# SLEEPERS

**UNI-BOND—PRECAST—  
PERMANENT—NEVER ROT—  
PERMANENTLY  
NAIL PENETRABLE  
FIRE PROOF  
SECURELY BONDED TO  
THE CONCRETE SLAB**

**Make Solid Non-Squeaking  
Permanent Wood Flooring**

Used in spring floor construction for Gymnasiums and dance floors, also under solid wood floor construction. Spaced on any centers desired. Specifications and information available on request.

Territories open for qualified representatives. Free consultation service.

**LeROY OLSON  
COMPANY**

3070 Seventeenth Street,  
San Francisco, California



tile work, metal sash, acoustical tile ceilings, 10,586 sq.ft., \$102,000. ARCHITECT: Harold Gimeno, Santa Ana. GENERAL CONTRACTOR: R. H. Douglas, Fortuna.

**RECTORY BUILDING.** San Francisco. Roman Catholic Archbishop of San Francisco, owner. 2-story frame and stucco, \$140,000. ARCHITECT: Vincent Buckley, San Francisco. GENERAL CONTRACTOR: Robert McCarthy, San Francisco.

**MOTEL BUILDING.** Palo Alto, Santa Clara County. James Hunter, Salinas, owner. 1 and 2-story frame and stucco, 24-units, \$76,000. ARCHITECT: Thos. S. Elston, Salinas. GENERAL CONTRACTOR: Johnson & Mape, Menlo Park.

**JUVENILE HALL REMODEL.** Kern county. County of Tulare, Visalia, owner. Interior remodel, new detention steel sash, \$65,000. ARCHITECT: James P. Lockett, Visalia. GENERAL CONTRACTOR: Chester & Alexander, Visalia.

**OFFICE BUILDING.** Bakersfield, Kern county. Union Oil Co., Los Angeles, owner. Contract \$47,532. ARCHITECT: William Hastrup, Fresno. GENERAL CONTRACTOR: Valley Builders, Fresno.

**WAREHOUSE OFFICE & STORE.** Long Beach. William C. McDean, Long Beach, owner. 1-story, frame and stucco, warehouse office and store building, built-up composition roofing, bow-string trusses, plate glass, wood sliding doors, concrete slab floor with asphalt tile covering in offices, forced air heating, acoustical tile ceilings, plumbing, electrical work, 13,600 sq.ft. STRUCTURAL ENGINEER: Francis H. Geary, Long Beach.

**MANUFACTURING PLANT.** Glendale. F. E. Langenberger, Glendale, owner. Reinforced brick manufacturing building, composition roof, concrete slab floor, steel sash, toilet units, interior plaster, roof ventilators, 50x120 ft. ARCHITECT: Latta & Denney, Glendale.

**CHURCH AUDITORIUM.** South Gate, Los Angeles County. Grace Bible Church, South Gate, owner. 1-story, frame and stucco auditorium to seat 300 persons, forced air heating, concrete slab floor, composition roofing, interior wood paneling. ARCHITECTS: Hans Wallner, South Gate & Paul Duncan, Sherman Oaks. STRUCTURAL ENGINEER: W. M. Bostock, South Gate.

**RESTAURANT AND GARAGE.** Las Vegas, Nevada. Otto Westlake, Las Vegas, owner. 1-story, composition roof, asphalt tile floor, gas space heaters, air conditioning, insulation, plaster, plate glass, 2-baths, \$15,000. ARCHITECT: John Replogle, Las Vegas.

**AUDITORIUM.** Phoenix, Arizona. Phoenix Union High School and Junior College District, Phoenix, owners. New auditorium for West Phoenix High School, \$266,900. ARCHITECT: H. H. Green, Phoenix. GENERAL CONTRACTOR: Womack Construction Co., Phoenix.

**OFFICE BUILDING.** Albuquerque, New Mexico. Albert G. and John Simms, Albuquerque, owners. 12-story, office building with basement, demolition, excavation, concrete waterproofing, masonry, plastering, acoustical treatment, mail chute, passenger elevators, hydraulic freight elevators, plastic skylights, painting, glass, composition floor covering, aluminum sash, heating and air conditioning, electrical work, 132,000 sq.ft., \$2,000,000. ARCHITECTS: Max Flatow and Jason Moore, Albuquerque. GENERAL CONTRACTORS: Lembeck, Clough & King Co., Inc., Albuquerque, New Mexico.

**STORE AND DWELLINGS.** El Cajon, San Diego County. James H. Wells, El Cajon, owner. One store and two dwellings, 1-story with mezzanine, masonry construction, 4000 sq.ft., composition roof, slab and

asphalt tile floor, suspended heaters, air conditioning, glass doors, plaster, plate glass, steel sash, steel roof trusses, \$41,302. ARCHITECTS: Paderewski, Mitchell and Dean, San Diego. GENERAL CONTRACTOR: Rihar Construction Co., San Diego.

**COMMERCIAL BUILDING WITH APARTMENTS.** Corona Del Mar, Orange County. W. E. Fisher, Corona Del Mar, owner. Two stores ground floor, 4-apartments on second floor, 5300 sq.ft., composition roof, slab and oak floor, individual baths, ceramic tile in baths and kitchens, wall furnaces, plate glass, off street parking. STRUCTURAL ENGINEER: E. Zepelin-Sprince.

**DEPT. STORE AND OFFICE BLDG.** Las Vegas, Nevada. 2-story, 6 baths, composition roof, asphalt and rubber tile floors, forced air heat, air conditioning, elevators, glass doors, glass blocks, insulation, marble, ornamental iron, steel sash, ceramic tile. ARCHITECT: John Replogle, Las Vegas.

**PERMANENT FACILITIES STATE COLLEGE.** Long Beach. State of California, owner. Construction 8-buildings, reinforced concrete frame, pile foundations, composition roof, brick work, steel sash, cabinet work, acoustical tile, plaster work, metal stud partitions, ceramic tile and veneer, \$1,441,647. GENERAL CONTRACTOR: J. C. Boespflug Construction Co., Los Angeles.

**THEATER REMODEL.** Santa Rosa, Sonoma County. Roxy Theater Co., owner. Interior remodel, plastering, mill work, tile, plumbing, \$31,925. ARCHITECTS: A. A. & A. McKenzie Canting, San Francisco. GENERAL CONTRACTOR: Alired H. Hopper, Oakland.

**EDUCATIONAL BUILDING.** San Jose, Santa Clara County. First Baptist Church, San Jose, owner. 2-story concrete block and

frame, 60x140 ft., \$165,677. ARCHITECT: Donald Powers Smith, San Francisco. GENERAL CONTRACTOR: E. A. Hathaway, San Jose.

**HIGH SCHOOL ADDITION.** Sonoma, Sonoma County. Sonoma Valley Union High School District, Sonoma, owner. Frame and stucco addition of shop building and home economics building, \$229,972. ARCHITECT: John Lyon Reid, San Francisco. GENERAL CONTRACTOR: Rapp Construction Co., Santa Rosa.

**ADDITIONAL FACILITIES ORDNANCE PLANT.** Riverbank, Stanislaus County. Corps of Engineers, U. S. Army, San Francisco, owner. Awarded \$1,010,000 for additional facilities at the Riverbank Ordnance Plant. GENERAL CONTRACTOR: Swinerton & Walberg, San Francisco.

**NEW GYMNASIUM BUILDING.** Brentwood, Contra Costa County. Liberty Union High School District, Brentwood, owner. Reinforced concrete, frame const., \$237,700. ARCHITECT: Young & Lloyd, Albany. GENERAL CONTRACTOR: Floyd G. Borchardt, Stockton.

**MAPLE AVE. ELEMENTARY SCHOOL.** Sacramento. South Sacramento Elementary School District, Sacramento, owner. Frame and stucco, 7-classes, administration, kindergarten, toilets, \$204,260. ARCHITECT: Geo. C. Sellon, Sacramento. GENERAL CONTRACTOR: Chas. F. Unger, Sacramento.

**FOOTBALL FIELD & TRACK.** Vallejo, Solano County. Armijo Union High School District, Vallejo, owner. Grading, drainage, sprinkler system, turfing, \$40,847. ARCHITECT: Schmidt & Hardman, Berkeley. GENERAL CONTRACTOR: Watkins & Sibbald, San Anselmo.

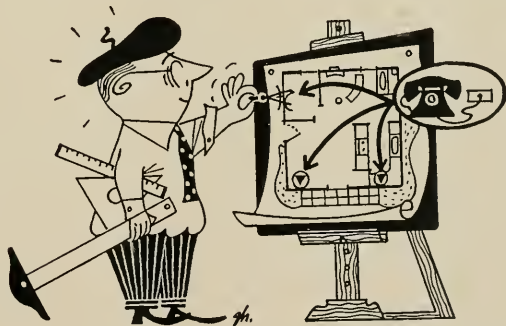

## Don't forget the 'master' touch of built-in telephone facilities

Your clients will appreciate the idea of concealed wiring and neat telephone outlets conveniently located to take care of their present and future telephone installations and changes. Wise home-owners today know the advantages of low-in-cost, high-in-satisfaction planned telephone facilities.

Just call Pacific Telephone's free Architects and Builders service. We'll gladly help you plan telephone facilities for greater beauty tomorrow in homes you are building today.

*Put built-in telephone facilities in your plans*



**Pacific Telephone**



# IN THE NEWS

## NAMED CHAIRMAN ARIZONA HIGHWAYS

C. A. Calhoun of Mesa has been chosen chairman of the Arizona State Highway Commission by the members. He succeeds Louis Escalada of Nogales, whose term with the Commission has expired.

## ARIZONA ARCHITECTS WANT CAPITAL MOVED

Members of the Phoenix Chapter, A.I.A., recently suggested moving of the state capitol to Papago Park and building entirely new structures to house the state's government.

The recommendation is the result of legislative action which provided for a committee of four architectural firms to "study the state's needs in this direction" and make a report.

The committee reports costs of remodeling present facilities would be comparable to building a complete new building, and that an entirely new venture would better provide for the state's future growth and development.

## COURT HOUSE ADDITION

Architect Robert Keeney of Medford, Oregon, has completed drafting plans for an addition to the Siskiyou County Court House in Yreka, California.

Plans call for a 2-story, with basement, addition of reinforced concrete. Estimated cost is \$181,290.

## CHEWING GUM FACTORY PLAN

The William Wrigley, Jr., Company of Chicago, recently announced revised plans were being drafted for construction of a new \$3,000,000 manufacturing plant in Santa Cruz, California.

Nelson P. Rice of Los Angeles, Associate Architect for the project and representing Architect Victor L. Charn, Chicago, announced the new building will be of 1 and 2-story, reinforced concrete construction and will contain 147,000 sq. ft.

Facilities are being provided for general offices, cafeteria, hospital, locker rooms, warehouse and manufacturing area.

## PACOIMA JUNIOR HIGH SCHOOL

Architects William Glen Balch and Louis L. Bryan are designing a 1600 student Junior High School to be built in Pacoima (California).

The new school will comprise twenty-one standard classrooms, administration, health and counseling units, and will cost an approximate \$2,168,000.

## ORANGE COUNTY BUILDING RECORD

Rural Orange county construction set an all time record of \$30,219,011 during 1952, a 54% gain over the previous year's mark, according to a report by Charles W. Donahue, county Building Inspector.

Even greater activity for 1953 was predicted by Donahue.

## HOME OWNERSHIP IN CALIFORNIA

The U. S. Census Bureau reports California has a home ownership of 54% out of a total dwelling survey of 3,177,406.

The five states reporting the highest per-

centage of home ownership were: New York, California, Pennsylvania, Illinois and Ohio, in that order.

## NEW MEDICAL OFFICES

Architect Stewart S. Granger was the designer of a new medical building recently opened in Hollywood.

Cost of the project was \$200,000.

## ARIZONA MILITARY EXPANSIONS

The Los Angeles District Office of the Corps of Engineers, U. S. Army, has announced proposed expenditures of \$42-million on the expansion of Arizona military installations during the first half of 1953.

Projects are part of a \$100-million expansion program being undertaken in Arizona, California and Nevada.

## YOUNG ARCHITECT WINS NATIONAL AWARD

Architect Charles W. Jones, Jr., Los Angeles, was awarded first place in a nationwide competition for designs of bathrooms, kitchens and utility rooms.

Jones, a graduate of the University of Southern California, was awarded a \$3000 check for his design of a bathroom for homes costing \$25,000 or more. The award was made by George C. Perry, Southern California manager for the Crane Company, sponsors of the contest.

## ELEMENTARY SCHOOL TEHAMA COUNTY

The Antelope Elementary School District, near Red Bluff, Tehama county, will construct a new Elementary School in the immediate future, according to Clayton Kantz of Redding who is architect for the project.

## COMBINATION GARAGE AND OFFICE BUILDING

The architectural firm of Carl I. and John C. Warnecke, Oakland, are preparing preliminary drawing for the construction of a 10-story and basement combined office and garage building in Oakland.

The basement and first three floors of the structure will be devoted to use as a garage and the seven upper floors will be designed for office use. Estimated cost of the project is \$3,000,000.

## SITE PURCHASED FOR OFFICE

The Prudential Life Insurance Company of Los Angeles has announced the purchase of a site in Menlo Park, San Mateo county, upon which will be built a new office building.

Two acres have been acquired at the corner of Linfield Drive and Homeward Place for the development.

## ARIZONA STATE COLLEGE

Kemper Goodwin, Tempe architect, has been authorized by the Board of Regents of the University and State Colleges to draw plans for a \$1-million Memorial Student Union Building and a dormitory on the Arizona State College at Tempe.

Alumni secretary Jim Creasmen, campaign director for the building fund, reports necessary funds are almost available.

## McLANE RESIGNS BUREAU OF ROADS DISTRICT

G. L. McLane, district engineer of the U. S. Bureau of Public Roads for Arizona since 1929, retired from office recently. He is succeeded by Baird M. French who

comes to Arizona from Seward, Alaska, where he directed public roads work for four and a half years as district engineer for the territory.

## UNION OIL NEW OFFICE BUILDING

Officials of the Union Oil Company, Los Angeles, recently announced plans for the construction of a new office building in Fresno, California.

Wm. Hastrup, Fresno, is the architect.

## ADDITION TO HOSPITAL

Architect Edward D. Cerruti of Oakland has completed working drawings for the construction of a new Administration Building for the Fairmont Hospital in San Leandro.

According to Alameda county officials the new addition will cost about \$270,000.

## NEW CHURCH FOR CONCORD

The Queen of All Saints Parish in Concord, California, is building a 800 seating capacity church, according to a recent announcement by the Roman Catholic Archbishop of San Francisco.

Vincent G. Raney, Architect of San Francisco, is designing the building which is to be of reinforced concrete with wood roof trusses, and will cost an estimated \$244,611.

## AIR FORCE CHAPEL

The U. S. Corps of Engineers, Sacramento, recently authorized construction of a new Air Force Chapel at the Beale Air Force Base, near Marysville.

Contract of \$140,765 was awarded to Chapek, Dorville, Gallino and Kohler of Sacramento.

## ARCHITECT SELECTED

The Napa Elementary School District has commissioned Architect Wm. Corlett of San Francisco, to draw plans and specifications for the construction of a new elementary school building to be built in the City of Napa.

## AMERICAN TRUST BANK BUILDING

Architect Harry J. Devine, Sacramento, is completing working drawings on a new branch bank building to be built by the American Trust Company at Alhambra and Broadway, Sacramento.

Estimated cost of the one-story, reinforced concrete, building is \$150,000.

## HIGH SCHOOL SWIMMING POOL

The Recreation Department of the City of Oakland recently announced the selection of Architect Irwin M. Johnson to draw plans and specifications for the construction of a new swimming pool and bath house at the Oakland High School.

Associate Architect on the project is William C. Helm, also of Oakland.

## ARCADIA GLASS DOOR PRODUCT APPROVED

Architects and builders report a favorable reception of the new Arcadia sliding glass doors, used in homes and commercial installations, which operate on a "bottom-rolling" principle and a screw driver is the only tool necessary in making adjustments of door alignments.

Specially designed mechanism supporting rollers makes possible this easy adjust-

## CLASSIFIED ADVERTISING

Will Bring Results

—USE—

## ARCHITECT and ENGINEER

68 Post St. San Francisco

### STATIONERY SCHOOL & OFFICE SUPPLIES

Printing Engraving  
Announcements

### CENTER STATIONERY

468 McAllister  
San Francisco UN 1-3703

## MULLEN MFG. COMPANY

BANK, STORE AND OFFICE  
FIXTURES—CABINET WORK  
OF GUARANTEED QUALITY  
CHURCH SEATING

Office and Factory  
60-80 RAUSCH ST., Bet. 7th and 8th Sts.  
San Francisco  
Telephone UNDERhill 1-5815

*Fine*  
**ENGRAVINGS**



**POOR  
RICHARD**

PHOTO ENGRAVING CO.  
220-324 COMMERCIAL STREET  
SAN FRANCISCO, CALIF.

ment without removing door from installation, and Arcadia engineers report that adjustment is "an operation simple enough for the woman of the house to undertake."

### SCHOOL BONDS ARE VOTED

Voters of the San Mateo Elementary School District of San Mateo county recently approved the issuance of \$2,000,000 in school bonds. Funds are to be used in construction of new elementary schools and in making additions to present elementary school facilities.

### LAS VEGAS PLANS NEW SPA HOTEL

Walter R. Stutz and Nate Rosenberg, San Diego business men, and Mrs. Lillian Woods, present owner of the Desert Spa Motel in Las Vegas, Nevada, have formed a corporation and plan to build a new hotel on the site of the present motel.

The new hotel, known as the Desert Spa Hotel, will contain 250 rooms, casino, night club, and swimming pool.

Estimated cost in \$3,500,000.

### PASADENA APPROVES SCHOOL BONDS

Electors of the Pasadena School District recently approved a school bond issue of \$5,840,000, with funds to be used in the construction of new elementary school in the City of Pasadena.

A number of other school bond proposals submitted at the same time were rejected.

### ARCHITECT SELECTED

The architectural firm of Ponsrod & Price of Oakland, have been commissioned by the Belmont Elementary School District to draft plans and specifications for the construction of an addition to the Home View Elementary School.

The addition will comprise a 7-classroom, kindergarten and toilet room unit and will be of frame and stucco construction.

### SCHOOL BONDS APPROVED

Qualified electors of the Woodland Elementary School District, Yolo county, recently approved the issuance of \$246,000 in school bonds with funds to be used for the construction of two new Elementary Schools in the City of Woodland. The new buildings will be of frame and stucco construction.

Russell G. De Lappe of Berkeley, is the architect.

### HOTEL BUILDING FOR SAN MATEO

Walter W. Cribbins of San Mateo, recently announced plans for the construction of a \$1,500,000 hotel in San Mateo and applied for a zoning permit.

The contemplated new hotel building would be 7-stories in height.

### DETENTION HOME FOR MARYSVILLE

Architect Russell G. De Lappe of Berkeley, is drafting plans and specifications for the construction of a new Detention Home in Marysville, Calif. for the County of Yuba.

### SCHOOL BOND ELECTION

Qualified electors of the Elsinor School District of Riverside county, California, will vote on a proposal at an election May 15, to issue \$210,000 in bonds to finance construction of new school facilities.

Subscribe  
Now —

## ARCHITECT and ENGINEER

\$3.00  
Per Year

## DINWIDDIE CONSTRUCTION COMPANY

## BUILDERS

CROCKER BUILDING  
SAN FRANCISCO



## HERRICK IRON WORKS STRUCTURAL STEEL REINFORCING STEEL

18TH AND CAMPBELL STS.  
OAKLAND, CALIF.  
Phone GLencourt 1-1787

Phone GARfield 1-1184

## Thomas B. Hunter DESIGNER OF HEATING

AIR CONDITIONING  
VENTILATING AND WIRING  
SYSTEMS, MECHANICAL  
AND ELECTRICAL EQUIP-  
MENT OF BUILDINGS



41 SUTTER STREET  
ROOM 710

San Francisco California

## PITTSBURGH TESTING LABORATORY

### ENGINEERS AND CHEMISTS

Testing and Inspection of Concrete,  
Steel and Other Structural Materials

Design of Concrete Mixes

Offices in all principal cities

651 Howard St., San Francisco 5  
EXbrook 2-1747

## MATTOCK CONSTRUCTION COMPANY



### BUILDERS



604 MISSION STREET  
SAN FRANCISCO

## ARCHITECT and ENGINEER

Please enter my subscription for  
..... year.... My check in the  
amount of \$..... is attached.  
1 year . . . . \$3.00  
2 years . . . . 5.00

Name.....

City.....

State.....

## ABBOT A. HANKS, INC. Engineers & Chemists

INSPECTING — TESTING — CONSULTING  
CONCRETE • STEEL • MATERIALS  
CHEMICAL AND TESTING  
LABORATORIES

• RESEARCH AND INVESTIGATION •

TESTS OF STRUCTURAL MATERIALS  
DESIGN OF CONCRETE MIXES  
SHOP AND ERECTION INSPECTION OF  
STRUCTURES AND EQUIPMENT  
INVESTIGATION OF STRUCTURES  
AND MATERIALS  
TESTS AND INVESTIGATION OF  
FOUNDATION SOILS  
FIRE RESISTANCE AND INSULATION  
TESTS

624 Sacramento Street, San Francisco

## Index to Advertisers

ALLIANCE Engineer .....	38
ARCHITECTS Reports .....	40
BARRETT & HILP, Contractors .....	37
BY-CHEMICAL Products Co. ....	33
CAMBRIDGE Tile Mfg. Company .....	*
CENTER Stationery .....	49
CLAY Brick & Tile Association .....	5
CLASSIFIED Advertising .....	45
CLINTON Construction Company .....	38
CROCKER First National Bank .....	*
DINWIDDIE Construction Company ..	49
FORORDERER Cornice Works .....	37
GLADDING, McBean & Company ....	1
GOULD-Mersereau Co., Inc. ....	36
GREENBERG'S, M. Sons .....	34
HANKS, Abbott A., Inc. ....	50
HAWS Drinking Faucet Co. ....	30 & 31
HERRICK Iron Works .....	49
HOGAN Lumber Co. ....	38
HUNT, Robert W. Company .....	50
HUNTER, Thos. B. ....	49
IDEAL Cement Co. ....	Back Cover
JOHNSON, S. T. Co. ....	36
JUDSON, Pacific-Murphy Corp. ....	38
KRAFTILE Company .....	28
MARBLE Institute of America .....	*
MATTOCK Construction Co. ....	50
MICHEL & Pfeiffer Iron Works, Inc. ....	2
MOORE, E. H. & Son .....	33
MULLEN Mfg. Co. ....	49
OLSON, Leroy Co. ....	46
PACIFIC Coast Aggregates .....	29
PACIFIC Manufacturing Co. ....	39
PACIFIC Telephone & Telegraph Co. ....	47
PARKER, Steffens & Pearce .....	37
PITTSBURGH Testing Laboratory .....	50
POOR Richard Engraving Co. ....	49
PORCELAIN Enamel (Architectural Division) Publicity Bureau .....	35
REMILLARD-Dandini Co. ....	50
REPUBLIC Steel Corporation .....	39
SCOTT Company .....	50
SIMONDS Machinery Company .....	39
SMOOT-Holman Company .....	35
SUMMERBELL Roof Structures .....	34
TOLAND, C. E. & Son .....	27
U. S. Bonds .....	Inside Back Cover
UTILITY Appliance Corp'n .....	*
VERMONT Marble Company .....	39
WEST Coast Screen Co. ....	45

\*Indicates Alternate Months

## Scott Company

HEATING • PLUMBING  
REFRIGERATION



San Francisco  
Oakland  
San Jose  
Los Angeles

## FOR ADVANCE INFORMATION

ON  
BUILDERS  
CONTRACTORS  
ENGINEERS

Get

ARCHITECTS  
REPORTS

68 Post St. Phone  
San Francisco DO 2-8311

## ROBERT W. HUNT CO.

ENGINEERS

INSPECTING TESTING

STRUCTURAL MATERIALS  
CONCRETE MIX DESIGN  
CHEMICAL ANALYSIS  
EQUIPMENT

PRINCIPAL CITIES  
UNITED STATES • EUROPE  
SAN FRANCISCO LOS ANGELES  
PORTLAND SEATTLE

## REMILLARD-DANDINI Co.

Brick and  
Masonry Products



400 MONTGOMERY STREET  
SAN FRANCISCO, CALIF.



# ARCHITECT AND ENGINEER

ARCHITECTURAL INGENUITY IN HOME



ARCHITECT KEITH C. WOOLLEN, Longview, Washington

**MAY**

**1953**

CIRCL-LITE CX-1000S

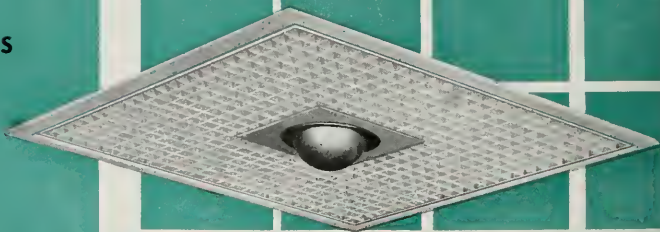

SKYLIKE

GOOD SCHOOL LIGHTING ... **MEANS** ...

- ... intensive research covering the seeing task.
  - ... quality and serviceability of the equipment.
  - ... engineered and designed to accomplish the desired results—high-test illumination standards.
- The units illustrated have passed the rigid test.

CIRCL-LITE—incandescent, with low brightness, for critical seeing task in class or office.

SKYLIKE—giving controlled incandescent illumination for many types of schoolrooms.

COLLEGIATE—proven adaptability where fluorescent lighting is desired.

No Schoolroom Can Afford To Be Without Good Light

**patterned for school lighting**

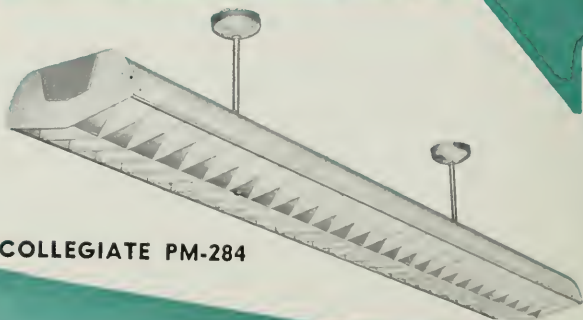

COLLEGIATE PM-284



ILLUMINATION EQUIPMENT, INGLEWOOD, CALIFORNIA  
BRANCH OFFICE AND WAREHOUSE SAN FRANCISCO  
SALES OFFICES IN MOST PRINCIPAL CITIES

# ARCHITECT

Vol. 193 No. 2

# AND ENGINEER

ARCHITECTS' REPORTS—Published Daily

**EDWIN H. WILDER**  
Editor

**J. WELLS HASTINGS**  
Contributing Editor

**PROF. LELAND VAUGHAN**  
Landscape Architecture

**JOHN A. BLUME**  
Structural Engineering

**MICHAEL GOODMAN**  
Planning

**JOHN S. BOLLES, A.I.A.**  
Book Reviews



## COVER PICTURE

A HOUSE  
TO FIT

By Architect  
Keith C. Woollen

Designed by the architect for Mr. & Mrs. Melvin C. Rooney and family, to fit an odd shaped summer home site on the Coweeman River near Longview, Washington.

Complete details and photographs on page 14.

**ERNEST McAVOY**  
Advertising Manager

*ARCHITECT & ENGINEER*  
is indexed regularly by  
*ENGINEERING INDEX, INC.*

## Contents for

# MAY

EDITORIAL NOTES . . . . .	.....
NEWS & COMMENT ON ART . . . . .	.....
THE AMERICAN INSTITUTE OF ARCHITECTS - 85th ANNUAL CONVENTION . . . . .	.....
Seattle, Washington	
POLICE FACILITIES BUILDING, Los Angeles, California . . . . .	.....
Associated Architects, Welton Beckett, F.A.I.A. and J. E. Stanton, A.I.A.	
PARKROSE GRADE SCHOOL, Multnomah County, Oregon . . . . .	.....
Annand & Boone, Architects & Engineers	
BENT THE HOUSE TO FIT THE SITE, Longview, Washington . . . . .	.....
Keith C. Woollen, Architect. Irving C. Eggimann, General Contractor.	
A FARM HOUSE IN THE DELTA COUNTRY OF THE SACRAMENTO RIVER, Clarksburg, California . . . . .	.....
Mr. & Mrs. James M. Marshall, Owners. W. R. Yelland, A.I.A., Architect.	
TILT-UP CONCRETE CONSTRUCTION - CONTINENTAL CAN COMPANY . . . . .	.....
Pittsburg, California	
A. I. A. ACTIVITIES . . . . .	.....
WITH THE ENGINEERS . . . . .	.....
PRODUCERS COUNCIL PAGE . . . . .	.....
Edited by Phil Brown, Otis Elevator Company	
BOOK REVIEWS, Pamphlets and Catalogues . . . . .	.....
ESTIMATOR'S GUIDE, Building and Construction Materials . . . . .	.....
ESTIMATOR'S DIRECTORY, Building and Construction Materials . . . . .	.....
BUILDING TRADES WAGE SCALES, Northern, Central & Southern California . . . . .	.....
CLASSIFIED ADVERTISING . . . . .	.....
CONSTRUCTION CONTRACTS AWARDED and Miscellaneous Data . . . . .	.....
IN THE NEWS . . . . .	.....
INDEX TO ADVERTISERS . . . . .	.....

ARCHITECT AND ENGINEER (Established 1905) is published on the 15th of the month by The Architect and Engineer, Inc., 68 Post St., San Francisco 4; Telephone EXbrook 2-7182. President, K. P. Kierulff; Vice-President and Manager, L. B. Penhorwood; Treasurer, E. N. Kierulff.

Los Angeles Office: Wentworth F. Green, 439 So. Western Ave., Los Angeles 5; Telephone DUNKirk 7-8135.

Entered as second class matter, November 2, 1905, at the Post Office in San Francisco, California, under the Act of March 3, 1879. Subscriptions United States and Pan America, \$3.00 a year; \$5.00 two years; foreign countries \$5.00 a year; single copy 50c. ARCHITECTS' REPORTS are published daily from this office, Vernon S. Yallop, Manager, Telephone DOuglas 2-8311.





# EDITORIAL NOTES

## ARCHITECTS BUSY

Architects throughout many parts of the nation are working overtime these days in an upswing of building activity which tops even last year's record high, according to a recent survey conducted by The American Institute of Architects, national association representing the architectural profession of America.

Current work in architects' offices, which reflects over-all conditions in the building industry, is up fifty-five plus on the Pacific Coast with substantial increases also being shown in other sections of the country.

Especially good news to many school districts is the report that last year's much publicized bottle neck in the nation's school building program—due largely to shortages in structural steel—seems to be eased. Without exception, schools topped the list as the most active building type. Also high is commercial building, the long pent-up demand for which has finally been turned loose.

It is interesting to note that defense jobs are relatively far down the list percentagewise, although schools, houses, and other community facilities required as the result of military, atomic or defense connected installations, keep many architects fully occupied.

At least some of the new high in building is due to increased supplies of steel, copper, and aluminum which, until recently, have been in short supply and subject to government control. With few exceptions these vital materials are now readily obtainable on the open market with supplies at or near normal levels.

\* \* \*

*The tax bite on a \$2,000 automobile is \$614.00. Without taxes you could buy the car for \$1,386.00.*

\* \* \*

## ECONOMIC EDUCATION

It is easy to find persons who want to do more and more things through government help, through centralized control, and by taking responsibility away from the individual. It is easy to emphasize the "popular" side of these public questions, to look at only the ideal goals.

But those who question easy "solutions" in these directions often find their motives questioned merely because they insist on taking the long view, looking at the problems as a whole and pointing out the complicated interrelations.

Those who are committed to the free, voluntary approach to our problems, through a free competitive economy, have not always been able to make

a persuasive case for their views. An important reason for this lack is an inadequate grasp of economics.

Mr. Lemuel R. Boulware, Vice President of the General Electric Company, who has thought about this problem deeply, puts it this way: "I believe it is clearly the obligation of business and professional leaders to **learn**—and teach—**economics**, and do so as a matter of self-preservation, not only for their businesses and professions, but for everything else they hold dear for themselves and their fellow citizens . . . the great need is, first to get management to go on to the more advanced economics befitting their responsibilities and, second, to find a way to interest our 100 million adults to join voluntarily in discussion groups not as a favor to their employer but on their own time as a good citizenship duty on their part."

Economics must be taught as a method of analysis, as a help to stating convincingly the implications of the choices we can make between methods for attaining our goals.

\* \* \*

*The march of science with its constant production of new and better materials has made business monopoly more and more difficult, and less and less important.*

\* \* \*

## RAGS TO RICHES

Richard L. Bowditch, a seacoast New Englander who earned his first money as a trapper-boy in a West Virginia coal mine some thirty-years ago, was recently elected president of the Chamber of Commerce of the United States by the board of directors.

Born in Massachusetts, the great-grandson of the inventor of the Bowditch navigation tables which are still used by the U. S. Navy, he started his business career in a coal mine because it was the only job he could find. Earlier the lure of the sea had taken him across the Pacific for an eight-month tour of Japan, China, Korea, and India. Arriving at St. John, New Brunswick, with \$8 in his pocket he had to appeal to a brother for funds to get home.

He liked his work and was soon promoted to a track-laying job; later to a job of hand-loading coal, and then to running a mine locomotive. After a year or two a surface job was taken and then one with the sales department of the C. H. Sprague and Sons Co., a firm which mines, ships and distributes coal and oil, and the Sprague Steamship Co., both of Boston.

Today Bowditch is president of the Sprague firms.

# NEWS and COMMENT ON ART



## **M. H. deYOUNG MEMORIAL MUSEUM REOPENS CENTRAL WING EXHIBITS**

The Central Wing of the M. H. deYoung Memorial Museum, Golden Gate Park, San Francisco, has been reopened after being closed for remodeling of twenty galleries.

Additional hanging space has been provided and smaller art objects have been removed to the corridors to be displayed in built-in wall cases effectively lined and illuminated. Monk's cloth gallery walls have been replaced by painted plaster surfaces, and hardwood floors installed in many of the galleries.

## **CITY OF PARIS**

The Rotunda Gallery of the City of Paris, San Francisco, under the direction of Beatrice Judd Ryan, is offering the Twelfth Annual Pacific Coast Ceramic Exhibition and Sale of Sculpture and Pottery during the month of May.

The exhibition is sponsored annually by the City of Paris, and is organized each year by Beatrice Judd Ryan for the artists of the Pacific Coast. Each artist is asked to submit from four to six entries which are for sale and eligible for prizes.

The Jury of Selection for this year's event comprises: Whitney Atchley, Mary Erckenbrack, Ruby O'Burke, Antonio Prieto, Vivika, and Audrey Evans, acting director.

## **CALIFORNIA SCHOOL OF FINE ARTS**

The Albert M. Bender Memorial Exhibition, commemorating the role of Albert M. Bender in establishing a community of understanding between artists and business men of San Francisco, is being shown in the Gallery of the California School of Fine Arts, 800 Chestnut Street, San Francisco.

Winners of the Albert M. Bender "Grants-in-Aid", in the fields of painting and sculpture, literature and photography will exhibit representative samples of their work. The exhibition will remain on public display until June 1st.

## **FRANK LLOYD WRIGHT EXHIBITS MODEL BRIDGE**

A sixteen foot model of the Southern Bay Bridge Span designed by Frank Lloyd Wright has been placed on exhibit at the M. H. deYoung Memorial Museum, Golden Gate Park in San Francisco.

The model built by architectural students under the direction of Aaron Green, represents an advanced design in bridge construction of reinforced concrete. It is of "butterfly wing design" and earthquake proof.

## **SAN FRANCISCO MUSEUM OF ART**

The San Francisco Museum of Art, War Memorial Building, Civic Center, is presenting the following calendar of exhibitions and events for May:

EXHIBITIONS—Etchings by John Marin; the Gifford Beal Retrospective Exhibition; Paintings by Loren MacIver and I. Rice Pereira; 17th Annual Drawing and Print Exhibition of the San Francisco Art Association; Contemporary Japanese Prints and Pottery; Designer-Craftsmen, U.S.A.—1953; and Four Sculptors of the West.

The Parkmerced Branch will feature an exhibition of Color in Prints, and an analysis of What Makes Art Work?

SPECIAL EVENTS include Concerts, Composers' Forum, Lectures, Lecture Tours of the Museum, Discussions, and Classes in Art for adults and children. Art classes include "Art for the Layman," "Sketch Club", "Painting Class" and the "Childrens Class". Adult and children's classes are also held at the Parkmerced Branch.

## **M. H. deYOUNG MEMORIAL MUSEUM**

The M. H. deYoung Memorial Museum, Golden Gate Park, San Francisco, under the direction of Walter Heil, offers a number of unusual exhibition in conjunction with the opening of the newly remodeled central wing and the French period rooms and special galleries, gifts of Roscoe and Margaret Oakes.

The Max Pollak Color Etchings, presented to the Museum, will open on May 12th; and the San Francisco Art Association Open Exhibition for Artist Members, and featuring Oils, watercolors, sculpture and graphics will open on May 22.

Classes in Art Enjoyment include "Modes of Representation," "Seminars in the History of Art", and the "Painting Workshop" for adults. Childrens Classes offer "Elements of Art", "Form in Art and Nature", and Picture Making.

Many permanent exhibitions in the fine and applied arts are shown, as are special exhibitions of art and culture. Lectures and Gallery tours are also offered.

# "A NEW COUNTRY—A NEW ARCHITECTURE"

## 85th CONVENTION

### THE AMERICAN INSTITUTE OF ARCHITECTS

SEATTLE, WASHINGTON—JUNE 15-19, 1953

The Program consistently adheres to the theme of the Convention, "A New Country—A New Architecture" in its subject matter, exploiting the development and resources of the great Northwest and the entire Pacific Coast.

#### PRELIMINARY PROGRAM

##### SUNDAY, JUNE 14

1:00 P.M.—10:30 P.M.—Registration starts.

##### MONDAY, JUNE 15

9:00 A.M.—Convention Registration continues

8:00 A.M.—Logging Camp Tour (return 6:00 P.M.)

2:00 P.M.—City Tour

2:30 P.M.—Boat Trip—Puget Sound and Lake Washington

##### TUESDAY, JUNE 16

9:00 A.M.—Registration continues  
(Delegates registration closes 12:30 P.M.)

9:45 A.M.—Opening Session of the Convention

12:30 P.M.—Honor Awards Luncheon

2:30 P.M.—Industrial Tours

2:30 P.M.—Seminar—"Woods—The Forest"

4:00 P.M.—President's Reception at the Rainier Club

7:00 P.M.—Students' Forum

8:00 P.M.—Modular Coordination Meeting

##### WEDNESDAY, JUNE 17

9:00 A.M.—Registration continues

9:30 A.M.—Chapter Problems Meeting  
Chapter Affairs  
Chapter Officers  
Chapter Editors

12:30 P.M.—Luncheon Seminar—"Oriental Influence on American Art and Architecture"

3:00 P.M.—Seminar—"Wood—Processing"

3:00 P.M.—Liturgical Arts Seminar

7:00 P.M.—Dinner Dance

##### THURSDAY, JUNE 18

7:30 A.M.—Scrapple Breakfast

9:00 A.M.—Registration continues

9:30 A.M.—Polls Open

9:30 A.M.—Second Business Session

12:30 P.M.—Luncheon Seminar—"Condensation in Buildings"

3:00 P.M.—Seminar—"Wood—Construction Uses"

3:00 P.M.—Ladies' Boat Trip

4:00 P.M.—Polls Close

6:30 P.M.—Cocktail Party as Guests of Washington State Chapter

8:00 P.M.—Banquet

##### FRIDAY, JUNE 19

9:30 A.M.—Final Business Session

12:00 Noon—Mount Rainier Tour

1:00 P.M.—Fellows Luncheon

3:00 P.M.—Embark for Alaska Tour

3:00 P.M.—A.I.A. Board of Directors—Organization Meeting

7:00 P.M.—A.I.A. Board of Directors Dinner

9:00 P.M.—Plane leaves on Hawaiian Tour

11:45 P.M.—Special Train, en route Home

#### PRODUCTS EXHIBITION

The exhibition of building products will open Tuesday morning and continue through Thursday between the hours of 9:00 A.M. to 6:00 P.M.

Supplementing the above will be four days of pre-convention meetings of the A.I.A. Board of Directors, the Association of Collegiate Schools of Architecture, the National Council of Architectural Registration Boards, and the Producers' Council.





# POLICE FACILITIES BUILDING

LOS ANGELES, CALIFORNIA

WELTON BECKET, F.A.I.A.

ASSOCIATED ARCHITECTS

J. E. STANTON, A.I.A.

AREA — 398,000 Square Feet

COST — \$6,142,548.00

The work of two outstanding Los Angeles architects recently proved that through good design and businesslike methods it is possible to save taxpayers money, in this case \$2,000,000, and at the same time present a functional and pleasing contemporary building.

The specific case cited is the Los Angeles Police Facilities Building designed by Welton Becket, F.A.I.A., and J. E. Stanton, A.I.A., Associated Architects. To the delight of the Board of Public Works, the low bid tendered, \$6,142,548, was more than \$2,000,000 under the proposed city budget for the structure.

Harold Nash, President of the Board of Public Works, highly praised the work of Becket and Stanton and expressed hope that other civic

buildings would be constructed at proportionately low cost.

The new police building itself will undoubtedly establish a precedent in civic planning and perhaps revolutionize law enforcement procedure throughout the country. The structure, which will be eight stories high, with a basement and covering a full city block, represents the first entirely functional approach to the physical problems of police administration.

Except for a few geographical patrol divisions, all the various departments of the municipal police department—now scattered among half a dozen different buildings often miles apart—will be brought together under a single roof, with the design of the building providing a closer integration

PLOT PLAN

1" = 80'

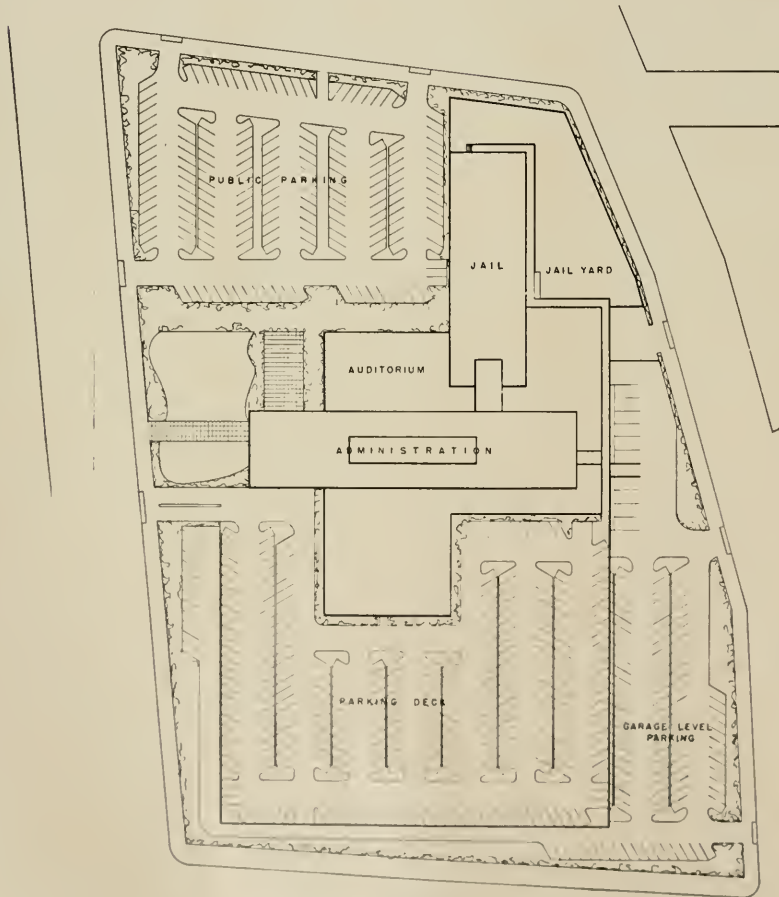

PLOT PLAN

between departments than ever before attained.

A combination ground and deck area will provide garage service and parking facilities for more than 850 police cars. Space is also available for invited public parking.

Underground squad rooms and lockers for the officers of the metropolitan, traffic and central divisions can be easily reached from the lower-level parking area. The basement will also contain assembly rooms for the officers.

On the first floor are the business offices, the information center, communications, traffic division, offices of the Police Commission, a completely equipped auditorium and stage for "show-ups" and a jail for initial booking procedures.

The felon prison and the Record and Identification Bureaus are on the second floor. The third floor will be occupied by the detective bureau.

The remainder of the building houses various police bureaus and business offices. The eighth floor will have an employee cafeteria and lounge.

The building itself is to be constructed of steel and lightweight concrete. All interior details and appointments will also be supervised by the architects.

According to architects Becket and Stanton, the building will have a total floor space of 398,000 square feet, and will be located on a Civic Center site already owned by the city, lying north of First street between Los Angeles and San Pedro streets and running through to Market street.

The Ford J. Twaits Company and the Morrison-Knudsen Company who jointly entered the lowest bid will be in charge of construction. The building is expected to be completed in two years.

### MAIN FLOOR PLAN

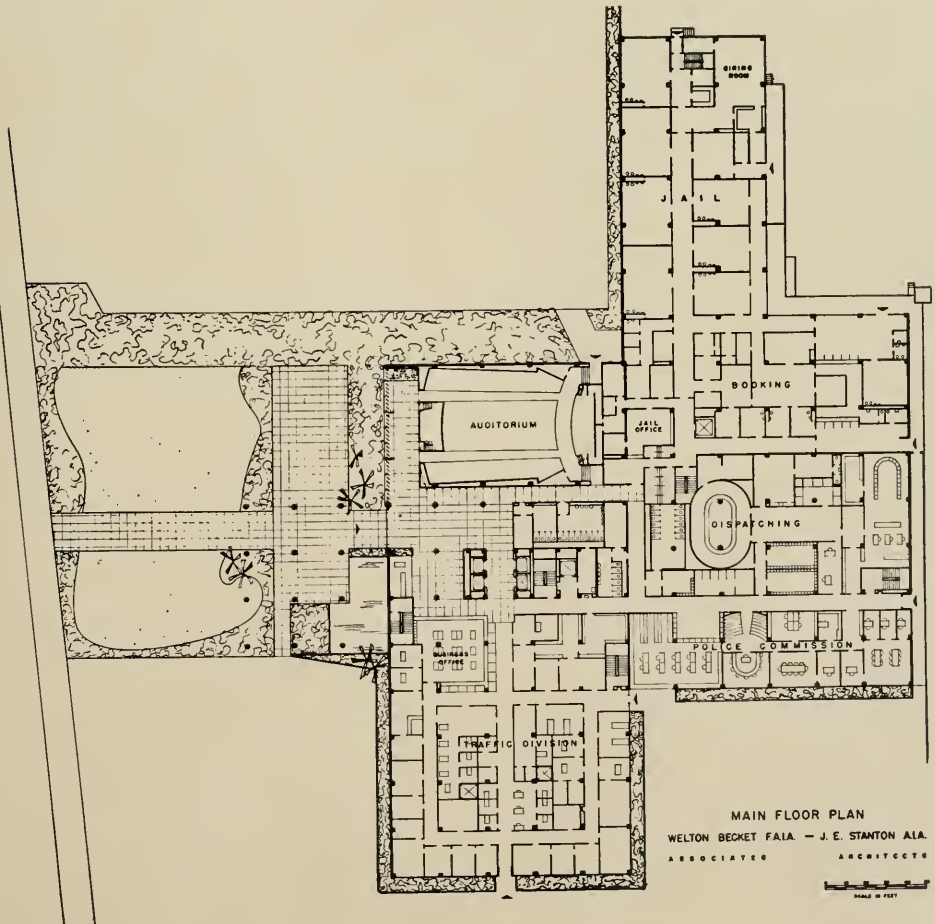



PARKROSE GRADE SCHOOL  
SCHOOL DISTRICT NO 3 MULTNOMAH COUNTY, OREGON  
ANNAND & BOONE ARCHITECTS & ENGINEERS



Student enrollment increased from 900 to 2400 in six years.

# PARKROSE GRADE SCHOOL

## MULTNOMAH COUNTY, OREGON

ANNAND & BOONE ARCHITECTS  
ENGINEERS

COST — \$9.11 Square Foot

The new Park Rose Elementary School which is part of School District No. 3 of Multnomah county, Oregon, is located in one of the more rapidly growing residential communities immediately East of the City of Portland, and this unique school building designed in the offices of Annand & Boone, Architects and Engineers of Portland, is attracting considerable attention among school authorities

throughout the nation because of the building's unorthodox use of space and economical construction costs.

The problem presented to the architect was to design an elementary school building which would meet an increase of student registration of from 900 pupils in 1946 to a present registration of more than 2400 pupils, and at the same time bear

**SIMPLIFIED  
CONSTRUCTION**

Concrete base and walks,  
extension of roof over walk  
for sun and storm protection,  
with location of windows  
to obtain a maximum of  
natural light with  
minimum glare.



in mind a continued growth of the community and at the same time keep within certain financial limitations. To meet this situation the Park Rose District has produced something entirely new and different in the way of an elementary school building, and many of the architectural and design innovations will be of interest to architects, school

boards and teachers, builders, and the taxpayer who is called upon to finance the construction of educational facilities.

Probably the best way to describe the new Park Rose School building is to visualize a series of matchboxes placed side by side and slightly staggered (Note illustration on page 13). Then if you

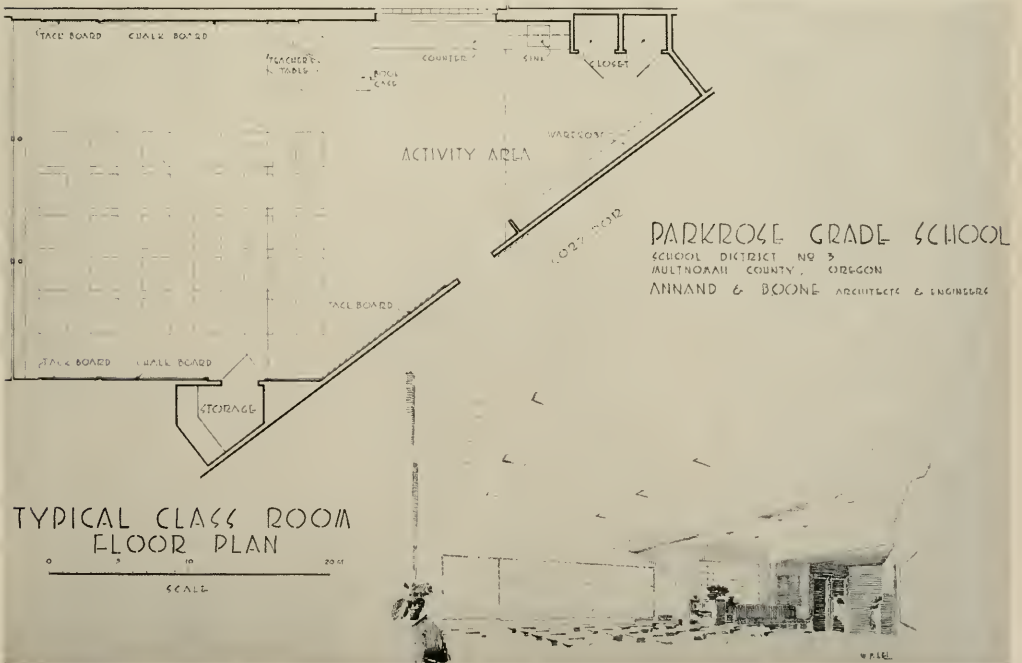



**Classroom as seen from work alcove, showing part of additional blackboard and bulletin board area. Glass blocks used on upper portion of windows.**

**Unique shaped classroom. Sink and children's work bench area are on diagonal wall of the left rear. Part of work bench lifted to teacher's height.**





# . . . PARKROSE GRADE SCHOOL

run a corridor down through the middle of the jigsawed box design you have the approximate arrangement of this school. This unique handling of corridor and classroom represents what is believed to be a maximum of space utilization and space economy in relation to the utility use of the structure.

The classroom that results from the "staggered matchbox" design is slightly triangular with the service-end or work alcove at the pointed end. More wall space and efficient use of closet space make for greater use of what is actually smaller floor area. While the classroom is slightly smaller in size than the conventional type room, its greater "use area" and reduced initial construction cost, together with the fact that more efficient use can be made of the corridor, makes the building desirable.

The illustration at the bottom of page 11, and the two pictures on page 12 show detail arrangements of the classroom. The top photograph on page 12 shows the interior as viewed from the point-end, or work alcove. Additional blackboard and bulletin board space is provided along the longer walls on both sides. The lower picture on the same page illustrates the point-end where sink,

counter, closets, wardrobes and book case are installed. This is the work area and can be easily used without interfering with the desk area. The teacher's desk or table, is located at a vantage point for use in supervision of students in either work area or while they are sitting at the desk.

The building has but one general utility room which has been designed to serve the purposes of a gymnasium, auditorium and cafeteria whenever the need arises. In addition to the "staggered" classrooms a conventional type primary wing has been included. Plumbing is provided for each room and to facilitate use of the outside play-grounds, entrances have been placed in each room.

The building is of reinforced concrete construction. Roof overhangs to form weather protection for the sidewalks in some of the areas, and glass blocks have been used over regular windows to provide more natural lighting and at the same time reduce glare. Heating and ventilating are of the newest design.

Objective of the architect has been to get more space use for the money spent and cost of the 16-classroom building was \$270,000, which figures at a square foot construction cost of \$9.11.

**Distinctive feature is wing of eight classrooms that are roughly triangular in shape, with corridor running diagonally through series of rectangles to form two rooms.**

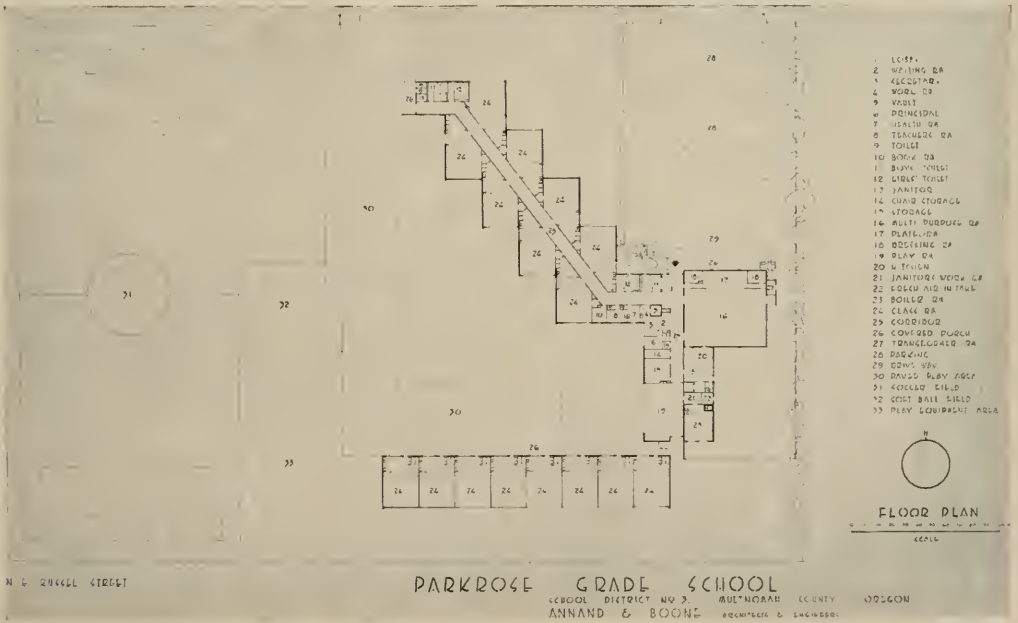



SUMMER HOME BENT TO FIT THE RIVER

# BENT THE HOUSE TO FIT THE SITE

LONGVIEW, WASHINGTON

KEITH C. WOOLLEN, Architect

IRVIN C. EGGIMANN, General Contractor

By **ARTHUR W. PRIAULX**

When you design a summer home to fit into one of the most spectacular scenic spots on Washington's beautiful, winding Coweeman River, view is everything. Architect Keith C. Woollen, of Longview, Washington, has come up with a rather extraordinary budget summer home for the Melvin C. Rooney family which is a tribute to his imagination and skill as a designer.

The site selected was in the bend of this lovely river ten miles east of Longview and Architect Woollen was charged with getting as much view visibility as possible from each window of the house. To solve the problem, he decided to bend the house to fit the river bend. The result is a

startling home of distinctive beauty and maximum utility and off-the-beaten-path floor plan.

A picture view of the river is had from every room, and some rooms afford two or more different vistas of this charming little river. The kitchen window overlooks the swimming hole, so Mrs. Rooney can watch her offspring while they are swimming. A sand beach is seen from the bedrooms. From the V-shaped living room a full and sweeping prospect of the full river bend is had.

Architect Woollen designed a summer dwelling which would blend into the woody character of the 100-acre Rooney tract. Exterior of the unique-shaped home is cedar boards and batten, finished

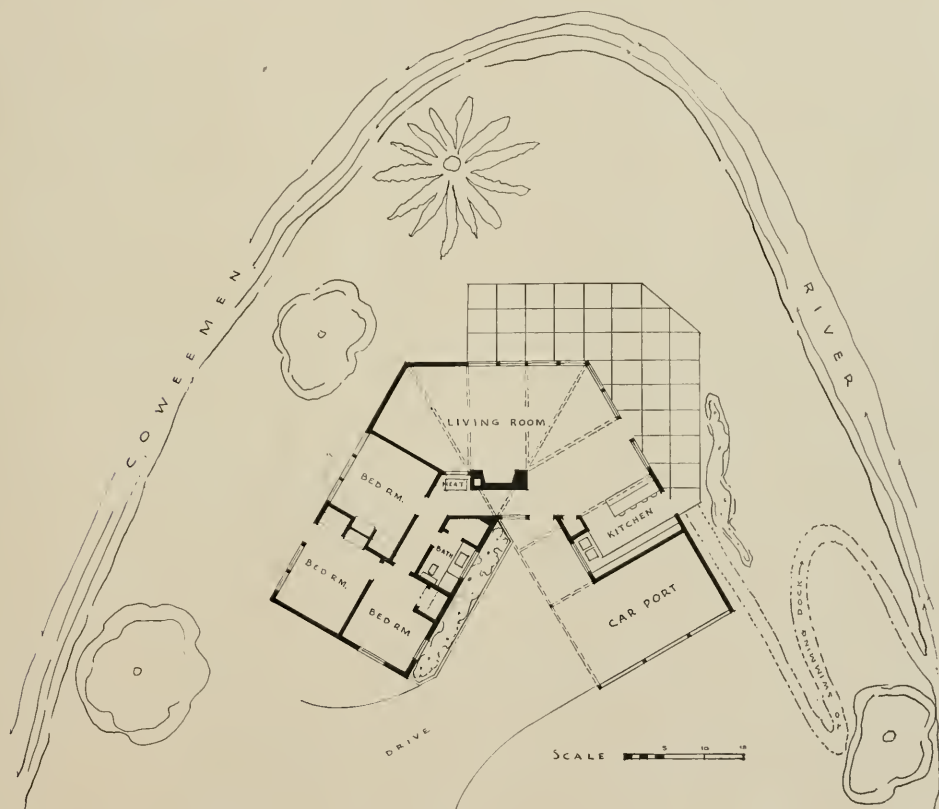

SUMMER HOME  
FOR  
MR. & MRS. MELVIN C. ROONEY  
ON COWEEMAN RIVER  
KEITH C. WOOLLEN, ARCHITECT  
LONGVIEW, WASHINGTON



## RIVER SITE HOME . . .

with two coats of stain to preserve the natural cedar coloring. Even the exterior doors have been finished in a blue-green, native woods color. The structure is a wood-casement and fixed-frame design.

To simplify construction problems, Woollen designed the two converging wings of the home in a nineteen foot, six inch width. The ceiling is supported throughout the living area in an economical and yet attractive manner. Four-by-ten-inch fir beams are arranged fan shaped, one edge supported on the fireplace at ceiling height and the other by the outer wall. The beams are left exposed in both living room and kitchen areas. A two-by-six fir decking forms the ceiling and the roof as well. Ceilings have been painted throughout the house. The beams have been left exposed in the three bedrooms.

The general plan of the owner and designer was to eliminate as much housekeeping work as possible. A concrete slab forms the floor of the home as well as the patio and carport. Carpeting has been used in living room and hall, but all other rooms have been finished in asphalt tile.

Space utilization is ingenious. In the 1050 feet of livable area has been designed three bedrooms and bath, a large living room and kitchen.

The five-sided living room is the central feature

of the home. On two sides of this unusual room are a solid twenty-eight feet of plate glass windows, six feet high, which afford a dramatic view of the Coweeman River. Four of the walls have been finished off in a vertical-grain fir panelling, a fifth wall is made up of a fireplace of Wilkinson stone (native Washington), from floor to ceiling. Around the corner from the fireplace is a snug, lounging area which adds to the charm, comfort and pleasant living of the family.

A novel pass-cupboard and bar serves as a wall between the living area and the cooking area. There is no door between the two areas of the home. The bar and pass-cupboard is really more of a mask or break than a wall. It is almost a part of the furniture for it houses storage cabinets on the living room side.

The kitchen is also finished in vertical grain fir panelling. Drainboards and cupboards are made of a composition material. On the kitchen side the pass-cupboard becomes a dining bar with a capacity for four. Dish storage space has been provided above this dining bar. The kitchen has also been equipped with modern conveniences, including a dishwasher.

So enamoured has the Rooney family become of their "summer" home that they live there much of the year. It is only ten miles east of Longview

**A Patio within sound of the River sheltered by friendly fir trees.**



*Photos  
by  
Jan Fardell*

**LOAFING  
CORNER**

**Of the Living Room tucked away by itself. A place for reflection, or dreaming, or snoozing on a summer's day.**



and their 100-acre, natural-woods area is a private deer park preserve where no hunting is allowed. Deer are everywhere. But, not even the owner hunts. Fishing is mighty good, too, and Coweeman river water is warm enough for swimming much of the year.

The three compact bedrooms were designed with a definite woods theme. Each has been finished in a different wood. One is in knotty pine, another in western hemlock and a third in western red cedar. In every case the walls have been finished with a clear rez to preserve the natural

**Looking Riverward from the fireplace wall into the Coweeman River.  
Homey, easy living is keynote of this summer dwelling.**





**DINING BAR**

Gives family spectacular view of the River from the kitchen side. Note how this serves dual purpose as break wall between living and kitchen areas.

**KITCHEN  
(below)**

Compact and easy to manage. Cabinets and fixtures are built of vertical grain fir, finished natural with a rez coating.





## RIVER SITE HOME . . .

grain of the wood and the distinctive coloring of the three western species.

Another interesting feature of the home is the entrance hall which opens off the inside of the U bend of the house. It serves the kitchen and living area and becomes as well a short hallway for the bedrooms.

Heating is provided by an oil-burning space heater, concealed behind the fireplace.

The living room is most spacious, with a thirty-two foot length. When you enter the living area from the hallway, the view is breathtaking. You get a sweeping and striking look at a woods and river wonderland. It is apparent that Architect Woollen has consciously utilized the natural beauty of this setting to a remarkable degree. Not a room in the house is without a view of the river and surrounding woods.

The bath has been built of plaster board and serves all three bedrooms and is fully plumbed.

Closets and storage space become walls between the master bedroom and the child's room. The bedrooms are small, but purposely so, because they require a minimum of upkeep and the throw rugs on the tile floor make housecleaning a small chore.

The feeling of living outdoors, accentuated by the nearness of the river and woods, is further heightened by the easy accessibility to the outdoors. Four doors, at strategic locations around the home gives easy access to almost any part of the home from outdoors. Doors open onto the river-side patio from both the kitchen and living areas. Another door opens on the river-side from the bedroom wing and the main entrance from the off-river side patio and lawn area makes access to the home easy from the carport.

An interesting feature of the carport is its dual purpose. In the hot summer months in the after-

(See Page 38)

**The Cedar Bedroom - the children's sleeping room, one of three finished in native woods.  
Other two are of hemlock and knotty pine paneled walls.**



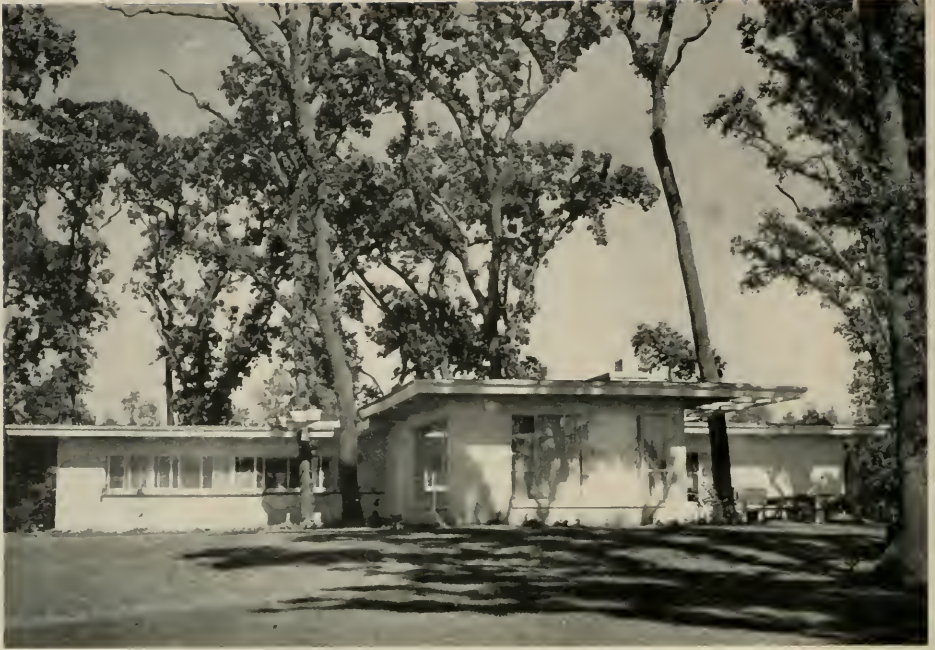

# A FARM HOUSE IN THE DELTA COUNTRY OF THE SACRAMENTO RIVER

CLARKSBURG, CALIFORNIA

MR. & MRS. JAMES M. MARSHALL, Owners  
ARCHITECT: W. R. YELLAND, A.I.A.

The design of this house came as a hurry up job. The energetic young farmer, James Marshall, having just sold his home and farm was ready in a very few days to pick a building site on another farm, move dirt, and get a new house under way. Such activity is pleasant to any architect, though it does present a problem to keep one blue print

ahead of those that were to put the building together.

The location of this house in the delta region of the Sacramento River in northern California meant that it must be raised to a height to form drainage, and be oriented to make the most of the sun and shade, cross ventilation, and shelter from the

# . . . A FARM HOUSE

winds. Too, there was a problem of getting a house of the right size, and a shape that was pleasant, in a grove of many beautiful trees, all of them seeming too choice to remove.

Once our plan was formed and marked out among the trees, a spread footing was set on the surface of the ground, the walls of which were raised about three feet in height. A long, gentle slope of earth was started from far out in the fields, graded to the height of the foundation. A fill was also made within the walls of the foundations. Heater ducts of terra cotta pipe were set in the fill as earth was moved in. Over the fill a concrete floor was laid, and the walls were ready to be set.

Economy being something of a watchword, the work thus far had been carried largely with farm equipment, manned by farm help, carefully guided and managed by the owner. From the concrete

floor up the walls were of cast blocks, with the exception of one long brick wall extending through the house from side to side. Some brick was used at the front entrance, and, as shown in the drawings and photograph, a considerable amount went into the raised hearth. The hearth extended from the fireplace to the end of the room, under the book cases, and across the end wall. The supply of both brick and blocks was within easy reach, some eighteen miles away in the city of Sacramento.

As the house walls neared the ceiling line, the romance of the river was to extend to our building, even though the river was some miles away. An old river pier showed up in the structural part of the ceiling. These heavy timbers were laid across the walls over which the ceiling and flat roof were laid. Roof and heavy pier timbers may be seen

FLOOR  
PLAN  
and  
PLOT  
AREA

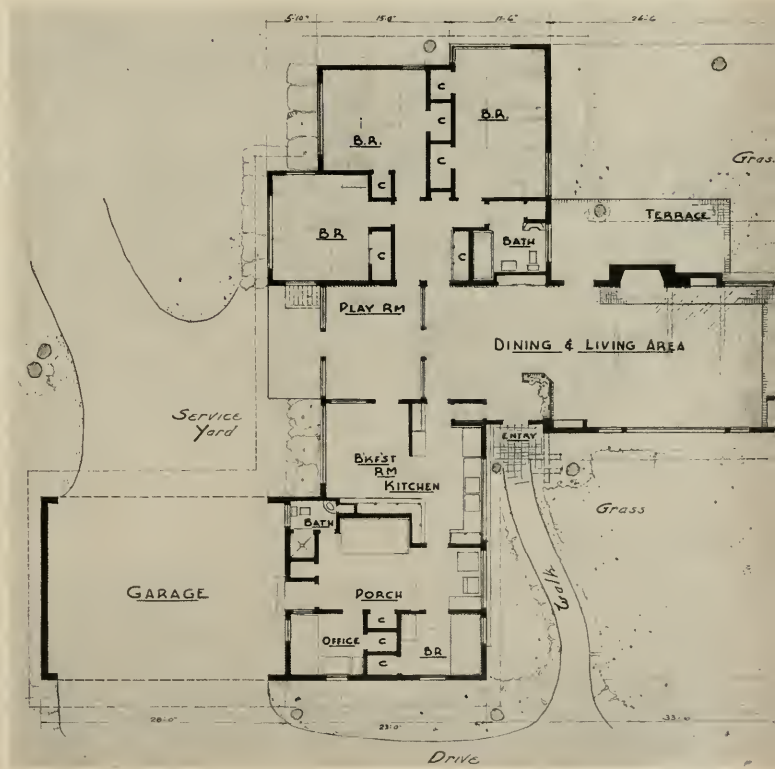



## A FARM HOUSE . . .



**SCREEN** - forming shelter at front entrance.

extending well out over the walls to give window and door protection.

The ceiling material came from a mill in the nearby city of Stockton. It was a cedar lumber largely used by the mill in the manufacture of lead pencils. The material, as brought to the job, was a heavy tongue and groove planking some 3" thick and 6" wide. This stock of material was laid out on the floor, where it was painted five different pastel shades of soft colors. It was then laid diagonally in pattern on the upper side of the large supporting timbers from the pier. These timbers had been colored a gray-blue at the time they were set in place. One wonders now, looking up at this subdued, gay ceiling, just how many pencils might be made out of that much lumber.

The salmon-colored brick wall running through the house forms one wall of the living and dining area and the play room. A glass partition set in a chrome metal frame of dull silver or pewter color makes the division in this part of the house, and

**FRONT ENTRANCE** - Showing large timbers extending over doorway to form canopy.  
Timbers were taken from Sacramento River pier.



leaves the brick wall visible for its entire length.

The metal used in the frame partition appears also in a hood for the fireplace, in the buffet, and in the screen at the front entrance. This metal against the brick as selected, and the fresh-colored ceiling, make a mellow and interesting room, not modern exactly, but certainly removed from the orthodox standards for room finish.

The screen at the entrance we think is a distinctive feature that has done much for the living area. It was built as a shelter against weather, and to afford some seclusion for people arriving at the house. It is a brick wall up some 4'6" from the floor, with a metal planting box set in the top, with glass above that, in all about seven feet high.

Walls other than glass or brick are almost uniformly of the natural building block throughout the house, kitchen, bedroom, and bath alike. Color in the form of both water and oil paints has been applied to the block walls. The treatment of color and the forthright type of construction naturally were a great factor in keeping costs to a minimum.

#### CEILING BOARDS

Are done in color.

Laid diagonally  
over supporting  
river pier  
timbers.



**FIREPLACE** - with chrome metal hood. Raised brick hearth skirts along base of brick wall and across end of the living room.





*Photos  
Courtesy  
By-Chemical  
Products  
Company*

**CONTINENTAL CAN COMPANY . . . Pittsburg, California**

# TILT-UP CONCRETE CONSTRUCTION CONTINENTAL CAN COMPANY

**PITTSBURG, CALIFORNIA**



When J. K. Doolan, president and J. W. Komes, vice-president of the Bechtel Corpn. planned the use of precast concrete panels for the construction of the new Continental Can Company's factory in Pittsburg, California, they also chose Roland Cowles as job superintendent because of his wide experience in the construction industry, and particularly because of his extensive experiments during the past two years with various compounds to be used as bond breakers when concrete panels are cast.

**Concrete Slab being lifted from  
low-bed truck into wall position.**



In his preparation for the panels, Cowles poured the floor and trowled it smooth. The entire surface of 840 ft. x 360 ft. was then treated by brush and spray with Thompson's Water Seal. The concrete panels, some of which weighed seventeen tons, were then poured directly on the treated floor. When the cranes lifted them there was no bond whatever only a clean, very smooth surface on the underside of the panels. This method speeded construction, according to Cowles, as there was no need for long curing periods or the necessity for cleaning before painting. Both of these factors are also a major item in maintaining construction schedules.

Design of the new plant represents the most modern conception of a large manufacturing plant where objectives include the functional operations of a building, harmonious appearance with the surrounding area, and employee conveniences.

Large windows above center floor sections, and use of much glass in side walls, assures a maximum in natural lighting. Large steel trusses are used to obtain minimum floor obstruction, and the general appearance is in keeping with western industry industrial design.



**Roland Cowles, Bechtel Corp'n and Carl W. Gott of Continental Can Co. standing by 17-ton tilt-up panel. Inset - Carl W. Gott and Roland Cowles beside smooth panel cast on concrete floor. (See photo below.)**

**Completed tilt-up panels lying on concrete floor that have been treated with Thompson's Water Seal. Panels are ready for moving and installing in permanent position in building.**



# American Institute



# of Architects

Glenn Stanton, President  
Kenneth E. Wischmeyer, 1st Vice-president  
Norman J. Schlossman, 2nd Vice-president  
Clair W. Ditchy, Secretary  
Maurice J. Sullivan, Treasurer

National Headquarters—  
1741 New York Avenue, N. W.  
Washington, D. C.  
Edmund R. Purves  
Executive Secretary

#### Arizona Chapter:

Lew Place (Tucson), President; Ralph Haver (Phoenix), Vice-President; Fred O. Knipe (Tucson), Secretary; James W. Elmore (Phoenix), Treasurer. Secretary Offices, 1324 E. Lester St., Tucson.

#### Coast Valleys Chapter:

Kurt Gross, President; Harold Ahnfeldt, Vice-President; Frank C. Treseder, Secretary; Jerome Kasavan, Treasurer. Directors, Hollis Logue and Gifford Sobey. Offices, 82 S. 3rd St., San Jose.

#### Central Valley of California:

John W. Bomberger, President; Nicholas Tomich, Vice-President; Albert B. Thomas, Secretary; Ted de Wolf, Treas.; Gordon Stafford, Director; Alternate to CCA, Silvio Barovetto; Sec. Office 718 Alhambra Blvd., Sacramento.

#### Colorado Chapter:

James M. Hunter, President, 2049 Broadway, Boulder; Casper F. Hepler, Secretary, 1659 Grant Street, Denver 5.

#### East Bay Chapter:

Malcolm D. Reynolds, President; Donald Hardison, Vice-President; John Lloyd, Secretary; Ed Cerruti, Treasurer. Directors: Chester Treichel, Ira Beals, Cecil Moyer. Secretary's office: 1171 Solano Ave., Albany.

#### Idaho Chapter:

Frederick C. Hummel, President; Jack Woodmonsee, Vice-President; Jed Jones III, Sec.-Treas. Offices 1324 Idaho Street, Boise, Idaho.

#### Montana Chapter:

E. Edward Scowcroft, President (Billings); J. Van Teylingen, Vice-President (Great Falls); H. C. Cheever, Secretary-Treasurer. Secretary office, Bozeman.

#### Nevada Chapter:

Walter Zick, President, Las Vegas; Russell Mills, Vice President, Reno; Keith Lockard, Secretary, Reno; Directors Edward Parsons, L. A. Ferris, David Vhay, Reno. Office of President P. O. Box 2107, Las Vegas.

#### Nevada State Board of Architects:

Russell Mills, Chairman, Reno; Aloysius MacDonald, Secretary, Las Vegas; Edward Parsons, L. A. Ferris, Reno, and Richard Stadleman, Los Vegas, Members. Office, 309 S. 5th St., Las Vegas.

#### Northern California Chapter:

Albert R. Williams, President; Donn Emmons, Vice-President; William Corlett, Secretary; Bernard J. Sabaroff, Treasurer. Helen H. Ashton, Office Sec., Offices 369 Pine Street, San Francisco.

## SOUTHERN CALIFORNIA CHAPTER

Emphasizing the "Good Neighbor Policy" a recent meeting was devoted to Mexico's University City. A group of architects presented color slides and a report in the VII Congreso Pan Americano de Arquitectos which was recently held at University City in Mexico City. Taking part in the

program were Anthony Thormin, Kemper Nomland, Edward A. Fickett, Raphael Soriano, John Rex, Maynard Lyndon, and Carl Maston.

Members were reminded of the A.I.A. National Convention in Seattle, June 15 to 19, when architects, their families and guests from all parts of the world will be in attendance.

## OREGON CHAPTER

It was announced at the May meeting that the annual meeting would be held on June 9th, the date being advanced so as not to conflict with the national A.I.A. Convention which is to be held in Seattle, June 15-19.

Recommendations of the Nominating Committee include: for Delegates to the 1953-54 A.I.A. Regional Convention—H. Abbott Lawrence, Holman J. Barnes, Donald W. Edmundson, Richard J. Marlitt, Robert W. Fritsch, Clarence H. Wick, Herman Brookman, John D. Annand, and Albert W. Hilgers. Officers placed in nomination to serve for the ensuing year included: John D. Annand, President; Albert W. Hilgers, Vice-President; Donald W. Edmundson, Secretary; Richard J. Marlitt, Treasurer, and H. Abbott Lawrence, Trustee.

New Member—Robert Martin has been presented a certificate as a Corporate Member.

## PASADENA CHAPTER

The May meeting was a joint session with the Southern California Chapter on the campus of the University of Southern California at Los Angeles. Dean Callion and his faculty and students presented an extremely interesting program dealing with the education of the young architect in the School of Architecture at U. S. C.

Delegates to the national A.I.A. Convention in Seattle include: Dorothy and Wilber Harrison, Carl

Remember it's

# KRAFTILE

- for ★ GLAZED STRUCTURAL WALL UNITS  
★ PATIO TILE  
★ FACE AND ROMAN BRICK  
★ ACID FLOOR BRICK  
★ HEARTH BRICK  
★ BRICKETTES  
★ MINWAX TILE & CONCRETE FLOOR FINISH

For complete information and prompt service, phone or write

## KRAFTILE COMPANY

NILES, CALIFORNIA NILES 3611

LOS ANGELES 13: 406 South Main Street—MUJAL 7241

#### Orange County Chapter:

Paul O. Davis (Los Angeles), President; Ralph Modjeski (Santa Ana), Vice-President; Geo. Lind (Newport Beach), Secretary; Wm. L. Faulkner (Santa Ana), Treasurer. Secretary's Office: 2919 Newport Blvd., Newport Beach.

#### Oregon Chapter:

H. Abbott Lawrence, President; Holman J. Barnes, Vice-President; Donald W. Edmondson, Secretary; and Robert W. Fritsch, Treasurer. Office of Secretary, 325 Henry Bldg., Portland.

#### Pasadena Chapter:

Robert E. Lutz, Jr., President; Wallace C. Bonsall, Vice-President; Robert L. Deines, Secretary; Henry C. Burge, Treasurer; and Directors John N. Douglas, R. VanBuren Livingston, Scott Quintin and Burton Romberger. Offices: 259 South Los Robles Ave., Pasadena 5.

#### San Diego Chapter:

Donald Campbell, President; Victor L. Wulfi, Jr., Vice-President; Bill P. Pinnel, Secretary; Edward G. Holliday, Treasurer; Louis A. Dean, Director. Office Sec., San Diego Trust & Savings Bldg.

#### San Joaquin Chapter:

Maurice J. Metz (Fresno), President; Allastair Simpson, Vice-President; Al Bailey, Secretary; Robert Stevens, Treasurer. Directors: David H. Horn, Wm. Hyberg, Robert Kaestner. Secretary's Office, Fresno.

#### Santa Barbara Chapter:

Miss Lutah Maria Riggs, President; Roy C. Wilson, Vice-President; Chester L. Corjala, Secretary; Roy W. Cheesman, Treasurer. Corres. Sec.; Richard B. Nelson, 3033 Calle Rosales, Santa Barbara.

#### Southern California Chapter:

Henry L. Wright, President; U. Floyd Rible, Vice-President; Cornelius M. Deasy, Secretary; Savo M. Stoshich; Hugh R. Davies, S. Kenneth Johnson, Kemper Nomland and Chas. Fry, Directors.

Headquarters, 3723 Wilshire Blvd., Los Angeles 5.

#### Utah Chapter:

W. J. Monroe, Jr., President, 433 Atlas Bldg., Salt Lake City; M. E. Harris, Jr., Secretary, 703 Newhouse Bldg., Salt Lake City.

#### Washington State Chapter:

Paul Thiry, President; John S. Detlie, 1st Vice-President;

Robert H. Wehleb, 2nd Vice-President; Robert H. Dietz, Secretary; and Edwin T. Turner, Treasurer. Alce Gregor Executive Secretary, 430 Central Building, Seattle 4.

#### Spokane Chapter:

B. K. Rueli, President; Victor L. Wulfi, 1st Vice-President; Philip Keene, 2nd Vice-President; Laurence G. Evanoff, Secretary, and Carroll Martell, Treasurer. Office 515 American Legion Bldg., Spokane, Washington.

#### Tacoma Society:

E. N. Dugan, President; P. G. Ball, Vice-President; Lyle Swedberg, Secretary-Treasurer.

#### Hawaii Chapter:

Kenji Onodera, President, 3518 McCarriston St., Honolulu, T. H.; George J. Wimberly, Secretary, 315 Royal Hawaiian Ave., Honolulu, T. H.

#### CALIFORNIA COUNCIL OF ARCHITECTS

Charles E. Fry, President, Los Angeles; Malcolm D. Reynolds, Oakland, Vice-President; Lawrence Gentry, Los Altos, Secretary; Louis A. Dean, San Diego, Treasurer; Fred A. Chase, Executive Secretary, 3723-A Wilshire Blvd., Los Angeles.

#### CALIFORNIA STATE BOARD ARCHITECTURAL EXAMINERS:

Earl T. Heitschmidt (Los Angeles), President; Geo. P. Simonds (Oakland), Secretary; Norman Blanchard (San Francisco); C. J. Paderewski (San Diego); Ulysses Floyd Ribbe (Los Angeles), Exec. Sec.; Robert K. Kelley, Room 712 Mirror Bldg, 145 Spring St. Los Angeles; San Francisco Office, Room 300, 507 Polk St.

#### ALLIED ARCHITECTURAL ORGANIZATIONS

##### San Francisco Architectural Club:

Joseph Scama, President; Frank S. Gerner, Vice-President; Russell W. Pennell, Treasurer; Frank L. Barsotti, Secretary. Club Quarters: 507 Howard St., San Francisco.

##### Producers' Council—Southern California Chapter:

Bert Taylor, President, Pittsburgh Plate Glass Company; G. Robert Roden, Jr., Vice-President, Truscon Steel Company; Malcolm G. Lowe, Secretary, Natural Gas Equipment Inc.; Richard Seaman, Treasurer, W. P. Fuller & Company; Vern Boget, National Director, Gladding McBean & Co. Producers' Council—Northern California Chapter (See Special Page)

McElvy, John Douglas, Breo Freeman, George Lindeberg, Culver Hecton and Bob Landon.

New member—Ward Deems has been elected to Junior Associate membership.

## CALIFORNIA COUNCIL OF ARCHITECTS

The California Council of Architects will hold its mid-year meeting at the Hotel Fairmont in San Francisco on May 22-23. The two days will be devoted to business sessions and reports of committee chairmen.

The association has been particularly busy this year in connection with various phases of legislation offered to the state legislature at Sacramento having a bearing directly, and indirectly, on the practice of architecture in California.

### SAN DIEGO CHAPTER

Tom Armstrong of Armstrong-Schramm Company discussed the subject "What Our Public Relations Program Should Include" at the May meeting with Sam Hamill serving as chairman of the program.

Charles Fry of Los Angeles, and president of the California Council of Architects was also present and discussed a number of architectural problems which are being considered on a state-wide basis.

### PASADENA WOMENS ARCHITECTURAL LEAGUE HOLDS ANNUAL MEETING

The Pasadena Womens' Architectural League celebrated their third anniversary early this month

with a special meeting in the home of Mr. and Mrs. John Douglas in Monrovia.

Guy Brink, interior decorator and currently serving as Pasadena Chamber of Commerce community

(See Page 32)



**BUILD A SAFER BUILDING**

with **MILCOR Materials**

- METAL LATH
- CORNER BEAD (Plain & Expanded)
- CASINGS (All Types)
- ACCESS DOORS
- COLD ROLLED CHANNEL
- STEEL STUDS
- BASE SCREENS

**AND OTHER FIREPROOF CONSTRUCTION MATERIALS!**

Distributed by



**Pacific Coast Aggregates, Inc.**

CONTACT THE NEAREST P.C.A. OFFICE

SAN FRANCISCO	OAKLAND	SAN JOSE
SACRAMENTO	STOCKTON	FRESNO



# WITH THE ENGINEERS

## Structural Engineers Association of California

John E. Rinne, President; San Francisco; Jack S. Barrish, Vice-President, Sacramento; Leslie W. Graham, Secretary-Treasurer, San Francisco. Directors John J. Gould, R. W. Binder, M. A. Ewing, Leslie W. Graham, Jack S. Barrish, Harold P. King, W. T. Wheeler, John E. Rinne and Donald F. Shugart. Secretary's office, c/o Associated Structural Engineers, 417 Market St., San Francisco 5.

## Structural Engineers Association of Northern California

George A. Sedgwick, President; Michael V. Pregnoff, Vice-President; John M. Sardis, Secretary; William K. Cloud, Treasurer; Robert P. Moffett, Asst. Sec.-Treas.; Directors, Robert D. Dalton, Robert D. Dewell, William H. Ellison, John J. Gould and J. Albert Paquette. Offices: 417 Market St., San Francisco.

## Structural Engineers Association of Central California

William H. Peterson, President; Walter S. Wassum, Vice-President; O. T. Illerich, Sec.-Treas.; Ernest D. Francis, M. A. Ewing, and Arthur A. Sauer, directors. Office O. T. Illerich, c/o Div. of Arch., Sacramento.

## American Society of Civil Engineers Los Angeles Section

Trent R. Dames, President; Stephenson B. Barnes, Vice-President; John M. Server, Vice-President; C. Martin Duke, Secretary, and John Merrell, Jr., Treasurer. Office of Secretary, 3066 Engineering Building, University of California, Los Angeles 24.

## American Society of C. E. San Francisco Section

J. G. Wright, President; J. E. Rinne, Vice-President; Howard C. Wood, Vice-President; John S. Longwell, Past President; H. C. Medbery, Secretary, and Richard C. Clark, Treasurer. Office Secretary, S. F. Water Dept., Millbrae.

## ARIZONA ENGINEER RECEIVES A.I.A. HONOR MEMBERSHIP

Gurdon M. Butler, Dean Emeritus of the College of Engineering, University of Arizona, has been elected to Honorary Membership in The American Institute of Architects. He will receive a Certificate from the Institute at its Honor Awards Luncheon to be held in conjunction with the Institute's annual convention in Seattle, June 15-19.

Honorary Membership is conferred upon persons otherwise ineligible for corporate membership, who have rendered distinguished service to

the architectural profession or to any of its allied arts or sciences.

Butler was chosen for this honor because of his outstanding work over many years in legal and educational aspects of engineering and architecture and because of his work on the Tucson Planning Commission.

## STRUCTURAL ENGINEERS ASSOCIATION NORTHERN CALIFORNIA

E. F. Ball, Chief Engineer of Fabricated Steel Construction for the Bethlehem Steel Company, was the principal speaker at the regular May meeting held in the Engineers' Club in San Francisco.

Ball used a number of slides to show the financing, development, and history of the Chesapeake Bay Bridge, and also covered the subject of toll bridges in general. The superstructure of the Chesapeake bridge is four miles long over water and consists of 60 ft. beam spans; 100 ft. and 200 ft. girder spans; 250 ft. and 300 ft. simple truss spans; 480 ft.-600 ft. deck cantilever truss spans; a 780 ft. through cantilever span and a 1600 ft. suspension bridge main channel span. Erection of most of the truss spans was accomplished by building them at a common dock and floating into place on barges.

The brochure "School Construction Under the Field Act," prepared by the Consulting Practice Committee under the Chairmanship of Fred Hall, has been published and is available for distribution. Copies have already been sent each member of the California State Legislature.

## AMERICAN SOCIETY OF CIVIL ENGINEERS—LOS ANGELES

The Los Angeles Section of the American Society of Civil Engineers recently held a meeting at the University of Southern California and heard General L. J. Sverdrup, Corps of Engineers, U. S. Army, describe some of his experiences during the recent

## Both are NEW both are distinctive



← **HAWS Model No. 76**  
the latest member of a "name" family, combines new beauty with the utility and reliability for which HAWS has been famous since 1909.

## The New 56-Page HAWS CATALOG

thoroughly describes and illustrates HAWS complete line of Sanitary Drinking Fountains, Faucets, Electric Water Coolers and HAWS Emergency Eye-Wash Fountains and Drench Shower Equipment. Send for it today...study it...you'll see why it always pays to specify HAWS.



**HAWS DRINKING FAUCET CO.**  
1441 FOURTH STREET (Since 1909) BERKELEY 10, CALIFORNIA

**Structural Engineers Association of Southern California**

Ben Benioff, President; William T. Wright, Vice-President; Charles M. Corbit, Jr., Sec-Treas. Directors: Ben Benioff, William T. Wright, Harold P. King, Henry M. Layne, Joseph Sheffet, Robert J. Kadow and Harold Omsted. Offices, 121 S. Alvarado St., Los Angeles 4.

**Structural Engineers Association of Oregon**

Lewis R. Ellingwood, President; Robert M. Bonney, Vice-President; Sully A. Ross, Secretary-Treasurer. Directors William J. Dornier, Roger V. Gillam, Leslie E. Poole, Rowland S. Rosé. Offices 706 Board of Trade Bldg., 310 S.W. 4th Ave., Portland 4.

**Society of American Military Puget Sound Engineering Council (Washington)**

R. E. Kister, A. I. E. E., Chairman; E. R. McMillan,

A. S. C. E., Vice Chairman; L. B. Cooper, A. S. M. E., Secretary; A. E. Nickerson, I. E. S., Treasurer. Offices L. B. Cooper, c/o University of Washington, Seattle 5, Washington.

**American Society Testing Materials Northern California District**

L. A. O'Leary, Chairman; P. V. Garin, Vice-chairman; H. P. Hoopes, Sec. Office Sec., 1550 Powell St., Emeryville, Calif.

**Society of American Military Engineers—San Francisco Post**

CDR N. M. Martinsen, President; L. L. Wise, 1st Vice-President; Col. Paul Berrigan, 2nd Vice-President; R. M. Hamilton, Secretary; Thomas Hurley, Treasurer. Directors, RADM C. A. Trexel, J. G. Wright, LTCOL C. S. Lindsey, C. E. Bentley, F. R. Fowler, BRIGEN D. F. Johns, and RADM L. N. Moeller.

world war on the island of New Guinea.

General Sverdrup was in charge of the construction of several air fields in the interior of the island where his equipment was composed of thousands of natives wielding picks, shovels and axes. He told of the many problems encountered and equally unusual methods of solution. His methods of procuring and utilizing native labor provided an interesting and colorful narration.

Color motion pictures taken by the General supplemented his comments.

**STRUCTURAL ENGINEERS ASSOCIATION SOUTHERN CALIFORNIA**

The Los Angeles Engineering Council of Founder Societies recently heard Anthony J. Kennedy, attorney at law, and a member of the California Legislative Council, describe a number of legislative matters in Sacramento which effect the engineering profession. The meeting was held in the auditorium of the Edison building.

Ethan F. Ball, of the Bethlehem Steel Company was the main speaker at the May meeting of the Structural Engineers, taking as his subject the famed Chesapeake Bay Bridge. Ball has been identified with many of the outstanding bridge and building structures in the United States and illustrated his talk with many slides.

**FEMINEERS OBSERVE THIRD BIRTHDAY**

Chapter members of the FEMINEERS—: Mrs. A. C. Horner, Mrs. L. L. Wise, Mrs. Henry Degenkolb, Mrs. H. W. Haberkorn, Mrs. S. Ospina, Mrs. R. F. Lyman, Jr., Mrs. Wm. Brewer, Mrs. L. Graham and Mrs. F. Ulrich were feted at an anniversary luncheon on May 20th at the Lake Merritt Hotel in Oakland.

The FEMINEERS is a social club composed of the wives of members of the Structural Engineers Association of Northern California and the American Society of Civil Engineers of Northern California.

The club was founded in 1950 with an initial nine members and to date now numbers over one hundred members. The chief function of the club is to aid in the planning of engineer conventions and to acquaint wives of engineers with each other socially. Membership is always open and new members are invited to join.

The highlight of the FEMINEERS' 1951 season was the awarding of a \$300.00 Engineering Scholarship at the University of California, to a worthy student.

**SPECIFICALLY DESIGNED...**

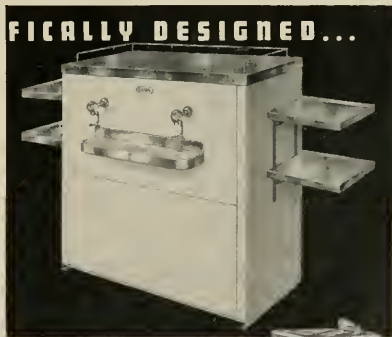

**for primary and intermediate SCHOOLS**

**HAWS**—the complete line—makes specifying easy. Two special school drinking water units illustrated typify the design latitude attainable from HAWS. Special models for specific use...and without custom-made price tags.



See Sweets or write for the new HAWS Catalog

**HAWS DRINKING FAUCET CO.**

1443 FOURTH STREET • BERKELEY 10, CALIFORNIA

# PRODUCER'S COUNCIL PAGE

The National Organization of Manufacturers of Quality Building Materials and Equipment  
(Northern California Chapter) affiliated with THE AMERICAN INSTITUTE OF ARCHITECTS

President, A. L. West, Jr.  
Aluminum Company of America  
621 Russ Bldg.

Vice-President, Howard W. Noleen  
E. F. Hauserman Company  
31 Geary Street

Secretary, Hillman Hudson  
Vermont Marble Company  
525 Market Street

Treasurer, Tait Smith  
Ceco Steel Products Corp.  
401 Tunnel Avenue

Edited by Phil Brown, OTIS ELEVATOR COMPANY.

## PRODUCT DISPLAY

The Product Display on May 27 will feature competition among the exhibitors and three prizes will be awarded. The displays are to be completed for judging at 2:00 P.M. May 27 prior to the opening at 3:00 P.M. The prizes will be awarded to those displays which, in the opinion of the judges, best suit the theme of "Specify, Don't Mystify."

The judges will be Bill Corlett, architect; Mario Ciampi, architect; and Joe Murray, consulting engineer.

The prizes will be awarded to the individuals setting up the display and not the company being represented. The awards will be made prior to the opening of the exhibit.

## CHRISTMAS JINX

As we all know, the size of this affair has gone beyond bounds and some type of corrective action was necessary.

On April 6, the Executive Committee, following its instructions by the majority of the members at a regular meeting on March 16, once again considered the best arrangement to solve this problem.

After due consideration and discussion as to the most practical solution, Mr. Charles Nichols, Crane Company, proposed a motion that the Christmas Jinx be eliminated entirely for 1953 and that a committee be set up now to study a program for 1954.

This motion was carried unanimously, as it was felt that this was the best possible solution to a rather ticklish problem. It will give the Council time to re-group its thoughts as to the desired pur-

pose of the Christmas Jinx and the passage of the additional year between our Annual Christmas parties will remove the possibility of hurt feeling that would be present if we tried to reduce the number of attendants at the party this year.

## ANNUAL SPORTS PROGRAM

The Annual Producers' Council Golf Tournament & Sportsmen's Dinner will be held again at the Olympic Club this year on Tuesday June 9.

The sports program has been enlarged to include tennis for those who have the energy and for those that think they are younger than they really are.

Singles matches will undoubtedly be played, but the prizes will be awarded to the winning doubles team. If you are young in heart, strong of limb and weak in mind, join your fellow Producers and Architects on the courts.

In the cow pasture pool department, ten awards will be made to the low gross, blind boogie low net, longest drive, and high score. Five of the prizes will go to the architects and five to the Producers' Council.

For those that are not athletically inclined, the dinner is being made especially attractive—potables at 6:30 P.M., the finest type of good fellowship, food fit for kings and entertainment.

Harris Wilkinson, Pittsburgh Plate Glass Company, as program chairman, has the details well in hand and advises that as the Christmas Party will not be held this year, and you can't afford to miss this terrific social event.

USE QUALITY PRODUCTS



CONSULT AN ARCHITECT



## LOW RENT HOUSING

The Housing Authority of the County of Kern, Bakersfield, has authorized the construction of a 184-unit Low Housing project to be built in Bakersfield at a cost of \$1,302,000.

The project will include 1, 2, 3 and 4 bedroom duplex dwellings, also an administration building, shops and multi-purpose facilities.

Robert N. Eddy, Bakersfield, is the architect and Fred S. Macomber of Los Angeles is the general contractor.

## SCHOOL BONDS ARE APPROVED

Electors of the Cupertino Union Elementary School District, Cupertino, Santa Clara county, recently approved the issuance of \$350,000 in school bonds plus a State Aid of \$1,950,000 for the construction of new elementary schools and additions to present buildings.

## YATES COOK JOINS NAHB

G. Yates Cook, promoter of the "Baltimore Plan" of slum clearance and a leader in the fight against big city blight, has joined the National Association of Home Builders as head of a new Department of Urban Redevelopment, according to an announcement by Emanuel M. Spiegel, president.

Cook will direct a nation-wide campaign by private builders to wipe out rock-bottom slums and rebuild run-down areas in American cities.

## ARCHITECT SELECTED

Architect Robert R. Jones of Carmel has been selected by the Elks Hall Association of Monterey to design a new Elks Clubhouse to be built in Monterey.

## SHOPPING CENTER LAGUNA BEACH

Plans are underway for construction of the "Laguna Bazaar," a reinforced concrete shopping center in Laguna Beach comprising 82,000 sq. ft. of floor space plus a 20,000 sq. ft. concrete slab parking area. Building will contain 50 retail shops, 75 professional offices, auto ramps and elevators to roof level.

James R. Friend, Long Beach, is the Architect. Cost of project, \$1,300,000.

## TELEVISION STATION

The KFTN Television Broadcasting Company of Stockton has commissioned the architectural firm of Mayo & Johnson & de Wolf, also of Stockton, to draft plans and specifications for a new Television Broadcasting Studio to be built near Stockton in San Joaquin county.

The new studio will be of concrete block and frame construction and will represent the latest in T-V facilities.

## ARCHITECTS NAMED TO SUPERVISE UC

The Regents of the University of California have named the architectural firm of Pereira & Luckman of Los Angeles as supervising architects to plan the over-all development of the 408-acre Santa Barbara College campus at Goleta.

Individual buildings within the master-plan may be assigned to other architectural firms, as in case of the science and library already under construction.

These permanent buildings and conver-

sion of 50 military-type buildings into classrooms and offices are being readied for the expected move next year from the present Riviera campus near the center of Santa Barbara.

## COUNTY BUILDING TO BE ENLARGED

Architect Roy C. Wilson of Santa Paula designed additions which are being made to the Ventura County Court House comprising construction of a three-story building.

Offices of the superintendent of Education, Superior Court, and various county departments will occupy the new building, which is being constructed at a cost of \$386,000 by contractor M. F. Stilwell of Ventura.

## ARCHITECT SELECTED

Architect Gordon Stafford of Sacramento has been commissioned by the Board of the Arcade Elementary School District of Sacra-

mento county to design the new Whitney Elementary School to be built near the City of Sacramento.

Of frame and stucco construction the structure will contain 21,000 sq. ft.

## TUBERCULOSIS HOSPITAL

Architects Horn & Mortland of Fresno are the architects on a 206-bed Tuberculosis Hospital being built for Fresno County.

The building is 3-story with basement, 50 x 350 ft., reinforced concrete with brick veneer, asphalt tile and terrazzo floors, 3 elevators and 1 dumbwaiter, will cost \$2,020,000.

## COMBINATION STORE AND RESIDENCE

Harry Levy, Los Angeles, is building a combined store-residence on W. Pico Blvd. The building will cover an area of 46 x 91 feet.

**ARCHITECTURAL  
PORCELAIN  
BY**

**CAMEO**  
SINCE 1911

**GOODYEAR  
TIRES**

**GOODYEAR**

From Coast to Coast these  
Goodyear colors are  
permanent and unmistakable

Architect — Goodyear Tire &  
Rubber Co.

Contractor — Harry M. Lukens

● Engineering, fabricating and erecting of architectural porcelain has been a major business with us for years. From start to finish our knowledge, experience and large stocks of Armcro enameling iron are at your service. Our complete facilities, and wide spread organization, reduces the cost to you, and assures complete satisfaction everywhere.

Consultation without obligation, of course.

ARCHITECTURAL  
DIVISION



**CALIFORNIA**

6904 E. SLAUSON AVE., LOS ANGELES 22, CALIFORNIA • Underhill 0-1268

Engineers, Designers, and Fabricators of Porcelain  
on metal for Signs, Architecture and Industrial uses.

*Metal Enameling* COMPANY

# PERSONALITIES

## CHARLES FENTON STAUFFACHER, JR., Architect

Graduated from the School of Architecture, University of California, Berkeley, in 1942.

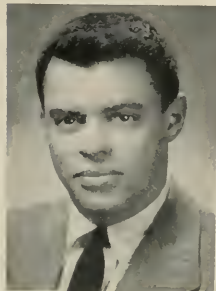

Charles F. Stauffacher, Jr.  
Architect-Designer

Served as Lieutenant in the United States Navy from 1942 to 1946.

Associated with the firm of Ambrose & Spencer, Architects, San Francisco, from 1947 to 1951.

Joined his father's firm of The Fink & Schindler Company of San Francisco in 1951 as vice-president. Assumed management of the Silverado Ranch, a Guest Ranch owned and operated by the Fink & Schindler Company situated on Mt. St. Helena in Napa County, an area made famous in fiction by Robert Louis Stevenson. Supervised

extensive remodeling program of Guest Ranch, including complete redecorating of all rooms, plus additions of new units which were designed by himself.

Stauffacher spends every weekend at the Guest Ranch acting as host and manager; weekdays he is in San Francisco at the offices of Fink & Schindler Co., in the capacity of designer for the firm.

Recent work manufactured and installed by the Fink & Schindler Co., includes: Interiors of Sak's Fifth Ave. store in San Francisco; all Laboratory equipment at the Virus Lab, University of California; Drakes Tavern, Sir Francis Drake Hotel; and the First National Bank, Belmont, California.

*NEXT MONTH: Clarence Cullimore, F.A.I.A. Architect, Bakersfield, Calif.*

## A.I.A. ACTIVITIES

(From Page 27)

development chairman, spoke on the subject "Interior Color." Mrs. A. C. Zimmerman, President, presided at the meeting.

A special party honoring newly licensed architects and their wives, is scheduled for the 24th of May.

## AMERICAN INSTITUTE OF ARCHITECTS CONVENTION

Pietro Belluschi, F.A.I.A., Dean of the School of Architecture and Planning at Massachusetts Institute of Technology, and William M. Allen, President of Boeing Airplane Company, will be the two keynote speakers at the 85th convention of the American Institute of Architects, which meets in Seattle, Washington, June 15-19.

The theme of the convention is "A New Country—A New Architecture," specifically the contribution of the Pacific Northwest to contemporary American building. Seattle resident Allen will open the business sessions Tuesday, speaking on the first part of the theme, "A New Country." Belluschi's subject, "A New Architecture," will close the week's program on Friday.

Tied in with the convention theme is the choice of speaker for the Annual Banquet, Thursday, June 18. George H. T. Kimble, geographer, meteorologist and, since 1950, Director of the American Geographical Society, will relate architecture to the broader study of environment. Kimble classes modern geography as a social science "primarily concerned with viewing the earth as the home of human communities and cultures, and with examining the way in which man has shaped the habitable parts for his own ends . . ."

Throughout the convention, daily seminars will also present a variety of subjects appropriate to the convention theme.

Professor Winfield Scott Wellington of the Department of Decorative Arts at the University of

## Summerbell



for **INDUSTRY**



SUMMERBELL glued laminated segmental arches are economical in first cost and provide greater fire safety. SUMMERBELL glued laminated segmental arches not only permit unobstructed floor space but also unobstructed overhead areas, thereby giving more usable interior space for the money.

Warehouse and Shop Building, Los Angeles. Architects, Siles Clements & Associates. Structural Engineer, Ted H. Joehn. Contractor, Dan H. Shaw.

Glued Laminated Construction • Summerbell Bowstring Trusses  
Lomello Roofs & All Types of Timber Structures

For quality, economy and satisfaction, specify **SUMMERBELL**

## Summerbell ROOF STRUCTURES

825 EAST 29TH STREET • BOX 21B, STATION "K" • LOS ANGELES 11

California, will be the principal speaker at a seminar on "Oriental Influences on American Art and Architecture". Other noted members of this panel include Antonin Raymond, F.A.I.A., architect for the new Reader's Digest Building in Tokyo, Japan, and Harwell Hamilton Harris, Dean of the School of Architecture at the University of Texas. Both Harris, who formerly practised in California and Raymond, who has won his major fame for work in the Far East, have been strongly influenced by Asian architecture.

A special business meeting on the Home Building Industry will feature well known California builder Joseph Eichler and Los Angeles architect Edward Fickett as speakers, with Morgan Yost, F.A.I.A. of Chicago as the Committee Chairman.

Richard M. Bennett, F.A.I.A. of the Chicago firm of Loeb, Schlossman and Bennett, will act as moderator for the "Liturgical Arts" seminar, which will include on its panel representatives of the Protestant, Catholic and Jewish faiths.

Three wood seminars will be conducted by leading representatives from the fields of forest products, lumber research, plywood and timber manufacturing.

#### NATIONAL SOCIETY OF PROFESSIONAL ENGINEERS

Charles F. Kettering was presented the NSPE Award at the Society's annual meeting in Daytona Beach, Florida, recently. Kettering, vice-president of General Motors Corp. was granted the award in recognition for his meritorious service to the engineering profession. The honor has only been previously awarded to former President Herbert Hoover and D. B. Steinman, bridge-builder.

T. Carr Forrest, Jr., of Dallas, Texas, was elected to serve as president, succeeding John D. Coleman of Dayton, Ohio.

#### GLADDING, McBEAN COMPANY INCREASES BOARD MEMBERS

Stockholders voted to increase the number of directors of the Gladding, McBean & Company from 11 to 12 at the recent annual meeting of the company. All former directors were re-elected and Jonathan Lovelace, president and director of the American Mutual Fund, Inc., was chosen as the new member of the board.

F. B. Ortman was elected chairman of the board, as well as president, succeeding Atholl McBean as chairman who will continue to serve as chairman of the finance committee.

James W. Mahoney, who has been vice president in charge of sales, was promoted to executive vice president with headquarters in Los Angeles. Paul J. Lovewell, was appointed assistant to the president with headquarters in San Francisco.

The annual report of Ortman showed the remarkable progress this company has made since the end of World War II, with plant investments alone increasing in value from three million dollars in 1945 to more than eight million dollars at the present time.

#### ARCHITECT PRINCIPAL SPEAKER AT BUILDERS HARDWARE CONVENTION

Architect Don Kirby, of the architectural firm of Kirby and Mulvin, San Francisco, was one of the principal speakers at the eighth annual conference



UNIVERSITY  
LABORATORY  
EQUIPMENT  
Berkeley,  
California

Manufactured and  
Installed by

#### THE FINK and SCHINDLER CO.

Since 1882

552 Brannan St.

San Francisco, Calif.

EXbrook 2-1513



Architect:  
Stanley Fuller Davis

#### PORCELAIN ENAMEL VENEER

#### ECCLESIASTICAL DIGNITY

preserved and displayed for all time  
to come... with decorum, with classic  
beauty, with PORCELAIN ENAMEL  
VENEER.

*Architectural Division*

PORCELAIN ENAMEL PUBLICITY BUREAU  
ROOM 601, FRANKLIN BUILDING, OAKLAND 12, CALIFORNIA  
P. O. BOX 186, EAST PASADENA STATION, PASADENA 8, CALIFORNIA



sponsored by the Pacific Coast Builders Hardware Clubs, the National Contractors Hardware Association and the American Society of Architectural Hardware Consultants, recently held in the Biltmore Hotel in Santa Barbara.

Kirby told the hardware men that with continued advancement in technology and production a continuous effort should be made to improve building hardware design and that cooperation between industrial designers, manufacturers, salesmen and the construction industry as a whole, could accomplish the desired results.

Louis Du Fresne and Marron Kendrick of the

## REDUCE TILT-UP CONSTRUCTION COSTS

with  
**Thompson's  
WATER SEAL**



for surface slabs  
and tilt-up panels

- Locks out moisture, acts as bond breaking agent.
- Permits easy lifting of panels without suction.
- Eliminates hairline cracks for smoother concrete surfaces.
- Gives slower, more uniform curing.
- Protects against seepage, prevents efflorescence.

### MANY OTHER CONSTRUCTION USES:

For lasting protection against moisture, use Thompson's Water Seal for plywood forms, concrete blocks, brick, tile, stucco, plasterboard and any other porous material. Sold in 1, 5, 30, 55 gal. sizes. Ready to use — no mixing. Applied easily by spraying, brushing, mopping or dipping.

Available at paint, hardware or building supply dealers.

**BY-CHEMICAL PRODUCTS CO.**

1355 Market Street • San Francisco 3, California

# HAAS and HAYNIE

Formerly Haas Construction Company

Since 1898

275 PINE ST.

SAN FRANCISCO, CALIF.

Phone DOuglas 2-0678

Schlage Lock Co., Robert Logan of the J. B. Rice Co., San Rafael, and Gene Hundley, San Francisco hardware dealer, were in charge of arranging this year's program. More than 400 representatives of manufacturers, dealers, and jobbers on the West Coast were in attendance.

### HARRINGTON ATTENDS WASHINGTON CLAY BRICK AND TILE MEETING

R. W. Harrington, manager of the Clay Brick & Tile Association, San Francisco, attended a recent national conference of tile industry representatives at the Structural Clay Products Institute headquarters in Washington, D. C.

The meetings were held solely for the Industry's Board of Directors, Regional Directors, and Working Committee, whose members represent all parts of the United States. The conference included eight days of meetings with industry engineers and executives to determine the programs and policies of the tile industry for the ensuing year.

### ASSOCIATION OF TESTING AND INSPECTION LABORATORIES

Formation of the Association of California Testing and Inspection Laboratories was completed at a meeting of testing and laboratory representatives in Los Angeles.



THEODORE P. DRESSER, JR.  
President

Theodore P. Dresser, Jr. of the Abbot A. Hanks, Inc., Engineers and Chemists, San Francisco, was elected president. Other officers named to serve the new organization included: Harrison H. McCall, Los Angeles, Vice-President; Frank R. Killinger, Oakland, Secretary-Treasurer; and Philip W. Helsley of San Diego and M. R. Neuman, Oakland, members of the Board of Directors.

Formation of the association followed a previous meeting of representatives of the Division of Architecture, State of California, and of representatives of the laboratories throughout the state. The need for such an organization to serve as a central point of contact for discussion of inspection and testing procedures in connection with school building and other public construction has long been recognized. The next meeting of the association will be held in Sacramento the latter part of this month.

### SOUTHERN CALIFORNIA ARCHITECTS WIN NEW YORK RECOGNITION

Seven structures designed by Southern California architects are among 43 structures selected

ARCHITECT AND ENGINEER

by New York's Museum of Modern Art as significant examples of architecture in the United States since World War II.

Models and photographs of the buildings are on display at the Museum, in conjunction with a book entitled "Built in U.S.A." which has just been published by the Museum.

Architects and projects honored include: Gregory Ain, Wilfong house, Los Angeles, 1952; Harwell H. Harris, Johnson house, Los Angeles, 1951; Maynard Lyndon, Vista Elementary School, 1950; Richard J. Neutra, Tremaine house, Montecito, 1949; Raphael Soriano, Los Angeles house, 1950; Lloyd Wright, Wayfarers' Chapel, Palos Verdes, 1951; and Charles Eames, house in Santa Monica.

#### ADVANCED DESIGN WINS HONORS FOR AGRICULTURAL BUILDINGS

The new Home Economics Building on the Davis campus of the University of California, has been accorded both local and national awards for its advanced design in collegiate architecture.

Clark and Beuttler, and Robert J. Evans, chief architect for the university, were honored by The American Institute of Architects, Award of Merit, and the School Executive magazine for their design of the building. One of the features of the L-shaped structure is its unique design to reduce discomforts from high temperatures, based upon extensive studies of the sun's position at all times.

#### ARCHITECT OPENS OFFICES IN ABILENE, TEXAS

George Morgan, architect and engineer, has opened offices in Abilene, Texas, for the practice of architecture and engineering according to a recent announcement.

Morgan, a three year resident of Abilene, practiced architecture and was a designer of homes in California for twelve years prior to moving to Texas. He also engaged in designing numerous commercial, municipal and educational buildings, and during World War II was with the U. S. Corps of Engineers in Southern California.

#### ENGINEER APPOINTED TO LOS ANGELES BOARD OF EDUCATION

Ed Stahl has been appointed Structural Engineer, Building Branch, of the Los Angeles Board of Education. He will serve as assistant to Chief Structural Engineer Harold Omsted.

**PORCELAIN ENAMEL INSTITUTE:**—Members of the Porcelain Enamel Institute's Executive Committee and other industry leaders met in Los Angeles recently, for a "Report to the West Coast", according to W. A. Barrows, Institute president.

## FORDERER CORNICE WORKS

*Manufacturers of*

Hollow Metal Products • Interior Metal Trim  
Elevator Fronts and Cabs  
Metal Plaster Accessories • Sanitary Metal Base  
Flat and Roll Metal Screens  
Metal Cabinets • Commercial Refrigerators

269 POTRERO AVE.

SAN FRANCISCO, CALIF.

HEMLOCK 1-4100

## Parker, Steffens & Pearce

BUILDERS

135 South Park, San Francisco

Phone: EXbrook 2-6639

## BARRETT & HILP

CONTRACTORS

*Serving The Construction Field  
Since 1912*

OUR FORTIETH YEAR

918 Harrison Street • San Francisco  
Telephone DOuglas 2-0700

## E. H. MOORE & SONS

*General Contractors*



E. H. (Deck) MOORE  
693 MISSION ST., SAN FRANCISCO  
Telephone: GARfield 1-8579

## JUDSON PACIFIC-MURPHY CORP.

Steel Fabricators  
and  
Erectors

REINFORCING STEEL  
STRUCTURAL STEEL  
BRIDGE CRANES

4300 EASTSHORE HWY.  
EMERYVILLE, CALIF.

Phone:  
OL 3-1717

## CLINTON CONSTRUCTION CO. OF CALIFORNIA

General Contractors

923 FOLSOM STREET • SAN FRANCISCO

SUtter 1-3440

## HOGAN LUMBER CO.

Wholesale and Retail

LUMBER

MILL WORK • SASH & DOORS

Office, Mill, Yard and Docks  
SECOND AND ALICE STREETS • OAKLAND, CALIF.

Telephone GLencourt 1-6861

## ALLIANCE ENGINEERS

C. L. WEEKS  
Civil Engineer No. 4943

COST ENGINEERS  
QUANTITY SURVEYORS  
APPRAISERS

★ Preliminary & Final Estimates ★

602 West Santa Barbara Avenue  
Los Angeles 37, California  
ADams 3-7138

## BOOK REVIEWS PAMPHLETS AND CATALOGUES

**THE SMALL ENGLISH HOUSE . . . 1500-1939.** By Reginald Turnor. John de Graff, Inc., 64 W. 23rd St., New York 10. Price \$10.00.

On the premise that the house is the basic unit in architecture, the author has told the story of English architecture, from the late medieval times until 1939, in terms of the smaller house. Excluding cottages on the one hand and the great mansions on the other, Turnor writes of the houses in which the middle class people make their homes.

The genesis of the smaller English house is to be found in the Hall of the later middle ages. It was not until the Renaissance that the dwelling house ceased to be a traditional structure with the architect unknown, and with the building of the Queen's House at Greenwich by Inigo Jones entered a period when houses came to be consciously designed often by named architects.

There are nearly 200 photographs, engravings and plans, which form a visual history of the development of the smaller English house. 216 Pages.

**A SURVEY OF HOUSING RESEARCH IN THE UNITED STATES.** Housing and Home Finance Agency, Washington, D. C. Price \$3.00.

Results of a survey conducted by the Building Research Advisory Board, National Research Council, National Academy of Sciences, under the supervision of William H. Schenck, executive director of the Building Research Advisory Board, to provide industry with as much information as possible about what is being done in housing research by educational institutions, scientific foundations, professional societies and trade associations, and commercial laboratories.

The study is intended to assist the housing industry to make the most efficient use of current research activity and to provide information as to facilities available for further housing research.

**ADHESIVES FOR WOOD.** By R. A. G. Knight. Chemical Publishing Company, 212 5th Ave., N. Y. Price \$5.00.

Serves as a guide for the younger technician and a ready reference for the experienced man. The age-old problem of the engineer—how to join components together—is the theme of the book, and in this case the components are made of wood. The joining of wood to metals and plastics is also considered.

The book contains many interesting diagrams and tables, giving numerical data on the moisture content of wood in various tests. Other features are a glossary of special terms, a comprehensive index and many references on every phase of the subject which will help the technical worker to locate more detailed information he may need in his work. 242 Pages.

## NEW CATALOGUES AVAILABLE

Architects, Engineers, Contractors, Planning Commission members—the catalogues, folders, new building products material, etc., described below may be obtained by directing your request to the name and address given in each item.

**Air Filters.** Two new booklets, "Bulletin 201-D" and "Bulletin 401-A", covering the subject of automatic, self-cleaning air filters and cleanable air filters are available from the Stanford Mechanical Equipment Co., 306-40th St., Oakland 6, California, newly appointed Sales Representatives of Continental Air Filters, Inc., of Louisville, Ky. The material includes a number of charts, scales, drawings and photographs showing methods and types of use.

**Water Circulators.** A new pamphlet devoted to information on water circulators including performance charts, capacity tables, dimensions, etc., on horizontal and vertical installations. Numerous drawings illustrate the various applications on hot water heating systems and domestic hot water supply systems. Other special and unusual applications are also called to the attention of the trade. Circular HC-352 Available, H. A. Thrust & Co., Peru, Indiana.

**Elevator and Dumbwaiter Doors.** An illustrated, two-color, 12-page catalog describing the many advantages of bi-parting telescoping and single section freight doors for use on elevators throughout industry and in stores, hotels and office buildings. Also describes dumbwaiter doors used on hatch entrances for



dumbwaiters, trayveyors, subveyors and other vertical conveyors in restaurants, hotels, hospitals, etc. Includes layout data, specifications, hoistway construction requirements and cut-away diagrams. Catalog G2-2. Available, Guilbert, Inc., 1105 Frankford Ave., Philadelphia 25, Pa.

**Drive-In Banks.** Faster and more convenient banking service for motorists is the theme of a new booklet entitled "Super Service Banking Drive-in Plans Manual". Prepared to help banks planning to install modern drive-in facilities, the booklet covers a wide variety of drive-in installations; illustrations, accompanied by schematic drawings, show dimensions, proper radius of turn, spacing of multiple drive-in windows, and traffic flow markings. Shows single and multiple installations of bay-type and flush-type electrically operated windows. Available, Mosler Safe Co., 320 - 5th Ave., New York 1.

**Stainless Steels for Store Fronts** and building entrances. A new two-color illustrated booklet that analyzes the use of stainless steel in a variety of store-fronts and entrances in various parts of the country. Detail drawings, photographs, and brief comments point up significant features of the installations presenting to the architect and designer stainless steel knowhow in its most useful form. Prepared in cooperation with Department of Education and Research of The American Institute of Architects. A.I.A. File No. 26D. Committee of Stainless Steel Producers, American Iron & Steel Institute, 350 5th Ave., New York.

**Tables of Distinction** catalog is printed in full color and emphasizes new Flare Design cast construction table base. Other tables illustrated show a variety of metal finishes including cast anodized aluminum, chrome and bronze plate, cast solid bronze, and cast iron in a wide variety of porcelain enamel colors. Many illustrations, sizes and accessory specifications. Available from Chicago Hardware Foundry Co., North Chicago, Illinois.

**Air Conditioning** high velocity systems are described in a new bulletin (HV Manual 48) with engineering data on the selection, layout and installation of Anemostat units for high velocity air conditioning systems. This new publication contains data that will help consulting engineers design high velocity air conditioning systems, plus standard tables in the ASHVE Guide; useful tips on duct design, sizing of ducts, types of systems and balancing of units and information on how metal and space savings can be achieved. Photographs and drawings are shown. Available from Anemostat Corp. of America, 10 E. 39th St., New York 16.

**Approved Playground Equipment** manufactured by the American Playground Device Company is shown in colored pamphlet, also gives complete description and prices. Fittings and combinations of pieces of equipment are given. Includes playgrounds and swimming pools. Available from American Playground Device Co., Anderson, Indiana.

**Awning Type Windows** popularly used in ranch type residential building uses top-hinged or awning type windows. This pamphlet shows uses in single or multiple units, or in "ribbon" series as ventilators in large fixed glass areas. Device permits perfect control of sash in any projected position. Complete information available The Casement Hardware Co., 612 N. Michigan Ave., Chicago 11, Ill.

**Modernfold Doors.** An architectural inspiration for every interior closure or space division problem. New catalog with many photographs, shows how to specify doors to save space in home and commercial installations and as a room division for both home and commercial use. Contains complete architectural detail for stock, standard and custom doors, including track sizes and styles; sound insulated doors, curved installations, switch installations and mechanically operated doors. Catalogs are available from Modernfold Door Division, 655 Folsom St., San Francisco.

**Silent Light Switches** are described in a new folder on "Lifetime Quiet Switch"; can be installed in any position; quiet in operation, and designed for use with both incandescent and fluorescent lights. Complete information from Arrow-Hart & Hegemann Electric Co., Hartford, Conn.

**Distribution Panelboard** pamphlet lists specifications and enclosure sizes; can be assembled on job from stock parts; circuits may be changed or added to the panelboard with a minimum of lost time. Gives suggestions on correct installations, including a step-by-step photographic demonstration of an assembly. Available from Federal Electric Products Co., 50 Paris St., Newark, N.J.

**Overhead Panelwork** new catalog. Contains photographs of various models for use in commercial and industrial buildings, theatres, churches, and auditoriums. Also data on dimensions and specifications and a number of testimonials. A.I.A. File No. 30-C-43. Available from Affiliated Gas Equipment, Inc., Monrovia, California.

## "AMERICAN - MARSH"

CONDENSATION UNIT

Pumping  
Machinery  
for  
Every  
Purpose

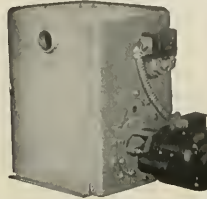

For Service  
Call  
DOuglas  
2-6794  
or  
MUTual 8322

**SIMONDS MACHINERY CO.**

SAN FRANCISCO  
816 FOLSOM

LOS ANGELES  
455 EAST 4TH

## VERMONT MARBLE COMPANY

DOMESTIC AND IMPORTED MARBLES  
GRANITE VENEER

525 MARKET STREET • SAN FRANCISCO 5  
Phone: SUtter 1-6747

3522 COUNCIL STREET • LOS ANGELES 4  
Phone: DUUnkirk 2-7834

The Most Complete Line of  
STEELS and STEEL BUILDING MATERIALS  
Made by a Single Producer



See Sweet's Catalog File or write us for  
full information.

**REPUBLIC STEEL CORPORATION**

GENERAL OFFICES: CLEVELAND, OHIO

DENVER, COLORADO . . . . . CONTINENTAL OIL BUILDING  
LOS ANGELES, CALIF. . . . . GENERAL PETROLEUM BUILDING  
SAN FRANCISCO, CALIFORNIA . . . . . RIALTO BUILDING  
SEATTLE, WASH. . . . . WHITE-HENRY-STUART BUILDING

## PACIFIC MANUFACTURING CO.

High Class Interior Finish Quality  
Millwork

16 Beale St., San Francisco  
GARfield 1-7755

2215 El Camino Real, San Mateo  
S. M. 5-0687

304 Bryant Street, Palo Alto  
P. A. 3373

2610 The Alameda, Santa Clara  
S. C. 607 (Factory)

6820 McKinley Avenue, Los Angeles  
THornwall 4196

MAIN OFFICE — SANTA CLARA

## ROBERT M. JOHNSON APPOINTED SOUTHERN SALES MANAGER

Robert M. Johnson has been appointed Southern California sales manager for General Controls Co., according to an announcement by J. F. Ray, vice president of the company.

Johnson, a Los Angeles native, has more than fifteen years' experience in the heating, ventilating and air conditioning fields. He is a registered professional engineer, member of the American Society of Heating & Ventilating Engineers and past chairman of the floor furnace group of the Gas Appliance Manufacturers Association.

## CLAY MANUFACTURERS NAME NEW EXECUTIVE DIRECTOR

The Structural Clay Products Institute, national association of brick and tile manufacturers, recently announced the appointment of Henry E. Bollman of Denver as executive director. The new post was created by the institute's board of directors.

## SOUND ENGINEER JOINS REDWOOD CITY FIRM

Dr. Carl H. Becker, German physicist and audio engineer, has joined the staff of the Ampex Electric Corp. of Redwood City, California.

Dr. Becker was chief sound engineer and physi-

cist for UFA from 1930 to 1934, and later organized Stereophone Ltd., in Bavaria, manufacturers in the field of stereophonic equipment.

## WOMAN ENGINEER RECEIVES AWARD

Miss Elizabeth G. McGill, consultant aeronautical engineer of Toronto, was chosen by the Society of Women Engineers to receive their 1953 "Award for Meritorious Contribution to Engineering."

The award was presented at the annual banquet of the Society of Women Engineers, recently held in New York City. The award was made by Marie Reith, chairman of the Awards Committee, and associated with the Consolidated Edison Company of New York.

## SAN FERNANDO VALLEY ARCHITECTS HOME SHOW

Architects of the San Fernando Valley will hold their annual "Home Show" June 17-21 at the Burbank Armory, according to Robert Stacy-Judd who has been named director of this year's event.

The show will include everything applicable to the home, with two shows being given per day. Free parking has been arranged for those attending, and a nominal charge is being made for admission.

## RIVER SITE HOME

(From Page 19)

noon when the sun floods the patio, family and guests slide deck furniture into the carport where it is cool much of the late afternoon.

The roof is a one-way slope design, built up with asphalt roofing laid directly on the two-by-six decking. An overhang around the perimeter of the unusual-shaped home protects the siding from unnecessary exposure to the weather, and gives a feeling of height to the home when viewed from the river side.

The Rooney summer home is a budget or economy job. It cost slightly more than \$8 a square foot, a very conservative cost for a home where nothing was spared to make it liveable, beautiful and with full utility.

Architect Woollen has achieved excellent results in his departure from conventional floor design and fixed patterns in this pleasing summer home. His framing of many river pictures through the windows of this home marks a refreshing touch of artistry and imagination. We like the Rooney home because it belongs to its location and is in no way offensive to the woodsy, natural flavor of its setting. Bending the home to fit the river curve was a charming idea by a good craftsman.

# VALUABLE NEWS SERVICE

- BUILDING MATERIAL DEALERS
- CONTRACTORS
- SUB-CONTRACTORS
- MANUFACTURERS AND REPRESENTATIVES

**ARCHITECTS REPORTS** gives advance news on construction projects in Northern California, lists: name of projects, location, architect, proposed cost and other pertinent information.

**HANDY** individual slip-reports, issued daily at a total cost of only

\$10 a month

## ARCHITECT'S REPORTS

Published Daily

The ARCHITECT and ENGINEER, Inc.

68 Post Street, San Francisco - DO 2-8311

# ESTIMATOR'S GUIDE

## BUILDING AND CONSTRUCTION MATERIALS

PRICES GIVEN ARE FIGURING PRICES AND ARE MADE UP FROM AVERAGE QUOTATIONS FURNISHED BY MATERIAL HOUSES TO SAN FRANCISCO CONTRACTORS. 3% SALES TAX ON ALL MATERIALS BUT NOT LABOR

All prices and wages quoted are for San Francisco and the Bay District. There may be slight fluctuation of prices in the interior and southern part of the state. Freight cartage, at least, must be added in figuring country work.

**BONDS**—Performance or Performance plus Labor and Material Bond(s), \$10 per \$1000 on contract price. Labor & Material Bond(s) only, \$5.00 per \$1000 on contract price.

**BRICKWORK—MASONRY**—  
Common Brick—Per 1 M laid—\$150.00 up (according to class of work).  
Face Brick—Per 1 M laid—\$200.00 and up (according to class of work).  
Brick Steps—\$3.00 and up.  
Common Brick Veneer on Frame Bldgs.—Approx. \$1.20 and up—(according to class of work).  
Face Brick Veneer on Frame Bldgs.—Approx. \$2.00 and up (according to class of work).  
Common Brick—\$36.00 per M truckload lots, delivered.

Face Brick—\$81.00 to \$106.00 per M, truckload lots, delivered.  
**Glazed Structural Units—Walls Erected**—  
Clear Glazed—  
2 x 6 x 12 Furring.....\$2.00 per sq. ft.  
4 x 6 x 12 Partition.....2.25 per sq. ft.  
4 x 6 x 12 Double Faced.....  
For colored glaze add......30 per sq. ft.  
Mantel Fire Brick \$150.00 per M—F.O.B. Pittsburgh.

Face Brick—Per M—\$111.00 to \$147.00.  
Cartage—Approx. \$10.00 per M.  
Paving—\$75.00.

**Building Tile**—  
8 1/2 x 12-inches, per M.....\$139.50  
6 x 5 1/2 x 12-inches, per M.....105.00  
4 5/8 x 12-inches, per M.....84.00

**Hollow Tile**—  
12 x 12 x 2-inches, per M.....\$146.75  
12 x 12 x 3-inches, per M.....156.85  
12 x 12 x 4-inches, per M.....177.10  
12 x 12 x 6-inches, per M.....235.30  
F.O.B. Plant

**BUILDING PAPER & FELTS**—

1 ply per 1000 ft. roll.....\$5.30  
2 ply per 1000 ft. roll.....7.80  
3 ply per 1000 ft. roll.....9.70  
Brownskin, Standard 500 ft. roll.....6.85  
Sisalraff, reinforced, 500 ft. roll.....8.50

**Sheathing Papers**—  
Asphalt sheathing, 15-lb. roll.....\$2.70  
30-lb. roll.....3.70  
Dampcourse, 216-ft. roll.....2.95  
Blue Plasterboard, 60-lb. roll.....5.10

**Felt Papers**—  
Deadening felt, 3/4-lb., 50-ft. roll.....\$4.30  
Deadening felt, 1-lb.....5.05  
Asphalt roofing, 15-lb.....2.70  
Asphalt roofing, 30-lb.....3.70

**Roofing Papers**—  
Standard Grade, 108-ft. roll, Light.....\$2.50  
Smooth Surface, Medium.....2.90  
Heavy.....3.40  
M. S. Extra Heavy.....3.95

**BUILDING HARDWARE**—

Sash cord com. No. 7.....\$2.65 per 100 ft.  
Sash cord com. No. 8.....3.00 per 100 ft.  
Sash cord spot No. 7.....3.65 per 100 ft.  
Sash cord spot No. 8.....3.35 per 100 ft.  
Sash weights, cast iron, \$100.00 ton.....\$3.75  
1-ton lots, per 100 lbs.....4.75  
Less than 1-ton lots, per 100 lbs.....4.75  
Nails, per leg, base.....\$12.55  
8-in. spikes.....12.45  
Rim Knob lock sets.....\$1.80  
Butts, dull brass plated on steel, 3/2 x 3/2......76

**CONCRETE AGGREGATES**—

The following prices net to Contractors unless otherwise shown. Carload lots only.

	Bunker per ton	Del'd per ton
Gravel, all sizes.....	\$2.44	\$2.90
Top Sand.....	2.38	3.13
Concrete Mix.....	2.38	3.06
Crushed Rock, 1/4" to 3/4".....	2.38	2.90
Crushed Rock, 3/4" to 1 1/2".....	2.38	2.90
Roofing Gravel.....	2.81	2.90
River Sand.....	2.50	3.00
<b>Sand</b> —		
Lapis (Nos. 2 & 4).....	3.56	3.94
Olympia (Nos. 1 & 2).....	3.56	3.88

**Cement**—  
Common (all brands, paper sacks), Per Sack, small quantity (paper).....\$1.05  
Carload lots, in bulk, per bbl.).....3.55  
Cash discount on carload lots, 10c a bbl., 10th Prox., less than carload lots, \$4.00 per bbl. f.o.b. warehouse or delivered.  
Cash discount 2% on L.C.L.

Trinity White.....{ 1 to 100 sacks, \$3.50 sack warehouse or del.; \$9.56 bbl. carload lots.  
Medusa White.....{

**CONCRETE READY-MIX**—

Delivered in 4-yd. loads:  
Per cubic yard, 1-8 Mix.....\$ 9.80  
1-7 Mix.....10.15  
1-6 Mix.....10.70  
1-5 Mix.....11.40

Curing Compound, clear, drums, per gal.....1.03

**CONCRETE BLOCKS**—

	Hay-dite	Ba-salt
4x8x16-inches, each.....	\$.19	\$.19
6x8x16-inches, each.....	.23	.235
8x8x16-inches, each.....	.27	.27
12x8x16-inches, each.....	.39	.40
12x8x24-inches, each.....	..	.60

**Haydite Aggregates**—  
3/4-inch to 3/8-inch, per cu. yd.....\$7.75  
3/4-inch to 1/2-inch, per cu. yd.....7.75  
No. 6 to 0-inch, per cu. yd.....7.75

**DAMP-PROOFING and Waterproofing**—

Two-coat work, \$9.00 per square.  
Membrane waterproofing—4 layers of saturated felt, \$10.00 per square.  
Hot coating work, \$5.00 per square.  
Medusa Waterproofing, \$3.50 per lb. San Francisco Warehouse.  
Trico-sal concrete waterproofing, 60c a cubic yd. and up.

**ELECTRIC WIRING**—\$15 to \$20 per outlet for conduit work (including switches).  
Knob and tube average \$6.00 per outlet.

**ELEVATORS**—

Prices vary according to capacity, speed and type. Consult elevator companies. Average cost of installing a slow speed automatic passenger elevator in small four story apartment building, including entrance doors, about \$9,500.00.

**EXCAVATION**—

Sand, \$1.00; clay or shale, \$1.50 per yard. Trucks, \$30 to \$45 per day.  
Above figures are an average without water. Steam shovel work in large quantities, less; hard material, such as rock, will run considerably more.

**FIRE ESCAPES**—

Ten-foot galvanized iron balcony, with stairs, \$250 installed on new buildings; \$300 on old buildings.

**FLOORS**—

Asphalt Tile, 1/8 in. gauge 18c to 35c per sq. ft.  
Composition Floors, such as Magnesite, 40c-\$1.25 per sq. ft.  
Linoleum, standard gauge, sq. yd.....\$2.75  
Mastipave—\$1.50 per sq. yd.  
Battleship Linoleum—1/8"=\$3.00 sq. yd.  
Terazzo Floors—\$2.00 per sq. ft.  
Terazzo Steps—\$2.50 per lin. ft.  
Mastic Wear Coat—according to type—20c to 35c.

**Hardwood Flooring**—

**Oak Flooring—T & G—Unfin.**—  
Clear Old., White.....\$3x2/4 1/2x2 3/8x2 1/2x2  
Clear Old., Red.....405 380 \$ \$  
Select Old., Red or White.....355 340  
Clear Pin., Red or White.....355 340 325 315  
Select Pin., Red or White.....340 330 335 300  
#1 Common, Red or White 315 310 305 280  
#2 Common, Red or White 305

**Prefinished Oak Flooring**—

	Prime	Standard
1/2 x 2.....	\$349.00	\$370.00
3/4 x 2.....	380.00	370.00
1 x 2.....	390.00	381.00
1 1/4 x 2.....	375.00	355.00
1 1/2 x 2.....	395.00	375.00
1 3/4 x 2.....	395.00	415.00

**Unfinished Maple Flooring**—

1 1/2 x 2/4 First Grade.....	\$390.00
1 1/2 x 2/4 2nd Grade.....	365.00
1 1/2 x 2/4 2nd & 3rd Grade.....	375.00
1 1/2 x 2/4 3rd Grade.....	240.00
1 1/2 x 3/4 3rd & Btr. Jrd. EM.....	380.00
1 1/2 x 3/2 2nd & Btr. Jrd. EM.....	400.00
33/32 x 2/4 First Grade.....	360.00
33/32 x 2/4 2nd Grade.....	320.00
33/32 x 2/4 3rd Grade.....	320.00
Floor Layer Wage \$2.60 hr.	

**GLASS**—

Single Strength Window Glass.....\$ .30 per sq. ft.  
Double Strength Window Glass......45 per sq. ft.  
Plate Glass, 1/4 polished to 75.....1.60 per sq. ft.  
75 to 100.....1.74 per sq. ft.  
1/4 in. Polished Wire Plate Glass.....2.50 per sq. ft.  
1/4 in. 2nd Grade......80 per sq. ft.  
1/4 in. Rgh. Wire Glass......44 per sq. ft.  
1/4 in. Obscure Glass......63 per sq. ft.  
1/4 in. Obscure Glass......54 per sq. ft.  
1/4 in. Heat Absorbing Obscure......72 per sq. ft.  
1/4 in. Heat Absorbing Wire......44 per sq. ft.  
1/4 in. Ribbed......63 per sq. ft.  
1/4 in. Ribbed......44 per sq. ft.  
1/4 in. Rough......63 per sq. ft.  
1/4 in. Rough......30 per sq. ft.  
Glazing of above additional \$.15 to  
Glass Blocks, set in place.....3.50 per sq. ft.

**HEATING**—

**Furnaces—Gas Fired**  
Floor Furnace, 25,000 BTU.....\$ 70.50  
35,000 BTU.....77.00  
45,000 BTU.....39.00  
Automatic Control, Add.....91.50  
Dual Wall Furnaces, 25,000 BTU.....99.00  
35,000 BTU.....117.00  
45,000 BTU.....117.00  
With Automatic Control, Add.....39.00  
Unit Heaters, 50,000 BTU.....202.00  
Gravity Furnace, 45,000 BTU.....198.00  
Forced Air Furnace, 75,000 BTU.....313.50  
**Water Heaters—5-year guarantee**  
With Thermostat Control.....87.50  
20 gal. capacity.....103.95  
30 gal. capacity.....120.00  
40 gal. capacity.....120.00



## INSULATION AND WALLBOARD—

Rockwool Insulation—	
(2") Less than 1,000 sq. ft.	\$64.00
(2") Over 1,000 sq. ft.	\$9.00
Cotton Insulation—Full thickness	
(3 1/2")	\$95.50 per M sq. ft.
Statilaton Aluminum Insulation—Aluminum coated on both sides	\$23.50 per M sq. ft.
Tileboard—4'x6' panel	\$9.00 per panel
Wallboard—1/2" thickness	\$55.00 per M sq. ft.
Finished Plank	\$9.00 per M sq. ft.
Ceiling Tileboard	\$9.00 per M sq. ft.

**IRON**—Cost of ornamental iron, cast iron, etc., depends on designs.

## LUMBER—

S4S No. 2 and better common	
O.P. or D.F., per M. f.b.m.	\$100.00
Rough, No. 2 common O.P. or D.F., per M. f.b.m.	95.00

## Flooring—

	Per M Delvd.
V.G., D.F. 8 & 8tr. 1 x 4 T & G Flooring	\$225.00
"C" and better—all	225.00
"D" and better—all	225.00
Rwd. Rustic—"A" grade, medium dry	185.00

Pllywood, per M sq. ft.	
1/4-inch, 4.0x8.0-S15	\$135.00
1/2-inch, 4.0x8.0-S15	219.00
3/4-inch, per M sq. ft.	292.00
Plyscord	11 1/2¢ per ft.
Plyform	25¢ per sq. ft.

Shingles (Rwd. not available)—  
Red Cedar No. 1—\$9.50 per square; No. 2, \$7.00; No. 3, \$5.00.

Average cost to lay shingles, \$6.00 per square.  
Cedar Shakes—1/2" to 3/4" x 24/26 in hand split tapered or split resawn, per square \$15.25  
3/4" to 1 1/4" x 24/26 in split resawn, per square \$17.00

Average cost to lay shakes, \$8.00 per square.  
**Pressure Treated Lumber—**  
Wolmanized ..... Add \$35 per M to above  
Creosoted,  
8-lb. treatment ..... Add \$45 per M to above

**MARBLE**—(See Dealers)

## METAL LATH EXPANDED—

Standard Diamond, 3.40, Copper Bearing, L.C.L. per 100 sq. yds.	\$43.50
Standard Ribbed, ditto	\$47.50

## MILLWORK—Standard.

D. F. \$150 per 1000. R. W. Rustic \$175 per 1000 (delivered).  
Double hung box window frames, average with trim, \$12.50 and up, each.  
Complete door unit, \$15 to \$25.  
Screen doors, \$8.00 to \$12.00 each.  
Patent screen windows, \$1.25 a sq. ft.

Cases for kitchen pantries seven ft. high, per lineal ft., upper \$9.00 to \$11.00; lower \$12.00 to \$13.00.

Dining room cases, \$20 per lineal foot  
Rough and finish about \$1.00 per sq. ft.  
Labor—Rough carpentry warehouse heavy framing (average), \$75.00 per M.

For smaller work average, \$85.00 to \$100. per 1000.

## PAINTING—

Two-coat work	per yard 85c
Three-coat work	per yard \$1.10
Cold water painting	per yard 25c
Whitewashing	per yard 15c

<b>Inseed Oil, Strictly Pure</b>	<b>Wholesale</b>
(Basis 7 1/2 lbs. per gal.)	<b>Raw Boiled</b>
Light iron drums	per gal. \$2.28 \$2.34
5-gallon cans	per gal. 2.40 2.46
1-gallon cans	each 2.52 2.58
Quart cans	each 71. 72
Pint cans	each 38 39
1/2-pint cans	each 24 24

<b>Turpentine</b>	<b>Pure Gum</b>
(Basis 7.2 lbs. per gal.)	<b>Spirits</b>
Light iron drums	per gal. \$1.65
5-gallon cans	per gal. 1.76
1-gallon cans	each 1.88
Quart cans	each .54
Pint cans	each .31
1/2 pint cans	each .20

## Pioneer White Lead in Oil Heavy Paste and All-Purpose (Soft-Paste)

	<b>List Price</b>	<b>Price to Painters</b>
<b>Net Weight</b>	<b>lbs.</b>	<b>Pr. per</b>
<b>Packages</b>	<b>lbs.</b>	<b>100 Pr. per</b>
100-lb. kegs	\$28.35	\$27.50
50-lb. kegs	30.05	29.35
25-lb. kegs	30.35	28.45
5-lb. cans*	33.35	31.24
1-lb. cans*	36.00	33.75

500 lbs. (one delivery) 3/4¢ per pound less than above.  
\*Heavy Paste only.

## Pioneer Dry White Lead—Litharge—Dry Red Lead

	<b>Red Lead in Oil</b>		
	<b>Price to Painters—Price Per 100 Pounds</b>		
	<b>100</b>	<b>50</b>	<b>25</b>
	<b>lbs.</b>	<b>lbs.</b>	<b>lbs.</b>
Dry White Lead	\$26.30	\$	\$
Litharge	25.95	28.40	29.00
Dry Red Lead	27.20	27.95	28.15
Red Lead in Oil	30.65	31.30	31.60

## PATENT CHIMNEYS—

6-inch	\$2.50 lineal foot
8-inch	3.00 lineal foot
10-inch	4.00 lineal foot
12-inch	5.00 lineal foot

## PLASTER—

Neat wall, per ton delivered in S. F. in paper bags, \$17.60.

## PLASTERING (Interior)—

3 Coats, metal lath and plaster	Yard \$3.00
Keene cement on metal lath	3.50
Ceilings with 3/4 hot roll channels metal lath (lathed only)	3.00
Ceilings with 3/4 hot roll channels metal lath plastered	4.50
Single partition 3/4 channel lath 1 side (lathed only)	3.00
Single partition 3/4 channel lath 2 inches thick plastered	8.00
4-inch double partition 3/4 channel lath 2 sides (lath only)	5.75
4-inch double partition 3/4 channel lath 2 sides plastered	8.75
Thermax single partition; 1" channels; 2 1/4" overall partition width. Plastered both sides	7.50
Thermax double partition; 1" channels; 4 1/4" overall partition width. Plastered both sides	11.00
3 Coats over 1" Thermax nailed to one side wood studs or joists	4.50
3 Coats over 1" Thermax suspended to one side wood studs with spring sound isolation clip	5.00

Note—Channel lath controlled by limitation orders.

## PLASTERING (Exterior)—

2 coats cement finish, brick or concrete wall	Yard \$2.50
3 coats cement finish, No. 18 gauge wire mesh	3.50
Lime—\$4.00 per bbl. at yard.	
Processed Lime—\$4.15 per bbl. at yard.	
Rock or Grip Lath—3/8"—30¢ per sq. yd.	
3/8"—29¢ per sq. yd.	
Composition Stucco—\$4.00 sq. yd. (applied).	

## PLUMBING—

From \$200.00 per fixture up, according to grade, quality and runs.

## ROOFING—

'Standard' tar and gravel, 4 ply \$13.00 per sq. for 30 sqs. or over.  
Less than 30 sqs. \$16.00 per sq.  
Tile \$40.00 to \$50.00 per square.  
No. 1 Redwood Shingles in place, 4 1/2 in. exposure, per square \$18.25  
5/2 No. 1 Cedar Shingles, 5 in. exposure, per square 14.50  
5/8 x 16"—No. 1 Little Giant Cedar Shingles, 5" exposure, per square 18.25  
4 1/2 No. 1-24" Royal Cedar Shingles 7 1/2" exposure, per square 23.00  
Roof at with Gravel \$5.50 per sq.

Asbestos Shingles, \$27 to \$35 per sq. laid.  
1/2 to 3/4 x 25" Resawn Cedar Shakes,  
10" Exposure \$30.00  
3/4 to 1 1/4 x 25" Resawn Cedar Shakes,  
10" Exposure \$35.00  
1 x 25" Resawn Cedar Shakes,  
10" Exposure \$22.00  
Above prices are for shakes in place.

## SEWER PIPE—

C.I. 6-in. to 24-in. B. & S. Class B and heavier, per foot \$99.50  
Vitrified, per foot: L.C.L. F.O.B. Warehouse, San Francisco.  
Standard, 8-in. \$ .66  
Standard, 12 in. 1.30  
Standard, 24-in. 5.41  
Clay Drain Pipe, per 1,000 L.F. L.C.L., F.O.B. Warehouse, San Francisco:  
Standard, 6-in. per M. \$240.00  
Standard, 8-in. per M. 400.00

## SHEET METAL—

Windows—Metal, \$2.50 a sq. ft.  
Fire doors (average), including hardware \$2.80 per sq. ft., size 12x12'. \$3.75 per sq. ft., size 3'x6'.

## SKYLIGHTS—(not glazed)

Galvanized iron, per sq. ft. \$1.25  
Vented hip skylights, per sq. ft. 2.25  
Aluminum, puttyless, (unglazed), per sq. ft. 1.25  
(installed and glazed), per sq. ft. 1.85

## STEEL—STRUCTURAL—

\$290 per ton erected, when out of mill.  
\$350 per ton erected, when out of stock.

## STEEL REINFORCING—

\$200.00 per ton, in place.  
1/4-in. Rd. (Less than 1 ton) per 100 lbs. \$9.90  
3/8-in. Rd. (Less than 1 ton) per 100 lbs. 7.80  
1/2-in. Rd. (Less than 1 ton) per 100 lbs. 7.50  
5/8-in. Rd. (Less than 1 ton) per 100 lbs. 7.25  
3/4-in. & 7/8-in. Rd. (Less than 1 ton) 7.15  
1 in. & up (Less than 1 ton) 7.10  
1 ton to 5 tons, deduct 25¢.

## STORE FRONTS—

Individual estimates recommended. See ESTIMATORS DIRECTORY for Architectural Veneer (3), and Mosaic Tile (35).

## TILE—

Ceramic Tile Floors—Commercial \$1.20 to \$1.60 per sq. ft.  
Cove Base—\$1.40 per sq. ft.  
Quarry Tile Floors, 6x6" with 8" base @ \$1.35 per sq. ft.  
Tile Wainscots & Floors, Residential, 4 1/4 x 4 1/4", @ \$1.65 to \$2.00 per sq. ft.  
Tile Wainscots, Commercial Jobs, 4 1/4 x 4 1/4" Tile, @ \$1.50 to \$1.65 per sq. ft.  
Asphalt Tile Floor 1/8" - 5/16" @ \$1.8 - \$3.35 sq. yd.  
Light shades slightly higher.  
Cork Tile—\$ .70 per sq. ft.  
Mosaic Floors—See dealers.  
Linoleum tile, per sq. ft. \$ .65  
Rubber tile, per sq. ft. \$ .55 to \$ .75

## Furring Tile

Scored		F.O.B. S. F.
12 x 12, each		1.17
Kraftite: Per square foot	Small	Large
Patio Tile—Niles Red	Lots	Lots
12 x 12 x 3/8 inch, plain	\$ .40	\$ .36
6 x 12 x 3/8 inch, plain	.44	.39
6 x 6 x 3/8 inch, plain	.46	.42

<b>Building Tile—</b>	
8 1/2 x 12 inches, per M	\$139.50
6 1/2 x 12 inches, per M	105.00
4 1/2 x 12 inches, per M	84.00
<b>Hollow Tile—</b>	
12 x 12 x 2 inches, per M	\$146.75
12 x 12 x 3 inches, per M	156.85
12 x 12 x 4 inches, per M	177.10
12 x 12 x 6 inches, per M	235.30

## VENETIAN BLINDS—

75¢ per square foot and up. Installation extra.

## WINDOWS—STEEL—INDUSTRIAL—

Cost depends on design and quality required

# ARCHITECT AND ENGINEER ESTIMATOR'S DIRECTORY

## Building and Construction Materials

**EXPLANATION**—Building and construction materials are shown in major classified groups for general identification purposes with names and addresses of suppliers of materials listed in detail under group classification where name first appears—main offices are shown first with branch or district offices following. The numeral appearing in listings \*(3) refers to the major group classification where complete data on the dealer, or representative, may be found.

<b>ADHESIVES (1)</b> Wall and Floor Tile Adhesives <b>THE CAMBRIDGE TILE MFG. CO. *1351</b>	<b>BUILDING PAPERS &amp; FELTS (9)</b> <b>ANGIER PACIFIC CORP.</b> San Francisco 5: 55 New Montgomery St., DO 2-4416 Los Angeles: 7424 Sunset Blvd. <b>PACIFIC COAST AGGREGATES, INC. *1111</b> <b>SISALKRAFT COMPANY</b> San Francisco 5: 55 New Montgomery St., EX 2-3066 Chicago, Ill.: 205 West Wacker Drive	Los Angeles: 923 E. 3rd, TR 8282 Seattle: 3440 E. Marginal Way Diversified (Magnesite, Asphalt Tile, Composition, Etc.) <b>LE ROY OLSON CO.</b> San Francisco 10: 3070 - 17th St., HE 1-0188 Sleepers (composition) <b>LE ROY OLSON CO.</b>
<b>AIR CONDITIONING (2)</b> Air Conditioning & Cooling <b>UTILITY APPLIANCE CORP.</b> Los Angeles 58: 4851 S. Alameda St. San Francisco: 1355 Market St., UN 1-4908	<b>BUILDING HARDWARE (9a)</b> <b>THE STANLEY WORKS</b> San Francisco: Monadnock Bldg., YU 6-5914 New Britain, Conn.	<b>GLASS (16)</b> <b>W. P. FULLER COMPANY</b> San Francisco: 301 Mission St., EX 2-7151 Los Angeles, Calif. Portland, Ore.
<b>ARCHITECTURAL PORCELAIN ENAMEL (2a)</b> <b>CALIFORNIA METAL ENAMELING CO.</b> Los Angeles: 6904 E. Slauson, UN 01268 San Francisco: O'Keefe's, 55-11th St., UN 3-4445 Portland: Beaver Sheet Metal & Roofing Co., 924 N. Russell St., TR 6766 Seattle: Teclar Aluminum Co., 625 Yale Ave. N., SE 8494 Salt Lake City: S. A. Roberts & Co., 109 W. 2nd South, Salt Lake 4-4431 Phoenix: Baker-Thomas Co., 300 S. 12th, Phoenix 4-5503 Tucson: Lasing-Garrett Co., 19 S. Tyndall Ave., TU 2-2893 Albuquerque: Welch-Irwin Corp., 1726 Lomas Blvd. NE.	<b>CABINETS &amp; FIXTURES (9b)</b> <b>FINK &amp; SCHINDLER, THE; CO.</b> San Francisco: 522 Brannan St., EX 2-1513	<b>HEATING (17)</b> <b>S. T. JOHNSON CO.</b> Oakland 8: 940 Arlington Ave., OL 2-6000 San Francisco: 585 Potrero Ave., MA 1-2757 Philadelphia 8, Pa.: 401 N. Broad St. <b>SCOTT COMPANY</b> San Francisco: 243 Minna St., YU 2-0400 Oakland: 113 - 10th St., GL 1-1937 San Jose, Calif. Los Angeles, Calif. <b>UTILITY APPLIANCE CORP. *121</b>
<b>ARCHITECTURAL VENEER (3)</b> Ceramic Veneer <b>GLADDING, McBEAN &amp; CO.</b> San Francisco: Harrison at 9th St., UN 1-7400 Los Angeles: 2901 Los Feliz Blvd., OL 2121 Portland: 110 S.E. Main St., EA 6179 Seattle: 1500 First Ave. S., EL 4711 Spokane: 1102 N. Monroe St., BR 3259 <b>THE CAMBRIDGE TILE MFG. CO. *1351.</b>	<b>CEMENT (10)</b> <b>IDEAL CEMENT COMPANY (Pacific Division)</b> San Francisco 4: 310 Sansome St., GA 1-4100 <b>PACIFIC COAST AGGREGATES, INC. *1111</b>	<b>Electric Heaters</b> <b>WESTIX ELECTRIC HEATER CO.</b> San Francisco 5: 390 First St., GA 1-2211 Los Angeles: 520 W. 7th St., MI 8096 Portland: Terminal Sales Bldg., BE 2050 Seattle: Securities Bldg., SE 5028 Designer of Heating <b>THOMAS B. HUNTER</b> San Francisco 4: 41 Sutter St., GA 1-1164
<b>ARCHITECTURAL VENEER (3)</b> Porcelain Veneer <b>PORCELAIN ENAMEL PUBLICITY BUREAU</b> Oakland 12: Room 601 Franklin Building Pasadena 8: P. O. Box 186, East Pasadena Station Granite Veneer <b>VERMONT MARBLE COMPANY</b> San Francisco 5: 525 Market St., SU 1-6747 Los Angeles: 3522 Council St., DU 2-7834 Marble Veneer <b>VERMONT MARBLE COMPANY</b> San Francisco 5: 525 Market St., SU 1-6747 Los Angeles: 3522 Council St., DU 2-7834	<b>CONCRETE AGGREGATES (11)</b> Ready Mixed Concrete <b>PACIFIC COAST AGGREGATES, INC.</b> San Francisco: 400 Alabama St., KL 2-1616 Sacramento: 16th and A Sts., GI 3-6586 San Jose: 790 Stockton Ave., CY 2-5620 Oakland: 2400 Peralta St., GL 1-0177 Stockton: 820 So. California St., ST 8-8643 Lightweight Aggregates <b>AMERICAN PERLITE CORP.</b> Richmond: 26th & B. St. - Yd. 2, RI 4307	<b>INSULATION AND WALL BOARD (18)</b> <b>LUMBER MANUFACTURING CO.</b> San Francisco: 225 Industrial Ave., JU 7-1760 <b>PACIFIC COAST AGGREGATES, INC. *1111</b> <b>SISALKRAFT COMPANY *191</b> <b>WESTERN ASBESTOS COMPANY</b> San Francisco: 675 Townsend St., KL 2-3868 Oakland: 251 Fifth Avenue, GL 1-2345 Stockton: 733 S. Van Buren, ST 4-9421 Sacramento 1331 - T St., HU 1-0125 Fresno: 434 - P St., FR 2-1600
<b>BANKS - FINANCING (4)</b> <b>CROCKER FIRST NATIONAL BANK OF S. F.</b> San Francisco, Post & Montgomery Sts., EX 2-7700	<b>DOORS (12)</b> Hollywood Doors <b>WEST COAST SCREEN CO.</b> Los Angeles: 1127 E. 63rd St., AD 1-1108 <b>W. P. FULLER CO.</b> Seattle, Tacoma, Portland <b>NICOLAI DOOR SALES CO.</b> San Francisco: 3045 19th St. <b>F. M. COBB CO.</b> Los Angeles & San Diego <b>SOUTHWESTERN SASH &amp; DOOR</b> Phoenix, Tucson, Arizona El Paso, Texas <b>HOUSTON SASH &amp; DOOR</b> Houston, Texas	<b>IRON—Ornamental (10)</b> <b>MICHEL &amp; PFEFFER IRON WORKS, INC. *1131</b>
<b>BATHROOM FIXTURES (5)<sup>2</sup></b> Metal <b>THE CAMBRIDGE TILE MFG. CO. *1351</b> Ceramic <b>THE CAMBRIDGE TILE MFG. CO. *1351</b>	Screen Doors <b>WEST COAST SCREEN DOOR CO.</b> (See above)	<b>LANDSCAPING (20)</b> Landscape Contractors <b>HENRY C. SOTO CORP.</b> Los Angeles: 13,000 S. Avalon Blvd., ME 4-6617
<b>BRASS PRODUCTS (16)</b> <b>GREENBERG'S, M. &amp; SONS</b> San Francisco 7: 765 Folsom, EX 2-3143 Los Angeles 23: 1258 S. Boyle, AN 3-7108 Seattle 4: 1016 First Ave. So., MA 5140 Phoenix: 3009 N. 19th Ave., Apt. 92, PH 2-7663 Portland 4: 510 Builders Exch. Bldg., AT 6443	<b>FIRE ESCAPES (13)</b> <b>MICHEL &amp; PFEFFER IRON WORKS, INC.</b> South Linden & Tanforan Ave. South San Francisco: 74-8362	<b>LIGHTING FIXTURES (21)</b> <b>SMOOT-HOLMAN COMPANY</b> Inglewood, Calif., OR 8-1217 San Francisco: 55 Mississippi St., MA 1-8474
<b>BRICKWORK (7).</b> Face Brick <b>GLADDING, McBEAN &amp; CO. *131</b> <b>KRAFTILE *1351</b> <b>REMILLARD-DANDINI CO.</b> San Francisco 4: 400 Montgomery St., EX 2-4988	<b>FIREPLACES (14)</b> Heat Circulating <b>SUPERIOR FIREPLACE CO.</b> Los Angeles: 1708 E. 15th St., PR 8393 Baltimore, Md.: 601 N. Point Rd.	<b>LUMBER (22)</b> Shingles <b>LUMBER MANUFACTURING CO. *1181</b>
<b>BRONZE PRODUCTS (8)</b> <b>GREENBERG'S, M. &amp; SONS *161</b>	<b>FLOORS (15)</b> Hardwood Flooring <b>HOGAN LUMBER COMPANY</b> Oakland: Second and Alice Sts., GL 1-6861 Floor Tile <b>GLADDING, McBEAN &amp; CO. *131</b> <b>KRAFTILE *1351</b> Floor Tile (Ceramic Mosaic) <b>THE CAMBRIDGE TILE MFG. CO. *1351</b> Floor Treatment & Maintenance <b>HILLYARD SALES CO. (Western)</b> San Francisco: 470 Alabama St., MA 1-7766	<b>MARBLE (23)</b> <b>VERMONT MARBLE COMPANY</b> San Francisco 5: 525 Market St., SU 1-6747 Los Angeles 4: 3522 Council St., DU 2-7834 <b>METAL LATH EXPANDED (24)</b> <b>PACIFIC COAST AGGREGATES, INC. *1111</b> <b>MILLWORK (25)</b> <b>FINK &amp; SCHINDLER, THE; CO. *19b)</b> <b>LUMBER MANUFACTURING COMPANY *1181</b> <b>MULLEN MANUFACTURING COMPANY</b> San Francisco: 60-80 Rausch St., UN 1-5815

PACIFIC MANUFACTURING COMPANY  
San Francisco: 16 Beale St., GA 1-7755  
Santa Clara: 2610 The Alameda, SC 607  
Los Angeles, 6820 McKinley Ave., TH 4196

**PAINTING (26)**

Paint  
W. P. FULLER COMPANY \* (16)

**PLASTER (27)**

Interiors - Metal Lath & Trim  
PACIFIC COAST AGGREGATES, INC. \* (111)  
Exteriors  
PACIFIC PORTLAND CEMENT COMPANY \* (28)

**PLASTIC CEMENT (28)**

IDEAL CEMENT COMPANY  
San Francisco: 310 Sansome St., GA 1-4100

**PLUMBING (29)**

THE HALSEY TAYLOR COMPANY  
Redlands, Calif.  
Warren, Ohio  
THE SCOTT COMPANY \* (17)  
MAVS DRINKING FAUCET COMPANY  
Berkeley 10: 1435 Fourth St., LA 5-3341  
CONTINENTAL WATER HEATER COMPANY  
Los Angeles 31: 1801 Pasadena Ave., CA 6178  
SIMONDS MACHINERY COMPANY  
San Francisco: 816 Folsom St., DO 2-6794  
Los Angeles: 455 East 4th St., MU 8322  
SECURITY VALVE COMPANY  
Los Angeles 31: 410 San Fernando Rd., CA 6191

**RESILIENT TILE (30)**

LE ROY OLSON CO. \* (15)

**SEWER PIPE (32)**

GLADDING, McBEAN & CO. \* (13)

**SHEET METAL (32)**

Windows  
DETROIT STEEL PRODUCTS COMPANY  
Oakland 8: 1310 - 63rd St., OL 2-8826  
San Francisco: Russ Building, DO 2-0890  
MICHEL & PFEFFER IRON WORKS, INC. \* (113)  
PACIFIC COAST AGGREGATES, INC. \* (11)

**Fire Doors**

DETROIT STEEL PRODUCTS COMPANY

**Skylights**

DETROIT STEEL PRODUCTS COMPANY

**STEEL—STRUCTURAL (33)**

COLUMBIA STEEL CO.  
San Francisco: Russ Bldg., SU 1-2500  
Los Angeles: 2087 E. Slauson, LA 1171  
Portland: 2345 N. W. Nicolai, 8E 7261  
Seattle: 1331 3rd Ave. Bldg., MA 1922  
Salt Lake City: Walker Bank Bldg., SL 3-6733  
HERRICK IRON WORKS  
Oakland: 18th & Campbell Sts., GL 1-1767  
JUDSON PACIFIC-MURPHY CORP.  
Emeryville: 4300 Eastshore Highway, OL 3-1717  
REPUBLIC STEEL CORP.  
San Francisco: 116 N. Montgomery St., SA 1-0977  
Los Angeles: Edison Building  
Seattle: White-Henry-Stuart Building  
Salt Lake City: Walker Bank Building  
Denver: Continental Oil Building  
SAN JOSE STEEL COMPANY  
San Jose 195 North Thirtieth St., CO 4184

**STEEL—REINFORCING (34)**

REPUBLIC STEEL CORP. \* (33)  
HERRICK IRON WORKS \* (133)  
SAN JOSE STEEL CO. \* (133)  
COLUMBIA STEEL CO. \* (133)

**CLAY TILE (35)**

THE CAMBRIDGE TILE MFG. CO.  
San Francisco 10: 470 Alabama St., UN 3-1666  
Los Angeles 19: 1335 S. La Brea, WE 3-7800  
GLADDING, McBEAN & CO. \* (3)  
KRAFTILE  
Niles, Calif.: Niles 3611  
San Francisco 5: 50 Hawthorne St., DO 2-3780  
Los Angeles 13: 406 South Main St., MU 7241

**TIMBER—REINFORCING (36)**

Trusses  
WYERHAEUSER SALES CO.  
Tacoma, Wash.  
St. Paul, Minn.  
Newark, N. J.  
Treated Timber  
J. H. BAXTER CO.  
San Francisco 4: 333 Montgomery St., DO 2-3883  
Los Angeles 13: 601 West Fifth St., MI 6294

**WALL TILE (37)**

THE CAMBRIDGE TILE MFG. CO. \* (15)  
GLADDING, McBEAN & CO. \* (13)  
KRAFTILE COMPANY \* (15)

**WINDOWS STEEL (38)**

DETROIT STEEL PRODUCTS CO. \* (132)  
MICHEL & PFEFFER IRON WORKS, INC. \* (113)  
PACIFIC COAST AGGREGATES, INC. \* (111)

**GENERAL CONTRACTORS (39)**

BARRETT & HILP  
San Francisco: 918 Harrison St., DO 2-0700  
Los Angeles: 234 W. 37th Place, AD 4-3161  
DINWIDDIE CONSTRUCTION COMPANY  
San Francisco: Crocker Building, YU 6-2718  
CLINTON CONSTRUCTION COMPANY  
San Francisco: 923 Folsom St., SU 1-3440  
MATTOCK CONSTRUCTION COMPANY  
San Francisco: 604 Mission St., GA 1-5516  
PARKER, STEFFENS & PEARCE  
San Francisco: 135 So. Park, EX 2-6639  
STOLTE, INC.  
Oakland: 8451 San Leandro Blvd., TR 2-1064  
SWINERTON & WALBERG COMPANY  
San Francisco: 225 Bush St., GA 1-2980  
Oakland: 1723 Webster St., HI 4-4322  
Los Angeles, Sacramento, Denver  
P. J. WALKER COMPANY  
San Francisco: 391 Sutter St., YU 6-5916  
Los Angeles: 714 W. Olympic Blvd., RI 7-5521

**TESTING LABORATORIES**

(ENGINEERS & CHEMISTS (40))  
ABBOT A. HANKS, INC.  
San Francisco: 624 Sacramento St., GA 1-1697  
ROBERT W. HUNT COMPANY  
San Francisco: 251 Kearny St., EX 2-4634  
Los Angeles: 3050 E. Slauson, JE 9131  
Chicago, New York, Pittsburgh  
PITTSBURGH TESTING LABORATORY  
San Francisco: 651 Howard St., EX 1-2747

**BUILDING TRADES WAGE (JOB SITES) NORTHERN, CENTRAL AND SOUTHERN CALIFORNIA**

ATTENTION: The following are the PREVAILING hourly rates of compensation being paid and in effect by employers by agreement between employees and their union; or as recognized and determined by the U. S. Department of Labor. (September 1, 1952.)

CRAFT	San Francisco	Alameda	Contra Costa	Fresno	Sacramento	San Joaquin	Santa Clara	Solano	Los Angeles	San Bernardino	San Diego	Santa Barbara	Kern
<b>ASBESTOS WORKERS</b>	\$2.585	\$2.585	\$2.585	\$2.585	\$2.585	\$2.585	\$2.585	\$2.585	\$2.25	\$2.25	\$2.25	\$2.25	\$2.25
BOLLERMAKERS	2.48	2.48	2.48	2.48	2.48	2.48	2.48	2.48		3.00	3.00	3.00	3.00
BRICKLAYERS	2.25	2.25	2.25	2.25	2.25	2.25	2.25	2.25		2.25	2.25	2.25	2.25
BRICKLAYERS, HODCARRIERS	2.45	2.45	2.45	2.45	2.45	2.45	2.45	2.45	1.94	1.94	1.94	1.94	1.94
CARPENTERS	2.60	2.60	*2.39	*2.39	*2.39	*2.39	*2.39	*2.39	2.29	2.57	2.57	2.57	2.43
CEMENT FINISHERS	2.57	2.57	2.57	2.57	2.57	2.57	2.57	2.57	2.57	2.57	2.57	2.57	2.57
ELECTRICIANS	3.00	3.00	3.00	3.00	3.00	3.00	3.00	3.00	2.75	2.75	2.75	2.75	2.75
ELEVATOR CONSTRUCTORS	2.75	2.70	2.45	2.75	2.915	2.915	2.915	2.915	2.25	2.25	2.25	2.25	2.25
ENGINEERS: MATERIAL HOIST	2.54	2.54	2.54	2.54	2.54	2.54	2.54	2.54	1.9875	1.9875	1.9875	1.9875	1.9875
GLAZIERS	2.30	2.30	2.30	2.30	2.25	2.30	2.30	2.30	2.16	2.16	2.16	2.16	2.12
IRONWORKERS: ORNAMENTAL	2.55	2.55	2.45	2.55	2.55	2.55	2.55	2.55	2.70	2.70	2.70	2.70	2.70
REINF. ROOMEN	*2.45	2.45	2.45	2.45	2.45	2.45	2.45	2.45	2.38	2.38	2.38	2.38	2.38
STRUCTURAL	*2.70	2.70	2.70	2.70	2.70	2.70	2.70	2.70	2.70	2.70	2.70	2.70	2.70
LABORERS: BUILDING CONCRETE	1.85	1.85	1.85	1.85	1.85	1.85	1.85	1.85	1.85	1.94	1.94	1.94	1.94
LATHERS	3.00	3.00	3.00	3.00	3.00	3.00	3.00	3.00	2.8125	3.125	3.125	3.125	3.125
MARBLE SETTERS	2.70	2.70	2.70	2.70	2.70	2.70	2.70	2.70	2.70	2.25	2.25	2.25	2.25
MOSAIC & TERRAZZO	**2.6125	2.6125	2.6125	2.6125	2.6125	2.6125	2.6125	2.6125	2.40	2.40	2.40	2.40	2.40
PAINTERS	**2.40	2.40	2.40	2.40	2.40	2.40	2.40	2.40	2.38	2.54	2.475	2.22	2.22
PILEDRIVERS	**2.5575	*2.5575	*2.5575	*2.5575	*2.5575	*2.5575	*2.5575	*2.5575	3.00	3.125	3.125	3.125	3.125
PLASTERERS	3.125	3.145	3.125	3.125	3.00	3.00	3.125	3.00	3.00	3.125	3.125	3.125	3.125
PLASTERERS, HODCARRIERS	2.60				2.50	2.50	2.50	2.50	2.50	2.875	2.25	2.30	2.00
PLUMBERS	2.90	2.90	2.875	2.75	2.75	2.75	2.75	2.75	2.90	2.90	2.90	2.90	2.90
ROOFERS	2.50	2.50	2.50	2.25	2.50	2.50	2.50	2.50	2.45	2.00	1.90	2.00	2.00
SHEET METAL WORKERS	2.475	2.475	2.3125	2.43	2.50	2.50	2.40	2.415	2.475	2.475	2.175	2.90	2.475
SPRINKLER FITTERS	2.75	2.70	2.70	2.625	2.625	2.625	2.75	2.75	2.25	2.25	2.25	2.25	2.25
STEAMFITTERS	2.75	2.90	2.90	2.75	2.625	2.625	2.75	2.75	2.90	2.90	2.90	2.90	2.90
TRUCK DRIVERS—1/2 Ton or less	1.89	1.99	1.89	1.89	1.89	1.89	1.89	1.89					
TILESETTERS	2.955	2.955	2.955	2.955	2.955	2.955	2.955	2.955	2.65	2.45	2.45	2.45	2.45

\* 6 Hour Day. \*\* 7 Hour Day. \*\*\* Before C.I.S.C. for 15% increase.

Prepared and compiled by:

CENTRAL CALIFORNIA CHAPTER, ASSOCIATED GENERAL CONTRACTORS OF AMERICA, with the assistance and cooperation of secretaries of General Contractors Associations and Builders Exchanges of Northern California; and the above information for southern California is furnished by the Labor Relations Department of the Southern California Chapter, ASSOCIATED GENERAL CONTRACTORS OF AMERICA.



**ARCHITECT MOVES OFFICES  
TO NEW LOCATION**

Architect Mario L. Gaidano, recently announced removal of offices from 177 Post Street in San Francisco, and is now located at 605 Washington Street, San Francisco.

**INTERNATIONAL GLASS EXPANDS  
BUSINESS NATION-WIDE**

Purchase of plant facilities and equipment of the Perrault Glass Fiber Corp. in Newport, Arkansas, and re-engineering and expansion of the firm's plant in Puente, California, will make International Glass Corp. one of the foremost glass fiber and optical manufacturers in the nation.



**New Plant at Puente, California.**

Plastic laminated sheets, corrugated and flat, in a large selection of colors, will be manufactured at Puente for use in industrial and residential architecture, according to a recent announcement by Roy J. Scott, president of the firm.

**STEEL MANUFACTURERS ATTEND  
NATIONAL INSTITUTE MEETING**

Among prominent West Coast steel men attending the American Institute of Steel Construction fifth annual meeting engineering conference in Detroit this month were Richard Murphy, Judson Pacific Murphy Co.; S. G. Herrick, Herrick Iron

Works, and Harry B. Corlett, district engineer for the American Institute of Steel Construction.

Over two-hundred attended the two day conference held in the Detroit Engineering Society Building.

**LUMBER DIRECTORY ISSUED:** The West Coast Lumbermen's Association, Portland, Oregon, recently issued their 1953 "Where to Buy" directory which lists lumber mills, personnel and production of West Coast sawmills and wood fabricators.

**HOLLYWOOD JUNIOR**  
COMBINATION  
SCREEN and METAL SASH DOOR  
★  
The "WEATHER-WISE"  
DOOR!!

**A VENTILATING SCREEN DOOR  
A SASH DOOR  
A PERMANENT OUTSIDE DOOR  
ALL 3 IN 1!**

Discriminating home owners and architects have chosen Hollywood Junior as the TRIPLE DOOR VALUE in the COMBINATION SCREEN and METAL SASH DOOR field! A sturdy dependable door, constructed of quality material, HOLLYWOOD JUNIOR'S EXCLUSIVE PATENTED FEATURES have outmoded old-fashioned screen doors and other doors of its type entirely! . . . . .

**IT GUARANTEES YOU YEAR 'ROUND  
COMFORT, CONVENIENCE and ECONOMY**

WE ALSO MANUFACTURE A COMPLETE LINE OF  
SHUTTERS, C. C. DOORS, SCREENS, SCREEN DOORS, LOUVRE DOORS

**WEST COAST SCREEN CO.**

1115 EAST 4th STREET ★ LOS ANGELES, CALIFORNIA

★ ★ WRITE FOR FREE ILLUSTRATED LITERATURE ★ ★

**CLASSIFIED ADVERTISING**

RATE: 20c PER WORD . . . CASH WITH ORDER MINIMUM \$5.00

**BUILDERS!** You can make more money; get information you need before it is published elsewhere; Subscribe to the daily ARCHITECTS REPORTS, only \$10.00 per month. Complete information from ARCHITECTS REPORTS, 68 Post Street, San Francisco. Phone DOuglas 2-8311.

**PHOTOGRAPHY.** For the best in construction photography, including exterior and interior, aerial, and progress views . . . you will find as many others have that it's the SKELTON STUDIOS, 875 O'Farrell St., San Francisco. Telephone PRespect 6-1841.

**ARCHITECTURAL DRAFTSMAN WANTED;** Experienced in working drawings and details

for hospitals, schools, and commercial work. Excellent working conditions. Permanent position. W. D. Holdredge, P. O. Box 412, San Luis Obispo, Calif.

**Registered ARCHITECT,** residential and commercial, 17 years experience, seeks association with medium sized firm. Independent work, design, specifications, supervision, client contact. BOX J-3, Architect & Engineer, 68 Post Street, San Francisco, Calif.

**ARCHITECTURAL SLIDING SLEEL SASH.** One lot only — new, half price. 13 units, assorted sizes, 353 square feet total. 3 at 7 ft. x 5 ft.; 4 at 7 ft. x 4 1/2 ft.; 1 at 6 ft. x 4 1/2 ft.; 2 at 6 ft. x 4 ft.; 1 at 7 ft. x 3 1/2 ft.;

1 at 4 1/2 ft. x 3 ft.; 1 at 3 ft. x 3 ft. Phone DElaware 3-7378, San Francisco.

**YOUNG ARCHITECT** — Wanted with some evenings and weekends free during April to assist business couple building S. F. view home. Ideas are formulated, but need professional services at reasonable rate. Address replies to Suite 485, 703 Market St., S. F.

**MODERN FRESCO PAINTINGS ON SLABS** by SIMEON PELENC—Received A.I.A. and Government awards. Approximate size 3 x 4 ft. Suitable for exterior or interior decoration. HELEN PELENC, 1101 Francisco St. San Francisco.

## CONSTRUCTION CONTRACTS AWARDED AND MISCELLANEOUS PERSONNEL DATA

**BOTTLING PLANT BUILDING.** San Francisco. San Francisco Brewing Co., owner. 4-story reinforced concrete and structural steel, \$460,000. ENGINEER: Roy N. Moore, San Francisco. GENERAL CONTRACTOR: Cahill Bros., San Francisco.

**KERN GENERAL HOSPITAL,** Bakersfield, Kern County, owner. Rehabilitation of Ward G at the Kern General Hospital, adding 44-beds, \$11,646. GENERAL CONTRACTOR: Johnson-Western Constn. Co., Los Angeles.

**DENTAL BUILDING.** San Leandro, Alameda County. Dr. A. C. Maass, owner. 2-story, frame and stucco, steel sash, asphalt tile and cork tile and linoleum floors, \$51,897. ARCHITECT: George J. Steuer, San Leandro. GENERAL CONTRACTOR: Landis & Burns, San Leandro.

**OFFICE BUILDING.** Santa Monica. Edwin W. Tell Co., Los Angeles. Two-story frame, stucco, brick and stone veneer office building on Santa Monica Blvd., contains 5000-6000 sq. ft.; composition roof, plate glass, elevator, concrete slab, toilets, patio and electrical work.

**COTTAGE ELEM. SCHOOL.** Sacramento. Arden-Carmichael Union Elem. School District, owner. One-story frame and stucco, 14,000 sq.ft., to cost \$312,844. 12-Classrooms, administration, kindergarten, multi-purpose, toilet rooms. ARCHITECT: John Lyon Reid, San Francisco. GENERAL CONTRACTOR: United Const. Co., Sacramento.

**YMCA ALTERATIONS.** San Bernardino. YMCA Board of Directors, San Bernardino,

owner. New building will be 1-story, with provision for future second story, reinforced masonry, toilet facilities, shower and drying rooms, senior locker and shower rooms, massage room, steam and slumber rooms, 9500 sq.ft.; composition roofing, slab and asphalt tile and glazed tile floors, plate glass, dining facilities, steam heating, metal sash, acoustical work, plaster, lockers, concrete work, plumbing, electrical work. Alterations to existing building, complete re-conditioning and revising of 1st floor and basement.

**REST HOME.** Mt. View, Santa Clara County. Florio Cappelletti, Mt. View, owner. 1-story frame and stucco, concrete floor and asphalt tile, steel sash, \$66,485. ARCHITECT: Higgins & Root, San Jose. GENERAL CONTRACTOR: George J. Lauer, San Jose.

**GRANDSTAND,** Stockton, San Joaquin County. City of Stockton, owner. Reinforced concrete to accommodate 1000 seats, \$36,834. GENERAL CONTRACTOR: J. L. Webster, Galt.

**HIGH SCHOOL ADD'N,** Fortuna, Humboldt County. Fortuna Union High School District, owner. 1-Story frame, redwood exterior, composition shingle roof, asphalt tile floor, ceramic tile work, fold-partitions, metal (toilet partitions), metal sash, acoustical ceiling, \$102,000. ARCHITECT: Harold Gimeno, Santa Ana. GENERAL CONTRACTOR: R. H. Douglas.

**CHURCH.** Sacramento. Temple Methodist Church, San Francisco, owner. Frame and stucco construction, \$144,196. ARCHITECT: Alfred W. Johnson, San Francisco. GENERAL CONTRACTOR: Morris Daley, Burlingame.

**HIGH SCHOOL ADD'N.** Roseville, Placer County. Roseville Union High School District, Roseville, owner. 6-Classrooms, boiler and toilet rooms, \$125,967. ARCHITECT: Gordon Stafford, Sacramento. GENERAL CONTRACTOR: Arthur Odman, Fair Oaks.

**FLEMING TOWNE ELEM. SCHOOL.** Vallejo, Solano County. Vallejo Unified School District, Vallejo, owner. 22-Classrooms, administration, kindergarten, kitchen and toilets, frame and stucco, \$511,674. ARCHITECT: Masten & Hurd, San Francisco. GENERAL CONTRACTOR: J. A. Bryant, Vallejo.

**CHEMISTRY LABORATORY BUILDING,** Livermore, Alameda County. Atomic Energy Commission, San Francisco, owner. 1-Story laboratory, reinforced concrete, 18,000 sq. ft., \$262,733. GENERAL CONTRACTOR: Elmer J. Freethy, El Cerrito.

**HOSPITAL ADDITION.** Castro Valley, Alameda County. Eden Township Hospital District, San Lorenzo, owner. 2-Story addition to a 5-story building, reinforced concrete, steel windows, asphalt tile and terrazzo floors, \$850,000. ARCHITECT: D. D. Stone & Lou Mulloy, San Francisco. GENERAL CONTRACTOR: Williams & Burrows, South San Francisco.

**PAROCHIAL SCHOOL ADDITION.** Reno, Nevada. Roman Catholic Bishop of Reno, Nevada, owner. 1-Story, basement, reinforced concrete and brick. 4-classrooms, assembly room, \$115,402. ARCHITECT: Russell Mills, Reno. GENERAL CONTRACTOR: I. C. Dillard, Reno.

**EXHIBIT BUILDING STATE FAIR.** Sacramento State of California, Sacramento, owner. 1-Story, prefabricated, steel rigid frame, aluminum roof, some mechanical and electrical work included. 200x184 ft., \$97,

600. ARCHITECT: State of California. GENERAL CONTRACTOR: Continental Construction Co., Sacramento.

**BANK BUILDING.** Fresno. Security First National Bank, Los Angeles, owner. 1-Story, mezzanine, reinforced concrete, brick filler walls, light structural steel roof trusses, 40x100 ft., \$72,436. ARCHITECT: Swartz & Hyberg, Fresno. GENERAL CONTRACTOR: Harris Construction Co., Fresno.

**MARKET BUILDING.** Watsonville, Santa Cruz County. Daylight Market, Watsonville, owner. 1-Story, reinforced concrete, wood roof trusses, 50x150 ft., \$55,000. STRUCTURAL ENGINEER: H. M. O'Neil, Oakland. GENERAL CONTRACTOR: G. W. Davis, Watsonville.

**LABORATORY BUILDING.** Salinas, Monterey County. County of Monterey, Salinas, owner. 1-Story, concrete block and structural steel frame addition to the County Hospital, wood roof, \$37,847. ARCHITECT: Robt. Stanton, Carmel. GENERAL CONTRACTOR: F. V. Hampshire, Salinas.

**OFFICE AND SERVICE BUILDING.** Los Angeles. J. N. Ceazan, Los Angeles, owner. Concrete and brick, composition roof, mezzanine, concrete slab floor, hardwood and glass partitions, concrete vault, acoustical tile ceilings, locker rooms, toilets, stall showers, electrical work, 85x179 ft. ARCHITECT: Arthur Froelich, Beverly Hills. GENERAL CONTRACTOR: Pozzo Construction Co., Los Angeles.

**FACTORY AND OFFICE.** Temple City, Los Angeles County. Horning Engineering Co., Temple City, owner. 1-Story, precast panel wall office and factory, composition roof, tapered steel girders, steel sash, plate glass door, brick planter, metal sliding doors, concrete slab floor, forced air heating, toilets, \$25,000. STRUCTURAL ENGINEER: Carl B. Johnson, San Marino. GENERAL CONTRACTOR: Richard A. Hansen, Pasadena.

**HIGH SCHOOL ADDITION,** Albuquerque, New Mexico. Highland High School, Albuquerque, owner. 2-Story, 18-classroom wing addition, \$320,375. ARCHITECT: Louis G. Hesselde, Albuquerque. GENERAL CONTRACTOR: George A. Rutherford, Jr., Albuquerque, New Mexico.

**RESIDENCE.** Claremont Pines, Alameda County. Owner c/o Architect. \$32,695. ARCHITECT: Ponsford & Price, Oakland. GENERAL CONTRACTOR: John P. Kay, Danville.

**TELEPHONE EXCHANGE.** Fowler, Fresno county. General Telephone Co., Lindsay, owner. 1-story masonry and reinforced concrete, steel sash, asphalt tile floors, air conditioning system: 43 x 100 ft. ARCHITECT: Albert C. Martin & Associates, Los Angeles. GENERAL CONTRACTOR: Harris Const. Co., Fresno.

**HIGH SCHOOL ADD'N.** Rio Vista, Solano county. Rio Vista Unified School District, Rio Vista, owner. Classrooms and administration building addition to high school, \$179,498. ARCHITECT: Chas. F. Dean, Sacramento. GENERAL CONTRACTOR: Geo. Roek, Stockton.

**CHURCH BUILDING.** Norwalk, Los Angeles county. Covenant Presbyterian Church, Norwalk, owner. 1-story frame and stucco fellowship hall, offices and storage area; 6000 sq. ft. floor space, composition roof, brick veneer, metal sash, concrete floor with asphalt tile covering, and plastering. ARCHITECTS: Wilkinson & Crosby Los Angeles. GENERAL CONTRACTOR: Shepard & Morgan, San Marino.

**HEATING & COOLING PLANT.** Arizona State Hospital, Phoenix, Arizona State of Arizona, State Hospital Board, owner. Comprises excavation underground tunnels, laying pipe to connect with present power

# FLOORS

**FOR EVERY PURSE  
OR PURPOSE**

HOSPITALS • COMMERCIAL BUILDINGS • WINERIES • CANNERIES • FOOD PROCESSING • INDUSTRIAL BUILDINGS • WAREHOUSES • RESTAURANTS • SCHOOLS

Territories open for Qualified  
Representatives

*Specifications and information  
available on request*

*Free Consultation Service*

**LeROY OLSON  
COMPANY**

3070 Seventeenth Street,  
San Francisco, California



plant; new boiler, also steam driven compressor, and water tower, \$273,655. ENGINEER: N. M. Lowry, Phoenix. GENERAL CONTRACTOR: Homes & Son Const. Co., Phoenix.

**MARKET BUILDING.** Sacramento. Kwong & Associates, Sacramento, owner. 1 and part 2-story concrete block and frame with brick and plate glass front; 23,000 sq. ft., \$130,000. ARCHITECT: Wallace J. Alexander, Sacramento. GENERAL CONTRACTOR: Lyman W. Beutler, Sacramento.

**ADMINISTRATION BUILDING.** Yreka, Siskiyou county. 10th Agricultural Association, Yreka, owner. 1-story wood and frame construction administration building at County Fair Grounds; 21 x 62 ft., \$15,859. GENERAL CONTRACTOR: A. J. McMurry Co., Yreka.

**FACTORY BLDG.** San Leandro, Alameda county. Frank L. Pollard, Oakland, owner. 1-story concrete block, wood roof trusses, steel sash, concrete floors, 40,000 sq. ft., \$200,000. ARCHITECT: Cecil S. Moyer, Oakland. GENERAL CONTRACTOR: A. S. Holmes & Son, Oakland.

**FAIRGROUNDS PAVILION.** Colistoga, Napa county. Napa County, Napa, owner. 1-story concrete block, wood roof trusses, \$42,500. ARCHITECT: Albert Hunter, Jr., Berkeley. GENERAL CONTRACTOR: John Cavaglieri, Colistoga.

**CAFETERIA BLDG.** High School, Daly City, San Mateo county. Jefferson Union High School District, Daly City, owner. 2-story reinforced concrete multi-use, home economics, small theatre building, \$347,313. ARCHITECT: Mario J. Ciampi, San Francisco. GENERAL CONTRACTOR: Ralph Larsen & Son, San Francisco.

**COMMERCIAL BLDG.** San Diego. Handlery Hotels, San Diego, owner. 3-story bldg. will house 6 stores, 20,000 sq. ft., stucco construction, composition roof, concrete slab floor, asphalt tile, forced air heating. ARCHITECT: Richard G. Wheeler, San Diego.

**DRIVE-IN RESTAURANT.** Glendale, Los Angeles county. MacFarlane Candies, Glendale, owner. Brick block, composition roof, concrete slab and asphalt tile floors, plate glass, painted plaster interior, porcelain enamel, toilets, asphalt paving, parking lights. ARCHITECT: Carl L. Maston, Los Angeles. GENERAL CONTRACTOR: Jackson Bros., Los Angeles.

**OFFICE-WAREHOUSE.** Santa Monica Blvd., Los Angeles. Henry Shanedding & Sons, Los Angeles, owners. 2-story reinforced concrete, slab floor, plaster interior, mahogany paneling, aluminum and mahogany doors, metal toilet partitions, galvanized iron gutters and downspouts, projecting steel sash, ceramic tile wainscoting, 130 x 150 ft., \$115,000. ARCHITECT: Roy W. Donley and ENGINEER W. D. Treadway, Los Angeles. GENERAL CONTRACTOR: Millie & Severson, Long Beach.

**GARAGE.** Oakland, Alameda county. Downtown Realty Co., Oakland, owner. 1-story and basement and roof parking, structural steel frame, no walls, ventilating system in basement, concrete floors, some brick work, sprinkler system, \$650,000. STRUCTURAL ENGINEER: R. H. Coolye, Oakland. GENERAL CONTRACTOR: John C. Moore Co., Oakland.

**CHURCH.** Redwood City, San Mateo county. Redeemer Lutheran Church, Redwood City, owner. Single story frame and stucco building, \$147,966. ARCHITECT: Arthur Janssen, Menlo Park. GENERAL CONTRACTOR: Earl W. Emley, Saratoga.

**PAROCHIAL SCHOOL.** Santa Rosa, Sonoma county. Roman Catholic Archbishop of San Francisco, owner. 1-story frame and stucco

building for 4 classrooms, administration offices and toilet rooms, \$77,880. ARCHITECT: J. Clarence Felciano, Santa Rosa. GENERAL CONTRACTOR: Coddling Homes, Santa Rosa.

**HANGAR BLDG.** San Francisco Airport, San Mateo county. United Air Lines, San Francisco, owner. Reinforced concrete walls, structural steel frame, steel sash, 180 ft. wide, \$439,000. STRUCTURAL ENGINEER: H. J. Brunner, San Francisco. GENERAL CONTRACTOR: Barrett & Hilp, San Francisco.

**WAREHOUSE.** Stockton, San Joaquin county. John Eagal Co., Stockton, owner. 1-story concrete block, structural steel roof trusses, wood roof, 13,000 sq. ft., \$48,283. ENGINEER: Ohm & Ecklund, Stockton. GENERAL CONTRACTOR: Nomellini Const. Co., Stockton.

**OFFICE, SALESROOM, WAREHOUSE.** Bakersfield, Kern county. Tay-Holbrook, Inc., Bakersfield, owner. Concrete block, filler walls, face brick front, steel sash, air conditioning, 1-story, 200x114 ft., reinforced structural steel, \$120,000. ARCHITECT: Ernest L. McCoy, Bakersfield. GENERAL CONTRACTOR: Alva Hackney & Son, Bakersfield.

**DEPARTMENT STORE REMODEL.** Sacramento. Hale's Department Store, San Francisco, owner. 3-story and basement, interior and exterior remodel, new architectural porcelain exterior, new show windows, 3 new entrances, glass doors, \$2,000,000. GENERAL CONTRACTOR: Carl J. Henchen, Carmichael.

**CHURCH INTERIOR FINISHING.** Church of the Blessed Sacrament, Los Angeles. Roman Catholic Archbishop of Los Angeles, owner. Work includes glass mosaic, marble, decorative painting, bronze, terrazzo, heating,

electrical, plastone, lath and plaster, asphalt tile, \$200,000. ARCHITECT: J. Earl Trudeau, Alhambra.

**FIRE HOUSE.** Menlo Park, San Mateo county. Menlo Park Fire Protection District, Menlo Park, owner. 1-story brick and frame construction fire house, \$31,860. ARCHITECT: Leslie J. Nichols, Palo Alto. GENERAL CONTRACTOR: Aro & Okerman, Palo Alto.

**OFFICE & REPAIR SHOP.** Oakland, Alameda county. Trailmobile, Inc., Oakland, owner. 1-story structural steel frame, concrete block walls, gypsum slab roof, steel sash, steel rolling doors, wood overhead doors, 30,000 sq. ft., \$275,153. ARCHITECT: Young & Lloyd, Albany. GENERAL CONTRACTOR: Marvin E. Collins, El Cerrito.

**SWIMMING POOL.** La Mesa, San Diego county. City of La Mesa, owner. Excavation, concrete, structural steel, plastering, masonry, ceramic tile, metal sash, metal-clad doors, wire fencing, sprayed-on vinyl plastic film, swimming pool mechanical and deck equipment, \$53,734. ARCHITECT: Eggers & Paddis, La Mesa. GENERAL CONTRACTOR: Dakan Engineering Co., Alhambra.

**HIGH SCHOOL ADD'N.** Easton, Fresno county. Washington Union High School District, Easton, owner. 1-story frame and stucco shop bldg., steel frame, concrete floor, radiant heating, asbestos shingle roof, \$187,999. ARCHITECT: Wm. Hastrup, Fresno. GENERAL CONTRACTOR: Harris Const. Co., Fresno.

**GARAGE BUILDING.** Reno, Nevada. City of Reno, owner. 4-story, reinforced concrete with ramps; 500 car capacity, \$1,000,000. STRUCTURAL ENGINEER: John J. Gould, San Francisco. GENERAL CONTRACTOR: Haas & Haynie, San Francisco.



## *Built-in telephone facilities will make a hit with your clients*

Your clients will appreciate your thoughtfulness if you include built-in telephone facilities in your building plans. Concealed conduit for telephone wiring and conveniently located telephone outlets allow them to change the position of their telephone without detracting from the beauty of their home with exposed wiring.

Just call Pacific Telephone's free Architects and Builders service. We'll be glad to help you plan for better living tomorrow in the homes you are building today.

*Put built-in telephone facilities in your plans*



**Pacific Telephone**



# IN THE NEWS

## SHOPPING CENTER FOR SACRAMENTO

A group of buildings and super-markets representing a cost of \$2,000,000 is being planned for construction near the City of Sacramento, according to R. H. Cooley, Structural Engineer for the project.

The buildings are to be of single story, concrete block design and will be built by John J. Moore Company, General Contractors of Oakland.

## REMODELING CONTRACTOR GROUP BEING FORMED

A group of Southern California remodeling contractors are in the process of incorporating a new trade group to be known as the Remodeling Contractors Association, according to Harold Hammerman, temporary chairman.

Interested contractors are invited to contact Hammerman in Los Angeles.

## MEDICAL BUILDING FOR PALO ALTO

Paul James Huston, Palo Alto architect, has been commissioned to design a Medical Building, comprising three suites, for Palo Alto.

The building will be of 1 and 2-story design and of frame construction with some stone veneer on the exterior. A. G. Frykman of Menlo Park is the General Contractor.

## AIRCRAFT PLANT EXPANDS

Groundbreaking ceremonies were conducted recently for the construction of a new engineering and office building for the Marquardt Aircraft Company at Van Nuys, Los Angeles county.

A 2-story building will add to a \$250,000 expansion program involving an employee cafeteria, paving and lighting of employee parking area, installation of a public address system, and test laboratories.

## OIL PLANT FOR BRECA

The Orange County Planning Commission has approved application of the Union Oil Company, to build a new chemical plant for the manufacture of ammonia and by-products, on a site 14 miles east of the city of Brea.

General offices and administration building, change house and dispensary, warehouse, shop, loaders office and utilities building, compressor building, boiler plant, and tanks are included in the project.

## INDUSTRIAL COMMISSION BUILDING FOR NEVADA

The Nevada Industrial Commission has announced remodeling of a new Industrial Commission building to be erected in Carson City at an estimated cost of \$100,000.

Plans and specifications are being prepared by the architectural firm of Ferris & Erskine of Reno. The building will be of 2-story design with basement and complete interior remodel.

## BRANCH LIBRARY SAN FRANCISCO

The Department of Public Works for the City and County of San Francisco is having the architectural firm of Appleton & Ward San Francisco, design a new branch library to be built on the corner of Chestnut and Webster streets.

Cost of the project is estimated at \$150,000, and will be a 1-story, reinforced concrete building with a brick veneer exterior.

## SEQUOIA HOSPITAL REDWOOD CITY

The Sequoia Hospital District of Redwood City, San Mateo county, will construct a 98-bed wing addition to the Sequoia Hospital, according to hospital authorities.

The addition will be a 3-story reinforced concrete building and will cost \$800,000.

Stone and Mulloy & S. P. Marraiccini of San Francisco are the architects.

## ADDITION TO CAYUCOS ELEMENTARY SCHOOL

Architect John Badgley of John Badgley & Associates, San Luis Obispo, is responsible for plans and specifications for a major San Luis Obispo county school addition.

Classrooms, cafeteria, corridors and utility rooms are being built for the Cayucos Elementary School District at a cost of \$51,700.

C. C. Sharps of Arroyo Grande is the general contractor. The new facilities will be ready for use in the 1953-54 school term.

## FACTORY BUILDING FOR SAN FRANCISCO

The Kortick Mfg. Co., San Francisco, have announced construction of a 1-story reinforced concrete building of the new tilt-up method, with wood trusses, is to be built in San Francisco at a cost of \$160,000. It will contain 57,000 sq. ft.

Simpson & Stratta, San Francisco, are the Engineers.

## MOVABLE PARTITIONS VENTURA COURTHOUSE

Movable interior partitions will be a feature of the \$325,000 annex to be built at the Ventura County Courthouse in Ventura.

Two-stories in height, the annex will be fireproof and will provide facilities for a courtroom and offices.

Roy C. Wilson of Santa Paula is the architect.

## BLOOD BANK BUILDING

Architects Stone & Mulloy, and S. P. Marraiccini associate, have completed plans and specifications for a 1-story frame, stucco, and structural steel building to be built in Millbrae, San Mateo county, for the San Mateo County Blood Bank.

Cost of the project is estimated at \$126,000.

## HIGH SCHOOL GYMNASIUM

Architects Masten & Hurd of San Francisco have been commissioned by the Fremont Union High School District of Santa Clara county, to draft plans and specifications for the construction of a new gymnasium building at the Fremont High School in Sunnyvale.

## PHOEBE HEARST SCHOOL PLANNED

The Sacramento Board of Education has announced construction will soon start on the new \$325,000 elementary school to be known as the Phoebe Hearst School.

It will comprise 14-classes, administration, kindergarten, nurses, and toilet room and will be of frame and stucco construction.

Harry J. Devine of Sacramento is the architect.

## WEST ORANGE SCHOOL WILL ADD CLASSROOMS

Architect Paul O. Davis is preparing plans for the West Orange Grammar School

in Orange, Calif., which will add five rooms to the present building.

Three rooms were added in 1950 and with the present addition the unit will comprise a total of 14 rooms.

## ARCHITECT OPENS NEW OFFICES

Earl J. Taylor, A. I. A., architect, has opened offices in North Sacramento for the general practice of architecture.

A graduate of the University of Utah with a degree in civil engineering, Taylor took post graduate work in architecture at the University of Michigan and the U. S. Naval Academy at Annapolis. Before entering private practice in the Sacramento area, he was a naval architect at the Puget Sound Naval Shipyards and was also with the U. S. Bureau of Reclamation.

## SCHOOL BONDS APPROVED

Qualified voters of the Ravenswood Elementary School District of San Mateo County approved a bond election of \$489,000 at a recent special election.

Funds are to be used in the construction of Elementary School buildings in East Palo Alto.

## SHOPPING CENTER HOUSING PROJECT

The Sterling Building Company of San Francisco have applied to San Mateo county for a zoning permit to construct a private housing project and shopping center in Pedro Valley near Sharp Park.

The project will include 3000 residences and will cost approximately \$35,000,000.

## CLASSROOM ADDITION

Architects Laurence D. Viole, Ayres and Fiege of North Hollywood have completed plans for the addition of classrooms to the St. Jane Francis de Chantal Parish of Los Angeles.

The additions will comprise granite construction, composition white rock roofing, concrete slab floors with asphalt tile, interior stucco and plaster work, pipe columns, forced air heating with thermostatic control, and toilets.

## CONTRACTOR GETS MILITARY WORK

Hal E. Hayes Contractor, Inc., of North Hollywood, has been awarded three Army projects near Salt Lake City, Utah. They will construct an initial 150 homes at a cost of \$1,500,000 at the Desert Chemical Depot, Desert, Utah; 53 homes at the Utah General Depot, Ogden, at a cost of \$1,000,000; and 25 residential units at the Tooele Ordnance Center at a cost of \$250,000.

Contracts were let through the Corps of Engineers, Sixth Army, San Francisco District.

## OFFICE BUILDING IN BURLINGAME

R. P. Etienne and S. W. Gates of Burlingame have commissioned architects Sharpe & Brown of San Mateo to draft plans for the construction of a new office building on El Camino Real.

The new structure will comprise a 2-story concrete block with some structural steel building with brick work. 50x85 ft the estimated cost is \$100,000.

## SHOPPING CENTER FOR HAYWARD

The Amos Parish City, architectural firm of New York City, has been commis-

**STATIONERY  
SCHOOL & OFFICE  
SUPPLIES**

•  
**Printing Engraving  
Announcements**

•  
**CENTER STATIONERY**

**468 McAllister  
San Francisco UN 1-3703**

sioned by H. W. Owen of Hayward, California, to draft plans and specifications for the construction of a \$20,000,000 Shopping Center to be built near Hayward.

The project calls for a group of store buildings.

**ARCHITECT  
SELECTED**

The architectural firm of Buchter & Lillis, Vallejo, has been selected by the Board of the Vallejo Unified School District to design a new Administration building to be built in Vallejo.

**PORTLAND CEMENT  
INFORMATION BUREAU**

Architects, contractors, and engineers seeking information relative to prevention of shrinkage cracks in concrete floor slabs, or concrete floor slab warping, or prevention of excessive dusting of concrete walls and ceilings, or almost any information pertaining to the use of concrete may secure such information from the Portland Cement Information Bureau, 564 Market Street, San Francisco.

The Bureau, in charge of Jay E. Jellick, answers dozens of questions on Portland Cement concrete and is designed to serve the entire construction industry.

**NEW HIGH CAPACITY  
GAS FIRED INCINOR**

Field tests have been completed on a new twin-burner incinor of four bushel capacity for commercial use.

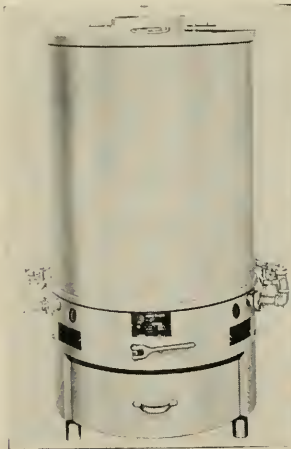

It uses LP, manufactured, natural or mixed gases at a rate of 50,000 BTU per hour input. Standard unit has 1/4" thick steel plate combustion chamber and also furnished with heavy refractory lining at extra cost. Solves problem of hospitals, clinics, restaurants, stores, motels and institutions. Manufactured by Incineration Division, Bowser, Inc., Cairo, Ill.

**OFFICE BUILDING  
FOR BAKERSFIELD**

Architect Robert N. Eddy, Bakersfield, is designing a new office building to be built in Bakersfield for the InTex Oil Company.

The building will be 1-story in height, and will contain 7500 sq. ft. of floor space.

**DINWIDDIE  
CONSTRUCTION  
COMPANY**

•  
**BUILDERS**

•  
CROCKER BUILDING  
SAN FRANCISCO



**HERRICK  
IRON WORKS**  
STRUCTURAL STEEL  
REINFORCING STEEL

1878 AND CAMPBELL STS.  
OAKLAND, CALIF.  
Phone GLencourt 1-1767

Phone GARfield 1-1164

**Thomas B. Hunter**  
DESIGNER OF HEATING

AIR CONDITIONING  
VENTILATING AND WIRING  
SYSTEMS, MECHANICAL  
AND ELECTRICAL EQUIP-  
MENT OF BUILDINGS

☆  
41 SUTTER STREET  
ROOM 710  
San Francisco California

Subscribe  
Now —

**ARCHITECT  
and  
ENGINEER**

**\$3.00  
Per Year**

**MULLEN MFG.  
COMPANY**

—  
BANK, STORE AND OFFICE  
FIXTURES—CABINET WORK  
OF GUARANTEED QUALITY  
CHURCH SEATING

—  
Office and Factory  
60-80 RAUSCH ST., Bet. 7th and 8th Sts.  
San Francisco  
Telephone UNDERhill 1-5815

**CLASSIFIED  
ADVERTISING**

Will Bring Results

—USE—

**ARCHITECT  
and  
ENGINEER**

68 Post St. San Francisco

*Fine*  
**ENGRAVINGS**  
**POOR**  
**RICHARD**  
PHOTO ENGRAVING CO  
320-324 COMMERCIAL STREET  
SAN FRANCISCO 33

**ABBOT A. HANKS, INC.**  
**Engineers & Chemists**

INSPECTING — TESTING — CONSULTING  
 CONCRETE • STEEL • MATERIALS  
 CHEMICAL AND TESTING  
 LABORATORIES  
 • RESEARCH AND INVESTIGATION •  
 TESTS OF STRUCTURAL MATERIALS  
 DESIGN OF CONCRETE MIXES  
 SHOP AND ERECTION INSPECTION OF  
 STRUCTURES AND EQUIPMENT  
 INVESTIGATION OF STRUCTURES  
 AND MATERIALS  
 TESTS AND INVESTIGATION OF  
 FOUNDATION SOILS  
 FIRE RESISTANCE AND INSULATION  
 TESTS

624 Sacramento Street, San Francisco

**PITTSBURGH  
 TESTING LABORATORY**

**ENGINEERS AND CHEMISTS**

Testing and Inspection of Concrete,  
 Steel and Other Structural Materials

Design of Concrete Mixes

Offices in all principal cities

651 Howard St., San Francisco 5  
 EXbrook 2-1747

**MATTOCK  
 CONSTRUCTION  
 COMPANY**



**BUILDERS**



604 MISSION STREET  
 SAN FRANCISCO

**ARCHITECT  
 and  
 ENGINEER**

Please enter my subscription for  
 ..... year ... My check in the  
 amount of \$ ..... is attached.  
 1 year . . . . \$3.00  
 2 years . . . . 5.00

Name .....

City .....

State .....

**Index to Advertisers**

ALLIANCE Engineer ... 36  
 ARCHITECTS Reports ... 38  
 BARRETT & HILP, Contractors ... 35  
 BY-CHEMICAL Products Co. .... 34  
 CALIFORNIA Metal Enameling Co. ... 31  
 CAMBRIDGE Tile Mfg. Company ..... \*

CENTER Stationery ..... 47  
 CLAY Brick & Tile Association ..... \*

CLASSIFIED Advertising ..... 43  
 CLINTON Construction Company ..... 36  
 DINWIDDIE Construction Company .. 47  
 FINK & Schindler, The, Co. .... 33  
 FORDERER Cornice Works ..... 35  
 GLADDING, McBean & Company .... \*

GREENBERG'S, M. Sons ..... \*

HANKS, Abbott A., Inc. .... 48  
 HAAS & Haynie, Contractors ..... 34  
 HAWS Drinking Faucet Co. .... 28 & 29  
 HERRICK Iron Works ..... 47  
 HOGAN Lumber Co. .... 36  
 HUNT, Robert W. Company ..... 48  
 HUNTER, Thos. B. .... 47  
 INDEPENDENT Iron Works ..... 1  
 IDEAL Cement Co. .... Back Cover  
 JOHNSON, S. T. Co. .... \*

JUDSON, Pacific-Murphy Corp. .... 36  
 KRAFTILE Company ..... 26  
 MARBLE Institute of America ..... \*

MATTOCK Construction Co. .... 48  
 MICHEL & Pfeffer Iron Works, Inc. .... 2  
 MOORE, E. H. & Son ..... 35  
 MULLEN Mfg. Co. .... 47  
 OLSON, Leroy Co. .... 44  
 PACIFIC Coast Aggregates ..... 27  
 PACIFIC Manufacturing Co. .... 37  
 PACIFIC Telephone & Telegraph Co. 45  
 PARKER, Steffens & Pearce ..... 35  
 PITTSBURGH Testing Laboratory ..... 48  
 POOR Richard Engraving Co. .... 47  
 PORCELAIN Enamel (Architectural  
 Division) Publicity Bureau ..... 33  
 REMILLARD-Dandini Co. .... 48  
 REPUBLIC Steel Corporation ..... 37  
 SCOTT Company ..... 48  
 SIMONDS Machinery Company ..... 37  
 SMOOT-Holman Company  
 ..... Inside Front Cover  
 SUMMERBELL Roof Structures ..... 32  
 U. S. BONDS' Inside Back Cover  
 UTILITY Appliance Corp'n ..... \*

VERMONT Marble Company ..... 37  
 WEST Coast Screen Co. .... 43

\*Indicates Alternate Months

**REMILLARD-DANDINI Co.**

**Brick and  
 Masonry Products**



400 MONTGOMERY STREET  
 SAN FRANCISCO, CALIF.

**Scott Company**

**HEATING • PLUMBING  
 REFRIGERATION**



San Francisco  
 Oakland  
 San Jose  
 Los Angeles

**FOR ADVANCE  
 INFORMATION**

**ON  
 BUILDERS  
 CONTRACTORS  
 ENGINEERS**

Get

**ARCHITECTS  
 REPORTS**

68 Post St. Phone  
 San Francisco DO 2-8311

**ROBERT W. HUNT CO.**

**ENGINEERS  
 INSPECTING TESTING**

**STRUCTURAL MATERIALS  
 CONCRETE MIX DESIGN  
 CHEMICAL ANALYSIS  
 EQUIPMENT**

PRINCIPAL CITIES  
 UNITED STATES • EUROPE  
 SAN FRANCISCO LOS ANGELES  
 PORTLAND SEATTLE



# ARCHITECT AND ENGINEER

WEST'S FIRST DRIVE-IN POST OFFICE



WELTON BECKET, F.A.I.A., Architect

**JUNE**

**1953**



Moyfair School, Fresno  
Franklin & Simpson, Architects



Willow Glen High School, San Jose  
Morsh, Smith & Powell, Architects



## *Steel Windows*

*&*

## *Doors*

ARISTON Steel Windows and Doors are especially designed and constructed to meet the particular requirements of each job.

Michel & Pfeffer engineers are always available to assist architects in their preliminary and final plans.

# *Arislide*

## *Horizontal Sliding Doors*

- Fully Spring Bronze Weatherstripped
- Roller-bearing Bottom Rollers
- Smooth, Quiet Operation
- Bronze Handles and Foot Bolt
- Stainless Steel Capped Track



WRITE FOR LITERATURE: INQUIRIES INVITED

## **Michel & Pfeffer Iron Works**

N. K. JUVET, Manager Steel Window Division  
So. East Corner of So. Linden and Tanforan Avenues  
South San Francisco • Telephone Juniper 4-8362

Since 1912

# ARCHITECT

Vol. 193

No. 3

# AND ENGINEER

ARCHITECTS' REPORTS—Published Daily

EDWIN H. WILDER  
Editor

J. WELLS HASTINGS  
Contributing Editor

PROF. LELAND VAUGHAN  
Landscape Architecture

JOHN A. BLUME  
Structural Engineering

MICHAEL GOODMAN  
Planning

JOHN S. BOLLES, A.I.A.  
Book Reviews



## COVER PICTURE

The West's First  
DRIVE-IN POST OFFICE  
Los Altos Village  
(Los Angeles)

The architectural firm of Welton Becket, F.A.I.A., and Associates, Architects and Engineers, designed this unique U. S. Post Office building for the United States Postal Service. Service windows available from one-way drive at far right of building. See page 8 for additional pictures and details.

—Photos by Woro Studio.

ERNEST McAVOY  
Advertising Manager

ARCHITECT & ENGINEER  
is indexed regularly by  
ENGINEERING INDEX, INC.

## Contents for

# JUNE

EDITORIAL NOTES . . . . .	4
NEWS & COMMENT ON ART . . . . .	6
DRIVE-IN, United States Post Office, Los Angeles . . . . .	8
Welton Becket, F.A.I.A., & Associates, Architects and Engineers	
RESIDENCE, Mr. and Mrs. C. B. Noyes, Berkeley, California . . . . .	10
Architects Robert S. Kitchen and Frank B. Hunt. By Marcia Lee	
MADISON ELEMENTARY CONVERTIBLE SCHOOL, Boise, Idaho . . . . .	14
Anton E. Dropping, Architect; Resident Manager, Victor N. Jones & Associates By Arthur W. Prialux	
AUSTRALIA'S NEW TROPIC SCHOOLS, Darwin, Northern Territory . . . . .	20
By Norman Bartlett (Released by Australian News and Information Bureau)	
UNIQUE TILE EXHIBIT, a Joint Venture in Ceramic Tile Education . . . . .	27
A. I. A. ACTIVITIES . . . . .	28
WITH THE ENGINEERS . . . . .	30
PRODUCERS COUNCIL PAGE . . . . .	32
Edited by Phil Brown, Otis Elevator Company	
PERSONALITIES: Clarence Cullimore, Architect, F.A.I.A., Bakersfield, California	34
BOOK REVIEWS, Pamphlets and Catalogues . . . . .	38
ESTIMATOR'S GUIDE, Building and Construction Materials . . . . .	41
ESTIMATOR'S DIRECTORY, Building and Construction Materials . . . . .	43
CONSTRUCTION CONTRACTS AWARDED and Miscellaneous Data . . . . .	44
BUILDING TRADES WAGE SCALES, Northern, Central & Southern California . . . . .	45
CLASSIFIED ADVERTISING . . . . .	45
IN THE NEWS . . . . .	47
INDEX TO ADVERTISERS . . . . .	50

ARCHITECT AND ENGINEER (Established 1905) is published on the 15th of the month by The Architect and Engineer, Inc., 68 Post St., San Francisco 4; Telephone EXbrook 2-7182. President, K. P. Kierulff; Vice-President and Manager, L. B. Penhorwood; Treasurer, E. N. Kierulff.

Los Angeles Office: Wentworth F. Green, 439 So. Western Ave., Los Angeles 5; Telephone DUnkirk 7-8135.

Entered as second class matter, November 2, 1905, at the Post Office in San Francisco, California, under the Act of March 3, 1879. Subscriptions United States and Pan America, \$3.00 a year; \$5.00 two years; foreign countries \$5.00 a year; single copy 50c. ARCHITECTS' REPORTS are published daily from this office, Vernon S. Yallop, Manager. Telephone DOuglas 2-8311.





# EDITORIAL NOTES

## A MASTER BUILDER

The Architect . . . an individual who professionally plans buildings and supervises their construction.

The American Institute of Architects, a national organization representing many architects throughout the nation, has recently published a collection of facts about the Architect, his services, his profession and his national association. Objective of the publication is to have available to those who may be interested in using an Architect, a ready reference on things architectural.

Employing an Architect is similar to engaging the services of any professional man. Training and ability are important; his business capability, his artistic and technical ability, and his temperament are also important.

It is a pretty safe rule when contemplating any new building, or remodeling of old structures, to "Consult an Architect" and if at all possible "Know Your Architect."

\* \* \*

*The danger inherent in luxury and ease is that people may be better off without being better.—The War Cry.*

\* \* \*

## ANOTHER BITE

Members of the California State Legislature recently approved the assessment and collection of 1½¢ per gallon gasoline tax from the motoring public. Payment of the one and one-half cents in itself will not seriously effect the operator of any motor vehicle, and if the funds raised are wisely spent on construction and maintenance of California highways there may possibly be sufficient benefit accrue to the motorist to compensate for the additional tax-bite.

There is considerable eye-brow lifting, however, in the manner and method in which the gasoline tax is spent and allocated. Motorists in one section of the state have difficulty in comprehending the tremendous expenditures in some other area, they cannot understand obvious inadequate highways in their community and super-duper free-ways with complicated over-pass, under-pass, on-and-off approaches, and pedestrian walk-ways that seldom serve a pedestrian in another.

Highways are essential to modern living, but so is food, clothing, and shelter. Another 1½¢ gasoline tax, an increase in automobile insurance rates, increase costs in automobile repair and maintenance, expansion of the parking-meter curse, and substantial increase in car parking rates in

metropolitan areas, all contribute to less funds available for the also needed elements of living, i.e. proper food, clothing, medical care, and housing.

Members of legislative bodies empowered to assess charges against the income and necessities of living, should exercise such power in the light of the overall problem of the individual to meet the total costs of maintaining the American way of life. It should be well remembered that "the power to tax, is the power to destroy."

\* \* \*

*You didn't start working for yourself until April 22nd—prior to then all wages, salaries, rents, interest and dividends received represent an out-go for payment of taxes.*

\* \* \*

## HOUSE TRADE-INS

The National Association of Home Builders, through a number of its members is experimenting in a "Trade-In" Home Program which promises to develop some extremely interesting factors in the home-owner-home builder relationships throughout the nation.

Many prospective home buyers are faced with the problem of what to do with a present house which must be disposed of before acquiring the new home. In many instances growing families make present living facilities inadequate and more space is needed. Preliminary study shows that incomes have usually increased since acquiring the initial home-buying obligation and nominal increases in monthly payments can easily be made on a larger houses. Few families have, however, accumulated the cash necessary to make a down payment on the larger house, but can do so by using the accumulated equity in their present home.

The problem therefore facing the nation's home builders is What to do with the trade-in home, how much remodeling is necessary to put the structure in a easy marketing condition, and how far will the financing agencies go in such a program.

Indications are that cooperation among all phases of the home building industry throughout the nation will result in an acceptable plan and a program beneficial to the home owner will soon develop.



*Creating*  
 Appetite Appeal  
*with*  
**COLORFUL  
 CLAY BRICK**

Today design and materials must speak up—  
 invite the customers in with warmth and  
 color. In the case of Mayes Oyster House,  
 clay brick help focus attention—get results.

**CLAY BRICK & TILE ASSOCIATION**

SERVING NORTHERN CALIFORNIA

Affiliated with Structural Clay Products Institute

**55 NEW MONTGOMERY STREET, SAN FRANCISCO**

*In the interest of better brick and tile construction the following companies have contributed to the publication of this advertisement.*

KRAFTILE COMPANY  
 L. P. McNEAR BRICK COMPANY  
 PORT COSTA BRICK WORKS

REMILLARD-DANDINI COMPANY  
 SAN JOSE BRICK AND TILE, LTD.  
 STOCKTON BRICK AND TILE COMPANY  
 UNITED MATERIALS & RICHMOND BRICK COMPANY

**Inside or Outside A CLAY BRICK WALL... BEST FINISH OF ALL**

# NEWS and COMMENT ON ART



## M. H. deYOUNG MEMORIAL MUSEUM

The M. H. deYoung Memorial Museum, Golden Gate Park, San Francisco, under the direction of Walter Heil, is offering the following special exhibitions during June:

Building in Germany 1945-52, a group of photographs of post-war architecture; Contemporary Indian Arts and Crafts; Association of San Francisco Potters—Sixth Annual Exhibition; Twenty American Paintings, from the collection of International Business Machines Corpn.; Thirteen Wa-

tercolorists—19th Annual; the Max Pollak Color Etchings presented to the Museum; and an open exhibition for artist members of the San Francisco Art Association showing oils, watercolors, sculpture and graphics.

Special events will include lectures of the Museum, and adult and children classes in art and painting.

## SAN FRANCISCO MUSEUM OF ART

The San Francisco Museum of Art, War Memorial Building, Civic Center, has scheduled the



## M. H. deYOUNG MEMORIAL MUSEUM Golden Gate Park San Francisco

This piece of limestone  
Sculpture representing  
**THE TRINITY**  
(Father, Son and Holy Ghost)  
is the work of an unknown  
French artist of the second  
half of the 15th Century.

It is a new acquisition of the  
deYoung Museum, now on display in  
the newly remodeled Central  
Wing and is the gift of the  
deYoung Museum Society.



following special Exhibitions and Events for the Month of June:

**Exhibitions**—Leger. A Survey of His Art; Contemporary Drawings from 12 countries; Paintings by Loren MacIver and I. Rice Pereira; Design for Outdoor living; and Costume and Stage Designs by Eric Stearne.

**Events**—Lecture tours of the Museum are held each Sunday at 3 p.m.; Discussions on Art each Wednesday evening at 8 o'clock; Classes in Art for the Layman (will close for Summer in June); and Motion Picture films relating to art subjects each Saturday and Sunday at 2 and 4 p.m.

More than 4000 entries were submitted for consideration in the exhibition of Contemporary Drawings from 12 Countries, and 314 works were selected for inclusion. This exhibition will also be shown at the Los Angeles County Museum and the Colorado Springs Fine Arts Center, as well as a number of Eastern art centers.

### **SAN FRANCISCO ART ASSOCIATION**

Award winners for the San Francisco Art Association, 800 Chestnut Street, Open Exhibition for Artist Members have been announced and include:

Clayton Pinkerton, resident of Richmond and instructor at the Richmond Art Center, \$100 for untitled Oil Painting; Alan Williams, Richmond, teacher of sculpture, Berkeley Evening High School, \$100 for untitled Sculpture In Iron; Kenneth Nack, San Francisco, director of Area Arts Galley, \$100 for watercolor "A Stringed Instrument With A Pear Shaped Body and A Fretted Neck."

David Park, Berkeley, \$75 for Oil Painting "Manicure"; Emiko Nakano, San Francisco, \$60 for Oil Painting "Landscape"; and Mary Navratil, San Francisco, \$50 for Oil on Canvas "Omen".

Jury of awards consisted of John Haley, University of California instructor in Painting; John Humphrey, San Francisco Museum of Art staff member; Fenton Kastner, sculptor and librarian at the California School of Fine Arts; Weldon Kees, recently of New York City; and Jerry Walter, Sausalito sculptor.

### **ARCHITECTURAL ACTIVITIES AT THE SEATTLE A.I.A. MEETING**

Thirty members of The American Institute of Architects were advanced to the rank of Fellow in recognition for their distinguished performance in design, education, literature, public service, and service to The Institute.

Among those receiving this high recognition were: William Charles Furer of Honolulu, T. H., for "service to The Institute"; Henry L. Gogerty of Los Angeles, for "Science of Construction"; Ken-

neth Smith Wing of Long Beach for "Design"; and Arthur P. Herrman of Medina, Washington, for "Education".

\* \* \* \*

Pedro Ramirez Vazquez, President of the Mexican Society of Architects was elected Honorary Corresponding Member, an honor conferred yearly upon the presidents of architectural societies in England, Canada, Mexico, Cuba and the Philippines.

\* \* \* \*

Joseph Eichler, home builder of Palo Alto, California, spoke at a special business session of architects and representative of the National Association of Home Builders. It was the first time an operative builder has appeared on a national convention program of architects.

\* \* \* \*

Members of the Honor Awards Jury for this year included: H. Abbott Lawrence, A.I.A. of Portland; Lawrence G. Waldron, A.I.A. of Seattle; Rollin H. Boles, A.I.A. of Portland; Arthur P. Herrman, A.I.A., of Seattle; and non-architects Charles H. Gordon, Seattle; V. O. Stringfellow, secretary NAHB; Frederick M. Hunter, Eugene; and Walter L. Doty, Menlo Park, California.

\* \* \* \*

Architectural exhibits were not limited to Seattle, but were also shown in Tacoma, Spokane and Olympia, Washington.

\* \* \* \*

The Steel Joint Institute, Washington, D. C., and the Overly Mfg. Co., of Greensburg, Pa., were awarded "Certificates of Exceptional Merit" in the annual Products Literature Competition, an event sponsored jointly by the A.I.A. and The Producers' Council.

\* \* \* \*

A 60-page manual, containing illustrations of Seattle Architecture and nearby lake regions, was issued in conjunction with the Convention. Copies (\$1.00 each) may be secured from the Washington State Chapter, A.I.A. offices, 430 Central Building, Seattle 4, Washington.

\* \* \* \*

A flying Indian Thunderbird, adapted from the totem pole carvings of the Haida Indian Tribe of the Queen Charlotte Islands, was chosen as the emblem for this year's convention. Selection of the local Indian symbol highlighted the character of the convention, the first ever to be held in the Pacific Northwest by the A.I.A. Designer of the emblem John Detlie of the Washington State Chapter, pointed out that the Thunderbird, part of Indian tribal mythology and legend, symbolizes the link between the native heritage of the Northwest and its contemporary art and architecture.



FRONT OF BUILDING . . . facing street

# DRIVE-IN UNITED STATES POST OFFICE

LOS ALTOS VILLAGE  
(LOS ANGELES)

WELTON BECKET, F.A.I.A., ARCHITECT  
AND ASSOCIATES  
ARCHITECTS & ENGINEERS

Southern Californians' partiality toward drive-in theaters, markets, and restaurants now includes a drive-in United States Post Office. Residents of Los Altos Village are proud of their new post office, first of its kind in the West. In the first three months of operation, more than 11,900 automobile patrons have been served at the convenient car-service windows.

The unique post office and store building was designed for the Lloyd S. Whaley Company and

Home Investment Company by the architectural firm of Welton Becket, F.A.I.A., and Associates, architects and engineers.

Before committing the plans for the building to paper, the architects worked in close cooperation with Long Beach Postmaster Howard K. Goodwin to produce a post office that insures maximum efficiency in the handling of normal postal transactions. Studies were made of the traffic flow along the busy Bellflower Boulevard; of the driving habits

of the community; and available parking facilities in the rapidly expanding business area.

After careful consideration of local climatic conditions the designers made the best use of available sunlight and air throughout the building to insure the most favorable working conditions for employees.

Without leaving their automobiles, post office customers may enter the one-way drive off Bellflower and approach the outside postal windows to purchase stamps and mail packages. The windows themselves are specially designed at a convenient height inside to facilitate the operations of the clerks. Overhanging canopies at each of the two windows offers protection from rain. The windows have double protection with the usual outer slide-up iron grille and a slide-up window inside that can be closed in cold weather, leaving a small opening at the bottom for postal transactions.

Upon completing their business at the windows, the patrons have three choices of egress from the post office: straight through the parking lot to an alley or by turning right or left through the parking lot to the street on either side. The parking lot behind the building has space for 500 automobiles

for the convenience of post office customers and shoppers at the adjoining stores.

Covering 12,000 square feet, the building includes space for doctors' offices and stores in addition to the post office branch. There are both street and parking lot entrances to all the units in the building. It is constructed of reinforced concrete block, with ceramic veneer finishing on the post office front. The roof is of arched rib-type trusses in two spans. Ceilings are suspended acoustical tile. Interior walls are wood stud partitions, designed for easy expansion in the future.

Cantilever canopies on the east and west sides of the building cover the sidewalk and the walkway from the parking lot. Street entrances to the stores are of glass with extruded aluminum doors.

Postmaster Goodwin announced to the community that Southern California's first drive-in post office is being studied with interest by top postal department executives. Los Altos Village was chosen as the testing ground for the unique idea because of the suburb's typically modern personality. Judging by the favorable response on the part of the motorized shoppers of the area, Goodwin believes that other Southland communities will be demanding the easy drive-in service.

**PLENTY OF ROOM**—Solving the off-street parking problem before it develops, a parking lot for 500 automobiles is provided at the Los Altos Village new Drive-In-Post-Office. Outside windows at far left of building take care of patrons from their automobiles, similar service provided on street-side of building.







ENTRANCE at street level . . . also location of garage area.

# RESIDENCE

MR. & MRS. C. B. NOYES

Berkeley, California

ROBERT S. KITCHEN

ARCHITECTS:

FRANK B HUNT

By **MARCIA LEE**

**SITE:** A residential lot, approximately 60' x 150', located in the heart of Berkeley, overlooking a beautiful wooded canyon and within earshot of a natural stream at the bottom of the canyon.

**PROGRAM:** To provide, for a couple whose children are married, a small, one bedroom house (with a study and adjoining bath easily convertible to a guest room) which would take maximum advantage of the site and be easy to maintain.

**PLAN:** The structure of the house follows the contours of the slope to achieve the greatest possible area with minimum excavation and retaining walls.

It is oriented to give major living spaces full view of the wooded canyon and to retain such natural beauties as the flowering cherry and luxuriant laurel trees on lot.

Garden space and building structure were

## . . . CANYON RESIDENCE

planned as a unit to permit maximum enjoyment of outdoor vistas from every room in the house.

The location of the garage was determined by the contours of the site for easy access from the street, and to preserve the existing trees. Wood storage space is provided under the garage, and the overhang of the garage roof is extended to give covered passage to the front door of the house.

House and garage are separated by a small inner garden and pool which becomes an extension of the living room through a wall of glass. Sliding glass doors on the opposite side of the room overlook the wooded canyon and open out onto a spacious sun deck running the full length of the house, cantilevered over the steep edge of the canyon. An ell on the sun deck side of the living room forms the dining space, with floor to ceiling panels of fixed glass on the view side.

The study adjoins the living room, off the entry way from the front door. Glass doors open onto the sun deck on the east side, and a glass bay is located on the south wall overlooking the attractive gardens of the neighboring home. A con-

vertible sofa-bed is recessed in this bay. The study fireplace, with raised hearth, is backed up to the living room fireplace and one chimney serves them both—as well as the furnace and water heater located in the work shop on the floor below.

Off the dining space at the north end of the house is the kitchen, with windows overlooking both canyon and inner garden. The breakfast space adjoining has a plate glass floor to ceiling window, affording an unobstructed view of the garden.

A utility hall, adjacent to the breakfast room, accommodates an automatic clothes washer and drier which are concealed from view by tambor shutters.

The large master bedroom is located directly over the living room with a wall of glass and French doors opening onto a balcony on the canyon side. The bath room is divided into two compartments with the dressing room adjoining. High windows provide privacy but permit a view of the cherry tree.

Large storage areas are located on this floor

### OPEN ROOF

Roof opens over master bed-room sun porch, with a sufficient overhang being maintained to protect the bedroom from glare and direct sun.





**OUTDOOR  
LIVING**

Area facing the "canyon" is featured by large glass windows and "sun-deck" combination for indoor and outdoor living.

Top view—looks towards house interior.

Bottom view shows magnificent trees in canyon, behind city streets, and "deck" which enhances spaciousness of the area.





over the kitchen. Additional storage space is provided on the ground floor adjacent to the work shop.

The underside of the roof forms the ceiling for study, dining room and master bedroom. The roof framing is 4 x 10 select Douglas Fir beams sheathed with 2" T&G white fir. Beams are 30 feet long and cantilevered over the bedroom walls to the ridge in the center.

The shake roof horizontal siding is re-sawn 1 x 8 T&G redwood. Vertical siding is 1 x 6 T&G smooth surface redwood.

**View from Canyon side shows how living space was extended by cantilevering the wood deck out into the tree tops.**



**North exposure of living space presents glass-framed view of the garden area separating house from street-side garage. A window, cut in garage wall, relieves the starkness of the wall and integrates this separate unit into over-all structure.**



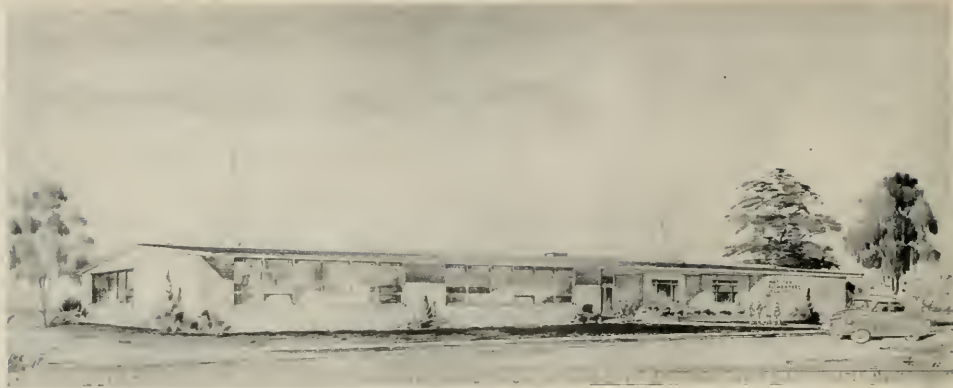

# MADISON ELEMENTARY CONVERTIBLE SCHOOL

Boise, Idaho

ANTON E. DROPPING, ARCHITECT  
RESIDENT MANAGER, VICTOR N. JONES  
AND ASSOCIATES

COST: \$7.92 PER SQUARE FOOT

By **ARTHUR W. PRIAULX**



**MODEST FRONT  
ENTRANCE**

Could be lobby of apart-  
ment building, medical  
clinic or other resi-  
dential-type building.

—Henry R. Griffiths, Jr.  
*Photographs.*

## . . . BOISE CONVERTIBLE SCHOOL.

Boise, Idaho may have solved one of the big headaches of school districts confronted with the unprecedented problem of supplying classroom space to house the over-size, war-baby crop. This intermountain metropolis has developed the convertible school.

It is a "little" school, built to house the first four grades, and all facilities are in junior size. When the current crop of primary students has progressed, and authorities can look forward to a diminution of numbers of primary pupils, the building is designed for quick conversion into apartments, a clinic, a kindergarten or some other residential district use.

Zed L. Foy, superintendent of Boise schools, and Anton E. Dropping, architect, and Boise resident manager of the firm of Victor N. Jones & Associates, AIA, worked out the idea and plans for the novel school structure.

On a block square area in the center of a fast-growing residential district, this six-classroom neighborhood school structure was designed to

conform to the surrounding residences and become an integral part of the community. Called Madison school, it is single storied.

The basic design and architectural problem confronting Architect Dropping was to develop a six classroom neighborhood school with the budget of \$60,000. Actually, the low bid was \$59,676 for 7,508 square feet, making a square foot cost of \$7.92, exclusive of land and architect's fee. All other bidders were close so the low price was not a contractor's error.

The idea was to design a school that was completely functional yet was as simple as possible with a minimum amount of corridor loss. Administration, heating, toilets, janitor's room, teachers' room and kitchen space were kept to a bare minimum. One reason for minimum facilities and improvements was that in the event of sale by the school board at a later date for conversion to apartments, a minimum amount of walls would have to be torn out.

The entire building is standard construction, the

**Front view of novel Madison Elementary School at Boise, Idaho—A "little" school designed to be converted to other uses when classroom demand has passed.**





# BOISE CONVERTIBLE SCHOOL . . .

exterior walls being made up of eight inch bricks. All interior partitions are stud walls and plaster. Ceilings are covered with sheet rock and acoustical tile. Floors are concrete on grade with asphalt tile covering. All windows and doors are frame in standard sizes.

One saving was developed in the roof, the underside of the fir rafters forming the ceiling. The area between the roof and the ceiling is ventilated by a continuous screened vent under the eaves and a ridge metal monovent. This is a very satisfactory method of ventilating this type of construction. The roof is low pitched and is built up paper and asphalt roofing. The hail ceiling has been furred to accomodate the heat supply ducts,

and the cold air return is by means of a system of concrete pipes installed under the floor and around the perimeter of the building. Heat is supplied by an oil-fired furnace in conjunction with an electric air filter.

This is one of four Boise schools designed by Victor N. Jones & Associates, but the smallest school designed for the Independent School District of Boise City.

Classroom space gets the lion's share of the floor area, 66.8 percent, and the six rooms contain 5005 square feet. Some idea of the use of space in the building and the compactness of the design can be gained by a look at the area set aside for other uses. Circulation areas have 951 square feet, toilets for students 323 feet, administration and teachers 435 feet, kitchen 122 feet, heating 250 feet and outside covered areas 422 feet.

To cut down on cost of finishing, all outside walls in classrooms have been left with exposed brick.

Lighting is supplied by means of incandescent fixtures throughout, supplementing natural light from long runs of windows. Because all students

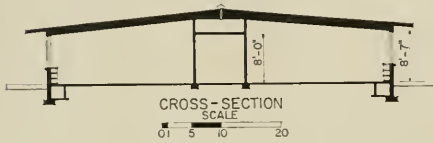

Detail of Cross Section of End Elevation.

## Floor Plan—Madison School



**This classroom has economy brick wall unfinished to save expense. It will be easy to convert in the future to almost any use.**



using the "little" school are fourth graders or under, toilets, blackboards and wardrobes have all been installed at a lower than normal height to accommodate these youngsters. Also, the ceilings in the classrooms have been held to a lower than standard height. This, too, will eliminate costs when and if conversion to other use is undertaken. Architect Dropping believes this reduction in scale

played a considerable part in keeping costs to a low price of \$7.92 per square foot.

One feature of Madison school liked by parents of young students is that its convenient location in the center of a heavily saturated residential district places the school within walking distance for all pupils. Residences are completely around the perimeter of the school. In fact, the building so

**View of rear—and one side of brick building. Note uniformity of window arrangement for each of the six classrooms.**





Economy roof rafters become ceiling joists for classrooms. Note pitch of roof against far wall. Acoustical tile ceilings give good results here . . . blackboards placed against end brick wall.

Rear view of this unusual school building shows how compact and un-institutional it looks in center of residential district of Idaho's state capital city, Boise.





## BOISE CONVERTIBLE SCHOOL . . .

closely resembles nearby residences that it is not at first apparent that it is a school.

Architect Dropping believes the safety factor is high in this novel school structure with two exits. If, by chance, the corridors should be obstructed, it would be relatively easy to get out of the classrooms through the windows. The building is supplied with a fire alarm system and has extinguishers located strategically.

Another feature liked by parents is the greater possibility of participation of all students in activities because all students are of a similar size. In larger elementary schools, the first and second graders are at a disadvantage in competing for play equipment with sixth graders and older, and there generally is a bully or two in the older grades who makes life miserable for tiny tots.

Although Madison school was designed to accommodate the first three grades, a fourth grade section was moved in this year to relieve crowding in other schools, and the fourth graders enjoy the junior size accommodations as much as their smaller fellow students.

Boise people are so enthusiastic about little children attending this "little" school that it is quite likely that in the near future the city may build two more similar structures, according to Superintendent Foy, which could be converted into other uses. However, Mr. Foy is rather sanguine about the possibility of early relinquishment. He says the birth rate in Boise and nationwide does not indicate any let-up in lower grade enrollment for several years to come.

Architect Dropping has carried out carefully the theme of the residence simulation in the exterior design of Madison school. Even his entrance is modest, opening off a modest cement walk, in a lobby style which could be associated with an apartment entrance. Windows are plentiful, but not ostentatious, and could pass for residence, clinic or apartments. Actual conversion of this low-cost school building will present no costly engineering or design problems. Low ceilings will convert readily for residence use. Extra partitions can be added without trouble. Windows can be

(See Page 33)

**Junior Classroom . . . note wardrobe and built-ins, as well as blackboards, are all built to junior scale to accommodate primary students.**





**Infant School Building of Darwin's Primary School—Lower Louvers, Extensive Windows and High Piles Provide Tropic Climate Ventilation.**

# AUSTRALIA'S NEW TROPIC SCHOOLS

Darwin, Northern Territory

**By NORMAN BARTLETT**

Released by Australian News and Information Bureau

A school of ultra-modern design will soon be housing the rapidly-growing child population of Darwin, capital of Australia's Federal-controlled Northern Territory.

Designers of this \$200,000 building have jettisoned all ideas of stereotype school architecture so familiar in colder and older regions; it will be neither an uptightly institution surrounded by asphalt nor an elderly-lad venerable pile set in green playing fields. It is a streamlined, up-to-date block, especially tailored for a vagarious tropic climate.

Darwin's new school will be in keeping with the new Darwin. Before the war Darwin was a half-forgotten tropical settlement with an almost static population. Between its white bungalows and the metropolis far to the south stretched thousands of square miles of sparsely populated cattle pastures and trackless wilderness. The township served a wild, frontier country inhabited by pioneer cattlemen, a handful of miners, missionaries and nomadic aborigines.

Irregular cargo steamers brought supplies from southern ports. A narrow-gauge railway with an in-

The pre-school kindergarten at Darwin is under the same lines as the highly developed Nursery school of Southern Australian cities and towns.

Area beneath the building is utilized as a playground.

Lower view shows a close-up of louver and window ventilation in classrooms.



frequent service, penetrated about 300 miles southward. A few unsurfaced motor tracks reached out to huge unfenced cattle stations and then petered away. Despite its obvious strategic importance on the map, Darwin was a neglected frontier post and seemed doomed to remain a neglected frontier post for many years.

Then World War II pitchforked Darwin into the spotlight.

Japanese raiders bombed the town and destroyed many of its buildings. Allied servicemen took it over from the civilians and Darwin became a frontline town with a place in international headlines.





## AUSTRALIAN TROPIC SCHOOL . . .



School bus taking children to school under free compulsory education plan.

**BELOW**—Pre-school kindergarten facilities provide for relaxation and comfort of children at all times. Area can be used for games and recreation in adverse weather seasons.

Now, the war over and the rhythm of civilian life restored Darwin is still a frontier town, but it is no longer a neglected static town. The Federal Government has moved in and is transforming the Territory's administrative capital into a well-planned focus for tropical development.

High on its list of undertakings is the development of educational facilities. This work is urgent because the school roll has jumped from 69 in 1946 to 600 in five years.

Darwin's population in 1939 was 3,500. Now it is more than 6,000 with the child population increasing more rapidly than the adult. In the first post-war year births amounted to 27. Next year the number was 144, then 216 and then 300. The present birthrate is the highest in Australia.

The old school with the makeshift additions put a severe strain on accommodation. Some children had to take their lessons beneath the school among the piers supporting the building. First, second and third year secondary pupils were for some time in one room.

In 1949 the Federal Standing Committee on Public Works investigated the position and heard evidence from many officials. Their recommendation for a new school followed and a start has been



Grade seven in the "secondary" school. Darwin is a higher primary school with 600 pupils, including 63-post primary students. The staff numbers seventeen.



A touch-typing class in the secondary school. These recently established commercial classes will help eliminate desperate shortage of trained commercial workers for business and administration offices.

Classroom in a temporary secondary school block on the site of the new school. The 80'x40' building has been converted into four classrooms by movable screens. Ventilation is by glass louvers.



## AUSTRALIAN TROPIC SCHOOL . . .

made on its construction.

Set in eight acres of sloping ground, the new school has been designed with the weather eye cocked on Darwin's peculiar two-season climate. During "the dry" the sun radiates a glare and heat which cannot be shut out by doors and curtained windows lest they impede the relieving cooling breezes. In "the wet" day-long down-pours make out-of-doors study impossible. The school's designers think they have beaten both problems.

Louvres in the 11-inch cavity cement-brick walls will catch the sea breezes, yet with the help of wide overhanging eaves, will repel the torrid sun overhead. As a second line, layers of insulating wool over all ceilings will beat off the heat and an ingenious system of cross ventilation will snare any zephyr that happens to be blowing. Green swards around the building will also assist in minimising ground radiation.

Vertical brickwork fins and projecting piers at regular intervals will also break down the tropical glare.

The louvred walls will provide adequate and constant daylight at desk height in all rooms.

For "the wet" there is a large covered playing area linked with all the school blocks by long shelters and including the "tuck-shop" so that once at school, the pupil need not venture into the rain for anything.

All rooms are wired for sound, for announcements and radio lessons and iced water drinking fountains will be placed both inside and outside the building.

The school is the first of several to be built in the residential areas that are part of the new Darwin. Each will have accommodation for 300 students without overcrowding.

Darwin's new school is only part of the comprehensive programme of education development planned for the Northern Territory. When the war ended there were only two schools operating in the Territory—at Alice Springs (27 children) and Tennant Creek (28 children). The Federal Government was faced with the responsibility of providing modern education for a growing and widely scattered population in a territory covering 524,000 square miles. This is five times the area of Great Britain and three times the size of Germany.

Within six years the Government has made education free and compulsory for every white and mixed-blood child in this huge area. There are now five departmental schools, two private schools, two kindergarten centres and more than 150 children enrolled in correspondence classes. Darwin and Alice Springs have established evening continuation classes and Darwin has classes for the technical training of apprentices.

The South Australian Department of Education supplies the curriculum and teachers and the upkeep is met by the Commonwealth. Since the war the number of teachers has increased from 5 to 34, and the number of pupils from 156 to 1,288. Buses carry pupils from outlying settlements and living allowances are paid to children who have to board away from home.

For pupils in the outback, the Alice Springs



School Buses carry children to and from school. These semi-trailers are temporary arrangements pending the arrival of new buses. Five Government vehicles are used.

—Photographs by James Fitzpatrick.



## . . . AUSTRALIAN TROPIC SCHOOL.

"School of the Air" keeps regular contact with correspondence pupils. Two-way radios enable pupils to speak direct to their radio-teacher at the end of each lesson.

The new Territory schools have all the amenities and facilities available to children in the metropolitan areas of Australia. Cineprojective radios and libraries are standard equipment and regular medical and dental inspections are carried out by mobile clinics.

Education is for all children, whatever their origin. There is no colour prejudice. The first Northern Territory boy to gain the intermediate certificate sitting in the Territory was an aboriginal quadroon; of the 1,134 children attending school, 25 per cent are of aborigine extraction and seven per cent of Asian.

Compulsory education of full bloods has not yet been possible. Many live on isolated stations or are nomads with their tribes and even if they could attend schools, they have not the necessary background of English to keep up with other children.

This problem is being met by the Commonwealth Office of Education which has set up special primary schools at selected native reserves. Here, specially trained teachers are using a curriculum adapted to aboriginal children.

Mission stations have also well-conducted schools for aborigines and mixed bloods.

The administration's efforts to improve its education system have brought encouraging co-operation from Territory citizens who have thrown themselves enthusiastically into full support. Active parents' associations flourish and more than \$2,240 has been raised to provide additional amenities not within the scope of the public purse. Throughout the Territory there is a happy union of government's aid and self-help. This was illustrated well at Pine Creek where there are only six families. With Government-supplied materials the six families hove to and quickly ran up a substantial shelter shed as a necessary school adjunct.

It is the Pine Creek spirit that is making the administration's job all the more easy—and pleasant.

**The school bus service costs the Darwin administration more than \$10,000 a year. Service is provided for the Convent School as well as for the Compulsory Departmental School. Children who live more than ten miles from an established school are entitled to a living allowance of approximately \$120 a year, if they live away from home.**



## PRODUCERS COUNCIL HOLD SUCCESSFUL PRODUCT SHOW

The annual Producers' Council Product Display was held in the Fairmont Hotel in San Francisco the latter part of last month, with 46 exhibitors showing new lines of building products at special displays, and more than 158 members attending the one day show.

Special awards, offered for the three displays which best illustrated this year's Show theme—"Specify, Don't Mystify," were awarded to 1) Gladding McBean & Company, Kawneer Company and the Reynolds Metals Company. Judges for the event were: Mario Ciampi, Architect; William Corlett, Architect, and Jos E. Murray, Consulting Engineer.

Some 454 architects and engineers attended the event as guests of the Council. Producer Council members participating in this year's show included:

Aluminum Company of America, American Radiator & Std. Sanitary, Armstrong Cork, Brookman Co., Bell & Gossett Company, Philip Carey Mfg. Co., Ceco Steel Products, Celotex Corp., Clay, Brick & Tile Assn., Detroit Steel Products, Fiat Metal Mfg. Co., W. P. Fuller & Co., Gladding McBean & Co., Goodyear Tire & Rubber, E. F. Hauserman Co., Johns-Manville Sales Corp., Johns-Manville Sales Corp., Ind. Prod. Div., Josam Pacific Company, Kawneer Company, Kraftile Company, Libbey-Owens-Ford Glass, J. O. Martin Company, Minneapolis-Honeywell Regulator, Modern Building Specialties, Mosiac Tile Co., Natural Gas Equipment, Inc., Otis Elevator Co., San Francisco, Owens-Corning Fiberglass Corp., The Peelle Company, F. K. Pinney, Inc., Pittsburgh Corning Corp., Pittsburg Plate Glass, & W. P. Fuller Co., A. E. Plante Company, Reynolds Metal Co., H. H. Robertson Co., The Roddiscraft, Inc., The Squires Company, Truscon Steel Corp., United States Plywood Corp., Vermont Marble, Western Asbestos, Arcadia Metal Prod., Habelmann & Co., Inc., Kentile, Inc., Pomona Tile Mfg. Co.

## NATIONAL PRESIDENT ADDRESSES

### PUGET SOUND CHAPTER

### AMERICAN SOCIETY FOR METALS

By H. L. Southworth, Boeing Airplane Company

A recent meeting of the Puget Sound Chapter of the American Society for Metals in Seattle was honored by the presence of Mr. R. L. Wilson, National President of the American Society for Metals.

Wilson is presently Director of Metallurgy, Timken Roller Bearing Company, Canton, Ohio. In addition to extensive metallurgical experience dating from his graduation from Lehigh University in

1921, he served during the late World War as Chief of the Constructional Steels Section, Steels Division, War Production Board. He is outstandingly qualified to discuss the topic he chose for the evening, "Recent Developments in Alloy Constructional Steels."

Wilson began by pointing out the large tonnage of alloy constructional steels used, which amounts to about 10,000,000 tons per year. Within the range of .25 to .40 carbon content, if these steels are properly heat treated to 200 to 400 Brinell, they are practically interchangeable. This fact formed the basis for the substitutional program. Alloying elements are interchanged where shortages occur and presently manganese and chromium are being used in place of nickel and molybdenum, and boron in place of all of these.

As these steels can be interchanged under most conditions another factor other than strength or hardenability must be used to evaluate them. Temperability has been found to be a very pertinent criterion as steels requiring higher tempering temperatures have great energy absorbing capacity or impact strength.

Wilson discussed recent work being stimulated by the competition of aluminum alloys and the materials such as Hy-Tuf, B-514 and Cr-Ni-Mo-V, Type 2 that have been developed. All of this work is directed toward a steel having a strength of 235,000 psi and above, coupled with an elongation that will be acceptable to designers. With steels operating with these strengths, their response to fatigue conditions and notch effects is very important and much investigation is following this line.

Several methods of increasing fatigue life and performance were presented such as shot peening, heat treating and shell hardening methods, which are also allowing substitution of medium carbon steels for alloy in certain instances.

It was predicted that with increased knowledge of residual stresses and how to avoid or eliminate these steels will have higher yield points, more elongation and better fatigue and impact resistance.

## PROFESSIONAL CONFERENCE ON HIGHWAYS SCHEDULED

A three-day professional conference on modern highways was held on June 23-25 at the Massachusetts Institute of Technology, sponsored by the Departments of Civil and Sanitary Engineering and the City and Regional Planning at M.I.T., and by the Massachusetts Department of Public Works.

The program will include Planning, plans, route selection; Survey, aerial, soil study; and Design, standards, capacity, safety.

# UNIQUE TILE EXHIBIT

A JOINT-VENTURE  
IN CERAMIC TILE  
EDUCATION

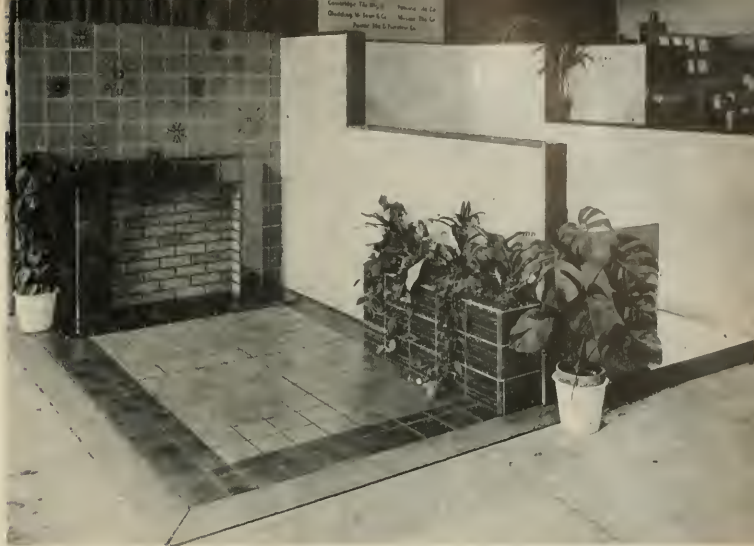

TILE MANUFACTURERS' EXHIBIT . . . Oakland Home Show

After three years of joint participation in Home Shows with various types of tile exhibits, experience convinced a group of tile manufacturers and representatives that the shows lacked something the public was looking for.

The result was an exhibit set up as nearly like an actual home installation as possible.

It was found that the public, and especially the housewife, attends Home Shows to see the actual material set up as it would be in their own home. It was noted that people like to run their hands over the tile and feel it. With this in mind, it was decided to consolidate several tile lines into a single show, or exhibit, and the entire project was handled by the participating companies themselves.

The planning, discussions, and construction took a considerable amount of time and many changes were made as work progressed, particularly where color and design were concerned.

Sections or panels of plywood and light supporting frame work were first built and the tile applied with adhesive and grouted. To erect, the finished sections are put together and the only grouting required is the joints where the panels meet. Weight and ease of handling in erecting and dismantling was an important factor, and the entire exhibit weighs about 3000 lbs. and takes a 10' x 20' booth. Three men can completely assemble it in 4 or 5 hrs.

Public acceptance thus far at Oakland, San Jose

(See Page 36)

Commercial Photo—Commercial Studio's Photo's.

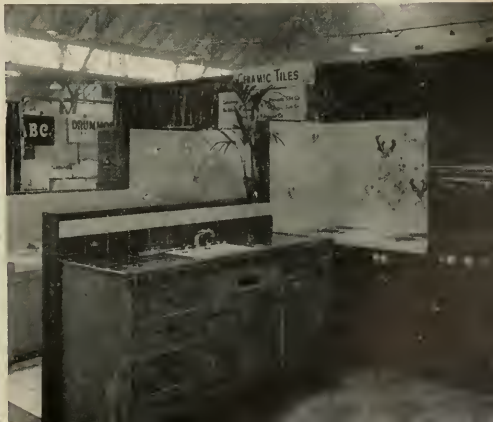





Glenn Stanton, President  
 Kenneth E. Wischmeyer, 1st Vice-president  
 Norman J. Schlossman, 2nd Vice-president  
 Clair W. Ditchy, Secretary  
 Maurice J. Sullivan, Treasurer

National Headquarters—  
 1741 New York Avenue, N. W.  
 Washington, D. C.  
 Edmund R. Purves  
 Executive Secretary

**Arizona Chapter:**  
 Lew Place (Tucson), President; Ralph Haver (Phoenix), Vice-President; Fred O. Knipe (Tucson), Secretary; James W. Elmore (Phoenix), Treasurer. Secretary Offices, 1324 E. Lester St., Tucson.

**Coast Valleys Chapter:**  
 Kurt Gross, President; Harold Ahnfeldt, Vice-President; Frank C. Treseder, Secretary; Jerome Kasavan, Treasurer. Directors: Hollis Logue and Gifford Sobey. Offices, 82 S. 3rd St., San Jose.

**Central Valley of California:**  
 John W. Bomberger, President; Nicholas Tomich, Vice-President; Albert B. Thomas, Secretary; Ted de Woll, Treas.; Gordon Stafford, Director; Alternate to CGA, Silvio Barovetto; Sec. Office 718 Alhambra Blvd., Sacramento.

**Colorado Chapter:**  
 James M. Hunter, President, 2049 Broadway, Boulder; Casper F. Hegner, Secretary, 1659 Grant Street, Denver 5.

**East Bay Chapter:**  
 Malcolm D. Reynolds, President; Donald Hardison, Vice-President; John Lloyd, Secretary; Ed Cerruti, Treasurer. Directors: Chester Treichel, Ira Beals, Cecil Moyer. Secretary's office: 1171 Solano Ave., Albany.

**Idaho Chapter:**  
 Frederick C. Hummel, President; Jack Woodmansee, Vice-President; Jed Jones III, Sec.-Treas. Offices 1324 Idaho Street, Boise, Idaho.

**Montana Chapter:**  
 E. Edward Scowcroft, President (Billings); J. Van Teylingen, Vice-President (Great Falls); H. C. Cheever, Secretary-Treasurer. Secretary office, Bozeman.

**Nevada Chapter:**  
 Walter Zick, President, Las Vegas; Russell Mills, Vice President, Reno; Keith Lockard, Secretary, Reno; Directors Edward Parsons, L. A. Ferris, David Vhay, Reno. Office of President P. O. Box 2107, Las Vegas.

**Nevada State Board of Architects:**  
 Russell Mills, Chairman, Reno; Aloysius MacDonald, Secretary, Las Vegas; Edward Parsons, L. A. Ferris, Reno, and Richard Stadleiman, Las Vegas, Members. Office, 309 S. 5th St., Las Vegas.

**Northern California Chapter:**  
 Donn Emmons, President; Wendell R. Spackman, Vice-President; William Corlett, Secretary; Bernard J. Sabaroff, Treasurer. Directors: Charles S. Pope, Wm. Stephen Allen and Lawrence A. Kruse. Helen H. Ashton, Office Sec., Office, 26 O'Farrell St., San Francisco.

## GERRIT J. de GELEKE, F.A.I.A.

### GIVEN EDWARD C. KEMPER AWARD

The Edward C. Kemper Award of The American Institute of Architects, given annually for outstanding contributions to the architectural profession or to The Institute, will be given to Gerrit J. de Gelleke, F.A.I.A., Milwaukee architect and financial expert, during the Institute's Seattle convention, June 15-19.

De Gelleke was chosen for this award primarily for his nine years of distinguished service as Chairman of the Institute's Finance Committee

### SAN DIEGO CHAPTER

Edward Hale Fickett, A.I.A. architect and a member of the Southern California Chapter was the principal speaker at the June meeting. His subject was "My Relations with Tract Builders," and having gained considerable national prominence lately in this field, Fickett gave a very interesting talk.

Fickett will represent the architects profession at a special collaboration session with the National Association of Home Builders, scheduled as a part of the A.I.A. Seattle convention.

Balance of the meeting was devoted to Chapter matters and discussion of State and National conventions.

### PASADENA CHAPTER

E. S. McKittrick, past president of the A.G.C. was the principal speaker at the June meeting, his subject being "Relationships Between the Architect and the General Contractor". The subjects of "specifications", "drawings", "trends in field methods", "preliminary estimating" and "building practices" were specifically discussed by McKittrick.

New members include Herbert E. Kaiser and Robert L. Kurtz, Junior Associateships.

### NORTHERN CALIFORNIA CHAPTER

The annual meeting and election of officers resulted in the following being named to serve for the ensuing year:

Don Emmons, President; Wendell R. Spackman, Vice-President; William Corlett, Secretary; Bernard J. Sabaroff, Treasurer. Directors chosen included

*Remember it's*

# KRAFTILE

- for ★ GLAZED STRUCTURAL WALL UNITS  
 ★ PATIO TILE  
 ★ FACE AND ROMAN BRICK  
 ★ ACID FLOOR BRICK  
 ★ HEARTH BRICK  
 ★ BRICKETTES  
 ★ MINWAX TILE & CONCRETE FLOOR FINISH

For complete information and prompt service, phone or write

## KRAFTILE COMPANY

NILES, CALIFORNIA

NI 5153 3611

LOS ANGELES 13: 406 South Main Street—MU 5141 7241

**Orange County Chapter:**

Paul O. Carter (Paul O. Angles), President; Ralph Modjeski (Santa Ana), Vice-President; Geo. Lind (Newport Beach), Secretary; Wm. L. Faulkner (Santa Ana), Treasurer. Secretary's Office: 2919 Newport Blvd., Newport Beach.

**Oregon Chapter:**

H. Abbott Lawrence, President; Holman J. Barnes, Vice-President; Donald W. Edmundson, Secretary; and Robert W. Fritsch, Treasurer. Office of Secretary, 325 Henry Bldg., Portland.

**Pasadena Chapter:**

Robert E. Langdon, Jr., President; Wallace C. Bonsall, Vice-President; Robert L. Deines, Secretary; Henry C. Barge, Treasurer; and Directors John N. Douglas, R. VanBuren Livingston, Scott Quintin and Burton Romberger. Offices: 259 South Los Rables Ave., Pasadena 5.

**San Diego Chapter:**

Donald Campbell, President; Victor L. Wulff, Jr., Vice-President; Richard L. Pinnel, Secretary; Edward G. Holiday, Treasurer; Louis A. Dean, Director. Office Sec., San Diego Trust & Savings Bldg.

**San Joaquin Chapter:**

Maurice J. Melz (Fresno), President; Allastair Simpson, Vice-President; Al Bailey, Secretary; Robert Stevens, Treasurer. Directors: David H. Horn, Wm. Hyberg, Robert Kaestner. Secretary's Office, Fresno.

**Santa Barbara Chapter:**

Miss Lutch Maria Riggs, President; Roy C. Wilson, Vice-President; Chester L. Carlola, Secretary; Roy W. Cheesman, Treasurer. Corres. Sec.; Richard B. Nelson, 3033 Calle Rosales, Santa Barbara.

**Southern California Chapter:**

Henry L. Wright, President; U. Floyd Rible, Vice-President; Cornelius M. Deasy, Secretary; Savo M. Stoshich; Hugh R. Davies, S. Kenneth Johnson, Kemper Nomland and Chas. E. Fry, Directors.

**Headquarters, 3723 Wilshire Blvd., Los Angeles 5.**

**Utah Chapter:**

W. J. Monroe, Jr., President, 433 Atlas Bldg., Salt Lake City; M. E. Harris, Jr., Secretary, 703 Newhouse Bldg., Salt Lake City.

**Washington State Chapter:**

Paul Thiry, President; John S. Detlie, 1st Vice-President;

Robert H. Wohleb, 2nd Vice-President; Robert H. Dietz, Secretary; and Edwin T. Turner, Treasurer. Alice Gregor, Executive Secretary, 430 Central Building, Seattle 4.

**Spokane Chapter:**

B. K. Ruehl, President; Victor L. Wulff, 1st Vice-President; Philip Keene, 2nd Vice-President; Laurence G. Evanol, Secretary; and Carroll Martell, Treasurer. Office 515 American Legion Bldg., Spokane, Washington.

**Tacoma Society:**

E. N. Dugan, President; P. G. Ball, Vice-President; Lyle Swedberg, Secretary-Treasurer.

**Hawaii Chapter:**

Kenil Onodera, President, 3518 McCarriston St., Honolulu, T. H.; George J. W. Wetherly, Secretary, 315 Royal Hawaiian Ave., Honolulu, T. H.

**CALIFORNIA COUNCIL OF ARCHITECTS**

Charles E. Fry, President, Los Angeles; Malcolm D. Reynolds, Oakland, Vice-President; Lawrence Gentry, Los Altos, Secretary; Louis A. Dean, San Diego, Treasurer; Fred A. Chase, Executive Secretary, 3723-A Wilshire Blvd., Los Angeles.

**CALIFORNIA STATE BOARD ARCHITECTURAL EXAMINERS:**

Earl T. Heitschmidt (Los Angeles), President; Geo. P. Simonds (Oakland), Secretary; Norman Blanchard (San Francisco); G. J. Paderewski (San Diego); Ulysses Floyd Rible (Los Angeles). Exec. Sec.; Robert K. Kelley, 11th & Grand Ave., Los Angeles; San Francisco Office, Room 300, 507 Polk St.

**ALLIED ARCHITECTURAL ORGANIZATIONS**

San Francisco Architectural Club: Joseph Seoma, President; Frank S. Gerner, Vice-President; Russell W. Pennell, Treasurer; Frank L. Barsotti, Secretary. Club Quarters: 507 Howard St., San Francisco.

**Producers' Council—Southern California Chapter:**

Bert Taylor, President, Pittsburgh Plate Glass Company; G. Robert Roder, Jr., Vice-President, Truscon Steel Company; Malcolm G. Lowe, Secretary, Natural Gas Equipment Inc.; Richard Seaman, Treasurer, W. P. Fuller & Company; Vern Bogert, National Director, Gladding McBean & Co.

Producers' Council—Northern California Chapter (See Special Page)

Charles S. Pope, Wm. Stephen Allen, and Lawrence A. Kruse.

As part of a program designed to broaden the scope and activities of the Chapter, new offices have been opened at 26 O'Farrell Street in San Francisco.

**WOMEN'S ARCHITECTURAL LEAGUE  
SOUTHERN CALIFORNIA**

Leis, prizes, dancing, Hawaiian food, special entertainment and music by Hawaiian orchestra featured the Luau in San Pedro, sponsored by Women's Architectural League of Los Angeles June 27.

**UNIVERSITY OF CALIFORNIA  
ARCHITECTURAL EXHIBITION**

Twenty architectural students of the Berkeley campus, University of California, were awarded prizes for outstanding achievement, at the annual exhibition of the School of Architecture on June 10.

The exhibition of student work and the conferring of awards is held each year in cooperation with the Department of City and Regional Planning, Department of Art, Decorative Arts Department, and Landscape Architecture Department.

**SOUTHERN CALIFORNIA CHAPTER**

The June meeting was devoted to the subject "Federal Bureau Encroachment on Private Practice" with Chapter Committee members and particularly the Governmental Relations Committee, leading general discussions on the various phases of governmental competition with private industry.

Henry L. Wright, George B. Allison, Cornelius M. Deasy, Walter Hagedohm, Earl T. Heitschmidt,

Paul R. Hunter, John J. Landon, Laurence C. Light, Samuel E. Lunden, Anthony Thormin, A. C. Martin, Jr., Kemper Nomland, Walter Rechart, John Rex, Ulysses Floyd Rible, S. Kenneth Wing, C. Day Woodford and Savo M. Stoshich were elected official delegates to the Seattle convention.

**"Thank Goodness my Architect Specified  
SIMPSON INSULATING BOARD"**



**Dozens of uses — inside and out, for**

- ★ Insulating Building Board
- ★ Insulating Decorative Plank
- ★ Insulating Decorative Tileboard
- ★ Insulating Sheathing

*Distributed by*



**Pacific Coast  
Aggregates, Inc.**

**DISTRICT OFFICE**

<b>SAN FRANCISCO</b>	<b>OAKLAND</b>	<b>SAN JOSE</b>
<b>SACRAMENTO</b>	<b>STOCKTON</b>	<b>FRESNO</b>

# WITH THE ENGINEERS

## Structural Engineers Association of California

John E. Rinne, President, San Francisco; Jack S. Barrish, Vice-President, Sacramento; Leslie W. Graham, Secretary-Treasurer, San Francisco. Directors John J. Gould, R. W. Binder, M. A. Ewing, Leslie W. Graham, Jack S. Barrish, Harold P. King, W. T. Wheeler, John E. Rinne and Donald F. Shugart. Secretary's office, c/o Associated Structural Engineers, 417 Market St., San Francisco 5.

## Structural Engineers Association of Northern California

George A. Sedgwick, President; Michael V. Pregnoff, Vice-President; John M. Sardis, Secretary; William K. Cloud, Treasurer; Robert P. Molfett, Asst. Sec. Treas.; Directors, Robert D. Dalton, Robert D. Dewell, William H. Ellison, John J. Gould and J. Albert Paquette. Offices: 417 Market St., San Francisco.

## Structural Engineers Association of Central California

William H. Peterson, President; Walter S. Wassum, Vice-President; O. T. Illerich, Sec. Treas.; Ernest D. Francis, M. A. Ewing, and Arthur A. Sauer, directors. Office O. T. Illerich, c/o Div. of Arch., Sacramento.

## American Society of Civil Engineers Los Angeles Section

Trent R. Dames, President; Stephenson B. Barnes, Vice-President; John M. Server, Vice-President; C. Martin Duke, Secretary, and John Merritt, Jr., Treasurer. Office of Secretary, 3066 Engineering Building, University of California, Los Angeles 24.

## American Society of C. E. San Francisco Section

J. G. Wright, President; J. E. Rinne, Vice-President; Howard C. Wood, Vice-President; John S. Longwell, Past President; H. C. Medbery, Secretary, and Richard C. Clark, Treasurer. Office Secretary, S. F. Water Dept., Millbrae.

## AMERICAN SOCIETY OF CIVIL ENGINEERS SAN FRANCISCO SECTION

"Construction Business Today" was the subject of a talk by H. W. Morrison, President of Morrison-Knudson Company, Inc., Boise, Idaho, at the June 16 meeting in San Francisco.

Morrison discussed the construction industry and the part played by both the constructor and the engineer. His firm was established in 1912 and today is one of the largest construction firms in the United States.

Members of the Section participated in an ex-

ursion to Folsom Dam, east of Sacramento, on the 27th, at the invitation of the San Francisco Post, Society of American Military Engineers.

New Members: Chairman Riggs of the Membership Committee reported the following new members. Col. Henry Berbert and Halvard W. Birke-land. Junior Members, Merrill W. Bird, Donald M. Bissell, Ramon F. Cayot, and Clarence K. Chan.

## STRUCTURAL ENGINEERS ASSOCIATION NORTHERN CALIFORNIA

Routine association activities were "aired" at the June meeting, with everyone present given an opportunity to express themselves. All complaints, "gripes," and any dissatisfaction with things "in-general" were considered and properly disposed of.

Considerable time and attention of association officers, directors and membership has been devoted to legislative matters pending in the State Legislature and with adjournment of the legislature attention will again be focused on more localized matters.

## FEMINEERS

The June meeting was held in the Elks Club, San Francisco, with Mrs. Fred Pavlow in charge of the meeting.

Fred Wheeler, member of the Wine Advisory Board, spoke on the subject "Wine Cookery and Proper Use of Wine at Home."

## STRUCTURAL ENGINEERS ASSOCIATION SOUTHERN CALIFORNIA

One hundred and eighty-three members and guests of the Structural Engineers Association of Southern California met June 3rd at the Rodger Young Auditorium at their last regular dinner meeting before fall. Special recognition was given to James Byers, a 20 year member of the Association, who is retiring from his job as Chief of

## Both are NEW both are distinctive



← **HAWS Model No. 7G**  
the latest member of a "name" family, combines new beauty with the utility and reliability for which HAWS has been famous since 1909.

## The New 56-Page HAWS CATALOG

thoroughly describes and illustrates HAWS complete line of Sanitary Drinking Fountains, Faucets, Electric Water Coolers and HAWS Emergency Eye-Wash Fountains and Drench Shower Equipment. Send for it today...study it...you'll see why it always pays to specify HAWS.



**HAWS DRINKING FAUCET CO.**  
1441 FOURTH STREET (Since 1909) BERKELEY 10, CALIFORNIA



**Structural Engineers Association of Southern California**

Ben Benioff, President; William T. Wright, Vice-President; Charles M. Corbit, Jr., Sec-Treas. Directors: Ben Benioff, William T. Wright, Harold P. King, Henry M. Loyne, Joseph Sheffet, Robert J. Kadow and Harald Omsted. Offices, 121 S. Alvarado St., Los Angeles 4.

**Structural Engineers Association of Oregon**

Lewis R. Ellingwood, President; Robert M. Bonney, Vice-President; Sully A. Ross, Secretary-Treasurer. Directors: William J. Dornier, Roger V. Gillam, Leslie E. Poole, Rowland S. Rosé. Offices 706 Board of Trade Bldg., 310 S.W. 4th Ave., Portland 4.

**Society of American Military Puget Sound Engineering Council (Washington)**

R. E. Kister, A. I. E. E., Chairman; E. R. McMillan,

A. S. C. E., Vice Chairman; L. B. Cooper, A. S. M. E., Secretary; A. E. Nickerson, I. E. S., Treasurer. Offices: L. B. Cooper, c/o University of Washington, Seattle 5, Washington.

**American Society Testing Materials Northern California District**

L. A. O'Leary, Chairman; P. V. Garin, Vice-chairman; J. P. Hoopes, Sec. Office Sec., 1550 Powell St., Emeryville, Calif.

**Society of American Military Engineers—San Francisco Post**

CDR N. M. Martinsen, President; L. L. Wise, 1st Vice-President; Col. Paul Berrigan, 2nd Vice-President; R. M. Hamilton, Secretary; Thomas Hurley, Treasurer. Directors, RADM C. A. Trexel, J. G. Wright, LTCOL C. S. Lindsey, C. E. Bentley, F. R. Fowler, BRIGEN D. F. Johns, and RADM L. N. Moeller.

the Building Branch, Los Angeles City School Department.

President Ben Benioff introduced John Steinbrugge, new Association member, to the group.

Dr. Hugo Benioff, Professor of Seismology at California Institute of Technology and Carnegie Seismological Laboratories, and a member of the National Academy of Science, was the principal speaker of the meeting, taking as his subject: "Earthquakes." His talk centered around the California faults and scientific data, much of which was obtained upon instruments designed by Dr. Benioff.

He told the group that the earth is continually going through cycles of energy storing and energy releasing, and the latter causes "elastic strain rebound." The rebound sets up ground waves having amplitude and frequency which are often enough to cause major damage to buildings. Especially do these waves become destructive to structures when a resonance is developed between the period of the wave and the structures. An example of this is the Los Angeles building where the light fixtures fell during the Tehachapi quake of July 21, 1952.

**AMERICAN SOCIETY OF CIVIL ENGINEERS SACRAMENTO SECTION**

Two color films, "Snow on the Run" and "Earthquake Damage and Repair" highlighted the June 2nd meeting, with the films and presentation being made by the Southern Pacific Railroad Company. Dr. James Bennett, assistant to the chief engineer of Hiller Helicopters spoke at the June 9th meeting on "Development of the Helicopter"; "Structural Use of Aluminum in Building and Bridges" by Eugene P. Burton of the Aluminum Company of America featured the June 16 meeting; "Growing Up" by R. A. Derr, manager of the Stockton Chamber of Commerce was the June 23 meeting theme; and "The Role of the Engineer in Civil Defense" was the topic of the June 30 meeting with Brigadier General, Retired, Dwight Johns, U. S. Army Corps of Engineers, the principal speaker.

**AMERICAN SOCIETY FOR METALS PUGET SOUND CHAPTER**

Reported by H. L. Southworth, Boeing Airplane Co.

The final session of the 1953 educational program recently presented by the Puget Sound Chapter consisted of a panel discussion on "Non-destructive Testing of Metals." The panel members were H. L. Southworth, J. E. Carton and V. I. Black all of Boeing Airplane Company. The speakers presented talks and demonstrations on "Magnetic and Penetrant Methods," "Ultrasonic Testing" and "Industrial X-Ray" in which the practical applications of these nondestructive methods were emphasized.

**SPECIFICALLY DESIGNED...**

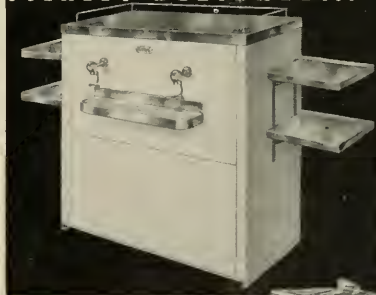

for primary and intermediate  
**SCHOOLS**

**HAWS**—the complete line—makes specifying easy. Two special school drinking water units illustrated typify the design latitude attainable from HAWS. Special models for specific use...and without custom-made price tags.

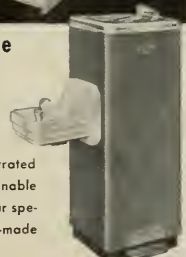

See Sweets or write for the new HAWS Catalog

**HAWS DRINKING FAUCET CO.**

1443 FOURTH STREET • BERKELEY 10, CALIFORNIA

# PRODUCER'S COUNCIL PAGE

The National Organization of Manufacturers of Quality Building Materials and Equipment  
(Northern California Chapter) affiliated with THE AMERICAN INSTITUTE OF ARCHITECTS

President, Roly MacNichol  
Libbey-Owens-Ford Glass Co.  
Rialto Bldg.

Vice-President, Ted Bakeman  
F. W. Wakefield Brass Co.  
445 Bryant Street

Secretary, John Cowley  
Hamilton Manufacturing Co.  
2833 3rd Street

Treasurer, Carl Frank  
Detroit Steel Products Co.  
Russ Building

Edited by Phil Brown, OTIS ELEVATOR COMPANY.

## RETIREMENT

On June 30 G. R. "Ray" Kingsland is retiring from his position with the Otis Elevator Company and his other associated business activities, which includes the Producers' Council.



G. R. Kingsland

Ray, in his association with the Producers' Council, has done more for the Council than any other member. He was one of the original group of founders of our Chapter and was its president for the first three years (1931-2-3). Ray could well be called "father" of the San Francisco Chapter.

At the Chapter's very inception, Ray attended the National Convention of the A.I.A. in San Antonio from which he returned with the enthusiasm of other attending members of Eastern Producers' Council Chapters. It was this gentleman who carried the message of the Producers' Council to the various A.I.A. Chapters and manufacturers throughout the Bay Area and it was due to his work that the Council got its successful start on the road to being an organization with high ideals.

Ray is retiring to enjoy his family, his garden, some traveling, and an occasional golf game after 45 very successful years with the Otis Elevator Company.

At the annual installation of new Chapter officers, attended by many of Ray's personal friends made within the architectural profession, Ray was honored with a scroll presented by President Al West, thanking him for his tremendous service to the Producers' Council.

## NEW COMMITTEES

At the last regular business meeting, it was proposed and approved that the Producers' Council expand its committee activities to include four new committees.

The By-Laws, originally included four committees; namely, Education, Entertainment, Membership, and Publicity.

Due to the expansion of the Council within the last few years and to our wish to continue and spread our activities to the Northern California Chapters of the A.I.A., four new committees have been approved. These new committees are—

1. Fellowship
2. Joint A.I.A. & Producers' Council
3. Joint A.G.C. & Producers' Council
4. Finance

This additional organization will enable the Council to function more efficiently and effectively.

## NEW OFFICERS

With a marked absence of filibustering and a valiant attempt by President Al. West to stay within parliamentary procedure, our new officers for the coming year were elected at the last business meeting, which was organized, oddly enough, to elect new officers.

The men responsible for the activities during 1953 and 1954 are—

President, Roly MacNichol, Libbey-Owens-Ford Glass Co.; Vice President, Ted Bakeman, F. W. Wakefield Brass Co.; Secretary, John Cowley, Hamilton Manufacturing Co.; Treasurer, Carl Frank, Detroit Steel Products Co.

USE QUALITY PRODUCTS



CONSULT AN ARCHITECT

## BOISE SCHOOL

(From Page 19)

added in present solid brick walls reserved for blackboards, without too much cost. Heating system would require no conversion. Toilet banks only would have to be removed. Economy has been a keynote of this building, and yet the children and teachers find it very comfortable and pleasant.

Madison is in an area not too far from two other large elementary schools, served by school buses. An attractive planter fills a recess in front of the windows serving the principal's office to lend further color to the residential atmosphere created by the building. Rear doors open onto a macadamized play area. All classrooms are identical in size, 33 by 24 feet.

Administrative offices, teachers and nurses rooms, waiting room and kitchen have all been arranged in a compact area near the center of the school and easily accessible to all six classrooms. An open counter from the kitchen facing the inner hall enables rapid service of tiny students at meal time. Students may thus line up in the long hallway and pass by the open service window to get their food, all with a minimum of inconvenience.

Madison is an efficient, well-planned school. It answers one of the problems which all school officials must face. That is, how to get comfortable teaching space now while the peak of war-babies need schooling, and yet avoid having a white elephant on hand a few years hence when the demand for primary facilities in this number may have passed.

## OREGON ARCHITECTURAL STUDENTS INSTALL DOME

A 36-foot diameter wood framed, transparent plastic-skinned Geodesic Dome was recently installed on the University of Oregon campus by students in the School of Architecture and Allied Arts, and under the supervision of R. Buckminster Fuller, designer-engineer and creator of Dymaxion architecture.

Design, fabrication, and assembly of the Dome, viewed as a "prototyping experiment in design and production engineering," and in which a volunteer group of more than 40 students participated, was completed in seven days.

Many uses are predicted for the building which is 36 feet in diameter and 18 feet high. It is quickly knocked down and reassembled and easily transported. It has no right-angle cuts. Structural members are plywood with light wood cross bracing, covered with plastic, then bolted together with joints covered with weatherproof tape.

PM-284

G-168-285

SKYLIKE

... QUALITY  
... ECONOMY  
... DEPENDABILITY  
... FOR  
... SCHOOLS  
... OFFICES  
... MERCHANDISING  
... SPECIFY QUALITY  
... EQUIPMENT  
... SMOOT-HOLMAN

SALES OFFICES IN MOST PRINCIPAL CITIES  
BRANCH OFFICE AND  
WAREHOUSE SAN FRANCISCO

**SMOOTHOLMAN**

**SMOOTHOLMAN ILLUMINATION EQUIPMENT INGLEWOOD CALIFORNIA**

## PORCELAIN ENAMEL VENEER

This trim, clean, corner close-up typifies the craftsmanship and vitreous, fired-in beauty you assure when you specify **PORCELAIN ENAMEL VENEER**. Appropriate for every installation... from modest shop to staid institution.

Architectural Design  
Bank Planning Division  
CAPITAL COMPANY, San Francisco

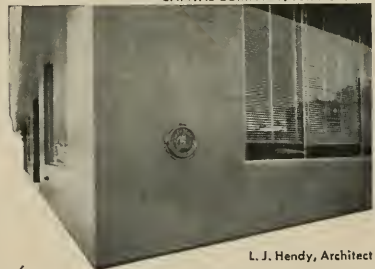

L. J. Hendy, Architect

*Architectural Division*

**PORCELAIN ENAMEL PUBLICITY BUREAU**  
P. O. BOX 1186, EAST PASADENA STATION, PASADENA 8, CALIFORNIA  
ROOM 601, FRANKLIN BUILDING, OAKLAND 12, CALIFORNIA



# PERSONALITIES

## CLARENCE CULLIMORE Architect, F.A.I.A.

Bakersfield, California

Graduated B.S. University of California, Berkeley, 1910; M. Architecture, University of Southern California, 1942. Certified to practice Architecture in California 1925;



Clarence Cullimore  
Architect, F.A.I.A.

Specialist in scientific design and construction of adobe buildings made fireproof, water-proof, and earthquake-proof, and his wide experience and successful application of adobe to residential architecture has made him internationally prominent in this field. His exhaustive studies and contributions to the art and science of architecture in the adobe field has laid a secure

foundation for the future progress of this typical California art.

1st Lt. Machine Gun Bn., U. S. Army, World War I.

Prominent in local civic, fraternal and governmental affairs.

Author: Mechanical Drawing for High School Students, 1921; Old Adobes of forgotten Fort Tejon, 1942; Adobe Architecture, 1947; Historic Old Adobes of Santa Barbara, 1947; Contributed many articles on old adobes to Los Angeles Sunday Times, and American Institute of Architecture publications.

His son, Clarence Cullimore, Jr., is also an architect having graduated from the University of Southern California in Architecture and successfully passed the architectural examinations of the California State Board of Architectural Examiners.

*NEXT MONTH: Paul Thiry, A.I.A. Architect, Seattle, Washington.*

## NORTHERN CALIFORNIA BUILDERS HARDWARE CLUB

Everett Appleton, president of the Northern California Builders' Hardware Club and buyer for Dunham, Carrigan & Hayden company, announced the Club's July 15 meeting will be devoted to a "Sport's Night" theme.

Motion pictures of the 1952 Olympic Games will

# BRONZE PRODUCTS by GREENBERG

Your best and nearest source for standard and special Bronze products



STABILITY since 1854

## M. GREENBERG'S SONS

765 Folsom St • San Francisco • Calif • EXbrook 2-3143

Manufacturers of Fire Hydrants and Fire Protection  
Brass Goods • Industrial, Navy and Maritime  
Bronze Valves and Fittings • Plumbing and  
Hardware Brass Specialties • Bronze Plaques,  
Letters and Name Plates.

LOS ANGELES • PHOENIX • SEATTLE • PORTLAND • SPOKANE • SALT LAKE CITY • DENVER • KANSAS CITY • NEW ORLEANS • HONOLULU • NEW YORK • WASHINGTON, D. C.

be shown, as will an old time movie featuring the '49er. Everyone interested in the builders hardware industry is invited to attend.

Officers of the organization, in addition to Appleton, include: Clark Van Housen, of the McKinney Co., treasurer; Robert Depot of the Stanley Co., secretary; and Jim Whitty of the E. M. Hundley Co., sergt. at arms.

### ROBERT GUNN VISITS EASTERN BUILDERS

Robert Gunn, an official of the Vincent Whitney Company of Sausalito, manufacturers of window sash hardware, returned to his California home recently from an extended business trip to many eastern and mid-western cities, where he conferred with distributors and representatives of his firm.

Conditions in the construction industry were generally reported good and excellent sales of the Sausalito firm are predicted for the balance of the year.

### PRODUCERS COUNCIL MANAGER NAMED NATIONAL CHAMBER AID

Charles M. Mortensen, Managing Director of the Producer's Council, Inc., has been appointed Associate Manager of the Trade Association Department of the Chamber of Commerce of the United States, it was announced recently by Arch N. Booth, Executive Vice President of the Chamber.

Mortensen joined the staff May 1 and will work with Henry P. Fowler, present manager of the Trade Association Department, until the latter's retirement on August 31. He brings to the job more than 19 years of experience in the fields of engineering, sales, public relations and promotion work.

Mortensen has been with the Producers' Council since 1947. Before that, he was employed as California Regional Engineer for the American Iron and Steel Institute. He begun his career in 1934 as



Altar—St. Ambrose Church, Berkeley  
Vincent Buckley, Architect

Manufactured and  
Installed by  
**THE FINK & SCHINDLER CO.**  
Since 1882

Bank, Store, Bar, Office and School  
Fixtures, Interior Woodwork,  
Laboratory Equipmet.

552 BRANNAN STREET  
San Francisco, Calif.

EXbrook 2-1513

For **LONG LASTING BEAUTY**  
in the Swimming Pool...

Specify Protective  
**RAMUC ENAMEL!**

- ✓ 9 beautiful sunfast colors
- ✓ Looks like—feels like tile
- ✓ Waterproof rubber base
- ✓ Won't crack or peel
- ✓ Resistant to heat and cold

Lasts far longer, looks far better than ordinary swimming pool paints. DESCRIPTIVE specification details available to architects, contractors, engineers.

Write Dept. A.E.

An  
**Inertol**  
Product

**INERTOL CO. INC.**  
27 SOUTH PARK • SAN FRANCISCO 7

## Summerbell for SCHOOL ADMINISTRATION



Warehouse, Public School  
Administration, Long Beach, Calif.  
Architect, Francis J. Heusel.

Structural Engineer,  
J. H. Davies.  
General Contractor,  
Mille-Severson Inc.

SUMMERBELL Bowstring Trusses play an increasingly important part in helping the Architects and School Authorities in keeping up with the constantly growing demand for more facilities in the face of limited budgets and a growing insistence for lower taxes. SUMMERBELL Bowstring Trusses and glued laminated arches and beams are the economical answer to the need for low-cost warehouses, shops, classrooms, gymnasiums and School buildings of all kinds.

Glued Laminated Construction • Summerbell Bowstring Trusses  
Lamella Roofs & All Types of Timber Structures

For quality, economy and satisfaction, specify **SUMMERBELL**

**Summerbell ROOF STRUCTURES**  
825 EAST 29TH STREET • BOX 218, STATION "K" • LOS ANGELES 11

# REDUCE TILT-UP CONSTRUCTION COSTS

with  
**Thompson's  
WATER SEAL**



for surface slabs  
and tilt-up panels

- Locks out moisture, acts as bond breaking agent.
- Permits easy lifting of panels without suction.
- Eliminates hairline cracks for smoother concrete surfaces.
- Gives slower, more uniform curing.
- Protects against seepage, prevents efflorescence.

**MANY OTHER CONSTRUCTION USES:**

For lasting protection against moisture, use Thompson's Water Seal for plywood forms, concrete blocks, brick, tile, stucco, plasterboard and any other porous material.

Sold in 1, 5, 30, 55 gal. sizes. Ready to use — no mixing. Applied easily by spraying, brushing, mopping or dipping.

Available at paint, hardware or building supply dealers.

**BY-CHEMICAL PRODUCTS CO.**

1355 Market Street • San Francisco 3, California

There's a **NEW** HEAVY DUTY

FULLY AUTOMATIC, METERING PUMP

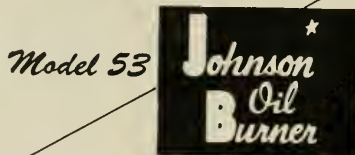

It's built with an amazing new Metering Pump which produces the finest performance ever achieved on "cold starts" and "variable viscosity" oils . . . plus several other new and improved features which make it exceptionally economical, dependable, and easy to service. Available in seven sizes — from 25 H.P. to 400 H.P. For full description of Model 53 see your nearest Johnson Dealer or write to us direct.

...*Johnson Oil Burners*...

S. T. JOHNSON CO.  
940 Arlington Ave., Oakland 8, Calif.  
Church Road, Bridgeport, Pennsylvania

a field engineer for the Iowa State Planning Board. Later he worked as sales engineer for the United-Des Moines Clay Products Co., and as Director of Public Relations for the Structural Clay Products Institute, Washington, D.C. During World War II, he served as a Naval gunnery officer assigned to the destroyer U.S.S. Steven Potter which saw action off Okinawa and Japan.

## UNIQUE TILE EXHIBIT

(From Page 27)

and Salt Lake City has far exceeded anything anticipated. The exhibit will show at Monterey, San Francisco, the California State Fair at Sacramento, and Fresno County Fair.

Planning is already under way for a complete new exhibit for the 1954 season, which will display the new developments in decorative tile and new colors to keep pace with the ever changing interior decorations of the modern home.

The exhibit this year is jointly sponsored by five tile manufacturers: Cambridge Tile Co.—Emil te Groen, representative; Gladding, McBean & Co.—R. A. Sinnott and R. V. Jeffrey, representatives; Mosaic Tile Co.—A. E. Guerra and Howard DeWeese, representatives; Pacific Tile & Porcelain Co.—Thomas Dillon, No. California Distributor; Pomona Tile Co.—Claire Wilson, representative.

Crane Company furnished the tub and built-in pullman lavatory and L & H Company supplied the built-in electric surface unit and the electric oven in the cabinet.

## WOODWORK INSTITUTE DIRECTORS MEET IN SAN JOAQUIN VALLEY

The regular quarterly meeting of the Board of Directors of the Woodwork Institute of California met in Fresno on May 22 in keeping with the newly established policy of the organization to hold meetings in various parts of the state.

Committee reports included: Membership, Hollis Jones of the Western Door & Sash Co., Oakland;

## HAAS and HAYNIE

Formerly Haas Construction Company

Since 1898

275 PINE ST.

SAN FRANCISCO, CALIF.

Phone DOuglas 2-0678



Program, Seth Potter of the Stockton Box Co., Stockton; Technical, S. Karns of Fresno and others.

Attending were: Stanley Gustafson, Sacramento; Seth Potter and Jack Little, Stockton; Ernie Atkinson and Hollis Jones, Oakland; J. L. Pierce, Santa Clara; Arthur Bernhauser and S. S. Kerns, Fresno; Tom Work, Monterey; L. J. Woodson, San Francisco; T. M. Cobb, Perry Acuff and Al Little of Southern California, and Russell Bjorn, manager-director.

The next meeting has been set for Monterey during August.

### LAWRENCE LIVINGSTON, JR. JOINS JOHN CARL WARNECKE

Lawrence Livingston, Jr., former assistant City Planning Engineer of the City of Oakland, and John Carl Warnecke, A.I.A. architect of San Francisco and Oakland, have joined forces to provide one of the most comprehensive architectural and planning service on the Coast.



LAWRENCE LIVINGSTON, JR.  
Planner

The correlation of architectural design and the planning of large areas, taking into consideration their broader relation to the community and its development, is a trend which promises benefits to client and public alike. This wide service is particularly valuable in the solution of the many

problems facing rapidly growing communities as well as the builders of new projects.

This new service is also extended to the firm of Warnecke & Warnecke, in which John Carl Warnecke is associated with his father, Carl I. Warnecke, A.I.A.

### DEEPENING OF COLUMBIA RIVER ENTRANCE RECOMMENDED BY ARMY

Deepening to 48 feet of the navigation channel of the Columbia River, across the ocean bar and in the entrance, has been recommended by the North Pacific Division, Corps of Engineers. The channel depth now, as authorized by Congress, is 40 feet.

In addition, consideration in the future was recommended for construction of a spur jetty or such other contraction works as the Board of Engineers for Rivers and Harbors may find necessary and economically justified.

The improvements proposed are designed to provide greater depths needed by present-day larger type cargo ships and tankers and to correct

(See Page 40)

## Parker, Steffens & Pearce

BUILDERS



135 South Park, San Francisco

Phone: EXbrook 2-6639

## FORDERER CORNICE WORKS

Manufacturers of

Hollow Metal Products • Interior Metal Trim  
Elevator Fronts and Cabs  
Metal Plaster Accessories • Sanitary Metal Base  
Flat and Roll Metal Screens  
Metal Cabinets • Commercial Refrigerators

269 POTRERO AVE.

SAN FRANCISCO, CALIF.

HEMLOCK 1-4100

## BARRETT & HILP CONTRACTORS

*Serving The Construction Field  
Since 1912*

OUR FORTIETH YEAR

918 Harrison Street • San Francisco  
Telephone DOuglas 2-0700

## CLASSIFIED ADVERTISING

Do YOU want to hire, buy, sell, rent, find, lose, and otherwise transact business with others in the Construction Industry? If so, your best bet is a CLASSIFIED ad in ARCHITECT & ENGINEER magazine.

SELL that used equipment at a good price; secure competent employees; buy good used equipment; obtain information on wanted materials, etc.

Rates are low 20 cents per word—cash with order—minimum 3 lines. "Position Wanted" ads are half-rate.

Forms close 20th of month preceding date of publication.

ARCHITECT & ENGINEER  
MAGAZINE

68 Post Street

San Francisco

**CLINTON  
CONSTRUCTION CO.  
OF CALIFORNIA**

**General Contractors**

923 FOLSOM STREET • SAN FRANCISCO

SUtter 1-3440

**HOGAN LUMBER CO.**

Wholesale and Retail

**LUMBER**

**MILL WORK • SASH & DOORS**

Office, Mill, Yard and Docks

SECOND AND ALICE STREETS • OAKLAND, CALIF.

Telephone GLencourt 1-6861

**ALLIANCE ENGINEERS**

C. L. WEEKS  
Civil Engineer No. 4943

**COST ENGINEERS  
QUANTITY SURVEYORS  
APPRAISERS**

★ Preliminary & Final Estimates ★

602 West Santa Barbara Avenue  
Los Angeles 37, California  
ADams 3-7138

**JUDSON PACIFIC - MURPHY CORP.**

**Steel Fabricators  
and  
Erectors**

**REINFORCING STEEL  
STRUCTURAL STEEL  
BRIDGE CRANES**

4300 EASTSHORE HWY.  
EMERYVILLE, CALIF.

Phone:  
OL 3-1717

**BOOK REVIEWS  
PAMPHLETS AND CATALOGUES**

**ARCHITECTURAL GRAPHS.** By C. Leslie Martin. The MacMillan Company, 60 - 5th Ave., New York 11. Price \$4.00.

The author, C. Leslie Martin, is Associate Professor of Architectural Design at the University of Cincinnati, has compiled a group of studies on the theory that Drawing is the universal language of the architect and designer.

The text is written so that it can be understood by persons who do not have the help of a teacher, and explains the characteristics of types of drawings and principles used giving explanations and simple examples.

Subjects covered by the author, include Orthographic and Oblique Drawings, Perspective Drawing, and Shades and Shadows. Many drawings and photographs are used. 213 pages.

**BEHIND THE SCENES OF BUSINESS.** By Roy A. Foulke. Dun & Bradstreet, Inc., 99 Church St., New York 8.

A revision of the issue of 1952, enlarged to meet the present economic situation. All tables have been brought up to date, and new cases and current business problems and situations have been added.

A new chapter "Relativity of the Moral Hazard" has been added. It discusses the influence of a progressively adverse financial condition of a business upon the moral stamina of individuals in management, and how in times of great pressure, it may occasionally result in a breakdown of Character.

**HOW TO CONTROL MOISTURE IN HOMES.** National Mineral Wool Association, 2906 RKO Bldg., New York 20. Price 25c.

Problems of excessive indoor moisture in homes, its cause, effects, prevention and control, is given far reaching and well documented study in this 72-page booklet.

Generously illustrated the book is directed to home owners and craftsmen in the building trades as well as to architects, contractors, applicators, material manufacturers, and dealers in supplies.

**NEW CATALOGUES AVAILABLE**

*Architects, Engineers, Contractors, Planning Commission members—the catalogues, folders, new building products material, etc., described below may be obtained by directing your request to the name and address given in each item.*

**Stainless Steel Wire** is described in a new 20-page booklet of technical data on the application of stainless steel wire. Tables of physical properties, corrosion resistance, and analysis are included. Copies of the booklet are available from Allegheny Ludlum Steel Corp., 2020 Oliver Bldg., Pittsburgh 22, Pa.

**Standardized Hangars** by Luria—a new illustrated catalog on structures for civil and military aircraft; contains descriptions, photographs, cross-sectional drawings and specifications of various types of standardized hangars, lean-to's and clear-span service buildings. Highlighted advantages are the lower costs made possible by mass production methods, speed of erection, permanence of steel-frame design and adaptability to special requirements. Copies available from Luria Engineering Co., 500 5th Ave., New York 36.

**Airco electrodes.** Over 30-different electrodes, stainless, mild and high tensile steels, cast iron, non-ferrous, low hydrogen, and hardfacing are described as to chemical analysis, procedure for welding and application in a new 50-page pocket book guide. Other sections in the booklet include "Picking the Right Electrode," mechanical properties and testing of electrodes, and specifications. Copies of this illustrated guide may be obtained by writing Air Reduction Pacific, 220 Bush Street, San Francisco, California.

**Hard facing.** The subject of Hard Facing, a production method used to lower maintenance and replacement costs, is presented in a color booklet just published. It describes the method of applying hard alloy metal to a low alloy steel base at areas of wear to hold down production costs on original equipment; also illustrates how operating life of worn equipment is increased by the proper and economical application of hard facing. Hard facing alloys are now applied to lineal, cylindrical or contoured shapes to provide excellent anti-cor-

rosive characteristics, increased operating life, resistances to high temperature, impact and abrasion. Copies of this colorful, profusely illustrated pamphlet containing photographs and descriptive data illustrating the types of products hard faced and the industries served, may be obtained by writing Cleveland Hard Facing, Inc., 3047 Stillson Ave., Cleveland 5, Ohio.

**Garden lighting.** A new catalog of garden and residential outdoor play area lighting units featuring the Steber line has just been published. An important item in this new line is the Steber Floridite which is a handy garden light approximately 30-inches high, mounted on an aluminum ground spike for mounting anywhere in the garden or lawn. It is supplied with clear glass globe with inside frost for use with white, colored, or insect repellent lamps, and can be had with 10-foot or 25-foot attachment cord and plug. Play area lights consist of sturdy lampholders mounted to extension poles, one adjustable 5 to 8 feet high, the other 5 to 15 feet high. This Bulletin No. 135-53 is available from the Steber Mfg. Co., Broadview, Illinois.

**Expandable concrete forms.** A new booklet describing the advantages of Rubora expandable concrete forms has just been issued; contains description of use and photographs showing actual application of forms. Developed in the Netherlands the product can be re-used up to 100 times. Copies of the booklet and full details from the Kurt Orban Co., Inc., 1939 Santa Fe Ave., Los Angeles, Calif.

**Impregnation of porous castings.** The whole development and application story of modern impregnation of porous castings is available in a new, 2-color bulletin containing complete illustrations. The booklet shows how impregnation by a 100% solid copolymer differs from older methods, and why only these new materials and methods can achieve complete impregnation. Photographs show the equipment used in batch immersion for the rapid treatment of large quantities of parts, as well as applications in various metals. Tables show properties of the new impregnant and corrosives it will resist.

**Cork insulation.** An illustrated 8-page bulletin describes the composition, application and uses of Whitcote No. 820 Cork Insulation. It is a cold-application fluid type of material composed of highly efficient insulating fillers of cork and asbestos and a bituminous base possessing unusual adhesive, water-proofing and corrosion-proofing qualities. Applied directly from drum by hand operated sprayguns.

Complete data as to thickness and coverage is given. Available from Witco Chemical Co., Pioneer Asphalt Div., 75 E. Wacker Drive, Chicago 1.

**Church Arches.** A new brochure on Church Arches designed to cover the subject so that the architect, the builder and the layman, can visualize the style of arches to be used in any church construction. Just enough structural detail is given to enable the builder or contractor to judge erection costs in preliminary estimates. Many photographs and drawings are included. Available from McKeown Bros. Co., 5302 S. Keeeler Ave., Chicago 32.

**Manual and magnetic motor starters.** Two new leaflets, no's 404 and 504, describing in detail specifications and applications of the Federal Electric's line of manual and magnetic motor starters is now available. The pamphlets describe special design features such as double-break silver contacts, servicing accessibility, and complete mounting flexibility; also sizes and horsepower, and type of current used. The magnetic motor starter booklet includes information on remote control, local control and selector switch control, in various types and sizes. Both publications are available from Federal Electric Products Co., 50 Paris St., Newark 5, N. Y.

**Glass fiber pipe insulation.** Many unusual and different features of a new one piece molded fine glass fiber pipe insulation are described in a booklet entitled "G-B Ultrafine - Pipe Insulation." Photographs show types of application and methods; data on temperatures, and packaging. Copies are available from the Gustin-Bacon Mfg. Co., Kansas City, Mo.

**Dual-fuel firing for heating.** A new four-page, three color folder on gas and dual-fuel firing for heating, processing, and power is available from the firm listed below.

Emphasis is laid on the advantages of zone fired control for low start and modulated firing permitted by the Iron Fireman vertical gas burner, on the features of the "in-shot" type of burner with its efficient radiant heat, on ring-type burners designated for intermediate and high pressure gas, and on the recently announced dual fuel package unit combining the Radiant gas burner with the gun-type commercial oil burner. Copies of data may be secured from Iron Fireman Mfg. Co., Cleveland 11, Ohio.

# VERMONT MARBLE COMPANY

DOMESTIC AND IMPORTED MARBLES  
GRANITE VENEER

525 MARKET STREET • SAN FRANCISCO 5

Phone: SUtter 1-6747

3522 COUNCIL STREET • LOS ANGELES 4

Phone: DUnkirk 2-7834

The Most Complete Line of  
STEELS and STEEL BUILDING MATERIALS  
Made by a Single Producer



See Sweet's Catalog File or write us for full information.

REPUBLIC STEEL CORPORATION

GENERAL OFFICES: CLEVELAND, OHIO

DENVER, COLORADO . . . CONTINENTAL OIL BUILDING  
LOS ANGELES, CALIF. . . GENERAL PETROLEUM BUILDING  
SAN FRANCISCO, CALIFORNIA . . . RIALTO BUILDING  
SEATTLE, WASH. . . . . WHITE-HENRY-STUART BUILDING

# PACIFIC MANUFACTURING CO.

High Class Interior Finish Quality  
Millwork

16 Beale St., San Francisco  
GARfield 1-7755

2215 El Camino Real, San Mateo  
S. M. 5-0637

304 Bryant Street, Palo Alto  
P. A. 3373

2610 The Alameda, Santa Clara  
S. C. 607 (Factory)

6820 McKinley Avenue, Los Angeles  
THornwall 4196

MAIN OFFICE — SANTA CLARA

# "AMERICAN - MARSH" CONDENSATION UNIT

Pumping  
Machinery  
for  
Every  
Purpose

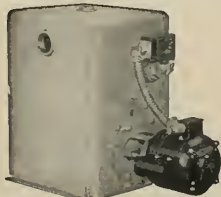

For Service  
Call  
DOuglas  
2-6794

or  
MUtual 8322

SIMONDS MACHINERY CO.  
SAN FRANCISCO 816 FOLSOM  
LOS ANGELES 455 EAST 4TH



## COLUMBIA RIVER . . .

(From Page 37)

physical characteristics of the entrance channel which are a hazard to navigation. The jetty or substitute works would be to reduce annual maintenance dredging requirements.

Cost to the Federal Government of the proposed improvements is estimated at \$8,550,000, of which \$2,898,000 would be for the initial deepening job.

### STRUCTURAL CLAY FACING TILE ONE OF NEWER PRODUCTS

The unique chemical properties of structural clay facing tile, one of the youngest of all clay products, have increased its use three-fold in the past ten years. Chemical plants, dairies, breweries, printing plants, industrial and institutional buildings now are being designed with interior walls of facing tile for sanitation, cleanliness, easy, low-cost maintenance and many special purposes offered by no other building material.

Facing tile should not be confused with ordinary wall tile, which is less than one-half inch thick and does not support its own weight. This relatively new material, developed in the past three decades, is a structural unit usually at least 4 inches thick. It holds its own weight and that of ceilings, roofs,

joists or other loads placed on it.

It is made of burned clay, same as brick, and generally burns to a tawny buff color, but it can be glazed with permanent porcelain finishes to any color from white to black. When glazed, its surface is impervious to acids, stains, smoke or soot, and can be cleaned easily with soap and water.

Used in industry, it has special values. It aids in humidity control, since moisture condenses and runs off its surface. In factories processing textiles, drugs, chemicals and foodstuffs, it helps control lint, dust and dirt, and does not absorb acid fumes or odors. Bacterial growth is prevented on the walls in meat packing plants and research laboratories by facing tile, impervious to bacteria. Usable shop space need not be left idle to provide for cumbersome cleaning and painting equipment required with other types of wall finishes.

R. H. Saunders, Chairman of the Facing Tile Institute, national association of facing tile manufacturers, points out that demand has constantly increased for this material, so that shipments of facing tile have risen each year from 154,000 tons in 1942 to an estimated 450,000 tons in 1952. "We look for a continued upward trend in facing tile shipments in 1953," Mr. Saunders added.

### SAN DIEGO COUNTY BUILDING VOLUME SHOWS BIG INCREASE

Residential building in the unincorporated area of San Diego county will show a sharp rise in 1953, according to Dr. Willis H. Miller, director of planning for San Diego county.

The number of tentative maps filed during January and February this year is nearly double the number filed during the corresponding period in 1952, while the total number of lots proposed is over four times as great.

### FREEZE ON ALASKA MILITARY CONSTRUCTION THAWED SOME

Colonel Carl Y. Farrell, acting District Engineer, Alaska District Corps of Engineers, announced recently that the freeze placed upon Alaska's multi-million dollar defense construction program had been lifted by the Bureau of the Budget on twelve Army projects.

The twelve items cover construction at Fort Richardson, Ladd and Eielson Air Force Bases.

Of the \$240-millions 1953 Alaska defense construction program \$60-millions have been awarded.

APPOINTED AGENT: Wm. C. Tagmyer has been appointed sole Northern California agent for Tube-sales, according to a recent announcement by F. G. Harmon, President. Offices will be maintained at 268 Market Street, San Francisco.



**HOLLYWOOD JUNIOR  
COMBINATION  
SCREEN and METAL SASH DOOR  
★  
The "WEATHER-WISE"  
DOOR!!**

**A VENTILATING SCREEN DOOR  
A SASH DOOR  
A PERMANENT OUTSIDE DOOR  
ALL 3 IN 1!**

Discriminating home owners and architects have chosen Hollywood Junior as the TRIPLE DOOR VALUE in the COMBINATION SCREEN and METAL SASH DOOR field! A sturdy dependable door, constructed of quality materials, HOLLYWOOD JUNIOR'S EXCLUSIVE PATENTED FEATURES have outmoded old-fashioned screen doors and other doors of its type entirely!

**IT GUARANTEES YOU YEAR 'ROUND  
COMFORT, CONVENIENCE and ECONOMY**

WE ALSO MANUFACTURE A COMPLETE LINE OF  
SHUTTERS, C. C. DOORS, SCREENS, SCREEN DOORS, LOUVRE DOORS

**WEST COAST SCREEN CO.**  
1145 EAST 83rd STREET LOS ANGELES, CALIFORNIA  
ADAMS 1136

WRITE FOR FREE ILLUSTRATED LITERATURE

# ESTIMATOR'S GUIDE

## BUILDING AND CONSTRUCTION MATERIALS

PRICES GIVEN ARE FIGURING PRICES AND ARE MADE UP FROM AVERAGE QUOTATIONS FURNISHED BY MATERIAL HOUSES TO SAN FRANCISCO CONTRACTORS. 3% SALES TAX ON ALL MATERIALS BUT NOT LABOR

All prices and wages quoted are for San Francisco and the Bay District. There may be slight fluctuation of prices in the interior and southern part of the state. Freight charge, at least, must be added in figuring country work.

**BONDS**—Performance or Performance plus Labor and Material Bond(s), \$10 per \$1000 on contract price. Labor & Material Bond(s) only, \$5.00 per \$1000 on contract price.

**BRICKWORK—MASONRY—**

Common Brick—Per 1 M laid—\$150.00 up (according to class of work).  
 Face Brick—Per 1 M laid—\$200.00 and up (according to class of work).  
 Brick Steps—\$3.00 and up.  
 Common Brick Veneer on Frame Bldgs.—Approx. \$1.20 and up (according to class of work).  
 Face Brick Veneer on Frame Bldgs.—Approx. \$2.00 and up (according to class of work).  
 Common Brick—\$36.00 per M truckload lots, delivered.  
 Face Brick—\$81.00 to \$106.00 per M, truckload lots, delivered.

**Glassed Structural Units—Walls Erected—**

Clear Glazed—  
 2 x 6 x 12 Furring.....\$2.00 per sq. ft.  
 4 x 6 x 12 Partition.....2.25 per sq. ft.  
 4 x 6 x 12 Double Faced  
 Partition.....3.00 per sq. ft.  
 For colored glaze add......30 per sq. ft.  
 Mantel Fire Brick \$150.00 per M—F.O.B. Pittsburgh.  
 Fire Brick—Per M—\$11.00 to \$147.00.  
 Carriage—Approx. \$10.00 per M.  
 Paving—\$75.00.

**Building Tile—**  
 8x5/2x12-inches, per M.....\$139.50  
 6x5/2x12-inches, per M.....105.00  
 4x5/2x12-inches, per M.....84.00

**Hollow Tile—**  
 12x12x2-inches, per M.....\$146.75  
 12x12x3-inches, per M.....156.85  
 12x12x4-inches, per M.....177.10  
 12x12x6-inches, per M.....235.30  
 F.O.B. Plant

**BUILDING PAPER & FELTS—**

1 ply per 1000 ft. roll.....\$5.30  
 2 ply per 1000 ft. roll.....7.80  
 3 ply per 1000 ft. roll.....9.70  
 Brownlin, Standard 500 ft. roll.....6.85  
 Sisalkraft, reinforced, 500 ft. roll.....8.50

**Sheathing Papers—**  
 Asphalt sheathing, 15-lb. roll.....\$2.70  
 30-lb. roll.....3.70  
 Dampcourse, 216-ft. roll.....2.95  
 Blue Plasterboard, 60-lb. roll.....5.10

**Felt Papers—**  
 Deadenng felt, 3/4-lb., 50-ft. roll.....\$4.30  
 Deadenng felt, 1-lb.....5.05  
 Asphalt roofing, 15-lbs.....2.70  
 Asphalt roofing, 30-lbs.....3.70

**Roofing Papers—**  
 Standard Grade, 108-ft. roll, Light.....\$2.50  
 Smooth Surface, Medium.....2.90  
 Heavy.....3.40  
 M. S. Extra Heavy.....3.95

**BUILDING HARDWARE—**

Sash cord com. No. 7.....\$2.65 per 100 ft.  
 Sash cord com. No. 8.....3.00 per 100 ft.  
 Sash cord spot No. 7.....3.65 per 100 ft.  
 Sash cord spot No. 8.....3.35 per 100 ft.  
 Sash weights, cast iron, \$100.00 ton.  
 1-Ton lots, per 100 lbs.....\$3.75  
 Less than 1-ton lots, per 100 lbs.....4.75  
 Nails, per keg, base.....\$12.55  
 8-in. spikes.....12.45  
 Rim Knob lock sets.....\$11.80  
 Butts, dull brass plated on steel, 3/2x3/2......76

**CONCRETE AGGREGATES—**

The following prices net to Contractors unless otherwise shown. Carload lots only.

	Bunker per ton	Del'd per ton
Gravel, all sizes.....	\$2.44	\$2.90
Top Sand.....	2.38	3.13
Concrete Mix.....	2.38	3.06
Crushed Rock, 1/4" to 3/4".....	2.38	2.90
Crushed Rock, 3/4" to 1 1/2".....	2.38	2.90
Roofing Gravel.....	2.81	2.90
River Sand.....	2.50	3.00
<b>Sand—</b>		
Lapis (Nos. 2 & 4).....	3.56	3.94
Olympia (Nos. 1 & 2).....	3.56	3.88

**Cement—**  
 Common (all brands, paper sacks),  
 Per Sack, small quantity (paper).....\$1.05  
 Carload lots, in bulk, per bbl.).....3.55  
 Cash discount on carload lots, 10c a bbl., 10th Prox., less than carload lots, \$4.00 per bbl. f.o.b. warehouse or delivered.  
 Cash discount 2% on L.C.L.  
 Trinity White..... { 1 to 100 sacks, \$3.50 sack  
 Medusa White..... { warehouse or del.; \$9.56  
 bbl. carload lots.

**CONCRETE READY-MIX—**

Delivered in 4-yr. loads:  
 Per cubic yard, 1-8 Mix.....\$ 9.80  
 1-7 Mix.....10.15  
 1-6 Mix.....10.70  
 1-5 Mix.....11.40  
 Curing Compound, clear, drums,  
 per gal.....1.03

**CONCRETE BLOCKS—**

	Hay-dite	Ba-salt
4x8x16-inches, each.....	\$.19	\$.19
6x8x16-inches, each.....	.23	.235
8x8x16-inches, each.....	.27	.27
12x8x16-inches, each.....	.38	.40
12x8x24-inches, each.....	.....	.60

**Haydite Aggregates—**  
 3/4-inch to 3/8-inch, per cu. yd.....\$7.75  
 3/8-inch to 1/8-inch, per cu. yd.....7.75  
 No. 6 to 0-inch, per cu. yd.....7.75

**DAMP-PROOFING and Waterproofing—**

Two-coat work, \$9.00 per square.  
 Membrane waterproofing—4 layers of saturated felt, \$10.00 per square.  
 Hot coating work, \$5.00 per square.  
 Medusa Waterproofing, \$3.50 per lb. San Francisco Warehouse.  
 Tricosal concrete waterproofing, 60c a cubic yd. and up.

**ELECTRIC WIRING—\$15 to \$20 per outlet for conduit work (including switches).  
 Knob and tube average \$6.00 per outlet.**

**ELEVATORS—**

Prices vary according to capacity, speed and type. Consult elevator companies. Average cost of installing a slow speed automatic passenger elevator in small four story apartment building, including entrance doors, about \$9,500.00.

**EXCAVATION—**

Sand, \$1.00; clay or shale, \$1.50 per yard. Trucks, \$30 to \$45 per day.  
 Above figures are an average without water. Steam shovel work in large quantities, less; hard material, such as rock, will run considerably more.

**FIRE ESCAPES—**

Ten-foot galvanized iron balcony, with stairs, \$250 installed on new buildings; \$300 on old buildings.

**FLOORS—**

Asphalt Tile, 1/8 in. gauge 18c to 35c per sq. ft.  
 Composition Floors, such as Magnesite, 40c-\$1.25 per sq. ft.  
 Linoleum, standard gauge, sq. yd.....\$2.75  
 Mastipave—\$1.50 per sq. yd.  
 Battleshop Linoleum—1/8"—\$3.00 sq. yd.  
 Terrazo Floors—\$2.00 per sq. ft.  
 Terrazo Steps—\$2.50 per lin. ft.  
**Mastic Wear Coat—**according to type—  
 20c to 35c.

**Hardwood Flooring—**

**Oak Flooring—T & G—Unfin.—**  
 Clear Old., White.....\$32 1/2  
 Clear Old., Red.....405 380  
 Select Old., Red or White.....355 340  
 Clear Pln., Red or White.....355 340  
 Select Pln., Red or White.....340 330  
 #1 Common, Red or White 315 310 305 280  
 #2 Common, Red or White 305 280

**Refinished Oak Flooring—**

	Prime	Standard
1/2 x 2.....	\$369.00	\$359.00
1/2 x 2 1/2.....	380.00	370.00
1/2 x 2 3/4.....	390.00	381.00
3/4 x 2.....	375.00	355.00
3/4 x 3/4.....	395.00	375.00
1/2 x 2 1/4 & 3/4 Ranch Plank.....	415.00	415.00

**Unfinished Maple Flooring—**

3/8 x 2 1/4 First Grade.....\$390.00  
 3/8 x 2 1/4 2nd Grade.....365.00  
 3/8 x 2 1/4 2nd & Btr. Grade.....375.00  
 3/8 x 2 1/4 3rd Grade.....240.00  
 3/8 x 3/4 2nd & Btr. Jtd. EM.....380.00  
 3/8 x 3/2 2nd & Btr. Jtd. EM.....390.00  
 33/32 x 2 1/4 First Grade.....400.00  
 33/32 x 2 1/4 2nd Grade.....400.00  
 33/32 x 2 1/4 3rd Grade.....320.00  
 Floor Layer Wage \$2.60 hr.

**GLASS—**

Single Strength Window Glass.....\$.30 per sq. ft.  
 Double Strength Window Glass......45 per sq. ft.  
 Plate Glass, 1/4 polished to 75.....1.60 per sq. ft.  
 75 to 100.....1.74 per sq. ft.  
 1/4 in. Polished Wire Plate Glass.....2.50 per sq. ft.  
 1/4 in. Rgh. Wire Glass......80 per sq. ft.  
 1/8 in. Obscure Glass......44 per sq. ft.  
 3/8 in. Obscure Glass......63 per sq. ft.  
 1/8 in. Heat Absorbing Obscure......54 per sq. ft.  
 3/8 in. Heat Absorbing Wire......72 per sq. ft.  
 1/8 in. Ribbed......44 per sq. ft.  
 3/8 in. Ribbed......63 per sq. ft.  
 1/8 in. Rough......44 per sq. ft.  
 3/8 in. Rough......63 per sq. ft.  
 Glazing of above additional \$.15 to  
 Glass Blocks, set in place.....3.50 per sq. ft.

**HEATING—**

**Furnaces—Gas Fired**  
 Floor Furnace, 25,000 BTU.....\$ 70.50  
 35,000 BTU.....77.00  
 45,000 BTU.....90.50  
 Automatic Control, Add.....39.00  
 Dual Wall Furnaces, 25,000 BTU.....91.50  
 35,000 BTU.....99.00  
 45,000 BTU.....117.00  
 With Automatic Control, Add.....39.00  
 Unit Heaters, 50,000 BTU.....202.00  
 Gravity Furnace, 65,000 BTU.....198.00  
 Forced Air Furnace, 75,000 BTU.....313.50  
**Water Heaters—5-year guarantee**  
 With Thermostat Control,  
 20 gal. capacity.....87.50  
 30 gal. capacity.....103.95  
 40 gal. capacity.....120.00

**INSULATION AND WALLBOARD—**

Rockwool Insulation—	
(2") Less than 1,000 sq. ft.	\$64.00
(2") Over 1,000 sq. ft.	59.00
Cotton Insulation—Full thickness	
(3/8")	\$95.50 per M sq. ft.
Sisalation Aluminum Insulation—Aluminum coated on both sides	\$23.50 per M sq. ft.
Tileboard—4'x6' panel	\$9.00 per panel
Wallboard—1/2" thickness	\$55.00 per M sq. ft.
Finished Plank	69.00 per M sq. ft.
Ceiling Tileboard	69.00 per M sq. ft.

**IRON—**Cost of ornamental iron, cast iron etc., depends on designs.

**LUMBER—**

S4S No. 2 and better common  
O.P. or D.F., per M. f.b.m. \$100.00  
Rough, No. 2 common O.P. or  
D.F., per M. f.b.m. 95.00

**Flooring—** Per M Delvd.

V.G.-D.F. B & Str. 1 x 4 T & G Flooring \$225.00  
"C" and better—all 225.00  
"D" and better—all 225.00  
Rwd. Rustic—"A" grade, medium dry, 185.00  
8 to 24 ft.

**Plywood, per M sq. ft.**

1/4-inch, 4:0x8-0-515 \$135.00  
1/2-inch, 4:0x8-0-515 219.00  
3/4-inch, per M sq. ft. 292.00  
Plyscord 11 1/2c per ft.  
Phyform 25c per ft.

**Shingles (Rwd. not available)—**

Red Cedar No. 1—\$9.50 per square; No. 2, \$7.00; No. 3, \$5.00.

Average cost to lay shingles, \$6.00 per square.  
Cedar Shakes—1/2" to 3/4" x 24/26 in handsplit tapered or split resawn, per square \$15.25  
3/4" to 1 1/4" x 24/26 in split resawn, per square 17.00

Average cost to lay shakes, \$8.00 per square.  
**Pressure Treated Lumber—**  
Wormkilled—Add \$35 per M to above  
Crescoted, 8-lb. treatment—Add \$45 per M to above

**MARBLE—**(See Dealers)

**METAL LATH EXPANDED—**  
Standard Diamond, 3-40, Copper Bearing, LCL, per 100 sq. yds. \$43.50  
Standard Ribbed, ditto \$47.50

**MILLWORK—**Standard.  
D. F. \$150 per 1000, R. W. Rustic \$175 per 1000 (delivered).

Double hung box window frames, average with trim, \$12.50 and up, each.  
Complete door unit, \$15 to \$25.  
Screen doors, \$8.00 to \$12.00 each.  
Patent screen windows, \$1.25 a sq. ft.

Cases for kitchen pantries seven ft. high per lineal ft., upper \$9.00 to \$11.00; lower \$12.00 to \$13.00.  
Dining room cases, \$20 per lineal foot.  
Rough and finish about \$1.00 per sq. ft.  
Labor—Rough carpentry, warehouse heavy framing (average), \$75.00 per M.

For smaller work average, \$95.00 to \$100 per 1000.

**PAINTING—**

Two-coat work per yard 85c  
Three-coat work per yard \$1.10  
Cold water paint per yard 25c  
Whitewashing per yard 15c

**Lined Oil, Strictly Pure**

Raw	Boiled
Light iron drums	\$2.28
5 gal in cans	2.40
1 gallon cans	2.52
Quart cans	71
Pint cans	38
1/2 pint cans	24

**Turpentine**

Pure Gum	Spirits
Light iron drums	\$1.61
5 gal in cans	1.74
1 gal in cans	1.87
Quart cans	4
Pint cans	31
1/2-pint cans	24

**Wholesale**

Raw	Boiled
Light iron drums	\$2.28
5 gal in cans	2.40
1 gallon cans	2.52
Quart cans	71
Pint cans	38
1/2 pint cans	24

**Pure Gum**

Pure Gum	Spirits
Light iron drums	\$1.61
5 gal in cans	1.74
1 gal in cans	1.87
Quart cans	4
Pint cans	31
1/2-pint cans	24

**Wholesale**

Raw	Boiled
Light iron drums	\$2.28
5 gal in cans	2.40
1 gallon cans	2.52
Quart cans	71
Pint cans	38
1/2 pint cans	24

**Pure Gum**

Pure Gum	Spirits
Light iron drums	\$1.61
5 gal in cans	1.74
1 gal in cans	1.87
Quart cans	4
Pint cans	31
1/2-pint cans	24

**Wholesale**

Raw	Boiled
Light iron drums	\$2.28
5 gal in cans	2.40
1 gallon cans	2.52
Quart cans	71
Pint cans	38
1/2 pint cans	24

**Pure Gum**

Pure Gum	Spirits
Light iron drums	\$1.61
5 gal in cans	1.74
1 gal in cans	1.87
Quart cans	4
Pint cans	31
1/2-pint cans	24

**Wholesale**

Raw	Boiled
Light iron drums	\$2.28
5 gal in cans	2.40
1 gallon cans	2.52
Quart cans	71
Pint cans	38
1/2 pint cans	24

**Pure Gum**

Pure Gum	Spirits
Light iron drums	\$1.61
5 gal in cans	1.74
1 gal in cans	1.87
Quart cans	4
Pint cans	31
1/2-pint cans	24

**Wholesale**

Raw	Boiled
Light iron drums	\$2.28
5 gal in cans	2.40
1 gallon cans	2.52
Quart cans	71
Pint cans	38
1/2 pint cans	24

**Pure Gum**

Pure Gum	Spirits
Light iron drums	\$1.61
5 gal in cans	1.74
1 gal in cans	1.87
Quart cans	4
Pint cans	31
1/2-pint cans	24

**Wholesale**

Raw	Boiled
Light iron drums	\$2.28
5 gal in cans	2.40
1 gallon cans	2.52
Quart cans	71
Pint cans	38
1/2 pint cans	24

**Pure Gum**

Pure Gum	Spirits
Light iron drums	\$1.61
5 gal in cans	1.74
1 gal in cans	1.87
Quart cans	4
Pint cans	31
1/2-pint cans	24

**Pioneer White Lead in Oil Heavy Paste and All-Purpose (Soft-Paste)**

Net Weight Packages	List Price Per 100 lbs.	Price to Painters Per 100 lbs.
100-lb. kegs	\$28.35	\$27.50
50-lb. kegs	30.05	28.15
25-lb. kegs	30.35	28.45
5-lb. cans*	33.35	31.25
1-lb. cans*	36.00	33.75

\*Heavy Paste only.  
500 lbs. (one delivery) 3/4c per pound less than above.

**Pioneer Dry White Lead—Litharge—Dry Red Lead Red Lead in Oil**

Dry White Lead	Litharge	Dry Red Lead
Price to Painters—Price Per 100 Pounds		
100 lbs.	25.95	26.60
50 lbs.	27.20	27.85
25 lbs.	30.65	31.30

Pound cans, \$37 per lb.

**PATENT CHIMNEYS—**

6-inch	\$2.50 lineal foot
8-inch	3.00 lineal foot
10-inch	4.00 lineal foot
12-inch	5.00 lineal foot

**PLASTER—**  
Neat wall, per ton delivered in S. F. in paper bags, \$17.60.

**PLASTER (Interior)—**

3 Coats, metal lath and plaster..... Yard \$3.00  
Keene cement on metal lath..... 3.50  
Ceilings with 3/4 hot roll channels metal lath (lathed only)..... 4.00  
Ceilings with 3/4 hot roll channels metal lath plastered..... 3.50

Single partition 3/4 channel lath 1 side (lath only)..... 3.00  
Single partition 3/4 channel lath 2 inches thick plastered..... 8.00

4-inch double partition 3/4 channel lath 2 sides (lath only)..... 5.75  
4-inch double partition 3/4 channel lath 2 sides plastered..... 8.75

Thermax single partition; 1" channels; 2 1/4" overall partition width. Plastered both sides..... 7.50  
Thermax double partition; 1" channels; 4 1/2" overall partition width. Plastered both sides..... 11.00

3 Coats over 1" Thermax nailed to one side wood studs or joists..... 4.50  
3 Coats over 1" Thermax suspended to one side wood studs with spring sound isolation clip..... 5.00

Note—Channel lath controlled by limitation orders.

**PLASTERING (Exterior)—**

2 coats cement finish, brick or concrete..... Yard \$2.50  
3 coats cement finish, No. 18 gauge wire mesh..... 3.50  
Lime—\$4.00 per bbl. at yard.  
Processed Lime—\$4.15 per bbl. at yard.  
Rock or Grip Lath—3/4"—65c per sq. yd.  
1/2"—29c per sq. yd.  
Composition Stucco—\$4.00 sq. yd. (applied).

**PLUMBING—**

From \$200.00 per fixture up, according to grade, quality and runs.

**ROOFING—**

"Standard" tar and gravel, 4 py per sq. for 30 sqs. or over. \$13.00  
Less than 30 sqs. \$16.00 per sq.  
Tile \$40.00 to \$50.00 per square

No. 1 Redwood Shingles in place, 4/2 in exposure, per square \$18.25  
5/2 No. 1 Cedar Shingles, 5 in exposure per square 14.50

5/8 x 16" No. 1 Little Giant Cedar Shingles, 5" exposure, per square 18.25  
4/2 No. 1 Cedar Shingles, 5 in exposure per square 14.50

Resealant with Gravel \$5.50 per sq.

Asbestos Shingles, \$27 to \$35 per sq. laid.  
1/2 to 3/4 x 25" Resawn Cedar Shakes, 10" Exposure \$30.00

3/4 to 1 1/4 x 25" Resawn Cedar Shakes, 10" Exposure \$35.00

1 x 25" Resawn Cedar Shakes, 10" Exposure \$22.00

Above prices are for shakes in place.

**SEWER PIPE—**

C.I. 6-in. to 24-in. B. & S. Class B and heavier, per top..... \$99.50

Vitrified, per foot: L.C.L. F.O.B. Warehouse, San Francisco.  
Standard, 8-in. \$6.66  
Standard, 12 in. 1.30  
Standard, 24-in. 5.41

Clay Drain Pipe, per 1,000 L.F. L.C.L., F.O.B. Warehouse, San Francisco:  
Standard, 6-in. per M. \$240.00  
Standard, 8-in. per M. 400.00

**SHEET METAL—**

Windows—Metal, \$2.50 a sq. ft.  
Fire doors (average), including hardware \$2.80 per sq. ft., size 12'x12'. \$3.75 per sq. ft., size 3'x6'.

**SKYLIGHTS—**(not glazed)

Galvanized iron, per sq. ft. \$1.25  
Vented hgt skylights, per sq. ft. 2.25  
Aluminum, puttlyless, (unglazed), per sq. ft. 1.25  
(installed and glazed), per sq. ft. 1.85

**STEEL—STRUCTURAL—**

\$290 per ton erected, when out of mill.  
\$350 per ton erected, when out of stock.

**STEEL REINFORCING—**

\$200.00 per ton, in place.  
1/2 in. Rd. (Less than 1 ton) per 100 lbs. \$8.90  
3/4 in. Rd. (Less than 1 ton) per 100 lbs. 7.80  
1/2 in. Rd. (Less than 1 ton) per 100 lbs. 7.50  
3/4 in. Rd. (Less than 1 ton) per 100 lbs. 7.25  
1/2 in. & 3/8 in. Rd. (Less than 1 ton) per 100 lbs. 7.10  
1 in. & 1 1/2 in. (Less than 1 ton) per 100 lbs. 7.10  
1 ton to 5 tons, deduct 25c.

**STORE FRONTS—**

Individual estimates recommended. See ESTIMATORS DIRECTORY for Architectural Veneer (3), and Mosaic Tile (35).

**TILE—**

Ceramic Tile Floors—Commercial \$1.20 to \$1.60 per sq. ft.  
Cove Base—\$1.40 per lin. ft.  
Quarry Tile Floors, 6x6" with 6" base @ \$1.35 per sq. ft.  
Tile Wainscots & Floors Residential, 4 1/4 x 4 1/4" @ \$1.65 to \$2.00 per sq. ft.  
Tile Wainscots, Commercial Jobs, 4 1/4 x 4 1/4" Tile, @ \$1.50 to \$1.65 per sq. ft.  
Asphalt Tile Floor 1/2" x 3/4" @ \$.18 to \$.35 sq. yd.  
Light shades slightly higher.  
Cork Tile—\$.70 per sq. ft.  
Mosaic Floors—See dealers  
Linguleum tile per sq. ft. \$5  
Rubber tile, per sq. ft. \$5 to \$7.50

**Furring Tile**

Scored	F.O.B. S. F.
2 x 12, each	\$17

Kraftite: Per square foot	Small	Large
Patm Tile—Niles Red	Lois	Lois
12 x 12 x 3/4 inch, plain	40	\$36
6 x 12 x 3/4 inch, plain	44	39
6 x 6 x 3/4 inch plain	46	42

**Building Tile—**  
8 1/2 x 12 inches, per M \$139.50  
6 5/8 x 12 inches, per M 100.00  
4 5/8 x 12 inches, per M 84.00

**Hollow Tile—**  
12 x 12 inches, per M \$46.75  
12 x 24 inches, per M 156.05  
12 x 24 inches, per M 177.10  
12 x 24 inches, per M 235.30  
F.O.B. Plant

**VENETIAN BLINDS—**

75c per square foot and up installed in extra

**WINDOWS—STEEL—INDUSTRIAL—**

Cost depends on size and type required.



# ARCHITECT AND ENGINEER ESTIMATOR'S DIRECTORY

## Building and Construction Materials

**EXPLANATION**—Building and construction materials are shown in major classified groups for general identification purposes with names and addresses of suppliers of materials listed in detail under group classification where name first appears—main offices are shown first with branch or district offices following. The numeral appearing in listings \*(3) refers to the major group classification where complete data on the dealer, or representative, may be found.

### ADHESIVES (1)

Wall and Floor Tile Adhesives  
THE CAMBRIDGE TILE MFG. CO. \*(35)

### AIR CONDITIONING (2)

Air Conditioning & Cooling  
UTILITY APPLIANCE CORP.  
Los Angeles 58: 4851 S. Alameda St.  
San Francisco: 1355 Market St., UN 1-4908

### ARCHITECTURAL PORCELAIN ENAMEL (2a)

CALIFORNIA METAL ENAMELING CO.  
Los Angeles: 6904 E. Slauson, UN D1268  
San Francisco: O'Keefe's, 55-11th St., UN 3-4445  
Portland: Beaver Sheet Metal & Roofing Co.,  
924 N. Russell St., TR 6766  
Seattle: Teclar Aluminum Co.,  
625 Yale Ave N., SE 8494  
Salt Lake City: S. A. Roberts & Co.,  
109 W. 2nd South, Salt Lake 4-4431  
Phoenix: Baker-Thomas Co.,  
300 S. 12th, Phoenix 4-5503  
Tucson: Laing-Garrett Co.,  
19 S. Tyndall Ave., TU 2-2893  
Albuquerque: Welch-Irwin Corp., 1726 Lomas Blvd. NE.

### ARCHITECTURAL VENEER (3)

Ceramic Veneer  
GLADDING, McBEAN & CO.  
San Francisco: Harrison at 9th St., UN 1-7400  
Los Angeles: 2901 Los Feliz Blvd., DL 2121  
Portland: 110 S.E. Main St., EA 6179  
Seattle: 1500 First Ave. S., EL 4711  
Spokane: 1102 N. Monroe St., BR 3259  
THE CAMBRIDGE TILE MFG. CO. \*(35)  
Porcelain Veneer  
PORCELAIN ENAMEL PUBLICITY BUREAU  
Oakland 12: Room 601 Franklin Building  
Pasadena 8: P. O. Box 186. East Pasadena Station  
Granite Veneer  
VERMONT MARBLE COMPANY  
San Francisco 5: 525 Market St., SU 1-6747  
Los Angeles: 3522 Council St., DU 2-7834  
Marble Veneer  
VERMONT MARBLE COMPANY  
San Francisco 5: 525 Market St., SU 1-6747  
Los Angeles: 3522 Council St., DU 2-7834

### BANKS - FINANCING (4)

CROCKER FIRST NATIONAL BANK OF S. F.  
San Francisco, Post & Montgomery Sts., EX 2-7700

### BATHROOM FIXTURES (5)

Metal  
THE CAMBRIDGE TILE MFG. CO. \*(35)  
Ceramic  
THE CAMBRIDGE TILE MFG. CO. \*(35)

### BRASS PRODUCTS (6)

GREENBERG'S, M. & SONS  
San Francisco 7: 765 Folsom, EX 2-3143  
Los Angeles 23: 1258 S. Boyle, AN 3-7108  
Seattle 4: 1016 First Ave. So., MA 5140  
Phoenix: 3009 N. 19th Ave., Apt. 92, PH 2-7663  
Portland 4: 510 Builders Exch. Bldg., AT 6443

### BRICKWORK (7)

Face Brick  
GLADDING, McBEAN & CO. \*(3)

KRAFTILE \*(35)  
REMILLARD-DANDINI CO.  
San Francisco 4: 400 Montgomery St., EX 2-4988

### BRONZE PRODUCTS (8)

GREENBERG'S, M. & SONS \*(16)

### BUILDING PAPERS & FELTS (9)

ANGIER PACIFIC CORP.  
San Francisco 5: 55 New Montgomery St., DD 2-4416  
Los Angeles: 7424 Sunset Blvd.  
PACIFIC COAST AGGREGATES, INC. \*(11)  
SISALKRAFT COMPANY  
San Francisco 5: 55 New Montgomery St., EX 2-3066  
Chicago, Ill.: 205 West Wacker Drive

### BUILDING HARDWARE (9a)

THE STANLEY WORKS  
San Francisco: Menadnock Bldg., YU 6-5914  
New Britain, Conn.

### CABINETS & FIXTURES (9b)

FINK & SCHINDLER, THE; CO.  
San Francisco: 522 Brannan St., EX 2-1513

### CEMENT (10)

IDEAL CEMENT COMPANY (Pacific Division)  
San Francisco 4: 310 Sansome St., GA 1-4100  
PACIFIC COAST AGGREGATES, INC. \*(11)

### CONCRETE AGGREGATES (11)

Ready Mixed Concrete  
PACIFIC COAST AGGREGATES, INC.  
San Francisco: 400 Alabama St., KL 2-1616  
Sacramento: 16th and A Sts., GI 3-6586  
San Jose: 790 Stockton Ave., CY 2-5620  
Oakland: 2400 Peralla St., GL 1-0177  
Stockton: 820 So. California St., ST 8-8643  
Lightweight Aggregates  
AMERICAN PERLITE CORP.  
Richmond: 26th & 8. St. - Yd. 2, RI 4307

### DOORS (12)

Hollywood Doors  
WEST COAST SCREEN CO.  
Los Angeles: 1127 E. 63rd St., AD 1-1108  
W. P. FULLER CO.  
Seattle, Tacoma, Portland  
NICOLAI DOOR SALES CO.  
San Francisco: 3045 19th St.  
F. M. COBB CO.  
Los Angeles & San Diego  
SOUTHWESTERN SASH & DOOR  
Phoenix, Tucson, Arizona  
El Paso, Texas  
HOUSTON SASH & DOOR  
Houston, Texas  
Screen Doors  
WEST COAST SCREEN DOOR CO.  
(See above)

### FIRE ESCAPES (13)

MICHEL & PFEFFER IRON WORKS, INC.  
South Linden & Tanforan Ave.  
South San Francisco: JU 4-8362

### FIREPLACES (14)

Heat Circulating  
SUPERIOR FIREPLACE CO.  
Los Angeles: 1708 E. 15th St., PR 8393  
Baltimore, Md.: 601 No. Point Rd.

### FLOORS (15)

Hardwood Flooring  
HOGAN LUMBER COMPANY  
Oakland: Second and Alice Sts., GL 1-6861  
Floor Tile  
GLADDING, McBEAN & CO. \*(3)  
KRAFTILE \*(35)  
Floor Tile (Ceramic Mosaic)  
THE CAMBRIDGE TILE MFG. CO. \*(35)  
Floor Treatment & Maintenance  
HILLYARD SALES CO. (Western)  
San Francisco: 470 Alabama St., MA 1-7766  
Los Angeles: 923 E. 3rd, TR 8282  
Seattle: 3440 E. Marginal Way  
Diversified (Magnesite, Asphalt Tile, Composition, Etc.)  
LE ROY OLSON CO.  
San Francisco 10: 3070 - 17th St., HE 1-0188  
Sleepers (composition)  
LE ROY OLSON CO.

### GLASS (16)

W. P. FULLER COMPANY  
San Francisco: 301 Mission St., EX 2-7151  
Los Angeles, Calif.  
Portland, Ore.

### HEATING (17)

S. T. JOHNSON CO.  
Oakland 8: 940 Arlington Ave., DL 2-6000  
San Francisco: 505 Potrero Ave., MA 1-2757  
Philadelphia 8, Pa.: 401 N. Broad St.  
SCOTT COMPANY  
San Francisco: 243 Minne St., YU 2-0400  
Oakland: 113 - 10th St., GL 1-1937  
San Jose, Calif.  
Los Angeles, Calif.  
UTILITY APPLIANCE CORP. \*(12)  
Electric Heaters  
WESTIX ELECTRIC HEATER CO.  
San Francisco 5: 390 First St., GA 1-2211  
Los Angeles: 520 W. 7th St., MI 8096  
Portland: Terminal Sales Bldg., BE 2050  
Seattle: Securities Bldg., SE 5028  
Designer of Heating  
THOMAS B. HUNTER  
San Francisco 4: 41 Sutter St., GA 1-1164

### INSULATION AND WALL BOARD (18)

LUMBER MANUFACTURING CO.  
San Francisco: 225 Industrial Ave., JU 7-1760  
PACIFIC COAST AGGREGATES, INC. \*(11)  
SISALKRAFT COMPANY \*(9)  
WESTERN ASBESTOS COMPANY  
San Francisco: 675 Townsend St., KL 2-3068  
Oakland: 251 Fifth Avenue, GL 1-2345  
Stockton: 733 S. Van Buren, ST 4-9421  
Sacramento 1331 - T St., HU 1-0125  
Fresno: 434 - P St., FR 2-1600

### IRON—Ornamental (10)

MICHEL & PFEFFER IRON WORKS, INC. \*(13)

### LANDSCAPING (20)

Landscape Contractors  
HENRY C. SOTO CORP.  
Los Angeles: 13,000 S. Avalon Blvd., ME 4-6617

### LIGHTING FIXTURES (21)

SMOOT-HOLMAN COMPANY  
Inglewood, Calif., OR 8-1217  
San Francisco: 55 Mississippi St., MA 1-8474

**LUMBER (22)**

Shingles  
LUMBER MANUFACTURING CO. \*(18)

**MARBLE (23)**

VERMONT MARBLE COMPANY  
San Francisco 5: 525 Market St., SU 1-6747  
Los Angeles 4: 3522 Council St., DU 2-7834

**METAL LATH EXPANDED (24)**

PACIFIC COAST AGGREGATES, INC. \*(11)

**MILLWORK (25)**

FINK & SCHINDLER, THE, CO. \*(9b)  
LUMBER MANUFACTURING COMPANY \*(18)  
MULLER MANUFACTURING COMPANY  
San Francisco: 60-80 Rausch St., UN 1-5815  
PACIFIC MANUFACTURING COMPANY  
San Francisco: 76 Beale St., GA 1-7755  
Santa Clara: 2610 The Alameda, SC 607  
Los Angeles, 6820 McKinley Ave., TH 4196

**PAINTING (26)**

Paint  
W. P. FULLER COMPANY \*(16)

**PLASTER (27)**

Interiors - Metal Lath & Trim  
PACIFIC COAST AGGREGATES, INC. \*(11)  
Exteriors  
PACIFIC PORTLAND CEMENT COMPANY \*(28)

**PLASTIC CEMENT (28)**

IDEAL CEMENT COMPANY  
San Francisco: 310 Sansome St., GA 1-4100

**PLUMBING (29)**

THE HALSEY TAYLOR COMPANY  
Redlands, Calif.  
Warren, Ohio  
THE SCOTT COMPANY \*(17)  
HANS DRINKING FAUCET COMPANY  
Berkeley 10: 1435 Fourth St., LA 5-3341  
CONTINENTAL WATER HEATER COMPANY  
Los Angeles 31: 1801 Pasadena Ave., CA 6178  
SIMONDS MACHINERY COMPANY  
San Francisco: 816 Folsom St., DU 2-6794  
Los Angeles: 455 East 4th St., MU 8322  
SECURITY VALVE COMPANY  
Los Angeles 31: 410 San Fernando Rd., CA 6191

**RESILIENT TILE (30)**

LE ROY OLSON CO. \*(15)

**SEWER PIPE (32)**

GLADDING, McBEAN & CO. \*(3)

**SHEET METAL (32)**

Windows  
DETROIT STEEL PRODUCTS COMPANY  
Oakland 8: 1310 - 63rd St., OL 2-8826  
San Francisco: Russ Building, DU 2-0890  
MICHEL & PFEFFER IRON WORKS, INC. \*(13)  
PACIFIC COAST AGGREGATES, INC. \*(11)  
Fire Doors  
DETROIT STEEL PRODUCTS COMPANY  
Skylights  
DETROIT STEEL PRODUCTS COMPANY

**STEEL—STRUCTURAL (33)**

COLUMBIA STEEL CO.  
San Francisco: Russ Bldg., SU 1-2500  
Los Angeles: 2087 E. Slauson, LA 1711  
Portland: 2345 N. W. Nicolai, BE 7261  
Seattle 1331 3rd Ave. Bldg., MA 1972  
Salt Lake City: Walker Bank Bldg., SL 3-6733  
HERRICK IRON WORKS  
Oakland: 18th & Campbell Sts., GL 1-1767  
JUDSON PACIFIC-MURPHY CORP.  
Emeryville: 4300 Eastshore Highway, OL 3-1717  
REPUBLIC STEEL CORP.  
San Francisco: 116 N. Montgomery St., GA 1-0977  
Los Angeles: Edison Building  
Seattle: White-Henry-Stuart Building  
Salt Lake City: Walker Bank Building  
Denver: Continental Oil Building  
SAN JOSE STEEL COMPANY  
San Jose 195 North Thirtieth St., CO 4184

**STEEL—REINFORCING (34)**

REPUBLIC STEEL CORP. \*(33)  
HERRICK IRON WORKS \*(33)  
SAN JOSE STEEL CO. \*(33)  
COLUMBIA STEEL CO. \*(33)

**CLAY TILE (35)**

THE CAMBRIDGE TILE MFG. CO.  
San Francisco 10: 470 Alabama St., CA 3-1666  
Los Angeles 19: 1335 S. La Brea, WE 3-7800  
GLADDING, McMEAN & CO. \*(3)  
KRAFTILE  
Niles, Calif.: Niles 3611  
San Francisco 5: 50 Hawthorne St., DU 2-3780  
Los Angeles 13: 406 South Main St., MU 7241

**TIMBER—REINFORCING (36)**

Trusses  
WYERHAUSER SALES CO.  
Tacoma, Wash.  
St. Paul, Minn.  
Newark, N. J.

**Treated Timber**

J. H. BAXTER CO.  
San Francisco 4: 333 Montgomery St., DU 2-3883  
Los Angeles 13: 601 West Fifth St., MI 6294

**WALL TILE (37)**

THE CAMBRIDGE TILE MFG. CO. \*(35)  
GLADDING, McBEAN & CO. \*(3)  
KRAFTILE COMPANY \*(35)

**WINDOWS STEEL (38)**

DETROIT STEEL PRODUCTS CO. \*(32)  
MICHEL & PFEFFER IRON WORKS, INC. \*(13)  
PACIFIC COAST AGGREGATES, INC. \*(11)

**GENERAL CONTRACTORS (39)**

BARRETT & HILP  
San Francisco: 918 Harrison St., DU 2-0700  
Los Angeles: 234 W. 37th Place, AD 3-8161  
DINWIDDIE CONSTRUCTION COMPANY  
San Francisco: Crocker Building, YU 6-2718  
CLINTON CONSTRUCTION COMPANY  
San Francisco: 923 Folsom St., SU 1-3440  
MATCOCK CONSTRUCTION COMPANY  
San Francisco: 604 Mission St., GA 1-5516  
PARKER, STEFFENS & PEARCE  
San Francisco: 135 So. Park, EX 2-6639  
STOLTE, INC.  
Oakland: 8451 San Leandro Blvd., TR 2-1064  
SWINERTON & WALBERG COMPANY  
San Francisco: 225 Bush St., GA 1-2980  
Oakland: 1723 Webster St., HI 4-4322  
Los Angeles, Sacramento, Denver  
P. J. WALKER COMPANY  
San Francisco: 391 Sutter St., YU 6-5916  
Los Angeles: 714 W. Olympic Blvd., RI 7-5521

**TESTING LABORATORIES**

(ENGINEERS & CHEMISTS (40))  
ABBOT A. HANKS, INC.  
San Francisco: 624 Sacramento St., GA 1-1697  
ROBERT W. HUNT COMPANY  
San Francisco: 251 Kearny St., EX 2-4634  
Los Angeles: 3050 E. Slauson, JE 9131  
Chicago, New York, Pittsburgh  
PITTSBURGH TESTING LABORATORY  
San Francisco: 651 Howard St., EX 2-1747

## CONSTRUCTION CONTRACTS AWARDED AND MISCELLANEOUS PERSONNEL DATA

**WATER SUPPLY STORAGE**, McClellan Air Force Base, Sacramento county. Corps of U.S. Engineers, Sacramento owner. Modification of water supply storage facilities. GENERAL CONTRACTOR: Stetle, Inc., Oakland. \$225,683.

**ELEMENTARY SCHOOL**, Vallejo, Solano county. Vallejo Unified School District. Vallejo, owner. 22-classrooms, administration, kindergarten, kitchen, toilets, frame and stucco construction. \$11,674. ARCHITECT: Masten & Hurd San Francisco. GENERAL CONTRACTOR: J. A. Bryant Vallejo.  
**CHURCH & SUNDAY SCHOOL**, Bakersfield, Kern county. First Congregational Church, Bakersfield, owner. Church and Sunday School. Social Hall, kitchen in main building. laminated arch roof trusses and roof.

concrete floors, radiant heating, \$200,000. ARCHITECT: Whitney Biggar, Bakersfield. GENERAL CONTRACTOR: Wm. McKenney, Bakersfield.

**FACTORY BLDG.**, San Francisco, Kortick Mfg. Co., San Francisco, owner. 1-story reinforced concrete tilt-up, wood roof trusses, 57,000 sq. ft., \$160,000. ENGINEER: Simpson & Strain, San Francisco. GENERAL CONTRACTOR: Johnson & Mapes, Menlo Park.

**RECTORY BLDG.**, North Hollywood, Los Angeles county. All Angels Church, North Hollywood, owner. Frame and stucco, composition roofing, brick work, oak and slab floor, steel sash, forced air heating, ceramic tile work in baths, sheet metal and elec-

trical work, 3000 sq. ft. floor area, \$39,700. ARCHITECT: Ralph C. Flewelling & Walter L. Moody, Los Angeles. GENERAL CONTRACTOR: Fred S. Macomber, Los Angeles.  
**SHOPPING CENTER**, Modesto, Stanislaus county. Roosevelt Shopping Center, Modesto, owner. 1-story frame and stucco building, 83x105 ft., 5 stores, \$81,000. ARCHITECT: John W. Bomberger, Modesto. GENERAL CONTRACTOR: Walter Spoon, Modesto.  
**DEFENSE HOUSING**, Herlong, California. Builders Corp. of America, Beverly Hills, owner. Concrete block, composition shingle roof, concrete slab floors, drywall interiors, aluminum sash, forced air heating and electrical heaters, 271 Units. ARCHITECT: W. Harry Hillier, Beverly Hills.  
**MANUFACTURING BLDG.**, Los Angeles. California Ink Co., San Francisco, owner. Reinforced brick, ink manufacturing building, composition roofing, concrete slab floors, eight skylights, wire fencing, asphalt paving, tanks, steam boiler, metal covered floors, steel sash, monorail, tapered steel ventilators, evaporation coolers, pumps.

automatic sprinkler system, 40x140 ft. ARCHITECT: Erwood P. Eiden, Glendale. GENERAL CONTRACTOR: T & S Construction Engineers, Los Angeles.

**PAROCHIAL SCHOOL**, Long Beach, Los Angeles county, Southern California Association of Seventh Day Adventists, Long Beach, owner, 1-story frame and stucco, 6-classrooms and auditorium, also 1-story lunchroom-assembly, kitchen, shop and library, composition and gravel roof, steel sash, concrete slab floors with asphalt tile covering, forced air heating, ceramic tile toilet rooms, 15,774 sq. ft., \$137,613. ARCHITECT: Thomas J. Russell, Long Beach. GENERAL CONTRACTOR: Percy Moody, Long Beach.

**ELEMENTARY SCHOOL**, West Pittsburg, Contra Costa county, Mt. Diablo Unified School District, Concord, owner. Frame and stucco, 11-classrooms, administration, kindergarten, multi-purpose, kitchen and toilets, \$356,907. ARCHITECT: Anderson & Simonds, Reynolds & Chamberlain, Confer & Willis and John Lyon Reid, Oakland. GENERAL CONTRACTOR: Ideaco, Oakland.

**MUSIC, ART, BLDG.**, Fresno, State of Cali-

ornia, owner, 2-reinforced concrete buildings at the Fresno State College. Concrete floor, steel sash, aluminum doors, structural steel roof, frame and concrete roof slab, platform elevator, exhaust system, \$787,000. ARCHITECT: State of California. GENERAL CONTRACTOR: Carl N. Swenson Co., San Jose.

**SECURITY FENCE LIGHTING**, Deuel Vocational Institution, Tracy, San Joaquin county, owner. Installation of lighting system, including standards, lamps, conduits, transformers, controls, \$23,944. ARCHITECT: State of California, Sacramento. GENERAL CONTRACTOR: Sacramento Electric Works, Sacramento.

**SURGICAL SUITE REMODEL, CITY AND COUNTY HOSPITAL, San Francisco**. City and County of San Francisco, owners. Part 2 of project to remodel the surgical suite at the County Hospital, \$98,945. ARCHITECT: Dodge A. Riedy (City Architect), San Francisco. GENERAL CONTRACTOR: Hart & Hynding, San Francisco.

**BATHHOUSE**, Ambrose Memorial Park, Pittsburg, Contra Costa county. Ambrose

Parkway and Recreation District, Pittsburg, owner. 1-story concrete block, and frame construction, \$27,578. ARCHITECT: A. P. Anderson, Jr., Oakland. GENERAL CONTRACTOR: Sal N. Siano, Pittsburg.

**CADET CLUB**, Clovis, New Mexico. Albuquerque District, Corps of Engineers, U.S. Army, owner. Cadet Club building at the Clovis Air Force Base, 7500 sq. ft., semi-permanent type building, \$87,005. GENERAL CONTRACTOR: Plains Construction Co., Clovis, New Mexico.

**APARTMENT BUILDING**, Pasadena, Los Angeles county, Chris Mowry, South Pasadena, owner, 2-story, 4-unit, 24-room, frame and stucco apartment, 6400 sq. ft., gravel roof, metal sash, oak and linoleum covered floors, brick fireplaces, unit heating, 2-baths per unit, tub and stall showers, electric bathroom heaters, tile top pullmans and drainboards, attached 8-car garage. Provision for adding 12 units later. ARCHITECT: Langdon & Wilson, Los Angeles. GENERAL CONTRACTOR: Chris Mowry, South Pasadena.

**BANK & OFFICE BLDG.**, Merced, Merced

## BUILDING TRADES WAGE (JOB SITES) NORTHERN, CENTRAL AND SOUTHERN CALIFORNIA

ATTENTION: The following are the PREVALING hourly rates of compensation being paid and in effect by employers by agreement between employees and their union; or as recognized and determined by the U. S. Department of Labor. [September 1, 1952.]

CRAFT	San Francisco	Alameda	Contra Costa	Fresno	Sacramento	San Joaquin	Santa Clara	Solano	Los Angeles	San Bernardino	San Diego	Santa Barbara	Kern
ASBESTOS WORKERS	\$2.585	\$2.585	\$2.585	\$2.585	\$2.585	\$2.585	\$2.585	\$2.585	\$2.25	\$2.25	\$2.25	\$2.25	\$2.25
BOILERMAKERS	2.68	2.68	2.68	2.68	2.68	2.68	2.68	2.68	2.175	2.175	2.175	2.175	2.175
BRICKLAYERS	3.25	3.25	3.25	3.00	3.25	3.00	3.45	3.25	2.45	2.45	2.45	2.45	2.45
BRICKLAYERS, HODCARRIERS	2.45	2.45	2.45	2.00	2.40	2.25	2.45	2.45	1.94	1.94	1.94	1.94	1.94
CARPENTERS	2.60	2.60	2.64	2.54	2.54	2.54	2.54	2.54	2.57	2.57	2.57	2.57	2.57
CEMENT FINISHERS	2.57	2.57	2.57	2.57	2.57	2.57	2.57	2.57	2.57	2.57	2.57	2.57	2.57
CONCRETE MIXER—Skip Type (1-1/2)	2.28	2.28	2.28	2.28	2.28	2.28	2.28	2.28	2.38	2.38	2.38	2.38	2.38
ELECTRICIANS	3.00	3.00	3.00	3.00	3.00	2.75	3.00	2.50	2.25	2.25	2.25	2.25	2.25
ELEVATOR CONSTRUCTORS	2.75	2.70	2.45	2.75	2.915	2.915	2.915	2.915	2.25	2.25	2.25	2.25	2.25
ENGINEERS: MATERIAL HOIST	2.56	2.56	2.56	2.56	2.56	2.56	2.56	2.56	1.9875	1.9875	1.9875	1.9875	1.9875
GLAZIERS	2.30	2.30	2.30	2.30	2.25	2.30	2.30	2.50	2.26	2.26	2.26	2.26	2.26
IRONWORKERS: ORNAMENTAL REINF. STREET	2.70	2.70	2.70	2.70	2.70	2.70	2.70	2.70	2.70	2.70	2.70	2.70	2.70
STRUCTURAL STEEL	*2.60	2.60	2.60	2.60	2.60	2.60	2.60	2.60	2.61	2.61	2.61	2.61	2.61
LABORERS: BUILDING CONCRETE	*2.85	2.85	2.85	2.85	2.85	2.85	2.85	2.85	2.85	2.85	2.85	2.85	2.85
LATHERS	1.85	1.85	1.85	1.85	1.85	1.85	1.85	1.85	1.85	1.94	1.94	1.94	1.94
MARBLE SETTERS	3.25	3.50	3.50	3.00	3.00	3.00	3.4375	3.00	3.125	3.125	3.125	3.125	3.125
MOSAIC & TERRAZZO	2.70	2.70	2.70	2.70	2.70	2.70	2.70	2.70	2.25	2.25	2.25	2.25	2.25
PAINTERS—BRUSH	2.74	2.74	2.74	2.74	2.74	2.74	2.74	2.74	2.40	2.40	2.40	2.40	2.40
PAINTER—SPRAY	**2.60	2.60	2.60	2.60	2.625	2.45	2.45	2.27	2.56	2.50	2.53	2.22	2.22
PILEDRIVERS—OPERATOR	2.75	2.75	2.75	2.75	2.75	2.75	2.75	2.75	2.74	2.70	2.70	2.70	2.70
PLASTERERS	3.125	3.165	3.125	3.125	3.00	3.00	3.125	3.00	3.125	3.125	3.125	3.125	3.125
PLASTERERS, HODCARRIERS	2.40				2.50	2.50	2.50	2.50	2.50	2.25	2.30	2.00	2.00
PLUMBERS—STEAM FITTERS	2.90	2.90	2.875	2.75	2.90	2.75	2.75	2.90	2.90	2.90	2.90	2.90	2.90
ROOFERS	2.50	2.50	2.50	2.25	2.50	2.50	2.50	2.50	2.65	2.00	1.90	2.00	2.00
SHEET METAL WORKERS	2.475	2.475	3.3125	2.43	2.75	2.50	2.40	2.15	2.475	2.475	2.175	2.00	2.00
SPRINKLER FITTERS	2.75	2.70	2.70	2.625	2.625	2.625	2.625	2.75	2.75	2.25	2.25	2.25	2.25
STEAMFITTERS	2.75	2.90	2.90	2.75	2.625	2.625	2.75	2.75	2.90	2.90	2.90	2.90	2.90
TRACTOR OPERATOR	2.67	2.67	2.67	2.67	2.67	2.67	2.67	2.67	2.62	2.52	2.52	2.52	2.52
TRUCK DRIVERS—1/2 Ton or less	1.89	1.89	1.89	1.89	1.89	1.89	1.89	1.89	2.02	2.02	2.02	2.02	2.02
TILESETTERS	2.955	2.955	2.955	2.955	2.955	2.955	2.955	2.955	2.65	2.65	2.65	2.65	2.65

\* 6 Hour Day. \*\* 7 Hour Day. \*\*\* Before C.I.S.C for 15c increase. Prepared and compiled by:

CENTRAL CALIFORNIA CHAPTER, ASSOCIATED GENERAL CONTRACTORS OF AMERICA, with the assistance and cooperation of secretaries of General Contractors Associations and Builders Exchanges of Northern California; and the above information for southern California is furnished by the Labor Relations Department of the Southern California Chapter, ASSOCIATED GENERAL CONTRACTORS OF AMERICA.

# CLASSIFIED ADVERTISING

RATE: 20c PER WORD . . . CASH WITH ORDER

MINIMUM \$5.00

**BUILDERS!** You can make more money; get information you need before it is published elsewhere: Subscribe to the daily ARCHITECTS REPORTS, only \$10.00 per month. Complete information from ARCHITECTS REPORTS, 68 Post Street, San Francisco. Phone DOuglas 2-8311.

**PHOTOGRAPHY.** For the best in construction photography, including exterior and interior, aerial, and progress views . . . you will find as many others have that it's the SKELTON STUDIOS, 875 O'Farrell St., San Francisco. Telephone R'ospect 6-1841.

**ARCHITECTURAL DRAFTSMAN WANTED;** Experienced in working drawings and details

for hospitals, schools, and commercial work. Excellent working conditions. Permanent position. W. D. Holdrege, P. O. Box 412, San Luis Obispo, Calif.

**Registered ARCHITECT,** residential and commercial, 17 years experience, seeks association with medium sized firm. Independent work, design, specifications, supervision, client contact. BOX J-3, Architect & Engineer, 68 Post Street, San Francisco, Calif.

**ARCHITECTURAL SLIDING SLEEL SASH.** One lot only — new, half price. 13 units, assorted sizes, 353 square feet total. 3 at 7 ft. x 5 ft.; 4 at 7 ft. x 4 1/2 ft.; 1 at 6 ft. x 4 1/2 ft.; 2 at 6 ft. x 4 ft.; 1 at 7 ft. x 3 1/2 ft.;

at 4 1/2 ft. x 3 ft.; 1 at 3 ft. x 3 ft. Phone DELaware 3-7378, San Francisco.

**YOUNG ARCHITECT** — Wanted with some evenings and weekends free during April to assist business couple building S. F. view home. Ideas are formulated, but need professional services at reasonable rate. Address replies to Suite 485, 703 Market St., S. F.

**MODERN FRESCO PAINTINGS ON SLABS** by SIMEON PELENC—Received A.I.A. and Government awards. Approximate size 3 x 4 ft. Suitable for exterior or interior decoration. HELEN PELENC, 1101 Francisco St. San Francisco.



county. Anglo-California National Bank, San Francisco, owner. 2-story, basement, reinforced concrete, steel sash, air conditioning, passenger elevator, 75x110 ft., \$357,744. ARCHITECT: Wm. Hastrup, Fresno. GENERAL CONTRACTOR: Stolte, Inc., Oakland.

**GARAGE BLDG.**, San Francisco. B. L. Nishkian, San Francisco, owner. 2-story Class 1-B, reinforced concrete, \$125,000. STRUCTURAL ENGINEER: B. L. Nishkian, San Francisco. GENERAL CONTRACTOR: MacDonald, Young & Nelson, San Francisco.

**DEPARTMENT STORE REMODEL**, Richmond, Contra Costa county. Macy's of San Francisco, owner. Two-story interior and exterior remodel, stucco and terra cotta, Marquee, fountain lunch counter, \$100,000. ARCHITECT: Ward & Bolles, San Francisco. GENERAL CONTRACTORS: Dinwiddie Construction Co., San Francisco.

**ELEMENTARY SCHOOL ADD'N.**, Hill View, Menlo Park, San Mateo county. Menlo Park Elementary School District, owner. Seven classrooms, music room, and toilet rooms; frame and stucco, \$148,372. ARCHITECT: A. D. Janssen, Menlo Park. GENERAL CONTRACTOR: Howard J. White, Inc., Palo Alto.

**SWIMMING POOL**, So. San Francisco, San Mateo county. South San Francisco Unified School District, South San Francisco, owner. "L" shaped pool of reinforced concrete to be built at the So. San Francisco High School, \$61,271. ARCHITECT: John Lyon Reid, San Francisco. GENERAL CONTRACTOR: Hart & Hynding, San Francisco.

**HOTEL ADDITION**, Casa Munras Hotel, Monterey county. Casa Munras Hotel, Monterey, owner. Recreation building of frame, and stucco; 12 deluxe hotel rooms and baths, stucco, \$108,750. ARCHITECT: Robt.

R. Jones, Carmel. GENGAL CONTRACTOR: Jake Huizenga, Seaside.

**SCHOOL BUILDING**, Santa Monica, Los Angeles county. Board of Education, Santa Monica, owner. Addition to the John Adams Junior High School, Santa Monica, frame and stucco construction; 8-classrooms, art-crafts building, electric shops building, and child care and home making building; composition roof, concrete slab and asphalt tile floors, acoustical tile walls and ceilings, ceramic tile walls in toilet rooms, steel sash, baseboard type radiant heating, \$230,794. ARCHITECT: Joe Estep, Santa Monica. GENERAL CONTRACTOR: Herbert Goldsworthy, Santa Monica.

**U.S. AIR FORCE**, Guam. U.S. Air Force, owner. Large project includes airfield improvements, utilities, roads, industrial buildings, warehouses, barracks, and officers quarters. ARCHITECTS: Skidmore, Owings & Merrill, San Francisco. GENERAL CONTRACTORS: Brown-Pacific-Maxon, San Francisco. Project estimate, \$40,000,000.

**DEFENSE HOUSING**, Flagstaff, Arizona. Public Housing Administration, San Francisco, owner. 100-dwelling units now at Upland, California, to be transported and reconditioned at the Navajo Ordnance Depot in Flagstaff, Arizona. Project includes site-constructed Central Laundry building, administration building, project construction office and site improvements, \$383,195. ARCHITECT: Lester H. Laraway, Phoenix. GENERAL CONTRACTOR: Claude T. Lindsay, San Francisco.

**5-APARTMENTS BUILDING**, Los Angeles. Substantial Homes, Los Angeles, owner. Two-story, 50-family, 170-rooms; 38-family, 120 rooms, and 8-family, 28-room, frame and stucco apartment building; composition roof, hardwood and linoleum floors, interior plaster, insulation, individual gas water heaters, dual and single gas wall heaters, tile baths and stall showers, glass enclosed bath tubs, electric bathroom heaters, automatic washers and dryers in laundry rooms; two swimming pools, concrete block walls, concrete paving, brick paver boxes, garbage disposal units, \$932,500. ARCHITECT: R. W. Wilson, Pasadena.

**STORE BUILDING**, Salinas, Monterey county. Farmers Mercantile Co., Salinas, owner. One-story reinforced tilt-up concrete, 100x180 ft. plus 60x60 ft. shop; wood roof, some structural steel beams, plate glass front, \$100,000. ARCHITECT: Butler, Holm & Waterman, Salinas. GENERAL CONTRACTOR: Johnson & Mapes, Menlo Park.

**OFFICE BUILDING**, Bell Gardens, Los Angeles county. National Automotive Fibers Co., Bell Gardens, owner. Frame and stucco; 6000 sq. ft. of floor covered with asphalt tile, acoustical ceiling, tile, steel sash, electrical work, forced air heating, paving. STRUCTURAL ENGINEER: M. J. Gabrielsen, Los Angeles. GENERAL CONTRACTOR: Dick Building Co., Los Angeles.

**APARTMENT BUILDING**, San Francisco. Jones Street Investment Co., San Francisco, owner. Nine story, 36-apartment, building; 3-floors of garages and 6-floors of apartments; reinforced concrete construction, \$550,000. ARCHITECT H. C. Brumann San Francisco. GENERAL CONTRACTOR, Theo. G. Meyer & Son, San Francisco.

**CHURCH BUILDING**, Reseda, Los Angeles county. Christ The King Lutheran Church, Reseda, owner. Frame and stucco Church building, administration office and chapel; composition roof, concrete slab with asphalt tile floors, insulation, metal tile, metal ventilator doors, pipe and metal toilet partitions, forced air

heating, loud speaker system, kitchen facilities and toilet rooms. ARCHITECT: Culver Heaton, Pasadena. GENERAL CONTRACTOR: Samuelson Bros., La Canada.

**WAREHOUSE**, Venice, Los Angeles county. Airport Building Development Corp., Los Angeles, owner. Tilt-up concrete warehouse 300x420 ft., composition roof, concrete slab floors, interior plaster work, ceramic tile in toilet rooms, galvanized iron gutters and downspouts, asphalt concrete paving, steel columns, sprinkler system, gas water heaters, corrugated aluminum sliding doors, tapered steel girders, \$450,000. ENGINEER: Geo. V. Novikoff, Los Angeles. GENERAL CONTRACTOR: Co-Ordinating Construction Co., Inc., Hawthorne.

**HIGH SCHOOL ADDITION**, Placerville. El Dorado county. El Dorado High School District, Placerville, owner. Light steel frame, wood and brick veneer exterior Agricultural and Shop Building, \$130,787. ARCHITECT: Gordon Stallord, Sacramento. GENERAL CONTRACTOR: G. S. Herrington, Auburn.

**AIR MAIL & CARGO BUILDING**, San Francisco Airport, San Mateo county. City and County of San Francisco, owner. One story structural steel frame, concrete ends, wood roof, porcelain enameled exterior walls, steel sash, \$439,100. ARCHITECT: Dodge Riedy, City Architect. GENERAL CONTRACTOR: Parker, Stiefens & Pearce, San Francisco.

**DRIVE-IN RESTAURANT**, Hayward, Alameda county. Burks Drive-In, Hayward, owner. Frame and stucco construction with some structural steel, plate glass, \$45,000. ARCHITECT: Ward & Bolles, San Francisco. GENERAL CONTRACTOR: Cox & Pritchard, San Francisco.

**STORE AND GRILL**, Wawona, Yosemite National Park, Yosemite Park & Curry Co., owners. New frame construction building to be occupied by general store and grill, \$45,000. ARCHITECT: Ambrose & Spencer, San Francisco. GENERAL CONTRACTOR: Hedahl-Martin Company, Redwood City.

**LAUNDRY BUILDING**, Sacramento. Merch Hospital, owner. One story concrete block, new laundry building, \$104,600. ARCHITECT: Harry J. Devine, Sacramento. GENERAL CONTRACTORS: Continental Construction Company, Sacramento.

**AUTO SALES & SERVICE**, Modesto, Stanislaus county. Alfred Mathews, Modesto, owner. Concrete block and frame building with plate glass front; 5000 sq. ft. in shop building and 7000 sq. ft. in sales and service building, \$100,000. ARCHITECT: G. N. Hilburn, Modesto. GENERAL CONTRACTOR: Wieland Bros., Modesto.

**WEST SIDE ELEMENTARY SCHOOL**, Corcoran, Kings County. Westside Union High School District, Corcoran, owner. One story, frame and stucco; 4-classrooms, administration room, kitchen, and toilet rooms, \$95,000. ARCHITECT: Wilbur C. Harrison, Los Angeles. GENERAL CONTRACTOR: O. T. Chester, Visalia.

**VETERANS MEMORIAL BUILDING**, Piedmont, Alameda county. County of Alameda, Oakland, owner. Two-story reinforced concrete and concrete block construction with tile roof, \$196,550. ARCHITECT: F. H. Reimers & Paul Overmire, San Francisco. GENERAL CONTRACTOR: Robert L. Wilson, San Francisco.

**AUTO SALES & SERVICE**, Tunnage, Los Angeles county. Welman Ford Co., Tunnage, owner. One and part two story cement block auto sales and service building, 5x78 ft. plus separate building 28x180 for repair stalls; composition roof, concrete slab first floor, wood and plate

## SLEEPERS

UNI-BOND—PRECAST—  
PERMANENT—NEVER ROT—  
PERMANENTLY  
NAIL PENETRABLE  
FIRE PROOF  
SECURELY BONDED TO  
THE CONCRETE SLAB

Make Solid Non-Squeaking  
Permanent Wood Flooring

Used in spring floor construction for  
Gymnasiums and dance floors, also  
under solid wood floor construction.  
Spaced on any centers desired. Specifi-  
cations and information available on  
request.

Territories open for qualified repre-  
sentatives. Free consultation service.

**LeROY OLSON  
COMPANY**

3070 Seventeenth Street,  
San Francisco, California

glass, forced air heating, acoustical plaster ceilings, vault room, toilet rooms, \$52,435. ARCHITECT: Scott Quintin, Alhambra. GENERAL CONTRACTOR: Shepard & Morgan, San Marino.

**JUNIOR HIGH ADDITION**, San Luis Obispo. San Luis Obispo High School District, owner. Frame and stucco, 7-academic classrooms, 7-special classrooms, administration, multi-purpose rooms, physical education, kitchen, toilet rooms, \$643,660. ARCHITECT: Falk & Booth, San Francisco. GENERAL CONTRACTOR: Maino Construction Co., San Luis Obispo.

## IN THE NEWS

### ALASKA HOUSING CONTRACT AWARDED

Lytle, Green, & Birch contractors of Seattle, have been awarded a \$4,206,268 contract by the Alaska District Engineer for the construction of family housing at the Ladd Air Force Base.

Under terms of the contract, the Seattle firm is to construct housing for 240 families at the air base. Two-story, frame construction, with basement, in eight-family units will be built.

### DEPARTMENT STORE FOR VAN NUYS

The May Company of Los Angeles is seeking a zone variance for property in Van Nuys, California, for erection of a new department store building.

Albert C. Martin & Associates, architects and engineers, Los Angeles, are the architects.

### LAS VEGAS HAS NEW DRIVE-IN

Architect Elmo C. Bruner of Las Vegas, Nevada, has completed plans and specifications for the construction of a new drive-in restaurant to be built in Las Vegas for Lincoln L. Snyder.

Of steel frame construction, the building will have a lightweight concrete roof, radiant heating, asphalt tile and carpet floors, air conditioning, insulation, plate glass, steel sash, ceramic tile, bar joisted trusses.

### SWIMMING POOL FOR WATSONVILLE

Trustees of the Watsonville Joint High School District, Santa Cruz county, have completed plans for construction of a swimming pool in the City of Watsonville.

John Lyon Reid of San Francisco is the architect.

### COLEMAN NAMES NEW MANAGER

J. R. (Jim) Pruitt has been appointed manager of the construction division of the Coleman Co., manufacturers of automatic gas heating equipment, for Southern California, according to a recent announcement by L. R. Carney, District Manager.

Pruitt, a licensed general contractor and graduate architect, is well known in the construction industry throughout Southern California. He was recently executive secretary of the Los Angeles Chapter of the Building Contractors' Association of California.

### ARCHITECTURAL OFFICES MERGE

Two well known Los Angeles architects, Douglas Honnold and John Rex, have

merged their offices and are now located at 306 N. Doheny Drive, Los Angeles.

John Rex, former president of the California Council of Architects, and former president of the Southern California Chapter AIA, has designed many Southern California schools. He is at present a member of the Board of Zoning Appeals for Los Angeles.

Douglas Honnold has won two honor awards from The American Institute of Architects for restaurant designs.

### MASONIC TEMPLE

A 1- and part 2-story concrete block building is being built in San Gabriel for the Masonic Temple Lodge. It is 87x105 ft. in area and will have a composition roof; banquet room will seat 240 persons. Scott Quintin, Alhambra is the architect.

### ADDITION TO HOTEL

A height limit addition containing 175,000 sq. ft. is being designed for the Beverly Hills Hotel in Beverly Hills, California, by the architectural firm of Pereira & Luckman of Los Angeles.

The addition will comprise two floors of garage space and the space will be de luxe apartments.

### COUNTY BUILDINGS

Qualified elector of Contra Costa county recently approved a \$1,350,000 special bond election. Funds are to be used in the construction of new county offices, courts, and warehouse buildings in the City of Richmond's new Civic Center.

Proposed is a 3-story, with basement,

building 62 ft. x 62 ft. of reinforced concrete and some structural steel. It will have a brick veneer exterior.

Donald L. Hardison of Richmond, is the Architect.

### SAHARA HOTEL ADDITION

Plans for the construction of a 2-story addition to the Sahara Hotel in Las Vegas, Nevada, are being completed by architect Martin J. Stern of Beverly Hills, California.

The new addition will contain 200 rooms and will be of cement block and wood frame construction.

### ARCHITECT SELECTED

The Tulare (California) Board of Supervisors recently commissioned Lloyd J. Fletcher, architect of Lemon Cove, to design the new Woodlake Memorial Building to be built in Tulare county.

### ALASKA ARMY BUILDING

The Alaska District Corps of Engineers recently announced an additional \$2,000,000 has been released for defense construction at Kenai and Fort Richardson.

Seventy family dwellings will be built at Kenai, together with a fence antenna farm with guard shelter. The Fort Richardson project comprises a dispensary building.

### APPOINTED REGIONAL SALES MANAGER

Robert D. Jones, for the last 17-years a field representative in the Los Angeles area for Libbey-Owens-Ford Glass Com-

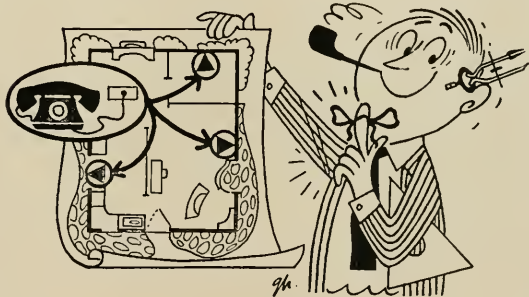

*For that 'extra finish' don't forget  
built-in telephone facilities*

Your clients will be happier with building plans that include planned telephone facilities. Concealed conduit for telephone wiring and conveniently located telephone outlets will allow them to change the position of their telephone or add a new instrument later on without detracting from the beauty of their home with exposed wiring.

Just call Pacific Telephone's free Architects and Builders service. We'll be glad to help you plan for greater beauty tomorrow in the homes you are building today.

*Put built-in telephone facilities in your plans*



**Pacific Telephone**

pany, has been named Pacific regional sales manager of the Corrollux Division of LOF Glass, according to a recent announcement by George D. Jefferson, sales manager of Corrollux.

Corrollux is a translucent plastic sheet material reinforced with fiber glass.

#### SAN MATEO ELKS CLUB BUILDING

E. J. Miller, architect of San Mateo, has been commissioned to draft plans for the construction of a new Elks Building to be built in San Mateo by the Elks Hall Association.

The new building will comprise a 1-story, frame and stucco structure with concrete slab floors, steel sash, composition roofing, warm air heating, and a swimming pool. Estimated cost of project is \$300,000.

#### SCHOOL BONDS VOTED

Qualified electors of the Hayward Union High School District, recently approved a school bond issue of \$8,000,000.

Funds are to be used in the construction of new High School buildings and additions to existing buildings.

#### HOSPITAL ADDITION

Swinerton & Walberg, San Francisco, and Cahill Bros of Oakland, have been given the contract under a joint-venture, for the grading and installation of drainage facilities and the erection of the first buildings at the new Ford automobile plant being built near Milpitas in Santa Clara county.

The initial building containing approximately 1,500,000 sq. ft. and a 2-story ad-

ministration building are on the 160 acre site recently acquired. Total cost of the project is estimated at \$35,000,000.

#### NEW JET TEST BASE CONTRACT

The Air Material Command has authorized Lockheed Aircraft Corp., to complete commitments with the architectural firm of Pereira & Luckmann of Los Angeles, to design a new jet test center to be built at Palmdale.

Facilities of the new field will be used jointly by a number of major aircraft companies.

#### ARCHITECT MOVES

Leslie I. Nichols, A.I.A. architect of Palo Alto has moved his offices from 627 University Avenue to 454 Forest Avenue, same city.

#### LOS ANGELES BUILDS COUNTY BUILDING

Architect Earl G. Boehm is the architect for a 280,000 sq. ft. office-warehouse building being erected for the Los Angeles County Purchasing and Stores Department, at a cost of \$1,635,000.

Tilt-up concrete construction is being used. About 2½ acres of land has been set aside for parking and trucking facilities and a nine-car spur track is also being provided. The building itself will be about 375x650 feet.

#### ARCHITECT SELECTED

Franceschi & Mullen of Sacramento were chosen architects to design a new school building for the Sierra-Plumas Joint Unified

School District to be built in Downville. Selection of the architects was made by the governing board of the district.

#### AIRCRAFT PLANT EXPANDS OFFICES

The Douglas Aircraft Company, Inc., El Segundo division, is building an administration building containing 102,000 sq. ft.

Plans for the structure, which is 936 feet long, were prepared by Van Dyke & Barnes, Los Angeles architect and engineer. When completed it will house the employment department, reception lobbies, and offices, and the medical department comprising first-aid facilities, X-ray equipment and dispensary.

#### LOS ANGELES SETS BUILDING PACE

Los Angeles county led the nation in the amount of building permits issued during the first three months of 1953.

The grand total of \$127,502,825 exceeded the totals of Chicago, Philadelphia and Detroit combined by more than \$18,746,331.

Throughout the Pacific Coast the total permits issued more than double the same amount for the same period of last year.

#### SCHOOL BONDS APPROVED

Voters of the Needles Union High School District in San Bernardino county, California, recently approved a special school bond issue of \$825,000 to be used in modernization of the Needles High School and construction of a new Junior High School.

#### GARAGE-APARTMENT IN LONG BEACH

Architect Paul L. Williamson of Long Beach is the architect for a 2-story frame and stucco garage-apartment building being built in Long Beach for B. B. Sullivan.

#### ARCHITECT SELECTED

The architectural firm of Kirby & Mulvin, San Francisco, has been commissioned by the Housing Authority of the City and County of San Francisco, to design plans for the proposed Middlepoint Low Rent Housing project to be built in San Francisco at an estimated cost of \$2,500,000.

The project comprises 2-story, row houses of frame and stucco construction.

#### WOMEN'S CLUB HOUSE

The Arvin Women's Club of Arvin, Calif., is building a new Club House and has commissioned architect Whitney Biggar of Bakersfield to draft plans and specifications for the new structure.

#### SUBDIVISION LAWS NEED REVISION

According to a report made by Marybeth Branaman of the Real Estate Research Program, Bureau of Business and Economic Research of the University of California at Berkeley, and filed with D. D. Watson, California Real Estate Commissioner, California's laws regulating residential subdivisions are badly in need of overhauling.

Conflicting regulations, lack of authority by regulating bodies, and the lack of a unified administration of controls combine to provide inadequate safeguards for buyers and delays for builders.

Findings of the survey indicate the bulk of complaints about subdivisions in the past

## VALUABLE NEWS SERVICE

- BUILDING MATERIAL DEALERS
- CONTRACTORS
- SUB-CONTRACTORS
- MANUFACTURERS AND REPRESENTATIVES

**ARCHITECTS REPORTS** gives advance news on construction projects in Northern California, lists: name of projects, location, architect, proposed cost and other pertinent information.

**HANDY** individual slip-reports, issued daily at a total cost of only

\$10 a month

## ARCHITECT'S REPORTS

Published Daily

The ARCHITECT and ENGINEER, Inc.

68 Post Street, San Francisco - DO 2-8311



## CLASSIFIED ADVERTISING

Will Bring Results

—USE—

## ARCHITECT and ENGINEER

68 Post St. San Francisco

few years concern flood hazards and improper drainage, erosion of ground fill, inadequate water supplies, improper sewage facilities, and the lack of proper road and street construction and repair.

### CHRISTIAN CHURCH BAKERSFIELD

The First Christian Church of Bakersfield will build a new Church in Bakersfield with a seating capacity of 760 persons. Plans and specifications are being prepared by architect Ernest L. McCoy.

Concrete block, brick and glass will form the exterior; steel sash, concrete floor and aisle carpeting will be used in the sanctuary. The Chapel, of frame and stucco construction, concrete floor, plate glass, Roman ruffle brick and a shingle roof will seat 150 persons. A frame and stucco administration building will be built in a central position in relation to the entire project.

### EXPAND STATE HOSPITAL LAS VEGAS, NEW MEXICO

The State of New Mexico is constructing a new receiving ward and clinic at the State Hospital for the Insane at Las Vegas, New Mexico.

The project includes the fireproofing of existing buildings, revision and expansion of kitchen facilities, additions to present wards, and will cost \$2,000,000.

W. C. Kruger & Associates of Santa Fe are the architects.

### AIRPORT BONDS APPROVED

Voters of the City of Oakland recently approved a special bond issue of \$10,000,000 for improvements at the Oakland Municipal Airport.

Included in the new construction will be a terminal building. The project is under supervision of the Port of Oakland Commission.

### GREYHOUND REMODEL

Offices of the Pacific Greyhound Lines in San Francisco are being remodeled according to plans by architect W. D. Peugh of San Francisco.

The building occupied by the bus company's general offices is a 4-story, with basement, structure and plans call for exterior and interior changes.

### LABORATORY BUILDING

The Eastman Kodak Company of San Francisco is constructing a new laboratory building in Palo Alto containing 150,000 sq. ft., according to a recent announcement.

The new laboratory will be a 1-story structure of reinforced concrete and reinforced tilt-up construction. Steel sash will be used and a complete air conditioning system installed.

Ward & Bolles of San Francisco are the architects.

### FRATERNITY HOUSE

The Sigma Alpha Epsilon Fraternity, University of Nevada at Reno, are negotiating with general contractor Frank Capriote of Reno, for the construction of a new 2-story, with basement, fraternity house which will cost in the neighborhood of \$102,600.

The building, according to architect Russell Mills, who is drafting plans and specifications will be of frame and brick veneer construction.



## HERRICK IRON WORKS

### STRUCTURAL STEEL REINFORCING STEEL

18TH AND CAMPBELL STS.  
OAKLAND, CALIF.  
Phone GLencourt 1-1767

Phone GARfield 1-1164

## Thomas B. Hunter

### DESIGNER OF HEATING

AIR CONDITIONING  
VENTILATING AND WIRING  
SYSTEMS, MECHANICAL  
AND ELECTRICAL EQUIP-  
MENT OF BUILDINGS



41 SUTTER STREET  
ROOM 710

San Francisco

California

## MULLEN MFG. COMPANY

BANK, STORE AND OFFICE  
FIXTURES—CABINET WORK  
OF GUARANTEED QUALITY  
CHURCH SEATING

Office and Factory

60-80 RAUSCH ST., Bet. 7th and 8th Sts.

San Francisco

Telephone UNderhill 1-5815

## E. H. MOORE & SONS

GENERAL  
CONTRACTORS



693 MISSION STREET  
SAN FRANCISCO

Subscribe  
Now —

## ARCHITECT and ENGINEER

\$3.00  
Per Year

## DINWIDDIE CONSTRUCTION COMPANY

## BUILDERS

CROCKER BUILDING  
SAN FRANCISCO

*Fine*  
**ENGRAVINGS**

**POOR  
RICHARD**  
PHOTO ENGRAVING CO.  
320-324 COMMERCIAL STREET  
SAN FRANCISCO 11

**PITTSBURGH  
TESTING LABORATORY**

**ENGINEERS AND CHEMISTS**

Testing and Inspection of Concrete,  
Steel and Other Structural Materials

Design of Concrete Mixes

Offices in all principal cities

651 Howard St., San Francisco 5  
EXbrook 2-1747

**MATTOCK  
CONSTRUCTION  
COMPANY**



**BUILDERS**



604 MISSION STREET  
SAN FRANCISCO

**ARCHITECT  
and  
ENGINEER**

Please enter my subscription for  
..... year.... My check in the  
amount of \$..... is attached.  
1 year . . . . \$3.00  
2 years . . . . 5.00

Name.....

City.....

State.....

**ABBOT A. HANKS, INC.  
Engineers & Chemists**

INSPECTING — TESTING — CONSULTING  
CONCRETE • STEEL • MATERIALS  
CHEMICAL AND TESTING  
LABORATORIES

• RESEARCH AND INVESTIGATION •

TESTS OF STRUCTURAL MATERIALS  
DESIGN OF CONCRETE MIXES  
SHOP AND ERECTION INSPECTION OF  
STRUCTURES AND EQUIPMENT  
INVESTIGATION OF STRUCTURES  
AND MATERIALS

TESTS AND INVESTIGATION OF  
FOUNDATION SOILS  
FIRE RESISTANCE AND INSULATION  
TESTS

624 Sacramento Street, San Francisco

**Index to Advertisers**

ALLIANCE Engineer ..... 38  
ARCHITECTS Reports ..... 47  
BARRETT & HILP, Contractors..... 37  
BY-CHEMICAL Products Co. .... 36  
CAMBRIDGE Tile Mfg. Company..... \*  
CLAY Brick & Tile Association..... 5  
CLASSIFIED Advertising ..... 45  
CLINTON Construction Company..... 38  
CROCKER First National Bank..... \*  
DINWIDDIE Construction Company... 49  
FINK & SCHINDLER Co., The..... 35  
FORDERER Cornice Works..... 37  
GLADDING, McBean & Company..... 1  
GREENBERG'S, M. Sons..... 34  
HAAS & HAYNIE Const. Co..... 36  
HANKS, Abbott A., Inc..... 50  
HAWES Drinking Faucet Co..... 30 & 31  
HERRICK Iron Works..... 49  
HOGAN Lumber Co. .... 38  
HUNT, Robert W. Company..... 50  
HUNTER, Thos. B. .... 49  
IDEAL Cement Co. .... Back Cover  
INERTOL Co., Inc..... 35  
JOHNSON, S. T. Co..... 36  
JUDSON, Pacific-Murphy Corp..... 38  
KRAFTILE Company ..... 28  
MARBLE Institute of America ..... 2  
MATTOCK Construction Co..... 50  
MICHEL & Pfeiffer Iron Works, Inc.  
..... Inside Front Cover  
MOORE, E. H. & Son..... 49  
MULLEN Mfg. Co. .... 49  
OLSON, Leroy Co..... 46  
PACIFIC Coast Aggregates..... 29  
PACIFIC Manufacturing Co..... 39  
PACIFIC Telephone & Telegraph Co. 47  
PARKER, Steffens & Pearce..... 37  
PITTSBURGH Testing Laboratory..... 50  
POOR Richard Engraving Co..... 49  
PORCELAIN Enamel (Architectural)  
Division) Publicity Bureau ..... 33  
REMILLARD-Dandini Co. .... 50  
REPUBLIC Steel Corporation ..... 39  
SCOTT Company ..... 50  
SIMONDS Machinery Company ..... 39  
SMOOT-Helman Company ..... 33  
SUMMERBELL Roof Structures. .... 35  
U. S. Bonds. .... Inside Back Cover  
VERMONT Marble Company..... 39  
WEST Coast Screen Co..... 40

\*Indicates Alternate Months

**Scott Company**

**HEATING • PLUMBING  
REFRIGERATION**



San Francisco  
Oakland  
San Jose  
Los Angeles

**FOR ADVANCE  
INFORMATION**

**ON  
BUILDERS  
CONTRACTORS  
ENGINEERS**

Get

**ARCHITECTS  
REPORTS**

68 Post St. Phone  
San Francisco DO 2-8311

**ROBERT W. HUNT CO.**

**ENGINEERS  
INSPECTING TESTING**

**STRUCTURAL MATERIALS  
CONCRETE MIX DESIGN  
CHEMICAL ANALYSIS  
EQUIPMENT**

PRINCIPAL CITIES  
UNITED STATES • EUROPE  
SAN FRANCISCO • LOS ANGELES  
PORTLAND SEATTLE

**REMILLARD-DANDINI Co.**

**Brick and  
Masonry Products**



400 MONTGOMERY STREET  
SAN FRANCISCO, CALIF.

# ARCHITECT AND ENGINEER

A RESIDENTIAL SWIMMING POOL . . . WOODSIDE, CALIFORNIA



GARDNER A. DAILEY, Architect

**JULY**

**1953**





Mayfair School, Fresno  
Franklin & Simpson, Architects

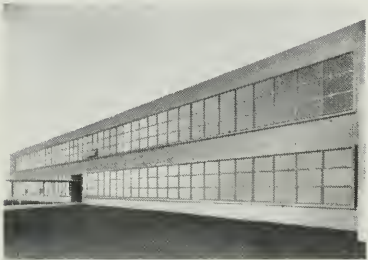

Willow Glen High School, San Jose  
Marsh, Smith & Powell, Architects



## *Steel Windows*

*&*

## *Doors*

ARISTON Steel Windows and Doors are especially designed and constructed to meet the particular requirements of each job.

Michel & Pfeffer engineers are always available to assist architects in their preliminary and final plans.

# *Arislide*

## *Horizontal Sliding Doors*

- Fully Spring Bronze Weatherstripped
- Roller-bearing Bottom Rollers
- Smooth, Quiet Operation
- Bronze Handles and Foot Bolt
- Stainless Steel Capped Track



WRITE FOR LITERATURE: INQUIRIES INVITED

## **Michel & Pfeffer Iron Works**

N. K. JUVET, Manager Steel Window Division  
So. East Corner of So. Linden and Tanforan Avenues  
South San Francisco • Telephone Juniper 4-8362

Since 1912

# ARCHITECT

Vol. 194

No. 1

# AND ENGINEER

ARCHITECTS' REPORTS—Published Daily

**EDWIN H. WILDER**  
Editor

**J. WELLS HASTINGS**  
Contributing Editor

**PROF. LELAND VAUGHAN**  
Landscape Architecture

**JOHN A. BLUME**  
Structural Engineering

**MICHAEL GOODMAN**  
Planning

**JOHN S. BOLLES. A.I.A.**  
Book Reviews



## COVER PICTURE

RESIDENTIAL  
SWIMMING POOL  
Woodside, California

OWNER—  
W. W. Mein, Jr.

ARCHITECT—  
Gardner A. Dailey

LANDSCAPE ARCHITECT—  
Thomas D. Church

GENERAL CONTRACTOR—  
M. C. Ingraham

POOL—A free form Paddock design; length 48', width 15'-43". Tile trim. Marcite interior finish incorporating White Cement. Underwater lighting; filter system, automatic surface skimmer. Chrome finished ladders and diving equipment.

(Photo by Keith Cole)

**ERNEST McAVOY**  
Advertising Manager

ARCHITECT & ENGINEER  
is indexed regularly by  
ENGINEERING INDEX, INC.

## Contents for

# JULY

EDITORIAL NOTES . . . . .	2
GROUND WATER IN GRADE SLABS . . . . .	3
—Its Effect on Floor Coverings	
—Its Prevention	
Part. One. By C. Leroy Olson.	
NEWS & COMMENT ON ART . . . . .	4
SWIMMING POOLS—Their Equipment, Their Care . . . . .	6
By Norman R. Miller, Vice-President, American Playground Device Co.	
Architectural designs by Gardner A. Dailey, Wayne D. McAllister, John M. McWilliams; Showing Pools at Ferguson Missouri; Stuarts Draft, Va.; Woodside, California; Las Vegas, Nevada; and Ignacio, California	
MUNICIPAL SWIMMING POOL, La Mesa, California . . . . .	12
Raymond Lee Eggers, A.I.A.—Eggers & Faddis, Architects, La Mesa	
CADILLAC—Stonestown Agency, San Francisco . . . . .	16
Welton Beckett and Associates, Architects	
KRAFTILE DEALERS—See Patio Tile Demonstration . . . . .	24
A. I. A. ACTIVITIES . . . . .	26
WITH THE ENGINEERS . . . . .	28
PRODUCERS COUNCIL PAGE . . . . .	30
Edited by Stanley L. Basterash, Western Asbestos Co.	
PERSONALITIES: Paul Thirty, A.I.A. Architect, Seattle, Washington . . . . .	32
BOOK REVIEWS, Pamphlets and Catalogues . . . . .	36
ESTIMATOR'S GUIDE, Building and Construction Materials . . . . .	39
ESTIMATOR'S DIRECTORY, Building and Construction Materials . . . . .	41
CONSTRUCTION CONTRACTS AWARDED and Miscellaneous Data . . . . .	42
BUILDING TRADES WAGE SCALES, Northern, Central & Southern California . . . . .	43
CLASSIFIED ADVERTISING . . . . .	43
IN THE NEWS . . . . .	45
INDEX TO ADVERTISERS . . . . .	48

ARCHITECT AND ENGINEER (Established 1905) is published on the 15th of the month by The Architect and Engineer, Inc., 68 Post St., San Francisco 4; Telephone EXbrook 2-7182. President, K. P. Kierulff; Vice-President and Manager, L. B. Penhorwood; Treasurer, E. N. Kierulff.

Los Angeles Office: Wentworth F. Green, 439 So. Western Ave., Los Angeles 5; Telephone DUnkirk 7-8135.

Entered as second class matter, November 2, 1905, at the Post Office in San Francisco, California, under the Act of March 3, 1879. Subscriptions United States and Pan America, \$3.00 a year; \$5.00 two years; foreign countries \$5.00 a year; single copy 50c.

ARCHITECTS' REPORTS are published daily from this office, Vernon S. Yallop, Manager, Telephone DOuglas 2-8311.

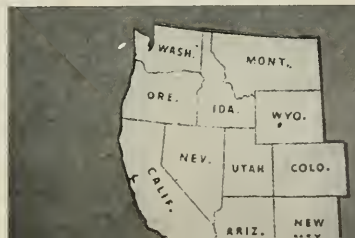

# EDITORIAL NOTES

## HOME BUILDERS

Officials of the National Association of Home Builders of the United States have been endeavoring to convince members of Congress for the urgent need of immediate action to break the mortgage finance jam on home buying and thereby insure a steady volume of housing production throughout the nation for the coming months.

Armed with first-hand reports from all parts of the country on the critical mortgage situation, M. Speigel, President and R. G. Hughes, Vice President of the Association, presented a number of recommendations to the Senate and House Banking and Currency Committees. They endorsed the interim housing legislation under consideration by the committees, but pointed out it did not go nearly far enough to solve the industry's most pressing problems.

Recommended for Congressional action was 1) reduction in down payments on mortgages insured by the Federal Housing Administration to give non-veteran families in the middle and lower income brackets a fair chance to buy the homes they want and need, 2) adoption of the plan to permit the Federal National Mortgage Association to operate the so-called "one-for-one" plan which would restore FNMA to its original function as a backstop to the market for use only in those areas where there is a temporary shortage of private funds. At the same time it would accomplish a substantial reduction in FNMA's existing portfolio at the best terms for the government.

Everyone in the construction industry should interest themselves in the efforts being put forth by the NAHB to "smooth out" problems confronting the construction of adequate housing throughout the nation on the long established concept of individual and free enterprise.

*A free market economy always leaves open the door of opportunity to the man with a new idea, a new product or a new method.*

## HOW HIGH IS UP?

How high can the Federal Debt get—and that is what determines the amount of taxes you pay to the federal government? Well, in 1869 when the Civil War had just been fought, the Federal Debt was \$2.2 billion. After fighting World War I the Federal Debt stood at \$25.2 billion in 1919, and after World War II and playing Santa Claus to the peoples of the World for a number of years, the Federal Debt stood at \$262.7 billion.

In other words, if each family in the United

States was to pay enough money to get the federal government out of debt, the family would have to pay \$5,874.00. How long does it take you to earn \$5,874.00? How long would you have to work to save enough money, over living costs, to have \$5,874.00? How High is Up? Only your representative in Congress knows the answer.

\* \* \*

## SOCIAL SECURITY

Security for old age must be considered as a three-layer cake. The first layer constitutes the floor of security provided through the cooperation of a well administered and universal pay-as-you-go government program. The second layer is often cooperatively arrived at through the joint action of employer and employee. It should meet the particular needs and desires of the group involved. Finally, there is the most important layer—that of individual thrift, initiative and family responsibility which is independently determined by the individual and fashioned to meet particular desires and circumstances.

This three-layer cake is the approach to Social Security favored by the large majority of Americans. They have rejected the alien European view of the welfare state wherein it is assumed that the individual cannot and should not provide for his own security.

Recurrent postwar crises have demonstrated that the end result of the European welfare state is a crushing burden of taxation, inflation, and the destruction of the production base, the only real basis of security. Such an approach guarantees neither security nor well-being.

For years the social planners have regularly engaged in a campaign of statistical justification for the philosophy that people cannot save for their old age, that they are largely destitute and, therefore, must be wholly supported by the state. But the facts of the case show that aging persons have substantial assets. The total assets of people over 65 years of age have been estimated at some \$90-billion; about 5.5 million of these people own their own homes and about a million own other real estate in substantial amounts averaging over \$10,000.

Social Security will only be a reality when each individual is in possession of sufficient cash or securities to be security independent. To have this security is the responsibility of each individual and can not be obtained on a "let-George-do-it" program.



# GROUND WATER IN GRADE SLABS

## — ITS EFFECT ON FLOOR COVERINGS — ITS PREVENTION

**Part One\***  
**By C. LeROY OLSON**

For at least thirty years or more the flooring contractors throughout the nation have been aware of the damage done to floor coverings by ground water present in and below slabs or by alkaline salts carrier from within or below the slab by such ground water. Often they have taken steps to overcome this trouble in various ways which will be discussed later on in this article.

While many architects, engineers, and others in the construction industry have recognized such shortcomings in construction of buildings having a slab on grade, not all such professional men have done so with the result that often the solution of such problems has been left to the floor covering contractor on the job sooner or later. Such architects, engineers in the construction industry have, however, been concerned about slabs below grade, such as basement slabs, and have taken steps accordingly to prevent the emergence of such moisture from the concrete slab and walls using various methods available to them.

Often our office receives inquiries from the staff of such building designers requesting specialized information not always available to them from other sources. Consequently, this article is being written for those in the construction industry who



**C. LeROY OLSON**  
LeRoy Olson Company

*\*EDITOR'S NOTE: This article has been specially written by C. LeRoy Olson of the LeRoy Olson Company of San Francisco, for Architect & Engineer magazine. Part One of the article appears herewith, Part Two will appear next month.*

do not have the answers at their command and which are contained in this article. Copies of this article are being published in pamphlet form by the LeRoy Olson Company and will be available to the files of everyone interested—on request.

The methods used by the floor covering contractor for asphalt tile, grease proof tile and/or mastipave, etc., often consist of a cutback asphaltic adhesive, a primer coat of asphaltic cutback solution. If the emulsified type of asphalt cement or prime coat is applied, it must be thoroughly dry before any attempt is made to overlay it with floor covering, since to render waterproof such emulsified asphalt, all mechanically entrained water must be completely removed or eliminated by evaporation. Otherwise, such emulsified adhesive or primer will usually redissolve in place, migrate and leave the floor covering free to shift on the slab. Such floor covering is usually of the asphalt tile, grease proof tile or mastipave type of floor covering.

When alkalies are present in the slab or in the ground water and carried through the slab, they appear on the surface of the slab in the form of white incrustations which may attack or interfere with the asphaltic primer or adhesive, rendering it ineffective as a primer or as an adhesive.

This manifestation may likewise occur where cutback asphaltic adhesives or primers are used, but they do not show the same degree of migration or disappearance as the emulsified type of adhesive or primer.

Often a new type of primer such as lacquer or synthetic plastic liquids, etc., is used with good effect to prevent the appearance of such alkalies,

(See Page 22)

# NEWS and COMMENT ON ART



## CALIFORNIA SCHOOL OF FINE ARTS

Summer sessions of the California School of Fine Arts, 800 Chestnut Street, San Francisco, offer a diversified and general program in both day and night classes.

Ernest Mundt, Director of the California School of Fine Arts, announced "Foundations of Modern Art" would be the subject of the Summer Sessions curriculum and includes "preparation for the student and teacher in the techniques, backgrounds and materials of Modern Art." Courses will also offer an integration of methods into thorough presentation of the philosophy and principles upon which contemporary art is based. Lectures and round-table discussions will give students a better understanding of the materials and techniques which the courses offers.

Among guest lecturers to appear during the "Foundations of Modern Art" discussions will be:

Alfred Frankenstein, author and critic; Walter Landor, Industrial Designer; Dr. John W. Perry, noted Psychiatrist; Ernest Mundt, author and sculptor and CSFA director, and others.

Robert Neuman, recent winner of the Fulbright Scholarship to Europe, will offer a special course in water color painting, and Kenneth Nack, distinguished American painter and teacher, will offer a course in painting fundamentals, techniques, still life and non-objective work.

Full professional training is offered in every field of Painting and Sculpture, Commercial Arts and Design, Photography and Crafts.

## SAN FRANCISCO MUSEUM OF ART

The San Francisco Museum of Art, War Memorial Building, Civic Center, is presenting a diversified calendar of exhibitions and events for July, which is highlighted by the Leger Exhibition which



## SAN FRANCISCO MUSEUM OF ART

WAR MEMORIAL BUILDING  
CIVIC CENTER  
SAN FRANCISCO

### STILL LIFE, Oil

24 x 19 3/4"

by

FERNAND LEGER

The exhibition, Leger:  
A Survey of His Art is in  
view at the San Francisco  
Museum of Art through  
August 23.

Albert M. Bender  
Collection.

will continue until August 23. Other summertime activities include:

**EXHIBITIONS:** Steuben Glass; Leger—A Survey of His Arts; Prints by Enid Foster, Mar Jean Ket-tunen, and Julius Wasserstein; Design for Out-door Living; Contemporary Drawings from Twelve Countries; and Costume and Stage Designs by Eric Stearne.

**EVENTS** will include Concerts and Lecture Tours (Sundays at 3 o'clock); Wednesday evening (8 o'clock) discussions; and the Museum activities covering "Art for the Layman", "Adventures in Drawing and Painting", and the Children's Satur-day morning classes have been recessed for the summer and will be resumed in September.

Museum hours are Mondays 12-5; Tuesday through Saturday, 12-10, and Sundays and Holi-days 1-5.

---

### **SCHOLARSHIPS AWARDED BY THE CALIFORNIA SCHOOL FINE ARTS**

Nineteen Certificates of Completion were presented graduating students by Francis V. Keesling, Jr., president of the San Francisco Art Association at the recent graduation exercises of the California School of Fine Arts in San Francisco.

Traditional setting was the Annual Student Exhibition in the galleries and patio of the School, presented by the Directors and Women's Auxiliary, and the faculty. The exhibition, which included showing of work completed in illustration, painting, sculpture, ceramics, jewelry making, lithography, advertising layout and design, remained open for public inspection.

Awards were given to: Zoe Lowenthal, student in Photography and Graphic Arts, The Robert Howe Fletcher Cup; Gertrude Murphy, sculpture student, The I. N. Walker Sculpture Prize; Eleanor Prindle, student in fine arts, The Gertrude Partington Albright Award for Drawing; John Saccaro, Painting; Robert Carigg, Julius Wasserstein, John Kraus, Stavros Trian and Jakobine Schou also received awards in painting and sculpture.

Irene Pattinson, 1st in Design; 2nd Caroline West; Zoe Lowenthal, 1st in Photography, and Alex Lib-sohn, 2nd.

Eleven scholarships were also awarded from various trust funds and bequests left to the school.

---

### **M. H. deYOUNG MEMORIAL MUSEUM**

The M. H. deYoung Memorial Museum, Golden Gate Park, San Francisco, under the direction of Walter Heil, offers a diversified summer group of exhibitions and events for July including:

**EXHIBITS:** Contemporary Hand weavers of Cali-

fornia—Fifth Annual showing; Watercolors by Richard L. Shell; Paintings by Graham Sutherland and Sculpture by Henry Moore; Paintings by Mario Sironi and Sculptures by Marino Marini; Associa-tion of San Francisco Potters—Seventh Annual ex-hibition; Building in Germany 1945-1952, repre-senting a group of photographs of Post-War Archi-tecture; Contemporary Indian Art and Crafts; Twenty American Paintings, from the Collection of the International Business Machines Corporation; and Thirteen Watercolorists—19th Annual.

**SPECIAL EVENTS** during July will include lec-tures and guided tours.

---

### **FRANK LLOYD WRIGHT RECEIVES NATIONAL INSTITUTE'S MEDAL**

Octogenarian Frank Lloyd Wright, America's still controversial peer of architects, was awarded the National Institute of Arts and Letters coveted Gold Medal for Architecture, according to an announcement by Marc Connelly, president.

Given twice annually for achievements in two different branches of the arts, the selection of Marianne Moore for the Gold Medal for Poetry was recently announced, the medal is given in rotation in other years for sculpture, music, his-tory and biography, drama, and essays.

Presentation was made by Ralph Walker, archi-tect and vice-president of the Institute. Wright's work is also on display in the Gallery of the In-stitute-Academy, New York, together with works of grantees, award winners and new members.

---

### **DeYOUNG MUSEUM ACQUIRES RUBENS MASTERPIECE**

The M. H. deYoung Memorial Museum, Golden Gate Park, San Francisco, announces the acqui-sition of "Portrait of a Gentleman" by Peter Paul Rubens. This rare and valuable Rubens master-piece painted about 1615, was donated by Mr. and Mrs. Roscoe Oakes.

According to Dr. Walter Heil, Museum director, no other American Museum has any portrait of such quality and few European museums can boast owning comparable ones.

As the Flemish master (1577-1640) was famous for his large compositions of holy and mythologi-cal subjects he was kept so busy with commis-sions from princely houses and churches he had to employ numerous assistants. His portraits how-ever were usually entirely by his own hand. Hence they stand out among all his other paintings and are the most perfect token of his art.





Municipal Swimming Pool . . . Ferguson, Missouri

# SWIMMING POOLS

## — THEIR EQUIPMENT

## — THEIR CARE

By **NORMAN R. MILLER**, Vice-President  
**American Playground Device Co.**

Durability, safety, approved design and economy are important factors to consider when selecting swimming pool equipment.

Look for the manufacturer who puts safety, in both design and construction, ahead of all other considerations, and who then builds into his products that extra durability which exceeds any strain to which they will be put.

First of all, be sure to buy diving units that meet the official requirements of the A.A.U. and N.C.A.A.

Conventional equipment at hundreds of pools is the one-meter diving unit. It should be constructed of hot-dip galvanized steel pipe, with the frame locked rigidly together by certified malleable fittings, throughbolted through the pipe members for greater strength and durability. Hot-dip

galvanizing gives the metal enduring rust protection.

For pools where the walk areas are limited, an extra heavy duty regulation one-meter diving unit of the streamlined type is recommended. The frame, supports and guard rail assembly should be constructed of larger pipe, preferably 2 $\frac{3}{4}$  inches in diameter. For resort hotels, country clubs and spas, where all accessory equipment must have true architectural beauty, the one-meter diving unit should combine graceful, streamlined design with heavy duty construction.

The streamlined three-meter diving unit should consist of a frame, main braces, stairway and risers of hot galvanized steel pipe, preferably 1 $\frac{7}{8}$  inches in diameter. Counterbracing of heavy, cold-

rolled flat steel bars and cantilever construction add durability. All stairways should be slanting, with non-slip treads and safety handrails.

For larger pools, triple diving units will provide greater activity and enjoyment. This equipment should include one official three-meter and two one-meter units, fan-shaped to assure absolute safety for the divers. One official 16-foot and two 14-foot diving boards are recommended for the triple diving unit.

A.A.U. and N.C.A.A. official regulations require diving boards of 14 and 16 feet, each 20 inches wide, 3 inches thick at the base and tapering to 1½ inches at the diving tip.

Proper selection of diving boards will greatly reduce maintenance work and expense. A type which gives years of good service is the regulation board of solid laminated construction. Top grades of clear, 100 per cent flat dense grain, old growth

Douglas fir must be carefully selected for moisture content and texture. Each of the 12 laminated sections comprising the board should be surfaced, planed and sanded to assure perfect glue joints.

Laminated sections should be matched and permanently welded together, using a special glue, resistant to tremendous pressures and to water. The boards should be treated with a sealant which seals in the proper moisture content so essential to assure the flexibility and resiliency required in official boards.

Springboard units are ideal for installation whenever official regulation diving units are not required. The springboards are made in 12 foot lengths, with 15, 18 and 20-inch widths. Complete units are equipped with strap-down fulcrums, all necessary fittings and anchors for installation on either a concrete or wood dock.

Increased safety is assured by covering boards

**Bathing At  
SHENANDOAH ACRES  
Stuarts Draft, Va.**

**This 30 ft. long steelchute  
slide provides thrills  
and fun for swimmers  
at this fine inland  
beach near Staunton,  
Virginia.**

*Photo by Alwood Studios.*

*Courtesy  
American Playground  
Device Co.*





ON THE REDWOOD HIGHWAY . . . ACROSS THE GOLDEN GATE BRIDGE

PICTURESQUE SETTING FOR  
RANCHO RAFAEL  
SWIMMING POOL  
IGNATIO, CALIFORNIA

ARCHITECT: JOHN M. McWILLIAMS



Rancho Rafael, located a few miles north of San Francisco on the famed Redwood Highway, is a beautiful California-Old Spanish Mission type of rural Motel-Hotel construction, with traditional thick adobe walls; attractive stone fireplace chimney; and traditional red-tile roof with eaves that extend well over the walls of the building to provide shade from the summer sun and protection from winter winds and rain.

The administration building, center of the site property, includes a spacious dining room decorated in cool forest green and natural California wood; large picture windows overlook the garden and swimming pool; and a comfortable air-conditioned "Round-Up" room, with sound proofing and indirect lighting, overlooks the terrace and large swimming pool.

Feature of the project is the "Landon Blue Lake" swimming pool which lies immediately adjacent

to the administration building and is almost surrounded by the guest accommodations which form a huge arc around the entire hillside of the grounds.

The swimming pool is 25x50 feet in size and was designed and built to serve the community as well as the Rancho Rafael guests. It is equipped with the usual diving board at the deep-end, and is immediately surrounded by a paved area and lawn-patio which may be used for dining, or just relaxing in the sun. Pool umbrellas are provided for those who seek the out-of-doors, but not the direct rays of the sun.

To present an unusually attractive appearance the pool is painted in a light blue Ramuc swimming pool enamel which reflects and emphasizes the blue of the sky overhead. Painting of the pool with the chlorinated rubber-base enamel solves many a maintenance problem and retains the desired color as well as providing better sanitation, durability and customer satisfaction and pleasure.

*Photos by Moulin Studio (Courtesy Inertal Co.)*





# MUNICIPAL SWIMMING POOL - - - La Mesa

CALIFORNIA

ARCHITECTS: RAYMOND LEE EGGERS, A.I.A.  
Eggers & Faddis, Architects

Cost \$113,000.00

This pool is located in MacArthur Park, a city park, now being developed near the center of the City of La Mesa, San Diego county, California. The architect Raymond Lee Eggers, A.I.A. of the architectural firm of Eggers & Faddis, points out that the pool represents an advancement in the design of such an installation.

The Recreation Commission of La Mesa determined that this was to be a community pool, designed for the enjoyment and benefit of every age group. Representative pools were visited by the architects and members of the Recreation Commission throughout Southern California and as far north as the City of Fresno in the San Joaquin Val-





## MUNICIPAL POOL . . .

pool in the side walls of the pool shell and bottom drains. The pool area is approximately 5,400 square feet and it contains 220,000 gallons.

The pool shell is reinforced gunite walls with poured concrete floor. The interior surface of the shell is white cement plaster. Gutters and racing lane markers are tiled. Deck areas are spacious with attention given to a carefully troweled tinted concrete surface to provide good drainage, sufficient traction, but not such a rough surface as to damage the feet. A low concrete block wall with a cast concrete seat cap and a wire mesh fence surround the pool where not bordered by the buildings.

The showers and locker buildings are oriented to provide the maximum shelter from prevailing winds. All shower and locker buildings visited on our survey, shared two universal shortcomings which were, the lack of adequate natural light and ventilation. In order to overcome this problem, we have designed, for what we believe to be the first time in a shower and locker building, a roof on casters and track which is rolled off the Shower and Locker Rooms by electric power. These rolling roofs are light in weight consisting of translucent

corrugated glass fiber plastic on a wood frame. When in the open position, these roofs shelter a sun bathing area on one side and a spectator area on the other side of the building. An added advantage to this feature is that the sunlight controls the growth of bacteria and algae thus reducing maintenance.

The buildings are constructed of concrete block treated with clear water-proofing on the exterior and sprayed on vinyl plastic on the interior. The area of the Shower and Locker Buildings is 2275 square feet.

The entrance and foyer facilities are reduced to a minimum consisting of a covered area with a Cashier's Booth and turnstiles for the control of traffic.

A concession building is provided and is accessible to both bathers and spectators. This area is enclosed in fences to prevent papers and debris from entering the pool area. It is expected that this concession will yield part of the necessary funds for the maintenance and operation of the pool.

The bids for this project were received March 10, 1953, and it is now in construction. It is expected to be ready for use approximately August 1, 1953.

Drawing of exterior view showing entrances at right and left of center.



This project was bid in two parts consisting of the swimming pool as one contract, and the buildings as another contract. It was felt that lower bids were obtained in this way and that the successful bidders would be better qualified contractors for their particular contract. This is because the contractors engaged primarily in pool construction are reluctant to bid on projects which include both

pool and buildings. On the other hand, few General Contractors are qualified in the specialized technique of swimming pool construction. Therefore, by permitting each contractor to bid that portion with which he is most familiar, lower bids were obtained. The contract for the swimming pool is approximately \$56,000.00 and the contract for the buildings is approximately \$57,000.00.

**Overhead  
View**

**Showing relative  
location of administration  
facilities, diving boards,  
sun bathing and varying  
pool depths.**

*Photos by  
LeeMac Studio.*

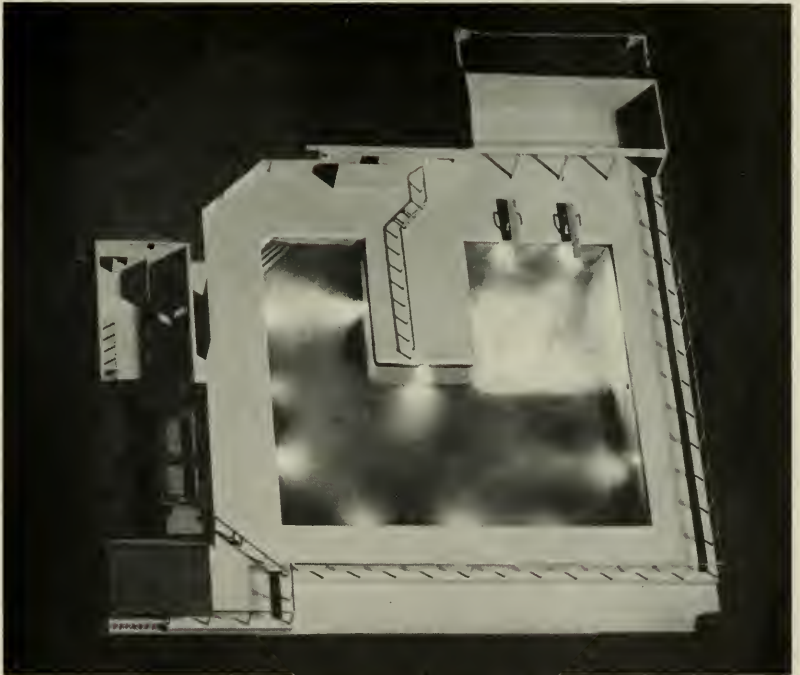



Showroom with glass front and anti-sun glare louvered canopy.

# CADILLAC

## STONESTOWN AGENCY

### SAN FRANCISCO, CALIFORNIA

ARCHITECTS: WELTON BECKETT and ASSOCIATES

60,600 Square Feet

Latest addition to the beautiful new Stonestown Shopping Center just off 19th Avenue in San Francisco, is the elegant Cadillac showroom and service department.

Designed by Welton Beckett and Associates, the showroom and business offices of Stonestown Cadillac, located at 20th Avenue and Buckingham Way, are as pleasing to the eye and as functional



• • • CADILLAC GARAGE

in planning as can possibly be styled in the charming California contemporary design that is evident throughout the shopping center.

This eye pleasing appearance of the building has been carried out through the effect of colors, lighting, large areas of glass and a general easy flow of design.

Pastel shades of green, red, brown, and beige adorn the outer and inner walls and fixtures. Most evident of these is a soft Nile green covering the wall running opposite the showroom entrance. This color is used again in the two large neon signs over the entrance and along the side of the building. The signs spelling out Cadillac in script writing are extremely effective at night along with two others of the gold Cadillac crest over gold V symbols bordered by red neon.

Glass enclosed on two sides, the showroom has approximately 3,600 square feet of floor space and

can adequately display five Cadillacs in any positions desired.

The floor is laid out in red quarry tile, which has durability and can be easily maintained.

The facade is predominantly glass. The west wall, 65 feet in length, is glass as well as the entrance doors. Aluminum division bars support the glass and aluminum frames enclose the glass doors. The glass facade has an appearance of smooth sleekness, complementing lines of the cars visible through it.

The south wall features 40 feet of glass running approximately two-thirds the length of the wall, the remainder is brick. The glass is free standing, steep pipe columns support the structure overhead.

The showroom and office ceilings the made of Cane fibre, sound absorbing, random perforated material with a noise reduction co-efficient of .63. The ceilings are basically a neutral color. Whether

**Attractive red quarry tile flooring, recessed lighting, sound absorbent ceiling and pastel colors highlight the interior of the spacious new Cadillac showroom.**

*(Photos on this and opposite page by Moulin Studios.)*



## CADILLAC GARAGE . . .

planned by design or not the showroom ceiling takes on a soft blended hue of red and green due to a reflection from the floor and walls. This reflected color tends to break up any monotony often prevalent in ceilings covering large areas.

Choice of lighting for the showroom and the building in general is excellent. Eight foot long recessed slimline fluorescent troffer lights are spaced on the ceiling with 32 square incandescent fixtures. The slimline lighting has a corning low brightness lens cutting glare and also giving economy and presenting clean graceful lines.

A soffit running the length of the west side of the building just above the glass wall holds a battery of 300 watt eye ball spot lights intermittently spaced with more square incandescent fixtures. The spots can be made adjustable to suit the desired car display.

A fourth type of lighting is used in the manager's office. In addition to slimline fluorescents there are five R-40 louvered spot lights that give added effect to any pictures or displays in the room.

Adding to the comfort of customers and employees is the latest combined heating and air-condition unit with modern overhead diffusers.

Looking at the building from the outside one immediately notices the louvered wooden canopy covering the length of the two glass fronts. In addition to the striking effect it gives the building, the canopy serves the functional purpose of cutting sun glare on window displays and supports the illuminated Cadillac signs.

Landscaping follows the contemporary California theme with two large palm trees at the north end of the building surrounded by lawn. Between the red brick walk and the front of the building

**View of east customer entrance and exit to 57,000 square feet of modern automobile service facilities.**

*(Photos by John Black and Associates.)*



are other tropical plants.

The huge new service department is located just across 20th Avenue in the magnificent Medical Dental Building that features outside walls of red brick, slab rock, and concrete.

The service department occupies the two lower floors of the building, an approximate area of 57,000 square feet. Easily accessible through two separate entrances, one for customers and one for service testing, the service department is one of the largest enclosed automotive service areas in the west and is considered excellent in its functional layout.

Space arrangement makes it possible to receive, service and deliver cars with utmost speed and no congestion whatever. The reception area just inside the customer down ramp is divided from the delivery area by an island housing the service and cashier offices. There is ample space to receive 14 cars at once and parking stalls for 11 cars that are ready for delivery, all within a few feet of the customer waiting room, which itself is comfortably furnished.

There are 13 production stalls on the top floor and on both floors space is available for 26 repair stalls. In addition to interior lighting, windows have



**South Entrance and Exit  
for service testing.**

**Planned spacious reception area for  
automobile service department  
can receive fourteen cars  
at one time.**







Entrance  
to  
Lower Floor

The entrance to the lower automobile service area is protected by automatic sprinkler system for fire protection.

Top floor automobile service area — natural daylighting is emphasized together with thorough air conditioning system.



been placed in front of each of the stalls to provide better working conditions for the mechanics.

The very latest equipment is in use. Most noticeable are the lubrication facilities. The four lube racks are stationary with a sub-floor under them. With no movable parts the lube area is inexpensive to maintain, and easy to clean. A metal grating on the floor level allows ample ventilation to the men working below, who can stand upright at all times due to the convenient height of the racks. Servicemen claim that many more cars can be handled in a day with this method.

One of the most important facilities of any automobile dealership is the parts department. Much planning has gone into this department at Cadillac Stonestown. In order to give prompt service the parts manager's desk is situated at the counter, where he is available to customers and mechanics at all times. The storage area includes 48 large steel bins and 23 racks within easy reach of the parts manager. All parts with the exception of tires are handled in this well designed area under a new specialized inventory control system. There is no guess work in determining what parts are stored and the quantities of each that should be available.

Safety and working condition comfort is of prime importance. Both floors of the service area are equipped with automatic sprinkler system for fire



**Reception desk for large automobile parts department.**

prevention. In addition the department has its own air-conditioning unit keeping the building free from carbon monoxide. The paint department is equipped with a special paint spray booth, a completely enclosed drive-in room. At one end of the booth is a huge suction fan that draws out all excess paint in the air so quickly that it hardly ever hits the walls of the booth.

The beauty of design and the conveniences offered by the many new businesses in the Stoneson Development Corporation's new Stonestown Shopping Center is evident by recent statistics revealing that one-third of the shoppers visiting the area are coming from outside the San Francisco city limits.

#### **SERVICE EQUIPMENT**

**Design of the building allows installation of fast stationary lubrication racks which are easy to operate and maintain.**

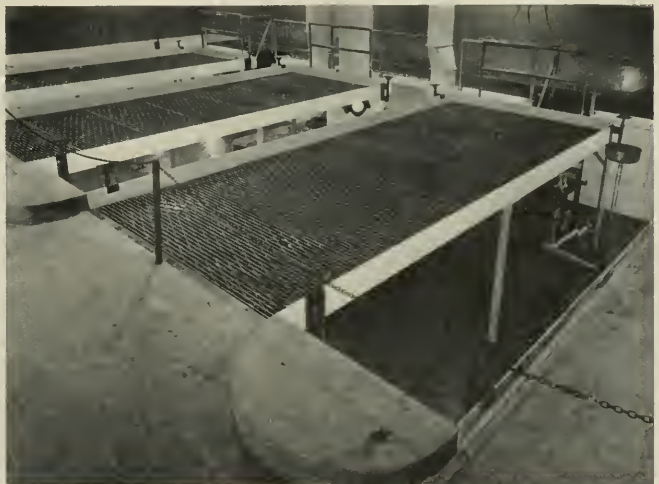

# GROUND WATER IN GRADE SLABS

## —ITS EFFECT ON FLOOR COVERINGS —ITS PREVENTATIVE

(From Page 3)

which either destroys such floor coverings or prevents their adhesion to the concrete slab altogether.

### LEVELING COURSES

Such underlayments or leveling courses as cold mastics, Masti-Dak, Neotex, etc., serve as surface sealers or water proofers to the slab while serving the purpose of a leveling course. Even magnesite finish coat flooring or base-coat flooring serves the same purpose, but as a rule is less economical. Likewise, often FLOORSTONE, SUPERSTONE or other similar materials serve the same purpose but generally are not entirely satisfactory as to permanence or cost.

Since we are limiting this discussion to grade slabs or below grade slabs, no attempt will be made to cover the subject of suspended slabs, wood subfloors, etc., in respect to the floor coverings and their behavior.

In general it can be said that linoleum, rubber, asphalt tile, vinyl tile, etc., magnesite oxychloride cement flooring, etc., can all be laid over concrete grade slabs or below grade slabs if such slabs have been waterproofed by internal membrane or cold mastics on the underside of such slabs.

It has also been observed that in many cases, linoleum, rubber tile, magnesite, vinyl tile, sheet rubber, etc., have been successfully installed over such grade slabs. Such floor coverings may have even been installed over the leveling courses of Masti-Dek, Neotex, cold mastic, etc., provided the ground waters and moisture have been entirely eliminated. While magnesite floors are less affected by such moisture, they are not immune to it.

Several instances come to mind over the years that often disprove theories on the subject of grade slab moisture.

### HYDROSTATIC PRESSURE UNDER THE SLAB

In the Mission District of San Francisco a magnesite floor job was installed over a grade slab during the dry season. Some four years later during a heavy season of rainfall, a spot approximately four feet by four feet became damaged and buckled from pressure of ground water under the slab. This "spot" was replaced and the flooring problem ceased thereafter, even when covered and blanketed with asphalt tile.

### SWEATING CONCRETE

Such an instance is recalled in Oakland where the slab was at an elevation of approximately 12" above ground level and rested on a gravel fill

between concrete foundations. Evidently capillary attraction carried the moisture through the gravel fill and concrete slab to the magnesite floor topping for it disintegrated badly and the entire floor area became loose. The presence of water was noted over the entire surface of the concrete slab.

There after the top surface of the concrete slab was cleaned, case hardened concrete steel nails driven in approximately every 3" to 6" each way allowing the heads to project approximately 1/4". The entire surface was then swept clean and asphaltic cutback primer applied thereover. Thereafter, a 1/2" to 3/4" coat of finish magnesite flooring was applied and sealed.

The magnesite floor was a good floor and served its purpose for some twenty years after. There are other instances of water passing through grade slabs with hot coat asphalt and three ply membrane each hot coated or mopped down. I recall a grade slab in Berkeley near the bay where the slab rested on top of the ground near the street 6" above ground with the rear end of the slab some two to four feet above the ground. This slab had been hot coated with asphalt and three plies of thirty pound saturated roofing felt mopped down with overlapping seams. Thereover, 3/16" or 6 mm. battleship linoleum was cemented down to the felt. This was considered a well water-proofed slab and no trouble was anticipated at the time of installation.

A few years later the linoleum rotted and water would spurt up in places at the seams when stepped on. The entire three plies of felt and linoleum had to be removed and replaced with asphalt tile. It was found that the water under the slab had worked its way up through the concrete slab and dislodged the hot asphaltic coating under the felt in a very large area. The hot coat had flaked and peeled off and was no longer effective.

The residue "hot coat" was dissolved, cleaned off and then replaced with a regular cutback asphaltic primer, whereupon an asphalt tile job was laid with cutback asphalt adhesive with permanent good results.

### CONCRETE SLABS—

#### On Grade Without Membrane:

In highly arid locations and where the ground slopes away from the building site location—say desert country—slabs are often of the (1) plain poured concrete type. (2) Such grade slabs are often of the so-called dense, waterproof type of formulation where admixtures are employed and the mix well compacted to a dense close grained mass and where moisture cannot penetrate the concrete once it is set up hard, such as reinforced



concrete successfully used in water tank construction, but in each case such slabs must be placed approximately at a minimum height of 12" above ground level at the highest point of ground elevation at the building site and on a crushed rock or gravel fill within the building foundation confines.

In semi-arid or farming communities or cities or industrial communities near bodies of water, rivers, canals, etc., of approximately the same elevation, such grade slabs should have a membrane (1) within the slab (between two sections of the slab) or slab should be (2) laid on a cold mastic layer approximately 1" thick or more. In each case a crushed rock fill or gravel fill within the building foundation confines should be provided. A sand bed layer on top of the crushed rock or gravel fill should be placed and the whole compacted by heavy rollers or other appropriate means before the (1) membraned slab or (2) the cold mastic layer applied. Hot street paving may be substituted for the cold mastic and rolled and compacted with street paving equipment. Where such mastics are used below the slab, it is optional whether a bed of sand approximately 1" or more be applied level over such mastic bed before the concrete slab is laid. The concrete slab in each case should be properly reinforced in accordance with commonly accepted building practice. In cases such as when No. 1 or No. 2 methods are employed, provision should be made for waterproofing the vertical surfaces against which the slab butts on all sides so that the effectiveness of the waterproofing is carried up or above the surface of the slab.

### **"FLOATING GROUND"**

In communities where subsoil is supersaturated with water to such an extent that the ground may be unstable or practically in a condition known as "floating ground" or constantly sinking, it may be necessary to drive piling in the floor spaces as well as the foundations before pouring concrete, and under such circumstances it is advisable to pour a section of concrete slab over the piling, then apply a heavy membrane well cemented in place with hot asphaltic cement. Such membrane must be either a non-rotting asbestos asphalt saturated felt or woven glass fabric or similar material in two or more plies, each ply hot coated down, after which the top section of the concrete slab is poured as specified for the job. The entire slab should be of steel reinforced construction in accordance with specifications for the job and/or commonly accepted standard construction practice.

In each of the foregoing instances the finish given the top surface of the slab will depend upon the requirements of the job or floor covering to

be used. While such foregoing information is contained in construction manuals, textbooks, and other sources of construction information, we do find such questions arising either before or after a job is installed in practice. No designer of a building likes to admit a mistake in the ground slab after a building has been erected and often resorts to finding fault with the work of the general contractor or his subcontractors, often resulting in litigation or to say the least "ill feeling." Usually a careful approach to such problems will reveal a solution thereof.

Often the foregoing slabs will well serve the purpose if finished by smooth trowelling for asphalt tile, grease proof tile, mastipave, the various types of approved underlayments or leveling course materials such as cold mastics, Masti-Dek, and/or other types such as latexes, Neotex, etc., and in some cases even linoleum, rubber tile, etc., if moisture has been positively eliminated.

Such slabs are usually finished to a rough texture by rodding or floating for ceramic tile, non-rotting composition sleepers (Unibond Sleepers), etc., and the levels corrected either in the sand bedding for the tile or in the levels of the sleepers receiving the wood flooring for gymnasiums or dance floors, etc.

Note: Wood sleepers of late years, whether treated with preservatives or not, have generally proven unsatisfactory and less permanent without sufficient compensating saving in cost.

Wood blocks for industrial floors as well also as parquet wood tile may either be laid on top of a leveling course over the concrete slab using a mastic adhesive or they may be laid over a concrete slab on which hot or cold mastic has been applied as an adhesive and which also may serve as a seal against moisture coming through the concrete slab on occasions. There are also cold mastic adhesives used for the same purpose as the hot asphaltic adhesives.

(To be continued)

---

### **FEDERAL GOVERNMENT SEEKING ARCHITECT**

An examination for architect has been announced by the United States Civil Service Commission to fill various vacancies in Federal agencies in Washington, D. C. and vicinity.

The positions range in pay from \$3,410 to \$10,800 per year. No written test will be given. To qualify applicants must have had appropriate education or experience.

Applications will be accepted until further notice and must be filed with the Executive Secretary, Central Board of U. S. Civil Service Examiners, Veterans Administration, Washington, D. C.

# KRAFTILE DISTRIBUTORS DEMONSTRATED TECHNIQUES

## OF LAYING PATIO TILE

Dealers and distributors of Kraftile (Niles, California) products were recently given a practical demonstration of the techniques of laying Patio Tile, when company officials and dealers observed the firm's annual Dealer-Day. A conducted tour of the manufacturing plant was also observed.



**POURING BASE**  
Mix is poured onto prepared ground area. Edge boards in place to hold mix.



**LEVELING BASE**  
"Screeding" the mix to assure proper over-all depth.



**SPREADING SETTING BED**  
After foundation has set,  $\frac{3}{4}$ " of bedding mortar is spread smoothly with a trowel.

#### SETTING TILE

Showing how damp tile is bedded. Each tile is gently tapped in place until firmly in position. Use of straight edge and level help get smooth, level job.



#### APPLYING MORTAR FOR JOINTS

Joining mortar (3 parts sand to 1 part cement, or, for exceptionally smooth joints, 2 parts sand to 1 part cement). Dry materials are mixed thoroughly, water added until mixture flows or pours.



#### SWEEPING MORTAR INTO JOINTS

Broom is used to sweep mortar into joints until all are full to top of tile.



#### APPLYING MINWAX SEALING COAT

Final. When tile has become dry, apply Minwax for sealing coat. This prevents staining, makes surface easy to clean and prepares for waxing, if desired. For best penetration, Minwax should be slightly heated and applied when tile surface is warm.







Glenn Stanton, President  
 Kenneth E. Wischmeyer, 1st Vice-president  
 Norman J. Schlossman, 2nd Vice-president  
 Clair W. Ditchy, Secretary  
 Maurice J. Sullivan, Treasurer

National Headquarters—  
 1741 New York Avenue, N. W.  
 Washington, D. C.  
 Edmund R. Purves  
 Executive Secretary

**Arizona Chapter:**  
 Lew Place (Tucson), President; Ralph Haver (Phoenix), Vice-President; Fred O. Knipe (Tucson), Secretary; James W. Elmore (Phoenix), Treasurer. Secretary Offices, 1324 E. Lester St., Tucson.

**Coast Valleys Chapter:**  
 Kurt Gross, President; Harold Ahnfeldt, Vice-President; Frank C. Treseder, Secretary; Jerome Kasavan, Treasurer. Directors, Hollis Logue and Gifford Sobey. Offices, 82 S. 3rd St., San Jose.

**Central Valley of California:**  
 John W. Bomberger, President; Nicholas Tomich, Vice-President; Albert B. Thomas, Secretary; Ted de Wolf, Treas.; Gordon Stafford, Director; Alternate to CCA, Silvio Barovetto; Sec. Office 718 Alhambra Blvd., Sacramento.

**Colorado Chapter:**  
 James M. Hunter, President, 2049 Broadway, Boulder; Casper F. Hegner, Secretary, 1659 Grant Street, Denver 5.

**East Bay Chapter:**  
 Malcolm D. Reynolds, President; Donald Hardison, Vice-President; John Lloyd, Secretary; Ed Cerruti, Treasurer. Directors: Chester Treichel, Ira Beals, Cecil Moyer. Secretary's office: 1171 Solano Ave., Albany.

**Idaho Chapter:**  
 Frederick C. Hummel, President; Jack Woodmansee, Vice-President; Jed Jones III, Sec.-Treas. Offices 1324 Idaho Street, Boise, Idaho.

**Montana Chapter:**  
 E. Edward Sawcrot, President (Billings); J. Van Teylingen, Vice-President (Great Falls); H. C. Cheever, Secretary-Treasurer. Secretary office, Bozeman.

**Nevada Chapter:**  
 Witter Zick, President, Las Vegas; Russell Mills, Vice President, Reno; Keith Lockard, Secretary, Reno; Directors Edward Parsons, L. A. Ferris, David Vhay, Reno. Office of President P. O. Box 2107, Las Vegas.

**Nevada State Board of Architects:**  
 Russell Mills, Chairman, Reno; Aloysius MacDonald, Secretary, Las Vegas; Edward Parsons, L. A. Ferris, Reno, and Richard Stadieman, Las Vegas, Members. Office, 309 S. 5th St., Las Vegas.

**Northern California Chapter:**  
 Donn Emmons, President; Wendell R. Spackman, Vice-President; William Corlett, Secretary; Bernard J. Sabaroff, Treasurer. Directors: Charles S. Pope, Wm. Stephan Allen and Lawrence A. Kruse, Helen H. Ashton, Office Sec., Office, 26 O'Farrell St., San Francisco.

## SAN DIEGO CHAPTER

Robert C. Dorland, Chief Building Inspector of the City of San Diego, was the principal speaker at the July meeting. He discussed numerous phases of the building industry in San Diego and presented a number of subjects very informally to the members in attendance.

President Donald Campbell reported on the

1953 A.I.A. Convention in Seattle, and his impressions of the Pacific Northwest. Indications were that the Convention was a great success and the country very beautiful.

New members include: Kempton Blair and Alan Daun, Junior Associates; and Carl Hotten, Associate.

Remember it's

# KRAFTILE

- for ★ GLAZED STRUCTURAL WALL UNITS
- ★ PATIO TILE
- ★ FACE AND ROMAN BRICK
- ★ ACID FLOOR BRICK
- ★ HEARTH BRICK
- ★ BRICKETTES
- ★ MINWAX TILE & CONCRETE FLOOR FINISH

For complete information and prompt service, phone or write

**KRAFTILE COMPANY**  
 NILES, CALIFORNIA NILES 3611  
 LOS ANGELES 13: 406 South Main Street—MUTUAL 7341

## OREGON CHAPTER

It has been reported that the Chapter's list of "What to See in '53" has proven well worth while in diverting architectural delegates to the Seattle A.I.A. Annual Convention to inspection of a number of "buildings" representing typical Northwest architecture.

Dick Marlitt, and committee, prepared a directional map listing 25 buildings that everyone should see and many local people have taken advantage of the opportunity to view Portland's architecture on parade.

## WOMEN'S ARCHITECTURAL LEAGUE OF SOUTHERN CALIFORNIA

The Women's Architectural League of Southern California has launched a program designated at restoration of the stained glass windows in the Chartres Cathedral.

Members of the Pasadena WAL recently made a contribution to assist in the program.

## PASADENA CHAPTER

The July meeting was the annual "BUZZ SESSION" at which the Coordinating Directors presented the members of their respective committees and outlined their general activities for the ensuing year.

Orange County Chapter:  
Paul O. Davis, (Los Angeles), President; Ralph Modjeski (Santa Ana), Vice President; Geo. Lind (Newport Beach), Secretary; Wm. L. Faulkner (Santa Ana), Treasurer. Secretary's Office: 2919 Newport Blvd., Newport Beach.

Oregon Chapter:  
H. Abbott Lawrence, President; Holman J. Barnes, Vice-President; Donald W. Edmundson, Secretary; and Robert W. Fritsch, Treasurer. Office of Secretary, 325 Henry Bldg., Portland.

Pasadena Chapter:  
Robert E. Langdon, Jr., President; Wallace C. Bonzall, Vice-President; Robert L. Deines, Secretary; Henry C. Burge, Treasurer; and Directors John N. Douglas, R. VanBuren Livingston, Scott Quintin and Burton Romberger. Offices: 259 South Los Robles Ave., Pasadena 5.

San Diego Chapter:  
Donald Campbell, President; Victor L. Wulff, Jr., Vice-President; Richard L. Pimmel, Secretary; Edward G. Holliday, Treasurer; Louis A. Dean, Director. Office Sec., San Diego Trust & Savings Bldg.

San Joaquin Chapter:  
Marice J. Metz (Fresno), President; Allastair Simpson, Vice-President; Al Bailey, Secretary; Robert Stevens, Treasurer. Directors: David H. Horn, Wm. Hyberg, Robert Kaestner, Secretary's Office, Fresno.

Santa Barbara Chapter:  
Miss Lulah Maria Riggs, President; Roy C. Wilson, Vice-President; Chester L. Carjola, Secretary; Roy W. Cheesman, Treasurer. Corres. Sec'y.: Richard B. Nelson, 3033 Calle Rosales, Santa Barbara.

Southern California Chapter:  
Henry L. Wright, President; U. Floyd Rible, Vice-President; Cornelius M. Deasy, Secretary; Savo M. Stoshitch; Hugh R. Davies, S. Kenneth Johnson, Kemper Normland and Chas. E. Fry, Directors. Headquarters, 3723 Wilshire Blvd., Los Angeles 5.

Utah Chapter:  
W. J. Monroe, Jr., President, 433 Atlas Bldg., Salt Lake City; M. E. Harris, Jr., Secretary, 703 Newhouse Bldg., Salt Lake City.

Washington State Chapter:  
Paul Thiry, President; John S. Dettlie, 1st Vice-President;

Robert H. Wohleb, 2nd Vice-President; Robert H. Dietz, Secretary; and Edwin T. Turner, Treasurer. Alice Gregor, Executive Secretary, 430 Central Building, Seattle 4.

Spokane Chapter:  
B. K. Ruehl, President; Victor L. Wulff, 1st Vice-President; Philip Keene, 2nd Vice-President; Laurence G. Ewanoff, Secretary; and Carroll Martell, Treasurer. Office 515 American Legion Bldg., Spokane, Washington.

Tacoma Society:  
E. N. Dugan, President; P. G. Ball, Vice-President; Lyle Swedberg, Secretary-Treasurer.

Hawaii Chapter:  
Kenji Onodera, President, 3518 McCarriston St., Honolulu, T. H.; George J. Wimberly, Secretary, 315 Royal Hawaiian Ave., Honolulu, T. H.

CALIFORNIA COUNCIL OF ARCHITECTS  
Charles E. Fry, President, Los Angeles; Malcolm D. Reynolds, Oakland, Vice-President; Lawrence Gentry, Los Altos, Secretary; Louis A. Dean, San Diego, Treasurer; Fred A. Chase, Executive Secretary, 3723-A Wilshire Blvd., Los Angeles.

CALIFORNIA STATE BOARD ARCHITECTURAL EXAMINERS:  
Earl T. Heitschmidt (Los Angeles), President; Geo. P. Simmonds (Oakland), Secretary; Norman Blanchard (San Francisco); C. J. Paderewski (San Diego); Ulysses Floyd Rible (Los Angeles). Exec. Sec'y.: Robert K. Kelley, 11th & Grand Ave., Los Angeles; San Francisco Office, Room 300, 507 Polk St.

#### ALLIED ARCHITECTURAL ORGANIZATIONS

San Francisco Architectural Club:  
Joseph Scoma, President; Frank S. Gerner, Vice-President; Russell W. Pennell, Treasurer; Frank L. Barsotti, Secretary. Club Quarters: 507 Howard St., San Francisco.

Producers' Council—Southern California Chapter:  
Bert Taylor, President, Pittsburgh Plate Glass Company; G. Robert Roden, Jr., Vice-President, Truscon Steel Company; Malcolm G. Lowe, Secretary, Natural Gas Equipment Inc.; Richard Seaman, Treasurer; W. Fuller & Company; Vera Boget, National Director, Gladding McBean & Co. Producers' Council—Northern California Chapter (See Special Page)

Delegates to the national A.I.A. 1953 Convention in Seattle reported briefly on the convention and Institute matters. A number of delegates to the National convention have visited Chapter officers and member architects while visiting in Southern California prior to returning to their eastern homes.

#### WOMEN'S ARCHITECTURAL LEAGUE CENTRAL VALLEY CHAPTER

The recently organized Central Valley Chapter of the Women's Architectural League held a meeting in Sacramento to hear Carl H. Ostertag, Director of Gumps Gallery of San Francisco speak on the subject "Art as an Appreciation of Our Times."

More than seventy-five women attended the meeting, and Mrs. William Koblik, president of the Chapter, announced similar program will be held in the future. Funds obtained from the activity are to be used in a scholarship to be offered by the WAL.

#### NAMED TO OREGON ARCHITECTURAL BOARD

I. G. Smith, Portland A.I.A. architect, has been named to serve as a member of the Oregon State Board of Architectural Registration, succeeding Glenn Stanton who resigned after serving for three successive terms.

#### PASADENA SCHOOL DISTRICT RAISES ARCHITECTURAL FEE

Culminating a three year effort on the part of the Pasadena Chapter of the A.I.A., the Pasadena

School District has approved a plan which will raise their approved fee for architectural service to 8 per cent. This is in conformity with a number of other school districts which have adopted the 8% architectural fee basis. The old rate was 7 per

(See Page 33)



## AVOID CORNER WALL DAMAGE

with

# Richbead

**The Patented Right Angle For  
Dry Wall Construction**

- ★ RICHBEAD gives the protection of metal to dry wall corners. Interior and exterior.
- ★ RICHBEAD saves money because it permits the use of any piece of wallboard.
- ★ RICHBEAD is easy to install — goes up fast. Richbead gives new beauty as well as protection in new construction or remodeling.

Distributed By



**CONTACT THE NEAREST P.C.A. SALES OFFICE**

SAN FRANCISCO SACRAMENTO	OAKLAND STOCKTON	SAN JOSE FRESNO
-----------------------------	---------------------	--------------------

# WITH THE ENGINEERS

## Structural Engineers Association of California

John E. Rinne, President, San Francisco; Jack S. Barrish, Vice-President, Sacramento; Leslie W. Graham, Secretary-Treasurer, San Francisco. Directors John J. Gould, R. W. Binder, M. A. Ewing, Leslie W. Graham, Jack S. Barrish, Harold P. King, W. T. Wheeler, John E. Rinne and Donald F. Shugar. Secretary's office, c/o Associated Structural Engineers, 417 Market St., San Francisco 5.

## Structural Engineers Association of Northern California

George A. Sedgwick, President; Michael V. Pregnoff, Vice-President; John M. Sardis, Secretary; William K. Cloud, Treasurer; Robert P. Moffett, Asst. Sec.-Treas.; Directors, Robert D. Dalton, Robert D. Dewell, William H. Ellison, John J. Gould and J. Albert Paquette. Offices: 417 Market St., San Francisco.

## Structural Engineers Association of Central California

William H. Peterson, President; Walter S. Wassum, Vice-President; O. T. Illerich, Sec.-Treas.; Ernest D. Francis, M. A. Ewing, and Arthur A. Sauer, directors. Office O. T. Illerich, c/o Div. of Arch., Sacramento.

## American Society of Civil Engineers Los Angeles Section

Trent R. Dames, President; Stephenson B. Barnes, Vice-President; John M. Server, Vice-President; C. Martin Duke, Secretary, and John Merrell, Jr., Treasurer. Office of Secretary, 3066 Engineering Building, University of California, Los Angeles 24. BRANCHES: Orange County Branch, Harold Sprenger, Pres; Raymond R. Ribal, V-P; Earl K. Burdick, Sec-Tr, 12311 Chapman, Anaheim. San Bernardino-Riverside Counties Branch, Albert A. Webb, Pres; Wright M. Price, V-P; John L. Merriam,

## STRUCTURAL ENGINEERS ASSOCIATION OF NORTHERN CALIFORNIA

No regular meeting was held in July, with the exception that the annual SEAONC Picnic was held Saturday, July 18th at the famed Sonoma Mission Inn near Sonoma.

Golf tournaments with Cecil Wells in charge; Art Anderson, Jr., in charge of a hot horseshoe tournament; swimming, baseball, and a full day of outdoor recreation plus a wonderful meal will go down in history as one of the most successful "picnics" yet held by the organization.

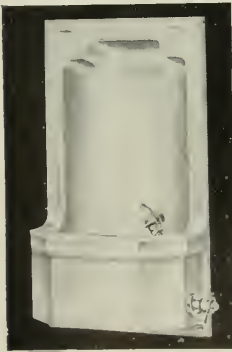

Always  
Specify  
**HAWS**  
for Highest Quality

A complete line of fountains, electric water coolers, faucets, filters and accessories. • Individual or multiple installations. • A reputation for reliability since 1909. • Check in Sweet's or write for complete HAWS catalog.

## HAWS DRINKING FAUCET CO.

1441 FOURTH STREET (Since 1909) BERKELEY 10, CALIFORNIA  
Agents and Sales Representatives in All Principal Cities

## UNIFORM "JOB" SIGN NOW APPROVED FOR ENGINEERS

A 15x25" "job sign" form has been completed and tracings are available at the offices of the local Structural Engineers Association, for use by members.

Adequate spaces have been provided for insertion of the proper title and identification of users.

It is felt by Association officials that by use of a common sign format and lettering on a state-wide basis, the position of the engineer to the project will be improved in relation to the public.

## STRUCTURAL ENGINEERS ASSOCIATION OF CALIFORNIA

John E. Finne, president of the Structural Engineers Association of California, announces that the 1953 Annual Convention will be held on October 8-10, at the Ahwahnee Hotel at Yosemite Park.

This year's convention is shaping up as another fine event that should not be missed by any engineer interested in present-day factors involving his profession. Arrangements are being made for excellent technical meetings and social events.

## STRUCTURAL ENGINEERS STATE EXAMINATION

While complete and final details are not available, it is reported that results of the last structural examination, held November 1952, 27 percent of the applicants passed successfully. Sixty-six per cent of those taking the examination failed, and seven per cent are yet undetermined.

Examinations were held in Sacramento, Berkeley, and Pasadena.

## NATIONS FOREMOST ENGINEERING WONDERS

A recent "vote" of members of the Metropolitan Section of the American Society of Civil Engineers,



Sec-Tr; 4865 Park Ave., Riverside. Ventura-Santa Barbara Counties Branch, Robert L. Ryan, Pres; Richard E. Burnett, V-P; George Conahey, Sec-Tr, 649 Doris St., Oxnard.

American Society of C. E.  
San Francisco Section

J. G. Wright, President; J. E. Rinne, Vice-President; Howard C. Wood, Vice-President; John S. Longwell, Past President; H. C. Medbery, Secretary, and Richard C. Clark, Treasurer. Office Secretary, S. F. Water Dept., Millbrae.

Structural Engineers Association of  
Southern California

Ben Benioff, President; William T. Wright, Vice-President; Charles M. Corbit, Jr., Sec-Treas. Directors: Ben Benioff, William T. Wright, Harold P. King, Henry M. Layne, Joseph Sheffet, Robert J. Kadow and Harald Omsted. Offices, 121 S. Alvarado St., Los Angeles 4.

Structural Engineers Association of  
Oregon

Lewis R. Ellingwood, President; Robert M. Bonney, Vice-President; Sully A. Ross, Secretary-Treasurer. Directors William J. Dornier, Roger V. Gillam, Leslie E.

Poole, Rowland S. Rosé. Offices 706 Board of Trade Bldg., 310 S.W. 4th Ave., Portland 4.

Society of American Military  
Puget Sound Engineering Council  
(Washington)

R. E. Kister, A. I. E. E., Chairman; E. R. McMillan, A. S. C. E., Vice Chairman; L. B. Cooper, A. S. M. E., Secretary; A. E. Nickerson, I. E. S., Treasurer. Offices. L. B. Cooper, c/o University of Washington, Seattle 5, Washington.

American Society Testing Materials  
Northern California District

L. A. O'Leary, Chairman; P. V. Garin, Vice-chairman; H. P. Hoopes, Sec. Office Sec., 1550 Powell St., Emeryville, Calif.

Society of American Military  
Engineers—San Francisco Post

CDR N. M. Mortensen, President; L. L. Wise, 1st Vice-President; Col. Paul Berrigan, 2nd Vice-President; R. M. Hamilton, Secretary; Thomas Hurley, Treasurer. Directors, RADM C. A. Trexel, J. G. Wright, LTCOL C. S. Lindsey, C. E. Bentley, F. R. Fowler, BRIGEN D. F. Johns, and RADM L. N. Moeller.

New York City, to determine the "Seven Engineering Wonders" of the world disclosed the foremost "wonder" to be the world-famed George Washington Bridge, spanning the Hudson River.

The second "wonder" is the Brooklyn Bridge. Third choice went to the Empire State Building; 4th to the New York City Subway System; 5th place went to the New York Water Supply System; 6th to the Holland Tunnel, and in seventh place was the Brooklyn Battery Tunnel.

The Golden Gate Bridge across San Francisco Bay was given mention.

AMERICAN SOCIETY FOR METALS  
PUGET SOUND CHAPTER

Reported by Howard L. Southworth,  
Boeing Airplane Company

Dr. Vsevolod N. Krivobok, head of the Stainless Steel Section of the Development and Research Division of the International Nickel Company in New York, discussed "Properties of Metals at Elevated Temperatures and the Factors Influencing Such Properties" before a recent Meeting of the Puget Sound Chapter of the American Society for Metals in Seattle, Washington.

Dr. Krivobok pointed out the impressive amount of scientific and engineering effort that has been expended in this field and the work is yet far from finished. As is still true in many fields of metallurgy, the merit of an alloy must still be evaluated by its performance in service. While most early investigations have studied the effects of temperature, temperature and stress must be studied together.

High temperature alloys can be generally classified as iron, nickel or cobalt base and using this classification, Dr. Krivobok discussed the metallurgical factors that effect the properties of such alloys. Maintenance of the original properties of

a material while in service is highly desirable.

With the exception of iron base alloys, most of the materials are precipitation hardening. Alloy additions are made to strengthen by: (1) adding strength to the matrix and changing the solubility of hardening elements; (2) influencing the size and distribution of the precipitant; (3) controlling the

(See Page 32)

# HAWS

## has the ANSWER

...for every specification requiring a public source of refreshing, sanitary drinking water.



**RESTAURANT WATER COOLERS**  
**ELECTRIC WATER COOLERS**  
**DRINKING FOUNTAINS**  
**DRINKING FAUCETS**

Single and multiple units to fit your requirements. Beauty to match the decor of any design. The utility you demand. Backed by a reputation for reliability since 1909.

See Sweets or write for the new **HAWS** Catalog

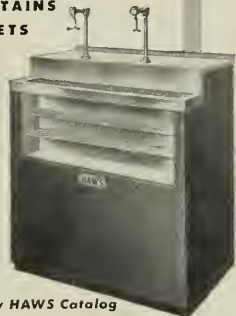

# HAWS

## DRINKING FAUCET CO.

1443 FOURTH STREET - BERKELEY 10, CALIFORNIA

# PRODUCER'S COUNCIL PAGE

The National Organization of Manufacturers of Quality Building Materials and Equipment  
(Northern California Chapter) affiliated with THE AMERICAN INSTITUTE OF ARCHITECTS

President, Roly MacNichol  
Libbey-Owens-Ford Glass Co.  
Rialto Bldg.

Vice-President, Ted Bakeman  
F. W. Wakefield Brass Co.  
445 Bryant Street

Secretary, John Cowley  
Hamilton Manufacturing Co.  
2833 3rd Street

Treasurer, Carl Frank  
Detroit Steel Products Co.  
Russ Building

Edited by Stanley L. Basterash, WESTERN ASBESTOS COMPANY.

## INFORMATION PAMPHLET

An information pamphlet is being mailed to all AIA chapters of Northern California. The membership of the Producers Council has prepared this booklet to assist those in the Building Industry Field who are charged with the responsibility of programing meetings for Architects & Engineers and Homebuilding Contractors and Architectural and Engineering students. If further information is needed please contact the Producers Council or the sponsoring company.

## WAKEFIELD BRASS EXHIBIT

The F. W. Wakefield Brass Co. went all out in presenting a very interesting program at the monthly informational meeting July 14th in San Francisco. The meeting featured demonstration of modern lighting developments from the A.I.A. Convention in Seattle including: Lighting Geometrics — Integrated Modular Ceilings — Luminous Ceilings and the 3 & 4 Way Sky Ceilings. General showings were also available for Draftsmen, Designers and all interested in new lighting developments July 15th and 16th. Ted Bakeman, who is

also our Producer Council Veep this year is to be highly commended.

We have scheduled such a fine program for future monthly informational meetings that we strongly urge all who possibly can to attend.

## ANNUAL SPORTSMEN'S DINNER

The Annual Producers' Council Golf Tournament & Sportsmen's Dinner was again a huge success. We understand Merv LaFaille of Johns-Manville sustained injury which we all hope has arrested itself to the degree that the tennis courts will again see his fine play. Harris Wilkinson, Pittsburgh Plate Glass Company, as program chairman, did a fine job arranging for the excellent dinner and the various sports activities.

## INSTALLATION NEW OFFICERS

The annual installation of new chapter officers was held at St. Julian's Restaurant at which a small but very convivial group was in attendance. G. R. "Ray" Kingsland of Otis Elevator Company was presented with a scroll thanking him for his tremendous service to the Producers' Council. This gentleman also received the much coveted "Oswald"

USE QUALITY PRODUCTS



CONSULT AN ARCHITECT

#### COUNTY HOSPITAL PLANS ADDITION

Plans are being completed by the Board of Supervisors of Shasta county for the construction of a 50-bed addition to the Shasta County Hospital in Redding. The addition will be 1-story, reinforced concrete, with basement, steel sash and linum floors. Estimated cost \$250,000. E. Geoffrey Bangs, San Francisco, is the architect.

#### NATIONAL GUARD WAREHOUSE

The Nevada National Guard is building new warehouse in Carson City, Nevada, comprising a 1-story, 50x200 ft., concrete block and frame building.

The architectural firm of Ferris & Erskine, Reno, are designing the structure.

#### HUGH KNOELL TO RESEARCH INSTITUTE

Hugh Knoell, president of the Arizona Home Builders Association, has been named to a three-man executive committee for the newly organized Mobilhome Research Institute, Phoenix, Arizona.

The executive committee will be headed by Frank Cortright, Bakersfield, California, who for 11-years was executive vice president of the National Association of Home Builders.

#### HOPPING CENTER

Being planned by architect H. W. Underhill of Los Angeles, to be built in Reseda by Shulman Bros.

It will be a two story building 600x150 ft., class B, and will cost an estimated \$1,250,000.

#### BLOOD BANK BUILDING

The San Mateo Blood Bank has awarded a contract to Williams & Burrows, General Contractors of Burlingame, for the construction of a new Blood Bank Building in Millbrae.

Stone & Mulloy and S. P. Marraccini of San Francisco are the architects.

#### SCHOOL BONDS ARE APPROVED

Qualified voters of the Bellevue Union Elementary School District of Sonoma county, recently approved issuance of special school bonds at a special election, for the construction of a new Elementary School Building to be built near Santa Rosa.

C. A. Caulkins, Jr., of Santa Rosa is the Architect.

#### SCHOOL BONDS ARE APPROVED

Voters of the Niles Elementary School District in Alameda county approved a School Bond issue of \$150,000 at a recent special election. A State Loan of \$610,000 has been applied for, with total amount of \$760,000 to be used for the construction of a new Elementary School building in Niles.

Anderson & Simonds of Oakland have been selected as the architects.

#### SAN MATEO STORE

Stevens Schenwasser & Company of San Francisco has completed plans for the construction of a new store building in the City of San Mateo. The new building will be 1 and part 2-story reinforced con-

crete frame construction with a plate glass front, and will occupy a space 50x90 feet.

Architect for the project is Irwin W. Goldstine of San Francisco.

#### NEW ARCHITECTURAL FIRM FOR PHOENIX

J. Harold MacDowell and Stefan S. Ryciak have formed a new architectural firm to be known as Associated Architects. Offices will be at 909 N. 1st St., Phoenix, Arizona.

#### FULLERTON BOYS CLUBS

Everett L. Child, architect, is completing plans and specifications for the construction of the Fullerton Boys Club in Fullerton. The structure will comprise 12,000 sq. ft.; will be part frame and stucco, and part laminated arch and post with frame and stucco filler walls.

The Anderson Trust Fund for Boys Club of America donated \$50,000 toward the

construction and maintenance of the new building.

A new and modern Shopping Center is

#### HALL OF JUSTICE BUILDING

The City of Lodi, California, is building a new 2-story, reinforced concrete and frame Hall of Justice building at an estimated cost of \$175,000.

The building will contain courtrooms and jail facilities.

Hurt, Trudell & Berger of San Francisco are the architects.

#### SACRAMENTO TITLE COMPANY BUILDS

The Capitol City Title Company of Sacramento started work recently on a new building which is being built on K-Street. Of 1-story design the building will be brick and frame construction.

Harry J. Devine, Sacramento, is the architect.

# ARCHITECTURAL PORCELAIN BY

  
**CAMEO**  
SINCE 1911

Cameo architectural porcelain makes possible dramatic and functional architecture with limitless colors and textures that never need painting or refinishing. It is light weight, rapidly constructed and life-long in any shape and any size. Write or call for complete details.



Sharp and clear, this effective tartan tower attracts prospective patrons.

ARCHITECTURAL  
DIVISION



*Metal Enameling COMPANY*  
6904 E. Slauson Ave., Los Angeles 22, California UNDERHILL 0-1268



# PERSONALITIES

## PAUL THIRY ARCHITECT, F.A.I.A.

Seattle, Washington

Architect Paul Thiry is a northerner by birth, being born in Nome, Alaska. He received his early education in the public schools and graduated from the University of Washington, Bachelor of Architecture, receiving the A.I.A. Medal and Tau Sigma Delta recognition.



PAUL THIRY  
Architect, F.A.I.A.

Before settling down to practice, Thiry made three trips to Europe and in 1934-35 made a trip around the world, including the Orient.

Paul Thiry first entered the private practice of architecture in 1929 and since that time has devoted his entire effort to his profession. He is licensed in the states

of Washington, California, Utah and is Registered with the N.C.A.R.B. His scope of work has covered the fields of site development and community planning, and most categories of building. He has recently completed construction of the Museum of History & Industry for the Seattle Historical Society; the Charles & Emma Frye Free Art Gallery, Seattle; a dormitory for 400 women at the State College of Washington at Pullman, and a building for the United States Army Engineers.

In addition to architecture, Paul Thiry is recognized in the field of literature and is co-author with Richard Bennett and Henry Kamphoefner of a book on CHURCHES and TEMPLES, published by the Reinhold Publishing Company. Many articles written by Thiry have appeared in books and periodicals throughout the United States, England, Italy, Norway, Spain, Japan and Argentina. Recognition has also been received in the field of furniture and carpet design and also fabric design.

Elected Fellow of the A.I.A. for achievement in Design in 1951, Paul Thiry was also decorated an Officer d'Academie by France in 1950.

*NEXT MONTH: Scott Quintin, A. I. A., Alhambra, California.*

## WITH THE ENGINEERS

(From Page 29)

grain size. Dr. Krivobok discussed the effects of variations in these factors on the important engineering properties such as creep and rupture strength and emphasized that small variations often exert a large influence which may not be predictable. Properties of alloys during service are also greatly effected by prior history of fabrication and heat treatment even though variations in these may result in alloys with essentially the same room temperature properties.

There is great need to find a room temperature property that will correlate with high temperature performance.

NE-2661

MERCURY INCANDESCENT ASSEMBLY

INDUSTRIAL INCANDESCENT & FLUORESCENTS OF ALL TYPES

MASTER

STANDARD DOME

ILLUMINATION EQUIPMENT, INGLEWOOD, CALIFORNIA  
BRANCH OFFICE AND WAREHOUSE SAN FRANCISCO

N  
look to.....  
E

**SMOOT-HOLMAN**

.....for quality  
W  
S



University  
Laboratory  
Tables

Berkeley, California

Manufactured and  
Installed by

## THE FINK & SCHINDLER CO.

Since 1882

552 Brannan Street San Francisco, Calif EXbrook 2-1513

## A.I.A. ACTIVITIES

(From Page 27)

cent.

According to Culver Heaton, Pasadena architect, who spearheaded the campaign for the new rate, the new contract will benefit the school district as architects will now be able to pay the standard engineering fees required by the outstanding structural and mechanical firms.

## WOMEN'S ARCHITECTURAL LEAGUE OF THE EAST BAY

The Women's Architectural League of the East Bay recently contributed the sum of \$350 to the Architecture Traveling Scholarship Fund of the University of California, Berkeley.

The award is made every seven years to an outstanding architectural student. Last year the East Bay Chapter WAL contributed \$1,000 to the same fund.

## OUTSTANDING ARCHITECTURAL STUDENTS AWARDED PRIZES AT UC BERKELEY

Twenty architectural students of the Berkeley campus of the University of California, were awarded various prizes for outstanding achievements at the recent opening of the annual exhibition of the School of Architecture.

The exhibition of student work and conferring of awards is held in cooperation with the Department of City and Regional Planning, Department of Art, Decorative Arts Department and Landscape Architecture Department of the University.

Among those receiving awards this year were: Richard Lareau, San Diego, Architectural Association award; Bertram Berenson, San Diego, Alpha Rho Chi Medal; Don McCarty, La Honda, The American Institute of Architects Medal.

Medals of the School of Architecture were awarded to Wayne Bowker, San Francisco; Ralph Eissman, La Crescenta; Jordan Hall, Berkeley; Donald Honer, Santa Ana; Barnard Johnson, Richmond; Sooky Lee, Sacramento; James Matthews, Los Angeles; Donald Thaden, Sacramento; Gary Tucker, Burbank; Mireya Urdaneta, Berkeley; Richard Zahm, Menlo Park.

Chi Alpha Kappa Prize in Architecture: lower division, Howard Leach, Sutter Creek; upper division, Guy O. Anderson, El Centro; Kenneth Foster Strong Memorial prize, Bernard B. Zimmerman, Los Angeles; Women's Architectural League of San Francisco, \$200 prize to Paul Wilson, San Francisco.

The Producers' Council, Incorporated, San Francisco branch, awarded a prize of \$50 for books to Robert Fisher, senior from Sacramento, who will a graduate student in the fall semester. Fisher



For LONG LASTING BEAUTY  
in the Swimming Pool...

Specify Protective

**RAMUC  
ENAMEL!**

- ✓ 9 beautiful sunfast colors
- ✓ Looks like—feels like tile
- ✓ Waterproof rubber base
- ✓ Won't crack or peel
- ✓ Resistant to heat and cold

Lasts far longer, looks far better than ordinary swimming pool paints. DESCRIPTIVE specification details available to architects, contractors, engineers.

Write Dept. A.E.



## Summerbell for CHURCHES



SUMMERBELL glued laminated arches and beams give the Architect the widest latitude in designing for the modern or the traditional...for the large cathedral or the small chapel. In addition to their lasting beauty, they provide structural advantages which effect substantial economies in overall costs. Write for illustrated brochure.

Methodist Church,  
Sherman Oaks, Calif.  
Architects,  
Frick & Frick,  
General Contractors,  
J. H. Baum & Sons.

Glued Laminated Construction • Summerbell Bowstring Trusses  
Lomella Roofs & All Types of Timber Structures

For quality, economy and satisfaction, specify SUMMERBELL

**Summerbell ROOF STRUCTURES**  
825 EAST 29TH STREET • BOX 218, STATION "K" • LOS ANGELES 11

Any contour, shape or design attainable in steel may be similarly achieved with **PORCELAIN ENAMEL on steel**. And note the perfection of texture, of fit, of erection, in this typical installation. When you specify **PORCELAIN ENAMEL VENEER**, you assure craftsmanship from layout through lay-up.



Architectural Design  
Bank Planning Division  
CAPITAL COMPANY, San Francisco  
L. J. Hendy, Architect

WRITE, TODAY, FOR FACT-FILLED BROCHURE!

*Architectural Division*

**PORCELAIN ENAMEL PUBLICITY BUREAU**  
P. O. BOX 186, EAST PASADENA STATION, PASADENA 8, CALIFORNIA  
ROOM 601, FRANKLIN BUILDING, OAKLAND 12, CALIFORNIA

**REDUCE TILT-UP  
CONSTRUCTION COSTS**

with  
**Thompson's  
WATER SEAL**



for surface slabs  
and tilt-up panels

- Locks out moisture, acts as bond breaking agent.
- Permits easy lifting of panels without suction.
- Eliminates hairline cracks for smoother concrete surfaces.
- Gives slower, more uniform curing.
- Protects against seepage, prevents efflorescence.

**MANY OTHER CONSTRUCTION USES:**

For lasting protection against moisture, use Thompson's Water Seal for plywood forms, concrete blocks, brick, tile, stucco, plasterboard and any other porous material. Sold in 1, 5, 30, 55 gal. sizes. Ready to use — no mixing. Applied easily by spraying, brushing, mopping or dipping.

Available at paint, hardware or building supply dealers.

**BY-CHEMICAL PRODUCTS CO.**

1355 Market Street • San Francisco 3, California

was also runner-up for the American Institute of Architects medal.

The Mario Ciampi Prize of \$200 for the winning design submitted as a special problem in high senior design was awarded to Sooky Lee, who also received a School of Architecture medal.

Edward J. Maher, of the architectural firm of Blanchard and Maher, San Francisco, gave a \$500 prize to Francis Evans Jones, Jr., Richmond. Jones will attend graduate school in the fall.

The prize of the Northern California chapter, American Institute of Architects, went to Barnard Johnson, Richmond, also recipient of a School of Architecture medal.

**JOSAM MANUFACTURING COMPANY  
RECEIVES A.I.A. HONOR AWARD**

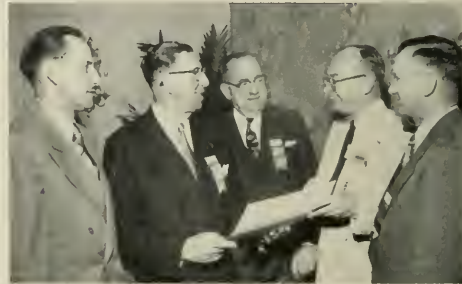

Accepting the A.I.A. Award at the Seattle Convention of The American Institute of Architects are: Representatives of M. Greenberg's Sons - Wayne James (left), Portland, Ore., manager; Stuart N. Greenberg, President, M. Greenberg's Sons - Josam Pacific Co. (Western Division of Josam Mfg. Co.); Elmer K. Ross, Manager of Sales; Richard M. Bennett, Chairman of the Awards Committee of the A.I.A.; and Robert Chandler, Seattle Manager.

A record unequaled by any other firm in its field was established by the Josam Manufacturing Company when they were awarded their second successive award from The American Institute of Architects, Awards Committee, during the Seattle national A.I.A. convention.

The award was given for excellence in preparation and presentation of the Josam Drainage Catalog "K", which was distributed during the year to architects, engineers, contractors and others interested in the construction industry. This was the second time the Josam firm received this award, as it was given to them last year in recognition of their Catalog "J."

**SWIMMING POOLS**

(From Page 8)

stiff malleable fittings should lock the chute, platform, safety handrails and supports into a strong integral unit.

Thriller slides always make a big hit with young and old. Constructed with either 20 or 30-foot steel



chutes, they plunge bathers into the water to depths of about three and a half feet at an exciting, yet completely safe speed. Safe features should include a spacious, completely enclosed tower platform, non-slip stair treads, slant-type stairway with safety handrails and chute guardrails at the top to permit bathers to position themselves properly before descending.

Where space is available, a swimming pool or bathing beach may add to its pulling power by installing a children's playground, equipped with swings, slides, see-saws, merry-go-rounds and castle tower climbing structure. Some operators might wish to cater to the family trade by installing picnic grills, tables and other picnicking facilities.

One of the important factors in the revenue-producing phase of swimming pool operation is the checking system, which safeguards the patrons' clothes and other personal belongings. It is also the method by which swimming pool admission fees are collected.

Checking baskets should be ruggedly built to deliver years of perfect service, and should be equipped with large number plates with 1/2" black enamel numerals. Companion piece is the checking pin, made of spring brass and heavily nickel-plated, with numbers embossed on the large hood.

Another essential piece of equipment is the steel basket rack, which provides compact shelving for orderly and sanitary storage of checking baskets and their contents. The rack should be equipped with padlock hasps and number plates.

Good seating is needed in the dressing room. Other pool accessories include umbrellas, rubber diving bricks and bicycle racks.

#### Care of Diving Boards

Here are some tips on the care of your official regulation boards:

Install your boards properly. First, make sure that all members of your diving stand are properly aligned and that your fulcrum is aligned and perfectly level with the floor. Second, locate your fulcrum correctly: For a 12-foot board, a distance of 6 feet from the anchored end of the board is recommended; for a 14-foot board, 6 to 7 feet; and, for a 16-foot board, 8 feet. Finally, make sure that the base of your board and fulcrum are aligned and perfectly level; then, bolt the base of your board securely to the stand.

\* Use a regulation style fulcrum. Either a standard bar-type or a rocker-type fulcrum will assure good diving board performance, providing the fulcrums are properly designed and covered with a heavy thickness of live, resilient rubber to absorb the shock of the board when in use. While American has made the conventional bar-type for the past four decades, we recommend the new patented

(See Page 38)

## FORDERER CORNICE WORKS

Manufacturers of

Hollow Metal Products • Interior Metal Trim  
Elevator Fronts and Cabs  
Metal Plaster Accessories • Sanitary Metal Base  
Flat and Roll Metal Screens  
Metal Cabinets • Commercial Refrigerators

269 POTRERO AVE.

SAN FRANCISCO, CALIF.

HEMLOCK 1-4100

## BARRETT & HILP CONTRACTORS

*Serving The Construction Field  
Since 1912*

OUR FORTIETH YEAR

918 Harrison Street • San Francisco  
Telephone DOUGLAS 2-0700

## Parker, Steffens & Pearce

BUILDERS

135 South Park, San Francisco

Phone: EXbrook 2-6639

## CLASSIFIED ADVERTISING

Do YOU want to hire, buy, sell, rent, find, lose, and otherwise transact business with others in the Construction Industry? If so, your best bet is a CLASSIFIED ad in ARCHITECT & ENGINEER magazine.

SELL that used equipment at a good price; secure competent employees; buy good used equipment; obtain information on wanted materials, etc.

Rates are low 20 cents per word—cash with order—minimum 3 lines. "Position Wanted" ads are half-rate. Forms close 20th of month preceding date of publication.

ARCHITECT & ENGINEER  
MAGAZINE

68 Post Street

San Francisco

# HOGAN LUMBER CO.

Wholesale and Retail

## LUMBER

MILL WORK • SASH & DOORS

Office, Mill, Yard and Docks

SECOND AND ALICE STREETS • OAKLAND, CALIF.

Telephone GLencourt 1-6861

# HAAS and HAYNIE

Formerly Haas Construction Company

Since 1898

275 PINE ST.

SAN FRANCISCO, CALIF.

Phone DOuglas 2-0678

# JUDSON PACIFIC - MURPHY CORP.

Steel Fabricators  
and  
Erectors

REINFORCING STEEL  
STRUCTURAL STEEL  
BRIDGE CRANES

4300 EASTSHORE HWY.  
EMERYVILLE, CALIF.

Phone:  
OL 3-1717

# CLINTON CONSTRUCTION CO. OF CALIFORNIA

General Contractors

923 FOLSOM STREET • SAN FRANCISCO

SUtter 1-3440

## BOOK REVIEWS PAMPHLETS AND CATALOGUES

**READING LIST ON HOUSING in the United States.** Housing & Home Financing Agency. U. S. Government Printing Office, Washington, D. C. Price \$1.5.

A newly revised issue of the "Reading List on Housing in the United States" containing 43-pages. Included in the bibliography are current publications of the Housing & Home Finance Agency and its constituents, the Federal Housing Administration, and Public Housing Administration, as well as materials from the lists of other Federal agencies and of private publishers. Appendices list housing periodicals and legislative documents relating to housing.

Subjects such as "Readings for the Prospective Home Owner," "Cooperative-Mutual-Nonprofit Housing," "Home Building as a Business," "Remodeling and Maintenance," "Rental Housing," and "Housing Finance" are covered. Orders should be sent to the Super. of Documents, U.S. Printing Office.

**SIMPLIFIED DESIGN OF ROOF TRUSSES—For Architects and Builders.** 2nd Edition. By Harry Parker, M.S. John Wiley & Sons, Inc., 440 4th Ave., New York 16. Price \$4.00.

Primary purpose of 1st edition by author Harry Parker, M.S., professor of Architectural Construction at the University of Pennsylvania, was to present in a concise manner the basic principles and methods underlying the design of structural members used in building construction. The new edition embodies all of the material contained in previous editions and adds considerable material which explains in detail the necessary steps in the design of both steel and timber roof trusses. New tables have been introduced and examples and figures have been altered and supplemented so that the design procedure is in agreement with current practice.

**THE ARCHITECT IN PRACTICE.** By Arthur J. Willis, F.R.I.C.S., HON. F.I.Q.S. and W. N. B. George, B.ARCH., A.R.I.B.A., A.M.T.P.L., Crosby Lockwood & Son, Ltd., 39 Thurlow St., London, S.W. 7. Price 18/- net.

On the theory that Architecture is both an art and a business, this book is designed to help the architect with the business side of his work, to understand his responsibilities to client and contractor; to develop organising powers and business-like methods; to find his way through the maze of present-day controls and to tackle the routine specification writing and the administration of building contracts. Also contains a number of charts and forms.

Architects and builders, and students, will find this book invaluable in the conduct of their business.

## NEW CATALOGUES AVAILABLE

Architects, Engineers, Contractors, Planning Commission members—the catalogues, folders, new building products material, etc., described below may be obtained by directing your request to the name and address given in each item.

**Noise isolation bases for fans.** Vibration and noise isolation bases for fans and motors are described in detail in the new Catalog FB-802.

Designed to give the maximum help to architects, engineers, air-conditioning contractors and fan manufacturers, this catalog gives illustrations, descriptions and specifications of vibration isolation equipment manufactured by the company.

Case histories are featured. Copies of the Catalog are available from The Kortung Co., Inc., 32nd Place, Long Island City 1, New York.

**Duct insulations.** A new 16-page design data book for Fiberglass duct insulations has just been issued, contains more than 40 photographs and drawings of the various rigid and flexible Fiberglass insulations for the exterior and interior of warm and cold air ducts. A. I. A. File No. 30-A.

Included in the booklet is complete information about the new flexible duct liner, a product recently introduced to the trade. Copies of the booklet are available upon request from Owens-Corning Fiberglass Corp., Toledo, Ohio.

**Low temperature space insulation.** A new 24-page booklet entitled "Foamglas: Low Temperature Space Insulation for Walls, Ceilings, Floors," contains information about many application methods. Lists finishes, suggested thicknesses, insulation value and properties. The information is presented in an easy to read and follow fashion with many illustrative

drawings, and pictures showing actual installations. Booklet is available from the Pittsburgh Corning Corp., 1 Gateway Center, Pittsburgh 22, Pa.

**Corrosion Resistance of Copper and Copper Alloys.** The results of twenty-seven years of continuous laboratory research and field study of the nature of corrosive attack on copper and copper alloys is contained in a new 28-page booklet, first of its kind in the industry. Included is a tabulation indicating the relative corrosion resistance of the principal types of copper and copper base alloys when in contact with 183 different corroding agents. Information is given on stress-corrosion cracking, galvanic corrosion, fresh and salt water corrosion, and a section has been added on the subject of atmospheric corrosion. The booklet "Publication B-36R" is available without charge from Department A&E, The American Brass Company, Waterbury 20, Connecticut.

**Cooling tower.** A new bulletin describing all features, data and dimensions of the new Marlo "Thrifty-Tower", a small cooling tower for commercial and residential air conditioning systems, is now available. The bulletin covers all performance characteristics, and includes a data and dimension chart giving pump sizes, water flow, motor horsepower, shipping weight and dimensions on units ranging in size from 2 to 16 tons. Copies may be obtained by writing Department A&E, Marlo Coil Company, 6135 Manchester Ave., St. Louis 10, Mo.

**Vermiculite products.** A new 16-page booklet entitled "Recommended Building Code Requirements for Vermiculite Plastering, Acoustical Plastic, Fireproofing, and Concrete" includes in one booklet all recommendations covering proper requirements for vermiculite products. The recommendations are based upon standards of the American Standards Association, American Society for Testing Materials, and Vermiculite Institute. Included are simple, concise directions for using the data contained in the booklet. Building code language and several pages of line drawings make it a convenient reference for officials and agencies responsible for approval of materials and construction or writing or revision of building codes. Copies are available by writing Department A&E, Vermiculite Institute, 208 S. LaSalle St., Chicago 4, Ill.

**Weatherproof sealing ribbons.** A technical data sheet covering its EC-1202 new weather proof, water tight, synthetic rubber fabric reinforced sealing ribbons is now available. The booklet contains specifications, application methods and test results, including applications as a gasketing material as well as anti-squeak material in busses, trailers, prefabricated metal buildings, railroad cars, trucks and automobiles. Copies are available by writing Dept. A&E, Adhesives & Coatings Division, Minnesota Mining and Manufacturing Co., 423 Piquette Ave., Detroit 2, Michigan.

**Corrosion resistance of cements.** A comprehensive chart showing the resistance of seven classes of corrosion resistant cements to 297 of the most generally used corrosive chemicals is now available. The type of cement mortars listed in the chart include: Silicate, sesin type, and sulfur. Copies of the new chart may be obtained by writing Dept. A&E, Corrosion Engineering Department, Pennsalt Chemicals, 1000 Widener Bldg., Philadelphia 7, Pa.

**Cost Estimates of Brickwork.** Information in the form of cost estimates, rather than cost analyses, of brickwork has been prepared and is available to architects, engineers, and contractors. The material covers the Northern part of California, however, in general costs are 5 to 10 per cent lower in the Central valley area. Copies may be obtained by writing Dept. A&E, Clay, Brick & Tile Assn., 55 New Montgomery St., San Francisco 5.

**Quick-connect couplers.** A new pamphlet covering the subject of "quick connect, disconnect couplers" has been prepared covering the HI-FLOW line. Technical data showing size, length, diameter, weight in chart form, with illustrations of parts and uses is included. Copies may be obtained by writing Dept. A&E, Snap-Tite, Inc., Union City, Pa.

**Skydomes for daylighting.** Colored folder containing many photographs of actual installation of "skydomes" for natural daylighting of homes, offices, etc. Also data on sizes and other specifications. Available from Wasco Flashing Co., 87 Fawcett St., Cambridge 38, Mass.

**Ditching machines.** A new catalog showing all nine models of Buckeye Ditchers is now available. Well illustrated with action and still photographs it shows the many types and sizes available, their digging speeds, digging depths, widths, and other desired information. Also included is data on engines, horsepower, machine weights, and ground bearing pressures. Catalog, Form No. F-167, Gar Wood Industries, Inc., Wayne, Michigan.

**The Most Complete Line of  
STEELS and STEEL BUILDING MATERIALS  
Made by a Single Producer**



See Sweet's Catalog File or write us for full information.

**REPUBLIC STEEL CORPORATION**

GENERAL OFFICES: CLEVELAND, OHIO

DENVER, COLORADO . . . . . CONTINENTAL OIL BUILDING  
LOS ANGELES, CALIF. . . . . GENERAL PETROLEUM BUILDING  
SAN FRANCISCO, CALIFORNIA . . . . . RIALTO BUILDING  
SEATTLE, WASH. . . . . WHITE-HENRY-STUART BUILDING

**PACIFIC  
MANUFACTURING CO.**

*High Class Interior Finish Quality  
Millwork*

16 Beale St., San Francisco  
GARfield 1-7755

2215 El Camino Real, San Mateo  
S. M. 5-0687

304 Bryant Street, Palo Alto  
P. A. 3373

2610 The Alameda, Santa Clara  
S. C. 607 (Factory)

6820 McKinley Avenue, Los Angeles  
THornwall 4196

MAIN OFFICE — SANTA CLARA

**"AMERICAN - MARSH"  
CONDENSATION UNIT**

Pumping  
Machinery  
for  
Every  
Purpose

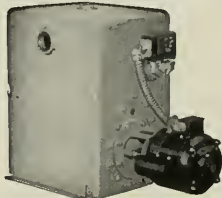

For Service  
Call  
DOuglas  
2-6794  
or  
MUtual 8322

**SIMONDS MACHINERY CO.**  
SAN FRANCISCO 816 FOLSOM      LOS ANGELES 455 EAST 4TH

**VERMONT  
MARBLE COMPANY**

**DOMESTIC AND IMPORTED MARBLES  
GRANITE VENEER**

525 MARKET STREET • SAN FRANCISCO 5

Phone: SUtter 1-6747

3522 COUNCIL STREET • LOS ANGELES 4

Phone: DUmkirk 2-7834



## INSULATION AND WALLBOARD—

Rockwool Insulation—	
(2") Less than 1,000 sq. ft.	\$64.00
(2") Over 1,000 sq. ft.	59.00
Cotton Insulation—Full-thickness	
(3½")	\$95.50 per M sq. ft.
Sisalation Aluminum Insulation—Aluminum	
coated on both sides	\$23.50 per M sq. ft.
Tileboard—4x6" panel	\$9.00 per panel
Wallboard—½" thickness	\$55.00 per M sq. ft.
Finished Plank	\$70.00 per M sq. ft.
Ceiling Tileboard	\$70.00 per M sq. ft.

**IRON**—Cost of ornamental iron, cast iron, etc., depends on designs.

## LUMBER—

S4S No. 2 and better common	
O.P. or D.F., per M. f.b.m.	\$100.00
Rough, No. 2 common O.P. or D.F., per M. f.b.m.	95.00

## Flooring—

	Per M Delivd.
V.G., D.F. 8 & 8½, 1 x 4 T & G Flooring	\$225.00
"C" and better—all	225.00
"D" and better—all	225.00
Rwd. Rustic—"A" grade, medium dry	185.00
8 to 24 ft.	

## Plwood, per M sq. ft.

½-inch, 4.0-8.0 S15	\$135.00
¾-inch, 4.0-8.0 S15	219.00
¾-inch, per M sq. ft.	292.00
Physcord	11½¢ per ft.
Physform	25¢ per ft.

## Shingles (Rwd. not available)—

Red Cedar No. 1—\$9.50 per square; No. 2, \$7.00; No. 3, \$5.00.

Average cost to lay shingles, \$6.00 per square.  
Cedar Shakes—½" to ¾" x 24/26 in handsplit tapered or split resawn, per square, \$15.25  
¾" to 1¼" x 24/26 in split resawn, per square, \$12.00

Average cost to lay shakes, \$8.00 per square.  
**Pressure Treated Lumber—**  
Wolmanized Add \$35 per M to above  
Creosoted,  
8-lb. treatment Add \$45 per M to above

## MARBLE—(See Dealers)

## METAL LATH EXPANDED—

Standard Diamond, 3.40, Copper Bearing, LCL, per 100 sq. yds., \$43.50  
Standard Ribbed, ditto, \$47.50

## MILLWORK—Standard.

D. F. \$150 per 1000, R. W. Rustic \$175 per 1000 (delivered).

Double hung box window frames, average with trim, \$12.50 and up, each.

Complete door unit, \$15 to \$25.

Screen doors, \$8.00 to \$12.00 each.

Patent screen windows, \$1.25 a sq. ft.

Cases for kitchen pantries seven ft. high per lineal ft., upper \$9.00 to \$11.00; lower \$12.00 to \$13.00.

Dining room cases, \$20 per lineal foot. Rough and finish about \$1.00 per sq. ft.

Labor—Rough carpentry warehouse heavy framing (average), \$75.00 per M.

For smaller work average, \$85.00 to \$100 per 1000.

## PAINTING—

Two-coat work	per yard 85¢
Three-coat work	per yard \$1.10
Cold water painting	per yard 25¢
Whitewashing	per yard 15¢

## Lined Oil, Strictly Pure

(Basis 7½ lbs. per gal)	Raw	Balied
Light iron drums	per gal \$2.28	\$2.34
5-gallon cans	per gal 2.40	2.46
1-gallon cans	each 2.52	2.58
Quart cans	each 72	72
Pint cans	each 32	32
½ pint cans	each 24	24
<b>Turpentine</b>		
(Basis, 7.2 lbs. per gal)	Pure Gum	Spirits
Light iron drums	per gal \$1.65	\$1.65
5-gallon cans	per gal 1.78	1.78
1-gallon cans	each 1.84	1.84
Quart cans	each 31	31
Pint cans	each 31	31
½ pint cans	each 31	31

## Pioneer White Lead in Oil Heavy Paste and All-Purpose (Soft-Paste)

Net Weight Packages	List Price		Price to Painters	
	lbs.	pkg.	per 100 lbs.	per pkg.
100-lb. kegs	\$28.35	\$29.35	\$27.50	\$27.50
50-lb. kegs	30.05	15.03	28.15	14.08
25-lb. kegs	30.35	7.50	28.45	7.12
5-lb. cans*	33.00	1.34	31.25	1.25
1-lb. cans*	36.00	.36	33.75	.34

500 lbs. (one delivery) ¾¢ per pound less than above.  
\*Heavy Paste only.

## Pioneer Dry White Lead—Litharge—Dry Red Lead Red Lead in Oil

	Price to Painters—Price Per 100 Pounds	
	100 lbs.	25 lbs.
Dry White Lead	\$26.30	\$6.50
Litharge	25.95	26.00
Dry Red Lead	27.20	27.85
Red Lead in Oil	30.65	31.30

## PATENT CHIMNEYS—

6-inch	\$2.50 lineal foot
8-inch	3.00 lineal foot
10-inch	4.00 lineal foot
12-inch	5.00 lineal foot

## PLASTER—

Neat wall, per ton delivered in S. F. in paper bags, \$17.60.

## PLASTERING (Interior)—

3 Coats, metal lath and plaster	Yard \$3.00
Keene cement on metal lath	3.50
Ceilings with ¾ hot roll channels metal lath (lathed only)	3.00
Ceilings with ¾ hot roll channels metal lath plastered	4.50
Single partition ¾ channel lath 1 side (lath only)	3.00
Single partition ¾ channel lath 2 inches thick plastered	8.00
4-inch double partition ¾ channel lath 2 sides (lath only)	5.75
4-inch double partition ¾ channel lath 2 sides plastered	8.75
Thermax single partition; 1" channels; 2¼" overall partition width, Plastered both sides	7.50
Thermax double partition; 1" channels; 4¾" overall partition width, Plastered both sides	11.00
3 Coats over 1" Thermax nailed to one side wood studs or joists	4.50
3 Coats over 1" Thermax suspended to one side wood studs with spring sound isolation clip	5.00
Note—Channel lath controlled by limitation orders.	

## PLASTERING (Exterior)—

2 coats cement finish, brick or concrete wall	Yard \$2.50
3 coats cement finish, No. 18 gauge wire mesh	3.50
Lime—\$4.00 per bbl. at yard.	
Processed Lime—\$4.15 per bbl. at yard.	
Rock or Grip Leth—¾"—30¢ per sq. yd.	
¾"—29¢ per sq. yd.	
Composition Stucco—\$4.00 sq. yd. (applied).	

## PLUMBING—

From \$200.00 per fixture up, according to grade, quality and runs.

## ROOFING—

"Standard" tar and gravel, 4 ply, \$13.00 per sq. for 30 sqs. or over.

Less than 30 sqs. \$16.00 per sq.

Tile \$40.00 to \$50.00 per square.

No. 1 Redwood Shingles in place.

4/2" exposure, per square \$18.25

5 2 N. 1 Cedar Shingles, 5 in. exposure, per square, 14.50

5 x 16"—No. 1 L Little Giant Cedar Shingle, 5" exposure, per square 18.25

4 2 N. 1 24" Royal Cedar Shingles 7 1/2" exposure per square 23.00

Roofing with Groye \$5.50 per sq.

Asbestos Shingles, \$27 to \$35 per sq. laid.

1/2 to 3/4 x 25" Resawn Cedar Shakes,

10" Exposure \$30.00

¾ to 1¼ x 25" Resawn Cedar Shakes,

10" Exposure \$35.00

1 x 25" Resawn Cedar Shakes,

10" Exposure \$22.00

Above prices are for shakes in place.

## SEWER PIPE—

C.I. 6-in. to 24-in. B. & S. Class B and heavier, per foot, \$99.50

Vitrified, per foot: L.C.L. F.O.B. Warehouse, San Francisco.

Standard, 8-in. \$ .66

Standard, 12 in. 1.30

Standard, 24-in. 5.41

Clay Drain Pipe, per 1,000 L.F.

L.C.L. F.O.B. Warehouse, San Francisco:

Standard, 6-in, per M. \$240.00

Standard, 8-in, per M. 400.00

## SHEET METAL—

Windows—Metal, \$2.50 a sq. ft.

Fire doors (average), including hardware

\$2.80 per sq. ft., size 12'x12'. \$3.75 per sq. ft., size 3'x6'.

## SKYLIGHTS—(not glazed)

Galvanized iron, per sq. ft. \$1.25

Vented hip skylights, per sq. ft. 2.25

Aluminum, puttlyless,

(installed), per sq. ft. 1.25

(unglazed and glazed), per sq. ft. 1.85

## STEEL—STRUCTURAL—

\$70 per ton erected, when out of mill.

\$350 per ton erected, when out of stock.

## STEEL REINFORCING—

\$200.00 per ton, in place.

¼-in. Rd. (Less than 1 ton) per 100 lbs. \$8.90

½-in. Rd. (Less than 1 ton) per 100 lbs. 7.80

¾-in. Rd. (Less than 1 ton) per 100 lbs. 7.50

1-in. Rd. (Less than 1 ton) per 100 lbs. 7.25

1 1/8-in. & 7/8-in. Rd. (Less than 1 ton), 7.15

1 in. & up (Less than 1 ton), 7.10

1 ton to 5 tons, deduct 25¢.

## STONE FRONTS—

Individual estimates recommended. See

ESTIMATORS DIRECTORY for Architectural Veneer (3), and Mosaic Tile (35).

## TILE—

Ceramic Tile Floors—Commercial \$1.20 to \$1.60

per sq. ft.

Cove Base—\$1.40 per lin. ft.

Quarry Tile Floors, 6x6" with 6" base @ \$1.35 per sq. ft.

Title Wainscots & Floors, Residential, 4¼x4¼", @ \$1.65 to \$2.00 per sq. ft.

Title Wainscots, Commercial Jobs, 4¼x4¼" Tile, @ \$1.50 to \$1.65 per sq. ft.

Asphalt Tile Floor ½", 3", \$ .18 - .35 sq. yd.

Light shades slightly higher.

Cork Tile—\$.70 per sq. ft.

Mosaic Floors—See dealers

Linoleum tile, per sq. ft. \$ .65

Rubber tile, per sq. ft. \$ .55 to \$ .75

## Furring

Scored F.O.B. S. F.

12 x 12, each \$ .17

Kraftite: Per square foot

Patro Tile—Niles Red Lots Large

12 x 12 x 7/8-inch, plain, \$ .40 \$ .36

8 x 12 x 7/8-inch, plain \$ .44 \$ .39

6 x 6 x 3/4-inch, plain \$ .46 \$ .42

## Building Tile—

8½ x 12-inches, per M \$139.50

6½ x 12-inches, per M 105.00

4½ x 12-inches, per M 84.00

## Hollow Tile—

12x12 2-inches, per M \$146.25

2x12 3-inches, per M 156.85

12x12 4-inches, per M 177.10

12x12 6-inches, per M 235.30

F.O.B. Plant

## VENETIAN BLINDS—

75¢ per square foot and up installation extra

## WINDOWS—STEEL—INDUSTRIAL—

Cost depends on design and quality required

# ARCHITECT AND ENGINEER ESTIMATOR'S DIRECTORY

## Building and Construction Materials

**CLASSIFICATION**—Building and construction materials are shown in major classification groups for general identification purposes with names and addresses of suppliers of materials listed in detail under group classification where name first appears—main offices are shown first with branch and district offices following. The numeral appearing in listings \*(3) refers to the major group classification where complete data on the dealer, or representative, may be found.

**FLOORS (15)**  
**Hardwood Flooring**  
**HOGAN LUMBER COMPANY**  
 Oakland: Second and Alice Sts., GL 1-6861

**CONDITIONING (2)**  
**Conditioning and Cooling**  
**LITTY APPLIANCE CORP.**  
 Angeles 58: 4851 S. Alameda St.  
 San Francisco: 1355 Market St., UN 1-4908

**STRUCTURAL PORCELAIN ENAMEL (2a)**  
**CALIFORNIA METAL ENAMELING CO.**  
 Angeles: 6904 E. Slauson, ON D1268  
 San Francisco: O'Keefe's, 55-1111 St., UN 3-4445  
**Fland: Beaver Sheet Metal & Roofing Co.,**  
 924 N. Russell St., TR 6766  
**Little: Teclar Aluminum Co.,**  
 625 Yale Ave N., SE 8494  
**Los Angeles: S. A. Roberts & Co.,**  
 109 W. 2nd South, Salt Lake 4-4431  
**Phoenix: Baker-Thomas Co.,**  
 300 S. 12th, Phoenix 4-5503  
**San Jose: Laing-Garrett Co.,**  
 19 S. Tyndall Ave., TU 2-2893  
**San Francisco: Welch-Irwin Corp.,** 1726 Lomas Blvd. NE.

**STRUCTURAL VENEER (3)**  
**Alameda Veneer**  
**ADDING, McBEAN & CO.**  
 San Francisco: Harrison at 9th St., UN 1-7400  
 Angeles: 2901 Los Feliz Blvd., OL 2121  
**Fland: 1100 S.E. Main St., EA 6179**  
**Los Angeles: 1500 First Ave. S., EL 4111**  
**Kane: 1102 N. Monroe St., BR 3259**  
**KRAFTILE \* (135)**  
**LAFFERTY TILE MFG. CO.**  
**Main Veneer**  
**RECLAINE ENAMEL PUBLICITY BUREAU**  
 Fland 12: Room 601 Franklin Building  
 Pasadena 8: P. O. Box 186, East Pasadena Station  
**San Francisco: Harrison at 9th St., UN 1-7400**  
 Angeles: 3522 Council St., OU 2-7834  
**San Francisco: Harrison at 9th St., UN 1-7400**  
 Angeles: 3522 Council St., OU 2-7834

**FINANCING (4)**  
**ROCKY MOUNTAIN NATIONAL BANK OF S. F.**  
 San Francisco, Post & Montgomery Sts., EX 2-7700

**ROOM FIXTURES (5)**  
**KRAFTILE \* (135)**  
**LAFFERTY TILE MFG. CO.**  
**LAFFERTY TILE MFG. CO. \* (135)**

**GREENBERG'S, M. & SONS**  
 San Francisco 7: 765 Folsom, EX 2-3143  
 Angeles 23: 1258 S. Boyle, AN 3-7108  
 Little 4: 1016 First Ave. So., MA 5140  
 Phoenix: 3009 N. 19th Ave., Apt. 92, PH 2-7663  
 Fland 4: 510 Builders Exch. Bldg., AT 6443

**ADDING, McBEAN & CO. \* (13)**

**KRAFTILE \* (135)**  
**REMILLARD-DANDINI CO.**  
 San Francisco 4: 400 Montgomery St., EX 2-4988

**BROWN PRODUCTS (8)**  
**GREENBERG'S, M. & SONS \* (16)**

**BUILDING PAPERS & FELTS (9)**  
**ANGIER PACIFIC CORP.**  
 San Francisco 5: 55 New Montgomery St., DO 2-4416  
 Los Angeles: 7424 Sunset Blvd.  
**PACIFIC COAST AGGREGATES, INC. \* (111)**  
**SISALKRAFT COMPANY**  
 San Francisco 5: 55 New Montgomery St., EX 2-3066  
 Chicago, Ill.: 205 West Wacker Drive

**BUILDING HARDWARE (9a)**  
**THE STANLEY WORKS**  
 San Francisco: Monadnock Bldg., YU 6-5914  
 New Britain, Conn.

**CABINETS & FIXTURES (9b)**  
**FINK & SCHINDLER, THE, CO.**  
 San Francisco: 522 Brannan St., EX 2-1513

**CEMENT (10)**  
**IDEAL CEMENT COMPANY (Pacific Division)**  
 San Francisco 4: 310 Sansome St., GA 1-4100  
**PACIFIC COAST AGGREGATES, INC. \* (111)**

**CONCRETE AGGREGATES (11)**  
**Ready Mixed Concrete**  
**PACIFIC COAST AGGREGATES, INC.**  
 San Francisco: 400 Alabama St., XL 2-1616  
 Sacramento: 16th and A Sts., GI 3-6586  
 San Jose: 790 Stockton Ave., CY 2-5620  
 Oakland: 2400 Peralta St., GL 1-0177  
 Stockton: 820 So. California St., ST 8-8643  
**Lightweight Aggregates**  
**AMERICAN PERLITE CORP.**  
 Richmond: 26th & B. St. - Yd. 2, RI 4307

**DOORS (12)**  
**Hollywood Doors**  
**WEST COAST SCREEN CO.**  
 Los Angeles: 1127 E. 63rd St., AD 1-1108  
**W. P. FULLER CO.**  
 Seattle, Tacoma, Portland  
**NICOLAÏ DOOR SALES CO.**  
 San Francisco: 3045 19th St.  
**F. M. COBB CO.**  
 Los Angeles & San Diego  
**SOUTHWESTERN SASH & DOOR**  
 Phoenix, Tucson, Arizona  
 El Paso, Texas  
**HOUSTON SASH & DOOR**  
 Houston, Texas

**Screen Doors**  
**WEST COAST SCREEN DOOR CO.**  
 (See above)

**FIRE ESCAPES (13)**  
**MICHEL & PFEFFER IRON WORKS, INC.**  
 South Linden & Tanloran Ave.  
 South San Francisco: JU 4-8362

**FIREPLACES (14)**  
**Heat Circulating**  
**SUPERIOR FIREPLACE CO.**  
 Los Angeles: 1708 E. 15th St., PR 8393  
 Baltimore, Md.: 601 No. Point Rd.

**FLOORS (15)**  
**Hardwood Flooring**  
**HOGAN LUMBER COMPANY**  
 Oakland: Second and Alice Sts., GL 1-6861  
**Flor Tile**  
**GLADDING, McBEAN & CO. \* (13)**  
**KRAFTILE \* (135)**  
**Flor Tile (Ceramic Mosaic)**  
**THE CAMBRIDGE TILE MFG. CO. \* (135)**  
**Flor Treatment & Maintenance**  
**HILLYARD SALES CO. (Western)**  
 San Francisco: 470 Alabama St., MA 1-7766  
 Los Angeles: 923 E. 3rd, TR 8282  
 Seattle: 3440 E. Marginal Way  
**Diversified (Magnesite, Asphalt Tile, Composition, Etc.)**  
**LE ROY OLSON CO.**  
 San Francisco 10: 3070 - 17th St., HE 1-0188  
**Sleepers (composition)**  
**LE ROY OLSON CO.**

**GLASS (16)**  
**W. P. FULLER COMPANY**  
 San Francisco: 301 Mission St., EX 2-7151  
 Los Angeles, Calif.  
 Portland, Ore.

**HEATING (17)**  
**S. T. JOHNSON CO.**  
 Oakland 8: 940 Arlington Ave., OL 2-6000  
 San Francisco: 585 Potrero Ave., MA 1-2757  
 Philadelphia B., Pa.: 401 N. Broad St.  
**SCOTT COMPANY**  
 San Francisco: 243 Minna St., YU 2-0400  
 Oakland: 113 - 10th St., GL 1-1937  
 San Jose, Calif.  
 Los Angeles, Calif.  
**UTILITY APPLIANCE CORP. \* (12)**  
**Electric Heaters**  
**WESTIX ELECTRIC HEATER CO.**  
 San Francisco 5: 390 First St., GA 1-2211  
 Los Angeles: 520 W. 7th St., MI B096  
 Portland: Terminal Sales Bldg., BE 2050  
 Seattle: Securities Bldg., SE 5028  
**Designer of Heating**  
**THOMAS B. HUNTER**  
 San Francisco 4: 41 Sutter St., GA 1-1164

**INSULATION AND WALL BOARD (18)**  
**LUMBER MANUFACTURING CO.**  
 San Francisco: 225 Industrial Ave., JU 7-1760  
**PACIFIC COAST AGGREGATES, INC. \* (111)**  
**SISALKRAFT COMPANY \* (9)**  
**WESTERN ASBESTOS COMPANY**  
 San Francisco: 675 Townsend St., KL 2-3868  
 Oakland: 251 Fifth Avenue, GL 1-2345  
 Stockton: 733 S. Van Buren, ST 4-9421  
 Sacramento 1331 - T St., HU 1-0125  
 Fresno: 434 - P St., FR 2-1600

**IRON—Ornamental (10)**  
**MICHEL & PFEFFER IRON WORKS, INC. \* (13)**

**LANDSCAPING (20)**  
**Landscape Contractors**  
**HENRY C. SOTO CORP.**  
 Los Angeles: 13,000 S. Avalon Blvd., ME 4-6617

**LIGHTING FIXTURES (21)**  
**SMOOT-HOLMAN COMPANY**  
 Inglewood, Calif., DR 8-1217  
 San Francisco: 55 Mississippi St., MA 1-8474

**LUMBER (22)**  
Shingles  
LUMBER MANUFACTURING CO. \*(18)

**MARBLE (23)**  
VERMONT MARBLE COMPANY  
San Francisco 5: 525 Market St., SU 1-6747  
Los Angeles 4: 3522 Council St., OU 2-7834

**METAL LATH EXPANDED (24)**  
PACIFIC COAST AGGREGATES, INC. \*(11)

**MILLWORK (25)**  
FINK & SCHINDLER, THE; CO. \*(96)  
LUMBER MANUFACTURING COMPANY \*(118)  
MULLEN MANUFACTURING COMPANY  
San Francisco: 60-80 Rausch St., UN 1-5815  
PACIFIC MANUFACTURING COMPANY  
San Francisco: 16 Beale St., GA 1-7755  
Santa Clara: 2610 The Alameda, SC 607  
Los Angeles, 6820 McKinley Ave., TH 4196

**PAINTING (26)**  
Paint  
W. P. FULLER COMPANY \*(16)

**PLASTER (27)**  
Interiors - Metal Lath & Trim  
PACIFIC COAST AGGREGATES, INC. \*(111)  
Exteriors  
PACIFIC PORTLAND CEMENT COMPANY \*(28)

**PLASTIC CEMENT (28)**  
IDEAL CEMENT COMPANY  
San Francisco: 31D Sansome St., GA 1-4100

**PLUMBING (29)**  
THE HALSEY TAYLOR COMPANY  
Redlands, Calif.  
Warren, Ohio  
THE SCOTT COMPANY \*(17)  
HAWKS DRINKING FAUCET COMPANY  
Berkeley 10: 1435 Fourth St., LA 5-3341  
CONTINENTAL WATER HEATER COMPANY  
Los Angeles 31: 1801 Pasadena Ave., CA 6178  
SIMONDS MACHINERY COMPANY  
San Francisco: 816 Folsom St., DD 2-6794  
Los Angeles: 455 East 4th St., MU 8322  
SECURITY VALVE COMPANY  
Los Angeles 31: 410 San Fernando Rd., CA 6191

**RESILIENT TILE (30)**  
LE ROY OLSON CO. \*(15)

**SEWER PIPE (32)**  
GLADDING, McBEAN & CO. \*(13)

**SHEET METAL (32)**  
Windows  
DETROIT STEEL PRODUCTS COMPANY  
Oakland B: 1310 - 63rd St., OL 2-8826  
San Francisco: Russ Building, OD 2-0890  
MICHEL & PFEFFER IRON WORKS, INC. \*(113)  
PACIFIC COAST AGGREGATES, INC. \*(11)

Fire Doors  
DETROIT STEEL PRODUCTS COMPANY  
Skylights  
DETROIT STEEL PRODUCTS COMPANY

**STEEL—STRUCTURAL (33)**  
COLUMBIA STEEL CO.  
San Francisco: Russ Bldg., SU 1-2500  
Los Angeles: 2087 E. Slauson, LA 1171  
Portland: 2345 N. W. Nicolai, BE 7261  
Seattle 1331 3rd Ave. Bldg., MA 1972  
Salt Lake City: Walker Bank Bldg., SL 3-6733  
HERRICK IRON WORKS  
Oakland: 18th & Campbell Sts., GL 1-7167  
JUDSON PACIFIC-MURPHY CORP.  
Emeryville: 4300 Eastshore Highway, OL 3-1777  
REPUBLIC STEEL CORP.  
San Francisco: 176 N. Montgomery St., GA 1-0977  
Los Angeles: Edison Building  
Seattle: White-Henry-Stuart Building  
Salt Lake City: Walker Bank Building  
Denver: Continental Oil Building  
SAN JOSE STEEL COMPANY  
San Jose 195 North Thirtieth St., CO 4184

**STEEL—REINFORCING (34)**  
REPUBLIC STEEL CORP. \*(133)  
HERRICK IRON WORKS \*(133)  
SAN JOSE STEEL CO. \*(133)  
COLUMBIA STEEL CO. \*(133)

**CLAY TILE (35)**  
THE CAMBRIDGE TILE MFG. CO.  
San Francisco 10: 470 Alabama St., UN 3-1666  
Los Angeles 19: 1335 S. La Brea, WE 3-7800  
GLADDING, McBEAN & CO. \*(13)  
KRAFTILE  
Niles, Calif.: Niles 3611  
San Francisco 5: 50 Hawthorne St., DD 2-3780  
Los Angeles 13: 406 South Main St., MU 7241

**TIMBER—REINFORCING (36)**  
Trusses  
WYERHAEUSER SALES CO.  
Tacoma, Wash.  
St. Paul, Minn.  
Newark, N. J.

Treated Timber  
J. H. BAXTER CO.  
San Francisco 4: 333 Montgomery St., DO 2-3883  
Los Angeles 13: 601 West Fifth St., MI 6294

**WALL TILE (37)**  
THE CAMBRIDGE TILE MFG. CO. \*(135)  
GLADDING, McBEAN & CO. \*(131)  
KRAFTILE COMPANY \*(135)

**WINDOWS STEEL (38)**  
DETROIT STEEL PRODUCTS CO. \*(132)  
MICHEL & PFEFFER IRON WORKS, INC. \*(113)  
PACIFIC COAST AGGREGATES, INC. \*(11)

**GENERAL CONTRACTORS (39)**  
BARRETT & HILP  
San Francisco: 918 Harrison St., DO 2-0700  
Los Angeles: 234 W. 37th Place, AD 3-8161  
DINWIDDIE CONSTRUCTION COMPANY  
San Francisco: Crocker Building, YU 6-2718  
CLINTON CONSTRUCTION COMPANY  
San Francisco: 923 Folsom St., SU 1-3440  
MATCOCK CONSTRUCTION COMPANY  
San Francisco: 604 Mission St., GA 1-5516  
PARKER, STEFFENS & PEARCE  
San Francisco: 135 So. Park, EX 2-6639  
STOLTE, INC.  
Oakland: 8451 San Leandro Blvd., TR 2-1064  
SWINERTON & WALBERG COMPANY  
San Francisco: 225 Bush St., GA 1-2980  
Oakland: 1723 Webster St., HI 4-4322  
Los Angeles, Sacramento, Denver  
P. J. WALKER COMPANY  
San Francisco: 391 Sutter St., YU 6-5916  
Los Angeles: 714 W. Olympic Blvd., RI 7-5521

**TESTING LABORATORIES (ENGINEERS & CHEMISTS (40))**  
ABDOTT A. HANKS, INC.  
San Francisco: 624 Sacramento St., GA 1-1697  
ROBERT W. HUNT COMPANY  
San Francisco: 251 Kearny St., EX 2-4634  
Los Angeles: 3050 E. Slauson, JE 9131  
Chicago, New York, Pittsburgh  
PITTSBURGH TESTING LABORATORY  
San Francisco: 651 Howard St., EX 2-1747

## CONSTRUCTION CONTRACTS AWARDED AND MISCELLANEOUS PERSONNEL DATA

**NEW HIGH SCHOOL.** Stockton, San Joaquin county. Stockton Board of Education, Stockton, owner. One-story frame and stucco Academic building with six-wings containing 38-classes, administration offices, library and toilet rooms, to be known as Daniel Webster High School, \$640,172. ARCHITECT: May, Johnson & De Wolf, Stockton. GENERAL CONTRACTOR: E. H. Moore & Son, San Francisco.  
**BANK BUILDING.** Santa Ana, Orange county. First National Bank of Santa Ana, owner. Reinforced concrete, 10,000 sq. ft., composition gravel roofing, terrazzo and asphalt tile floors, wood steel girders, plate glass aluminum framing, interior plaster mahogany paneling, terrazzo tile in lobbies, acoustic tile, terrazzo tile, asphalt concrete paving. ARCHITECT: Bennett &

Bennett, Pasadena. GENERAL CONTRACTOR: Allison Honer Co., Santa Ana.  
**SEQUOIA HOSPITAL ADDN.,** Redwood City, San Mateo county. Sequoia Hospital District, Redwood City, owner. One 4-story wing and a 2-story with basement wing; reinforced concrete, steel sash, asphalt tile and linoleum and terrazzo floors; adds 98 beds, \$966,700. ARCHITECTS: Stone & Mulloy & S. P. Marzaccini, Associate, San Francisco. GENERAL CONTRACTOR: B. & R. Construction Co., San Francisco.  
**OFFICE BUILDING.** North Hollywood, Los Angeles county. A. T. Chabon, Los Angeles, owner. Two-story stucco and reinforced brick, 44x127 ft., composition roof, asphalt tile and plywood floors, acoustic tile, interior plaster, terrazzo in lobby, plate

glass, toilets, composition and metal stairs, electrical work, \$65,000. ARCHITECT: James W. Larson, North Hollywood. GENERAL CONTRACTOR: Kersey-Kinsey Co., North Hollywood.

**WAREHOUSE.** Modesto, Stanislaus county. Turlock Cooperative Growers, Modesto, owner. One story building 40,000 sq. ft., reinforced concrete tilt-up, wood roof trusses concrete floors, \$118,963. ARCHITECT: John W. Bomberger, Modesto. GENERAL CONTRACTOR: J. Beltancourt, San Bruno.

**CHURCH BUILDING.** Covina, Los Angeles county. Church of Jesus Christ of Latter Day Saints, Covina, owner. One story, 19-room masonry church building, 11,809 sq. ft., single tile roof, steel sash, concrete slab and asphalt tile covered floors; maple floor recreation room, interior plaster, \$90,000. ARCHITECT: Montierth & Strickland.

**OFFICE BUILDING.** Brea, Los Angeles county. American Corp., Brea, owner. One-story, with part 2-story, frame and stucco with brick facade, 13,600 sq. ft. floor space, colored gravel composition roof, concrete



floor, asphalt tile covering, metal sash, acoustical work, painting, plastering, electrical work, plumbing, heating, ventilating, air conditioning. ARCHITECT: Austin, Field & Fry, Los Angeles. GENERAL CONTRACTOR: C. F. Braun & Co., Alhambra.

**RECREATION CENTER**, Oakland, Alameda county. Midway Recreation Corp., Oakland, owner. One story, 25,000 sq. ft. reinforced concrete tilt-up, wood roof, will contain 24-bowling alleys, 2-billiard tables, cocktail lounge, restaurant, \$500,000. ARCHITECT: Andrew P. Anderson, Jr., Oakland. GENERAL CONTRACTOR: Robt. D. Bardell, Oakland.

**CITY HALL ALTERATIONS**, Beverly Hills, Los Angeles county. City of Beverly Hills, owner. Alterations to basement, first and second floors of City Hall; remove hollow tile partitions, new dumb waiter, new cement filled metal pan stairs, wood and glass partitions, new concrete retaining wall, asphalt tile composition and linoleum floors, painting, ceramic tile wainscoting in toilets, meal toilet partitions, fire doors, fluorescent lighting, concrete patio, \$59,200.

ARCHITECT: Pereira & Luckman, Los Angeles. GENERAL CONTRACTOR: James Bros., Beverly Hills.

**DAIRY & POULTRY BUILDING**, San Luis Obispo, California Polytechnic School, San Luis Obispo, owner. A group of new buildings for the dairy and poultry divisions of the college, \$311,449. ARCHITECT: Division of Architecture, State of California. GENERAL CONTRACTOR: M & K Corp., San Francisco.

**DEL PASO JR. HIGH SCHOOL**, Del Paso Heights, Sacramento county. Grant Union High School District, Del Paso Heights, owner. One story addition to the Del Paso Heights Junior High School, 15,000 sq. ft., frame and stucco construction, concrete floors. ARCHITECT: Leonard F. Starks, Sacramento. GENERAL CONTRACTOR: Holdener Construction Co., Sacramento.

**MEAT PACKING PLANT**, Stockton, San Joaquin county. Alpine Packing Co., Stockton, owner. Remodeling of packing plant and construction of a new sausage plant; concrete block, glazed tile interior. ENGINEER: W. B. Clausen, Oakland. GENERAL

CONTRACTOR: Chas. S. Plumb Co., Stockton.

**OFFICE BUILDING**, Long Beach, Los Angeles county. Richfield Oil Corp., Los Angeles, owner. One story combination office, laboratory and storehouse building; 65,382 sq. ft. floor space, precast panel walls, composition roof, steel sash, concrete slab and asphalt tile floors, acoustical tile ceilings, plastered walls with wood and metal trim, terrazzo floor toilet rooms, radiant heating. ARCHITECT: Kenneth S. Wing, Long Beach. GENERAL CONTRACTOR: P. J. Walker Co., Los Angeles.

**ELEMENTARY SCHOOL**, Klamath, Del Norte county. Klamath Elementary School District, Klamath, owner. One story frame and stucco addition to the Klamath Elementary School consisting of 6-classes rooms, and toilet rooms, \$102,177. ARCHITECT: Ernest F. Winkler, San Francisco. GENERAL CONTRACTOR: H. Barnhart, Medford, Oregon.

**MACHINE SHOP REMODEL**, San Francisco, Union Machine Co., San Francisco, owner. Remodel interior and exterior of machine

## BUILDING TRADES WAGE (JOB SITES) NORTHERN, CENTRAL AND SOUTHERN CALIFORNIA

ATTENTION: The following are the PREVALING hourly rates of compensation being paid and in effect by employers by agreement between employees and their union; or as recognized and determined by the U. S. Department of Labor. (June 1, 1953.)

CRAFT	San Francisco	Alameda	Contra Costa	Fresno	Sacramento	San Joaquin	Santa Clara	Solano	Los Angeles	San Bernardino	San Diego	Santa Barbara	Kern
ASBESTOS WORKERS	\$1.585	\$2.585	\$2.585	\$2.585	\$2.585	\$2.585	\$2.585	\$2.585	\$2.25	\$2.25	\$2.25	\$2.25	\$2.25
BOILERMAKERS	2.68	2.68	2.68	2.68	2.68	2.68	2.68	2.68	3.175	3.175	2.75	3.175	3.175
BRICKLAYERS	3.25	3.25	3.25	3.00	3.25	3.00	3.45	3.25	2.45	1.94	1.94	1.94	1.94
BRICKLAYERS, HODCARRIERS	2.45	2.45	2.45	2.00	2.40	2.25	2.45	2.54	2.57	2.57	2.57	2.57	2.65
CARPENTERS	2.40	2.40	2.54	2.54	2.54	2.54	2.54	2.54	2.57	2.57	2.57	2.57	2.57
CEMENT FINISHERS	2.57	2.57	2.57	2.57	2.57	2.57	2.57	2.57	2.57	2.57	2.57	2.57	2.57
CONCRETE MIXER—Skip Type (1-y.)	2.28	2.28	2.28	2.28	2.28	2.28	2.28	2.28	2.38	2.38	2.38	2.38	2.38
ELECTRICIANS	3.00	3.00	3.00	3.00	3.00	2.75	3.00	2.50	3.00	3.00	3.00	3.00	3.00
ELEVATOR CONSTRUCTORS	2.75	2.75	2.75	2.75	2.915	2.915	2.915	2.915	2.25	2.25	2.25	2.25	2.25
ENGINEERS; MATERIAL HOIST	2.54	2.54	2.54	2.54	2.54	2.54	2.54	2.54	1.975	1.975	1.975	1.975	1.975
GLAZIERS	2.30	2.30	2.30	2.30	2.25	2.30	2.30	2.50	2.26	2.26	2.26	2.26	2.26
IRONWORKERS; ORNAMENTAL	2.70	2.70	2.70	2.70	2.70	2.70	2.70	2.70	2.70	2.70	2.70	2.70	2.70
REFRIG. FREET	*2.60	2.60	2.60	2.60	2.60	2.60	2.60	2.60	2.61	2.61	2.61	2.61	2.61
STRUCTURAL STEEL	*2.85	2.85	2.85	2.85	2.85	2.85	2.85	2.85	2.70	2.70	2.70	2.70	2.70
LABORERS—BUILDING	1.85	1.85	1.85	1.85	1.85	1.85	1.85	1.85	1.94	1.94	1.94	1.94	1.94
CONCRETE	1.85	1.85	1.85	1.85	1.85	1.85	1.85	1.85	1.94	1.94	1.94	1.94	1.94
LATHERS	3.25	3.50	3.50	3.00	3.00	3.00	3.4375	3.00	3.125	3.125	3.125	3.125	3.125
MARRBLE SETTERS	2.95	2.95	2.95	2.95	2.95	2.95	2.95	2.95	2.875	2.875	2.875	2.875	2.875
MOSAIC & TERRAZZO	2.76	2.76	2.76	2.76	2.76	2.76	2.76	2.76	2.40	2.40	2.40	2.40	2.40
PAINTERS—BRUSH	*2.60	2.60	2.60	2.60	2.625	2.65	2.625	2.27	2.56	2.50	2.53	2.22	2.22
PAINTER—SPRAY					2.91	2.70		2.68					
PILEDRIVERS—OPERATOR	2.75	2.75	2.75	2.75	2.75	2.75	2.75	2.75	2.74	2.74	2.70	2.70	2.70
PLASTERERS	3.125	3.165	3.125	3.125	3.00	3.00	3.125	3.00	3.125	3.125	3.125	3.125	3.125
PLASTERERS, HODCARRIERS	2.60				2.50	2.50		2.50	2.875	2.25	2.30	2.00	2.00
PLUMBERS—STEAM FITTERS	2.90	2.90	2.875	2.75	2.90	2.75	2.75	2.90	2.90	2.90	2.90	2.90	2.90
ROOFERS	2.50	2.50	2.95	2.95	2.50	2.50	2.50	2.50	2.45	2.45	2.45	2.45	2.45
SHEET METAL WORKERS	2.475	2.475	3.125	2.43	2.75	2.50	2.40	2.415	2.475	2.475	2.175	2.00	2.475
SPRINKLER FITTERS	2.75	2.70	2.70	2.625	2.625	2.625	2.75	2.75	2.25	2.25	2.25	2.25	2.25
STEAMFITTERS	2.75	2.90	2.90	2.75	2.625	2.625	2.75	2.75	2.90	2.90	2.90	2.90	2.90
TRACTOR OPERATOR	2.67	2.67	2.67	2.67	2.67	2.67	2.67	2.67	2.52	2.52	2.52	2.52	2.52
TRUCK DRIVERS—1/2 Ton or less.	1.89	1.89	1.89	1.89	1.89	1.89	1.89	1.89	2.02	2.02	2.02	2.02	2.02
TILESETTERS	2.955	2.955	2.955	2.955	2.955	2.955	2.955	2.955	2.65	2.65	2.65	2.65	2.65

\* 6 Hour Day. \*\* 7 Hour Day. \*\*\* Before C.I.S.C for 15c increase.

Prepared and compiled by:

CENTRAL CALIFORNIA CHAPTER, ASSOCIATED GENERAL CONTRACTORS OF AMERICA, with the assistance and cooperation of secretaries of General Contractors Associations and Builders Exchanges of Northern California; and the above information for southern California is furnished by the Labor Relations Department of the Southern California Chapter, ASSOCIATED GENERAL CONTRACTORS OF AMERICA.

# CLASSIFIED ADVERTISING

RATE: 20c PER WORD . . . CASH WITH ORDER

MINIMUM \$5.00

**HOME BUYERS**—Now building moderate priced homes in Sacramento and Marysville area; we are in a position to serve your needs. "Better Built Homes" by Ronne, Ronne & Ronne, Builders, 520 9th Street, Sacramento.

**YOUNG MAN SEEKS OPPORTUNITY**—Young man with good background in the construction industry, seeks opportunity with Contractor. Primary consideration chance to advance to executive position in future. College graduate. INQUIRE, Box 521, ARCHITECT & ENGINEER magazine, 68 Post St., San Francisco.

**COLLECTIONS**—Thoroughly experienced in all phases of the collection business; your interests protected at all times; bonded agents everywhere; no collection no charge; California Material Dealers Service Co., 925 Hearst Bldg., San Francisco. Ernest T. Langley, Manager.

**BUILDERS!** You can make more money; get information you need before it is published elsewhere; Subscribe to the daily ARCHITECTS REPORTS, only \$10.00 per month. Complete information from ARCHITECTS REPORTS, 68 Post Street, San Francisco. Phone DOuglas 2-8311.

**PHOTOGRAPHY**, For the best in construction photography, including exterior and interior, aerial, and progress views . . . you will find as many others have that it's the SKELTON STUDIOS, 875 O'Farrell St., San Francisco. Telephone PRespect 8-1841.

**ARCHITECTURAL SLIDING SLEEVE SASH**. One lot only — new, half price. 13 units, assorted sizes, 353 square feet total. 3 at 7 ft. x 5 ft.; 4 at 7 ft. x 4 1/2 ft.; 1 at 6 ft. x 4 1/2 ft.; 2 at 6 ft. x 4 ft.; 1 at 7 ft. x 3 1/2 ft.; 1 at 4 1/2 ft. x 3 ft.; 1 at 3 ft. x 3 ft. Phone DElaware 3-7378, San Francisco.

shop, plus addition to building, \$54,556. ENGINEER: Leland S. Rosener, San Francisco. GENERAL CONTRACTOR: Swinerton & Walberg, San Francisco.

**BANK REMODEL**, Santa Fe, New Mexico. First National Bank of Santa Fe, owner. Two-story, and basement, addition, 93x150 ft.; brick and terra cotta construction, \$509,100. ARCHITECT: Meem, Zehner, Holien & Associates, Santa Fe. GENERAL CONTRACTOR: Robert E. McKee, Santa Fe.

**FACTORY ADDITION**, Los Angeles. Olympic Realty Co., Los Angeles, owners. One and part two-story factory, 20,000 sq. ft. of floor area, reinforced concrete frame walls, precast concrete joists, composition roof, precast concrete floor, electrical work, metal sash, plumbing. ARCHITECT: Ralph C. Flewelling and Walter L. Moody, Los Angeles. GENERAL CONTRACTOR: Heirshberg Construction Co., Los Angeles.

**HIGH SCHOOL BUILDING**, Fellon, Santa Cruz county. San Lorenzo Valley Unified School District, Boulder Creek, owner. Frame and stucco construction; 8-classrooms, administration, home making, library, science, arts & crafts, music, shop, gymnasium, shower, locker and toilet rooms, \$527,200. ARCHITECT: John Lyon Reid, San Francisco. GENERAL CONTRACTORS: B & R Construction Co., San Francisco.

**LINCOLN HALL**, University of Nevada, Reno, Nevada. University of Nevada, Reno, owner. Completion of the interior of the building, \$47,175. ARCHITECT: Russell Mills, Reno. GENERAL CONTRACTOR: Robert E. Hansen, Reno.

**PUBLIC HEALTH CENTER**, Fairmont Hospital, San Leandro, Alameda county. Alameda county, Oakland, owner. Two-story, type-1, reinforced concrete, metal windows,

composition roof, \$374,980. ARCHITECT: Corlett & Anderson, Oakland. GENERAL CONTRACTOR: W. H. Wisheroop, Oakland.

**TEMPORARY CLASSROOMS**, Jr. College Site, Fresno. Fresno Unified School District, Fresno, owner. Construction of 13-temporary classroom building in the City of Fresno, \$93,336. ARCHITECT: Beni F. Lippold, Fresno. GENERAL CONTRACTOR: William Hopkins & Son, Fresno.

**THEATRE TO SYNAGOGUE**, Los Angeles. Temple Beth Israel, Los Angeles, owner. Convert theatre building at 8056 Beverly Blvd., Los Angeles, to a synagogue for the Temple Beth Israel. ARCHITECT: Arthur Froelich, Beverly Hills. GENERAL CONTRACTOR: Chotiner & Gumbiner, Inc., Los Angeles.

**MACHINE SHOP BLDG.**, Sacramento, Alameda county, Johansson Machine Co., Oakland, owner. One-story grouted brick construction with wood roof trusses, \$110,000. ARCHITECT: Cecil S. Moyer, Oakland. GENERAL CONTRACTOR: A. S. Holmes & Son, Oakland.

**VETERANS MEMORIAL BUILDING**, Exeter, Tulare county. Exeter Memorial District, Exeter, owner. Reinforced grouted brick construction, wood deck, structural steel trusses, concrete floors, asphalt tile, air conditioning system, 12,000 sq. ft., \$251,843. ARCHITECT: Allison & Ribbe, Los Angeles. GENERAL CONTRACTOR: Midstone Construction Co., Fresno.

**SUPER MARKET**, Fresno. Mairfair Markets, Inc., Los Angeles, lessee. One-story brick and concrete block and frame, asphalt tile floors, 160x200 ft. STRUCTURAL ENGINEER: R. H. Cooley, Oakland. GENERAL CONTRACTOR: John J. Moore Co., Oakland.

**FOUNDRY BLDG.**, San Leandro, Alameda county. Ridge Foundry, San Leandro, owner. Three buildings, 1-story, concrete block, wood roof trusses, steel sash, concrete floor, 27,000 sq. ft., \$100,000. ARCHITECT: Andrew P. Anderson, Oakland. GENERAL CONTRACTOR: Robert D. Bardell, Oakland.

**ELEMENTARY SCHOOL ADD'N.**, Westwood, Lassen county. Westwood Joint Unified School District, Westwood, owner. Frame addition comprising classroom and corridor to Elementary School in Westwood, \$37,500. ARCHITECT: Clayton Kantz, Redding. GENERAL CONTRACTOR: Affiliated Engineers & Contractors, Sacramento.

**PORTABLE CLASSROOMS**, Stockton, San Joaquin county. Stockton Unified School District, Stockton, owner. 26-portable frame construction with steel sash, asphalt tile floors, composition roof, for use throughout school district, \$194,058. ARCHITECT: Victor Galbraith, Stockton. GENERAL CONTRACTOR: Nomellini Const. Co., Stockton.

**PARTS WAREHOUSE & OFFICE BLDG.**, Portland, Oregon. General Motors Co., Detroit, Michigan, owner. 1-story structural steel frame, brick walls, steel roof, \$500,000. ARCHITECT: George Dahl, Dallas, Texas. GENERAL CONTRACTOR: Haas & Haynie, San Francisco.

**COUNTY TB HOSPITAL**, Fresno. Fresno county, Fresno, owner. Three-story, and basement, reinforced concrete brick veneer, asphalt and terrazzo floors, 3-elevators, 1-dumbwaiter, steel sash, 50x350 ft., 206-beds, \$1,433,823. ARCHITECT: Horn & Merrilland, Fresno. GENERAL CONTRACTOR: Stolle, Inc., San Leandro.

**SHOPPING CENTER**, Sunnyvale, Santa Clara county. E. W. Handle and Wm. S. Peman, San Francisco, owners. 1-story, reinforced concrete tilt-up construction, with 1,400,000 sq. ft., \$3,500,000. ARCHITECT: Ward & Bolles, San Francisco. GENERAL CONTRACTOR: Barrett & Hulp, San Francisco.

**OFFICE BLDG.**, San Francisco. Pacific Greyhound Lines, San Francisco, owner. Four-story, and basement, interior and exterior remodel, \$320,000. ARCHITECT: W. E. Peugh, San Francisco. ENGINEER: F. W. Kellberg, San Francisco. GENERAL CONTRACTOR: Barrett & Hulp, San Francisco.

**SWIMMING POOL**, Costa Mesa, San Diego county. Orange Coast College, Costa Mesa, owner. Project includes 1-small, shallow pool for swimming instruction; a larger pool for diving, racing and water polo; a small section for spectator bleachers and decks with radiant heat, \$76,494. GENERAL CONTRACTOR: Baker Construction Co., Pasadena.

**OFFICE & WAREHOUSE**, San Bernardino. Brunswig Drug Co., Vernon, owner. 1-story tilt-up concrete and steel, composition roofing, concrete floor with asphalt tile covering, metal sash, air conditioning, 160x240 ft., \$350,000. ARCHITECT: Albert C. Martin & Associates, Los Angeles. GENERAL CONTRACTOR: William Simpson Co., Los Angeles.

**AUTO REPAIR SHOPS**, Long Beach. Freeman A. McKenzie, Long Beach, owner. Two 1-story, reinforced tilt-up concrete shop buildings. One of the buildings will be an addition 50x65 ft. in area and the other a separate building 51x150 ft. in area, composition and gravel roofing, aluminum frame skylights, concrete slab floors, monorails, roll-up doors, toilet rooms, \$47,000. CONSULTING ENGINEER: Charles C. Curtis, Long Beach. GENERAL CONTRACTOR: Tom E. Norcross, Long Beach.

**WAREHOUSE & OFFICE**, Culver City. Klein-Norton, Culver City, owners. Reinforced brick warehouse and office building, steel beams, wood joists, concrete slab, asphalt tile floors in eaves, radiant heating in offices and suspended gas heaters in warehouse area, steel sash, rolling steel doors, toilets, plate glass asphalt paving. ARCHITECT: Jones & Emmons, Los Angeles. GENERAL CONTRACTOR: Pallsigaard-Wilson, West Los Angeles.

**MISSION CHURCH**, San Mateo, San Mateo county. Roman Catholic Archbishop of San Francisco, San Francisco, owner. Frame and stucco construction, new St. Mathews Mission Church of San Mateo, \$201,000. ARCHITECT: Vincent Buckley, San Francisco. GENERAL CONTRACTOR: W. A. Moroney, Burlingame.

**HIGH SCHOOL REMODEL**, Los Gatos, Santa Clara county. Los Gatos Union High School District, Los Gatos, owner. Alterations to the Academic building and interior remodel, \$74,357. ARCHITECT: Sobe & Green, Los Gatos. GENERAL CONTRACTOR: W. R. Kalsched, San Jose.

**FACTORY ADDITION**, Burbank. Aero-Coupling Corp., Burbank, owner. Precast concrete addition to factory, tapered steel girders, wood roof with composition covering, concrete slab and asphalt tile floors, plaster walls, acoustical tile ceilings in kitchen, steel doors, wood doors, steel sash, steel decking, toilets, grading, asphalt paving, 50x180 ft. in area. ARCHITECT: Kenneth H. Neptune, Beverly Hills. GENERAL CONTRACTOR: H. M. Keller Co., Burbank.

**CHURCH & SUNDAY SCHOOL**, Concord, Contra Costa county. Presbyterian Church, Concord, owner. 1-story, and basement, reinforced concrete and concrete block steel frame, shingle tile roof, \$154,233. ARCHITECT: Donald Powers Smith, San Francisco.

# FLOORS

FOR EVERY PURSE  
OR PURPOSE

HOSPITALS • COMMERCIAL BUILDINGS • WINERIES • CANNERIES • FOOD PROCESSING • INDUSTRIAL BUILDINGS • WAREHOUSES • RESTAURANTS • SCHOOLS

Territories open for Qualified Representatives

Specifications and information available on request

Free Consultation Service

**LeROY OLSON  
COMPANY**

3070 Seventeenth Street,  
San Francisco, California

cisco. GENERAL CONTRACTOR: Zuckerman Construction Co., Walnut Creek.

**HIGH SCHOOL REMODEL**, Sonoma, Sonoma county. Sonoma Valley Union High School District, Sonoma, owner. Remodel existing building and remodel auditorium into combined cafeteria and auditorium, frame and stucco construction, \$138,993. ARCHITECT: John Lyon Reid, San Francisco. GENERAL CONTRACTOR: Herbert A. Crocker Co., San Rafael.

**SELF PARKING GARAGE**, San Francisco. Downtown Center Corp., San Francisco, owner. Nine-story and basement, class I-B, reinforced concrete, open on 2-street fronts, 2-passenger elevators, 137x275 ft., \$1,682,000. ARCHITECT: George A. Applegarth, San Francisco. GENERAL CONTRACTOR: Cahill Construction Company, San Francisco.

**RECREATION BUILDING**, North Sacramento. Haganwood Parkway & Recreation District, North Sacramento, owner. 1-Story concrete block and frame construction recreation building, \$36,056. ARCHITECT: Koblak & Fisher, Sacramento. GENERAL CONTRACTOR: Sacramento Construction Co., Sacramento.

**STORAGE BUILDING**, Los Angeles. K. A. Davis Wire & Cable Co., Los Angeles, owner. 1-Story, reinforced masonry, steel storage building, composition roofing, skylights, overhead car loading doors, concrete slab floor at dock height, 20 ft. exterior walls, rotary roof vents, 44x62 ft. area. ARCHITECT: Landon & Wilson, Los Angeles.

**PARKING FACILITIES**, Los Angeles. May Company, Los Angeles, owner. Three-level, 2-story and roof, parking structure, reinforced concrete construction to accommodate 1180 cars, 508x232 ft. in area. ARCHITECT: Albert C. Martin & Associates, Los Angeles. GENERAL CONTRACTOR: T-S Construction Engineers, Inc., Los Angeles.

**MARKET BUILDING**, Reseda, Los Angeles county. West Valley Investment Corp., Los Angeles, owner. One story and mezzanine, brick, 160x140 ft.; composition roof, concrete floor, metal sash, air conditioning, asphalt paving. ARCHITECT: Stiles O. Clements, Associated architects and engineers, Los Angeles. GENERAL CONTRACTOR: West Valley Investment Corp., Reseda.

ditioning industry and by the growth of the company's activities in this field.

Other officials of the new division include: H. M. Carnahan, vice-president; and Frank P. Well, vice president.

#### ASSOCIATED LIGHTING MOVES THEIR OFFICES

Associated Lighting Service of San Francisco, manufacturers of architectural and theatrical lighting equipment, have moved their offices from 488 Bryant Street to 521 Brannan Street.

The manufacturing plant, formerly located in San Francisco, has moved to new quarters in Redwood City.

#### APPOINTS SERVICE UNIT REPRESENTATIVE

The Farr Company of Los Angeles recently announced the appointment of Air Filter Sales & Service Co., Jackson, Mich., and Air Filter Sales & Service Co., Nashville, Tenn., as representatives in their respective areas for Farr products.

Marshall, Neil & Pauley, Inc., Texas and Louisiana representatives for Farr have organized a subsidiary company in New Orleans to handle Farr sales and service in the New Orleans territory, it was also announced by Los Angeles Farr officials.

#### ARIZONA HIGHWAY BUDGET ANNOUNCED

The tentative budget for Arizona's highway system for the fiscal year 1953-54, as released by the state highway department, totals \$32,792,600 as compared with \$30,936,000 for the current year.

Of the total budget, \$27,485,000 is allocated to the 4,000-mile state highways

system; \$19,137,000 for Primary; \$6,620,000 for secondary, and \$1,728,000 for the urban system.

The off-state system budget amounts to \$1,156,000, of which \$500,000 are city funds and \$656,000 are urban funds.

#### NEW LUCITE AND CHROME TOWEL RING

Architects, home builders, and home owners will be interested in a new lucite and chrome stirrup-type towel ring that "corals" that both towel to the wall and is manufactured by the HALL-MACK Co., of Los Angeles.

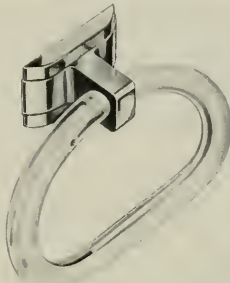

Six inches wide, it can be conveniently attached to the bathroom wall within easy reach of the shower; ring is swivel-attached to a chromium plated, die cast Zamak metal wall mounting. Custom styling is matched by its practicability..

## IN THE NEWS

#### MODESTO MEDICAL BUILDING

A group of doctors' have commissioned architect Merrill W. Baird of Glendale, to draft plans and specifications for the construction of a new medical building in Modesto.

Of reinforced brick with built-up composition roof, the building will include a refrigeration room, X-ray room, and out-patients department. Estimated cost is \$150,000.

#### NEW FIRM ORGANIZED BY AMERICAN-STANDARD

Thomas W. McNeill, has been named president of the newly organized Sunbeam Air Conditioner Division of the American Radiator & Standard Sanitary Corp., of Pittsburgh, Pa.

Formation of the new division to handle the company's operations in the air heating and cooling fields, was prompted by the increasing importance of the air con-

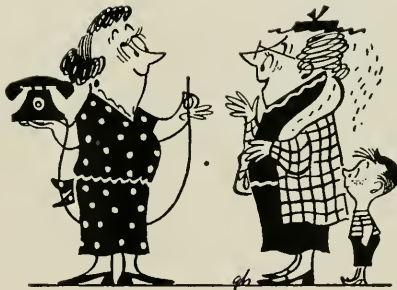

## Why built-in telephone facilities mean happier clients for you

Home owners like to tell their friends about the little "extras" you include in their building plans. That's why planned telephone facilities always appeal. People like the idea of concealed telephone wires and conveniently located telephone outlets to take care of their initial and future telephone installations and changes.

Just call Pacific Telephone's free Architects and Builders service. We'll be glad to help you plan for better living tomorrow in the homes you are building today.

Put built-in telephone facilities in your plans



## Pacific Telephone



## OPENS ARIZONA DISTRIBUTORSHIP

The Pacific Tile & Porcelain Company of Paramount, California, recently appointed the Copperstate Supply Company with general offices in Phoenix, Arizona, as distribution outlet for the state of Arizona.

Robert Yerxa, sales manager of Pacific Tile & Porcelain Company, stated that the appointment of Copperstate Supply Company will give complete statewide coverage of "Ramona" and "Cerattile" in Arizona.

## AWARDED WORK IN ALASKA

J. B. Warrack of Seattle, Washington, was awarded a contract by the Alaska District Engineer, Anchorage, to construct a 1-story guardhouse and P.O.L. laboratory at Fort Richardson, at a cost of \$408,956.40.

The Denali Construction Company, Inc., Anchorage, was also awarded a \$48,988 contract for the construction of three gasoline stations in Fort Richardson.

## TELEPHONE FACILITIES

The Pacific Telephone & Telegraph Company has plans underway for the construction of new office facilities, warehouse and shop buildings in San Leandro, California.

The 1 and part 2-story reinforced concrete building will cost an estimated \$3,000,000. An addition building to serve as a transportation center will also be built at a cost of \$500,000.

## NEVADA HOSPITAL

The Board of Trustees of the Churchill

Public Hospital, Fallon, Nevada, are building a 16-bed addition to the Churchill Public Hospital, comprising a 1-story concrete block and frame structure.

Estimated cost is \$140,000.

De Lonchamps & O'Brien of Reno are the architects.

## ARCHITECT SELECTED

The Pacific Mutual Life Insurance Company, with general offices in Los Angeles, has commissioned architect W. D. Paugh of San Francisco to draft plans and specifications for the construction of a new Office Building to be built in San Francisco.

Costing \$1,000,000 the new building will be located at the Northwest corner of California and Kearney streets.

## RESIDENCE HALL FOR WOMEN

A new residence hall for women students is being built on the University of California campus at Davis.

Of 3-story reinforced concrete construction the new facilities will accommodate 200 students, and will cost \$700,000.

Architects W. C. Hayes and Herbert E. Goodpastor of Sacramento are designers of the building.

## APPOINT DISTRICT MANAGER

John W. Marton, has been appointed San Francisco District Manager for the Virginia Metal Products, Inc., according to an announcement by R. M. Drysdale, Jr., vice-president of the company who's general offices are maintained at Orange, Virginia.

The firm manufactures steel partitions,

steel doors and frames, library stacks and equipment, vertical files, and conveyors.

## HOSPITAL PLANS ADDITION

The Alta Bates Hospital, Berkeley, California, is planning a 36-bed addition to the present facilities of the hospital.

Planned is a 6-story reinforced concrete building with steel sash, and asphalt tile and linoleum floors.

## L. B. FOSTER CO. OPENS NEW WEST COAST OFFICE

Henry E. Fleishman, vice president and general manager of the Chicago office of the L. B. Foster Company, will head the firm's new Los Angeles offices which are being established to better serve the industrial markets of California Arizona, Utah, Nevada, Oregon, Washington, Idaho, Montana and Wyoming.

The L. B. Foster Company maintains warehouse stocks of pipe, tubing, welding facilities, steel sheet piling, and steel rail and track equipment.

## CALIFORNIA NATIONAL GUARD

The California National Guard is completing plans for the construction of a 1-story, type "A" Army building in Red Bluff, Tehama county.

Present plans call for a 11,000 sq. ft. reinforced concrete, rigid steel frame, wood and composition roof structure.

## APPOINTED VICE-PRESIDENT BY-CHEMICALS PRODUCTS CO.

Raymond L. Drew, has been appointed vice-president and a member of the Board of Directors of the By-Chemical Products Company, San Francisco, according to a recent announcement by Edward A. Thompson, president of the firm.

Drew was formerly technical director in charge of manufacturing operations for the company at their King City, California, manufacturing plant and came to California from New York where he was technical director for the American Dye Wood Company.

## SCHOOL BONDS ARE VOTED

The Cascade Union Elementary School District of Shasta county, recently approved issuance of \$158,000 school bonds at a special election.

The funds, together with a \$190,000 State School Loan, will be used for the construction of a new Elementary school building near Anderson.

## ARCADIA METALS NAME NEW REPRESENTATIVE

The firm of Ralph, Mills & Company of San Francisco, has been named exclusive agents for Arcadia Products in northern California, according to a recent announcement by Henry E. North, Jr., president of the Los Angeles manufacturing firm

## RESEDA HIGH SCHOOL

The Los Angeles Board of Education has commissioned the architectural firm of George B. Allison and Ulysses Floyd Ribie, who have designed more than 30 Southern California educational institutions, to draft plans and specifications for the construction of a new High School for Reseda in the San Fernando Valley.

Designed to accommodate 2500 students

# VALUABLE NEWS SERVICE

- BUILDING MATERIAL DEALERS
- CONTRACTORS
- SUB-CONTRACTORS
- MANUFACTURERS AND REPRESENTATIVES

**ARCHITECTS REPORTS** gives advance news on construction projects in Northern California, lists: name of projects, location, architect, proposed cost and other pertinent information.

**HANDY** individual slip-reports, issued daily at a total cost of only

\$10 a month

# ARCHITECT'S REPORTS

Published Daily

The ARCHITECT and ENGINEER, Inc.

68 Post Street, San Francisco - DO 2-8311

## MULLEN MFG. COMPANY

BANK, STORE AND OFFICE  
FIXTURES—CABINET WORK  
OF GUARANTEED QUALITY  
CHURCH SEATING

Office and Factory

60-80 RAUSCH ST., 8et. 7th and 8th Sts.

San Francisco

Telephone UNDERhill 1-5815

## E. H. MOORE & SONS

GENERAL  
CONTRACTORS



693 MISSION STREET  
SAN FRANCISCO

## CLASSIFIED ADVERTISING

Will Bring Results

—USE—

ARCHITECT  
and  
ENGINEER

68 Post St. San Francisco

Fine  
ENGRAVINGS



POOR  
RICHARD

PHOTO ENGRAVING CO.  
320-324 COMMERCIAL STREET  
SAN FRANCISCO, CALIF.

the new facilities will cover approximately 225,000 sq. ft. and will cost \$4,233,000. A 2-story building is planned for academic and science classes, a library building, administration building, a building to house 4-homemaking classes, assembly hall to seat 1250, student store, cafeteria, boys and girls gymnasium, extensive shops for industrial arts classes, athletic facilities, and an agricultural unit.

### STATE MENTAL HOSPITAL

The Washington Department of Public Institutions, Olympia, is building a 475-bed ward building for the Western State Mental Hospital at Steilacoom, Washington at an estimated cost of \$2,300,000.

The new facilities will comprise a 5-story, and basement, building of reinforced concrete with a brick facing.

Architects George Cove and Lea, Pearson & Richards of Tacoma prepared the plans and specifications.

### CONCRETE SAW SPEEDS REMOVAL OF ASPHALT PAVEMENT

In order to facilitate the removal of a center section of street in Santa Rosa, California, where an abandoned water main has caused the street to settle, contractor Chester S. Yardley used one of the new Clipper Model C-130 Concrete Saw's equipped with a Clipper Diamond Blade.

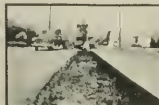

Some 1800 ft. of 9" Macadam base asphalt roadway was cut to a depth of 3 3/4", in accordance with specifications of the city, in a matter of 12 1/2 hours, or an average of 2 1/2 ft. per minute.

The city also specified that "free flowing traffic" be maintained. This was accomplished by completing all sawing before starting with the "breakout." To overcome the possibility of difficulty in rejoining of the asphalt at the cut, due to heavy truck traffic and a 90 degree summer heat, Yardley sifted fine sand into the finished cut.

### BONDS VOTED FOR DOCTORS HOSPITAL ADDITION READIED

The Doctors Hospital in Ontario, San Bernardino county, has commissioned architect Dewey J. Harnish of Los Angeles to draft plans and specifications for the addition of additional bed space to the hospital.

### RESIDENCE

Architect Elmo C. Brunner of Las Vegas, is the architect for Frank Rogers who is building a new 7-room residence in Paradise Park, Las Vegas, at an estimated cost of \$20,000.

Phone GARfield 1-1164

## Thomas B. Hunter

DESIGNER OF HEATING

AIR CONDITIONING  
VENTILATING AND WIRING  
SYSTEMS, MECHANICAL  
AND ELECTRICAL EQUIP-  
MENT OF BUILDINGS



41 SUTTER STREET  
ROOM 710

San Francisco

California

Subscribe  
Now —

ARCHITECT  
and  
ENGINEER

\$3.00  
Per Year

DINWIDDIE  
CONSTRUCTION  
COMPANY

BUILDERS

CROCKER BUILDING  
SAN FRANCISCO



HERRICK  
IRON WORKS  
STRUCTURAL STEEL  
REINFORCING STEEL

18TH AND CAMPBELL STS.  
OAKLAND, CALIF.  
Phone GLEncourt 1-1767

**MATTOCK  
CONSTRUCTION  
COMPANY**



**BUILDERS**



604 MISSION STREET  
SAN FRANCISCO

**ARCHITECT  
and  
ENGINEER**

Please enter my subscription for  
..... year.... My check in the  
amount of \$..... is attached.  
1 year . . . . \$3.00  
2 years . . . . 5.00

Name.....  
City.....  
State.....

**ABBOT A. HANKS, INC.  
Engineers & Chemists**

INSPECTING — TESTING — CONSULTING  
CONCRETE • STEEL • MATERIALS  
CHEMICAL AND TESTING  
LABORATORIES  
• RESEARCH AND INVESTIGATION •  
TESTS OF STRUCTURAL MATERIALS  
DESIGN OF CONCRETE MIXES  
SHOP AND ERECTION INSPECTION OF  
STRUCTURES AND EQUIPMENT  
INVESTIGATION OF STRUCTURES  
AND MATERIALS  
TESTS AND INVESTIGATION OF  
FOUNDATION SOILS  
FIRE RESISTANCE AND INSULATION  
TESTS

624 Sacramento Street, San Francisco

**PITTSBURGH  
TESTING LABORATORY**

**ENGINEERS AND CHEMISTS**

Testing and Inspection of Concrete,  
Steel and Other Structural Materials

Design of Concrete Mixes

Offices in all principal cities

651 Howard St., San Francisco 5  
EXbrook 2-1747

**Index to Advertisers**

ARCHITECTS Reports ..... 46  
BARRETT & HILP, Contractors ..... 35  
BY-CHEMICAL Products Co. .... 34  
CALIFORNIA Metal Enameling Co. .. 31  
CLAY Brick & Tile Association ..... \*

CLASSIFIED Advertising ..... 43  
CLINTON Construction Company ..... 36  
DINWIDDIE Construction Company .. 47  
FINK & Schindler, The, Co. .... 32  
FORDEKER Cornice Works ..... 35  
GLADDING, McBean & Company .... \*

GREENBERG'S, M. Sons ..... \*

HANKS, Abbott A., Inc. .... 48  
HAAS & Haynie, Contractors ..... 36  
HAWES Drinking Faucet Co. ....28 & 29  
HERRICK Iron Works..... 47  
HOGAN Lumber Co. .... 36  
HUNT, Robert W. Company ..... 48  
HUNTER, Thos. B. .... 47  
INERTOL Co., Inc. .... 33  
IDEAL Cement Co. .... \*

JOHNSON, S. T. Co. .... \*

JUDSON, Pacific-Murphy Corp. .... 36  
KRAFTILE COMPANY ..... 26  
MARBLE Institute of America ..... \*

McDONOUGH Steel Co. ....Back Cover  
MATTOCK Construction Co. .... 48  
MICHEL & Pfeffer Iron Works, Inc.  
..... Inside Front Cover

MOORE, E. H. & Son ..... 47  
MULLEN Mfg. Co. .... 47  
OLSON, LeRoy Co. .... 44  
PACIFIC Coast Aggregates ..... 27  
PACIFIC Manufacturing Co. .... 37  
PACIFIC Telephone & Telegraph Co. 45  
PARKER, Steffens & Pearce ..... 35  
PITTSBURGH Testing Laboratory ..... 48  
POOR Richard Engraving Co. .... 47  
PORCELAIN Enamel (Architectural  
Division) Publicity Bureau ..... 34  
REMILLARD-Dandini Co. .... 48  
REPUBLIC Steel Corporation ..... 37  
SCOTT Company ..... 48  
SIMONDS Machinery Company ..... 37  
SMOOT-Holman Company ..... 32  
SUMMERBELL Roof Structures ..... 33  
U. S. BONDS ..... Inside Back Cover  
VERMONT Marble Company ..... 37  
WEST Coast Screen Co. .... 38

\*Indicates Alternate Months

**FOR ADVANCE  
INFORMATION  
ON  
BUILDERS  
CONTRACTORS  
ENGINEERS**

Get

**ARCHITECTS  
REPORTS**

68 Post St. Phone  
San Francisco DO 2-8311

**ROBERT W. HUNT CO.  
ENGINEERS  
INSPECTING TESTING**

**STRUCTURAL MATERIALS  
CONCRETE MIX DESIGN  
CHEMICAL ANALYSIS  
EQUIPMENT**

PRINCIPAL CITIES  
UNITED STATES • EUROPE  
SAN FRANCISCO LOS ANGELES  
PORTLAND SEATTLE

**REMILLARD-DANDINI Co.**

**Brick and  
Masonry Products**



400 MONTGOMERY STREET  
SAN FRANCISCO, CALIF.

**Scott Company**

**HEATING • PLUMBING  
REFRIGERATION**



San Francisco  
Oakland  
San Jose  
Los Angeles



# ARCHITECT AND ENGINEER

BAYVIEW ELEMENTARY SCHOOL . . . San Pablo, California



SCHMIDTS & HARDMAN, Architects

**AUGUST**

**1953**



Simplified  
Installation



Easy  
Maintenance

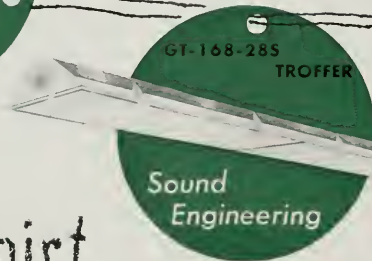

Sound  
Engineering



Efficiency



Dependability

Lost your shirt  
on hidden  
lighting cost?



Don't let it happen again.

Buy the QUALITY line with "plus"  
values on the price tag.

SIMPLIFIED INSTALLATION      EFFICIENCY  
SOUND ENGINEERING  
EASY MAINTENANCE      DEPENDABILITY

*Remember ...* You get only what you  
pay for ... and buying on price  
alone can be costly.

Next time look to .....



..... for quality

# ARCHITECT

Vol. 194 No. 2

ARCHITECTS' REPORTS—Published Daily

# AND ENGINEER

## Contents for

# AUGUST

EDITORIAL NOTES . . . . .	4
Guest Editor — Charles E. Fry, A.I.A., Austin, Field & Fry, Architects, Los Angeles; President, California Council of Architects	
NEWS AND COMMENT ON ART . . . . .	6
GROUND WATER IN GRADE SLABS . . . . .	8
—Its Effect on Floor Coverings	
—Its Prevention	
By C. LeRoy Olson. Part II (Conclusion)	
CONCRETE — Cities, Rural Communities, Residences, Schools, etc. . . . .	11
Technical Comment by J. E. Jellick, Manager, Portland Cement Information Bureau	
THE BETTANCOURT WAY . . . . .	16
Honest Construction Yields Dividends for Client and Builder.	
By Fred W. Jones	
A.I.A. ACTIVITIES . . . . .	28
WITH THE ENGINEERS . . . . .	30
PRODUCERS COUNCIL PAGE . . . . .	32
Edited by Stanley L. Basterdash, Western Asbestos Co.	
PHILIPPINE MAHOGANY ASSOCIATION . . . . .	33
National Conference at Carmel-By-The-Sea, California	
PERSONALITIES . . . . .	34
Scott Quinton, A.I.A. Architect, Alhambra, California	
BOOK REVIEWS, Pamphlets and Catalogues . . . . .	38
ESTIMATOR'S GUIDE, Building and Construction Materials . . . . .	41
ESTIMATOR'S DIRECTORY, Building and Construction Materials . . . . .	43
CONSTRUCTION CONTRACTS AWARDED and Miscellaneous Data . . . . .	44
BUILDING TRADES WAGE SCALES, Northern, Central & Southern California . . . . .	45
CLASSIFIED ADVERTISING . . . . .	45
IN THE NEWS . . . . .	47
INDEX TO ADVERTISERS . . . . .	50

- EDWIN H. WILDER  
Editor
- J. WELLS HASTINGS  
Contributing Editor
- PROF. LELAND VAUGHAN  
Landscape Architecture
- JOHN A. BLUME  
Structural Engineering
- MICHAEL GOODMAN  
Planning
- JOHN S. BOLLES, A.I.A.  
Book Reviews



### COVER PICTURE

BAYVIEW  
ELEMENTARY SCHOOL  
San Pablo, California

Architects:  
Schmidts & Hardman, A.I.A.

Contractor:  
J. Bettancourt

One of many outstanding construction projects completed by the contractor, J. Bettancourt of San Bruno, Calif.

For details of Bettancourt's work, see page 16.

ERNEST McAVOY  
Advertising Manager

ARCHITECT & ENGINEER  
is indexed regularly by  
ENGINEERING INDEX, INC.

ARCHITECT AND ENGINEER (Established 1905) is published on the 15th of the month by The Architect and Engineer, Inc., 68 Post St., San Francisco 4; Telephone EXbrook 2-7182. President, K. P. Kierulff; Vice-President and Manager, L. B. Penhorwood; Treasurer, E. N. Kierulff.

Los Angeles Office: Wentworth F. Green, 439 So. Western Ave., Los Angeles 5; Telephone DUnkirk 7-8135.

Entered as second class matter, November 2, 1905, at the Post Office in San Francisco, California, under the Act of March 3, 1879. Subscriptions United States and Pan America, \$3.00 a year; \$5.00 two years; foreign countries \$5.00 a year; single copy 50c. ARCHITECTS' REPORTS are published daily from this office, Vernon S. Yallop, Manager.





## NATIONAL HOME WEEK

Once again the eyes of the world will be turned on the homes of American families when "National Home Week" will be observed throughout the nation, September 20-27.

The event is sponsored in each city by local home building groups, in cooperation with architects, engineers, contractors and governmental officials, and is designed to show the public the latest types of homes, newer methods of construction, uses and application of building materials and products, and latest developments in home furnishings and equipment.

From this "public showing" of today's houses, comes the inspiration to own a "new-home"; the desire of building material manufacturers to further advance their services to the home building industry; the wish of the architect to advance the architectural perfection of residential design; and the hope of many people throughout the world, that "some-day" they may have a real home as in America.

\* \* \*

*"When we follow and do not lead, we are parasites. We become advocates of a style when we have no style ourselves."*—Frank Lloyd Wright, Architect.

\* \* \*

## CONSTRUCTION MARKETS

Problems facing the construction industry form a considerable amount of time, effort, and energy on the part of a large segment of persons connected with the nations leaders in planning, design, finance and building.

Such subjects as construction credit, materials, building costs, the demand for public and private construction, investment problems in income producing property, the needs and requirements for public works, construction statistics, the financing of construction, and the market for residential repairs and all type of remodeling—all these and many more come into prominence when reviewing the present and future of construction industry problems.

Trade organizations are fast taking a prominent spot in determining facts and figures pertaining to various phases of the industry, and participation by individuals in trade-association programs is important to the individual. It is important today to be on the inside of what is taking place in your industry, or profession, and the best way to make sure that you are keeping pace with current trends is to become an active member of your promotional group.

## GUEST EDITORIAL

### California Council of Architects



By CHARLES E. FRY, A. I. A.  
Austin, Field and Fry, Architects  
President  
California Council of Architects

*"A little more than three years ago the architects of California followed the lead of other members of the construction industry team, and of other professional groups, by implementing their own State-wide program.*

*"The California Council of Architects had existed before that time, and under the wise and conscientious guidance of its founders and early Presidents had achieved stature and had welded the profession together to a greater extent than ever before.*

*"But it was recognized that individual architects, no matter how much time they devoted to it, could not give the Council program the continuity and the necessary handling of a tremendous burden of detail which professional and trade associations must assume to attain full stature and influence.*

*"Therefore, the Council opened an office and employed a staff. The man chosen for Executive Secretary was Frederic A. Chase, former newspaperman, public relations executive, and a man who had become familiar to some extent with the profession and its problems during a period when he was Director of Public Relations of the Southern California Chapter of the Associated General Contractors.*

*"There were many doubters, inside and outside the profession, and there are still some. There were predictions that the Council would fall apart because 'architects are all individualists,' and because of ancient rivalries between Northern and Southern California.*

*"Three years later, the pessimism must be completely dispelled, because California's architects are working together now, through the Council, in many ways for the benefit of the profession as a whole, of the construction industry, and of the public.*

*"Isolationism is as dead in professional affairs as in international affairs. Much as we might like to live alone, in a sort of splendid dream world, we cannot afford it. There are many rude hands ready to slap one out of it. The Legislature can put you out of business. Building design can be taken over by others; much of it has been. There are about 2,000 licensed architects in California; 6,500 or so engineers, and thousands of contractors.*

*"But the Council is not intended as an organized minority to do battle with the Goliaths of industry. It is organized to work, in full stature, with the contractor groups, and with everyone else concerned with the same problems. We have proved this in many ways. An example is that the California Council of Architects is a member of the Construction Industry Legislative Council.*

*"We have committees to work with other groups, and much more of this is on our schedule for the future.*

*"It is recognized that good relations within the industry are good public relations for all of us; that the construction industry team, working together and solving its problems and differences within the family, can be a tremendous weight for good in the California community.*

*"We have been most encouraged by the friendly and cooperative attitude of the various other professional organizations, and the contractor organizations. They have welcomed the architects warmly to their councils. We are grateful, and dedicated to doing our full share.*

*"We also hope, as time goes by, and with the help of the rest of the building team, to widen public understanding of the nature and value of the architects' service.*

*"And we might say—to engineers and contractors and others—we also solicit your aid in bringing forth and solving problems and misunderstandings that arise from time to time between us, so that the final result is to the best interest of the job and the client."*



*With  
colorful  
CLAY  
BRICK*

*...inside or  
outside...*

**ONE WALL  
DOES IT ALL**



**ABOVE**—Appleton & Wolfard, Architects have blended Clay Brick with the landscape in creating an ideal outdoor setting at Parkside Library.

**AT LEFT**—Inside, colorful Clay Brick scores again with an outstanding achievement in indirect lighting.

**CLAY BRICK & TILE ASSOCIATION**

SERVING NORTHERN CALIFORNIA

Affiliated with Structural Clay Products Institute

**55 NEW MONTGOMERY STREET, SAN FRANCISCO**

*In the interest of better brick and tile construction the following companies have contributed to the publication of this advertisement.*

KRAFTILE COMPANY  
L. P. McNEAR BRICK COMPANY  
PORT COSTA BRICK WORKS

REMILLARD-DANDINI COMPANY  
SAN JOSE BRICK AND TILE, LTD.  
STOCKTON BRICK AND TILE COMPANY

UNITED MATERIALS & RICHMOND BRICK COMPANY

**Inside or Outside A CLAY BRICK WALL... BEST FINISH OF ALL**

# NEWS and COMMENT ON ART



## CERAMICS FOR WESTERN LIVING WINNERS

Awards in "Ceramics for Western Living", an exhibition currently being shown at the M. H. deYoung Memorial Museum in Golden Gate Park, San Francisco, have been announced by Louis Ferrario, Exhibition Committee Chairman for the San Francisco Potters Association.

Receiving awards were: Edwin A. Cadogan, Kenfield, for integration to the exhibition theme; Madeline Cortese, Richmond, integration of architecture and ceramics; Margo Elberg, San Anselmo, excellence in experimentation and unification of ceramic media; Antonio Prieto, Oakland, general excellence; Marguerite Wildenhain, Guerneville, general excellence; Helen Peeke, San Francisco, honorable mention for progress in ceramics.

The jury making the awards and selecting the objects for exhibition was composed of the following San Francisco Potters Association members: Mary Lindheim, Elizabeth McCrone, John McDowell, Eileen Reynolds, and Roy Walker.

## CITY OF PARIS

The Rotunda Gallery of the City of Paris, San Francisco, under the direction of Beatrice Judd Ryan is featuring a Coronation Exhibition during August. The material comprises a group of Lithographs by thirty-two contemporary British painters and is being sponsored by The Consul General and Mrs. Kenneth J. M. White.

A number of Prints selected in London by Beatrice Judd Ryan are being shown on the 4th Floor of the City of Paris.



**M. H. deYOUNG  
MEMORIAL MUSEUM  
Golden Gate Park  
San Francisco**

*Portrait of a Gentleman*  
By **PETER PAUL RUBENS**

**Flemish, 1577 - 1640**

Gift of  
**Mr. and Mrs. Roscoe Ookes**



# SPECIFY Porcelain ENAMEL VENEER

**FOR NEW  
CONSTRUCTION  
AND ...**

**REMODELING OF OLD!**



PORCELAIN ENAMEL VENEER was selected to transform St. Francis Hospital Pharmacy...in San Francisco...to its present state of classic beauty and functional simplicity.

HAROLD ONSTAD  
Architect  
BARRET & HILP  
Contractors

**PORCELAIN ENAMEL VENEER** is a superb facing specification, which grants closest liaison between the architect's intent, the requirements of the craftsman and economic reality.

Virtually any color that can be created may be timelessly fused into this inorganic material... which is bonded to steel at high temperature... permitting its ultimate fabrication in any manner that steel itself will accept.

*You may specify PORCELAIN ENAMEL VENEER with complete confidence, always*

Write today for  
Full Information  
and Color Chart

*Architectural Division*  
PORCELAIN ENAMEL PUBLICITY BUREAU  
P. O. BOX 186, EAST PASADENA STATION, PASADENA 8, CALIFORNIA  
ROOM 601, FRANKLIN BUILDING, OAKLAND 12, CALIFORNIA

# GROUND WATER IN GRADE SLABS

## — ITS EFFECT ON FLOOR COVERINGS — ITS PREVENTION

Part Two\*

By C. LeROY OLSON

### COMPOSITION SLEEPERS ON SLABS CONTAINING NO MEMBRANE

Where a concrete slab has already been installed without the waterproofing precautions mentioned above and where such composition sleepers are to be used, corrective measures may still be used and generally satisfactory results obtained by the following method:

#### SOLID WOOD FLOOR

The sleepers may be installed to the required levels and spacing to accommodate the job flooring requirements. Then the slab surface and composition sleepers may be hot coated with asphalt and the spaces filled flush with concrete to the top of such sleepers.

Such concrete fill is then allowed to dry thoroughly. When dry, such concrete may either be hot coated or primed with a cut-back asphaltic primer and when dry, covered with roofing felt or membrane, asphalt ply, siselkraft or other non-rotting building paper, chalk lines snapped over the paper to locate the sleepers and thereafter the wood flooring, either single or double, nailed to the sleepers. Obviously such construction, while solid and unyielding, requires



C. LeROY OLSON  
LeRoy Olson Company

no ventilating transverse tubes, holes or grooves in the sleepers nor does it require any ventilation in the ends of the sleeper spaces at the walls. Such concrete fill does not affect the Unibond Sleeper but does cause rotting in wood sleepers. Treating wood sleepers with preservatives does not sufficiently extend the life of such wood sleepers under the space filling technique described above to justify their use to the best of the author's knowledge of present day preservatives. If such efficient preservatives do exist such information has not been universally made known or is extremely limited to say the least.

### SPRING FLOORS FOR GYMNASIUMS OR DANCE FLOORS

Where such floors are to be installed over slab, not waterproofed as described above, the following procedure may be applied:

Install the composition sleepers to levels and spacing as required for the job and thereafter hot coat the slab in the spaces and over the sleepers. Then make a fill of concrete over the hot coat in the sleeper spaces with the top surface of the fill approximately  $\frac{1}{2}$ " or more below the top surface of the sleepers. Then proceed with the spring floor construction as specified for the job. No ventilation tubes, grooves or holes will be required with the hot coating and concrete fill described above. This if properly and carefully done, will take care of the waterproofing as a rule, although there are conceivable conditions which could arise to prevent such measures from becoming thoroughly waterproof, such as for instance movement of and cracking of slab after such hot coating and fill has been made. However, such situations are extremely unlikely and the method is logical and thus far over approximately twelve or fifteen years service has proven permanent and a good secure method of doing the job.

\*EDITOR'S NOTE: Part One—Published in the preceding issue of *Architect & Engineer* dealt with concrete slabs as to the effect on floor coverings of various types and kinds.

Part two, which follows, deals with concrete slabs in connection with sleepers and wood floors and the injury to wood floors caused by moisture and the prevention of such moisture and the resultant damage to such wood flooring.

## HOT COATING AND MEMBRANE ONLY

A method employed by many of the most successful and prominent architects for waterproofing a grade slab in the cities has been as follows:

The slab is constructed in accordance with the requirements of the job under the specifications and when thoroughly dry, it is given a hot coat of asphalt and one or more plies of roofing felt, each mopped down with hot asphalt. Thereover, chalk lines are snapped to accommodate the sleeper spacing specified and thereafter steelcrete nails  $\frac{3}{4}$ " or 1" long (tempered) are driven on these lines at intervals of 3" to 4" with heads projecting approximately  $\frac{1}{4}$ " above the hot coat. Then each nail is daubed with bitumuls, cut-back asphalt and allowed to dry.

Thereafter either the "cast in place" composition sleepers or "precast" composition sleepers are laid along such lines to the predetermined levels and allowed to set hard and are ready for the wood flooring to be applied thereover.

The principal objection to such a method of waterproofing a slab lies in the fact that, in the opinion of the author, hydrostatic pressure of ground water from below might and probably would dislodge the hot coat above the most porous sections of the slab, if not the entire surface thereof, with the result that a film or sheet of water would lie below the membrane and later on cause trouble and damage to the wood floor and especially the kiln dried finished flooring when much inconvenience, damage, expense and trouble might result.

Hence, the author's suggestion and use of a concrete fill between the sleepers to hold down the hot coat with an appreciable amount of weight, thus aiding in waterproofing permanently the slab in much the same manner and function as membrane within a concrete slab. (Elsewhere within this article the same observation is made in the case of floor covering.)

In such cases where moisture is likely to appear on the surface due only to "sweating" or to capillary attraction only with no pressure of water from below, then such methods of hot coating and application of membrane thereover, including separate hot mopping would no doubt completely waterproof the grade slab.

## BELOW GRADE SLABS

System of waterproofing such a slab by a most successful and prominent architect was as follows:

On this job several years ago the gymnasium was below grade approximately fifteen feet on its upper end and probably ten feet below grade or ground line on lower end. A very efficient and effective means was provided by the architect's of-

fice for waterproofing this slab as follows:

1. Crushed rock and gravel fill was laid.
2. Drainage—terracotta pipe was laid in the gravel and discharged into a sump.
3. This sump discharged at proper level to connect with the sewer lines well below the slab.
4. Reinforced concrete slab was poured over the entire area including concrete sump.
5. When the slab was thought to be dry a hot coat of asphalt and the several ply of asphalt saturated felt membrane applied, each mopped down with hot asphalt.
6. Chalk lines were snapped at spacing intervals of 16".

7.  $\frac{3}{4}$ " tempered stub nails (steelcrete nails) were driven in at 3" to 4" intervals with heads projecting approximately  $\frac{1}{4}$ " above membrane.

8. Here an interesting case of apparent sweating occurred which was at first thought to be hydrostatic pressure of water but which proved to be only "sweating" caused by the moisture content of the slab itself. In the upper end of the room where slab was the deepest, water came through the nail holes in the membrane. Thereupon, work on the sleeper installation was halted for two weeks after which all water on the surface dried up, thus proving that the water present was due only to "sweating." The drainage below this basement slab prevented any water emerging through the slab either by capillary attraction or by hydrostatic underground water pressure, and the work was then allowed to proceed on schedule.

9. Thereafter, the nail heads and holes were daubed with cut-back asphalt and allowed to dry.

10. Unibond sleepers were then cast directly over the chalk lines and nail heads at the predetermined levels and ventilation provided as specified.

11. Later the flooring specified was installed and all work completed in the gymnasium according to plan. Obviously such a well planned job contained all of the elements of success and is a shining example of the resourcefulness of the construction industry in meeting unusual situations.

Even in such a situation as described in the above job, had the method of waterproofing not been entirely successful, it is possible that the method previously described of installing a concrete fill between the sleepers would have saved the situation for the architects, but thanks to their careful planning of the job such a preventive procedure was not required. Thus the construction industry moves forward in stride with progress in the true American style, or shall we say in the true spirit of progress regardless of nationality. Many other instances of ingenuity in the methods of the construction industry and/or in our own in-



dividual experiences make for progress. The unfortunate phase of such methods is that not all are properly recorded for future generations and no doubt many ideas of value have been lost through failure to record them in detail.

Occasionally an architect not too familiar with the composition, non-rotting sleepers and the true purpose of ventilating, transverse tubes, grooves or openings therein, is likely to run into trouble on his own theory that such ventilation facilities are intended to be used for "drying out purposes" rather than the true purpose of rot prevention.

The original intention back of the idea of rot prevention meant that while the sleepers themselves are rot-resistant and rotproof, it was shown that a complete change of air under the flooring every twenty-four to forty-eight hours would prevent rot occurring in the flooring.

It is a known fact that the magnesium chloride solution within the sleeper, itself, leaves a surface deposit of efflorescent salts of this solution which solution not only acts as one of the hardening agents in the composition sleeper but the efflorescent salts on the surface act as a germicide against decay of wood and also as a preservative of any wood coming in contact with the sleeper at the point of contact. Therefore, a change of air within the sleeper spaces every twenty-four to forty-eight hours would prevent rot in the subfloor.

The personal observation of the author over some thirty years indicates this theory to be erroneous since not a single case of rot has ever been observed (by the author) in that time either in such composition sleeper installations or in the wood subfloor or top flooring thereover, nor in the case of wood subflooring supporting magnesite floors or other oxychloride cement floors where a sufficient air space below the subfloor existed. However, here we refer only to the subfloor and not to the floor joists below the wood floor. If the air space below such floor joists is not properly ventilated and if less than say 18 inches clearance above the soil, such joists have been known to rot out or be damaged by termites regardless of the condition of the wood subfloor directly in contact with such magnesite or other oxychloride cement floor. The opinion and theory that such ventilation facilities are intended to cause a drying out of all moisture finding its way under such flooring overlaying such sleepers is likewise erroneous since the moisture could not dry out before affecting the kiln dried finished flooring adversely.

Some architects and construction engineers have asked this question, but have been told by the author that the presence of moisture should not be

permitted under any circumstances in such installations. The steps in waterproofing the concrete slab have been described elsewhere in this article and are a practical solution to the problem of preventing moisture from entering such sleeper spaces.

The instances where moisture causes trouble usually results from three or more causes. (1) hydrostatic pressure of subsoil water, (2) capillary attraction by which subsoil or ground water is brought in direct contact with a poorly laid loose concrete slab, thus finding its way to the top surface, or (3) mechanically entrained water within a wall compacted concrete slab, must escape to the top surface of such slab by reason of the fact that it is not able to dissipate itself on the underside of the slab, probably due to moisture in the subsoil.

Hydrostatic pressure usually is caused by elevated ground on one or more sides of a building location sufficiently high to cause the water to rise above the ground level in the low areas and flow away if there is sufficient slope, or evaporate if not in sufficient quantity or slope to inundate the ground.

However, where the building is located, neither sloping ground nor evaporation would be present to prevent accumulation of water in the sleeper spaces unless the concrete slab had been previously waterproofed in the manner described previously herein.

Likewise, "sweating" could be prevented. In those cases or instances where the slab had not been previously waterproofed it would still not be too late—before the wood floors had not been nailed to the sleepers—to hot coat or otherwise waterproof the concrete in the sleeper spaces and over the sides and top of the sleepers. Then make doubly safe by pouring a concrete mixture therein, flush to the top of the sleepers but no higher. When the concrete is dry, either a hot coat of asphalt or a layer of fifteen pound roofing felt is applied and lapped three inches or four inches thereover and loosely nailed or tacked to sleepers. Then snap chalk lines over the sleepers and proceed to lay single or double floors direct to the sleepers.

Obviously no ventilation is needed at all in such an installation, and all fire ordinances in any and all cities are respected and well met.

In the case of spring floors for gymnasiums the same procedure of hot coating or otherwise effectively waterproofing the concrete slab surface in the sleeper spaces and over the tops of the sleepers may be followed but the difference thereafter in the procedure is as follows:

Make the concrete fill between the sleepers but

(See Page 40)

# No Part Of The Civilized World Is Built Without Some Modern Form Of CONCRETE

## Cities - Rural Communities - Residences - Schools - Factories

The cement industry, by and large, is easily recognized as one segment of the construction industry which serves in a very important manner practically every phase of industrial, commercial, residential and professional activity throughout the civilized world.

It would be quite difficult to select any individual industry, or almost any business endeavor which

does not directly use in some degree, or substantially benefit from the manufacture of cement in its various forms.

The use of cement as a building material in many types of construction has been a pretty generally accepted operation for a great number of years, however, modern progress has utilized the many attributes of this product, particularly its

**SACRAMENTO AREA**—California's State Capitol City is a typical concrete community with large multi-story office and business buildings, many residences, concrete and steel drawbridge over Sacramento River, industrial buildings, and modern concrete highways and overhead clover-leafs and ramps being constructed to better serve the American way of life.

*Photo Courtesy "California Highways," Department of Public Works magazine.*







Photo Courtesy "California Highways," Department of Public Works magazine



durability in situations where subjected to unusually heavy wear, shock, and as a mixing agent.

Modern airlines which now circle the globe with huge multi-engined equipment capable of transporting many persons and items of freight use concrete in the construction of landing fields which must withstand the constant "shock" of landing aircraft and constant exposure to all types of weather conditions; the railroads, one of the pioneers in the transportation systems of the world, now use vast quantities of cement in the construction of bridges, culverts, railway stations, repair yard equipment, and administrative buildings; the comparatively new (when considered in terms of modern era development) oil industry uses concrete and cement products in a widening variety of construction, such as completion of wells, drilling operations, building great oil refineries, service facilities for the public, and business office buildings; the agricultural activities of the nation are dependent to a degree upon the use of cement. Vast irrigation projects with their combinations of dams, canals and irrigation ditches would not be possible without this product. Ranch and farm buildings everywhere represent additional use of cement by the rancher and farmer.

The nation's extensive system of modern highways, freeways, and roads with their myriad of bridges, subways, cloverleafs and traffic separation centers would not be a reality were it not for the use of cement, and the fact that cement can be adapted in its use to meet the ever increasing need for a more durable roadbed to serve the pleasure automobile and the increasing number of light and heavy trucks. Original standards of highway construction in terms of width and roadbed thickness have long been discarded. In their place have come wide divided highways of multiple lanes, and a roadbed thickness designed to meet the requirements of today's varied vehicles which pass over the highway. A number of illustrations are used on these pages to show the extensive and important factors dealing with the construction of highways in California. Similar segments of highway construction may be seen in almost every metropolitan area in the nation, and

similar activities on perhaps a somewhat smaller scale may be observed in the smaller cities and throughout rural areas of the nation.

Probably the most frequently accepted use of cement is in the construction of factories, warehouses, office buildings, garages, commercial buildings and a very wide variety of residential construction. These are the types of building most people come in contact with most frequently, and in all such construction has been developed a recognized acceptance and approval. However, even in many of these common uses, the ways and means of handling cement products has moved ahead. One of the newest developments in the construction industry where concrete is one of the major considerations has been the advent of the pre-cast, or tilt-up, method of building. Engineers and contractors working together have developed a method of constructing concrete walls, and even floors, for multi-story structures wherein the walls and poured flat, allowed to set and then moved into place with crane, or other method, where these precast sections become a permanent part of the building. Much time is saved by use of this method as well as permitting the simplification of a number of other factors which are involved in the use of cement in construction.

Residential construction is another tremendous sector of the construction industry wherein cement, and cement products, are all important. Few of today's modern homes are built without the use of cement, in some form or another.

Cities and towns are built with cement. Streets, sidewalks, subways, sewers, bridges, and as pointed out almost every building, has some cement in it.

Cement is therefore basic to practically all building and it would be hard to conceive of a modern home, factory, airport, highway, office building, farm, garage, railroad, or public works project being constructed without the use of a substantial amount of cement.

Advent of this product into the construction industry took place many years ago, but the most spectacular era of the use of cement has been since the turn of the century and during the decade prior to 1930. The broadening use of cement and the spectacular building boom of that era, stimulated a great expansion in the number of cement

*EDITOR'S NOTE—Basic construction materials such as cement, steel, wood, brick and tile, ceramics and a number of combination materials will be featured in ARCHITECT & ENGINEER in the future. This article deals with "concrete".*

**ILLUSTRATION AT LEFT—**Shows the Arroyo Seco in Pasadena, California. In the foreground can be seen the old two-lane Colorado Street bridge built in 1912, and immediately beyond is seen the new Colorado six-lane freeway under construction . . . a project that would be impossible without the use of cement. The famous Rose Bowl, scene of the annual New Year's Day intersectional collegiate football game, is at upper left, and the residential area seen in the distance is a portion of the cities of Altadena and Pasadena.

mills engaged in the manufacture of cement products. The capacity of the industry in this brief period was increased from 140-million barrels per year to a annual capacity of 270-million barrels.

With the depression of 1929, and subsequent years of tedious recovery, the expansion of the cement industry came to an abrupt halt, and in the past twenty three years the capacity of the industry to produce cement has grown but about 5-percent to a present total of approximately 285-million barrels per year. The latest available figures, reported to the United State Bureau of Mines, Department of the Interior, show the production of finished portland cement in June of this year totaled 22,698,000 barrels which is a 9-percent increase over June of one year ago. So, it now appears the industry has taken up all slack, and is again faced with an expansion in production in order to keep up with the ever increasing, and widening, demands for cement.

## A TECHNICAL ANALYSIS OF ONE USE OF CEMENT

J. E. JELICK, Manager  
Portland Cement Information Bureau

In Northern California and the Bay Area, where prevailing low humidity and drying winds are common, concrete floor slabs are likely to show more than average shrinkage cracks when placed during the summer months.

There are many contributing causes of cracks in flat slabs, the most common of which are weather conditions, too much water in the mix, an excess of fines in the sand, too early and too much steel troweling, and insufficient or improper curing.

Some three years ago the writer was called upon to inspect a job of more than average cracks in the floor slabs in a Housing Project in Palo Alto. As is well known, F.H.A. requires a granular fill and on top a waterproof membrane (usually consisting of several pieces of tar paper) on which the concrete floor slab is placed. On this particular

project two or three to one-half dozen shrinkage cracks were noticed in the rooms of each of the houses, which is no more than the average experienced during hot drying weather.

In the garage, which was part of the house, F.H.A. did not require a waterproof membrane and the granular fill had an excess of sand. It was noticed that practically no cracks had occurred in the garage after an inspection of some twenty or thirty houses.

After studying the situation and discussing it with contractors we were convinced that the sand in the granular fill, which absorbed a reasonable amount of water from the base of the slab, was responsible for the elimination of the shrinkage cracks in the garage. Accordingly, we made recommendations to certain contractors, who were having the same trouble in Fresno, Sacramento, and other unusually warm localities, and suggested that they experiment with a blanket of one or two inches of sand underneath the concrete floors that were placed on the ground, regardless of the subgrade. In checking with them later they all were enthusiastic about the use of a sand cushion underneath the concrete since it eliminated practically all of the shrinkage cracks.

Under the circumstances we now recommend the use of an inch or two of sand over any subgrade, other than sandy loam, or an all sand base. This is especially beneficial in the case of impervious and dense red rock fills or other materials in the subgrade which do not readily absorb moisture from the base of the concrete after it is placed.

Equally important is keeping the water content in the mix as low as possible, keeping the finishers from troweling until the surface water has disappeared, and above all—an early application of membrane curing. In this case emphasis must be placed on a sufficient amount of curing compound on the finished concrete flooring—particularly during hot drying weather—in order to insure a minimum or entire elimination of shrinkage cracks.

**CONCRETE ROAD CONSTRUCTION**—Use of concrete in highway construction is becoming more general throughout the world, the three views at the right show: **TOP**, construction operations on a freeway with portland cement being placed in position with a mechanical spreader and mechanical tamper; **CENTER VIEW** shows application of grey pigmented sealing compound to newly placed pavement; **LOWER VIEW** shows a modern traveling concrete mixing plant using base material, water and cement.



Photo Courtesy "California Highways," Department of Public Works magazine.



# THE BETTANCOURT WAY

## HONEST CONSTRUCTION YIELDS DIVIDENDS FOR CLIENT AND BUILDER

By **FRED W. JONES**

One day shortly after the beginning of World War II, Joseph Bettancourt, San Bruno contractor and builder, was called to the telephone. The War had put a stop to private building and Bettancourt had planned to "take it easy" for a few months.

"This is Frank Barrett of Barrett & Hilp," were the first words to reach the ears of the San Bruno

contractor as he listened to the phone receiver. "Say, Bettancourt," the voice continued, "we are in need of a good superintendent at the Belair Shipyards, can you make it?"

"Never heard of the Belair Shipyards," replied Bettancourt, "anyway I am due to take a few months vacation."



### EXECUTIVES OF J. BETTANCOURT BUILDER

J. Bettancourt (seated at left),  
Clifford Anderson and  
Clarence Hodges.

Harold Lister, another staff member  
is not shown in this photo.

**J. BETTANCOURT  
CONTRACTOR  
San Bruno, California**

"True, at the moment there are no Belair Ship-yards," explained Barrett, "but it's up to you to build them. Joe, this is War!"

And the next day Joseph Bettancourt was on the job, overseeing construction of one of the World War II's major defense projects.

Aside from this government job, Jos. Bettancourt has successfully followed the contracting business since 1927, completing many notable structures, private and public, throughout the State of California.

Asked how he happened to go into the contracting business, the San Bruno builder replied, "I figured that if I could make money for the other fellow I could make some for myself. I enjoy my work and that is a very important factor, leading to success, in any vocation."

Bettancourt learned the contracting business while associated with R. H. Hamilton in Santa Cruz back in 1918. He spent two years in the sum-

The following firms, participants in the construction activities of J. Bettancourt, Contractor-builder, have display advertisements in this issue:

L. N. Johnson & Son—Vallejo  
Golden Gate Iron Works—San Francisco  
Gilmre Fabricators—Oakland  
Regal Roofing Co.—San Francisco  
Atlas Heating & Ventilating Co., Inc.—San Francisco  
Minton Lumber Co.—Mountain View  
Engineered Metals, Inc.—San Francisco  
Steelform Contracting Co.—San Francisco - Los Angeles  
Richards Reinforcing Steel Co.—Oakland  
Clinton Mill & Mfg. Co.—Oakland  
California Builders Hardware Co.—Oakland  
United Floor Covering Co.—Vallejo  
Gamerston & Green Lumber Co.—San Francisco  
Universal Window Co.—Berkeley  
The Hermann Safe Co.—San Francisco  
E. M. Hundley Hardware Co.—San Francisco  
General Hotel Supply Co.—San Francisco  
Vallejo Building Materials Co.—Vallejo  
Worley & Co. (Agents for Trask & Squire Co., Inc.—Pico  
Pacific Mfg. Co.—San Francisco  
Judson Pacific Murphy Corp.—Emeryville  
Haws Drinking Faucet Co.—Berkeley  
Gladding McBean Co.—San Francisco  
Pacific Coast Aggregates—San Francisco  
Kraftile Company—Niles  
Michel & Pfeffer Iron Works—South San Francisco

**General Offices of J. Bettancourt, Builder, San Bruno, California**



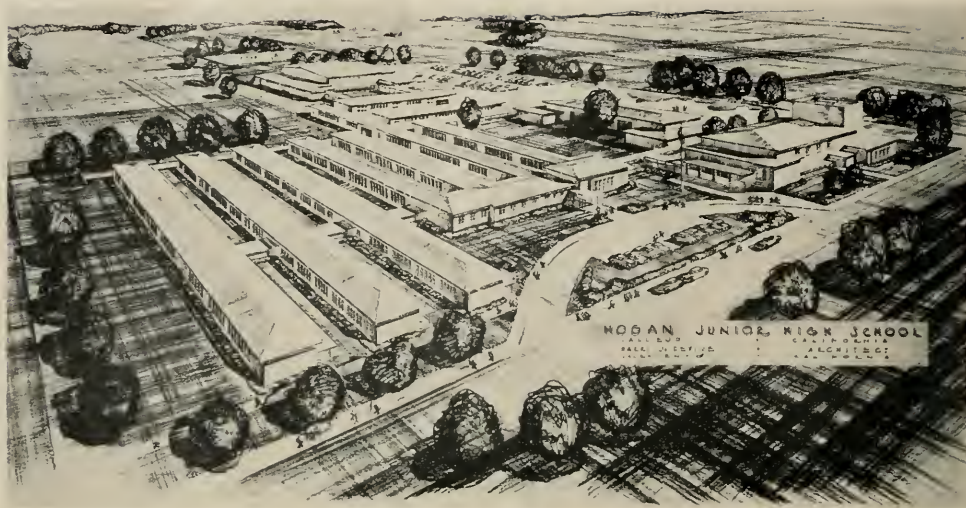

HARRY J. DEVINE, A.I.A., Architect

mer resort city in business for himself, then moved to San Francisco to become superintendent for the late Ed Garren and later for Cahill Bros.

Among the outstanding Bettancourt construction jobs, illustrated in this issue of Architect & Engineer magazine, is the Dr. James Hogan High School at Vallejo which was designed by architect Harry J. Devine, AIA of Sacramento, and represents an expenditure of more than \$2,000,000 in school funds by the Vallejo School Board. The project, one of the largest of its kind in the State, consists of a

group of thirteen separate buildings with Bettancourt the successful bidder on all but two units. All units are single story in height and combined occupy a thirty acre site. A notable feature of the school is the heating system, radiant heat, with pipes concealed beneath the main corridors and within convenient reach in case of emergency.

Besides a group of Safeway Stores up-and-down the "Peninsula", the Bettancourt organization built the San Bruno City Hall; the American Trust Bank

(See Page 20)

PARTIAL VIEW . . . two of thirteen units.







**ABOVE VIEW**—Shows main corridor of the Dr. James Hogan, Jr., High School, Vallejo. It is 700 feet long and 18 feet wide. Flooring is ceramic and asphalt tile. Lockers are a part of 1200 installations.

**LOWER VIEW**—Shows the Library of the Dr. James Hogan, Jr., High School.





in San Bruno; the California National Guard Maintenance Shop in Stockton, one of the largest State armories in California; an addition to the Yolo County Hospital at Woodland; a warehouse for the Redwood City Wholesale Grocery Com-

pany; warehouse for the Turlock Cooperative Growers at Salida; the Thermalito Elementary School near Oroville, Butte county, designed by Koblick and Fisher of Sacramento; and numerous residences. At present the firm is building the

(See Page 23)



**AMERICAN TRUST COMPANY  
San Bruno Branch**

Top View shows exterior of branch bank building.

View at left shows the bank's interior with customer facilities and some building detail.



**ELMER LAFAYETTE CAVE  
ELEMENTARY SCHOOL**  
Designed by architect  
Jacob Joseph Buchter to  
serve as a primary school  
for the City of Vallejo.

**Building  
With  
Bettancourt..**

Joseph Bettancourt, busy California Contractor, has used 3,730 Worley Steel lockers—manufactured exclusively in California — on these recent projects:

**DR. JAMES HOGAN  
JUNIOR HIGH SCHOOL**

•  
**SAN MATEO GIRLS'  
HIGH SCHOOL**

•  
**SAN BRUNO PARISH  
SCHOOL**

•  
**SAN BRUNO CITY HALL**

•  
**HILLSBOROUGH GRAMMAR  
SCHOOL**

**WORLEY**  
AND COMPANY

PICO, CALIFORNIA  
SAN FRANCISCO



Multi-purpose room is shown above: Large windows for natural lighting, plus overhead lights and draw curtains on windows to regulate light. Acoustic ceiling, asphalt tile floor.





**MATTHEW LEHMAN, Structural Engineer**



**SAFEWAY STORE**

New building for Safeway in San Bruno, embodies all latest construction design of a grocery store.

**INTERIOR VIEW** at left, shows overhead lighting, sound-proof ceiling, check-outs.

**Reinforcing Steel  
for Monte Gardens School**

Concord  
J. BETTANCOURT, GENERAL CONTRACTOR

*furnished by*  
**GILMORE FABRICATORS**

1401 MIDDLE HARBOR ROAD, OAKLAND  
PHONE: TE 2-8974

**REGAL ROOFING**

One of our most recent jobs—Bay View Elementary School, San Pablo, under construction.

**REGAL ROOFING CO.**

930 INNES AVENUE • SAN FRANCISCO  
Phone: VAlencia 4-3261



**HILLSBOROUGH ELEMENTARY SCHOOL**—Designed by the architectural firm of Kump & Falk and constructed for the City of Hillsborough, San Mateo county. It is an eighth grade school comprising a multiple purpose room, eight classrooms, and a cafeteria. Exterior is wood facing, roof is shake wood.

(From Page 20)

Bay View Elementary School in San Pablo of which Schmidts and Hardman are the architects and is illustrated on the cover of this issue.

Bettancourt is a member of Pacific Parlor No. 10, Native Sons of the Golden West; Elks Club of San Mateo; past president of the San Bruno Exchange Club; past president of the San Bruno Chamber of Commerce, and a member of the San Bruno Planning Commission over a twelve year period. His hobbies are hunting, fishing, and his family—a happy one of a wife and two daughters.

## STRUCTURAL STEEL

and

## MISCELLANEOUS IRON

for

Dr. Hogan Jr. High School

Vallejo

Fabricated and Erected by

**GOLDEN GATE IRON WORKS, INC.**

1525-57 Howard Street, San Francisco

## Congratulations

to J. BETTANCOURT

General Contractor & Builder

**ATLAS HEATING & VENTILATING CO., LTD.**

— Everything in Heating —

557-567 FOURTH STREET, SAN FRANCISCO

## MINTON LUMBER COMPANY

Incorporated

## MILLWORK

599 Front Street

Mountain View, California

Phone: **YORKSHIRE 7-5523**



**MODERNISTIC CITY HALL**—Designed by Architect William Henry Rowe, A.I.A., and constructed to serve the fast growing City of San Bruno in San Mateo county. Site of the new building required that special attention be given to sun and natural daylighting, a problem solved by use of interesting design on front of the structure.

## MILCOR TRIM STEEL PRODUCTS

- Access Panels
- Metal Base, Chairrails, etc.
- Metal Chalk Troughs & Trim
- Louvres - Ventilators
- Escape Hatches - Fire Extinguisher Cabinets
- Letters - Plaques
- Office Partitions
- Hollow Metal & Kalamine Doors & Frames

(Labeled and Non-Labeled)

*Call Us On Your Problems*  
— in —  
PRESSED METAL SPECIALTIES

*Engineered Metals, Inc.*

575 MISSION STREET  
SAN FRANCISCO, CALIF.  
YUKON 2-3830

## LATHING & PLASTERING

ON THE  
DR. HOGAN AND ELMER CAVE  
SCHOOL BUILDINGS,  
VALLEJO, BY

**L. N. JOHNSON & SON**

401 COUCH STREET, VALLEJO

Phone: 3-7828

## STEELFORMS

For  
CONCRETE JOIST CONSTRUCTION  
ROUND COLUMNS      BEAM AND SLAB  
FOUNDATION WALLS

**STEELFORM CONTRACTING CO.**

666 HARRISON ST. — SAN FRANCISCO

833 E. GAGE AVE. — LOS ANGELES





COMMERCIAL—Among commercial type buildings constructed is the warehouse for the Redwood Wholesale Grocery Company at Redwood City.

## REINFORCING STEEL

for the Bayview School  
San Pablo

*furnished by*

**RICHARDS REINFORCING STEEL CO.**  
2850 Hannah Street, Oakland  
TEmplebar 2-4371

## MILLWORK

MONTE GARDENS SCHOOL, CONCORD

*by*

**CLINTON MILL & MFG. CO.**  
345 EAST SEVENTH STREET, OAKLAND  
PHONE: GL 1-9480

## California Builders Hardware Company

MAIN OFFICE AND WAREHOUSE  
17 BLUXOME ST. • SAN FRANCISCO 7, CALIF.  
YUkon 2-5690

•

BRANCH OFFICE AND STORE  
2563 SAN PABLO AVE. • OAKLAND 12, CALIF.  
TWinoaks 3-7732

## CERAMIC AND ASPHALT TILE FLOORS

*Dr. James J. Hogan School, by*

## UNITED FLOOR COVERING CO.

2313 Sonoma Blvd., Vallejo  
Phone: Vallejo 3-4593

# LUMBER

- DOUGLAS FIR
- REDWOOD
- PONDEROSA PINE
- SUGAR PINE
- PLYWOOD
- SHINGLES
- LATH



JUniper 5-6083

**GAMERSTON**

&

**GREEN**

LUMBER CO.

535 TUNNEL AVE.

SAN FRANCISCO

Phone JUniper 5-6083



WILLIAM HENRY ROWE, A.I.A., Architect

## CITY HALL — SAN BRUNO

### ARCHITECTURAL DETAILS

of the impressive new  
City Hall built for the  
City of San Bruno.

Note provision in architect's  
design for elimination of  
direct sun glare.

*for all types of  
construction*

**DONOVAN  
UNIVERSAL  
ALUMINUM  
WINDOWS**

**CASEMENT  
PROJECTED  
AWNING**

*Write today for literature, details  
and specifications*



**UNIVERSAL WINDOW CO.**

950 Parker Street

Berkeley 10, California

SALES REPRESENTATIVES:

Contact us regarding available exclusive territories.

**OVER 30 YEARS OF WINDOW EXPERIENCE**

**VAULT DOORS**  
and  
**SAFE DEPOSIT BOXES**  
**SAN BRUNO CITY HALL**  
by  
**THE HERMANN SAFE CO.**  
HOWARD & MAIN STS.  
SAN FRANCISCO



RESIDENCE—The attractive home of Mr. and Mrs. Douglas J. Shaw of Hillsborough, is a typical example of Bettancourt's construction.

**E. M. HUNDLEY HARDWARE CO.**

*Specialists in*

**Builders Hardware**



662 MISSION STREET      SAN FRANCISCO  
YUkon 2-3322

*CONCRETE AND PLASTERING  
MATERIALS*

furnished by

**VALLEJO BUILDING MATERIALS CO.**

512 SOLANO AVENUE  
VALLEJO, CALIFORNIA  
PHONE 8-8987

**GENERAL HOTEL SUPPLY CO.**

*Designers • Manufacturers • Distributors*

EQUIPMENT, FIXTURES AND SUPPLIES for  
Restaurants, Bars, Hotels, Hospitals, Schools, and  
Institutions

953-955 MISSION STREET  
SAN FRANCISCO 3, CALIF.

**J. BETTANCOURT BUILDER**

on the following buildings

DR. JAS. J. HOGAN JR. HIGH SCHOOL  
VALLEJO, CALIFORNIA

SPRINGS ROAD ELEMENTARY SCHOOL  
VALLEJO, CALIFORNIA

ARMORY FOR CALIFORNIA NATIONAL  
GUARD  
VALLEJO, CALIFORNIA



# American Institute

Clair W. Ditchy, President  
Norman J. Schlossman, 1st Vice-President  
Howard Eichenbaum, 2nd Vice-President  
George Bain Cummings, Secretary  
Maurice J. Sullivan, Treasurer



# of Architects

National Headquarters—  
1741 New York Avenue, N. W.  
Washington, D. C.  
Edmund R. Purves  
Executive Secretary

## Arizona Chapter:

Lew Place (Tucson), President; Ralph Haver (Phoenix), Vice-President; Fred O. Knipe (Tucson), Secretary; James W. Elmore (Phoenix), Treasurer. Secretary Offices, 1324 E. Lester St., Tucson.

## Coast Valleys Chapter:

Kurt Gross, President; Harold Ahnfeldt, Vice-President; Frank C. Tressder, Secretary; Jerome Kasavan, Treasurer. Directors, Hollis Logue and Gifford Sobey. Offices, 82 S. 3rd St., San Jose.

## Central Valley of California:

John W. Bomberger, President; Nicholas Tomich, Vice-President; Albert B. Thomas, Secretary; Ted de Wolf, Treas.; Gordon Stafford, Director; Alternates to CCA, Silvio Barovetto; Sec. Office 718 Alhambra Blvd., Sacramento.

## Colorado Chapter:

James M. Hunter, President, 2049 Broadway, Boulder; Casper F. Hegner, Secretary, 1659 Grant Street, Denver 5.

## East Bay Chapter:

Malcolm D. Reynolds, President; Donald Hardison, Vice-President; John Lloyd, Secretary; Ed Cerruti, Treasurer. Directors: Chester Treichel, Ira Beais, Cecil Moyer. Secretary's office: 1171 Solano Ave., Albany.

## Idaho Chapter:

Frederick C. Hummel, President; Jack Woodmansee, Vice-President; Jed Jones III, Sec.-Treas. Offices 1324 Idaho Street, Boise, Idaho.

## Montana Chapter:

E. Edward Sowercraft, President (Billings); J. Van Teylingen, Vice-President (Great Falls); H. C. Cheever, Secretary-Treasurer. Secretary office, Bozeman.

## Nevada Chapter:

Walter Zick, President, Las Vegas; Russell Mills, Vice President, Reno; Keith Lockard, Secretary, Reno; Directors Edward Parsons, L. A. Ferris, David Vhay, Reno. Office of President P. O. Box 2107, Las Vegas.

## Nevada State Board of Architects:

Russell Mills, Chairman, Reno; Aloysius MacDonald, Secretary, Las Vegas; Edward Parsons, L. A. Ferris, Reno, and Richard Stadleman, Las Vegas, Members. Office, 309 S. 5th St., Las Vegas.

## Northern California Chapter:

Don Emmons, President; Wendell R. Spackman, Vice-President; William Corlett, Secretary; Bernard J. Sabaroff, Treasurer. Directors: Charles S. Pope, Wm. Stephan Allen and Lawrence A. Kruse. Helen H. Ashton, Office Sec., Office, 26 O'Farrell St., San Francisco.

## CALIFORNIA COUNCIL OF ARCHITECTS

Leaders of the California Council of Architects, under the presidency of Charles E. Fry, AIA, Los Angeles, are completing plans for the Annual Convention of the Council which is to be held in Coronado on October 15-16-17.

Remember it's

# KRAFTILE

- for ★ GLAZED STRUCTURAL WALL UNITS  
★ PATIO TILE  
★ FACE AND ROMAN BRICK  
★ ACID FLOOR BRICK  
★ HEARTH BRICK  
★ BRICKETTES  
★ MINWAX TILE & CONCRETE FLOOR FINISH

For complete information and prompt service, phone or write

## KRAFTILE COMPANY

NILES, CALIFORNIA NILES 3611

LOS ANGELES 13, 406 South Main Street—MUtual 7241

Attending a preliminary meeting in Coronado recently were: Malcolm Reynolds, Oakland, vice-president; Lawrence Gentry of Los Gatos, secretary; Louis Dean, San Diego, treasurer; Frank Hope, San Diego, Convention Manager; William Glenn Balch, Los Angeles; Donald Beach Kirby, San Francisco; William Koblik, Sacramento; Arthur Gallion, Dean of Architecture, University of Southern California; John Rex, Los Angeles; Frank Mayo, Stockton, and Frederick A. Chase, executive secretary of the Council.

## OREGON CHAPTER

Holman J. Barnes, AIA, architect of Portland, was chosen to serve as president of the Chapter for the ensuing year at the annual election meeting. Named to serve with Barnes were: Albert W. Hilgers, vice-president; Donald W. Edmundson, secretary; Dewitt C. Robinson, treasurer, and H. Abbott Lawrence, trustee.

Tentative plans for the new year were discussed and president Barnes announced full committee appointments and Chapter activities would be announced in the near future.

## NORTHERN CALIFORNIA CHAPTER

Recent developments in the Civic Center Master Plan for the City and County of San Francisco, and establishing the Chapter in new quarters at 26 O'Farrell Street, have taken almost full time of president Donn Emmons and the membership.

A statement was prepared on architect participation in the city's program of planning and submitted to the Committee on Buildings, Parks and City Planning, the Board of Supervisors and others. The statement, including an outline of the cost

#### Orange County Chapter:

Paul O. Davis (Los Angeles), President; Ralph Modjeski (Santa Ana), Vice-President; Geo. Lind (Newport Beach), Secretary; Wm. L. Faulkner (Santa Ana), Treasurer. Secretary's Office: 2919 Newport Blvd., Newport Beach.

#### Oregon Chapter:

Holman J. Barnes, President; Albert W. Hilgers, Vice-President; Donald W. Edmundson, Secretary; DeWitt C. Robinson, Treasurer, and H. Abbott Lawrence, Trustee. Office of Secretary, 323 Henry Bldg., Portland.

#### Pasadena Chapter:

Robert E. Langdon, Jr., President; Wallace C. Bonvall, Vice-President; Robert L. Deines, Secretary; Henry C. Burge, Treasurer; and Directors John N. Douglas, R. VanBuren Livingston, Scott Quintin and Burton Romberger. Offices: 259 South Los Robles Ave., Pasadena 5.

#### San Diego Chapter:

Donald Campbell, President; Victor L. Wulff, Jr., Vice-President; Richard L. Pinnel, Secretary; Edward G. Holliday, Treasurer; Louis A. Dean, Director. Office Sec., San Diego Trust & Savings Bldg.

#### San Joaquin Chapter:

Maurice J. Metz (Fresno), President; Allastair Simpson, Vice-President; Al Bailey, Secretary; Robert Stevens, Treasurer. Directors: David H. Horn, Wm. Hyberg, Robert Kaestner. Secretary's Office, Fresno.

#### Santa Barbara Chapter:

Miss Lulah Maria Riggs, President; Roy C. Wilson, Vice-President; Chester L. Carjola, Secretary; Roy W. Chessman, Treasurer. Corres. Sec'y: Richard E. Nelson, 3033 Calle Rosales, Santa Barbara.

#### Southern California Chapter:

Henry L. Wright, President; U. Floyd Rible, Vice-President; Cornelius M. Dacey, Secretary; Savo M. Stoshitch; Hugh R. Davies, S. Kenneth Johnson, Kemper Nomland and Chas. E. Fry, Directors.

Headquarters, 3723 Wilshire Blvd., Los Angeles 5.

#### Utah Chapter:

W. J. Menroe, Jr., President, 433 Atlas Bldg., Salt Lake City; M. E. Harris, Jr., Secretary, 703 Newhouse Bldg., Salt Lake City.

#### Washington State Chapter:

Paul Thiry, President; John S. Dettle, 1st Vice-President;

Robert H. Wohleb, 2nd Vice-President; Robert H. Dietz, Secretary; and Edwin T. Turner, Treasurer. Alice Gregor, Executive Secretary, 430 Central Building, Seattle 4.

#### Spokane Chapter:

B. K. Ruelh, President; Victor L. Wulff, 1st Vice-President; Philip Keene, 2nd Vice-President; Laurence G. Ewanoff, Secretary, and Carroll Martell, Treasurer. Office 515 American Legion Bldg., Spokane, Washington.

#### Tacoma Society:

E. N. Ducon, President; P. G. Ball, Vice-President; Lyle Swedberg, Secretary-Treasurer.

#### Hawaii Chapter:

Kenji Onodera, President, 3518 McCarriston St., Honolulu, T. H.; George J. Wimberly, Secretary, 315 Royal Hawaiian Ave., Honolulu, T. H.

#### CALIFORNIA COUNCIL OF ARCHITECTS

Charles E. Fry, President, Los Angeles; Malcolm D. Reynolds, Oakland, Vice-President; Lawrence Gentry, Los Allos, Secretary; Louis A. Dean, San Diego, Treasurer; Fred A. Chase, Executive Secretary, 3723-A Wilshire Blvd., Los Angeles.

#### CALIFORNIA STATE BOARD ARCHITECTURAL EXAMINERS:

Earl T. Heitschmidt (Los Angeles), President; Geo. P. Simonds (Oakland), Secretary; Norman Blanchard (San Francisco); C. J. Paderewski (San Diego); Ulysses Floyd Rible (Los Angeles), Exec. Sec'y: Robert K. Kelley, Room 712, 143 S. Spring St., Los Angeles; San Francisco Office, Room 300, 507 Polk Street.

#### ALLIED ARCHITECTURAL ORGANIZATIONS

##### San Francisco Architectural Club:

Joseph Scuma, President; Frank S. Gerner, Vice-President; Russell W. Pennell, Treasurer; Frank L. Barsotti, Secretary. Club Quarters: 507 Howard St., San Francisco.

##### Producers' Council—Southern California Chapter:

Bert Taylor, President, Pittsburgh Plate Glass Company; G. Robert Roden, Jr., Vice-President, Truscon Steel Company; Malcolm G. Lowe, Secretary, Natural Gas Equipment Inc.; Richard Seaman, Treasurer, W. P. Fuller & Company; Vern Boget, National Director, Gladding McBean & Co.

Producers' Council—Northern California Chapter (See Special Page)

estimates, was prepared by the Chapter's Area Planning Committee as a public service.

The new Chapter headquarters represent something startling in architectural decor and have commanded considerable favorable attention from many.

#### PASADENA CHAPTER

W. L. Holladay, representing the firm of Holladay & Westcott, was the principal speaker at the August meeting, taking as his subject the timely consideration of "Building for the Hot-Arid Climate." A refrigeration and air conditioning engineer, Holladay's discussion covered building design including human comfort, shading, ventilation, wetted roofs, evaporative cooling and air conditioning.

A number of Chapter matters were also presented for membership consideration.

#### LOS ANGELES ARCHITECTS OFFER SERVICES TO COUNTY

The Southern California Chapter of The American Institute of Architects has volunteered its services to the Los Angeles County Board of Supervisors to help facilitate selection of architects for the county's proposed 1953-54 building program.

Architect Henry L. Wright, president of the Chapter, pointed out in a letter to the Board of Supervisors that the county had adopted a comprehensive and equitable system of selecting qualified architects for county building work in the past and suggested that such a procedure be adopted again.

#### ARCHITECTS AWARD HONORS TO DR. GORDON M. BUTLER

Dr. Gordon M. Butler, dean emeritus of the University of Arizona, was elected to honorary

(See Page 36)

## Fight EFFLORESCENCE On Brick, Stucco, Concrete with **DARACONE** INVISIBLE WATER-REPELLENT

DARACONE is the proven way to combat leaks, efflorescence and stains in any type of above-grade exterior masonry.

DARACONE penetrates deeply into masonry, lining pores and hair-line cracks with an insoluble water repellent. Clear and colorless, it does not affect natural appearance or "breathing" qualities of the building. Long-lasting.

Distributed By



CONTACT THE NEAREST P.C.A. SALES OFFICE

SAN FRANCISCO  
SACRAMENTO

OAKLAND  
STOCKTON

SAN JOSE  
FRESNO

# WITH THE ENGINEERS

## Structural Engineers Association of California

John E. Rinne, President, San Francisco; Jack S. Barrish, Vice-President, Sacramento; Leslie W. Graham, Secretary-Treasurer, San Francisco. Directors John J. Gould, R. W. Binder, M. A. Ewing, Leslie W. Graham, Jack S. Barrish, Harold P. King, W. T. Wheeler, John E. Rinne and Donald F. Shugart. Secretary's office, c/o Associated Structural Engineers, 417 Market St., San Francisco 5.

## Structural Engineers Association of Northern California

George A. Sedgwick, President; Michael V. Pregonoff, Vice-President; John M. Sardis, Secretary; William K. Cloud, Treasurer; Robert P. Moffett, Asst. Sec.-Treas.; Directors, Robert D. Dalton, Robert D. Dewell, William H. Ellison, John J. Gould and J. Albert Paquette. Offices: 417 Market St., San Francisco.

## Structural Engineers Association of Central California

William H. Peterson, President; Walter S. Wassum, Vice-President; O. T. Illerich, Sec.-Treas.; Ernest D. Francis, M. A. Ewing, and Arthur A. Sauer, directors. Office O. T. Illerich, c/o Div. of Arch., Sacramento.

## American Society of Civil Engineers Los Angeles Section

Trent R. Dames, President; Stephenson B. Barnes, Vice-President; John M. Server, Vice-President; C. Martin Duke, Secretary, and John Merrell, Jr., Treasurer. Office of Secretary, 3066 Engineering Building, University of California, Los Angeles 24. BRANCHES: Orange County Branch, Harold Sprenger, Pres; Raymond R. Ribal, V-P; Earl K. Burdick, Sec-Tr, 12311 Chapman, Anaheim. San Bernardino-Riverdale Counties Branch, Albert A. Webb, Pres; Wright M. Price, V-P; John L. Merriam,

## STRUCTURAL ENGINEERS ASSOCIATION OF CALIFORNIA—ANNUAL MEETING

Plans are being set for the Annual Convention of The Structural Engineers Association of California to be held this year at the Ahwahnee Hotel in Yosemite Valley from October 8 to 10 inclusive.

Charles Scurich, general chairman of the convention committee, predicts from advance interest in the conference, that it will be one of the best attended conventions ever held by the Association, and that the varied program of technical discus-

sions and entertainment will attract leading engineers from many sections of the nation.



*Structural Engineers Association of California members completing plans for their annual convention to be held in Yosemite, October 8-9-10, 1953: Wesley W. Graham (left), Sec.-Treas. of state association; Charles G. Scurich, general chairman of convention committee; John E. Rinne, president of the state association; John J. Gould, delegate representing the Northern Section on the board of directors of the state association.*

**for CONSISTENCY,  
ALWAYS SPECIFY **HAWS**  
ELECTRIC  
WATER  
COOLERS**



When you specify HAWS Electric Water Coolers, you are specifying a source of refreshing drinking water that is:

- Consistent in good design
- Consistent in sanitation
- Consistent in mechanical dependability

There is a HAWS Electric Water Cooler for every requirement.

See Sweet's... or write for new HAWS Catalog...NOW!

**HAWS DRINKING FAUCET CO.**  
1443 FOURTH STREET • BERKELEY 10, CALIFORNIA

Arrangements being made by the Northern Section of the Association for the convention, include the following program speakers:

Frank B. Durkee, Director of Public Works, State of California; Verne Ketchum, Timber Structures, Inc. of Portland, Oregon; T. R. Higgins, American Institute of Steel Construction, New York City; Arthur R. and Toni Anderson, co-owners of Concrete Engineering Co., Tacoma, Washington; J. T. Sirveira, Pacific Fire Rating Bureau, Los Angeles; Prof. N. M. Newmark, Research Prof. of Engineering, University of Illinois; and J. G. Wright of Earl & Wright Consulting Engineers, San Francisco, California.



Sec-Tr; 4865 Park Ave., Riverside. Ventura-Santa Barbara Counties Branch, Robert L. Ryan, Pres; Richard E. Burnett, V-P; George Conchey, Sec-Tr, 649 Doris St. Oxnard.

**American Society of C. E.  
San Francisco Section**

J. G. Wright, President; J. E. Rinne, Vice-President; Howard C. Wood, Vice-President; John S. Longwell, Past President; H. C. Medbery, Secretary, and Richard C. Clark, Treasurer. Office Secretary, S. F. Water Dept., Millbrae.

**Structural Engineers Association of  
Southern California**

Ben Benioff, President; William T. Wright, Vice-President; Charles M. Corbit, Jr., Sec-Treas. Directors: Ben Benioff, William T. Wright, Harold P. King, Henry M. Layne, Joseph Shellet, Robert J. Kadow and Harold Omsted, Offices, 121 S. Alvarado St., Los Angeles 4.

**Structural Engineers Association of  
Oregon**

Lewis R. Ellingwood, President; Robert M. Bonney, Vice-President; Sully A. Ross, Secretary-Treasurer. Directors William J. Dornier, Roger V. Gillam, Leslie E.

Poole, Rowland S. Rosé. Offices 706 Board of Trade Bldg., 310 S.W. 4th Ave., Portland 4.

**Society of American Military  
Puget Sound Engineering Council  
(Washington)**

R. E. Kister, A. I. E. E., Chairman; E. R. McMillan, A. S. C. E., Vice Chairman; L. B. Cooper, A. S. M. E., Secretary; A. E. Nickerson, I. E. S., Treasurer. Offices, L. B. Cooper, c/o University of Washington, Seattle 5, Washington.

**American Society Testing Materials  
Northern California District**

L. A. O'Leary, Chairman; P. V. Garin, Vice-chairman; H. P. Hoopes, Sec. Office Sec., 1550 Powell St., Emeryville, Calif.

**Society of American Military  
Engineers—San Francisco Post**

CDR N. M. Martinsen, President; L. L. Wise, 1st Vice-President; Col. Paul Berriagan, 2nd Vice-President; R. M. Hamilton, Secretary; Thomas Hurley, Treasurer. Directors, RADM C. A. Trexel, J. G. Wright, LTCOL C. S. Lindsey, C. E. Bentley, F. R. Fowler, BRIGEN D. F. Johns, and RADM L. N. Moeller.

**STRUCTURAL ENGINEERS ASSOCIATION  
OF SOUTHERN CALIFORNIA**

The August meeting was the Annual Field Day, observed this year at the Oakmont Country Club in Glendale, and included contests of baseball, swimming, and golf. Following a full day of outdoor activities the evening was devoted to the Annual Dinner and entertainment program, admitted by all in attendance as an outstanding success.

**NEW MEMBERS:** Thomas G. Atkinson. **ASSOCIATE members:** Robert L. Armstrong and George Youngclaus. **JUNIOR member:** Robert G. Niebur.

**FEMINEERS**

The FEMINEERS of San Francisco held a Chinese Auction Sale at their regular July meeting with proceeds going into the Program Fund. Following the "sale" members enjoyed Bridge and Canasta.

Articles offered at the Auction were all donated by members.

Mrs. E. D. Kahler was in charge of the program.

**STRUCTURAL ENGINEERS ASSOCIATION  
OF NORTHERN CALIFORNIA**

The August meeting, arranged by the Junior Activities Committee, featured a talk on the "St. Mary's Square Garage" by Tom Wosser, Jr.; "Use of Marginal Land in Construction" by Ned P. Clyde, and "Use and Economies of Belled Footings and Drilled In-Place Piles" by Fred Pavlow.

A number of reports were given and attention called to the Annual SEAOC Convention, scheduled for October 8-9-10 at Yosemite.

**NEW MEMBERS:** Include A. L. Brinckman, Civil Engineer, Taylor Roof Structures; Milton F. Bourke, Design Engineer, Columbia-Geneva Steel Co.; Weldon L. Richards, Partner, The Pacific Company; and Robert F. Wildman, Partner, Wildman

& Morris. **AFFILIATE MEMBER,** Charles E. Denton, Draftsman, Hall, Pregnoff & Matheu.

**ARIZONA HIGHWAY ENGINEER  
WINS GMC ESSAY AWARD**

William E. Willey, head of the Division of Economics and Statistics, Arizona State Highway Department, is one of the six top winners in General

(See Page 35)

**Both are NEW both are distinctive**



**HAWS Model No. 7G**

the latest member of a "name" family, combines new beauty with the utility and reliability for which HAWS has been famous since 1909.

**The New 56-Page  
HAWS CATALOG**

thoroughly describes and illustrates HAWS complete line of Sanitary Drinking Fountains, Faucets, Electric Water Coolers and HAWS Emergency Eye-Wash Fountains and Drench Shower Equipment. Send for it today...study it...you'll see why it always pays to specify HAWS.



**HAWS DRINKING FAUCET CO.**  
1441 FOURTH STREET (Since 1909) BERKELEY 10, CALIFORNIA

# PRODUCER'S COUNCIL PAGE

The National Organization of Manufacturers of Quality Building Materials and Equipment  
(Northern California Chapter) affiliated with THE AMERICAN INSTITUTE OF ARCHITECTS

President, Roly MacNichol  
Libbey-Owens-Ford Glass Co.  
Rialto Bldg.

Vice-President, Ted Bakeman  
F. W. Wakefield Brass Co.  
445 Bryant Street

Secretary, John Cowley  
Hamilton Manufacturing Co.  
2833 3rd Street

Treasurer, Carl Frank  
Detroit Steel Products Co.  
Russ Building

Edited by Stanley L. Basterash, WESTERN ASBESTOS COMPANY.

About three years ago The Producers' Council decided to present a Fifty Dollar (\$50.00) book award to a deserving architectural student at the University of California.

For the third year The Producers' Council presented this award at the Architectural Department's annual award presentation ceremony.

This award is presented during the June graduation ceremonies, the recipient being one selected by a committee from the School of Architecture at the University. The award presentation serves several functions, the chief of which is to contribute to the encouragement that awards of this type have on the efforts of the student architect. In addition, the award indicates to the architectural profession that we are vitally interested in the future members of their profession. Of equal importance, it affords us the opportunity to introduce the advanced members of the student body to The Producers' Council by permitting a minute or two in the presentation for us to explain the function of the Council.

The award was started on an experimental basis, but the results have been so satisfactory it is recommended that the Council adopt it as a continuing award. In this way The Producers' Council is cementing itself into a closer relationship with the more generous awards of the Northern California and East Bay Chapters of the AIA, the Women's Architectural League of the East Bay and San Francisco.

We take this opportunity to present in this issue the various committee chairmen of the Producers' Council for the coming year.

These men are taking active part in the Council for furtherment of your objectives and aims of the Council. The acceptance of an office not only affords the opportunity of the individual to become better acquainted with workings of the organization and the membership, but adds a considerable amount of necessary and sometimes burdensome activity to serve the best interests of the Architect, Engineer, and the Council. Though the reader may not be represented by firm name or individual on the executive committee, we of the committee know there is many a good idea that the Council could consider and put in force if it were brought to the attention of the executive committee. We want these ideas! We urge the Architect, Engineer, and Producer Council members to contact any of the committee chairmen, in writing or by telephone. In this way you too are taking active participation in the Council.

#### Membership

John O'Connor  
H. H. Robertson

#### Education

Philip F. Brown  
Otis Elevator Co.

#### Program

C. T. Bakeman  
Ted Bakeman &  
Associates

#### Public Relations

Stanley L. Basterash  
Western Asbestos Co.

#### Finance

Wm. Daniels  
F. K. Pinney Co.

#### Entertainment

Harris M. Wilkinson  
Pittsburgh Plate Glass

#### Advisory

A. L. West  
Aluminum Co. of  
America

#### Fellowship

Richard Pederman  
The E. F. Hausermann  
Company

USE QUALITY PRODUCTS



CONSULT AN ARCHITECT

# Philippine Mahogany Association

HELD AT CARMEL-BY-THE-SEA, CALIFORNIA



**W. G. SCRIM, President, Philippine Mahogany Association, Inc. (seated) and son George, sec.-treas., inspect catalog issued by Association.**

One of the most successful and outstanding national conferences of the Philippine Mahogany Association, Inc., was held at the La Playa Hotel, Carmel-By-The-Sea, California, with representatives and members of their families present from all parts of the nation and the Philippines.

Many subjects of great importance to the industry were considered during the scheduled business meetings presided over by Walter G. Scrim, president. Among top consideration was the Association's advertising program which has proven so successful during the past few years, with plans being completed for a continuance of the program for the current fiscal year.

At the annual election of officers Walter G. Scrim was reelected President; Howard R. Black was chosen Vice-President, and George D. Scrim was elected Secretary-treasurer.

Special entertainment was provided for the ladies during the business sessions including golf and sightseeing motor trips throughout the Carmel area. Serving as an Entertainment Committee were: Mmes. Robert S. Osgood, Frank J. Connolly, John G. Ziel, H. A. Evans, J. Raymond Peck and Harry Lilly.

H. A. J. Evans presided over the Annual Dinner and acted as Master of Ceremonies.

Walter G. Scrim, president, is thoroughly experienced in the Mahogany lumber industry, having started in the lumber business in Quebec, Canada, in the early days and later serving the industry in various capacities until forming his own lumber business, the Scrim Lumber Co. of Los Angeles in 1923. He has attended every annual convention of the Association, except one, since its organization more than a quarter century ago.

**FRONT (L to R):** Mrs. J. C. Fellows; Mrs. H. C. Pope; Miss Margaret Groark; Mrs. H. A. J. Evans; Mrs. P. R. Kahn; Walter G. Scrim, Association president; Mrs. R. S. Osgood; Miss Jean Pope; Mrs. J. Raymond Peck; Mrs. Herbert Coffey (Diane Connolly); Mrs. Frank J. Connolly; Mrs. Philip Latasa (Shella Connolly); Mrs. LeRoy Stanton. **SECOND ROW (L to R):** G. P. Purchase; G. F. Roswell, Western Hardwood Co., Los Angeles; H. D. Florence, Atlanta Oak Flooring Co., Atlanta, Ga.; Mrs. H. S. Thompson; Leroy Stanton, Sr., Stanton & Son, Los Angeles; Mrs. G. F. Roswell; Frank J. Connolly, Westhard Importing Co., Terminal Island, Calif.; Mrs. Frank Rawolle; Miss Patsy Zeil; Mrs. Harry Lilly; Miss Betsy Zeil; Mrs. John G. Zeil; Miss Susan McNab; Harry Lilly, Norton-Lilly Co., San Francisco; John G. Zeil & Co., San Francisco; J. Raymond Peck, Insular Lumber Sales Corp., Philadelphia, Pa.; Howard R. Black, Black & Yates, Inc., Brooklyn; H. A. J. Evans, Dixie Lumber Co., New Orleans; J. G. Gudmundson, Wood Mosaic Inc., Louisville, Ky.; H. R. Kahn, Forsyth Hardwood Co., San Francisco; Herbert Coffey, Westhard Lumber Co., Terminal Island, Calif.; Harvey C. Pope, Insular Lumber Co., Manila, P. I.; Frank Rawolle, American Philippine Hardwood Co., San Francisco; **REAR ROW (L to R):** John C. Fellows, John C. Fellows Co., Los Angeles; Philip Latasa, Westhard Lumber Co., Terminal Island; R. S. Osgood, Los Angeles; Roy Barta, Mahogany Importing Co., Los Angeles; and George D. Scrim, Scrim Lumber Co., Los Angeles.





# PERSONALITIES

## SCOTT QUINTON ARCHITECT, A. I. A.

Alhambra, California

Architect Scott Quinton has conducted a pioneer architectural office in the San Gabriel Valley in Southern California since 1920, when he opened the first architects office in Alhambra.



SCOTT QUINTON  
Architect, A.I.A.

Story Building at Sixth and Broadway in the City of Los Angeles.

A graduate of the Drexel Institute in Philadelphia, Pennsylvania, he majored first in art and then in architecture. On leaving school he worked in several of the leading architectural offices in the United States, and in 1911 passed the California State Board and opened an office in the then new

With his partner, Edwin Westberg, Scott Quinton now conducts his practice in a specially designed office building on North Garfield in Alhambra.

Quinton has played an important part in the development of the architectural profession in the Southland, and in addition to support of The American Institute of Architects, served as president of the Pasadena Chapter of the A. I. A. during 1952.

*NEXT MONTH: Francis Joseph McCarthy, A. I. A. Architect of San Francisco.*

## HANDWEAVERS AND DESIGNERS FIFTH ANNUAL EXHIBITION

The Fifth Annual Exhibition of Contemporary Handweavers being shown at the M. H. deYoung Memorial Museum in Golden Gate Park, San Francisco, this month features eighteen interiors by leading California interior designers and weavers. The Exhibition also includes an extensive display of fabrics illustrating the new trends in handweaving.

The show was planned by Architect Joseph Esherick and the interiors on display include living room, dining room, bedrooms, and a doctor's office by Edgar Frank. Working with interior decorators of their own choice, weavers have illustrated the importance of handwoven fabrics in

A large advertisement for M. Greenberg's Sons Bronze Products. The background is a collage of various bronze items, including vases, figurines, and decorative pieces. Overlaid on this background is the text "BRONZE PRODUCTS by GREENBERG" in large, bold, black letters. The word "by" is in a smaller, cursive font.

Your best and nearest source for standard and special Bronze products



STABILITY since 1854

M. GREENBERG'S SONS

765 Folsom St. San Francisco, Calif. EXbrook 2-3143

Manufacturers of Fire Hydrants and Fire Protection  
Brass Goods • Industrial, Navy and Maritime  
Bronze Valves and Fittings • Plumbing and  
Hardware Brass Specialties • Bronze Plaques,  
Letters and Name Plates.

LOS ANGELES • PHOENIX • SEATTLE • PORTLAND • SPOKANE • SALT LAKE CITY • DENVER • KANSAS CITY • NEW ORLEANS • HONOLULU • NEW YORK • WASHINGTON, D. C.

contemporary interiors with fabrics assuming new roles.

## WITH THE ENGINEERS

(From Page 31)

Motors Corp. "Better Highways" essay contest featuring the subject "How to Plan and Pay for the Safe and Adequate Highway We Need."

Willey received a check for \$3000 as one of the three top honorable mention winners at a dinner in Detroit.

Other honorable mention winners were: David C. Guilbert, Spokane, Washington, manager of the Inland Automobile Association; and William F. Steuber, Jr., Madison, Wisconsin, assistant to the Wisconsin State Highway Engineer.

Winner of the first place and \$25,000 was Robert Moses of New York City, construction co-ordinator and commissioner of parks.

## CALIFORNIA TECH DENIED N.L.R.B. EXEMPTION

The National Labor Relations Board has refused to allow the exemption to California Institute of Technology it usually grants to educational institutions with reference to the operation of a wind tunnel for the benefit of airplane manufacturers and other industrial users.

Despite claims of California Tech in behalf of its non-profit status, the claim for exemption was denied because of the commercial nature of the project.

## OPENS ENGINEERING OFFICE

Jack Martin, formerly with the Southern California engineering firm of Brandow & Johnston, has opened his own offices at 1820 Wilshire Blvd., Los Angeles.

## AMERICAN INSTITUTE OF STEEL CONSTRUCTION

The American Institute of Steel Construction announced the ten \$1000 scholarships in civil or



**UNIVERSITY  
LIBRARY  
FURNITURE**

Berkeley, California

Manufactured and  
Installed by

## THE FINK & SCHINDLER CO.

Since 1882

552 Brannan Street San Francisco, Calif. EXbrook 2-1513

**RAMUC MASONRY PAINT**  
years more protection for less cost!

RAMUC Masonry Paint is a water-proof, natural rubber base coating that protects stucco, concrete and unglazed surfaces for years . . . average 2 to 5 years longer than other masonry paints. This maximum protection means lower painting cost. Does not crack, peel or chip. Is not affected by lime or moisture. Resists deterioration by heat and cold. Color bases are non-fading titanium pigments. RAMUC is easily cleaned . . . no streaks or dinginess. RAMUC Masonry Paint is available in nine pleasing, satin finish colors.

*This beautiful apartment house at 1998 Vallejo Street, San Francisco, was painted in 1946 with Peach RAMUC Masonry Paint. Still in excellent condition, the paint job is good for years more of beauty and protection for the owners.*

Write today for descriptive, specification details on RAMUC's outstanding protection that costs less.

Write Dept. A.E.

An Inertol Product **INERTOL CO. INC.**  
27 SOUTH PARK · SAN FRANCISCO 7

## Summerbell for GYMNASIUMS



SUMMERBELL glued laminated arches, in any curvature and span desired, make it easy to plan gymnasiums and field houses totally free of obstructions. Fire safety, ease of erection, flexibility for all types of lighting and provision for large door and window openings are a few of the additional advantages. Write for illustrated brochure.

High School Gymnasium, Culver City, California. Architects, Daniel, Mann & Johnson, Structural Engineer, Irving Mendenhall. General Contractor, Rains-McLellan Corp.

Glued Laminated Construction • Summerbell Bowstring Trusses  
Lamella Roofs & All Types of Timber Structures

For quality, economy and satisfaction, specify SUMMERBELL

**Summerbell ROOF STRUCTURES**  
825 EAST 29TH STREET • BOX 218, STATION "K" • LOS ANGELES 11

# IN THE WEST IT'S CALAVERAS WHITE CEMENT



Calaveras White Portland Cement is a western product for western needs. It is a true and uniform white, easy and economical to use. Order some today!

**CALAVERAS CEMENT CO.**

315 Montgomery Street • DOUGLAS 2-4224 • San Francisco 4, Calif.

**REDUCE TILT-UP  
CONSTRUCTION COSTS**

with  
**Thompson's  
WATER SEAL**

for surface slabs  
and tilt-up panels

- Locks out moisture, acts as bond breaking agent.
- Permits easy lifting of panels without suction.
- Eliminates hairline cracks for smoother concrete surfaces.
- Gives slower, more uniform curing.
- Protects against seepage, prevents efflorescence.

MANY OTHER CONSTRUCTION USES:

For lasting protection against moisture, use Thompson's Water Seal for plywood forms, concrete blocks, brick, tile, stucco, plasterboard and any other porous material.

Sold in 1, 5, 30, 55 gal. sizes. Ready to use — no mixing. Applied easily by spraying, brushing, mopping or dipping.

Available at paint, hardware or building supply dealers.

**BY-CHEMICAL PRODUCTS CO.**

1355 Market Street • San Francisco 3, California



architectural engineering to be awarded in its fourth annual scholarship program.

Winners were selected from a group of 84 high school seniors nominated by 53 steel fabricating companies in a nationwide contest. Candidates represent 25 states and were required to take college entrance examination board tests. Any one of 131 accredited colleges offering a degree in Civil or Architectural Engineering may be attended.

Among those receiving scholarships were: Delano J. Ball and Keith Slatore of San Diego, sponsored by the National Steel & Shipbuilding Corp.; and Ronald Morgenthaler of Deming, Washington, sponsored by the Leckenby Steel Co. of Seattle.

The jury of educators which made the final choices included Wesley J. Hennessy, assistant dean, Columbia University; Nichol H. Memory, director of admissions, Stevens Institute of Technology, and Robert W. Van Houten, president, Newark College of Engineering.

## A.I.A. ACTIVITIES

(From Page 29)

membership in The American Institute of Architects at the recent annual A.I.A. meeting in Seattle, Washington.

Dr. Butler was chosen for this honor in recognition of his outstanding works over many years in the legal and educational aspects of architecture and engineering.

## SOUTHERN CALIFORNIA CHAPTER

The August meeting was a "workshop" gathering with members contributing ideas and suggestions pertaining to the Chapter and to the architectural profession.

President Henry L. Wright announced extensive plans were being made for the Chapter's participation in the Annual Convention of the CCA to be held in Coronado in October.

## ARCHITECTS CONFERENCE ON RADIANT HEATING

The Department of Architecture at Pratt Institute, Brooklyn, New York, is sponsoring a series of educational meetings on "Radiant Heating" during the fall months of October and November, according to an announcement by Olindo Grossi, Chairman, Department of Architecture.

Authorities in the fields of design, research, equipment, and materials will participate in an overall analysis of this particular type of heating.

## MOBILE HOUSE LABORATORY FOR HOME PLANNING PROGRAM

A mobile house laboratory equipped on the Davis campus of the University of California will be used during the summer to determine how



homes in the central valley areas can be made more comfortable.

The research plan is to spot the specially equipped house-trailer under trees, in open fields, along creek beds, on paving, and on grass ground around the campus and near-by areas to study temperature and humidity changes in and around the mobile laboratory.

Robert B. Deering, chairman of the landscape management department, is leader of the project in cooperation with the department of agriculture engineering and home economics, and agricultural extension service.

#### CONCRETE MASONRY MANUFACTURERS' ASSOCIATION OF CALIFORNIA

Fifty-five members of the California Concrete Masonry Manufacturers Association and their wives, made a three-day pilgrimage and tour of inspection of the Builders Supply Corp. of Phoenix recently.

Various manufacturing processes and plant experiments were conducted by Dr. George G. Olson of Builders Supply.

#### OPENS NEW ARCHITECTURAL OFFICES IN SAN FRANCISCO

Announcement has been made of the formation of the architectural firm of Mulvin & Priestley, A.I.A. and opening of offices at 110 Sutter Street, San Francisco, for the general practice of architecture.

The new firm is comprised of Thomas B. Mulvin, A.I.A. and Ralph B. Priestley, A.I.A.

#### ARCHITECT BECKET IS REAPPOINTED

Architect Welton Becket, of Los Angeles, has been reappointed supervising architect of the University of California at Los Angeles current building program, according to an announcement by Chancellor Raymond B. Allen.

The present program of university expansion includes expenditures in excess of \$54,000,000.

Becket was first selected as supervising architect for the Los Angeles school in 1948.

#### NOTICE

In the July issue of ARCHITECT & ENGINEER magazine there appears an article on Page 10 pertaining to the Rancho Rafael swimming pool, Ignacio, California, as part of a general feature on swimming pool installations. Inadvertently in giving editorial recognition to John M. McWilliams, he was referred to as "Architect." Mr. John M. McWilliams is not a Registered architect but a "Designer," and as such designed the Rancho Rafael swimming pool.

## BARRETT & HILP CONTRACTORS

*Serving The Construction Field  
Since 1912*

OUR FORTIETH YEAR

918 Harrison Street • San Francisco  
Telephone DOuglas 2-0700

## Parker, Steffens & Pearce

BUILDERS

135 South Park, San Francisco

Phone: EXbrook 2-4832

## FORDERER CORNICE WORKS

*Manufacturers of*

Hollow Metal Products • Interior Metal Trim  
Elevator Fronts and Cabs  
Metal Plaster Accessories • Sanitary Metal Base  
Flat and Roll Metal Screens  
Metal Cabinets • Commercial Refrigerators

269 POTRERO AVE.

SAN FRANCISCO, CALIF. HEMLOCK 1-4100

## J. BETTANCOURT GENERAL CONTRACTOR AND BUILDER

1015 SAN MATEO AVENUE  
SAN BRUNO, CALIFORNIA

Phone: JUnO 8-7525

# HAAS and HAYNIE

Formerly Haas Construction Company

Since 1898

275 PINE ST.

SAN FRANCISCO, CALIF.

Phone DOuglas 2-0678

## JUDSON PACIFIC - MURPHY CORP.

Steel Fabricators  
and  
Erectors

REINFORCING STEEL  
STRUCTURAL STEEL  
BRIDGE CRANES

4300 EASTSHORE HWY.  
EMERYVILLE, CALIF.

Phone:  
OL 3-1717

## CLINTON CONSTRUCTION CO. OF CALIFORNIA

General Contractors

923 FOLSOM STREET • SAN FRANCISCO

SUtter 1-3440

## HOGAN LUMBER CO.

Wholesale and Retail

LUMBER

MILL WORK • SASH & DOORS

Office, Mill, Yard and Docks  
SECOND AND ALICE STREETS • OAKLAND, CALIF.

Telephone GLencourt 1-6861

## BOOK REVIEWS PAMPHLETS AND CATALOGUES

**ARCHITECTURAL PHOTOGRAPHY OF HOUSES.** By Robert C. Cleveland. *Architectural Record*, 119 W. 40th St., New York 18. Price \$7.50.

How to take good pictures of exteriors and interiors is explained in this first book to be published on how to take professional photographs of houses. Architects and interior decorators will find it a valuable guide in securing top-quality photographic records of their work. Professional photographers and the experienced amateur will learn how to take photographs of houses that crystallize the taste and judgment of their planners. Practical advice is given both on the basic technical problems like selection of camera angles and on the more artistic questions of design and composition so that the end result will truly capture the personality and individuality of the subject. Contains 325 actual photographs.

**SIMPLIFIED DRAFTING PRACTICE—A Modern Approach to Industrial Drafting.** By William L. Healy and Arthur H. Rau. John Wiley & Sons, Inc., 440 4th Ave., New York 16. Price \$5.00.

Offers "a revolution in drafting" that will result in a saving of industrial drafting time of from 30 to 50 per cent. The book marks the first major change in industrial drafting practice in years. It teaches new methods that are vitally necessary if the draftsman is to keep in step with the trend of modern industrial progress. The old concept of drafting is today as outmoded as the horse and buggy. The time element is dictating in ever stronger terms that drafting, as the key function between invention and production, produce drawings faster and with less effort.

Simplification of delineation, elimination of non-essentials, and extensive use of freehand drawing is emphasized. Both authors are well known in the professional engineering field.

**THE ORIGIN AND DEVELOPMENT OF EARLY CHRISTIAN CHURCH ARCHITECTURE.** By J. G. Davis. Philosophical Library, Inc., 15 E. 40th St., New York 16. Price \$4.75.

The book begins with a chapter on the geographical and historical background, and then surveys the field of architecture and furnishings of churches of the first six centuries.

Forty-five ground plans and many illustrations of churches and objects discussed are included; also a map showing revelant sites; a bibliography, and a glossary.

The book covers ground not previously covered in modern English work, and should be of use to students of architecture and all who are interested in the origins of church buildings.

### NEW CATALOGUES AVAILABLE

*Architects, Engineers, Contractors, Planning Commission members—the catalogues, folders, new building products material, etc., described below may be obtained by directing your request to the name and address given in each item.*

**Small cooling tower.** New bulletin describing in detail all features, data and dimensions of the "Thrifty-Tower" is now available. Suitable to residential, commercial, and industrial air conditioning systems; saves up to 95% of normal water demand; capacity range 2 to 16 tons. Write Marlo Coil Co., 6135 Manchester Ave., St. Louis 10, Mo.

**Steam traps.** Two new catalogs, No. 500 and No. 610, covering various types of steam traps, together with capacity charts. Contain many drawings, charts, and photographs on uses and installations. For complete information on the Universal Velan Steam Traps, write Velan Engineering Ltd., 6585 Jeanne Mance St., Montreal, Canada.

**Built-up Roofing Performance.** A new 4-page brochure entitled "Picture Story of the History of Built-up Roofing Performance with Liquid Fells", containing numerous photographs showing condition of roofing after years of weathering and placing emphasis on the value of roofing protection, is available to architects, engineers and contractors. Write Dept. A&E, Grems Manufacturing Co., 5635 So. 6th St., Klamath Falls, Oregon.

**Booklet on welding.** An 8-page reprint entitled "Will Inert-Gas Metal-Arc Save Money on Mild Steel", authored by G. C.

Christopher and R. C. Becker of the Research Laboratories of the International Harvester Co., reports the results of weld tests on mild steel with the inert-gas metal-arc welding method. Data is recorded in tables which show costs as compared with the conventional method of welding mild steel. Graphs and cross-section photos of weld deposits are also shown. Copies are available by writing Dept. A&E, Air Reduction Pacific Co., 220 Bush St., San Francisco.

**Heat Exchangers and Hot Water storage heaters.** A new 16-page general catalog covering hot water storage heaters and heat exchangers; includes horizontal and vertical hot water storage heaters, instantaneous water heaters, converters, condensate coolers, dishwasher boosters, fuel oil heaters and instantaneous suction heaters for viscous fluids. Copies of this, Catalog 5, may be obtained from Dept. A&E, Patterson-Kelley Co., Inc., 619 Warren St., East Stroudsburg, Penn.

**Stokers.** A new 12-page catalog in 4-colors containing full information on Iron Firemen Pneumatic Spreader stokers, for bituminous, sub-bituminous, high ash fusion, and lignite coals. Includes data on automatic combustion controls, dumping gates, and fly ash reinjection systems. Write for Catalog 2530, Dept. A&E, Iron Fireman Mfg. Co., Cleveland 11, Ohio.

**Translucent coverings.** A new 4-page, well illustrated, folder describing how to build translucent, fiber glass reinforced, plastic coverings for terrace, patio, porch, breezeway or carport. Gives easy-to-follow instructions on how to put up the shelter framework and how to install the covering. Folder may be obtained by writing Dept. A&E, Resolite Corp., Zelienople, Penn.

**Glazing the air conditioned home.** The booklet gathers together available data of interest to the individual planning or building a home so that he may obtain the greatest benefit from the glazing of windows, proper orientation, with data about different kinds of glass and hints about sash. Numerous photographs are used. A.I.A. File No. 26-A-9 1953. This booklet may be obtained by writing Dept. A&E, Libbey-Owens-Ford Glass Co., Toledo 3, Ohio.

**Metal Wall Panels.** A new catalog describing Steelcraft Insulated Metal Wall Panels, in brilliant 4-color process, is available. The catalog contains 8-pages filled with descriptive information, illustrations, specifications, and detailed drawings. Prepared primarily for architects, engineers, and contractors, it provides information on types of materials, textures and colors. Copies are available by writing Dept. A&E, Steelcraft Manufacturing Co., Rossmoyn, Ohio.

**Solderless Wire Connectors.** New Catalog 53 contains 16-pages of drawings, tables, illustrations and description of manufacturer's complete line of solderless wire connectors and specialized electrical fittings. Includes wire splicing, terminals, insulated bushings for electrical metallic conduit, "Snap-action" plugs for temporary or permanent plugging of knockout holes in wiring device boxes and other applications. Complete information on specifications, dimensional data, application instructions, etc. Copies available from Dept. A&E, Buchanan Electrical Products Corp., Hillside, New Jersey.

**Skylights.** 44-Page Catalog featuring aluminum skylights, separated into four major classifications: 1) Tubular de luxe, 2) de luxe, 3) standard, and 4) special applications. Illustrated with drawings, charts, photographs and descriptive material, also specifications and applications. A.I.A. File 12f. Copies may be obtained by writing Dept. A&E, O'Keeffe's, Inc., 225 Shaw Road, South San Francisco, California.

**Lighting Catalog.** A new 80-page booklet illustrating and describing complete line of lighting fixtures and provides a most comprehensive selection. It includes illustrations, descriptions, dimensional data, lighting curves and other detailed data on incandescent and fluorescent fixtures for commercial, industrial and outdoor use. Copies are available by writing Dept. A&E, Electro Silv-A-King Corp., 2000 W. Fulton St., Chicago, Ill.

**Motor Starters.** Describing in detail combination motor starters, a new publication, No. 514-515, is available. Illustrated with photos of various types; detailed drawings of special features. Starters provide means for disconnecting motors with either a disconnect switch, fusible or unfused, or an air circuit breaker, combined in a single enclosure with magnetic starter, as specified by National Electric Code. Dimensions and weights of all types are given. Available by writing Dept. A&E, Federal Electric Products Co., 50 Paris St., New York.

## PACIFIC MANUFACTURING CO.

High Class Interior Finish Quality Millwork

16 Beale St., San Francisco  
GARfield 1-7755  
2215 El Camino Real, San Mateo  
S. M. 5-0687  
304 Bryant Street, Palo Alto  
P. A. 3373  
2610 The Alameda, Santa Clara  
S. C. 607 (Factory)  
6820 McKinley Avenue, Los Angeles  
THornwall 4196  
MAIN OFFICE — SANTA CLARA

## "AMERICAN - MARSH" CONDENSATION UNIT

Pumping  
Machinery  
for  
Every  
Purpose

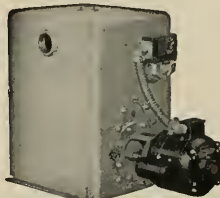

For Service  
Call  
DOuglas  
2-6794  
or  
MUtual 8322

**SIMONDS MACHINERY CO.**  
SAN FRANCISCO 816 FOLSOM  
LOS ANGELES 455 EAST 4TH

## VERMONT MARBLE COMPANY

DOMESTIC AND IMPORTED MARBLES  
GRANITE VENEER

525 MARKET STREET • SAN FRANCISCO 5  
Phone: SUtter 1-6747  
3522 COUNCIL STREET • LOS ANGELES 4  
Phone: DUUnkirk 2-7834

## The Most Complete Line of STEELS and STEEL BUILDING MATERIALS Made by a Single Producer



See Sweet's Catalog File or write us for full information.

**REPUBLIC STEEL CORPORATION**  
GENERAL OFFICES: CLEVELAND, OHIO

DENVER, COLORADO . . . . . CONTINENTAL OIL BUILDING  
LOS ANGELES, CALIF. . . . . GENERAL PETROLEUM BUILDING  
SAN FRANCISCO, CALIFORNIA . . . . . RIALTO BUILDING  
SEATTLE, WASH. . . . . WHITE-HENRY-STUART BUILDING



## GROUND WATER IN GRADE SLABS

(From Page 10)

keep the surface of the fill from  $\frac{1}{4}$ " to  $\frac{1}{2}$ " below the tops of the sleeper, then allow the new concrete fill to dry. Thereafter proceed in the usual way in installing a spring floor. The ample and enormous amount of ventilation in such spring floors is ample protection against rot.

It is quite evident that most of us in the construction industry are prone to neglect writing and recording good ideas for future generations, feeling that at the proper time in the future and whenever a similar occasion presented itself, we would again think of the same idea or a better one. Thus ideas are often lost because the similar occasion never again presented itself.

One wonders if the lost art of tempering copper by the ancient crafts was not lost in a similar manner. Apparently someone or many neglected to record just how the tempering was done in detail and the idea then died when the last survivor died. How many other times did such things occur? Can it be said that many ideas or methods of doing things in research were not actually done in the laboratory and simply because unrecorded, they were promptly forgotten. Someone later comes

along and does the same thing in research and thinks the idea is "new."

Many ideas in ore dressing, once familiar to many operators, in later years were thought to be "new" by the younger generation. Thus time, often all too soon, closes the pages of knowledge.

If everyone would stop long enough to record worthwhile ideas in a neat and orderly manner, many good ideas in the arts or sciences would never have been lost.

The author asks permission of the reader to digress from the theme and thought followed hereinabove and suggests that all architects, construction engineers follow the example of many architects and engineers high in their professions who make it a practice to cooperate with general contractors and subcontractors and material men realizing that trustworthy representatives of the construction industry among these crafts can bring best results. All should work together for best all around results.

The construction industry, the same as other industries, has and always will have those who are eternally looking for an opening to take advantage of others for their own benefit. No one can do good work for less than cost and the owner very rarely gets more than he pays for.

The architects and construction engineers have a profession which is highly creative and offers an opportunity for self expression in permanent form, likewise many other professions in industries such as automobile, machinery, etc. For that reason the closest cooperation between all professions in the construction industry is bound to get the best results. An architect or his associates cannot be expected to be so fully informed on all materials and methods of construction that timely advice would not help him now and then. Likewise the architect may often help the contractor in doing a better job. Thus the architects and/or construction engineers, once their specifications have been issued, may still have recourse to addenda, etc., to this end, which is constantly being done.

There is nothing "new" in this article but occasional restatement of well-known facts as a refresher is never out of order and the reader may often pick up an idea that is new to him, if not new to the industry as a whole.

(Conclusion)

### AMERICAN COUNCIL OF COMMERCIAL LABORATORIES

The Annual meeting of the American Council of Commercial Laboratories is scheduled for November 4-7, in Detroit, Michigan, according to an announcement by Harold M. Dudley, executive secretary. A full program of divisional and committee activities are being planned.

**HOLLYWOOD JUNIOR**  
COMBINATION  
SCREEN and METAL SASH DOOR  
★  
The "WEATHER-WISE"  
DOOR!!

**A VENTILATING SCREEN DOOR  
A SASH DOOR  
A PERMANENT OUTSIDE DOOR  
ALL 3 IN 1!**

Discriminating home owners and architects have chosen Hollywood Junior as the TRIPLE DOOR VALUE in the COMBINATION SCREEN and METAL SASH DOOR field. A sturdy dependable door, constructed of quality materials, HOLLYWOOD JUNIOR'S EXCLUSIVE PATENTED FEATURES have outmoded old-fashioned screen doors and other doors of its type entirely! . . . . .

**IT GUARANTEES YOU YEAR 'ROUND  
COMFORT, CONVENIENCE and ECONOMY**

WE ALSO MANUFACTURE A COMPLETE LINE OF  
SHUTTERS, C. C. DOORS, SCREENS, SCREEN DOORS, LOUVRE DOORS

**WEST COAST SCREEN CO.**  
145 EAST 61st STREET      LOS ANGELES, CALIFORNIA  
ADAMS 3138

WRITE FOR FREE ILLUSTRATED LITERATURE

# ESTIMATOR'S GUIDE

## BUILDING AND CONSTRUCTION MATERIALS

PRICES GIVEN ARE FIGURING PRICES AND ARE MADE UP FROM AVERAGE QUOTATIONS FURNISHED BY MATERIAL HOUSES TO SAN FRANCISCO CONTRACTORS. 3% SALES TAX ON ALL MATERIALS BUT NOT LABOR

All prices and wages quoted are for San Francisco and the Bay District. There may be slight fluctuation of prices in the interior and southern part of the state. Freight cartage, at least, must be added in figuring country work.

**BONDS**—Performance or Performance plus Labor and Material Bond(s), \$10 per \$1000 on contract price. Labor & Material Bond(s) only, \$5.00 per \$1000 on contract price.

**BRICKWORK—MASONRY—**

Common Brick—Per 1 M laid—\$150.00 up (according to class of work).  
Face Brick—Per 1 M laid—\$200.00 end up (according to class of work).  
Brick Steps—\$3.00 and up.  
Common Brick Veneer on Frame Bldgs.—Approx. \$1.20 and up—(according to class of work).  
Face Brick Veneer on Frame Bldgs.—Approx. \$2.00 and up (according to class of work).  
Common Brick—\$36.00 per M truckload lots, delivered.  
Face Brick—\$81.00 to \$106.00 per M, truckload lots, delivered.

**Glazed Structural Units—Walls Erected—**  
Clear Glazed—  
2 x 6 x 12 Furring .....\$2.00 per sq. ft.  
4 x 6 x 12 Partition ..... 2.25 per sq. ft.  
4 x 6 x 12 Double Faced  
Partition ..... 3.00 per sq. ft.  
For colored glaze add ..... .30 per sq. ft.  
Mentel Fire Brick \$150.00 per M—F.O.B. Pittsburgh.

Fire Brick—Per M—\$111.00 to \$147.00.  
Cartage—Approx. \$10.00 per M.  
Paving—\$75.00.

**Building Tile—**  
8x5 1/2x12-inches, per M .....\$139.50  
6x5 1/2x12-inches, per M ..... 105.00  
4x5 1/2x12-inches, per M ..... 84.00  
**Hollow Tile—**  
12x12x2-inches, per M ..... \$146.75  
12x12x3-inches, per M ..... 156.85  
12x12x4-inches, per M ..... 177.10  
12x12x6-inches, per M ..... 235.30  
F.O.B. Plant

**BUILDING PAPER & FELTS—**

1 ply per 1000 ft. roll .....\$5.30  
2 ply per 1000 ft. roll ..... 7.80  
3 ply per 1000 ft. roll ..... 9.70  
Brownskin, Standard 500 ft. roll ..... 6.85  
Sisal kraft, reinforced, 500 ft. roll ..... 6.50

**Sheathing Papers—**  
Asphalt sheathing, 15-lb. roll .....\$2.70  
30-lb. roll ..... 3.70  
Dampcourse, 216-ft. roll ..... 2.95  
Blue Plasterboard, 60-lb. roll ..... 5.10

**Felt Papers—**  
Deadening felt, 3/4-lb., 50-ft. roll .....\$4.30  
Deadening felt, 1-lb. .... 5.05  
Asphalt roofing, 15-lbs. .... 2.70  
Asphalt roofing, 30-lbs. .... 3.70

**Roofing Papers—**  
Standard Grade, 108-ft. roll, Light .....\$2.50  
Smooth surface, Medium ..... 2.90  
Heavy ..... 3.40  
M. S. Extra Heavy ..... 3.95

**BUILDING HARDWARE—**

Sash cord com. No. 7 .....\$2.65 per 100 ft.  
Sash cord com. No. 8 ..... 3.00 per 100 ft.  
Sash cord spot No. 7 ..... 3.65 per 100 ft.  
Sash cord spot No. 8 ..... 3.35 per 100 ft.  
Sash weights, cast iron, \$100.00 ton .....  
1-Ton lots, per 100 lbs. ....\$3.75  
Less than 1-ton lots, per 100 lbs. .... 4.75  
Nails, per keg, base .....\$12.55  
8-in. spikes ..... 12.45  
Rim Knob lock sets .....\$1.80  
Buttons, dull brass plated on steel, 3/2x3 1/2 ..... .76

**CONCRETE AGGREGATES—**

The following prices net to Contractors unless otherwise shown. Carload lots only.

Gravel, all sizes.....	\$2.44	\$2.90
Top Sand.....	2.38	3.13
Concrete Mix.....	2.38	3.06
Crushed Rock, 1/4" to 3/4".....	2.38	2.90
Crushed Rock, 3/4" to 1 1/2".....	2.38	2.90
Roofing Gravel.....	2.81	2.90
River Sand.....	2.50	3.00

**Sand—**  
Lepis (Nos. 2 & 4)..... 3.56 3.94  
Olympia (Nos. 1 & 2)..... 3.56 3.88

**Cement—**  
Common (all brands, paper sacks), Per Sack, small quantity (paper).....\$1.05  
Carload lots, in bulk, per bbl..... 3.55  
Cash discount on carload lots, 10c a bbl, 10th Prox., less than carload lots, \$4.00 per bbl, f.o.b. warehouse or delivered.  
Cash discount 2% on L.C.L.  
Trinity White..... [ 1 to 100 sacks, \$3.50 sack warehouse or del.; \$9.56 Medusa White..... [ bbl, carload lots.

**CONCRETE READY-MIX—**

Delivered in 4-yd. loads:  
Per cubic yard, 1-8 Mix.....\$ 9.80  
1-7 Mix..... 10.15  
1-6 Mix..... 10.70  
1-5 Mix..... 11.40  
Curing Compound, clear, drums, per gal. .... 1.03

**CONCRETE BLOCKS—**

	Hay-ditch	Basalt
4x8x16-inches, each	\$.19	\$.19
6x8x16-inches, each	.23	.235
8x8x16-inches, each	.27	.27
12x8x16-inches, each	.38	.40
12x8x24-inches, each	.....	.60

**Hayditch Aggregates—**  
3/4-inch to 3/8-inch, per cu. yd. ....\$7.75  
3/8-inch to 1/2-inch, per cu. yd. .... 7.75  
No. 6 to 0-inch, per cu. yd. .... 7.75

**DAMP-PROOFING and Waterproofing—**

Two-coat work, \$9.00 per square.  
Membrane waterproofing—4 layers of saturated felt, \$10.00 per square.  
Hot coating work, \$5.00 per square.  
Medusa Waterproofing, \$3.50 per lb. San Francisco Warehouse.  
Tricosol concrete waterproofing, 60c a cubic yd. and up.

**ELECTRIC WIRING—**\$15 to \$20 per outlet for conduit work (including switches).  
Knob and tube average \$6.00 per outlet.

**ELEVATORS—**

Prices vary according to capacity, speed end type. Consult elevator companies. Average cost of installing a slow speed automatic passenger elevator in small four story apartment building, including entrance doors, about \$9,500.00.

**EXCAVATION—**

Sand, \$1.00; clay or shale, \$1.50 per yard. Trucks, \$30 to \$45 per day.  
Above figures are an average without water. Steam shovel work in large quantities, less; hard material, such as rock, will run considerably more.

**FIRE ESCAPES—**

Ten-foot galvanized iron balcony, with stairs, \$250 installed on new buildings; \$300 on old buildings.

**FLOORS—**

Asphalt Tile, 1/8 in. gauge 18c to 35c per sq. ft.  
Composition Floors, such as Magnesite, 40c-1.25 per sq. ft.  
Linoleum, standard gauge, sq. yd.....\$2.75  
Mastipave—\$1.50 per sq. yd.  
BattleShip Linoleum—1/8"= \$3.00 sq. yd.  
Terrazo Floors—\$2.00 per sq. ft.  
Terrazo Steps—\$2.50 per lin. ft.  
Mastic Wear Coat—according to type—20c to 35c.

**Hardwood Flooring—**

**Oak Flooring—T & G—Unfin—**

	3 1/2 x 2 1/4	1/2 x 2	3/4 x 2	1/2 x 2
Clear Old, White.....	\$425	\$405	\$	\$
Clear Old, Red.....	405	380		
Select Old, Red or White.....	355	340		
Clear Pin, Red or White.....	355	340	335	315
Select Pin, Red or White.....	340	330	325	300
#1 Common, Red or White.....	315	310	305	280
#2 Common, Red or White.....	305			

**Prefinished Oak Flooring—**

1/2 x 2.....	Prime	Standard
1/2 x 2 1/2.....	\$369.00	\$359.00
1/2 x 2 1/4.....	360.00	370.00
1/2 x 2.....	390.00	381.00
1/2 x 3/4.....	375.00	355.00
1/2 x 3/4.....	375.00	375.00
1/2 x 2 1/4 & 3/4 Ranch Plank.....	395.00	415.00

**Unfinished Maple Flooring—**

1/2 x 2 1/4 First Grade.....	\$390.00
1/2 x 2 1/4 2nd Grade.....	365.00
1/2 x 2 1/4 2nd & Btr. Grade.....	375.00
1/2 x 2 1/4 3rd Grade.....	240.00
1/2 x 3/4 3rd & Btr. Jtd. EM.....	360.00
1/2 x 3/4 2nd & Btr. Jtd. EM.....	390.00
33/32 x 2 1/4 First Grade.....	400.00
33/32 x 2 1/4 2nd Grade.....	360.00
33/32 x 2 1/4 3rd Grade.....	320.00

Floor Layer Wage \$2.60 hr.

**GLASS—**

Single Strength Window Glass.....	\$.30 per sq. ft.
Double Strength Window Glass.....	.45 per sq. ft.
Plate Glass, 1/4 polished to 75.....	1.60 per sq. ft.
75 to 100.....	1.74 per sq. ft.
1/4 in. Polished Wire Plate Glass.....	2.50 per sq. ft.
1/4 in. Rgh. Wire Glass.....	.80 per sq. ft.
1/8 in. Obscure Glass.....	.44 per sq. ft.
3/8 in. Obscure Glass.....	.63 per sq. ft.
1/2 in. Heat Absorbing Obscure.....	.51 per sq. ft.
1/2 in. Heat Absorbing Wire.....	.72 per sq. ft.
1/8 in. Ribbed.....	.44 per sq. ft.
3/8 in. Ribbed.....	.63 per sq. ft.
1/2 in. Rough.....	.44 per sq. ft.
3/8 in. Rough.....	.63 per sq. ft.
1/2 in. Rough.....	.72 per sq. ft.
Glazing of above additional \$15 to	.30 per sq. ft.
Glass Blocks, set in place.....	3.50 per sq. ft.

**HEATING—**

**Furnaces—Gas Fired**  
Floor Furnace, 25,000 BTU..... \$ 70.50  
35,000 BTU ..... 77.00  
45,000 BTU ..... 90.50  
Automatic Control, Add..... 39.00  
Dual Wall Furnaces, 25,000 BTU ..... 91.50  
35,000 BTU ..... 99.00  
45,000 BTU ..... 117.00  
With Automatic Control, Add..... 39.00  
Unit Heaters, 50,000 BTU ..... 202.90  
Gravity Furnace, 65,000 BTU ..... 198.00  
Forced Air Furnace, 75,000 BTU ..... 313.50  
**Water Heaters—5-year guarantee**  
With Thermostat Control,  
20 gal. capacity ..... 87.50  
30 gal. capacity ..... 103.95  
40 gal. capacity ..... 120.00

## INSULATION AND WALLBOARD—

Rockwool Insulation—	
(2") Less than 1,000 sq. ft.	\$64.00
(2") Over 1,000 sq. ft.	\$9.00
Cotton Insulation—Full thickness	
(3 3/4")	\$95.50 per M sq. ft.
Sisalation Aluminum Insulation—Aluminum coated on both sides.	
	\$23.50 per M sq. ft.
Tileboard—4"x6" panel	
	\$9.00 per panel
Wallboard—1/2" thickness	
	\$55.00 per M sq. ft.
Finished Plank	
	\$9.00 per M sq. ft.
Ceiling Tileboard	
	\$9.00 per M sq. ft.

**IRON**—Cost of ornamental iron, cast iron, etc., depends on designs.

## LUMBER—

S4S No. 2 and better common	
O.P. or D.F., per M. f.b.m.	\$100.00
Rough, No. 2 common O.P. or D.F., per M. f.b.m.	95.00

## Flooring—

	Per M Delvd.
V.G.-D.F. B & Btr. 1 x 4 T & G Flooring	\$225.00
"C" and better—all	225.00
"D" and better—all	225.00
Rwd. Rustic—"A" grade, medium dry, 8" to 24 ft.	185.00

## Plywood, per M sq. ft.

1/4-inch, 4.0x8.0-SIS	\$135.00
1/2-inch, 4.0x8.0-SIS	219.00
3/4-inch, per M sq. ft.	292.00
Plycord	11 1/2c per ft.
Plyform	25c per ft.

## Shingles (Rwd. not available)—

Red Cedar No. 1—\$9.50 per square; No. 2, \$7.00; No. 3, \$5.00.	
Average cost to lay shingles, \$6.00 per square.	
Cedar Shakes—1/2" to 3/4" x 24/26 in. hand split tapered or split resawn, per square.	\$15.25
3/4" to 1 1/4" x 24/26 in. split resawn, per square	17.00
Average cost to lay shakes, \$8.00 per square.	
<b>Pressure Treated Lumber—</b>	
Wolmanized	Add \$35 per M to above
Cresoted,	
8-lb. treatment	Add \$45 per M to above

## MARBLE—(See Dealers)

## METAL LATH EXPANDED—

Standard Diamond, 3.40, Copper Bearing, L.C.M., per 100 sq. yds.	\$43.50
Standard Ribbed, ditto.	\$47.50

## MILLWORK—Standard.

D. F. \$150 per 1000, R. W. Rustic \$175 per 1000 (delivered).
Double hung box window frames, average with trim, \$12.50 and up, each.
Complete door unit, \$15 to \$25.
Screen doors, \$8.00 to \$12.00 each.
Patent screen windows, \$1.25 a sq. ft.
Cases for kitchen pantries seven ft. high, per lineal ft., upper \$9.00 to \$11.00; lower \$12.00 to \$13.00.
Dining room cases, \$20 per lineal foot. Rough and finish about \$1.00 per sq. ft.
Labor—Rough carpentry, warehouse heavy framing (average), \$75.00 per M.
For smaller work average, \$35.00 to \$100 per 1000.

## PAINTING—

Two-coat work	per yard	85c
Three-coat work	per yard	\$1.10
Lead-water painting.	per yard	25c
Whitewashing.	per yard	15c

## Linsed Oil, Strictly Pure

(Basis 7 1/2 lbs. per gal.)	Wholesale	
Light iron drums	per gal.	\$2.28
5-gallon cans	per gal.	2.40
1-gallon cans	each	2.52
Quart cans	each	.71
Pint cans	each	.38
1/2 pint cans	each	.24

## Turpentine

(Basis, 7.2 lbs. per gal.)	Pure Gum	
Light iron drums	per gal.	\$1.65
5-gallon cans	per gal.	1.76
1-gallon cans	each	1.88
Quart cans	each	.54
Pint cans	each	.31
1/2 pint cans	each	.20

## Pioneer White Lead in Oil Heavy Paste and All-Purpose (Soft-Paste)

List Price		Price to Painters	
Net Weight	Per 100 Pkgs.	Per 100 lbs.	Pr. per
Packages	lbs.	pkgs.	lbs.
100-lb. kegs	\$28.35	\$29.35	\$27.50
50-lb. kegs	30.05	15.03	28.15
25-lb. kegs	30.35	7.50	28.45
5-lb. cans*	33.35	1.34	31.25
1-lb. cans*	36.00	.36	33.75

500 lbs. (one delivery) 3/4c per pound less than above.  
\*Heavy Paste only.

## Pioneer Dry White Lead—Litharge—Dry Red Lead Red Lead in Oil

Price to Painters—Price Per 100 Pounds	
	100 lbs.
	50 lbs.
	25 lbs.
Dry White Lead	\$26.30
Litharge	25.50
Dry Red Lead	27.20
Red Lead in Oil	30.65

## PATENT CHIMNEYS—

6-inch	\$2.50 lineal foot
8-inch	3.00 lineal foot
10-inch	4.00 lineal foot
12-inch	5.00 lineal foot

## PLASTER—

Neat wall, per ton delivered in S. F. in paper bags, \$17.60.

## PLASTERING (Interior)—

3 Coats, metal lath and plaster.	Yard	\$3.00
Keene cement on metal lath.		3.50
Ceilings with 3/4 hot roll channels metal lath (lathed only)		3.00
Ceilings with 3/4 hot roll channels metal lath plastered		4.50
Single partition 3/4 channel lath 1 side (lath only)		3.00
Single partition 3/4 channel lath 2 inches thick plastered		8.00
4-inch double partition 3/4 channel lath 2 sides (lath only)		5.75
4-inch double partition 3/4 channel lath 2 sides plastered		8.75
Thermax single partition; 1" channels; 2 1/4" overall partition width, Plastered both sides		7.50
Thermax double partition; 1" channels; 4 3/4" overall partition width, Plastered both sides		11.00
3 Coats over 1" Thermax nailed to one side wood studs or joists.		4.50
3 Coats over 1" Thermax suspended to one side wood studs with spring sound isolation clip		5.00
Note—Channel lath controlled by limitation orders.		

## PLASTERING (Exterior)—

2 coats cement finish, brick or concrete wall	Yard	\$2.50
3 coats cement finish, No. 18 gauge wire mesh		3.50
Lime—\$4.00 per bbl. at yard.		
Processed Lime—\$4.15 per bbl. at yard.		
Rock or Grip Lath—3/8"—30c per sq. yd.		
3/8"—29c per sq. yd.		
Composition Stucco—\$4.00 sq. yd. (applied).		

## PLUMBING—

From \$200.00 per fixture up, according to grade, quality and runs.

## ROOFING—

"Standard" tar and gravel, 4 ply	\$13.00
per sq. for 30 sqs. or over.	
Less than 30 sqs. \$16.00 per sq.	
Tile \$40.00 to \$50.00 per square.	
No. 1 Redwood Shingles in place.	
4 1/2 in. exposure, per square	\$18.25
5/2 No. 1 Cedar Shingles, 5 in. exposure, per square	14.50
5/8 x 16"—No. 1 Little Giant Cedar Shingles, 5" exposure, per square	18.25
4/2 No. 1-24" Royal Cedar Shingles 7 1/2" exposure, per square.	23.00
Re-coat with Gravel \$5.50 per sq.	

Asbestos Shingles, \$27 to \$35 per sq. laid.  
1/2 to 3/4 x 25" Resawn Cedar Shakes,  
10" Exposure ..... \$30.00  
3/4 to 1 1/4 x 25" Resawn Cedar Shakes,  
10" Exposure ..... \$35.00  
1 x 25" Resawn Cedar Shakes,  
10" Exposure ..... \$22.00  
Above prices are for shakes in place.

## SEWER PIPE—

C.I. 6-in. to 24-in. B. & S. Class B end heavier, per top	\$99.50
Vitrified, per foot: L.C.L. F.O.B. Warehouse, San Francisco.	
Standard, 8-in.	.66
Standard, 12-in.	1.30
Standard, 24-in.	5.41
Clay Drain Pipe, per 1,000 L.F. L.C.L. F.O.B. Warehouse, San Francisco:	
Standard, 6-in, per M.	\$240.00
Standard, 8-in, per M.	400.00

## SHEET METAL—

Windows—Metal, \$2.50 a sq. ft.  
Fire doors (average), including hardware \$2.00 per sq. ft., size 12'x12'. \$3.75 per sq. ft., size 3'x6'.

## SKYLIGHTS—(not glazed)

Galvanized iron, per sq. ft.	\$1.25
Vented hip skylights, per sq. ft.	2.25
Aluminum, puttless,	
(unglazed), per sq. ft.	1.25
(installed and glazed), per sq. ft.	1.85

## STEEL—STRUCTURAL—

\$290 per ton erected, when out of mill. \$350 per ton erected, when out of stock.

## STEEL REINFORCING—

\$200.00 per ton, in place.	
1/4-in. Rd. (Less than 1 ton) per 100 lbs.	\$8.90
3/8-in. Rd. (Less than 1 ton) per 100 lbs.	7.80
1/2-in. Rd. (Less than 1 ton) per 100 lbs.	7.50
5/8-in. Rd. (Less than 1 ton) per 100 lbs.	7.25
3/4-in. & 7/8-in. Rd. (Less than 1 ton)	7.15
1 in. & up (Less than 1 ton)	7.10
1 ton to 5 tons, deduct 25c.	

## STORE FRONTS—

Individual estimates recommended. See ESTIMATORS DIRECTORY for Architectural Veneer (3), and Mosaic Tile (35).

## TILE—

Ceramic Tile Floors—Commercial \$1.20 to \$1.60 per sq. ft.	
Quarry Tile Floors, 6x6" with "b" base @ \$1.35 per sq. ft.	
Tile Wainscots & Floors, Residential, 4 1/4 x 4 1/4" @ \$1.65 to \$2.00 per sq. ft.	
Tile Wainscots, Commercial Jobs, 4 1/4 x 4 1/4" Tile @ \$1.50 to \$1.65 per sq. ft.	
Asphalt Tile Floor 1 1/2" x 2 1/2" @ \$1.18 - \$1.35 sq. yd.	
Light shades slightly higher.	
Cork Tile—\$.70 per sq. ft.	
Mosaic Floors—See dealers.	
Linoleum Tile, per sq. ft.	\$ .65
Rubber Tile, per sq. ft.	\$ .55 to \$ .75

## Furring Tile

Scored	F.O.B. S. F.
12 x 12, each	\$ .17
Kraftite: Per square foot	Small Large
Patio Tile—Niles Red	Lots Lots
12 x 12 x 3/8-inch, plain	\$ 40 \$ 3.30
6 x 12 x 3/8-inch, plain	44 39
6 x 6 x 3/8-inch, plain	46 42

## Building Tile—

8x5 x 12-inches, per M	\$13.50
6x5 x 12-inches, per M	10.00
4x5 x 12-inches, per M	8.00

## Hollow Tile—

12x12x2-inches, per M	\$4.75
12x12x3-inches, per M	5.85
12x12x4-inches, per M	17.10
12x12x6-inches, per M	235.30
	F.O.B. Plant

## VENETIAN BLINDS—

75c per square foot and up. Installation extra

## WINDOWS—STEEL—INDUSTRIAL—

Cost depends on design and quality required.



# ARCHITECT AND ENGINEER

# ESTIMATOR'S DIRECTORY

## Building and Construction Materials

**EXPLANATION**—Building and construction materials are shown in major classified groups for general identification purposes with names and addresses of suppliers of materials listed in detail under group classification where name first appears—main offices are shown first with branch or district offices following. The numeral appearing in listings \*(3) refers to the major group classification where complete data on the dealer, or representative, may be found.

### ADHESIVES (1)

Wall and Floor Tile Adhesives  
THE CAMBRIDGE TILE MFG. CO. \*(35)

### AIR CONDITIONING (2)

Air Conditioning & Cooling  
UTILITY APPLIANCE CORP.  
Los Angeles 58; 4851 S. Alameda St.  
San Francisco: 1355 Market St., UN 1-4908

### ARCHITECTURAL PORCELAIN ENAMEL (2a)

CALIFORNIA METAL ENAMELING CO.  
Los Angeles: 6904 E. Slauson, UN 01268  
San Francisco: O'Keefe's, 55-11th St., UN 3-4445  
Portland: Beaver Sheet Metal & Roofing Co.,  
924 N. Russell St., TR 6766  
Seattle: Teclar Aluminum Co.,  
625 Yale Ave N., SE B494  
Salt Lake City: S. A. Roberts & Co.,  
109 W. 2nd South, Salt Lake 4-4431  
Phoenix: Baker-Thomas Co.,  
300 S. 12th, Phoenix 4-5503  
Tucson: Laing-Garrett Co.,  
19 S. Tyndall Ave., TU 2-8993  
Albuquerque: Welch-Irwin Corp., 1726 Lomas Blvd. NE.

### ARCHITECTURAL VENEER (3)

Ceramic Veneer  
GLADDING, McBEAN & CO.  
San Francisco: Harrison at 9th St., UN 1-7400  
Los Angeles: 2901 Los Feliz Blvd., OL 2121  
Portland: 110 S.E. Main St., EA 6179  
Seattle: 1500 First Ave. S., EL 4711  
Spokane: 1102 N. Monroe St., BR 3259  
THE CAMBRIDGE TILE MFG. CO. \*(35)  
Porcelain Veneer  
PORCELAIN ENAMEL PUBLICITY BUREAU  
Oakland 12; Room 601 Franklin Building  
Pasadena B; P. O. Box 186, East Pasadena Station

Granite Veneer  
VERMONT MARBLE COMPANY  
San Francisco 5; 525 Market St., SU 1-6747  
Los Angeles: 3522 Council St., DU 2-7834

Marble Veneer  
VERMONT MARBLE COMPANY  
San Francisco 5; 525 Market St., SU 1-6747  
Los Angeles: 3522 Council St., DU 2-7834

### BANKS - FINANCING (4)

CROCKER FIRST NATIONAL BANK OF S. F.  
San Francisco, Post & Montgomery Sts., EX 2-7700

### BATHROOM FIXTURES (5)

Metal  
THE CAMBRIDGE TILE MFG. CO. \*(35)  
Ceramic  
THE CAMBRIDGE TILE MFG. CO. \*(35)

### BRASS PRODUCTS (6)

GREENBERG'S, M. & SONS  
San Francisco 7; 765 Folsom, EX 2-3143  
Los Angeles 23; 1258 S. Boyle, AN 3-7108  
Seattle 4; 1016 First Ave. So., MA 5140  
Phoenix: 3009 N. 19th Ave., Apt. 92, PH 2-7663  
Portland 4; 510 Builders Exch. Bldg., AT 6443

### BRICKWORK (7)

Face Brick  
GLADDING, McBEAN & CO. \*(3)

KRAFTILE \*(35)  
REMILLARD-DANDINI CO.  
San Francisco 4; 400 Montgomery St., EX 2-4988

BRONZE PRODUCTS (8)  
GREENBERG'S, M. & SONS \*(6)

BUILDING PAPERS & FELTS (9)  
ANGIER PACIFIC CORP.  
San Francisco 5; 55 New Montgomery St., OO 2-4416  
Los Angeles: 7424 Sunset Blvd.  
PACIFIC COAST AGGREGATES, INC. \*(11)  
SISALKRAFT COMPANY  
San Francisco 5; 55 New Montgomery St., EX 2-3066  
Chicago, Ill.: 205 West Wacker Drive

BUILDING HARDWARE (9a)  
THE STANLEY WORKS  
San Francisco: Monadnock Bldg., YU 6-5914  
New Britain, Conn.

CABINETS & FIXTURES (9b)  
FINK & SCHINDLER, THE; CO.  
San Francisco: 522 Brannan St., EX 2-1513

CEMENT (10)  
IDEAL CEMENT COMPANY (Pacific Division)  
San Francisco 4; 310 Sansome St., GA 1-4100  
PACIFIC COAST AGGREGATES, INC. \*(11)

CONCRETE AGGREGATES (11)  
Ready Mixed Concrete  
PACIFIC COAST AGGREGATES, INC.  
San Francisco: 400 Alabama St., KL 2-1616  
Sacramento: 16th and A Sts., GI 3-6586  
San Jose: 790 Stockton Ave., CY 2-5620  
Oakland: 2400 Peralta St., GL 1-0177  
Stockton: 820 So. California St., ST 8-8643  
Lightweight Aggregates  
AMERICAN PERLITE CORP.  
Richmond: 26th & B. St. - Yd. 2, RI 4307

DOORS (12)  
Hollywood Doors  
WEST COAST SCREEN CO.  
Los Angeles: 1127 E. 63rd St., AD 1-1108  
W. P. FULLER CO.  
Seattle, Tacoma, Portland

NICOLAI DOOR SALES CO.  
San Francisco: 3045 19th St.  
F. M. COBB CO.  
Los Angeles & San Diego  
SOUTHWESTERN SASH & DOOR  
Phoenix, Tucson, Arizona  
El Paso, Texas  
HOUSTON SASH & DOOR  
Houston, Texas

Screen Doors  
WEST COAST SCREEN DOOR CO.  
[See above]

FIRE ESCAPES (13)  
MICHEL & PFEFFER IRON WORKS, INC.  
South Linden & Tanforan Ave.  
South San Francisco: JU 4-8362

FIREPLACES (14)  
Heat Circulating  
SUPERIOR FIREPLACE CO.  
Los Angeles: 1708 E. 15th St., PR 8393  
Baltimore, Md.: 601 No. Point Rd.

FLOORS (15)  
Hardwood Flooring  
HOGAN LUMBER COMPANY  
Oakland: Second and Alice Sts., GL 1-6861

Floor Tile  
GLADDING, McBEAN & CO. \*(3)  
KRAFTILE \*(35)  
Floor Tile [Ceramic Mosaic]  
THE CAMBRIDGE TILE MFG. CO. \*(35)  
Floor Treatment & Maintenance  
HILLIARD SALES CO. (Western)  
San Francisco: 470 Alabama St., MA 1-7766  
Los Angeles: 923 E. 3rd, TR 8282  
Seattle: 3440 E. Marginal Way  
Diversified [Magnesite, Asphalt Tile, Composition, Etc.]  
LE ROY OLSON CO.  
San Francisco 10; 3070 - 17th St., HE 1-0188  
Sleepers [composition]  
LE ROY OLSON CO.

GLASS (16)  
W. P. FULLER COMPANY  
San Francisco: 301 Mission St., EX 2-7151  
Los Angeles, Calif.  
Portland, Ore.

HEATING (17)  
S. T. JOHNSON CO.  
Oakland 8; 940 Arlington Ave., OL 2-6000  
San Francisco: 585 Potrero Ave., MA 1-2757  
Philadelphia 8, Pa.: 401 N. Broad St.  
SCOTT COMPANY  
San Francisco: 243 Minna St., YU 2-0400  
Oakland: 113 - 10th St., GL 1-1937  
San Jose, Calif.  
Los Angeles, Calif.  
UTILITY APPLIANCE CORP. \*(2)  
Electric Heaters  
WESIX ELECTRIC HEATER CO.  
San Francisco 5; 390 First St., GA 1-2211  
Los Angeles: 520 W. 7th St., MI 8096  
Portland: Terminal Sales Bldg., BE 2050  
Seattle: Securities Bldg., SE 5028  
Designer of Heating  
THOMAS B. HUNTER  
San Francisco 4; 41 Sutter St., GA 1-1164

INSULATION AND WALL BOARD (18)  
LUMBER MANUFACTURING CO.  
San Francisco: 225 Industrial Ave., JU 7-1760  
PACIFIC COAST AGGREGATES, INC. \*(11)  
SISALKRAFT COMPANY \*(9)  
WESTERN ASBESTOS COMPANY  
San Francisco: 675 Townsend St., KL 2-3868  
Oakland: 251 Fifth Avenue, GL 1-2345  
Stockton: 733 S. Van Buren, ST 4-9421  
Sacramento 1331 - T St., HU 1-0125  
Fresno: 434 - P St., FR 2-1600

IRON—Ornamental (10)  
MICHEL & PFEFFER IRON WORKS, INC. \*(13)

LANDSCAPING (20)  
Landscape Contractors  
HENRY C. SOTO CORP.  
Los Angeles: 13,000 S. Avalon Blvd., ME 4-6617

LIGHTING FIXTURES (21)  
SMOOT-HOLMAN COMPANY  
Inglewood, Calif., DR 8-1217  
San Francisco: 55 Mississippi St., MA 1-8474

**LUMBER (22)**  
Shingles  
LUMBER MANUFACTURING CO. \*(18)

---

**MARBLE (23)**  
VERMONT MARBLE COMPANY  
San Francisco 5: 525 Market St., SU 1-6747  
Los Angeles 4: 3522 Council St., DU 2-7834

---

**METAL LATH EXPANDED (24)**  
PACIFIC COAST AGGREGATES, INC. \*(11)

---

**MILLWORK (25)**  
FINK & SCHINDLER, THE; CO: \*(9b)  
LUMBER MANUFACTURING COMPANY \*(18)  
MULLEN MANUFACTURING COMPANY  
San Francisco: 60-80 Rausch St., UN 1-5815  
PACIFIC MANUFACTURING COMPANY  
San Francisco: 16 Beale St., GA 1-7755  
Santa Clara: 2610 The Alameda, SC 607  
Los Angeles, 6820 McKinley Ave., TH 4196

---

**PAINTING (26)**  
Paint  
W. P. FULLER COMPANY \*(116)

---

**PLASTER (27)**  
Interiors - Metal Lath & Trim  
PACIFIC COAST AGGREGATES, INC. \*(11)  
Exteriors  
PACIFIC PORTLAND CEMENT COMPANY \*(2B)

---

**PLASTIC CEMENT (28)**  
IDEAL CEMENT COMPANY  
San Francisco: 310 Sansome St., GA 1-4100

---

**PLUMBING (29)**  
THE HALSEY TAYLOR COMPANY  
Redlands, Calif.  
Warren, Ohio  
THE SCOTT COMPANY \*(17)  
HAWS DRINKING FAUCET COMPANY  
Berkeley 10: 1435 Fourth St., LA 5-3341  
CONTINENTAL WATER HEATER COMPANY  
Los Angeles 31: 1801 Pasadena Ave., CA 6178  
SIMONDS MACHINERY COMPANY  
San Francisco: 816 Folsom St., OO 2-6794  
Los Angeles: 455 East 4th St., MU 8322  
SECURITY VALVE COMPANY  
Los Angeles 31: 410 San Fernando Rd., CA 6191

---

**RESILIENT TILE (30)**  
LE ROY OLSON CO. \*(15)

---

**SEWER PIPE (32)**  
GLADDING, McBEAN & CO. \*(13)

**SHEET METAL (32)**  
Windows  
DETROIT STEEL PRODUCTS COMPANY  
Oakland 8: 1310 - 63rd St., OL 2-8826  
San Francisco: Russ Building, DO 2-0890  
MICHEL & PFEFFER IRON WORKS, INC. \*(13)  
PACIFIC COAST AGGREGATES, INC. \*(11)  
Fire Doors  
DETROIT STEEL PRODUCTS COMPANY  
Skylights  
DETROIT STEEL PRODUCTS COMPANY

---

**STEEL—STRUCTURAL (33)**  
COLUMBIA STEEL CO.  
San Francisco: Russ Bldg., SU 1-2500  
Los Angeles: 2087 E. Slauson, LA 1171  
Portland: 2345 N. W. Nicolai, BE 7261  
Seattle 1331 3rd Ave. Bldg., MA 1972  
Salt Lake City: Walker Bank Bldg., SL 3-6733  
HERRICK IRON WORKS  
Oakland: 18th & Campbell Sts., GL 1-1767  
JUDSON PACIFIC-MURPHY CORP.  
Emeryville: 4300 Eastshore Highway, OL 3-1717  
REPUBLIC STEEL CORP.  
San Francisco: 116 N. Montgomery St., GA 1-0977  
Los Angeles: Edison Building  
Seattle: White-Henry-Stuart Building  
Salt Lake City: Walker Bank Building  
Denver: Continental Oil Building  
SAN JOSE STEEL COMPANY  
San Jose 195 North Thirtieth St., CO 4184

---

**STEEL—REINFORCING (34)**  
REPUBLIC STEEL CORP. \*(33)  
HERRICK IRON WORKS \*(33)  
SAN JOSE STEEL CO. \*(33)  
COLUMBIA STEEL CO. \*(33)

---

**CLAY TILE (35)**  
THE CAMBRIDGE TILE MFG. CO.  
San Francisco 10: 470 Alabama St., UN 3-1666  
Los Angeles 19: 1335 S. La Brea, WE 3-7800  
GLADDING, McMEAN & CO. \*(3)  
KRAFTILE  
Niles, Calif.: Niles 3611  
San Francisco 5: 50 Hawthorne St., DO 2-3780  
Los Angeles 13: 406 South Main St., MU 7241

---

**TIMBER—REINFORCING (36)**  
Trusses

Tacoma, Wash.  
WYERHAUSER SALES CO.  
St. Paul, Minn.  
Newark, N. J.  
Treated Timber  
J. H. BAXTER CO.  
San Francisco 4: 333 Montgomery St., OO 2-3883  
Los Angeles 13: 601 West Fifth St., MI 6294

---

**WALL TILE (37)**  
THE CAMBRIDGE TILE MFG. CO. \*(35)  
GLADDING, McBEAN & CO. \*(13)  
KRAFTILE COMPANY \*(35)

---

**WINDOWS STEEL (38)**  
DETROIT STEEL PRODUCTS CO. \*(132)  
MICHEL & PFEFFER IRON WORKS, INC. \*(13)  
PACIFIC COAST AGGREGATES, INC. \*(11)

---

**GENERAL CONTRACTORS (39)**  
BARRETT & HILP  
San Francisco: 918 Harrison St., DO 2-0700  
Los Angeles: 234 W. 37th Place, AO 3-8161  
J. BETTANCOURT  
San Bruno: 1015 San Mateo Ave., JU 8-7525  
DINWIDDIE CONSTRUCTION COMPANY  
San Francisco: Crocker Building, YU 6-2718  
CLINTON CONSTRUCTION COMPANY  
San Francisco: 923 Folsom St., SU 1-3440  
MATTOCK CONSTRUCTION COMPANY  
San Francisco: 604 Mission St., GA 1-5516  
E. H. MOORE & SONS  
San Francisco: 693 Mission St., GA 1-8579  
PARKER, STEFFENS & PEARCE  
San Francisco: 135 So. Park, EX 2-6639

---

**TESTING LABORATORIES  
(ENGINEERS & CHEMISTS (40)**  
ABBOT A. HANKS, INC.  
San Francisco: 624 Sacramento St., GA 1-1697  
ROBERT W. HUNT COMPANY  
San Francisco: 251 Kearny St., EX 2-4634  
Los Angeles: 3050 E. Slauson, JE 9131  
Chicago, New York, Pittsburgh  
PITTSBURGH TESTING LABORATORY  
San Francisco: 651 Howard St., EX 2-1747

## CONSTRUCTION CONTRACTS AWARDED AND MISCELLANEOUS PERSONNEL DATA

**SEWAGE TREATMENT PLANT.** Porterville, Tulare county. City of Porterville, owner. Reinforced concrete construction at sewage farm site. Porterville, \$364,845. ENGINEER: Currie Engineering Company, San Bernardino. GENERAL CONTRACTOR: Fred J. Early, Jr. Co., San Francisco.

**WOMEN CLUB BUILDING.** Monterey. Monterey Civic Club, Monterey, owner. 1-Story concrete block and frame construction, tile roof, 4½x50 ft in area, \$29,875. ARCHITECT: C. J. Ryland, Monterey. GENERAL CONTRACTOR: Jake Hutzenga, Seaside.

**ELEMENTARY SCHOOL.** Marysville, Yuba county. Pumas Elementary School District, Marysville, owner. Frame and stucco, 3-

classrooms, administration, kitchen, toilet rooms, new elementary school buildings, \$55,701. ARCHITECT: Clayton Kantz, Redding. GENERAL CONTRACTOR: Glen H. Passmore, Yuba City.

**CHURCH.** Modesto, Congregational Church, Modesto, owner. Concrete block and frame construction church building, \$47,855. ARCHITECT: Hachire Yussa, Oakland. GENERAL CONTRACTOR: Peter O. Mattei Company, Berkeley.

**OFFICE BUILDING.** Inglewood, Los Angeles county. Inglewood Federal Savings & Loan Association, Inglewood, owner. Two-story brick and concrete office building, composition roofing, aluminum sash, plate glass, concrete floors partly covered with asphalt

tile and terrazzo, acoustical tile ceilings, forced air heating and air conditioning, plumbing, electrical, toilet rooms, 22,000 sq. ft. of floor space, \$404,000. ARCHITECT: Francis J. Heusel, Long Beach. GENERAL CONTRACTOR: R. E. Payne, Inglewood.

**HIGH SCHOOL ADDITION.** Arcata, Humboldt county. Arcata Union High School, Arcata, owner. Two-story reinforced concrete, 3-homemaking rooms, 2-commercial rooms, boiler plant, 4-science laboratory rooms, toilet rooms, 21,000 sq. ft., \$392,706. ARCHITECT: Ernest F. Winkler, San Francisco. GENERAL CONTRACTOR: Jas. I. Barnes Construction Co., Redwood City.

**SCHOOL BUILDING.** Capitano Beach. Capitano Beach School District, owner. Four-classroom building and bus garage; frame and stucco construction, composition and gravel roof, concrete slab, asphalt tile and ceramic tile floors, plaster walls, acoustic tile ceilings, wood and steel sash, aluminum venetian blinds. Forced air heat-

ing, metal clad doors, gutters and downspouts, cabinet work, tapered steel girder for bus garage, \$102,780. ARCHITECT: Orr, Strance & Insee, Los Angeles. GENERAL CONTRACTOR: Ralph C. Day, Arcadia. **CHURCH ADDITION**, Ontario, Redeemer Lutheran Church, Ontario, owner. Two-story, 4-classroom, frame and stucco addition to Sunday school facilities, Spanish tile roof, slab and asphalt tile floors, toilets, metal sash, wood floors, 2448 sq. ft., \$26,458. ARCHITECT: Roy A. Kazzibier, Ontario. GENERAL CONTRACTOR: Earle T. Casler, Upland.

**APARTMENT BUILDING**, Sherman Oaks. Daniel Horowitz, Sherman Oaks, owner. Two-story, 6-unit, frame and stucco apartment building; composition shingle roof, oak, linoleum and ceramic tile floors, stucco

walls, slab sliding doors, louvered doors, composition stair, stall showers with glass doors, electric heaters, garbage disposers, ceramic tile counter tops, laundry room, warm air furnaces, brick planters, asphaltic concrete paving, carport. ARCHITECT: Emery Kanarik, Los Angeles.

**OFFICE ADDITION**, Santa Clara, Monsanto Chemical Co., Santa Clara, owner. Frame remodel of office building and addition, \$179,392. ARCHITECT: Higgins & Root, San Jose. GENERAL CONTRACTOR: Lew Jones Construction Co., San Jose.

**SCHOOL BUILDING**, Riverside, San Bernardino county. Riverside City School District, Riverside, owner. Frame and stucco, 8-classrooms, kindergarten, administration unit; composition roofing, fiber roof insulation, concrete slab, asphalt tile and

terrazzo floors, plaster walls, acoustic tile ceilings, steel sash, metal louvers, forced radiant heating and space heaters, toilet rooms, metal toilet partitions, ceramic tile, blackboards and tackboards, \$177,310. ARCHITECT: Caughey & Ternstrom, Los Angeles. GENERAL CONTRACTOR: T. C. Pritchard & Son, Riverside.

**AIRPORT ADM. BLDG.**, Visalia, Tulare county. City of Visalia, Visalia, owner. 1-Story concrete block, structural steel frame, concrete floors, wood roof, 32x80 ft., \$38,471. ARCHITECT: Jas. P. Lockett, Visalia. GENERAL CONTRACTOR: H. B. Thorpe, Visalia.

**FACTORY ADDITION**, Los Angeles. Bivans Mfg. Co., Los Angeles, owner. Brick walls, composition roofing, cement slab floor, sky-

## BUILDING TRADES WAGE (JOB SITES) NORTHERN, CENTRAL AND SOUTHERN CALIFORNIA

ATTENTION: The following are the PREVALING hourly rates of compensation being paid and in effect by employers by agreement between employees and their union; or as recognized and determined by the U. S. Department of Labor. (June 1, 1953.)

CRAFT	San Francisco	Alameda	Contra Costa	Fresno	Sacramento	San Joaquin	San Clara	Salano	Los Angeles	San Bernardino	San Diego	Santa Barbara	Kern
ASBESTOS WORKERS	\$2.585	\$2.585	\$2.585	\$2.585	\$2.585	\$2.585	\$2.585	\$2.585	\$2.725	\$2.25	\$2.25	\$2.25	\$2.25
BOILERMAKERS	2.60	2.60	2.60	2.60	2.60	2.60	2.60	2.60	3.175	3.175	2.75	3.175	3.175
BRICKLAYERS	3.75	3.75	3.25	3.00	3.75	3.00	3.45	3.25	1.94	1.94	1.94	1.94	1.94
BRICKLAYERS, HODCARRIERS	2.45	2.45	2.45	2.00	2.40	2.25	2.45	2.45	1.94	1.94	1.94	1.94	1.94
CARPENTERS	2.60	2.60	2.54	2.54	2.54	2.54	2.54	2.54	2.57	2.57	2.57	2.57	2.57
CEMENT FINISHERS	2.57	2.57	2.57	2.57	2.57	2.57	2.57	2.57	2.57	2.57	2.57	2.57	2.57
CONCRETE MIXER—Skip Type (1-yd.)	2.78	2.78	2.78	2.78	2.78	2.78	2.78	2.78	2.38	2.38	2.38	2.38	2.38
ELECTRICIANS	3.00	3.00	3.00	3.00	3.00	2.75	3.00	2.50	3.00	3.00	3.00	3.00	3.00
ELEVATOR CONSTRUCTORS	2.75	2.70	2.65	2.75	2.915	2.915	2.915	2.915	2.25	2.25	2.25	2.25	2.25
ENGINEERS: MATERIAL HOIST	2.56	2.56	2.56	2.56	2.56	2.56	2.56	2.56	1.9875	1.9875	1.9875	1.9875	1.9875
GLAZIERS	2.30	2.30	2.30	2.30	2.75	2.30	2.30	2.30	2.26	2.26	2.26	2.26	2.26
IRONWORKERS: ORNAMENTAL	2.70	2.70	2.70	2.70	2.70	2.70	2.70	2.70	2.70	2.70	2.70	2.70	2.70
REINF. STREET	*2.60	2.60	2.60	2.60	2.60	2.60	2.60	2.60	2.61	2.61	2.61	2.61	2.61
STRUCTURAL STEEL	*2.85	2.85	2.85	2.85	2.85	2.85	2.85	2.85	2.70	2.70	2.70	2.70	2.70
LABORERS: BUILDING	1.85	1.85	1.85	1.85	1.85	1.85	1.85	1.85	1.94	1.94	1.94	1.94	1.94
CONCRETE	1.85	1.85	1.85	1.85	1.85	1.85	1.85	1.85	1.94	1.94	1.94	1.94	1.94
LATHERS	3.25	3.50	3.50	3.00	3.00	3.00	3.4375	3.00	3.125	3.125	3.125	3.125	3.125
MARBLE SETTERS	2.95	2.95	2.95	2.95	2.95	2.95	2.95	2.95	2.875	2.875	2.875	2.875	2.875
MOSAIC & TERRAZZO	2.74	2.74	2.74	2.74	2.74	2.74	2.74	2.74	2.40	2.40	2.40	2.40	2.40
PAINTERS—BRUSH	**2.60	2.60	2.60	2.60	2.625	2.45	2.45	2.27	2.56	2.50	2.53	2.22	2.22
PAINTER—SPRAY					2.91	2.70	2.70		2.68				
PILEDRIVERS—OPERATOR	2.75	2.75	2.75	2.75	2.75	2.75	2.75	2.75	2.74	2.70	2.70	2.70	2.70
PLASTERERS	3.175	3.165	3.125	3.125	3.00	3.00	3.125	3.00	3.125	3.125	3.125	3.125	3.125
PLASTERERS, HODCARRIERS	2.60				2.50	2.50	2.50	2.50	2.875	2.25	2.30	2.00	2.00
PLUMBERS—STEAM FITTERS	2.90	2.90	2.875	2.75	2.90	2.75	2.75	2.90	2.90	2.90	2.90	2.90	2.90
ROOFERS	2.80	2.50	2.50	2.25	2.50	2.50	2.50	2.50	2.65	2.00	1.90	2.00	2.00
SHEET METAL WORKERS	2.475	2.475	3.3125	2.45	2.75	2.50	2.40	2.45	2.475	2.475	2.175	2.45	2.45
SPRINKLER FITTERS	2.75	2.70	2.70	2.625	2.625	2.625	2.625	2.75	2.75	2.75	2.75	2.75	2.75
STEAMFITTERS	2.75	2.90	2.90	2.75	2.625	2.625	2.75	2.75	2.90	2.90	2.90	2.90	2.90
TRACTOR OPERATOR	2.67	2.67	2.67	2.67	2.67	2.67	2.67	2.67	2.52	2.52	2.52	2.52	2.52
TRUCK DRIVERS—1/2 Ton or less	1.89	1.89	1.89	1.89	1.89	1.89	1.89	1.89	2.02	2.02	2.02	2.02	2.02
TILESETTERS	2.955	2.955	2.955	2.955	2.955	2.955	2.955	2.955	2.65	2.65	2.65	2.65	2.65

\* 6 Hour Day. \*\* 7 Hour Day. \*\*\* Before C.I.S.C for 15c increase.

Prepared and compiled by:

CENTRAL CALIFORNIA CHAPTER, ASSOCIATED GENERAL CONTRACTORS OF AMERICA, with the assistance and cooperation of secretaries of General Contractors Associations and Builders Exchanges of Northern California; and the above information for southern California is furnished by the Labor Relations Department of the Southern California Chapter, ASSOCIATED GENERAL CONTRACTORS OF AMERICA.

# CLASSIFIED ADVERTISING

RATE: 20c PER WORD . . . CASH WITH ORDER

MINIMUM \$5.00

**HOME BUYERS**—Now building moderate priced homes in Sacramento and Marysville area; we are in a position to serve you; needs. "Better Built Homes" by Ronne, Ronne & Ronne, Builders, 520 9th Street, Sacramento.

**YOUNG MAN SEEKS OPPORTUNITY**—Young man with good background in the construction industry, seeks opportunity with Contractor. Primary consideration chance to advance to executive position in future. College graduate. INQUIRE, Box 521, ARCHITECT & ENGINEER magazine, 68 Post St., San Francisco.

**COLLECTIONS**—Thoroughly experienced in all phases of the collection business; your interests protected at all times; bonded agents everywhere; no collection no charge; California Material Dealers Service Co., 925 Hearst Bldg., San Francisco. Ernest T. Langley, Manager.

**BUILDERS!** You can make more money; get information you need before it is published elsewhere; Subscribe to the daily ARCHITECTS REPORTS, only \$10.00 per month. Complete information from ARCHITECTS REPORTS, 68 Post Street, San Francisco. Phone DOUGLAS 2-8311.

**PHOTOGRAPHY**. For the best in construction photography, including exterior and interior, aerial, and progress views . . . you will find as many others have that it's the SKELTON STUDIOS, 875 O'Farrell St., San Francisco. Telephone PRospect 6-1841.

**ARCHITECTURAL SLIDING SLEE SASH**. One lot only — new, half price. 13 units, assorted sizes, 353 square feet total. 3 at 7 ft. x 5 ft.; 4 at 7 ft. x 4 1/2 ft.; 1 at 6 ft. x 4 1/2 ft.; 2 at 6 ft. x 4 ft.; 1 at 7 ft. x 3 1/2 ft.; 1 at 4 1/2 ft. x 3 ft.; 1 at 3 ft. x 3 ft. Phone DELaware 3-7378, San Francisco.



lights, roof ventilators, steel sash, structural steel, rolling steel doors, 65x80 ft., \$30,000. ENGINEER: Frank L. Smith, Los Angeles. GENERAL CONTRACTOR: G. O. Gartz, Los Angeles.

**CAFETERIA REMODEL**, San Francisco. Metropolitan Life Insurance Co., San Francisco, owner. Interior and exterior remodel of 7th floor of Metropolitan Life Building, kitchen, structural steel and reinforced concrete construction of additional facilities, \$648,000. ARCHITECT: Thomsen & Wilson, San Francisco. GENERAL CONTRACTOR: Cahill Bros., San Francisco.

**FURNITURE STORE**, Reseda. McMahan's Furniture Co., Reseda, owner. Frame and stucco, built-up composition roofing, concrete slab floor, mezzanine, acoustic tile, laminated arched wood trusses, plate glass, interior plaster, toilets, T&G hardwood flooring on mezzanine, plate glass and aluminum doors, stone veneer, 75x120 ft., \$55,000. CONSULTING ENGINEER: D. Arthur Lowe and J. E. Costello, Los Angeles. GENERAL CONTRACTOR: LeSage Building Corp., Van Nuys.

**FIRE HOUSE**, Palo Alto, Santa Clara county. City of Palo Alto, owner. 1-Story frame and stucco, wood exterior, shake roof, some stone veneer, \$37,585. ARCHITECT: Harold C. Ahnfeldt, Palo Alto. GENERAL CONTRACTOR: Sibley G. & T. Company, Menlo Park.

**EXHIBIT BUILDINGS**, Sacramento, State of California, Sacramento, owner. Two exhibit buildings for the State Agricultural Society at the California State Fair grounds; poultry and pigeon, 13,000 sq. ft.; rabbit building, 5,600 sq. ft., reinforced concrete

foundations, steel rigid frame vents, sheet metal siding and roofs, mechanical and electrical work, \$148,761. GENERAL CONTRACTOR: Dorville-Gallino & Kohler, Grass Valley.

**RESTAURANT**, Burbank. Lewis Sailee, Burbank, owner. 1 and part 2-story, frame, plaster and masonry veneer building; coffee shop, dining room, cocktail lounge and banquet rooms, tapered steel girders, composition roofing, concrete slab and asphalt tile floors, plate glass, plaster and wood paneling, air conditioning, forced air unit, glass doors, floodlights, toilets, asphalt paving, 8700 sq. ft., \$250,000. ENGINEER: Max Strauss, Los Angeles. GENERAL CONTRACTOR: Melone Construction, Inc., Los Angeles.

**ALUMNI HOUSE**, Berkeley. University of California, Board of Regents, Berkeley, owner. Ell-shaped, reinforced concrete, 2-story, office wing administration building; 1-story lounge wing, composition roof, brick and stone veneer, porcelain enameled steel and glass, asphalt tile floors, \$269,800. ARCHITECT: Clarence W. Mayhew, San Francisco. GENERAL CONTRACTOR: Midstate Construction Co., San Francisco and Robert L. Wilson, San Francisco, joint venture.

**STUDENT CENTER BUILDING**, Santa Rosa, Sonoma county. Santa Rosa Junior College District, Santa Rosa, owner. Reinforced concrete, structural steel, concrete floors, asphalt tile floor covering, aluminum sash, \$156,349. ARCHITECT: J. Clarence Felciano, Santa Rosa. GENERAL CONTRACTOR: North Bay Construction Company, Santa Rosa.

**PAPER MILL**, Santa Clara. Royal Fibre Company, owner. 1-Story, with basement, reinforced concrete and wood frame, protected metal siding and roof, 100x200 ft., \$106,966. STRUCTURAL ENGINEER: Myron C. Gould & Associates, San Francisco. GENERAL CONTRACTOR: W. J. Nicholson, Santa Clara.

**NEWSPAPER ADDITION**, Tucson, Arizona. Tucson Newspapers Inc., Tucson, owner. Two-story, basement and mezzanine, addition, reinforced concrete, 45,481 sq. ft., \$500,000. ARCHITECT: Morton L. Perla & Associates, Chicago, and Architect James Macmillan, Tucson. GENERAL CONTRACTOR: M. M. Sundt Construction Co., Tucson.

**NEW PRIMARY SCHOOL**, Costa Mesa, San Diego county. Costa Mesa School District, Costa Mesa, owner. One-story, frame and stucco, 8-classrooms, kindergarten and administration building, 16,000 sq. ft., \$255,700. ARCHITECT: Kistner, Wright & Wright, Los Angeles. GENERAL CONTRACTOR: Wm. Rohrbacher, Santa Ana.

**STORE BUILDING**, Long Beach. Bernard B. Waite, Long Beach, owner. One-story, concrete block store building, composition roofing, plate glass and transom sash, concrete slab and asphalt tile covered floors, suspended heater, toilets, 1250 sq. ft., \$9800. ARCHITECT: H. G. Thursby, Long Beach. GENERAL CONTRACTOR: Glenn W. Gration, Long Beach.

**BRICK DORMITORY BLDG.**, Chatsworth, Southern California. Roman Catholic Archbishop of Los Angeles, owner. New dormitory building at the Rancho San Antonio in Chatsworth to accommodate 40 boys; reinforced brick construction, composition gravel roof, slab floor, steel sash, forced air heating, plumbing, septic tank, asphalt

tile, ceramic tile, plastering. ARCHITECT: George Adams, Los Angeles. GENERAL CONTRACTOR: Rodney Benson & Co., Riverside.

**FRATERNITY HOUSE**, Reno, Nevada. Sigma Alpha Epsilon Fraternity, Reno, owner. Two-story, with basement, brick and frame Fraternity House, \$88,900. ARCHITECT: Russell Mills, Reno. GENERAL CONTRACTOR: Frank Capriotti, Reno.

**PUBLIC HOSPITAL ADDN.**, Fallon, Nevada. Board of Trustees, Churchill Public Hospital, Fallon, Nevada, owner. 1-story concrete block and frame addition to existing building to accommodate 16 additional beds, \$122,000. ARCHITECT: De Longchamps & O'Brien, Reno. GENERAL CONTRACTOR: B. E. Bliss, Fallon.

**REMODEL HIGH SCHOOL**, Cloverdale. Sonoma County. Cloverdale Union High School District, Cloverdale, owner. Remodel present high school building, \$33,613. ARCHITECT: J. Clarence Felciano, Santa Rosa. GENERAL CONTRACTOR: Paul V. Wright, Santa Rosa.

**MARKET BLDG.**, Oakland, Alameda county. Capitol Co., San Francisco, owner. 1-story reinforced concrete tilt-up, wood roof, concrete floors, 100x300 ft. of area, \$200,000. PLANS and GENERAL CONTRACTOR: H. K. Ferguson Co., San Francisco.

**CHURCH & SUNDAY SCHOOL** building, Hayward, Alameda county. First Presbyterian Church, Hayward, owner. The first unit consisting of a Sunday School and Sanctuary, frame and stucco construction, \$112,597. ARCHITECT: Floyd Comstock, Walnut Creek. GENERAL CONTRACTOR: Wallace Webb & Son, Hayward.

**AUTO SALES & SERVICE BLDG.**, San Rafael, Marin county. Doheman Ford Co., San Rafael, owner. Frame and stucco office and showroom; concrete block with wood roof garage; 13,000 sq. ft., \$83,718. ARCHITECT: Hammond & Woodbury, San Rafael. GENERAL CONTRACTOR: H. E. Rahlmann Co., San Francisco.

**OFFICE BLDG.**, San Francisco. R. C. A. Communications Inc., San Francisco, owner. 4-story type I-B, reinforced concrete construction on pile foundation, 45x137 feet in area, \$325,000. ARCHITECT: Albert R. Reller, San Francisco. GENERAL CONTRACTOR: Louis C. Dunn, San Francisco.

**WEST ORANGE SCHOOL ADDN.**, Orange. Orange Elementary School District, Orange, owner. Frame and stucco classroom and toilet addition to the West Orange School, \$68,500. ARCHITECT: Paul O. Davis and Paul Haynes, associate architect, Los Angeles. GENERAL CONTRACTOR: C. W. Devore, Garden Grove.

**GRANADA SCHOOL**, San Fernando. Los Angeles Board of Education, Los Angeles, owner. 1-story, frame and stucco building; 14-classrooms, two-unit kindergarten, administration unit, assembly-canteen, sanitary facilities, ground improvements, \$368,000. ARCHITECT: C. M. Deasy, Los Angeles. GENERAL CONTRACTOR: Westwood Builders and Leo Wolins, joint venture, Beverly Hills.

**KINDERGARTEN ADDN.**, Ocean View School, Ventura. Ocean View School District, Oxnard, owner. Kindergarten addition to Ocean View School; concrete masonry, structural steel, sheet metal, steel sash, plaster, acoustic tile, chalkboards and tack-boards, metal toilet partitions, plumbing, electrical, and painting, \$31,199. AR-

## SLEEPERS

UNI-BOND—PRECAST—  
PERMANENT—NEVER ROT—  
PERMANENTLY  
NAIL PENETRABLE  
FIRE PROOF  
SECURELY BONDED TO  
THE CONCRETE SLAB

Make Solid Non-Squeaking  
Permanent Wood Flooring

Used in spring floor construction for  
Gymnasiums and dance floors, also  
under solid wood floor construction.  
Spaced on any centers desired. Specifi-  
cations and information available on  
request.

Territories open for qualified repre-  
sentatives. Free consultation service.

**LeROY OLSON  
COMPANY**

3070 Seventeenth Street,  
San Francisco, California

CHITECT: Kenneth Hess, Ventura. GENERAL CONTRACTOR: Treiberg & Ruesink, Ventura.

**HIGH SCHOOL ADDN.** Pleasant Hill High School, Pleasant, Hill, Contra Costa County, Mt. Diablo Unified School Dist. owner, Concord. 7-Classrooms, multi-use rooms, shop buildings; frame and stucco construction, \$376,376. ARCHITECT: Anderson & Simonds, Reynolds & Chamberlain, Conler & Willis and John Lyon Reid, Oakland. GENERAL CONTRACTOR: Idenco, Oakland.

**PRIVATE HOSPITAL.** Redwood City, San Mateo county. Woodside Acres Hospital, owner. 1-story concrete block and frame construction to accommodate 18-beds, \$96,746. ARCHITECT: Albert W. Kahl, San Mateo. GENERAL CONTRACTOR: R. F. Royden, San Mateo.

## IN THE NEWS

### BANK SITE PURCHASED

The Bank of America, San Francisco, has purchased a site in Hayward for the construction of a new Bank building. Estimated cost of the new structure is \$100,000.

### GLENDALE CHURCH

The Zion Lutheran Church of Glendale has commissioned Architect William E. Foster of Los Angeles, to prepare drawings for the construction of a reinforced brick and artificial stone trim building in Glendale.

Facilities will include classroom building and will cost approximately \$140,000.

### CHURCH AND SUNDAY SCHOOL

The First Presbyterian Church of Vallejo, California, will build a new Church, Sunday School, and Fellowship Building in Vallejo at a cost of \$250,000, according to a recent announcement.

Of frame and stucco construction, the new facilities are being designed by Architect Donald Powers Smith of San Francisco.

### NEW ELEMENTARY SCHOOL READIED

Architect Bolton C. Moise, Jr., of Riverside, has been commissioned to prepare plans and specifications for a new elementary school for the Romoland Elementary School District, Riverside county.

### PALO ALTO STORE

Architect Morgan Stedman of Palo Alto has completed design of a 17,000 sq. ft. building for the firm of Stern & Price to be built in Palo Alto.

An unusual amount of plate glass will be used in the construction.

### NATIONAL TECHNICAL LIGHTING CONFERENCE

A wide range of subjects will be presented at the technical sessions of the Illuminating Engineering Society Conference in New York City on September 14-17, according to advance announcements.

Some 1000 members and guests are expected to attend the sessions which will

be highlighted by a paper presented by Dr. W. S. Stiles of the Department of Scientific and Industrial Research, National Physical Laboratory, London, England.

Reports will include "Lighting Progress," "Lighting Service," "Residence Lighting," and "Vision Specialists."

E. M. Strong of Cornell University will be succeeded as president of the Society by A. H. Manwaring, Executive vice-president, Philadelphia Electrical & Mfg. Co.

### ALL-BRITE DESIGN MAKES DEBUT

Designed for pendant mounting, the Californian is a luminous indirect fixture which combines low brightness, high efficiency and clean, slim western contemporary lines.



Full reflecting transmitting ribbed polyester plastic panels are curved at a radius which is modern in appearance and allows ideal levels of illumination for classrooms, offices and other interiors. Metal parts finished in high-reflectance baked enamel; accessible for maintenance, manufactured by Fluorescent Fixtures of California, San Francisco, Los Angeles, Portland.

### ARCHITECT SELECTED

Lawrence W. Gentry, architect of Los Altos, has been commissioned by the Los Altos Union Church to draft plans and specifications for the construction of a new Church Building in Los Altos.

Estimated cost of the project is \$100,000.

### SCHOOL BONDS ARE APPROVED

Electors of the Lake Tahoe Unified School District recently approved a school bond issue of \$350,000.

Funds are to be used for the construction of a new Elementary School at El Tahoe in El Dorado county.

### ARCHITECT MOVES OFFICES

W. Z. Smith, Jr., Phoenix, architect, has moved his offices from 1127 E. Camelback Rd. to new headquarters on 7th Street, Phoenix.

Smith's new offices were designed and built under his direction.

### HARBOR PLYWOOD NAMES CALIFORNIA MANAGER

George A. White has been appointed manager of the Harbor Plywood Corp. of California, according to H. W. Van Natta, supervisor of sales warehouses, Aberdeen, Washington.

White is well known in the lumber industry having been associated with Harbor for more than ten years in various sales capacities. He succeeds Wayne I. Rawlings.

Harbor maintains warehouse facilities in San Francisco and Oakland.

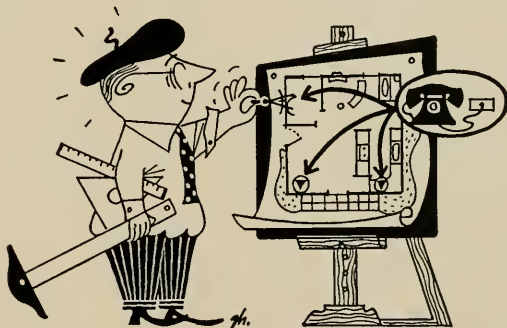

## Don't forget the 'master' touch of built-in telephone facilities

Your clients will appreciate the idea of concealed wiring and neat telephone outlets conveniently located to take care of their present and future telephone installations and changes. Wise home-owners today know the advantages of low-in-cost, high-in-satisfaction planned telephone facilities.

Just call Pacific Telephone's free Architects and Builders service. We'll gladly help you plan telephone facilities for greater beauty tomorrow in homes you are building today.

Put built-in telephone facilities in your plans



Pacific Telephone

**NEW TWO GUN CATHODE RAY TUBE ANNOUNCED**

Larger display, higher sensitivity, and closer tolerances are the features of the new type 72RA, two-gun, cathode ray tube just announced by the Electronic Tube Corp. of Philadelphia, Penna.



The new 7" tube is designed for use in dual-channel oscilloscopes having high sensitivity. Electric-static focus and deflection as well as adequate shielding against cross talk is used. Tube is normally coated with P1 phosphor, but other standard phosphors supplied upon request.

**FISCHER APPOINTED OVERLY ASSISTANT SALES MANAGER**

Malcolm E. Fischer, formerly executive

secretary of the National Metalclad Door Association, has been appointed assistant sales manager of the Overly Manufacturing Company, according to an announcement by Herbert W. Wehe, Overly, president.

Fischer will serve as advisor and consultant in metal and metal clad fire doors as well as traveling representative for the firm which operates manufacturing plants in Los Angeles, California and Greensburg, Penna.

**COURT HOUSE ANNEX**

The Board of Supervisors of Glenn county recently commissioned Architect Albert W. Kahl of San Mateo to draft plans for the remodel of the Annex to the Glenn County Court House in Willows.

Cost of the proposed work will approximate \$30,000 according to George S. Lewis, chairman of the board.

**HONORARY DEGREE IN ENGINEERING**

Brig. Gen. David Sarnoff, chairman of the Board, Radio Corp. of America, was given the honorary degree of Doctor of Engineering at the Drexel Institute of Technology, Philadelphia, Pa., during the Institute's

66th commencement exercises when 981 students were graduated with bachelor of science and master of science degrees in engineering, business administration, home economics and library science.

The presentation was made by Dr. James Creese, institute president.

**CONCRETE INSTITUTE REGIONAL MEETING**

The American Concrete Institute's Southwest Regional Meeting will be held October 29-30 in Houston, Texas.

Co-chairmen of the event are Prof. Phil M. Ferguson, chairman of the department of Civil Engineering, University of Texas, Austin, and John A. Murlin, Texas Concrete Products Corp., Austin.

**ARCHITECT SELECTED**

The architectural firm of Hertzka & Knowles, San Francisco, has been commissioned by the Housing Authority of the City and County of San Francisco to draft plans and specifications for the construction of a 350-unit Low Rent Housing project in San Francisco.

It is estimated the cost of the project will exceed \$2,500,000, and will comprise 2-story frame and stucco row-houses.

**SCHOOL BONDS APPROVED**

Qualified electors of the Sonoma Elementary School District of Sonoma, approved issuance of special school bonds for the construction of a new 9-classroom, kindergarten, and administration, multi-purpose and kitchen Elementary School in the City of Sonoma.

Mario Ciampi, San Francisco, is the architect.

**ALASKA US ENGINEERS MOVE SEATTLE OFFICE**

Col. L. H. Foote, Alaska District Engineer, announced recently that the Seattle Branch office of the Alaska District Corps of Engineers, had been moved to 4735 East Marginal Way.

Lt. Col. Edward P. Arnold is Officer in charge.

Identity and function of the office will remain separate and distinct from the Seattle District, although the two offices are located in the same building.

**PARKING GARAGE SAN FRANCISCO**

The State Board of Harbor Commissioners is contemplating the possibility of developing an automobile parking area north of the Ferry Building in San Francisco.

The proposed project would consist of a 3-story reinforced concrete building on concrete pile foundations, and according to preliminary estimates would cost in the neighborhood of \$1,500,000.

S. S. Gorman has been selected as Chief Engineer of the project.

**SOUTH HILLS COUNTRY CLUB**

Architect Richard H. Plegler of Corona Del Mar has been commissioned by the South Hills Country Club to draw plans and specifications for a new Club at West Covina.

**APARTMENT PROJECT**

A 1500 apartment project is scheduled to be built in Phoenix, Arizona, this summer, according to Ralph Haver, Phoenix.

MECHANICAL	ELECTRICAL	INDUSTRIAL
<h2 style="margin: 0;">GEORGE S. ERSKINE &amp; ASSOCIATES</h2> <p style="margin: 0;">CONSULTING ENGINEERS 1618 EL CAMINO REAL MENLO PARK, CALIFORNIA PHONE COLLECT DAVENPORT 3-1396 TWENTY SEVEN YEARS :: FOUNDED 1926</p>		

# VALUABLE NEWS SERVICE

- BUILDING MATERIAL DEALERS
- CONTRACTORS
- SUB-CONTRACTORS
- MANUFACTURERS AND REPRESENTATIVES

**ARCHITECTS REPORTS** gives advance news on construction projects in Northern California, lists: name of projects, location, architect, proposed cost and other pertinent information.

**HANDY** individual slip-reports, issued daily at a total cost of only

\$10 a month

## ARCHITECT'S REPORTS

Published Daily

The ARCHITECT and ENGINEER, Inc.

68 Post Street, San Francisco - DO 2-8311



## E. H. MOORE & SONS

GENERAL  
CONTRACTORS



693 MISSION STREET  
SAN FRANCISCO

## CLASSIFIED ADVERTISING

Will Bring Results

—USE—

## ARCHITECT and ENGINEER

68 Post St. San Francisco

## MULLEN MFG. COMPANY

BANK, STORE AND OFFICE  
FIXTURES—CABINET WORK  
OF GUARANTEED QUALITY  
CHURCH SEATING

Office and Factory  
60-80 RAUSCH ST., bet. 7th and 8th Sts.  
San Francisco  
Telephone UNderhill 1-5815

who has been appointed architect for the project.

Thirty buildings and a shopping center are included in the plan which will take two years to complete at an estimated cost of \$12,000,000.

### TO BUILD CITY

The Del Webb Construction Company of Phoenix, and the M-O-W Homes, Inc. of Bellflower, California, are scheduled to build the new Arizona copper mining city of San Manuel for the San Manuel Copper Company, subsidiary of the Magma Copper Corp.

Two-thousand homes are being planned to serve an estimated population of 7000.

### INTRODUCES NEW BATHROOM CABINET

One of the newer bathroom cabinets combines distinctive luxury and practical price in a modern sliding door design. Beautifully finished in white enamel, the cabinet provides attractive decorator contrast on both white and colored walls.

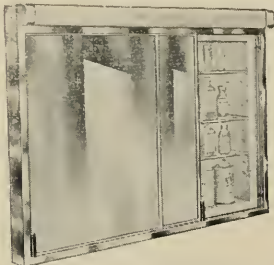

The two large, smooth-sliding mirror doors, are set into stainless steel frames by a special process which eliminates clouding, peeling or discoloring due to steam or moisture.

"SLIDE-O-NETTE" doors are 16x20 in.; cabinet interior 27x17x4½ inches; doors and shelves removable for easy cleaning. Manufactured by Premier-Hall Mfg. Co., Chicago 47, Ill.

### HALL OF RECORDS

Harold F. Kellogg of Pasadena has been appointed architect by the Los Angeles county board of supervisors to design plans and specifications for alterations to the Hall of Records, Los Angeles.

Cost of the work will approximate \$200,000.

### BANK AND OFFICE

The 1st National Bank of Nevada, Reno, is completing remodeling of its building in Reno, according to architects Ferris & Erskine.

The 4-story and basement building, type 2, is structural steel frame and reinforced concrete. A penthouse is also included in the work. Cost is \$500,000.

### KAISER GYPSUM APPOINTS COSTA

Robert A. Costa, formerly administrative assistant to the general sales manager of Kaiser Gypsum Company, Inc., has been named the Company's assistant general sales manager.

Subscribe  
Now —

## ARCHITECT and ENGINEER

\$3.00  
Per Year

## DINWIDDIE CONSTRUCTION COMPANY

## BUILDERS

CROCKER BUILDING  
SAN FRANCISCO



## HERRICK IRON WORKS STRUCTURAL STEEL REINFORCING STEEL

18TH AND CAMPBELL STS.  
OAKLAND, CALIF.  
Phone GLancourt 1-1747

Phone GARfield 1-1164

## Thomas B. Hunter DESIGNER OF HEATING

AIR CONDITIONING  
VENTILATING AND WIRING  
SYSTEMS, MECHANICAL  
AND ELECTRICAL EQUIP-  
MENT OF BUILDINGS



41 SUTTER STREET  
ROOM 710  
San Francisco California



# ARCHITECT and ENGINEER

Please enter my subscription for  
..... year.... My check in the  
amount of \$..... is attached.  
1 year . . . . \$3.00  
2 years . . . . 5.00

Name.....  
City.....  
State.....

## ABBOT A. HANKS, INC. Engineers & Chemists

INSPECTING — TESTING — CONSULTING  
CONCRETE • STEEL • MATERIALS  
CHEMICAL AND TESTING  
LABORATORIES  
• RESEARCH AND INVESTIGATION •  
TESTS OF STRUCTURAL MATERIALS  
DESIGN OF CONCRETE MIXES  
SHOP AND ERECTION INSPECTION OF  
STRUCTURES AND EQUIPMENT  
INVESTIGATION OF STRUCTURES  
AND MATERIALS  
TESTS AND INVESTIGATION OF  
FOUNDATION SOILS  
FIRE RESISTANCE AND INSULATION  
TESTS

624 Sacramento Street, San Francisco

## PITTSBURGH TESTING LABORATORY

ENGINEERS AND CHEMISTS

Testing and Inspection of Concrete,  
Steel and Other Structural Materials

Design of Concrete Mixes

Offices in all principal cities

651 Howard St., San Francisco 5  
EXbrook 2-1747

## MATTOCK CONSTRUCTION COMPANY



BUILDERS



604 MISSION STREET  
SAN FRANCISCO

## Index to Advertisers

ARCHITECTS Reports .....	48
ATLAS Heating & Ventilating Co., Ltd. ....	23
BARRETT & HILP, Contractors ..	37
BETTANCOURT, Jos. ....	27
BY-CHEMICAL Products Co. ....	36
CALAVERAS Cement Co. ....	36
CALIFORNIA Builders Hardware Co.	25
CAMBRIDGE Tile Mfg. Company ..	5
CLAY Brick & Tile Association ..	*
CLASSIFIED Advertising .....	45
CLINTON Construction Company ..	38
CLINTON Mill & Mfg. Co. ....	25
CROCKER First National Bank ..	*
DINWIDDIE Construction Company	49
ENGINEERED Metals, Inc. ....	24
ERSKINE, Geo. S. & Associates ..	48
FINK & SCHINDLER Co., The ..	35
FORDERER Cornice Works .....	37
GAMERSTON & GREEN Lumber Co.	26
GENERAL Hotel Supply Co. ....	27
GILMORE Fabricators, Inc. ....	22
GLADDING, McBean & Company ..	1
GOLDEN GATE Iron Works .....	23
GREENBERG'S, M. Sons .....	34
HAAS & HAYNIE Const. Co. ....	38
HANKS, Abbott A., Inc. ....	50
HAWS Drinking Faucet Co. ....	30 & 31
HERMANN Safe Co., The .....	26
HERRICK Iron Works .....	49
HOGAN Lumber Co. ....	38
HUNDLEY, E. M. Hardware Co. ..	27
HUNT, Robert W. Company .....	50
HUNTER, Thos. B. ....	49
IDEAL Cement Co. .... Back Cover	
INERTOL Co., Inc. ....	35
JOHNSON, L. N. & Son .....	24
JOHNSON, S. T. Co. ....	* 38
JUDSON, Pacific-Murphy Corp. ....	38
KRAFTILE Company .....	28
MARBLE Institute of America ..	*
MATTOCK Construction Co. ....	50
MICHEL & Pfeffer Iron Works, Inc.	2
MINTON Lumber Co. ....	23
MOORE, E. H. & Son .....	49
MULLEN Mfg. Co. ....	49
OLSON, LeRoy Co. ....	46
PACIFIC Coast Aggregates .....	29
PACIFIC Manufacturing Co. ....	39
PACIFIC Telephone & Telegraph Co.	47
PARKER, Steffens & Pearce .....	37
PITTSBURGH Testing Laboratory ..	50
POOR Richard Engraving Co. ....	49
PORCELAIN Enamel (Architectural Division) Publicity Bureau .....	7
REGAL Roofing Co. ....	22
REMILLARD-Dandini Co. ....	50
REPUBLIC Steel Corporation .....	39
RICHARDS Reinforcing Steel .....	25
SCOTT Company .....	50
SIMONDS Machinery Company ..	39
SMOOT-Holman Company .....	Inside Front Cover
STEEL Form Contracting Co. ....	24
SUMMERBELL Roof Structures ..	35
TRASK & SQUIRE .....	21
UNIVERSAL Window Co. ....	26
UNITED Floor Covering Co. ....	25
U. S. Bonds .....	Inside Back Cover
VALLEJO Building Materials Co. ..	27
VERMONT Marble Company .....	39
WEST Coast Screen Co. ....	40
WORLEY & Co. ....	21

\*Indicates Alternate Months

## ROBERT W. HUNT CO.

ENGINEERS

INSPECTING TESTING

STRUCTURAL MATERIALS  
CONCRETE MIX DESIGN  
CHEMICAL ANALYSIS  
EQUIPMENT

PRINCIPAL CITIES  
UNITED STATES • EUROPE  
SAN FRANCISCO • LOS ANGELES  
PORTLAND • SEATTLE

## REMILLARD-DANDINI Co.

Brick and  
Masonry Products



400 MONTGOMERY STREET  
SAN FRANCISCO, CALIF.

## Scott Company

HEATING • PLUMBING  
REFRIGERATION



San Francisco  
Oakland  
San Jose  
Los Angeles

## FOR ADVANCE INFORMATION

ON  
BUILDERS  
CONTRACTORS  
ENGINEERS

Get

ARCHITECTS  
REPORTS

68 Post St. Phone  
San Francisco DO 2-8311

# ARCHITECT AND ENGINEER

SANTIAM RIVER HOME . . . near Lebanon, Oregon



ARNOLD SOUTHWELL and MURLIN DRURY, A.I.A., Architects

SEPTEMBER

1953



# A Daily Report Service

On building construction projects in Northern California.

The name of project, location, architect, proposed cost and other valuable news on building and construction projects in Northern California . . . at less than 1c per name.

Use the REPORTS to develop new customers.

Don't Delay—Subscribe Today!

Mailed to you daily at a flat rate of \$10 per month.

## ARCHITECTS REPORTS

DOuglas 2-8311

EXbrook 2-7182

Published DAILY by

ARCHITECT & ENGINEER, Inc.

68 Post Street

San Francisco, California

# ARCHITECT

Vol. 194 No. 3

ARCHITECTS' REPORTS—Published Daily

# AND ENGINEER

Contents for

## SEPTEMBER

EDWIN H. WILDER  
Editor

J. WELLS HASTINGS  
Contributing Editor

PROF. LELAND VAUGHAN  
Landscape Architecture

JOHN A. BLUME  
Structural Engineering

MICHAEL GOODMAN  
Planning

JOHN S. BOLLES, A.I.A.  
Book Reviews



### COVER PICTURE

RAMSDELL'S  
SANTIAM RIVER  
HOME

Lebanon, Oregon

Architects:

Arnold Southwell  
Murlin Drury

Night view taken through full wall windows emphasizes the charm of this unusual wall and residence, which has been finished in natural color. Cardinal red framing heightens golden natural grain and textures of wood. For full details of this "Rural Showplace" see page 16.

*Photo taken by Tom Burns, Jr.*

ERNEST McAVOY  
Advertising Manager

ARCHITECT & ENGINEER  
is indexed regularly by  
ENGINEERING INDEX, INC.

EDITORIAL NOTES . . . . .	2
NEWS & COMMENT ON ART . . . . .	4
PAPER MANUFACTURING PLANT, Tracy, California . . . . .	6
American Reinforced Paper Company. William Corlett, A.I.A., Architect; Peter H. Skaer, A.I.A., Associate Architect; John M. Sardis, Structural Engineer; G. M. Simonson, Mechanical & Structural Engineer; Osmundson & Staley, Landscape Architects; B & R Construction Co., General Contractors.	
HILLSIDE RESIDENCE, Paradise Cove (Marin County), California . . . . .	11
Mr. and Mrs. Leslie Gottwald, Owner. Bruce E. Heiser, A.I.A., Architect; John A. Nelson, Contractor.	
RAMSDELL'S SANTIAM RIVER HOME, A Rural Showplace, Lebanon, Oregon . . . . .	16
Mr. and Mrs. Vittz Ramsdell, Owner. Arnold Southwell and Murlin Drury, A.I.A., Architects, By Arthur W. Prialuk.	
AUSTRALIA ENGINEERS PLAN JET AIRCRAFT AIRPORT . . . . .	23
Sending Users Underground. Part One. By John Loughlin.	
LIBERTY HOUSE, Modern Department Store . . . . .	24
Kailua (Suburb), Honolulu Hawaii. Rothwell & Lester, Architects; Burke, Kober & Nicolais, Designers.	
A.I.A. ACTIVITIES . . . . .	26
WITH THE ENGINEERS . . . . .	28
PRODUCERS COUNCIL PAGE . . . . .	30
Edited by Stanley L. Basterash, Western Asbestos Co.	
PERSONALITIES . . . . .	32
Francis Joseph McCarthy, A.I.A., Architect, San Francisco.	
BOOK REVIEWS, Pamphlets and Catalogues . . . . .	36
ESTIMATOR'S GUIDE, Building and Construction Materials . . . . .	39
ESTIMATOR'S DIRECTORY, Building and Construction Materials . . . . .	41
CONSTRUCTION CONTRACTS AWARDED and Miscellaneous Data . . . . .	42
BUILDING TRADES WAGE SCALES, Northern, Central & Southern California . . . . .	43
CLASSIFIED ADVERTISING . . . . .	43
IN THE NEWS . . . . .	45
INDEX TO ADVERTISERS . . . . .	48

ARCHITECT AND ENGINEER (Established 1905) is published on the 15th of the month by The Architect and Engineer, Inc., 68 Post St., San Francisco 4; Telephone EXbrook 2-7182. President, K. P. Kierulff; Vice-President and Manager, L. B. Penhorwood; Treasurer, E. N. Kierulff.

Los Angeles Office: Wentworth F. Green, 439 So. Western Ave., Los Angeles 5; Telephone DUinkirk 7-8135.

Entered as second class matter, November 2, 1905, at the Post Office in San Francisco, California, under the Act of March 3, 1879. Subscriptions United States and Pan America, \$3.00 a year; \$5.00 two years; foreign countries \$5.00 a year; single copy 50c. ARCHITECTS' REPORTS are published daily from this office, Vernon S. Yallop, Manager.



## PROBLEMS? YOU JUST THINK SO

You think you have problems?—around the office, with your clients, with the contractors, with the building material supply manufacturers and dealers—You do not know what trouble is . . . you are in the better of the elite professional professions and the great serious problems of today pass right by your door.

If you do not think so, give up your present activity and try what you may think is a greener field—take the automobile business for instance.

Since the turn of the century the industrial history of the nation has been shaped by the passionate love of the American for his automobile—sure, food, clothing and a roof over head was important, but, an automobile! that was a must even if it was necessary to skimp just a little on some of the other things.

So great and indispensable has become the automobile that tabulation by the National City Bank of the largest American corporations, on the basis of sales for 1952—which will carry along into 1953—the twenty-five largest corporations are shown to have sold \$56,635,000,000 worth of goods, and of this, 42½% or \$24,150,000,000, was credited directly to the automotive business.

The first half of 1953 has seen automobiles made at a record pace, but reports indicate the used cars—which have to be taken in on new ones in the majority of instances—are piling up on lots, a fact which anyone can see for himself by a little directed observation. These used cars must be sold, so must the new ones, if the present rate of production is to be maintained. So, the problem becomes of greater importance each day.

Talk to a few key men in these "greener pasture" businesses and you will agree with us that you just think you have problems.

• • •

*The United States Treasury took in more money in the five days March 16-20 than it collected in the 83 years from 1789 to 1872, during which time it fought three wars and bought Louisiana, Florida and Alaska.*

• • •

It is easy to see that with the Eisenhower administration starting in Washington with a debt of \$268-billion inherited from Truman, government economy was one of the most urgent problems facing the past session of Congress and the new President. What has been done to date? What will be done?

## GUEST EDITORIAL

# ARCHITECTURAL PROGRAM SHOULD BE PART OF COMMUNITY PLANNING

Mario J. Ciampi, Chairman  
Relations with Allied Arts  
and Affiliated Professions,  
San Francisco Chapter A.A.A.

*The San Francisco Art Commission passed a resolution some time ago in which it recommended "in the interest of beautification and the sponsoring of the Arts, that all future appropriations for building construction by the City and County of San Francisco shall include a minimum of 2% of the estimated gross project cost to be allocated and appropriated for the specific purpose of landscaping, sculpture and painting."*

*We, the architects of this community, are professionally and morally required to make every effort to help the "Art Commission" make this objective a reality so that the public may gain in cultural and spiritual betterment.*

*The recent completion of many new civic and community buildings reveals that frequently architects, though extremely anxious to incorporate the arts in their buildings, have been denied such opportunities because of the failure to approve funds for this work.*

*These basic values are inherent in our work, inseparable as the body and the spirit. We all know that good architecture includes emotional and spiritual qualities as well as economic and functional requirements. That down through the ages all civilizations, whether Egyptian, Greek or Medieval—even the primitive and uncivilized—have all endeavored to integrate the arts in their structures. This is a basic human need which manifests itself in every people, whether in their form of attire, or in the character of their homes. Thus most material possessions have more than a functional value. The decorative attempts to give special interest to these material things indicate that man all over the world, regardless of epoch, environment or race, seeks pleasure and satisfaction in his emotional reactions.*

*We, as a people, the dynamic leaders of world progress, have become so engrossed in materialism that other aspects of life are losing their significance.*

*It is therefore imperative that we architects, as a cultural force in our society, should put forth maximum effort and project into the work at community level the same basic aspirations we have reflected in the wish to enhance man's own personal environment.*

*The artist is the antenna of society, and every society should encourage him to express those values which are not always apparent, and by his recognition identify him with the community rather than discourage the very ideal he has been taught to believe in. The building he helps create, which gives him his education in his art, should in turn stand as a symbol of community aspiration, and as a guide and inspiration for the artist of tomorrow.*

*The forces which guide the destiny of man in his quest for the enrichment of life have for some years manifested themselves in various cities and countries throughout the world. Many people long ago discovered that in order to realize their ideals and to forestall the efforts of those more materially inclined, they must appeal to the public conscience in terms of law. Basic legislation or rules have thus been adopted to regulate the funds expended for civic work, so that a fair share of all funds allocated for new work would be reserved for cultural embellishment such as landscaping, painting, sculpture and other more specialized works of art.*

*During the past few years the writer visited several countries and corresponded with many persons willing to assist in the compilation of information. The results of these efforts show that world-wide the average appropriation for artistic refinement varies from 1% to 2%, and therefore the program suggested by the San Francisco Art Commission is entirely in accordance with generally accepted principles and should be adopted in any community desirous of keeping pace with today's construction trends.*



# WORLD'S SMALLEST COMPLETE KITCHEN!

ONLY 27½ INCHES WIDE!

Perfect For  
MOTELS HOTELS  
APARTMENTS  
OFFICES FACTORIES  
INSTITUTIONS  
SMALL KITCHENS  
TRAILERS  
PATIOS

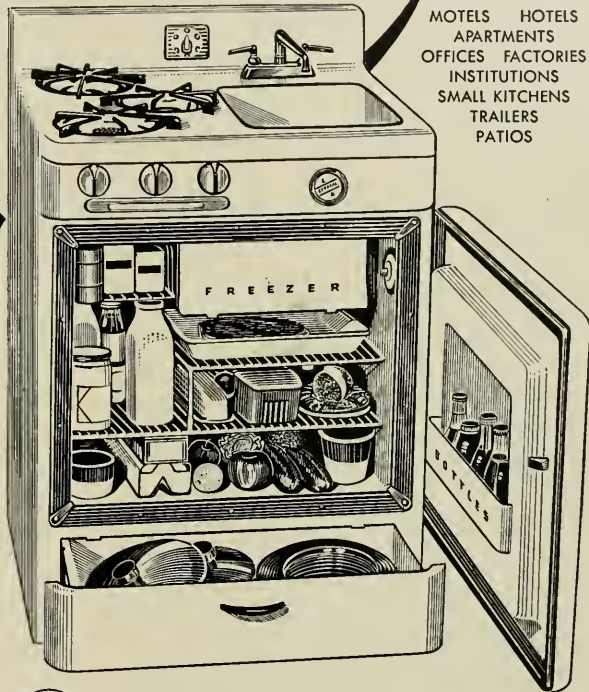

General Chef complete kitchen units fit in 5.4 square feet.

The ideal solution wherever space and dollars are important.

**SINK** One-piece porcelain top of heavy gauge steel. Faucets and all hardware triple-chrome plated. Units also available without sink.

**BURNERS** Units come with 3 gas burners (easily adjusted for bottled, natural or manufactured [L.P.] gas), or 3 electric burners (220 V.) or 2 (110 V.).

**REFRIGERATOR** Four cubic feet of space. Electric (sealed, self-oiling Tecumseh unit). Owens-Corning Fiberglas insulation. Convenient bottle shelf in door.

**FREEZER** Holds 9 ice cube trays, or 12 standard frozen food packages.

**STORAGE DRAWER** Ample storage space for pots and pans.



## 5 YEAR GUARANTEE

Every General Chef Unit is guaranteed in writing to give trouble-free service for 5 years!

# General Chef

NATIONWIDE SALES AND SERVICE

NEW YORK: Dept. A, Suite 762, 11 W. 42nd St.; LOS ANGELES: Dept. A, 4536 E. Dunham St.  
CHICAGO: Dept. A, Room 1108, Merchandise Mart

**WRITE for complete information and specifications** if you are building, remodeling, designing — you will be interested in the space and money you can save with General Chef units. Several models are available. Fully guaranteed. **WRITE TODAY** for complete information and specifications on all General Chef units. We will also send you name and address of distributor nearest you.

GENERAL CHEF, Dept. A, 4536 E. Dunham Street, Los Angeles 23, Calif.

Please send me complete information and specifications on General Chef units, and name of nearest distributor.

NAME \_\_\_\_\_ STREET & NUMBER \_\_\_\_\_

CITY \_\_\_\_\_ ZONE \_\_\_\_\_ STATE \_\_\_\_\_



# NEWS and COMMENT ON ART



## DIRECTOR OF ART GALLERY NAMED FOR U.C.L.A.

Frederick S. Wight, associate director of the Institute of Contemporary Art in Boston, has been appointed professor of art history and director of the art galleries at the University of California at Los Angeles.

A well known author, painter and teacher, Wight has been in charge of educational activities at the Boston Institute for the past four years, and has given courses on modern painting at Harvard and the University of Michigan.

Dr. Gibson Danes, chairman of the U.C.L.A. art department, announced the appointment of Wight.

## UNIQUE ART GALLERY IN SAN JOSE

Something new and different has been added to the art interests of San Jose, California. It is Yvonne's Art Gallery and Gift Shop which is located on U.S. Highway 101, and where lasting mementos of places of interest and historical value in the medium of underglaze decorating on semi-porcelain dinnerware is created. San Francisco scenes on plates and Siamese cat dinnerware are popular throughout the United States.

During September, the Gallery will show the paintings of Sam Harris of Monterey, Pat Cucaro of San Francisco, Jack Green, cowboy artist of California and Nevada, and Jack La Chappelle of Berkeley.

Besides domestic and imported gifts, shut-ins and people who do clever things well at home, here find a ready market for their talent. Young and old participate in this unusual feature.

## COMPETITIONS AND AWARDS

San Francisco Art Association Watercolor Annual: October 14 to November 15, Address SFAA, 800 Chestnut Street, San Francisco.

San Francisco Art Festival: September 24-27. Address SFAA, 800 Chestnut Street.

Fifth Annual Art Fair; Lafayette, California, September 11-15. Painting and Sculpture limited to two. Entry fee of \$1 for each field of art. Address Artists Market, 1045 Stuart Street, Lafayette.

Los Angeles County Fair; Pomona, September 15-30. Address Richard Pettersen, Director of Arts and Crafts, Los Angeles County Fair Association, Pomona.

University of Minnesota Gallery's National Print

Annual; Address 310 Northrup Auditorium, University of Minnesota, Minneapolis. Entry fee \$1.

## M. H. deYOUNG MEMORIAL MUSEUM

The M. H. deYoung Memorial Museum, Golden Gate Park, San Francisco, under the direction of Walter Heil, has announced the opening of Fall activities with a special group of exhibitions and events featuring the Art of The South Pacific Islands. This is an important and comprehensive show of some 350 outstanding works assembled from twenty museums and twelve of the foremost private collections. A profusely illustrated catalog is available on this exhibition.

EXHIBITIONS: Art of The South Pacific; Contemporary Prints from France; Watercolors by Serge Romanovsky; Harnett and His School; and the Third Annual exhibition of the Metal Arts Guild.

SPECIAL EVENTS: Gallery Tours and lectures; Painting for Pleasure featuring Exercises in Perception, for adults. Offering an opportunity to develop more enjoyment of art and of all visual experience. Seminars in the History of Art, will feature a practical discussion led by Charles Lindstrom. Painting Workshop offers painting from the model, and the Children's Classes in Picture Making, Art and Nature, and the Art Club have been resumed for the Fall months.

## CITY OF PARIS

The Rotunda Gallery of the City of Paris, San Francisco, under the direction of Beatrice Judd Ryan, will feature a fall exhibition of the Paintings by Julia Colton, Norma Groton and George O'Connell.

The Pictures of the Month exhibition will feature selections from the City of Paris' Coronation Exhibition, representing a select group of Lithographs by thirty-two British painters.

## SAN FRANCISCO MUSEUM OF ART

The San Francisco Museum of Art, War Memorial Building, Civic Center, is offering the following calendar of events for September:

EXHIBITIONS: Modern Aubusson Tapestries, an American Federation of Arts Exhibition; Mobiles, by Alexander Calder; Bay Area Sculpture; Rio Grande Graphics; Prints by Enid Foster, Mar Jean Kettunen, and Julius Wasserstein; Paintings by Alice Rahon Fitzgerald; Sculpture by Saul

Baizerman; and Contemporary Danish Furniture.

**SPECIAL EVENTS:** Lecture-Tours each Sunday at 3 o'clock; Discussions on art subjects, each Wednesday evening at 8; and the Children's Art Classes each Saturday morning at 10 o'clock which will again feature the Sketch Club and the Painting Class.

**ANNUAL SAN FRANCISCO ART FESTIVAL**

The San Francisco Art Commission's seventh annual Art Festival, staged in downtown Union Square and adjoining Maiden Lane, held the latter part of September, was again an outstanding event in the realm of art, according to Martin Metal, Festival Director.

Panel shelters were erected along the walks and accommodated more than 400 art exhibits and a 30x30 ft. stage provided for dancers and concerts.

**CALIFORNIA PALACE OF THE LEGION OF HONOR**

The California Palace of the Legion of Honor, Lincoln Park, San Francisco, under the direction of Thomas Carr Howe, Jr., opened its fall exhibition season with a group of special exhibitions including:

Concours d'Elegance; selections from the Second International Hallmark Art Award, comprising an array of more than 100 watercolors; Berthe Morisot

and Her Circle, paintings from the collection of Mme. Ernest Rouart, daughter of the artist; an Exhibition of the Museum's publications; Chinese Export Porcelain; Paintings by Helen Dunham; Exhibition of Japanese Folk and Provincial Art, from the Honolulu Academy of Arts and being shown under auspices of The Japan Society of San Francisco; and Works by Four Contemporary Artists—Jeremy Anderson, Ernest Briggs, Hassel Smith and James Weeks.

The Achenbach Foundation for Graphic Arts will feature Prints by Berthe Morisot and her contemporaries, and Four Centuries of Nautical Prints, a loan exhibition at the San Francisco Public Library.

Educational Activities include Painting classes for Children, ages 6 through 14, each Saturday morning at 10, and Painting Clases for Adults each Saturday afternoon at 2. Motion pictures are shown each Saturday afternoon, and the regular Organ Program is offered Sundays at 3 pm.

**CALIFORNIA SCHOOL OF FINE ARTS**

For the first time in its 82 year history, the California School of Fine Arts, 800 Chestnut Street, San Francisco, is offering a Bachelor of Fine Arts degree to students completing an enlarged new four-year program.

Ernest Mundt is Director of the School.

**SAN FRANCISCO MUSEUM OF ART**

**War Memorial Building  
Civic Center  
San Francisco**

**NEGRO WOMAN**

**lacquered wood**

**by**

**SARGENT JOHNSON**

**Albert M. Bender Collection**







THE AMERICAN REINFORCED PAPER COMPANY

# PAPER MANUFACTURING PLANT

## TRACY, CALIFORNIA

WILLIAM CORLETT, A.I.A. Architect

PETER H. SKAER, A.I.A. Architect Associate

JOHN M. SARDIS, Structural Engineer

G. M. SIMONSON, Mechanical & Structural Engineer

OSMUNDSON & STALEY, Landscape Architects

B & R CONSTRUCTION COMPANY, General Contractors

**ENTRANCE  
TO COMPLETED  
BUILDING**



The American Reenforced Paper Company, manufacturers of reenforced building paper and other reenforced papers, with plants in Attleboro, Massachusetts; Gary and Chicago, Illinois; London, England; and in Australia, purchased a thirty acre site in Tracy, California in February, 1952. The company believed that their proposed new plant need not look like the average industrial building. They felt that it should incorporate the principles of contemporary architectural design and selected San Francisco Architect, William Corlett, and his engineering consultants to design and supervise the construction of the mill.

Corlett journeyed to the company's Massachusetts Plant to observe the operation of their Attleboro mill and to determine a basic site utilization plan properly incorporating the various service elements that make up the complex facility necessary to the manufacture of building papers.

The resultant design incorporates many features unique in the field of industrial construction which proved to be attractive in appearance and economical in cost.

San Francisco Structural Engineer, John M. Sardis, utilized a welded steel frame in the 37,600 sq. ft. main building for the following reasons:

1. A 20 percent cost saving in structural steel due to the continuity and simplicity of the design.
2. Elimination of the usual rivets, bolts and clips.
3. Less cleaning maintenance due to the cleaner and simpler exposed framing.
4. The flexibility of the welded steel design allows the use of tapered sections and more desirable girder to column connections.
5. More liberal erection tolerances are allowed.

**Interesting wide-angle view of the front of the plant — main entrance at left and the motor vehicle and railroad loading dock are shown in the right foreground of picture.**

*(Photos on this page were taken by Ernest Braun, Photographer)*





**BEAM TO GIRDER  
CONNECTION**

Showing how shear clips  
were welded to beam flange  
and to girder to obtain  
greater simplicity in  
erection.



**DETAIL**

Steel girder is  
welded to supporting  
steel column with  
extension of column  
to form roof support.

**COMPLETED STRUCTURAL FRAME**

*(Duain Jay, Photos)*





6. Shop welded erection clips designed to take full design loads as well as serving as erection clips simplified erection, allowed greater field erection tolerances and eliminated web welding.
7. Shear clips were welded to the top flanges of the beams and girders supporting the 7" concrete mezzanine floor slab to take advantage of the composite action furnished by the slab to the structural steel beams and girders. This resulted in stiffening of the entire floor as a diaphragm and decreased vibration considerably.

Wood purlins support 2 inch T & G roof sheathing and an insulated composition roof sprayed with aluminum paint.

Corrugated transite is stud welded to horizontal steel channel girts as exterior siding. Flat transite is utilized in the soffits and in spandrels. Ten inch exposed steel channels form the south wall vertical and horizontal facias.

### MEZZANINE PLAN

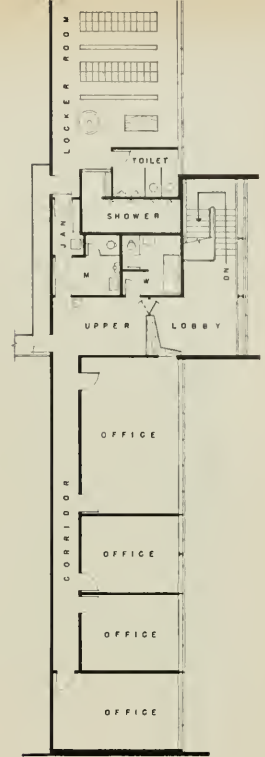

### MAIN FLOOR PLAN showing cross section at top

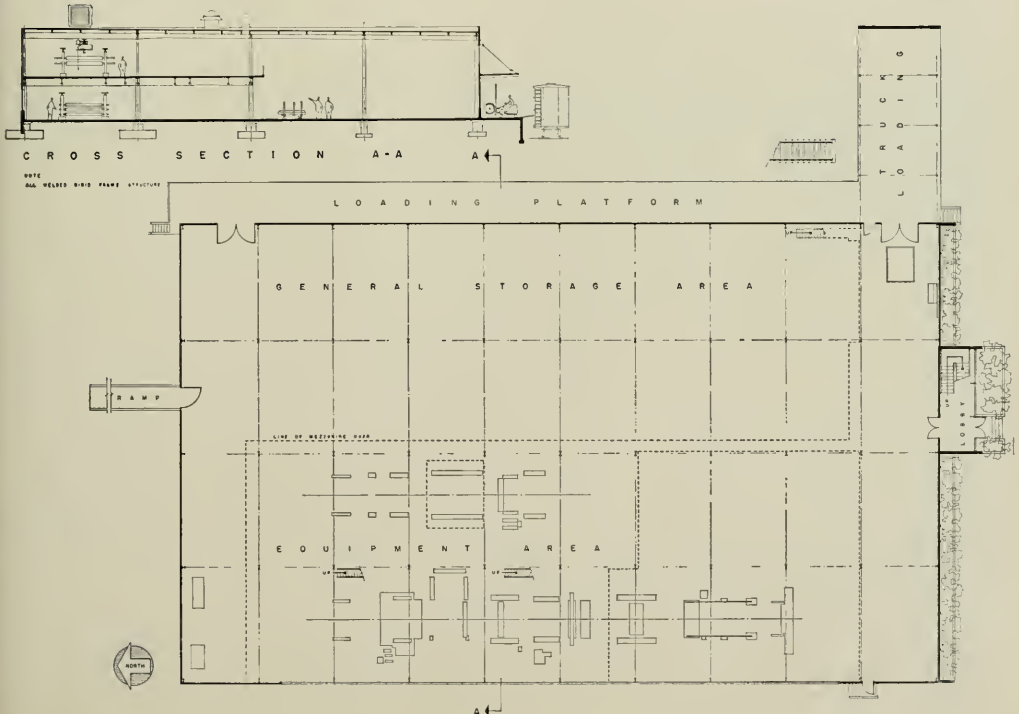

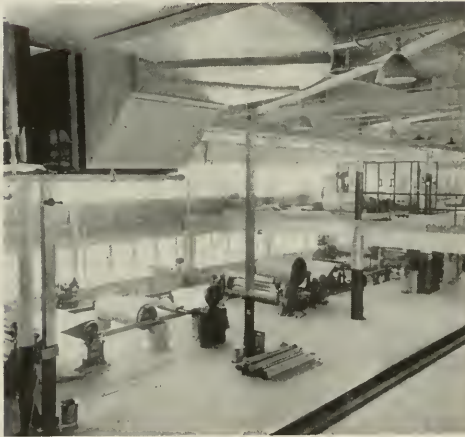

**MANUFACTURING AREA —**  
Showing placement of highly technical equipment for efficiency and maximum natural lighting.

**LOWER —**  
View of utility space adjacent to manufacturing area; note steel beams, girders and support columns.



Glare and heat reducing glass, blue in color, is set in the steel sash. Cool-shade screens cut out south sun in mezzanine office and locker room areas.

The main entrance all glass panel is set in enameled steel tubular frames. Blue and amber glass in alternate glass panels present an interesting and colorful pattern.

The continuous concrete base around the main building is covered with rubber base paint, terracotta in color.

Interior exposed framing, sprinklers and all process piping are painted cream yellow. Columns are painted tile red to a height of 6 feet. Mezzanine office areas are sheathed with ¼ inch mahogany plywood.

The 120 ft. by 200 ft. main building is served by an adjacent covered truck loading platform, railroad car loading dock and spur.

An adjacent steel framed 40 ft. by 60 ft. boiler building houses a hot oil heater, resin tanks and the main boiler. A large incinerator, which burns large amounts of trimmings and waste, is backed up to the boiler house adjacent to the boiler. Mechanical Engineer, G. M. Simonson, at the request

(See page 38)



VIEW OF HOME AND PANORAMA OF BAY FROM APPROACH DRIVE

# HILLSIDE RESIDENCE

Mr. and Mrs. Leslie Gottwald

PARADISE COVE [Marin County], CALIFORNIA



BRUCE E. HEISER, A.I.A.,  
Architect

AUGUST E. WAEAGEMANN, C.E.,  
Engineer

JOHN A. NELSON,  
Contractor

**TERRACED STEPS**  
To bay beach below.

Showing mahogany siding and  
treatment of masonry.

*Photo Courtesy White Bros. Hardwood Co.*



# . . . HILLSIDE RESIDENCE

**SITE:** Marin County, California.  
 Rugged hillside and beach  
 cliff near Paradise Cove,  
 overlooking San Francisco and  
 San Pablo bays.

**AREA:** Total Living Area  
 Square Feet . . . 1,785  
 Total Car Port  
 Square Feet . . . 538  
 Total Living Deck  
 Square Feet . . . 905

**COST:** Total Cost of Project . \$23,500  
 Including — land, construction,  
 architect's fee, and landscaping.  
 Per Square Foot . \$8.20

## FLOOR PLAN

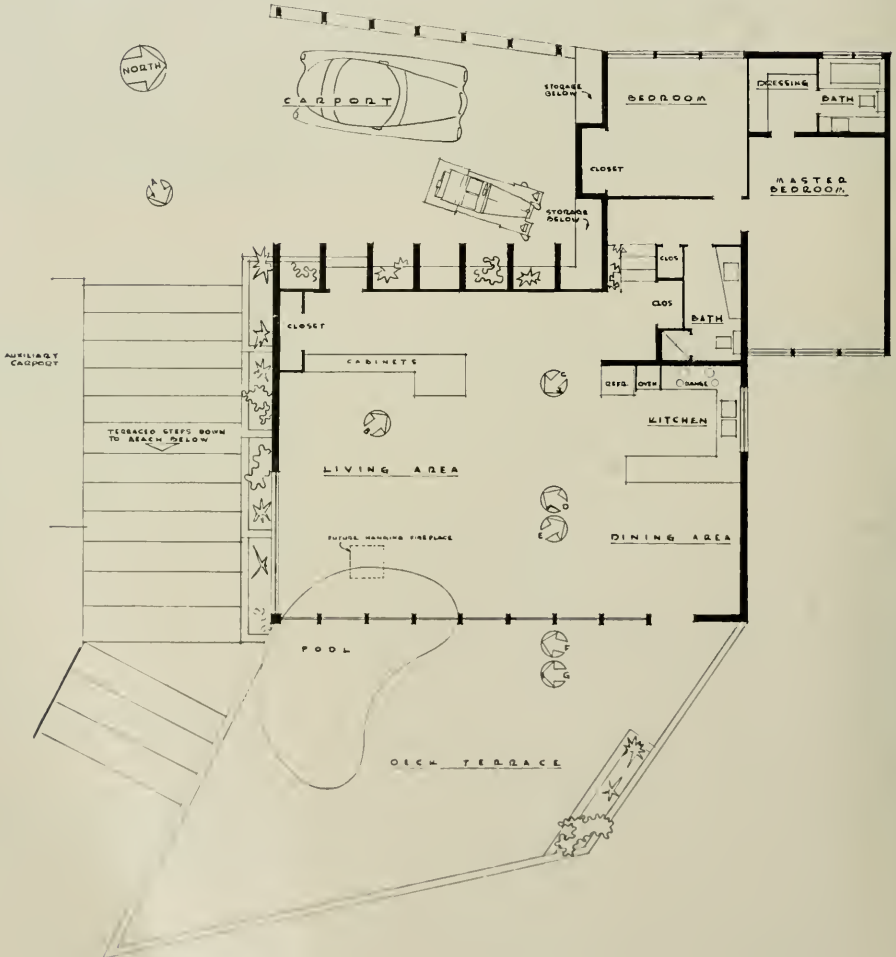

**VIEW**

Shows relation of  
raked glass front  
to pool and terrace.



**LOOKING**

From living room  
towards kidney shaped  
pool, glass window wall  
and terrace, showing  
a portion of Bay  
panorama beyond.



## HILLSIDE RESIDENCE . . .

Economy in construction is due to functional structural design principles, and therefore, according to common practice, by considering the spacious deck and adjoining car port as one-half of the cost of the entire living area—the total estimate of space in this project would be some 2,506 square

feet. Using this as a basis, the cost would then be but \$8.20 per square foot, an admittedly unusually low cost for home construction today.

It should be understood, however, that such a phenomenally low cost was only made possible and was brought about by the very close cooper-



**VIEW TOWARD  
KITCHEN**

**and dining area, showing disposition of fixtures and cabinet work.**

**FROM KITCHEN**

**Looking towards entrance and cabinets. The large wall windows at left. Note exposed overhead beams and wall to wall carpeting.**

*Photos Courtesy White Bros. Lumber Co.*





ation between the owners, the architect and the building contractor. This made possible the liberal use of many economical building materials, and it is important to remember when considering construction costs that building materials fluctuate a great deal in cost according to varying market conditions. A product which might not be in common use today and therefore have a low market price, can increase rapidly with a great demand and in some instances rising costs can necessitate the replacement of an alternate material.

One of the main features of this residence for Mr. and Mrs. Leslie Gottwald, according to Architect Bruce E. Heiser, A.I.A., is the liberal use of imported Philippine mahogany sheathing and trim inside and outside of the structure. Selection of this material was made because of its extremely low present-day cost, and its ability to withstand the variations of summer and winter weather experienced in this particular area on the lower ex-

pense and eastern side of the Coastal Range and Mt. Tamalpais region of Marin County.

It was demonstrated also that use of the Philippine mahogany material speeded-up construction time as there was no time-out for drying of plaster or other wet-wall construction necessary.

As will be noted from the photographs, other features of the home include the full wall-glass windows which afford an excellent panorama view of the bay to the east; the large number of built-in cabinets and features of the kitchen, dining and living room area; the attractive wall-to-wall floor covering, and the planted-wall separating the interior living space from the car port.

The kidney-shaped swimming pool, a portion of which is exposed to the outer deck area, and the other portion extending past the glass-wall into the interior of the home, is unique but definitely synonymous with the "livability" of this California home.

**VIEW from living room, past planter windows towards carport beyond.**





# RAMSDELL'S SANTIAM RIVER HOME

A RURAL SHOWPLACE

LEBANON, OREGON

OWNER: MR. and MRS. VITZ RAMSDELL

ARCHITECTS: ARNOLD SOUTHWELL

A.I.A. MURLIN DRURY

TOTAL COST PER SQUARE FOOT

\$10.50

By ARTHUR W. PRIAULX

Oregon's Santiam river is noted for its beauty and breath-taking vistas, especially as it winds its way across the valley floor from the Cascade Mountains to its juncture with the Willamette. Home sites along its gently sloping banks and in untouched wilderness settings among the native fir and maple, have become as choice and as much sought after as any in Oregon.

Five miles east of Lebanon, Mr. and Mrs. Vittz Ramsdell have built a home of rare beauty to match an exquisite natural setting to get a story-book effect of unusual grace and distinction. Architects Arnold Southwell and Murlin Drury, AIA, of Oswego, Oregon, designed this contemporary ranch style home in its lovely rural surroundings.

Architects Southwell and Drury had several problems to solve in order to achieve this picturesque home. The home first had to fit the surroundings. The site sloped gradually from a flat area to the river's edge where a natural screen of trees formed an attractive boundary. A low ranch-style design was selected as most suitable with exterior walls finished in western red cedar in natural color. The house had to hug the ground contour,

the architects decided, so some tricky foundation pouring came into play.

The two-bedroom home was then designed to catch every possible bit of beauty the river's edge site afforded from the principal rooms of the home. Full river view was arranged for living room, kitchen-breakfast nook and master bedroom. A patio outdoor living area follows the river-side of the Ramsdell home the full length of the living room.

Another problem undertaken by the architects was to design this home on standard centers, spacing and modules so that standard lengths of lumber could be used without waste. As an example, width of the structure was designed so that the main bearing foundation pier line would carry sixteen and ten foot floor joists. Throughout the building similar attention was paid to fully utilize standard lengths of lumber. It developed into a study of economic framing by Owner Ramsdell, who is a lumberman.

The Ramsdell home has been finished outside with vertically applied western red cedar boards ten and twelve inches wide with  $\frac{5}{8}$  inch by four

**Note flow of lines of roof and exterior walls as garage and home are tied together, thus giving the residence a low, rombling effect and a sense of belonging to the site.**





## A RURAL SHOWPLACE . . .

inch cedar battens. One coat of special seal was sprayed on as soon as the siding had been installed and another coat will be sprayed this summer. This treatment has held the natural color of the cedar, which fits beautifully into the rural location, and has the added advantage of being the final exterior treatment which the home will require for many years, the owner believes. This should reduce upkeep to a minimum.

A garage finished in cedar identical with the home, 22 by 26 feet in size, and connected by a breeze-way covered by a roof extension, adjoins the home on the east and follows the close, snug fit of the home in hugging the contour of the ground.

Heart of this home is the living room with two rare features. A solid wall of glass faces the river side with an unforgettable view of rural Oregon.

The outside wall is built up of West Coast hemlock in random widths of four to eight inches with a simple V joint. The hemlock has been finished natural. Centered in the wall is a fireplace made of ceramic marble tile with hemlock mantle and panelled trim.

What gives this hemlock wall such distinction and beauty is the contrast of the ceiling and end walls which are plaster and have been finished in a cardinal color. The effect is to frame the light-colored hemlock wall.

Doors from the living room open onto the patio, into the kitchen, and into the bedroom wing. The sliding door into the kitchen has been painted to match cardinal walls. A sliding birch door to the bedrooms and on the right of the fireplace has been finished in natural color to match the hemlock wall. A short entrance hall from the off-river

**WIDE EAVE overhang makes a very effective "eye shade" for the Ramsdell home, keeping out excessive sunlight, keeping home cool, and serving as roof and shelter for river-side patio lounging area.**



## . . . A RURAL SHOWPLACE

side ends in an entry way at the left of the fireplace. Oak floors cover living rooms, bedrooms and the den-activity room.

Windows throughout the house are fixed mill-work frame, but each room has one or more double hung screened windows to provide ventilation. A continuous screened ventilator under the eaves provides a steady down-river draft which keeps the flat roofed home unusually cool. The roof is built up of three layers, first two of paper and the third of split sheet mineral surface.

Adequate ventilation is provided in the under-house area. The home is a basic frame construction job and economies effected in the design to utilize all standard lengths of lumber without waste in no manner interfered or limited the architects in achieving their goal of a home of outstanding appearance and livability.

Like the living room, the master bedroom has a

full glass wall on the river side. Two double hung windows allow for full ventilation. Both bedrooms have room-height built-in clothes lockers with storage compartments above. Sliding doors accommodate all of these built-ins in the bedrooms, in the den-activity room, and in the kitchen. The kitchen has been designed to give Mrs. Ramsdell a north and an east view of the river with ample windows in two walls. Kitchen built-ins are numerous and roomy and all fixtures and storage installations were custom built from available lumber and plywood.

The basic house floor plan is 53 feet six inches long by 25 feet 10 inches wide. Roof slope is away from river to give height to home on riverside. Living room ceiling follows roof line adding to appearance of spaciousness in this living space of 16 by 29 feet.

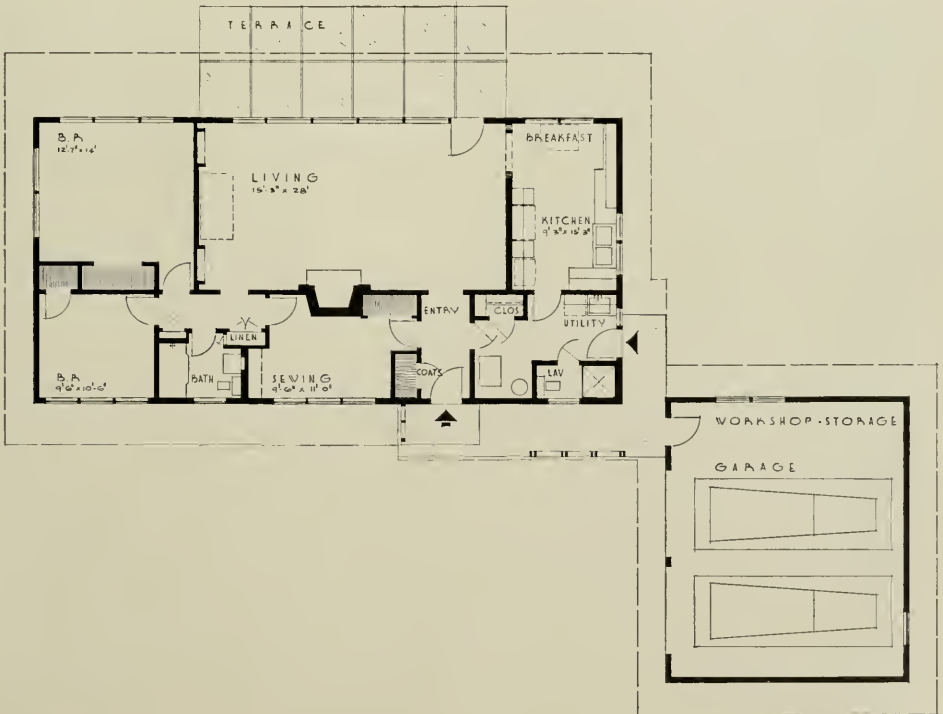



**LIVING ROOM  
WALL WINDOWS**

Faces lovely tree lined  
Santiam one hundred yards  
down hill. Door opens from  
living room into patio  
to make two areas  
almost one.

**LIVING ROOM**

Interesting feature is this  
room where wall of hemlock  
is framed by red tinted  
ceiling and side walls.





**MASTER BEDROOM**

Full floor to ceiling glass wall on river side. Site developed in every possible way, lawns slope to river's edge, trees and shrubs have been left natural.



**DINING NOOK'S RIVER VIEW**

Each room, except one, has a river view. Here two-window view sweeps the Santiam. Kitchen finished in serviceable plywood cabinets, built-ins and modern appliances.



## A RURAL SHOWPLACE . . .

The river side of the kitchen is the breakfast nook and dining space for the Ramsdells. Full view windows open onto an incomparable view of the meandering Santiam, seen through a natural screen of firs, maples and other native shrubs and smaller trees.

Arrangement of the Ramsdell home on the acre plot on the upper area away from the river has created a perfect balance of tree mass on the

lower side offsetting the home. A sloping lawn ties the two together. This is a rural showplace achieved by arrangement of structures on plot as well as affinity of design to natural surroundings, and without excessive expense. The Ramsdell home was built for \$10.50 a square foot including cost of the acre of land, driveways, walks around garage and home, landscaping expense complete with shrubs, lawn and other fixtures.

**ENTRANCE OFF DRIVEWAY** into small entrance-way is sheltered with a cedar screen to break the wind impact. Wide overhand eaves have been used on this south side of home to keep the residence cool.



# AUSTRALIA ENGINEERS PLAN JET AIRCRAFT AIRPORT SENDING USERS UNDERGROUND

Part One

By JOHN LOUGHLIN

Passengers on Australia's future jet air services will be whisked up in elevators from subways under aerodromes to the doors of their waiting aircraft without being exposed to weather or the noise and blast of jet engines.

This is Australia's answer to the world-wide problem of re-designing airports to provide protection for airway users against the scream and blast of jets.

But it is only one of the radical features of an airport that the Australian Department of Civil Aviation has designed for major Australian air terminals. Aviation authorities in the United States of America, Britain and France are interested in this original approach to modern airport design.

The effect of underground passenger facilities at the airport is obtained by building them under an elevated apron section where aircraft normally assemble to embark and disembark passengers and to refuel.

Passengers will enter the airline lounge at road level, and take one of several elevators up to their aircraft standing on the apron overhead. Subways will lead to the elevators serving more distant aircraft positions.

Aircraft will taxi from the runways up a ramp to the apron level cutting off their engines just before they turn into the apron lane at the top of the ramp. Then they will roll down a three per cent slope to the loading positions where chocks will rise from the apron to stop them.

As the elevator carrying the passengers up from the subway reaches the level of the aircraft door, the elevator cabin will roll forward to allow passengers to step straight into the aircraft. Luggage and freight will come up in the lift too. Cargo can be discharged from the front compartment of the aircraft down a chute into the basement.

With passengers comfortably seated and luggage stowed away, both the chocks and the lift will be retracted into the apron and the aircraft will roll down the slope to the engine starting area near

the main taxiway—well away from the terminal buildings.

The scale model built provides for an 18-position apron, handling that number of aircraft simultaneously. It would enable the airport to handle 40 aircraft movements an hour.

Taxiways will be built up like causeways with earthworks, and paved with concrete. Only a comparatively small area of heavily stressed concrete pavement will be needed. This, and the fact that all the buildings will be of normal structure, will keep the cost of the total scheme down to the level of that of a normal airline terminal and apron.

All the usual passenger and freight facilities of an airport will be provided in the terminal buildings.

Built at road level and extending beneath the loading apron, will be the booking hall, passenger lounge, airline office, buffet, cabin services, luggage stations, toilet facilities, freight store, entrance for outgoing passengers from a bus dock and exit for incoming passengers at a second bus dock.

Concourses will run under the loading apron to enable passengers to walk under cover to any of the 18 elevator entrances.

An observation terrace for visitors above the passenger accommodation overlooks the apron. Administration offices are located on a mezzanine floor.

A basement beneath the ground floor level is reserved for freight and luggage rooms, meal preparation, employees' change rooms, and other domestic facilities.

The engineers designed their airport to serve the busy internal air services, but now they are adapting it for an overseas terminal. Additional needs to be met are provision for segregation of aircraft to prevent contact between incoming passengers and the public before customs formalities have been completed. Changes in design of accommodation will make room for customs, health and emigration services.

Detailed planning will still be necessary to complete the airport scheme. In its present stage it has been examined critically by many Australian aviation experts, including airline operators. No fundamental objections have been raised to the

(See Page 38)

*Editor's Note: This special feature was prepared for ARCHITECT & ENGINEER magazine by the author John Loughlin, to show how engineers and the Commonwealth of Australia are cooperating to meet the many problems arising in commercial use of jet aircraft. The article will be concluded next month.*





*Photos by Harold Davis*

# LIBERTY HOUSE

## MODERN DEPARTMENT STORE

KAILUA [Suburb] HONOLULU, HAWAII

ROTHWELL & LESTER - Architects

BURKE, KOBER & NICOLAIS - Designers

The Liberty House, designed by Burke Kober & Nicolaï of Los Angeles and the firm of Rothwell & Lester serving as Architects is the largest department store in the Hawaiian Islands.

This new building is being located at Kailua, one of the important suburbs of the City of Hono-

lulu and will cover an area of 28,000 sq. ft. when completed.

The interior is designed in an informal style. Using a wide variety of building materials. Local beige stone and stucco with a Zolatoned surface make up the general exterior surfaces. The ac-



MEZZANINE

GROUND LEVEL

cents are especially designed ceramic tiles around the entrances and a patterned brick on two walls. Planting has been freely used as part of the architecture both interior and exterior. A continuous marquee is used around most of the building on a walkway featured by varying sizes and shapes of window displays.

The interior will serve the usual large department store facilities: the second level will be used for the Beauty Salon and the Coffee Shop, while the ground level will house the various departments. Wallpapers, woods and design motifs have been selected in character with the semi-tropical atmosphere of the Hawaiian Islands. Colors also have been carefully studied to harmonize with the character of the islands. Each department is individualized as to design and color in keeping with the nature of the department.

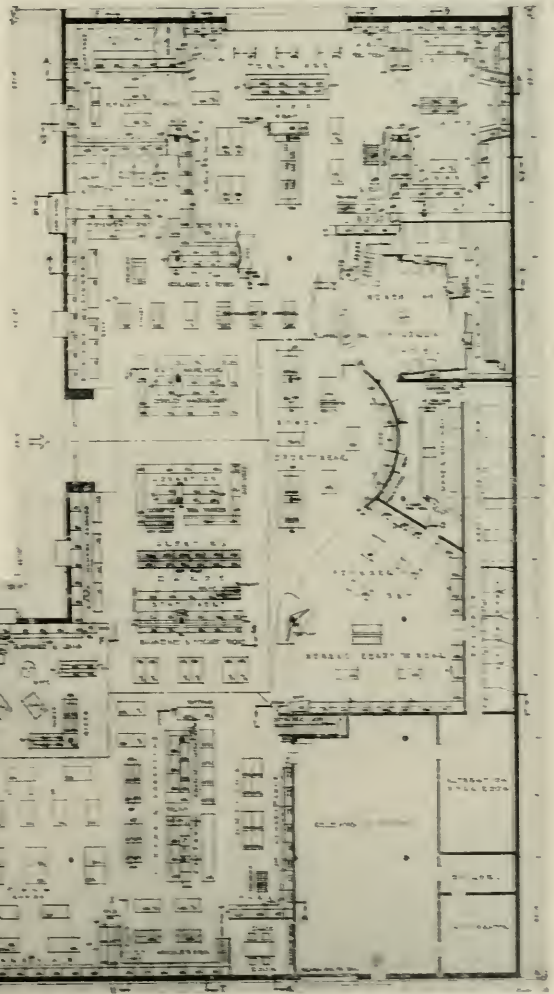



Clair W. Ditchy, President  
Norman J. Schlossman, 1st Vice-President  
Howard Eichenbaum, 2nd Vice-President  
George Bain Cummings, Secretary  
Maurice J. Sullivan, Treasurer

National Headquarters—  
1741 New York Avenue, N. W.  
Washington, D. C.  
Edmund R. Purves  
Executive Secretary

#### Arizona Chapter:

Lew Place (Tucson), President; Ralph Haver (Phoenix), Vice-President; Fred O. Knipe (Tucson), Secretary; James W. Elmore (Phoenix), Treasurer. Secretary Offices, 1324 E. Lester St., Tucson.

#### Coast Valleys Chapter:

Kurt Gross, President; Harold Ahnfeldt, Vice-President; Frank C. Treseder, Secretary; Jerome Kasavan, Treasurer. Directors, Hollis Logue and Gifford Sobey. Offices, 82 S. 3rd St., San Jose.

#### Central Valley of California:

John W. Bomberger, President; Nicholas Tamich, Vice-President; Albert B. Thomas, Secretary; Ted de Wolf, Treas.; Gordon Stafford, Director; Alternate to CCA, Silvio Barovetto; Sec. Office 718 Alhambra Blvd., Sacramento.

#### Colorado Chapter:

James M. Hunter, President, 2049 Broadway, Boulder; Casper F. Hegner, Secretary, 1659 Grant Street, Denver 5.

#### East Bay Chapter:

Malcolm D. Reynolds, President; Donald Hardison, Vice-President; John Lloyd, Secretary; Ed Cerruti, Treasurer. Directors: Chester Treichel, Ira Beals, Cecil Moyer. Secretary's office: 1171 Solano Ave., Albany.

#### Idaho Chapter:

Frederick C. Hummel, President; Jack Woodmansee, Vice-President; Ted Jones III, Sec.-Treas. Offices 1324 Idaho Street, Boise, Idaho.

#### Montana Chapter:

E. Edward Scowcroft, President (Billings); I. Van Teylingen, Vice-President (Great Falls); H. C. Cheever, Secretary-Treasurer. Secretary office, Bozeman.

#### Nevada Chapter:

Russell Mills, President, Reno; Harris P. Sharp, Vice-President, Las Vegas; E. Keith Lockard, Secretary, Reno; Edward S. Parsons, Treasurer, Reno. Directors: L. A. Ferris, David Vhay, Reno, and WALTER ZICK, Las Vegas. Office of President: 309 N. Virginia St., Reno.

#### Nevada State Board of Architects:

Russell Mills, Chairman, Reno; Aloysius MacDonald, Secretary, Las Vegas; Edward Parsons, L. A. Ferris, Reno, and Richard Stadelman, Las Vegas, Members. Office, 393 S. 5th St., Las Vegas.

#### Northern California Chapter:

Donn Emmons, President; Wendell R. Spackman, Vice-President; William Corlett, Secretary; Bernard J. Sabaroff, Treasurer. Directors: Charles S. Popa, Wm. Stephan Allen and Lawrence A. Kruse, Helen H. Ashton, Office Sec., Office, 26 O'Farrell St., San Francisco.

## ARCHITECT DEASY OF LOS ANGELES SELECTED TO STUDY GERMAN PROBLEM

C. M. Deasy, architect of Los Angeles, has been selected as one of the eight United States architects to tour Western Germany to study reconstruction procedures and community planning as guests of the Federal German Republic.

The group will fly to Frankfurt and will spend three days in Bonn for conferences with various ministries. Traveling in Western Germany and visiting West Berlin will occupy the remainder of their stay in the country.

Deasy, secretary of the Southern California Chapter of The American Institute of Architects, is an instructor in industrial design at the Art Center School in Los Angeles.

*Remember it's*

## KRAFTILE

- for ★ GLAZED STRUCTURAL  
WALL UNITS  
★ PATIO TILE  
★ FACE AND  
ROMAN BRICK  
★ ACID FLOOR BRICK  
★ HEARTH BRICK  
★ BRICKETTES  
★ MINWAX TILE &  
CONCRETE FLOOR FINISH

For complete information and prompt service, phone or write

## KRAFTILE COMPANY

HILES, CALIFORNIA

HILES 3611

LOS ANGELES 13: 404 South Main Street—MUTUAL 7241

## PUBLIC INVITED TO ARCHITECTS MEETING

The Southern California Chapter, AIA, recently invited the public to attend a joint meeting of the Chapter with the Southwest Chapter of the American Society of Architectural Hardware Consultants at which a technical discussion was presented by the architects to the consultants.

Following the general discussions an open forum was held. A. C. Zimmerman, chairman of the Technical and Materials Committee, served as moderator.

## PASADENA CHAPTER

The regular September meeting was in the form of a barbecue in Altadena, at the home of Ken Gordon, with arrangements in charge of the Junior Associates. Don Ramberg, presided, at a non-architecture "Trip to the Enchanted Isles" in the form of a motion picture taken by Charles Rucker off the coast of Mexico. Rucker served as narrator during the film's showing.

## WASHINGTON STATE CHAPTER

Dr. S. Harvard Kaufman, professor at the University of Washington in the Department of Psychiatry was the principal speaker at the September meeting taking as his subject—"Interpretation of



Orange County Chapter:  
Paul O. Davis (Los Angeles), President; Ralph Madjeski (Santa Ana), Vice-President; Geo. Lind (Newport Beach), Secretary; Wm. L. Faulkner (Santa Ana), Treasurer. Secretary's Office: 2919 Newport Blvd., Newport Beach.

Oregon Chapter:  
Holman J. Barnes, President; Albert W. Hilgers, Vice-President; Donald W. Edmundson, Secretary; DeWitt C. Robinson, Treasurer, and H. Abbott Lawrence, Trustee. Office of Secretary, 325 Henry Bldg., Portland.

Pasadena Chapter:  
Robert E. Langdon, Jr., President; Wallace C. Bonsall, Vice-President; Robert L. Deines, Secretary; Henry C. Burge, Treasurer; and Directors John N. Douglas, R. VanBuren Livingston, Scott Quintin and Burton Romberger. Offices: 259 South Los Robles Ave., Pasadena 5.

San Diego Chapter:  
Donald Campbell, President; Victor L. Wulff, Jr., Vice-President; Richard L. Pinnel, Secretary; Edward G. Holliday, Treasurer; Louis A. Dean, Director. Office Sec., San Diego Trust & Savings Bldg.

San Joaquin Chapter:  
Maurice J. Metz (Fresno), President; Allastair Simpson, Vice-President; Al Edley, Secretary; Robert Stevens, Treasurer. Directors: David H. Horn, Wm. Hyberg, Robert Kaestner. Secretary's Office, Fresno.

Santa Barbara Chapter:  
Miss Lulah Maria Riggs, President; Roy C. Wilson, Vice-President; Chester L. Carjolo, Secretary; Roy W. Cheesman, Treasurer. Corres. Secy.; Richard B. Nelson, 3033 Calle Rosales, Santa Barbara.

Southern California Chapter:  
Henry L. Wright, President; U. Floyd Rible, Vice-President; Carmelus M. Deasy, Secretary; Savio M. Stoshitch; Hugh R. Davies, S. Kenneth Johnson, Kemper Nomland and Chas. E. Fry, Directors.

Headquarters, 3723 Wilshire Blvd., Los Angeles 5.

Utah Chapter:  
W. J. Monroe, Jr., President, 433 Atlas Bldg., Salt Lake City; M. E. Harris, Jr., Secretary, 703 Newhouse Bldg., Salt Lake City.

Washington State Chapter:  
John S. Dettlie, President; Ralf E. Decker, 1st Vice-President; Edwin T. Turner, 2nd Vice-President; Wendell H. Lovett,

Secretary; Arnold G. Ganges, Treas. Directors Paul Thiry, William J. Bain, J. Emil Anderson and Robert B. Price. Dayis Holcomb, Ex-Sec., 409 Central Bldg., Seattle 4.

Spokane Chapter:  
B. K. Ruehl, President; Victor L. Wulff, 1st Vice-President; Philip Keene, 2nd Vice-President; Laurence G. Evans, Secretary, and Carroll Martell, Treasurer. Office 515 American Legion Bldg., Spokane, Washington.

Tacoma Society:  
E. N. Dugan, President; P. G. Ball, Vice-President; Lyle Swedberg, Secretary-Treasurer.

Hawaii Chapter:  
Kenji Onodera, President, 3518 McCarriston St., Honolulu, T. H.; George J. Wimberly, Secretary, 315 Royal Hawaiian Ave., Honolulu, T. H.

CALIFORNIA COUNCIL OF ARCHITECTS  
Charles E. Fry, President, Los Angeles; Malcolm D. Reynolds, Oakland, Vice-President; Lawrence Gentry, Los Altos, Secretary; Louis A. Dean, San Diego, Treasurer; Fred A. Chase, Executive Secretary, 3723-A Wilshire Blvd., Los Angeles.

CALIFORNIA STATE BOARD ARCHITECTURAL EXAMINERS:  
Earl T. Heitschmidt (Los Angeles), President; Geo. P. Simonds (Oakland), Secretary; Norman Blanchard (San Francisco); C. J. Paderewski (San Diego); Ullyses Floyd Rible (Los Angeles), Exec. Secy.; Robert K. Kelley, Room 712, 145 S. Spring St., Los Angeles; San Francisco Office, Room 300, 507 Polk Street.

**ALLIED ARCHITECTURAL ORGANIZATIONS**

San Francisco Architectural Club:  
Joseph Scora, President; Frank S. Gerner, Vice-President; Russell W. Pennell, Treasurer; Frank L. Barsotti, Secretary. Club Quarters: 507 Howard St., San Francisco.

Producers' Council—Southern California Chapter:  
Bert Taylor, President, Pittsburgh Plate Glass Company; G. Robert Roden, Jr., Vice-President, Truscon Steel Company; Malcolm G. Lowe, Secretary, Natural Gas Equipment Inc.; Richard Seaman, Treasurer, W. P. Fuller & Company; Vern Boggs, National Director, Gladding McBean & Co. Producers' Council—Northern California Chapter (See Special Page)

the Interpersonal Relationship of the Architect and the People with Whom He Comes in Contact."

Miss Dayis Holcomb, newly appointed Executive Secretary for the Chapter was introduced. Miss Holcomb will have charge of the offices opened at 409 Central Building, Seattle.

Officers selected to serve for the ensuing year, at the annual election were: John S. Dettlie, president; Ralf E. Decker, 1st vice-president; Edwin T. Turner, 2nd vice-president; Wendell H. Lovett, secretary; Arnold G. Ganges, treasurer, and Executive Board members included Paul Thiry, William J. Bain, J. Emil Anderson and Robert B. Price.

**HEITSCHMIDT REPRESENTS ARCHITECTS AT CONFERENCE**

Earl Heitschmidt, A.I.A., architect of Los Angeles, represented the architectural profession (west of the Mississippi) at a joint co-operative committee meeting of the Associated General Contractors and the American Institute of Architects held in Chicago this month.

The committee meeting was held just prior to the annual Associated General Contractors Convention, and taken under consideration were: modular co-ordination, insurance, AIA general conditions, contract forms and general items of the building industry.

**CALIFORNIA COUNCIL OF ARCHITECTS**

Among items coming before the annual convention of the California Council of Architects in San Diego on October 15-16-17, will be consideration of the reorganization of the Council office in Los Angeles.

Fred Chase, who has been serving as executive

secretary resigned his position, effective December 1, and a successor is to be named. Consideration of the functions of the executive secretary and possible expansion of the Council activities to include additional personnel, will also be taken under advisement at the annual meeting in Coronado.

Announced subjects of consideration at the an-

(See Page 34)



"Take it from me . . . concrete made with

**DAREX  
AEA**

*is more durable"*

DAREX AEA is the world's leading brand of air entraining agent. Contractors, engineers and ready-mix plants all over the world use DAREX AEA to make concrete that places easier and faster, is more homogenous, finishes better, has better surface texture, and is more durable when exposed to weathering, sulphate and sea water action.

Distributed By



**CONTACT THE NEAREST P.C.A. SALES OFFICE**  
SAN FRANCISCO OAKLAND SAN JOSE  
SACRAMENTO STOCKTON FRESNO

# WITH THE ENGINEERS

## Structural Engineers Association of California

John E. Rinne, President, San Francisco; Jack S. Barrish, Vice-President, Sacramento; Leslie W. Graham, Secretary-Treasurer, San Francisco. Directors John J. Gould, R. W. Binder, M. A. Ewing, Leslie W. Graham, Jack S. Barrish, Harold P. King, W. T. Wheeler, John E. Rinne and Donald F. Shugart. Secretary's office, c/o Associated Structural Engineers, 417 Market St., San Francisco 5.

## Structural Engineers Association of Northern California

George A. Sedgwick, President; Michael V. Preatoff, Vice-President; John M. Sardin, Secretary; William K. Cloud, Treasurer; Robert P. Moffett, Asst. Sec.-Treas.; Directors, Robert D. Dalton, Robert D. Dewell, William H. Ellison, John J. Gould and J. Albert Paquette. Offices: 417 Market St., San Francisco.

## Structural Engineers Association of Central California

William H. Peterson, President; Walter S. Wassum, Vice-President; O. T. Illerich, Sec.-Treas.; Ernest D. Francis, M. A. Ewing, and Arthur A. Sauer, directors. Office C. T. Illerich, c/o Div. of Arch., Sacramento.

## American Society of Civil Engineers Los Angeles Section

Trent R. Dames, President; Stephenson B. Barnes, Vice-President; John M. Server, Vice-President; C. Martin Duke, Secretary, and John Merrill, Jr., Treasurer. Office of Secretary, 3066 Engineering Building, University of California, Los Angeles 24. BRANCHES: Orange County Branch, Harold Sprenger, Pres; Raymond R. Ribal, V-P; Earl K. Burdick, Sec-Tr, 12311 Chapman, Anaheim. San Bernardino-Riverside Counties Branch, Albert A. Webb, Pres; Wright M. Price, V-P; John L. Merriam,

## FEMINEERS

"Fashions In Flight" was the theme of a Fashion Show held on September 16 in the San Francisco Elks Club, in conjunction with the regular monthly luncheon.

Millinery and Fur Fashions highlighted the event with Miss Carol M. Bigelow, Women's Representative of the United Airlines providing the commentary and background for the show. Furs were supplied by Roberts' Furs and the hats were furnished from the Francoise Modes new fall line.

Models included FEMINEERS, R. D. Dalton, E. D. Kahlert, G. R. Maurer, Eric Moorehead, William Moore, Fred Pavlow, Victor R. Sander and B. A. Vallerga. Musical background was furnished by Mrs. Harold B. Hammill. Arrangements for the event, which is held each year, was under the supervision of Mrs. John Fies.

## STRUCTURAL ENGINEERS ASSOCIATION OF NORTHERN CALIFORNIA

"Complexities of Soil Compaction" was the subject of an address by Francis N. Hveem, materials and research engineer for the California Division of Highways, Department of Public Works, at the September meeting held in the Hotel Claremont in Berkeley in joint meeting with the East Bay Structural Engineers Society. Hveem is considered an authority on bituminous pavements, soil conditions, and soil compactions having served in the California Division of Highways for more than 30 years.

Consideration was given to the annual Structural Engineers Convention, scheduled for October 8-9-10 at Yosemite, and early registration urged.

## AMERICAN SOCIETY OF CIVIL ENGINEERS

The highest distinction within the power of the Board of Directors of the American Society of

Civil Engineers, election to honorary membership in the Society, will be awarded to Othmar H. Ammann of New York, distinguished in long-span engineering; Dr. Arthur E. Morgan of Yellow Springs, Ohio; John C. Page of Denver, and Charles M. Spofford of the Massachusetts Institute of Technology.

The awards will be made at the Society's annual meeting in New York City on October 21st.

## SPECIAL COURSE OFFERED FOR SCHOOL INSPECTORS

A night school class is being offered in the fall term in Los Angeles for training of school building construction inspectors. The course is being prepared and sponsored by the Structural Engineers Association of Southern California, the American Institute of Architects, Mechanical and Electrical and other engineers and various trade organizations in cooperation with the California State Division of Architecture.

The purpose of the course, which will be given one night each week, is to assist present school construction inspectors in the performance of their duties, and also to qualify persons who desire to become school building construction inspectors. The California State Division of Architecture has indicated that persons receiving a satisfactory grade in this course may be certified to the State as qualified to become a school building construction inspector.

## STRUCTURAL ENGINEERS ASSOCIATION OF CALIFORNIA

Plans and preparations for the annual Convention, scheduled for the Ahwahnee Hotel in Yosemite Park on October 8-9-10, are nearing the completion stage, according to Ted Newman, general convention chairman.

A diversified program of technical subjects presented by national and internationally known

Sec-Tr; 4865 Park Ave., Riverside, Ventura-Santa Barbara Counties Branch, Robert L. Ryan, Pres; Richard E. Burnett, V-P; George Conchey, Sec-Tr, 649 Doris St., Oxnard.

**American Society of C. E.  
San Francisco Section**

J. G. Wright, President; J. E. Rinne, Vice-President; Howard C. Wood, Vice-President; John S. Longwell, Past President; H. C. Medbery, Secretary, and Richard C. Clark, Treasurer. Office Secretary, S. F. Water Dept., Millbrae.

**Structural Engineers Association of  
Southern California**

Ben Benioff, President; William T. Wright, Vice-President; Charles M. Corbit, Jr., Sec-Treas. Directors: Ben Benioff, William T. Wright, Harold P. King, Henry M. Layne, Joseph Sheffet, Robert J. Kadow and Harold Omsted. Offices, 121 S. Alvarado St., Los Angeles 4.

**Structural Engineers Association of  
Oregon**

Lewis R. Ellingwood, President; Robert M. Bonney, Vice-President; Sully A. Ross, Secretary-Treasurer. Directors William J. Dornier, Roger V. Gillam, Leslie E.

Poole, Rowland S. Rosé. Offices 706 Board of Trade Bldg., 310 S.W. 4th Ave., Portland 4.

**Society of American Military  
Puget Sound Engineering Council  
(Washington)**

R. E. Kister, A. I. E. E., Chairman; E. R. McMillan, A. S. C. E., Vice Chairman; L. B. Cooper, A. S. M. E., Secretary; A. E. Nickerson, I. E. S., Treasurer. Offices, L. B. Cooper, c/o University of Washington, Seattle 5, Washington.

**American Society Testing Materials  
Northern California District**

L. A. O'Leary, Chairman; P. V. Garin, Vice-chairman; H. P. Hoopes, Sec. Office Sec., 1550 Powell St., Emeryville, Calif.

**Society of American Military  
Engineers—San Francisco Post**

CDR N. M. Martinsen, President; L. L. Wise, 1st Vice-President; Col. Paul Berrigan, 2nd Vice-President; R. M. Hamilton, Secretary; Thomas Hurley, Treasurer. Directors, RADM C. A. Trexel, J. G. Wright, LTCOL C. S. Lindsey, C. E. Bentley, F. R. Fowler, BRIGEN D. F. Johns, and RADM L. N. Moeller.

speakers; round table discussions, and a varied program of entertainment is being provided for those attending this year's conference. Limited accommodations at the Ahwahnee Hotel is a suggestion that reservations should be sent in without delay, send to Ted Newman, 306 Sharon Bldg., San Francisco.

**STRUCTURAL ENGINEERS ASSOCIATION  
SOUTHERN CALIFORNIA**

"Building Accelerations Produced by Strong Ground Motion" was the subject of an address by Dr. George W. Housner, Professor of Civil Engineering and Applied Mechanics at the California Institute of Technology at the September meeting held in the Rodger Young Auditorium in Los Angeles.

Dr. Housner recently completed extensive research on the subject and related results to observe damage resulting from recent earthquakes. The study was conducted by detonating large charges of explosives adjacent to the structures under considerations and then recording actual accelerations. The results were very interesting and informative.

New Members: Norman Barsh and William E. Heller, Members. Hugh Brooks, Jr., Ralph J. D'Agostino, Milton R. Emerson, and Tom T. Kamei, Junior Members. Associate Members, Horace M. Hansen and Robert K. Williams.

**PAUL JEFFERS MEMORIAL  
SCHOLARSHIP ANNOUNCED**

A Paul Jeffers Memorial Scholarship is being established by the Structural Engineers Association of Southern California, honoring one of the founders of the Association and its first president.

The award will be made annually to an out-

standing student in Civil and Structural Engineering.

Jeffers at the time of his death was President of the California State Board of Registration for Civil and Professional Engineers. He was responsible for much of the structural design in many prominent buildings throughout Southern California.

**SCHOOL TRUSTEE REQUESTS  
EMPLOYMENT LOCAL ARCHITECT**

Taking the position that public school officials should set an example in following the principles of free enterprise, Robert M. Jackson, a trustee of the Redwood City (California) Elementary School District, contends the services of an architect residing in the district should be retained, rather than employing a full time architect by the district.

Considerable expansion of educational facilities in the form of new school buildings and remodeling, is anticipated by the District to keep pace with the rapid residential growth of the community, and in connection with such a program, Jackson points out the district will actually save money by employing the services of a local architectural firm on a fee basis, rather than putting an architect on the districts pay-roll.

In a recent communication to the superintendent of the Redwood City schools, Jackson pointed out "I think it is far better for our tax-payers to have our architectural services rendered by a private company rather than open ourselves to more 'State control.'" Governmental trends, as evidenced by the 83rd Congress, is towards getting Government out of business rather than increasing competition with private enterprise, the communication concluded.



# PRODUCER'S COUNCIL PAGE

The National Organization of Manufacturers of Quality Building Materials and Equipment  
(Northern California Chapter) affiliated with THE AMERICAN INSTITUTE OF ARCHITECTS

President, Roly MacNichol  
Libbey-Owens-Ford Glass Co.  
Rialto Bldg.

Vice-President, Ted Bakeman  
F. W. Wakefield Brass Co.  
445 Bryant Street

Secretary, John Cowley  
Hamilton Manufacturing Co.  
2833 3rd Street

Treasurer, Carl Frank  
Detroit Steel Products Co.  
Russ Building

Edited by Stanley L. Basterash, WESTERN ASBESTOS COMPANY.

## Annual Convention California Council of Architects

The annual convention of the California Council of Architects is to be held on October 14th, 15th and 16th at the Hotel Del Coronado in Coronado, California. The convention as usual, is jointly sponsored by the California Council of Architects and the Los Angeles and San Francisco Chapters of the Producers Council, Inc. As a background, this convention is held in the South one year and in the North the next, with applicable chapter of the Producer's Council taking over the required committee duties according to the location of the convention. This year as in the past the Los Angeles chapter is furnishing the committeemen with only one representative on each committee from the San Francisco Chapter. Primarily, the Producer's Council is responsible for handling the sports activities at the convention and, accordingly, the Los Angeles committees have been hard at work on this program. We understand the prizes for winners are quite select.

It goes without saying, that every member on the Producer's Council who finds it possible to attend this convention, will find it a wonderful opportunity to enjoy the fellowship that exists between members of the two organizations.

USE QUALITY PRODUCTS



CONSULT AN ARCHITECT

#### ARCHITECT SELECTED

Lawrence W. Gentry, AIA, architect of Los Gatos, has been commissioned by the Sunnyvale Elementary School District, Santa Clara County, to design plans and specifications for the construction of the new Cherry Chase Elementary School to be built in Sunnyvale.

The new school will comprise 6 classrooms, administration facilities, and toilet rooms and will be of frame and stucco construction.

#### MURRAY MERRIN MADE GENERAL MANAGER

Murray Merrin, Chairman of the Employment Committee of the Structural Engineers Association of Southern California, and prominent southland engineer, has been appointed general manager of the Sierra Steel & Fabricating Company.

Manufacturing plant of the firm is located in Gardena.

#### ARCHITECT MOVES OFFICE

Architect Henry V. Chescoe of San Francisco, has announced opening of new offices for the practice of architecture at 121 Beale Street, San Francisco 5.

Formerly located at Market and Third streets, the new offices are larger and much more complete.

#### NEW ENGINEERING FIRM ORGANIZED

S. K. Johnson, partner of Daniel, Mann, Johnson & Mendenhall, Los Angeles architectural and engineering firm, has announced the formation of the DMJM Engineering Company. The parent firm has been extensively engaged in engineering projects in this country and abroad for the past several years, and organization of the new civil engineering section will better serve the firm's clients.

#### DOANE APPOINTED SALES ASSISTANT

John E. Doane has been named assistant sales manager of the Calaveras Cement Company, according to an announcement by W. W. Mein, Jr., president.

He will continue to serve as traffic manager of the firm and will add his new duties in the sales department under Mel J. London, vice president and general sales manager.

#### COLLEGE NAMES ARCHITECTS

The architectural firm of Pereira & Luckman of Los Angeles has been named by the Regents of the University of California as the executive architects for the new music building to be constructed on the future campus of Santa Barbara College at Goleta.

Cost of the new music building is \$566,000 and it will have an estimated area of 29,600 sq. ft.

#### SUPERVISORS APPROVE MASTER IMPROVEMENTS

The Los Angeles County Board of Supervisors has approved a master zone plan for the community of Palmdale in accordance with a program advocated by the Palmdale Chamber of Commerce.

The plan calls for 211 acres for commercial purposes, 180 acres for manufacturing development, 6746 acres for single-family residential expansion and approxi-

mately 19,000 acres for agricultural uses.

It is one of the largest single package zoning plans ever processed by the Regional Planning Commission of Los Angeles.

#### ARCHITECT SELECTED

Architect Jack Buchter of Orinda has been commissioned by the Orinda Elementary School District board to draw plans and specifications for the construction of a new Elementary School in Orinda.

The new facilities will be occupied by the 7th and 8th grade students.

#### BAKERSFIELD CHURCH

Architect Whitney Biggar of Bakersfield is completing plans and specifications for the construction of a new First Congregational Church building to be built in Bakersfield.

The building will be of masonry with wood roof, concrete floor, radiant heat, laminated wood arches and will comprise

a sanctuary, offices, Sunday school, social hall and kitchen. Estimated cost is \$200,000.

#### NAMED GENERAL SUPERINTENDENT

Jack Ogden has been appointed general superintendent of the Ford J. Twaits Company, general contractors and engineers with main offices in Los Angeles, according to an announcement by company officials.

Ogden has been job superintendent of the Police Facilities Building now under construction in Los Angeles by Ford J. Twaits Co., and Morrison-Knudsen Co., Inc.

#### ENGINEERING FIRM EXPANDS

The Conley Engineering Company, general civil engineering consultants, have opened new offices at 1248 S. La Cienega Blvd., Los Angeles, according to a recent announcement.

**ARCHITECTURAL  
PORCELAIN  
BY  
CAMEO  
SINCE 1911**

Dramatic-design, customer-attracting store fronts with Cameo architectural porcelain enamel. Available in countless colors and textures that never need refinishing, and in practically any shape or size. It is lightweight, fire and weather resistant and easily constructed. For complete engineering specifications, write or call today.

ARCHITECTURAL  
DIVISION



**CALIFORNIA Metal Enameling COMPANY**  
6904 E. SLAUSON AVE., LOS ANGELES 22, CALIFORNIA • UNderhill 0-1268

# PERSONALITIES

## FRANCIS JOSEPH McCARTHY Architect, A.I.A.

San Francisco, California

Both father and mother of architect Francis Joseph McCarthy were born in Virginia City, Nevada, so he is another Westerner by inheritance



FRANCIS JOSEPH McCARTHY  
Architect, A.I.A.

and birth as he actually first saw the light of day in Sidney, N.S.W., Australia where his parents had moved in order that McCarthy senior could practice his profession of mining engineer.

Aside from globe-trotting in his early youth, McCarthy's boyhood was spent in the mining camps of Nevada, Arizona, and California, and it was while attending a University of Arizona extension School class and seeing the instructor

draw plans for a house that he determined to become an architect.

After graduation from the San Juan High School at Fair Oaks, California, and attendance at Stanford University, McCarthy worked in various architectural offices obtaining his major training with Charles F. Dean in Sacramento, and William Wilson Wurster in San Francisco, augmented with study at the California School of Fine Arts in San Francisco.

McCarthy opened his own architectural offices in 1939 and immediately designed a number of houses and was associated in the designing of the Czecho-Slovakian Exhibit at the Golden Gate Exposition. With the outbreak of World War II, he became associated with James Wickenden and Theodore Bernardi in doing public housing work in San Luis Obispo county.

In 1944 he went to Brazil to work on U. S. Government projects, returning to San Francisco in 1945 to again become associated in war housing projects with J. Francis Ward. In 1949 an association was made with Donald Forbes, interior and furniture designer and a great many projects have since cleared the office.

McCarthy says and believes "architects are specialists in design and construction—not in building types for, once the problem has been stated and properly analysed, the only problem is the resulting design and construction."

His non-office activities include many civic efforts, and participation in A.I.A. on a local, state and national level.

NEXT MONTH: Russell Mills, A.I.A., Reno, Nevada.

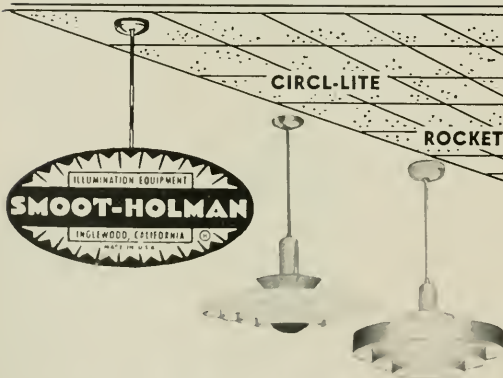

at the head of the class



• CLASSROOM • AUDITORIUM  
• OFFICES • CAFETERIA

## McDONALD BROS., CONSTRUCTORS ADD DESIGN-ENGINEERING DEPT.

Lloyd McDonald, partner of McDonald Brothers, Los Angeles construction firm, announces the addition of a design and engineering department which will be an integral part of their present construction



Drakes Tavern  
Sir Francis Drake  
Hotel  
San Francisco  
Gardner Dailey  
Architect

Manufactured and  
Installed by

## THE FINK & SCHINDLER CO.

Since 1882

552 Brannan Street San Francisco, Calif. EXbrook 2-1513



service.

The new department is the most recent of a series of expansion moves by McDonald Brothers to keep pace with the industrial growth of the West.

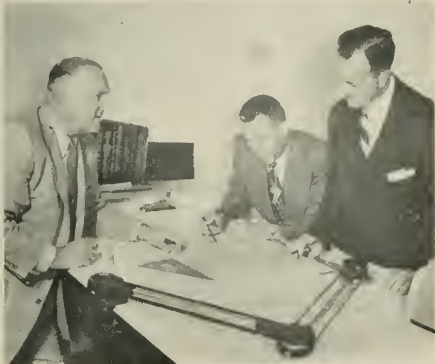

Lloyd McDonald (right) partner McDonald Brothers Construction firm discussing expansion plans on the new Design and Engineering Department with Russell D. Koons (center) and George S. Ballew.

Russell D. Koons, formerly with the Bechtel organization for eleven years, will head the new department. He has had more than sixteen years experience in engineering and construction of major projects, including oil refineries, shipyards, industrial and chemical plants.

George S. Ballew, formerly with Stone & Webster Engineering Corp., well known specialist in petroleum process design, will manage McDonald's service department for the petroleum industry.

### CONGRESS APPROPRIATES FUNDS FOR ARMY ENGINEERS CIVIL WORKS

Congress appropriated some \$421,686,600 for the Civil Works functions of the Corps of Engineers in Fiscal Year 1954, according to an announcement by Major General Samuel D. Sturgis, Jr., Chief of Engineers.

The funds, included in the Department of the Army Civil Functions Appropriation Bill signed by the President on July 27, 1953, are allocated to construction, maintenance, planning projects and survey reports in the Congressionally authorized flood control and river and harbor improvement programs assigned to the Army Engineers.

Of the total appropriation for the year, the general construction program receives the major share, \$276,770,000. Amounts have been specified for 81 individual construction projects in 35 states, as well as for three items in various states: emergency bank protection, snagging and clearing, and local protection projects. Construction in the



## Summerbell for SCHOOLS

Elementary School, Santa Paula, California.  
Architect, R. S. Raymond.  
Structural Engineer, R. J. Volante.  
General Contractors, Barringer & Balke.  
Note clerestory windows made possible by "lowloath" design.

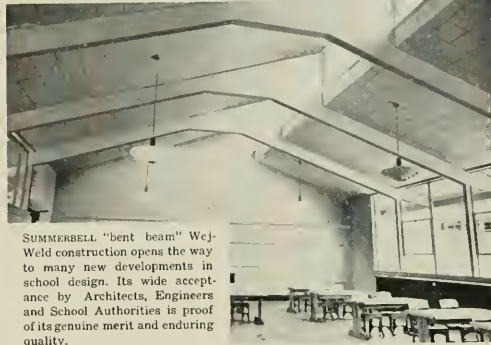

SUMMERBELL "bent beam" Wej-Weld construction opens the way to many new developments in school design. Its wide acceptance by Architects, Engineers and School Authorities is proof of its genuine merit and enduring quality.

Glued Laminated Construction • Summerbell Bowstring Trusses  
Lomella Roofs & All Types of Timber Structures

For quality, economy and satisfaction, specify **SUMMERBELL**

### Summerbell ROOF STRUCTURES

825 EAST 29TH STREET • BOX 218, STATION "K" • LOS ANGELES 11



## RAMUC MASONRY

years more protection  
for less cost!



RAMUC Masonry Paint is a water-proof, natural rubber base coating that protects stucco, concrete and unglazed surfaces for years . . . average 2 to 5 years longer than other masonry paints. This maximum protection means lower painting cost. Does not crack, peel or chip. Is not affected by lime or moisture. Resists deterioration by heat and cold. Color bases are non-fading titanium pigments. RAMUC is easily cleaned . . . no streaks or dinginess. RAMUC Masonry Paint is available in nine pleasing, satin finish colors.

*This beautiful apartment house at 1908 Vallejo Street, San Francisco, was painted in 1946 with Peab RAMUC Masonry Paint. Still in excellent condition, the paint job is good for years more of beauty and protection for the owners.*

Write today for descriptive, specification details on RAMUC's outstanding protection that costs less.

Write Dept. A.E.

An **Inertol** Product

## INERTOL CO. INC.

27 SOUTH PARK • SAN FRANCISCO 7



**DISTINCTIVE! COMMANDING! SYMBOLIC!**

Such are the comments on this striking architectural expression, so perfectly executed in

**PORCELAIN ENAMEL VENEER**

... the perfect facing material, inside and out, for any building. Resistant to fire, weather and wear.

- Borondon Co., Designers
- Kemp Bros., General Contractors
- Herbert Hamm, Engineer

**Write today for details!**

Investigate Porcelain Enamel Panels for curtain walls in essential building construction.

*Architectural Division*

**PORCELAIN ENAMEL PUBLICITY BUREAU**  
 ROOM 601, FRANKLIN BUILDING, OAKLAND 12, CALIFORNIA  
 P. O. BOX 186, EAST PASADENA STATION, PASADENA 8, CALIFORNIA

*The finest achievement of 50 years of  
 Oil Heating Engineering!*

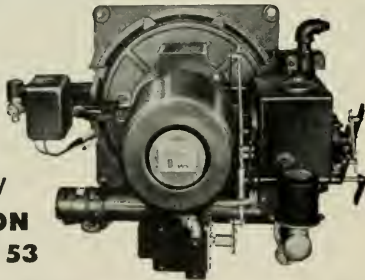

**The NEW  
 JOHNSON  
 Model 53**

**fully automatic Metering Pump Burner**

This revolutionary new Johnson Burner will automatically maintain a fixed Air-Fuel Ratio regardless of variations in oil temperature and viscosity. That's News . . . big News, to Oil Heating Engineers for it means the virtual elimination of the "Cold Starts" problem. The key to this phenomenal performance lies in a new positive-displacement metering pump developed on time-tested principles by Johnson engineers. The Model 53 is available in seven sizes, from 25HP to 400HP. It is basically simple in design, easy to service, and exceptionally efficient in heating performance.



Make it a point to investigate this newest addition to the Johnson Burner line-up that provides—"a Burner for Every Heating Need".

**S. T. JOHNSON CO.**  
 940 ARLINGTON AVE. CHURCH ROAD  
 OAKLAND 8, CALIF. BRIDGEPORT, PA.

amount of \$13,500,000 is to be accomplished from surplus funds. The appropriation for advance engineering and design was \$1,900,000, and the operation and maintenance allocation was \$79,000,000.

Construction funds allocated by basins include: Columbia River Basin (including Coastal streams) \$110,345,000; Gulf Coast and New Mexico and Texas streams, \$26,301,000; Sacramento-San Joaquin River Basins, \$16,000,000; and South Pacific Coastal Streams and Arizona and Utah streams, \$13,350,000.

Among the large projects included were: The Dalles Lock and Dam in Oregon and Washington, \$32,000,000; McNary Lock and Dam, Oregon and Washington, \$26,350,000; Chief Joseph Dam, Washington, \$23,350,000; Lookout Point Reservoir, Oregon, \$18,000,000; Folsom Reservoir, California, \$8,800,000; Albeni Falls Reservoir, Idaho, \$6,840,000, and the Los Angeles County Drainage area of California, \$6,200,000.

**APPOINTED ENGINEER FOR  
 PANAMA LAMPS COMPANY**

Mandle J. Mierbach, E.E., has been appointed Engineer for Panama Lamps and Commercial Co., Inc. of San Francisco, according to an announcement by Guy de Leuze, president of the firm.



**MANDLE J. MIERBACH**  
 Engineer

In his new work, Mierbach will direct an extensive lighting program for the marketing of fluorescent tube and incandescent lamps, residential fixtures, luvertile illuminated ceilings and other products distributed on the West Coast by Panama Lamps.

Mierbach has had sixteen years experience in industrial, commercial and military applications of electrical engineering and received additional training in post-graduate work at Harvard University and at Massachusetts Institute of Technology. He was a director of the California Society of Professional Engineers, Bay Area Chapter, and is a member of the American Institute of Electrical Engineers and the Illuminating Engineering Society.

**A.I.A. ACTIVITIES**

(From Page 27)

nual Convention include: Public Relations, panel discussions with nationally prominent speakers, educational exhibits, tours of the area (including Tia Juana, Mexico), and many social functions.

#### **SAN DIEGO CHAPTER**

A motion picture sponsored by the La Jolla Camera Club featuring "The City", "Crises in Iran", and "Does It Matter What You Think" featured the regular September meeting. The program was arranged by Bob Mosher and Lloyd Ruocco.

Considerable attention was given to the October meeting of the California Council of Architects which will be held at the Hotel Coronado in Coronado, with the San Diego Chapter serving as the "host" group.

#### **NORTHERN CALIFORNIA CHAPTER**

Redevelopment of the San Francisco Civic Center Plan won a major test recently when the Board of Supervisors appointed a special committee to handle the problem. The project is being keenly watched with Chapter members headed by Donn Emmons, president, taking a very active part in conferences with City officials and members of the Planning Commission.

#### **SOUTHERN CALIFORNIA CHAPTER**

The September meeting was the annual joint outing of the architects with members of the Producers Council with the event being held at the Anoakia Estate in Baldwin. Horseshoes, baseball, swimming and other recreational activities featured the day's outing. Fred Smith served as general chairman of the event.

#### **OREGON STATE CHAPTER**

As a good preliminary to a full fall and winter activity, members are urged to attend the Sun Valley Regional Convention on October 9-10-11.

#### **WOODWORK INSTITUTE OF CALIFORNIA**

The Manual of Millwork, released to architects early this year, has met with an enthusiastic response and many requests for additional information which the Technical Committee of the Institute is giving careful consideration.

Sherman S. Karns, Chairman of the Technical Committee reports that the initial portion of an "addendum" to the Manual is in preparation and will soon be ready for distribution. It includes a 3" scale drawing of various stock windows and door frames. Full size sections of stock sash and door stickings will also be included. The material will cover details of special applications of frames and sash most frequently required in modern school and commercial construction.

Karns declared "The Woodwork Institute of California is endeavoring to make their Manual of Millwork the most complete reference in the millwork field, and welcomes suggestions from architects as to their further requirements."

## **Parker, Steffens & Pearce**

**BUILDERS**

**135 South Park, San Francisco**

**Phone: EXbrook 2-4832**

## **FORDERER CORNICE WORKS**

*Manufacturers of*

Hollow Metal Products • Interior Metal Trim  
Elevator Fronts and Cabs  
Metal Plaster Accessories • Sanitary Metal Base  
Flat and Roll Metal Screens  
Metal Cabinets • Commercial Refrigerators

**269 POTRERO AVE.**

**SAN FRANCISCO, CALIF.**

**HEMLOCK 1-4100**

## **BARRETT & HILP**

**CONTRACTORS**

*Serving The Construction Field  
Since 1912*

**OUR FORTIETH YEAR**

**918 Harrison Street • San Francisco  
Telephone DOuglas 2-0700**

## **J. BETTANCOURT**

**GENERAL CONTRACTOR AND  
BUILDER**

**1015 SAN MATEO AVENUE  
SAN BRUNO, CALIFORNIA**

**Phone: JUno 8-7525**



## JUDSON PACIFIC-MURPHY CORP.

*Steel Fabricators  
and  
Erectors*

**REINFORCING STEEL  
STRUCTURAL STEEL  
BRIDGE CRANES**

4300 EASTSHORE HWY.  
EMERYVILLE, CALIF.

Phone:  
OL 3-1717

## CLINTON CONSTRUCTION CO. OF CALIFORNIA

*General Contractors*

923 FOLSOM STREET • SAN FRANCISCO

SUtter 1-3440

## HOGAN LUMBER CO.

*Wholesale and Retail*

**LUMBER**

**MILL WORK • SASH & DOORS**

*Office, Mill, Yard and Docks*  
SECOND AND ALICE STREETS • OAKLAND, CALIF.

Telephone GLencourt 1-6861

## HAAS and HAYNIE

Formerly Haas Construction Company

Since 1898

275 PINE ST.

SAN FRANCISCO, CALIF.

Phone DOuglas 2-0678

## BOOK REVIEWS PAMPHLETS AND CATALOGUES

**ARCHITECTURAL DETAILING.** By Caleb Hornbostel and Elmer A. Bennett. Reinhold Publishing Corp., 330 W. 42nd St., New York 36. Price \$12.00.

This book represents an annotated, cross-indexed, and organized collection of 165 of the selected architectural details that have for many years been the most popular feature of *Progressive Architecture*.

The drawings are the work of Elmer Bennett, many years experience with leading Boston and New York architectural offices and free-lance illustrator to technical and consumer magazines, teacher, and for the past seven years on the staff of *Progressive Architecture*.

The book is organized for easy reference into two parts. First, a collection of details inherent to particular building types; Second, details inherent to many types of buildings.

Introduction by Caleb Hornbostel, a practicing architect, teacher, and writer on architectural subjects. A philosophical introduction has been prepared by Richard J. Neutra.

**PLASTERING.** By Felicien Van Den Branden and Mark Knowles. American Technical Society, 848 E. 58th St., Chicago 37. Price \$4.90.

Plastering Skill and Practice is written to initiate the novice and up-to-date the journeyman in the techniques, both new and old, of the plastering trade.

Methods recommended by the authors to meet varying means are those which have earned recognition as the best by virtue of two tests: 1) economy of time in labor, and 2) quality of the results. Likewise, trade terms vary among different sections of the country, but the basic practices are everywhere the same.

The book abounds in photographs and illustrations.

**HEATING, VENTILATING, AIR CONDITIONING GUIDE—1953.**

The American Society of Heating and Ventilating Engineers, 62 Worth St., New York 13. Price \$7.50.

This book is an instrument of service prepared for the profession and contains a Technical Data Section—reference material on the design and specification of heating, ventilating and air conditioning systems, based upon the "transactions," "investigations" of the Research Laboratory and cooperating Institutions, and the practice of the Members and friends of the Society; A Manufacturers' Catalog Data Section—containing essential and reliable information concerning modern equipment; and Complete Indexes to Technical and Catalog Data Sections.

It contains 1096 pages in the technical data section and 427 pages in the catalog data section. It is the 31st edition of The Guide.

## NEW CATALOGUES AVAILABLE

*Architects, Engineers, Contractors, Planning Commission members—the catalogues, folders, new building products material, etc., described below may be obtained by directing your request to the name and address given in each item.*

**Powder Exhausters.** A new Bulletin 53-B (AIA File #30-D-1) gives illustrations, drawings and charts on installation, types, and sizes of wall and roof exhausters. Includes typical specifications form and schedule of recommended air changes for auditoriums, banquet halls, boiler rooms, churches, kitchens, laboratories, and other industrial and commercial buildings. Copies available by writing Dept. A&E, Jenn-Air Products Co., Inc., Architects & Builders Bldg., Indianapolis 4, Indiana.

**Fire Hose Racks, cabinets, accessories.** 1953 edition of catalog on fire protection equipment, including patented fire hose racks; spring clip nozzle holders, and accessories. Illustrated; charts give dimensions and hose capacities, hose reels, saddle racks and cabinets. Copies of Bulletin 27F AM are available from Dept. A&E, The American Rubber Mfg. Co., 1145 Park Ave., Oakland 8, California.

**Powder-actuated fasteners.** Complete applications manual for use with powder actuated fastening system; compiled from thousands of field reports, includes many photographs and cutaway sketches to show precisely how powder actuated tools and fasteners are best employed in various installations in building, construction and maintenance fields as well as

marine, electrical, air conditioning, plumbing masonry and many other crafts. Lists specifications on more than 20 fixtures and accessories, drive pins and threaded studs which comprise the Ramset powder-actuated fastening system. Copies available, write Dept. A&E, Ramset Fasteners, Inc., 12117 Brea Road, Cleveland 11, Ohio.

**Oil burners.** New colored Catalog containing many illustrations of types and installations; charts showing types, features, and electrical characteristics. Specifications and capacities. A condensed, handy Catalog available by writing Dept. A&E, Ray Oil Burner Co., 401-499 Bernal Ave., San Francisco 12, Calif.

**Boiler-Burner unit.** A new catalog on oil, gas or oil and gas combination Boiler Burner unit, gives descriptive details; output rating chart; cutaway drawing indicating all basic components; charts showing ratings, performance data and dimensions; and discussion of various elements in the burner system. Copies of this bulletin B-3133, AIA File No. 34-B-1, may be obtained by writing Dept. A&E, Iron Fireman Manufacturing Co., 3170 W. 106th St., Cleveland 11, Ohio.

**Pre-Cast Uni-Bond Composition Sleepers.** Material is now available on the subject of Pre-Cast Uni-Bond Composition Sleepers (AIA File No. 23-D) including history, specifications, photographs of installations, drawings and other detailed data. Copies available by writing Dept. A&E, LeRoy Olsen Company, 3070 17th Street, San Francisco 10, Calif.

**All purpose pump.** Three color brochure illustrates details of construction with cross illustration of the new 109 all-purpose Kenca, multi-purpose sump pump and switch. Working principles of pump and switch operation are detailed in a series of drawings, showing each phase of operating control. An improved liquid level control switch for greater simplicity and longer life. Copies of Circular No. 12, obtainable by writing Dept. A&E, Kenco Inc., 1125 N. Ridge Road, Lorain, Ohio.

**Baseboard radiators.** A 12-page brochure describes and illustrates a new line of baseboard heaters. Complete information is furnished on the unique features, including uniform heating 50% by radiation and 50% by convection, three extra large water-ways holding 1.1 quarts of hot water per linear foot, welded steel construction. Details also included in "How To Figure The System" along with approved table of IBR capacities; typical baseboard layouts for different types of homes; typical piping layouts; roughing-in dimensions; and detailed, step-by-step instructions for installing baseboards for recessed or standard mounting. Copies available by writing Dept. A&E, Waterfilm Boilers, Inc., 36-40 New York Avenue, Jersey City 7, N. J.

**Cook On Your Refrigerator.** New Catalog containing numerous photographs, rough-in dimensions, and specifications of the General's new "Budget Priced Refrigerators" which incorporates a cooking unit on the top of the refrigerator. Describes uses and various installation possibilities in the home, factory, hospital, office, apartment, and resorts. Copies are available by writing Dept. A&E, General Air Conditioning Corp., 4542 E. Dunham St., Los Angeles 23, Calif.

**Luminous ceilings.** New catalog (AIA File 31F290 and AIA 31F21 for Lighting and Equipment; and AIA File 39B1 for Acoustics) describes entirely new development in illumination and ceiling treatment to solve the problem of glare, noise and unsightly ceiling construction. Copies of catalog are available by writing Dept. A&E, Luminous Ceilings Inc., 2500 W. North Ave., Chicago 47, Ill.

**Filing negatives and transparencies.** Based on the premise that effective negative filing systems must not only provide for the secure storage of the negatives and transparencies but must also be arranged so that desired films can be readily found, a leaflet "Filing Negatives and Transparencies" outlines tested methods of classifying, identifying, and storing photographic negatives and sheet film transparencies. Contains 20 pages, liberally illustrated with photographs of all important points. Copies available by writing Dept. A&E, Sales Service Division, Eastman Kodak Co., Rochester 4, New York.

**World's smallest complete kitchen.** If you are designing for building, remodeling, you will be interested in complete information and specifications on a complete kitchen unit that will save money and can be installed in a 5.4 sq. ft. space; comprises sink, burners, refrigerator, freezer and storage drawer in one compact unit. For complete data write DEPT-A, General Chef, 4536 E. Dunham St., Los Angeles 23, California.

## "AMERICAN - MARSH"

CONDENSATION UNIT

Pumping  
Machinery  
for  
Every  
Purpose

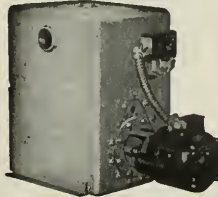

For Service  
Call  
DOuglas  
2-6794  
or  
MUtual 8322

**SIMONDS MACHINERY CO.**  
SAN FRANCISCO 816 FOLSOM  
LOS ANGELES 455 EAST 4TH

## VERMONT MARBLE COMPANY

DOMESTIC AND IMPORTED MARBLES  
GRANITE VENEER

525 MARKET STREET • SAN FRANCISCO 5

Phone: SUtter 1-6747

3522 COUNCIL STREET • LOS ANGELES 4

Phone: DUUnkirk 2-7834

*The Most Complete Line of*  
**STEELS and STEEL BUILDING MATERIALS**  
*Made by a Single Producer*



*See Sweet's Catalog File or write us for full information.*

**REPUBLIC STEEL CORPORATION**

GENERAL OFFICES: CLEVELAND, OHIO

DENVER, COLORADO . . . CONTINENTAL OIL BUILDING  
LOS ANGELES, CALIF. . . GENERAL PETROLEUM BUILDING  
SAN FRANCISCO, CALIFORNIA . . . RIALTO BUILDING  
SEATTLE, WASH. . . . . WHITE-HENRY-STUART BUILDING

## PACIFIC MANUFACTURING CO.

*High Class Interior Finish Quality  
Millwork*

16 Beale St., San Francisco  
GARfield 1-7755

2215 El Camino Real, Santa Mateo  
S. M. 5-0687

304 Bryant Street, Palo Alto  
P. A. 3373

2610 The Alameda, Santa Clara  
S. C. 607 (Factory)

6820 McKinley Avenue, Los Angeles  
THarnwall 4196

MAIN OFFICE — SANTA CLARA

## JET AIRCRAFT AIRPORT

(From Page 23)

design, and the Australian designers believe it could be the forerunner of an airport system to be adopted internationally.

If reports from overseas aviation authorities confirm the optimism of the designers, the Australian Department of Civil Aviation will seek approval to go ahead with detailed designs for airports at two Australian capital cities.

In the light of prospective airport requirements, it now seems likely that delays in carrying out some airport building projects planned after the war will prove a blessing in disguise.

The Director of Airports in the Department, Mr. A. Hepburn, said that most of the money spent since the war in airports in Australia have gone into new runways, extension of existing runways and strips, and establishing of new aerodromes.

Large scale housing schemes had absorbed building materials, and airport plans had been affected by State Government restrictions on use of materials.

The Department of Civil Aviation had not been unduly worried, as it took the view that the later the permanent buildings were built, the more likely

they were to meet the requirements of the latest types of aircraft.

"The result is that while our aerodromes are reasonably satisfactory, the building side is below our requirements," said Mr. Hepburn.

(To be concluded next month)

## LOS ANGELES ARCHITECT ASSISTS NEW ORLEANS

Henry L. Wright, Los Angeles architect, has been chosen by the New Orleans parish schools to act as advisor and consultant on their new 20-year building program, it has been announced.

Wright is president of the Southern California Chapter of The American Institute of Architects, and his firm of Kistner, Wright & Wright has designed some of California's most noted school structures.

## PAPER MANUFACTURING PLANT

(From Page 10)

of the owner, has designed the combination boiler-incinerator, served by one stack, to successfully utilize incinerator heat in the boiler. Complex process piping and jacketed lines carried on an overhead pipe structure span the 90 ft. distance between the Boiler House and Main Building. Two 10,000 gallon asphalt storage tanks are adjacent to the boiler house.

Extensive lawn areas, ground cover, shrubbery and trees as designed by Landscape Architects, Osmundson and Staley, enhance the entrance facade and public parking area.

The plant, now in production, is pronounced by its owners as admirably fulfilling their functional, appearance and economic requirements. It stands as documentary evidence that the combined efforts of Architects and Engineers can produce a handsome and economical industrial building.

Total construction cost, including all mechanical work, process piping, site development work, and landscaping	.....\$558,000
Total Floor Area	..... 37,400 sq. ft.
Total Cubage	.....598,600 cu. ft.
Building Cost per sq. ft.	..... \$10.00 per sq. ft.
Building Cost per cu. ft.	..... \$ 0.62 per cu. ft.
Structural Steel, 174 tons @ \$318 per ton	..... \$56,000
Structural Steel (pounds per sq. ft.)	..... 9.31 lbs. per sq. ft.
Structural Steel (pounds per cu. ft.)	..... 9.58 lbs. per cu. ft.
Total Concrete	..... 1350 cu. yds.
Miscellaneous Steel (25 tons @ \$6.00 per ton)	..... \$15,000
Miscellaneous Steel (Lbs. per sq. ft.)	..... 1.34 lbs. per sq. ft.

HOLLYWOOD JUNIOR

COMBINATION  
SCREEN and METAL SASH DOOR

★  
The "WEATHER-WISE"  
DOOR!!

A VENTILATING SCREEN DOOR  
A SASH DOOR  
A PERMANENT OUTSIDE DOOR  
**ALL 3 IN 1!**

Discriminating home owners and architects have chosen Hollywood Junior as the TRIPLE DOOR VALUE in the COMBINATION SCREEN and METAL SASH DOOR field! A sturdy dependable door, constructed of quality materials, HOLLYWOOD JUNIOR'S EXCLUSIVE PATENTED FEATURES have outmoded old-fashioned screen doors and other doors of its type entirely!

IT GUARANTEES YOU YEAR 'ROUND  
COMFORT, CONVENIENCE and ECONOMY

WE ALSO MANUFACTURE A COMPLETE LINE OF  
SHUTTERS, C. C. DOORS, SCREENS, SCREEN DOORS, LOUVRE DOORS

WEST COAST SCREEN CO.

145 EAST 63rd STREET      ★      LOS ANGELES, CALIFORNIA  
ADAMS 1118

★      ◆      WRITE FOR FREE ILLUSTRATED LITERATURE      ◆      ★





# ESTIMATOR'S GUIDE

## BUILDING AND CONSTRUCTION MATERIALS

PRICES GIVEN ARE FIGURING PRICES AND ARE MADE UP FROM AVERAGE QUOTATIONS FURNISHED BY MATERIAL HOUSES TO SAN FRANCISCO CONTRACTORS. 3% SALES TAX ON ALL MATERIALS BUT NOT LABOR

All prices and wages quoted are for San Francisco and the Bay District. There may be slight fluctuation of prices in the interior and southern part of the state. Freight cartage, at least, must be added in figuring country work.

**BONDS**—Performance or Performance plus Labor and Material Bond(s), \$10 per \$1000 on contract price. Labor & Material Bond(s) only, \$5.00 per \$1000 on contract price.

**BRICKWORK—MASONRY**—  
Common Brick—Per 1 M laid—\$150.00 up (according to class of work)  
Face Brick—Per 1 M laid—\$200.00 and up (according to class of work)  
Brick Steps—\$3.00 and up.  
Common Brick Veneer on Frame Bldgs.—Approx. \$1.20 and up (according to class of work).  
Face Brick Veneer on Frame Bldgs.—Approx. \$2.00 and up (according to class of work).  
Common Brick—\$36.00 per M truckload lots, delivered.  
Face Brick—\$81.00 to \$106.00 per M, truckload lots, delivered.

**Glass Structural Units—Walls Erected**—  
Clear Glass—  
2 x 6 x 12 Furring ..... \$2.00 per sq. ft.  
4 x 6 x 12 Partition ..... 2.25 per sq. ft.  
4 x 6 x 12 Double Faced  
Partition ..... 3.00 per sq. ft.  
For colored glass add ..... 30 per sq. ft.  
Mantel Fire Brick \$150.00 per M—F.O.B. Pittsburgh.

Fire Brick—Per M—\$111.00 to \$147.00.  
Cartage—Approx. \$10.00 per M.  
Paving—\$75.00.

**Building Tile**—  
8x5/2x12-inches, per M ..... \$139.50  
4x5/2x12-inches, per M ..... 105.00  
4x5/2x12-inches, per M ..... 84.00

**Hollow Tile**—  
12x12x2-inches, per M ..... \$146.75  
12x12x3-inches, per M ..... 156.85  
12x12x4-inches, per M ..... 177.10  
12x12x6-inches, per M ..... 235.30  
F.O.B. Plant

**BUILDING PAPER & FELTS**—  
1 ply per 1000 ft. roll ..... \$5.30  
2 ply per 1000 ft. roll ..... 7.80  
3 ply per 1000 ft. roll ..... 9.70  
Brownskin, Standard 500 ft. roll ..... 6.85  
Sisalcraft, reinforced, 500 ft. roll ..... 8.50

**Sheathing Papers**—  
Asphalt sheathing, 15-lb. roll ..... \$2.70  
Asphalt sheathing, 30-lb. roll ..... 3.70  
Dampcourse, 216-ft. roll ..... 2.95  
Blue Plasterboard, 60-lb. roll ..... 5.10

**Felt Papers**—  
Deadening felt, 3/8-lb., 50-ft. roll ..... \$4.30  
Deadening felt, 1-lb. Heavy ..... 5.05  
Asphalt roofing, 15-lbs ..... 2.70  
Asphalt roofing, 30-lbs ..... 3.70

**Roofing Papers**—  
Standard Grade, 108-ft. roll, Light ..... \$2.50  
Smooth Surface, Medium ..... 2.90  
Heavy ..... 3.40  
M. S. Extra Heavy ..... 3.95

**BUILDING HARDWARE**—  
Sash cord com. No. 7 ..... \$2.45 per 100 ft.  
Sash cord com. No. 8 ..... 3.00 per 100 ft.  
Sash cord spot No. 7 ..... 3.45 per 100 ft.  
Sash cord spot No. 8 ..... 3.35 per 100 ft.  
Sash weights, cast iron, \$100.00 ton ..... \$3.75  
1-ton lots, per 100 lbs. Heavy ..... 3.40  
Less than 1-ton lots, per 100 lbs. ..... 4.75

Nails, per keg, base ..... \$12.55  
8-in. spikes ..... 12.45  
Rim Knob lock sets ..... 12.80  
Butts, dull brass plated on steel, 3/2x3/2 ..... .76

**CONCRETE AGGREGATES**—  
The following prices net to Contractors unless otherwise shown. Carload lots only.

	Bunker per ton	Del'd per ton
Gravel, all sizes.....	\$2.44	\$2.90
Top Sand.....	2.38	3.13
Concrete Mix.....	2.38	3.06
Crushed Rock, 1/2" to 3/4".....	2.38	2.90
Crushed Rock, 3/4" to 1 1/2".....	2.38	2.90
Roofing Gravel.....	2.81	2.90
River Sand.....	2.50	3.00
<b>Sand</b> —		
Lapis (Nos. 2 & 4).....	3.56	3.94
Olympia (Nos. 1 & 2).....	3.56	3.68
<b>Cement</b> —		
Common (all brands, paper sacks), Per Sack, small quantity (paper).....	\$1.05	
Carload lots, in bulk, per bbl.....	3.55	
Cash discount on carload lots, 10c a bbl., 10th Prox., less than carload lots, \$4.00 per bbl. f.o.b. warehouse or delivered.		
Cash discount 2% on L.C.L.		
Trinity White.....	1 to 100 sacks, \$3.50 sack warehouse or del.	\$9.56
Medusa White.....	bbl. carload lots.	

**CONCRETE READY-MIX**—  
Delivered in 4-yd. loads:  
Per cubic yard, 1-8 Mix..... \$ 9.80  
1-7 Mix..... 10.15  
1-6 Mix..... 10.70  
1-5 Mix..... 11.40  
Curing Compound, clear, drums, per gal. .... 1.03

**CONCRETE BLOCKS**—

	Hay-dite	Basalt
4x8x16-inches, each	\$ .23	\$ .19
6x8x16-inches, each	.27	.25
8x8x16-inches, each	.27	.27
12x8x16-inches, each	.38	.40
12x8x24-inches, each	.....	.60

Haydite Aggregates—  
3/4-inch to 3/8-inch, per cu. yd. .... \$7.75  
3/8-inch to 1/2-inch, per cu. yd. .... 7.75  
No. 6 to 0-inch, per cu. yd. .... 7.75

**DAMP-PROOFING and Waterproofing**—  
Two-coat work, \$9.00 per square.  
Membrane waterproofing—4 layers of saturated felt, \$10.00 per square.  
Hot coating work, \$5.00 per square.  
Medusa Waterproofing, \$3.50 per lb. San Francisco Warehouse.  
Tricosal concrete waterproofing, 60c a cubic yd. and up.

**ELECTRIC WIRING**—\$15 to \$20 per outlet for conduit work (including switches).  
Knob and tube average \$6.00 per outlet.

**ELEVATORS**—  
Prices vary according to capacity, speed and type. Consult elevator companies. Average cost of installing a slow speed automatic passenger elevator in small four story apartment building, including entrance doors, about \$9,500.00.

**EXCAVATION**—  
Sand, \$1.00; clay or shale, \$1.50 per yard. Trucks, \$30 to \$45 per day.  
Above figures are an average without water. Steam shovel work in large quantities, less; hard material, such as rock, will... considerably more.

**FIRE ESCAPES**—  
Ten-foot galvanized iron balcony, with stairs, \$250 installed on new buildings; \$300 on old buildings.

**FLOORS**—  
Asphalt Tile, 1/8 in. gauge 18c to 35c per sq. ft.  
Composition Floors, such as Magnesite, 40c-\$1.25 per sq. ft.  
Linoleum, standard gauge, sq. yd.....\$2.75  
Mastipave—\$1.50 per sq. yd.  
Battleship Linoleum—1/8"—\$3.00 sq. yd.  
Terrazo Floors—\$2.00 per sq. ft.  
Terrazo Steps—\$2.50 per lin. ft.  
Mastic Wear Coat—according to type—20c to 35c.

**Hardwood Flooring**—  
**Oak Flooring—T & G—Unfin.**—

	3 1/2 x 2 1/4	1/2 x 2	3/8 x 2	1/2 x 2
Clear Qtd., White.....	\$425	\$405	\$	\$4x2
Clear Qtd., Red.....	405	380		
Clear Qtd., Red or White.....	355	340		
Clear Pln., Red or White.....	355	340	335	315
Select Pln., Red or White.....	340	330	325	300
#1 Common, red or White 315	310	305	280	
#2 Common, Red or White 305				

**Refinished Oak Flooring**—

	Prime	Standard
1/2 x 2.....	\$349.00	\$359.00
1/2 x 2 1/4.....	380.00	370.00
3/4 x 2 1/4.....	390.00	381.00
3/4 x 2 3/4.....	375.00	355.00
3/4 x 3.....	395.00	375.00
3/4 x 2 1/4 & 3/4 Ranch Plank.....		415.00

**Unfinished Maple Flooring**—

3/4 x 2 1/4 First Grade.....	\$390.00
3/4 x 2 1/4 2nd Grade.....	345.00
3/4 x 2 1/4 2nd & Btr. Grade.....	375.00
3/4 x 2 1/4 3rd Grade.....	240.00
3/4 x 3/4 3rd & Btr. Jtd. EM.....	380.00
3/4 x 3/4 2nd & Btr. Jtd. EM.....	390.00
33/32 x 2 1/4 First Grade.....	400.00
33/32 x 2 1/4 2nd Grade.....	360.00
33/32 x 2 1/4 3rd Grade.....	320.00
Floor Layer Wage \$2.83 hr.	

**GLASS**—  
Single Strength Window Glass ..... \$ .30 per sq. ft.  
Double Strength Window Glass ..... .45 per sq. ft.  
Plate Glass, 1/4 polished to 75..... 1.60 per sq. ft.  
75 to 100..... 1.74 per sq. ft.  
1/2 in. Polished Wire Plate Glass..... 2.50 per sq. ft.  
1/2 in. Rgh. Wire Glass..... .80 per sq. ft.  
1/2 in. Obscure Glass..... .44 per sq. ft.  
3/8 in. Obscure Glass..... .63 per sq. ft.  
1/2 in. Heat Absorbing Obscure..... .54 per sq. ft.  
1/2 in. Heat Absorbing Wire..... .72 per sq. ft.  
1/2 in. Ribbed..... .44 per sq. ft.  
3/8 in. Ribbed..... .63 per sq. ft.  
1/2 in. Rough..... .44 per sq. ft.  
3/8 in. Rough..... .63 per sq. ft.  
Glazing above additional \$1.15 to \$1.30 per sq. ft.  
Glass Blocks, set in place..... 3.50 per sq. ft.

**HEATING**—  
**Furnaces—Gas Fired**  
Floor Furnace, 25,000 BTU..... \$ 70.50  
35,000 BTU..... 75.00  
45,000 BTU..... 90.50  
Automatic Control, Add..... 39.00  
Dual Wall Furnaces, 25,000 BTU..... 91.50  
35,000 BTU..... 99.00  
45,000 BTU..... 117.00  
With Automatic Control, Add..... 39.00  
Unit Furnaces, 50,000 BTU..... 202.00  
Gravity Furnace, 65,000 BTU..... 198.00  
Forced Air Furnace, 75,000 BTU..... 313.50

**Water Heaters—5-year guarantee**  
With Thermostat Control,  
20 gal. capacity..... 87.50  
30 gal. capacity..... 103.95  
40 gal. capacity..... 120.00

## INSULATION AND WALLBOARD—

Rockwool Insulation— (2") Over 1,000 □ ft. ....	\$64.00
(2") Over 1,000 □ ft. ....	\$9.00
Cotton Insulation—Full-thickness (3½") .....	\$95.50 per M sq. ft.
Sisalation Aluminum Insulation—Aluminum coated on both sides.....	\$23.50 per M sq. ft.
Tieboard—4½" panel .....	\$9.00 per panel
Wallboard—½" thickness .....	\$55.00 per M sq. ft.
Finished Plank .....	69.00 per M sq. ft.
Ceiling Tieboard .....	69.00 per M sq. ft.

**IRON**—Cost of ornamental iron, cast iron, etc., depends on designs.

## LUMBER—

S4S No. 2 and better common O.P. or D.F. per M. f.b.m. ....	\$100.00
Rough, No. 2 common O.P. or D.F., per M. f.b.m. ....	95.00

## Flooring—

	Per M Delvd.
V.G.-D.F. 8 & 8 ft. 1 x 4 T & G Flooring .....	\$225.00
"C" and better—all .....	225.00
"D" and better—all .....	225.00
Rwd. Rustic—"A" grade medium dry .....	185.00
8 to 24 ft.	

Plywood, per M sq. ft. ....	
¼-inch, 4.0x8.0-515 .....	\$135.00
½-inch, 4.0x8.0-515 .....	219.00
¾-inch, per M sq. ft. ....	292.00
Plywood .....	11½¢ per ft.
Plyform .....	25¢ per ft.

<b>Shingles</b> (Rwd. not available)— Red Cedar No. 1—\$9.50 per square; No. 2, \$7.00; No. 3, \$5.00.	
Average cost to lay shingles, \$6.00 per square.	
Cedar Shakes—½" to ¾" x 24/26 in. handsplit tapered or split resawn, per square. ....	\$15.25
¾" to 1¼" x 24/26 in. split resawn, per square .....	17.00
Average cost to lay shakes, \$8.00 per square.	
<b>Pressure Treated Lumber</b> — Wolmized .....	Add \$35 per M to above
Cresoted .....	
8-lb. treatment .....	Add \$45 per M to above

## MARBLE—(See Dealers)

## METAL LATH EXPANDED—

Standard Diamond, 3.40, Copper Bearing, LCL, per 100 sq. yds. ....	\$43.50
Standard Ribbed, ditto .....	\$47.50

## MILLWORK—Standard,

D. F. \$150 per 1000, R. W. Rustic \$175 per 1000 (delivered).
Double hung box window frames, average with trim, \$12.50 and up, each.
Complete door unit, \$15 to \$25.
Screen doors, \$8.00 to \$12.00 each.
Patent screen windows, \$1.25 a sq. ft.
Cases for kitchen pantries seven ft. high, per lineal ft., upper \$9.00 to \$11.00; lower \$12.00 to \$13.00.
Dining room cases, \$20 per lineal foot. Rough and finish about \$1.00 per sq. ft.
<b>Labor</b> —Rough carpentry, warehouse heavy framing (average), \$75.00 per M.
For smaller work average, \$35.00 to \$100. per 1000.

## PAINTING—

Two-coat work .....	per yard 85c
Three-coat work .....	per yard \$1.10
Cold water painting .....	per yard 25c
Whitewashing .....	per yard 15c
<b>Linseed Oil, Strictly Pure</b> (Basis 7½ lbs. per gal.)	
Light iron drums .....	per gal. \$2.28
5-gallon cans .....	per gal. 2.40
1-gallon cans .....	each 2.52
Quart cans .....	each .71
Pint cans .....	each .38
½ pint cans .....	each .24

<b>Turpentine</b> (Basis, 7.2 lbs. per gal.)	
Light iron drums .....	per gal. \$1.65
5-gallon cans .....	per gal. 1.76
1-gallon cans .....	each 1.88
Quart cans .....	each .81
Pint cans .....	each .41
½ pint cans .....	each .20

## Pioneer White Lead in Oil Heavy Paste and All-Purpose (Soft-Paste)

Net Weight	Per 100 lbs.	Per Pr.	List Price	Price to Painters
Packages	lbs.	pkg.	per 100 lbs.	Pr. per pkg.
100-lb. kegs .....	\$28.35	\$29.35	\$27.50	\$27.50
50-lb. kegs .....	30.25	15.03	26.15	14.08
25-lb. kegs .....	30.35	7.50	28.45	7.12
5-lb. cans* .....	33.35	1.34	31.25	1.25
1-lb. cans* .....	36.00	.36	33.75	.34

500 lbs. (one delivery) ¾¢ per pound less than above.  
\*Heavy Paste only.

## Pioneer Dry White Lead—Litharge—Dry Red Lead Red Lead in Oil

	100 lbs.	50 lbs.	25 lbs.
Dry White Lead .....	\$28.30	\$29.35	\$27.50
Litharge .....	25.95	26.60	26.90
Dry Red Lead .....	27.20	27.85	28.15
Red Lead in Oil .....	30.65	31.30	31.60

Pound cans, \$37 per lb.

## PATENT CHIMNEYS—

6-inch .....	\$2.50 lineal foot
8-inch .....	3.00 lineal foot
10-inch .....	4.00 lineal foot
12-inch .....	5.00 lineal foot

## PLASTER—

Neat wall, per ton delivered in S. F. in paper bags, \$17.60.

## PLASTERING (Interior)—

3 Coats, metal lath and plaster .....	Yard \$3.00
Keene cement on metal lath .....	3.50
Ceilings with ¾ hot roll channels metal lath (lathed only) .....	3.00
Ceilings with ¾ hot roll channels metal lath plastered .....	4.50
Single partition ¾ channel lath 1 side (lath only) .....	3.00
Single partition ¾ channel lath 2 inches thick plastered .....	8.00
4-inch double partition ¾ channel lath 2 sides (lath only) .....	5.75
4-inch double partition ¾ channel lath 2 sides plastered .....	8.75
Thermax single partition; 1" channels; 2¼" overall partition width. Plastered both sides .....	7.50
Thermax double partition; 1" channels; 4¾" overall partition width. Plastered both sides .....	11.00
3 Coats over 1" Thermax nailed to one side wood studs or joists .....	4.50
3 Coats over 1" Thermax suspended to one side wood studs with spring sound isolation clip .....	5.00

Note—Channel lath controlled by limitation orders.

## PLASTERING (Exterior)—

2 coats cement finish, brick or concrete wall .....	Yard \$2.50
3 coats cement finish, No. 18 gauge wire mesh .....	3.50
Lime—\$4.00 per bbl. at yard.	
Processed Lime—\$4.15 per bbl. at yard.	
Rock or Grip Lath—¾"-30c per sq. yd.	
¾"-29c per sq. yd.	
Composition Stucco—\$4.00 sq. yd. (applied).	

## PLUMBING—

From \$200.00 per fixture up, according to grade, quality and runs.

## ROOFING—

"Standard" tar and gravel, 4 ply. ....	\$13.00
per sq. for 30 sqs. or over.	
Less than 30 sqs. \$16.00 per sq.	
Tile \$40.00 to \$50.00 per square.	
No. 1 Redwood Shingles in place.	
4½ in. exposure, per square .....	\$18.25
5/2 No. 1 Cedar Shingles, 5 in. ex- posure, per square .....	14.50
5/8 x 16"—No. 1 Little Giant Cedar Shingles, 5" exposure, per square .....	18.25
4/2 No. 1-24" Royal Cedar Shingles 7½" exposure, per square .....	23.00
Re-coat with Gravel \$5.50 per sq.	

Asbestos Shingles, \$27 to \$35 per sq. laid, 1/2 to ¾ x 25" Resawn Cedar Shakes, 10" Exposure .....	\$30.00
¾ to 1¼ x 25" Resawn Cedar Shakes, 10" Exposure .....	\$35.00
1 x 25" Resawn Cedar Shakes, 10" Exposure .....	\$22.00

Above prices are for shakes in place.

## SEWER PIPE—

C.I. 6-in. to 24-in. B. & S. Class B and heavier, per foot .....	\$99.50
Vitrified, per foot: L.C.L. F.O.B. Ware- house, San Francisco.	
Standard, 8-in. ....	\$ .66
Standard, 12 in. ....	1.30
Standard, 24-in. ....	5.41
Clay Drain Pipe, per 1,000 L.F. L.C.L., F.O.B. Warehouse, San Francisco:	
Standard, 6-in. per M. ....	\$240.00
Standard, 8-in. per M. ....	400.00

## SHEET METAL—

Windows—Metal, 25.00 a sq. ft.  
Fire doors (average), including hardware  
\$2.80 per sq. ft., size 12'x12'. \$3.75 per  
sq. ft., size 3'x6'.

## SKYLIGHTS—(not glazed)

Galvanized iron, per sq. ft. ....	\$1.25
Vented hip skylights, per sq. ft. ....	2.25
Aluminum, puttyless, (unglazed), per sq. ft. ....	1.85
(installed and glazed), per sq. ft. ....	1.85

## STEEL—STRUCTURAL—

\$290 per ton erected, when out of mill.  
\$350 per ton erected, when out of stock.

## STEEL REINFORCING—

\$200.00 per ton, in place.	
¼-in. Rd. (Less than 1 ton) per 100 lbs. ....	\$8.90
¾-in. Rd. (Less than 1 ton) per 100 lbs. ....	7.80
1½-in. Rd. (Less than 1 ton) per 100 lbs. ....	7.50
2-in. Rd. (Less than 1 ton) per 100 lbs. ....	7.25
¾-in. & 7/8-in. Rd. (Less than 1 ton) .....	7.15
1 ton to 5 tons, deduct 25c.	

## STORE FRONTS—

Individual estimates recommended. See  
ESTIMATORS DIRECTORY for Architect-  
tural Veneer (3), and Mosaic Tile (35).

## TILE—

Ceramic Tile Floors—Commercial \$1.20 to \$1.60 per sq. ft.	
Cove Base—\$1.40 per lin. ft.	
Quarry Tile Floors, 6x6" with 6" base @ \$1.35 per sq. ft.	
Tile Wainscots & Floors, Residential, 4½x4½", @ \$1.65 to \$2.00 per sq. ft.	
Tile Wainscots, Commercial Jobs, 4½x4½" Tile, @ \$1.50 to \$1.65 per sq. ft.	
Asphalt Tile Floor 1/2" - 3/4" - \$1.18 - \$1.35 sq. yd.	
Light shades slightly higher.	
Cork Tile—\$ .70 per sq. ft.	
Mosaic Floors—See dealers.	
Linoleum tile, per □ ft. ....	\$ .65
Rubber tile, per □ ft. ....	\$ .55 to \$ .75

## Furring Tile

Scored .....	F.O.B. S. F.
12 x 12, each .....	\$ .17
Kratflite: Per square foot	Small Large
Patio Tile—Niles Red .....	Lots
12 x 12 x ¾-inch plain .....	\$ .40
6 x 12 x ¾-inch plain .....	.44
6 x 6 x ¾-inch plain .....	.46
<b>Building Tile—</b>	
8x5½x12-inches, per M .....	\$139.50
6x5½x12-inches, per M .....	105.00
4x5½x12-inches, per M .....	84.00
<b>Hollow Tile—</b>	
12x12-inches, per M .....	\$146.75
12x12-3-inches, per M .....	156.85
2x12-4-inches, per M .....	172.10
2x12-6-inches, per M .....	235.30

F.O.B. Plant  
**VENETIAN BLINDS—**  
75c per square foot and up. Installation  
extra.

**WINDOWS—STEEL—INDUSTRIAL—**  
Cost depends on design and quality required.

# ARCHITECT AND ENGINEER ESTIMATOR'S DIRECTORY

## Building and Construction Materials

**EXPLANATION**—Building and construction materials are shown in major classified groups for general identification purposes with names and addresses of suppliers of materials listed in detail under group classification where name first appears—main offices are shown first with branch or district offices following. The numeral appearing in listings \*(3) refers to the major group classification where complete data on the dealer, or representative, may be found.

### ADHESIVES (1)

Wall and Floor Tile Adhesives  
THE CAMBRIDGE TILE MFG. CO. \*(135)

### AIR CONDITIONING (2)

Air Conditioning & Cooling  
UTILITY APPLIANCE CORP.  
Los Angeles 58: 4851 S. Alameda St.  
San Francisco: 1355 Market St., UN 1-4908

### ARCHITECTURAL PORCELAIN ENAMEL (2a)

CALIFORNIA METAL ENAMELING CO.  
Los Angeles: 6904 E. Slauson, UN 01268  
San Francisco: O'Keefe's, 55-11th St., UN 3-4445  
Portland: Beaver Sheet Metal & Roofing Co.,  
924 N. Russell St., TR 6766  
Seattle: Teclar Aluminum Co.,  
625 Yale Ave N., SE 8494  
Salt Lake City: S. A. Roberts & Co.,  
109 W. 2nd South, Salt Lake 4-4431  
Phoenix: Baker-Thomas Co.,  
300 S. 12th, Phoenix 4-5503  
Tucson: Laing-Garrett Co.,  
19 S. Tyndall Ave., TU 2-2893  
Albuquerque: Welch-Irwin Corp., 1726 Lomas Blvd. NE.

### ARCHITECTURAL VENEER (3)

Ceramic Veneer  
GLADDING, McBEAN & CO.  
San Francisco: Harrison at 9th St., UN 1-7400  
Los Angeles: 2901 Los Feliz Blvd., OL 2121  
Portland: 110 S.E. Main St., EA 6179  
Seattle: 1500 First Ave. S., EL 4711  
Spokane: 1102 N. Monroe St., BR 3259  
THE CAMBRIDGE TILE MFG. CO. \*(135)  
Porcelain Veneer  
PORCELAIN ENAMEL PUBLICITY BUREAU  
Oakland 12: Room 601 Franklin Building  
Pasadena 8: P. D. Box 186, East Pasadena Station  
Granite Veneer  
VERMONT MARBLE COMPANY  
San Francisco 5: 525 Market St., SU 1-6747  
Los Angeles: 3522 Council St., DU 2-7834  
Marble Veneer  
VERMONT MARBLE COMPANY  
San Francisco 5: 525 Market St., SU 1-6747  
Los Angeles: 3522 Council St., DU 2-7834

### BANKS - FINANCING (4)

CROCKER FIRST NATIONAL BANK OF S. F.  
San Francisco, Post & Montgomery Sts., EX 2-7700

### BATHROOM FIXTURES (5)

Metal  
THE CAMBRIDGE TILE MFG. CO. \*(135)  
Ceramic  
THE CAMBRIDGE TILE MFG. CO. \*(135)

### BRASS PRODUCTS (6)

GREENBERG'S, M. & SONS  
San Francisco 7: 765 Folsom, EX 2-3143  
Los Angeles 23: 1258 S. Boyle, AN 3-7108  
Seattle 4: 1016 First Ave. So., MA 5140  
Phoenix: 3009 N. 19th Ave., Apt. 92, PH 2-7663  
Portland 4: 510 Builders Exch. Bldg., AT 6443

### BRICKWORK (7)

Face Brick  
GLADDING, McBEAN & CO. \*(13)

KRAFTILE \*(135)  
REMILLARD-DANDINI CO.  
San Francisco 4: 400 Montgomery St., EX 2-4988

### BRONZE PRODUCTS (8)

GREENBERG'S, M. & SONS \*(16)

### BUILDING PAPERS & FELTS (9)

ANGIER PACIFIC CORP.  
San Francisco 5: 55 New Montgomery St., DO 2-4416  
Los Angeles: 7424 Sunset Blvd.  
PACIFIC COAST AGGREGATES, INC. \*(111)  
SISALKRAFT COMPANY  
San Francisco 5: 55 New Montgomery St., EX 2-3066  
Chicago, Ill.: 205 West Walker Drive

### BUILDING HARDWARE (9a)

THE STANLEY WORKS  
San Francisco: Monadnock Bldg., YU 6-5914  
New Britain, Conn.

### CABINETS & FIXTURES (9b)

FINK & SCHINDLER, THE; CO.  
San Francisco: 522 Brannan St., EX 2-1513

### CEMENT (10)

IDEAL CEMENT COMPANY (Pacific Division)  
San Francisco 4: 310 Sansome St., GA 1-4100  
PACIFIC COAST AGGREGATES, INC. \*(11)

### CONCRETE AGGREGATES (11)

Ready Mixed Concrete  
PACIFIC COAST AGGREGATES, INC.  
San Francisco: 400 Alabama St., KL 2-1616  
Sacramento: 16th and A Sts., GI 3-6586  
San Jose: 790 Stockton Ave., CV 2-5620  
Oakland: 2400 Peralta St., GL 1-0177  
Stockton: 820 So. California St., ST 8-8643  
Lightweight Aggregates  
AMERICAN PERLITE CORP.  
Richmond: 26th & B. St. - Yd. 2, RI 4307

### DOORS (12)

Hollywood Doors  
WEST COAST SCREEN CO.  
Los Angeles: 1127 E. 63rd St., AD 1-1108  
W. P. FULLER CO.  
Seattle, Tacoma, Portland  
NICOLAI DOOR SALES CO.  
San Francisco: 3045 19th St.  
F. M. COBB CO.  
Los Angeles & San Diego  
SOUTHWESTERN SASH & DOOR  
Phoenix, Tucson, Arizona  
El Paso, Texas  
HOUSTON SASH & DOOR  
Houston, Texas  
Screen Doors  
WEST COAST SCREEN DOOR CO.  
(See above)

### FIRE ESCAPES (13)

MICHEL & PFEFFER IRON WORKS, INC.  
South Linden & Tanforan Ave.  
South San Francisco: JU 4-8362

### FIREPLACES (14)

Heat Circulating  
SUPERIOR FIREPLACE CO.  
Los Angeles: 1708 E. 15th St., PR B393  
Baltimore, Md.: 601 No. Point Rd.

### FLOORS (15)

Hardwood Flooring  
HOGAN LUMBER COMPANY  
Oakland: Second and Alice Sts., GL 1-6861  
Floor Tile  
GLADDING, McBEAN & CO. \*(13)  
KRAFTILE \*(135)  
Floor Tile (Ceramic Mosaic)  
THE CAMBRIDGE TILE MFG. CO. \*(135)  
Floor Treatment & Maintenance  
HILLYARD SALES CO. (Western)  
San Francisco: 470 Alabama St., MA 1-7766  
Los Angeles: 923 E. 3rd, TR 8282  
Seattle: 3440 E. Marginal Way  
Diversified (Magnesite, Asphalt Tile, Composition, Etc.)  
LE ROY OLSON CO.  
San Francisco 10: 3070 - 17th St., HE 1-0188  
Sleepers (composition)  
LE ROY OLSON CO.

### GLASS (16)

W. P. FULLER COMPANY  
San Francisco: 301 Mission St., EX 2-7151  
Los Angeles, Calif.  
Portland, Ore.

### HEATING (17)

S. T. JOHNSON CO.  
Oakland 8: 940 Arlington Ave., OL 2-6000  
San Francisco: 585 Potrero Ave., MA 1-2757  
Philadelphia 8, Pa.: 401 N. Broad St.  
SCOTT COMPANY  
San Francisco: 243 Minna St., YU 2-0400  
Oakland: 113 - 10th St., GL 1-1937  
San Jose, Calif.  
Los Angeles, Calif.  
UTILITY APPLIANCE CORP. \*(12)  
Electric Heaters  
WESIX ELECTRIC HEATER CO.  
San Francisco 5: 390 First St., GA 1-2211  
Los Angeles: 520 W. 7th St., MI 8096  
Portland: Terminal Sales Bldg., BE 2050  
Seattle: Securities Bldg., SE 5028  
Designer of Heating  
THOMAS B. HUNTER  
San Francisco 4: 41 Sutter St., GA 1-1164

### INSULATION AND WALL BOARD (18)

LUMBER MANUFACTURING CO.  
San Francisco: 225 Industrial Ave., JU 7-1760  
PACIFIC COAST AGGREGATES, INC. \*(111)  
SISALKRAFT COMPANY \*(9)  
WESTERN ASBESTOS COMPANY  
San Francisco: 675 Townsend St., XL 2-3868  
Oakland: 251 Fifth Avenue, GL 1-2345  
Stockton: 733 S. Van Buren, ST 4-9421  
Sacramento 1331 - 1 St., HU 1-0125  
Fresno: 434 - P St., FR 2-1600

### IRON—Ornamental (10)

MICHEL & PFEFFER IRON WORKS, INC. \*(113)

### LANDSCAPING (20)

Landscape Contractors  
HENRY C. SOTO CORP.  
Los Angeles: 13,000 S. Avalon Blvd., ME 4-6617

### LIGHTING FIXTURES (21)

SMOOT-HOLMAN COMPANY  
Inglewood, Calif., OR 8-1217  
San Francisco: 55 Mississippi St., MA 1-8474



**LUMBER (22)**  
Shingles  
LUMBER MANUFACTURING CO. \*(18)

**MARBLE (23)**  
VERMONT MARBLE COMPANY  
San Francisco 5: 525 Market St., SU 1-6747  
Los Angeles 4: 3522 Council St., DU 2-7834

**METAL LATH EXPANDED (24)**  
PACIFIC COAST AGGREGATES, INC. \*(11)

**MILLWORK (25)**  
FINK & SCHINDLER, THE; CO. \*(96)  
LUMBER MANUFACTURING COMPANY \*(18)  
MULLEN MANUFACTURING COMPANY  
San Francisco: 6D-80 Rausch St., UN 1-5815  
PACIFIC MANUFACTURING COMPANY  
San Francisco: 16 Beale St., GA 1-7755  
Santa Clara: 261D The Alameda, SC 6D7  
Los Angeles, 682D McKinley Ave., TH 4196

**PAINTING (26)**  
Paint  
W. P. FULLER COMPANY \*(16)

**PLASTER (27)**  
Interiors - Metal Lath & Trim  
PACIFIC COAST AGGREGATES, INC. \*(11)  
Exteriors  
PACIFIC PORTLAND CEMENT COMPANY \*(28)

**PLASTIC CEMENT (28)**  
IDEAL CEMENT COMPANY  
San Francisco: 31D Sansome St., GA 1-4100

**PLUMBING (29)**  
THE HALSEY TAYLOR COMPANY  
Redlands, Calif.  
Warren, Ohio  
THE SCOTT COMPANY \*(17)  
HAWES DRINKING FAUCET COMPANY  
Berkeley 1D-1435 Fourth St., LA 5-3341  
CONTINENTAL WATER HEATER COMPANY  
Los Angeles 31: 1801 Pasadena Ave., CA 6178  
SIMONDS MACHINERY COMPANY  
San Francisco: 816 Folsom St., DO 2-6794  
Los Angeles: 455 East 4th St., MU 8322  
SECURITY VALVE COMPANY  
Los Angeles 31: 41D San Fernando Rd., CA 6191

**RANGE-REFRIGERATOR (29a)**  
Combinations  
GENERAL AIR CONDITIONING CORPN.  
Los Angeles 23: 4542 E. Dunham St.  
San Francisco: 42D Market St., DO 2-4194

**RESILIENT TILE (30)**  
LE ROY OLSON CO. \*(15)

**SEWER PIPE (32)**  
GLADDING, McBEAN & CO. \*(3)

**SHEET METAL (32)**  
Windows  
DETROIT STEEL PRODUCTS COMPANY  
Oakland 8: 131D - 63rd St., OL 2-8826  
San Francisco: Russ Building, DO 2-089D  
MICHEL & PFEFFER IRON WORKS, INC. \*(13)  
PACIFIC COAST AGGREGATES, INC. \*(11)

Fire Doors  
DETROIT STEEL PRODUCTS COMPANY

Skylights  
DETROIT STEEL PRODUCTS COMPANY

**STEEL—STRUCTURAL (33)**  
COLUMBIA STEEL CO.  
San Francisco: Russ Bldg., SU 1-250D  
Los Angeles: 2087 E. Slauson, LA 1171  
Portland: 2345 N. W. Nicolai, BE 7261  
Seattle 1331 3rd Ave. Bldg., MA 1972  
Salt Lake City: Walker Bank Bldg., SL 3-6733  
HERRICK IRON WORKS  
Oakland: 18th & Campbell Sts., GL 1-1767  
JUDSON PACIFIC-MURPHY CORP.  
Emeryville: 430D Eastshore Highway, OL 3-1717  
REPUBLIC STEEL CORP.  
San Francisco: 116 N. Montgomery St., GA 1-0977  
Los Angeles: Edison Building  
Seattle: White-Henry-Stuart Building  
Salt Lake City: Walker Bank Building  
Denver: Continental Oil Building  
SAN JOSE STEEL COMPANY  
San Jose 195 North Thirtieth St., CO 4184

**STEEL—REINFORCING (34)**  
REPUBLIC STEEL CORP. \*(33)  
HERRICK IRON WORKS \*(33)  
SAN JOSE STEEL CO. \*(33)  
COLUMBIA STEEL CO. \*(33)

**CLAY TILE (35)**  
THE CAMBRIDGE TILE MFG. CO.  
San Francisco 1D: 470 Alabama St., UN 3-1666  
Los Angeles 19: 1335 S. La Brea, WE 3-7800  
GLADDING, McBEAN & CO. \*(3)  
KRAFTILE  
Niles, Calif.: Niles 3611  
San Francisco 5: 5D Hawthorne St., DO 2-3780  
Los Angeles 13: 406 South Main St., MU 7241

**TIMBER—REINFORCING (36)**  
Trusses

Tacoma, Wash.  
WYERHAUSEY SALES CO.  
St. Paul, Minn.  
Newark, N. J.  
Treated Timber  
J. H. BAXTER CO.  
San Francisco 4: 333 Montgomery St., DO 2-3883  
Los Angeles 13: 601 West Fifth St., MI 6294

**WALL TILE (37)**  
THE CAMBRIDGE TILE MFG. CO. \*(35)  
GLADDING, McBEAN & CO. \*(3)  
KRAFTILE COMPANY \*(35)

**WINDOWS STEEL (38)**  
DETROIT STEEL PRODUCTS CO. \*(32)  
MICHEL & PFEFFER IRON WORKS, INC. \*(13)  
PACIFIC COAST AGGREGATES, INC. \*(11)

**GENERAL CONTRACTORS (39)**  
BARRETT & HILP  
San Francisco: 918 Harrison St., DO 2-0700  
Los Angeles: 234 W. 37th Place, AD 3-8161  
J. BETTANCOURT  
San Bruno: 1D15 San Mateo Ave., JU No 8-7525  
DINWIDDIE CONSTRUCTION COMPANY  
San Francisco: Crocker Building, YU 6-2718  
CLINTON CONSTRUCTION COMPANY  
San Francisco: 923 Folsom St., SU 1-3440  
MATTOCK CONSTRUCTION COMPANY  
San Francisco: 604 Mission St., GA 1-5516  
E. H. MOORE & SONS  
San Francisco: 693 Mission St., GA 1-8579  
PARKER, STEFFENS & PEARCE  
San Francisco: 135 So. Park, EX 2-6639

**TESTING LABORATORIES**  
**(ENGINEERS & CHEMISTS (40))**  
ABBOT A. HANKS, INC.  
San Francisco: 624 Sacramento St., GA 1-1697  
ROBERT W. HUNT COMPANY  
San Francisco: 251 Kearny St., EX 2-4634  
Los Angeles: 3050 E. Slauson, JE 9131  
Chicago, New York, Pittsburgh  
PITTSBURGH TESTING LABORATORY  
San Francisco: 651 Howard St., EX 2-1747

## CONSTRUCTION CONTRACTS AWARDED AND MISCELLANEOUS PERSONNEL DATA

**OFFICE BUILDING.** San Francisco. Vermont Marble Co., San Francisco, owner. 2-story, frame and stucco construction, \$50,000. ARCHITECT: Ward & Bolles, San Francisco. ENGINEER: T. F. Chase, San Francisco. GENERAL CONTRACTOR: Dinwiddie Const. Co., San Francisco.

**TWO ELEMENTARY SCHOOLS.** Rialto, San Bernardino county. Rialto Elementary School District, Rialto, owner. One school will contain 8-classrooms, 2-kindergartens, toilet facilities and administration unit. Frame and stucco with red clay tile roof, asphalt tile floors, area 11,964 sq ft. Walls, boards, metal toilet partitions, metal sinks, radiant heating, insulation covered walls. Incandescent lighting, plumbing and elec-

trical work. Other is exact duplicate, \$307,950. ARCHITECT: Harold Gimeno, Santa Ana. GENERAL CONTRACTOR: L. P. Scherer, Redlands.

**CHURCH & RECTORY.** Half Moon Bay, San Mateo county. Roman Catholic Archbishop of San Francisco, owner. Two-story frame and stucco Church and Rectory for Our Lady of the Pillar Parish, structural steel bents and roof trusses, \$235,380. ARCHITECT: Hewitt C. Wells, San Francisco. GENERAL CONTRACTOR: Pacific Coast Builders, San Francisco.

**FRATERNITY HOUSE ADDN.,** Palo Alto. Sigma Nu Fraternity, Stanford Campus, Palo Alto, owner. Two-story frame and stucco Fraternity house addition to provide for

kitchen and additional dormitory space, shingle exterior, \$11,900. ARCHITECT: Reimers & Overmire, San Francisco. GENERAL CONTRACTOR: M. C. Ingraham, Menlo Park.

**ELECTRONICS LABORATORY BLDG.,** Mt. View, Santa Clara county. Sylvania Electric Products Co., Mt. View, owner. One-story structural steel frame, concrete block walls, steel roof deck, insulated, steel sash, composition roofing, concrete floors, asphalt tile floors, \$500,000. GENERAL CONTRACTOR: Austin Co., Oakland.

**HATCHERY ADDN.,** Anchem, Orange county. Demler Hatchery, Anaheim, owner. One-story, frame and stucco addition, gravel roof, slab floors, metal sash, slab doors, electrical work to provide for six electrical incubators, and concrete work. ARCHITECT: Everett Lynn Child, Fullerton.

**LOW RENT HOUSING.** Richmond, Contra Costa county. Richmond Housing Authority, Richmond, owner. Comprises 300 1 and 2-story frame and stucco units to be built in the Easter Hill Village project, \$1,952,766.

ARCHITECT: Donald Hardison & Vernon De Mars, Richmond. GENERAL CONTRACTOR: Theo. G. Meyer & Sons, San Francisco.

**INK FACTORY, Berkeley,** Alameda County, California Ink Co., San Francisco, owner. 1-story, with mezzanine, frame and stucco construction, wood roof trusses, sheet rock interior, steel sash and skylights, 100x200 ft., \$210,000. GENERAL CONTRACTOR: Pacific Co., Berkeley.

**SALES AND EQUIPMENT BLDG., Los Angeles.** Brown-Bevis Industrial Equipment Co., Los Angeles, owner. Reinforced concrete tilt-up construction, offices, showroom, shops and warehouse; tapered steel girders, composition roofing, steel sash, metal covered doors, sliding doors, air condi-

tioned office area, acoustic ceiling, asphalt tile floor covering, toilets, vault, electrical work, spur track, 15-ton crane, 7-acres of paved landing and parking area, wire fencing, flood lights, 50,000 sq. ft. of floor space. ARCHITECT: Herman Charles Light, Los Angeles. GENERAL CONTRACTOR: William P. Neil Co., Ltd., Los Angeles.

**NEW HIGH SCHOOL, Antioch,** Contra Costa county, Antioch-Live Oak Unified School District, Antioch, owner. Structural steel frame and wood frame construction, brick veneer, structural steel roof trusses, three buildings; classrooms, administration offices, home economics, art, shops, commercial, library, cafeteria, gymnasium, shower and locker rooms, toilet rooms,

\$1,669,000. ARCHITECT: Wurster, Bernardi & Emmons, San Francisco. GENERAL CONTRACTOR: Pacific Co., Berkeley.

**ELEMENTARY SCHOOL, Dinuba,** Tulare county, Dinuba Elementary School District, Dinuba, owner. Frame and stucco construction of 11-classrooms, administration office, kindergarten, multi-purpose room, kitchen, toilet rooms, \$642,120. ARCHITECT: Swartz & Hyberg, Fresno. GENERAL CONTRACTOR: Floyd G. Borchardt, Stockton.

**HERBERT SLATER HIGH SCHOOL, Santa Rosa,** Sonoma county, Santa Rosa Board of Education, Santa Rosa, owner. Frame and stucco construction, 13-classrooms, ad-

## BUILDING TRADES WAGE (JOB SITES) NORTHERN, CENTRAL AND SOUTHERN CALIFORNIA

ATTENTION: The following are the PREVALING hourly rates of compensation being paid and in effect by employers by agreement between employees and their union; or as recognized and determined by the U. S. Department of Labor. (June 1, 1953.)

CRAFT	San Francisco	Alameda	Contra Costa	Fresno	Sacramento	San Joaquin	Santa Clara	Solano	Los Angeles	San Bernardino	San Diego	Santa Barbara	Kern
<b>ASBESTOS WORKERS</b>	\$2.585	\$2.585	\$2.585	\$2.585	\$2.585	\$2.585	\$2.585	\$2.585	\$2.25	\$2.25	\$2.25	\$2.25	\$2.25
<b>BOILERMAKERS</b>	2.68	2.68	2.68	2.68	2.68	2.68	2.68	2.68	3.175	3.175	2.75	3.175	3.175
<b>BRICKLAYERS</b>	3.25	3.25	3.25	3.00	3.25	3.00	3.25	3.25	1.94	1.94	1.94	1.94	1.94
<b>BRICKLAYERS, HODCARRIERS</b>	2.45	2.45	2.45	2.00	2.40	2.25	2.45	2.45	2.57	2.57	2.57	2.57	2.57
<b>CARPENTERS</b>	2.60	2.60	2.54	2.54	2.54	2.54	2.54	2.54	2.57	2.57	2.57	2.57	2.57
<b>CEMENT FINISHERS</b>	2.57	2.57	2.57	2.57	2.57	2.57	2.57	2.57	2.57	2.57	2.57	2.57	2.57
<b>CONCRETE MIXER—Skip 1 1/2 yd.</b>	2.28	2.28	2.28	2.28	2.28	2.28	2.28	2.28	2.38	2.38	2.38	2.38	2.38
<b>ELECTRICIANS</b>	3.00	3.00	3.00	3.00	3.00	2.75	3.00	2.50	3.00	3.00	3.00	3.00	3.00
<b>ELEVATOR CONSTRUCTORS</b>	2.75	2.70	2.65	2.75	2.915	2.915	2.915	2.915	2.25	2.25	2.25	2.25	2.25
<b>ENGINEERS: MATERIAL HOIST</b>	2.56	2.56	2.56	2.56	2.56	2.56	2.56	2.56	1.9875	1.9875	1.9875	1.9875	1.9875
<b>GLAZIERS</b>	2.30	2.30	2.30	2.30	2.25	2.30	2.30	2.50	2.26	2.26	2.26	2.26	2.26
<b>IRONWORKERS: ORNAMENTAL</b>	2.70	2.70	2.70	2.70	2.70	2.70	2.70	2.70	2.70	2.70	2.70	2.70	2.70
<b>REINF. STREET</b>	*2.60	2.60	2.60	2.60	2.60	2.60	2.60	2.60	2.61	2.61	2.61	2.61	2.61
<b>STRUCTURAL STEEL</b>	*2.85	2.85	2.85	2.85	2.85	2.85	2.85	2.85	2.70	2.70	2.70	2.70	2.70
<b>LABORERS: BUILDING</b>	1.85	1.85	1.85	1.85	1.85	1.85	1.85	1.85	1.94	1.94	1.94	1.94	1.94
<b>LABORERS: CONCRETE</b>	1.85	1.85	1.85	1.85	1.85	1.85	1.85	1.85	1.94	1.94	1.94	1.94	1.94
<b>LATHERS</b>	3.25	3.50	3.50	3.00	3.00	3.00	3.4375	3.00	3.125	3.125	3.125	3.125	3.125
<b>MARBLE SETTERS</b>	2.95	2.95	2.95	2.95	2.95	2.95	2.95	2.95	2.875	2.875	2.875	2.875	2.875
<b>MOSAIC &amp; TERRAZZO</b>	2.76	2.76	2.76	2.76	2.76	2.76	2.76	2.76	2.40	2.40	2.40	2.40	2.40
<b>PAINTERS—BRUSH</b>	**2.60	2.60	2.60	2.60	2.625	2.45	2.60	2.27	2.54	2.50	2.53	2.22	2.22
<b>PAINTER—SPRAY</b>					2.91	2.70			2.68				
<b>PILEDRIVERS—OPERATOR</b>	2.75	2.75	2.75	2.75	2.75	2.75	2.75	2.75	2.74	2.70	2.70	2.70	2.70
<b>PLASTERERS</b>	3.125	3.165	3.125	3.125	3.00	3.00	3.125	3.00	3.125	3.125	3.125	3.125	3.125
<b>PLASTERERS, HODCARRIERS</b>	2.60	2.60	2.60	2.60	2.50	2.50	2.50	2.50	2.375	2.375	2.30	2.00	2.00
<b>PLUMBERS—STEAM FITTERS</b>	2.90	2.90	2.875	2.75	2.90	2.75	2.75	2.90	2.90	2.90	2.90	2.90	2.90
<b>ROOFERS</b>	2.50	2.50	2.50	2.25	2.50	2.50	2.50	2.50	2.65	2.50	1.90	2.00	2.00
<b>SHEET METAL WORKERS</b>	2.475	2.475	3.125	2.43	2.75	2.50	2.40	2.415	2.475	2.475	2.175	2.00	2.475
<b>SPRINKLER FITTERS</b>	2.75	2.70	2.70	2.625	2.625	2.625	2.75	2.75	2.25	2.25	2.25	2.25	2.25
<b>STEAMFITTERS</b>	2.78	2.90	2.90	2.75	2.625	2.625	2.75	2.75	2.90	2.90	2.90	2.90	2.90
<b>TRACTOR OPERATOR</b>	2.67	2.67	2.67	2.67	2.67	2.67	2.67	2.67	2.52	2.52	2.52	2.52	2.52
<b>TRUCK DRIVERS—1/2 Ton or less</b>	1.89	1.89	1.89	1.89	1.89	1.89	1.89	1.89	2.02	2.02	2.02	2.02	2.02
<b>TILESETTERS</b>	2.955	2.955	2.955	2.955	2.955	2.955	2.955	2.955	2.65	2.65	2.65	2.65	2.65

\* 6 Hour Day. \*\* 7 Hour Day. \*\*\* Before C.I.S.C for 15c increase.

Prepared and compiled by:

CENTRAL CALIFORNIA CHAPTER, ASSOCIATED GENERAL CONTRACTORS OF AMERICA, with the assistance and cooperation of secretaries of General Contractors Associations and Builders Exchanges of Northern California; and the above information for southern California is furnished by the Labor Relations Department of the Southern California Chapter, ASSOCIATED GENERAL CONTRACTORS OF AMERICA.

# CLASSIFIED ADVERTISING

RATE: 20c PER WORD . . . CASH WITH ORDER

MINIMUM \$5.00

**HOME BUYERS**—Now building moderate priced homes in Sacramento and Marysville area; we are in a position to serve your needs. "Better Built Homes" by Ronne, Ronne & Ronne, Builders, 520 9th Street, Sacramento.

**YOUNG MAN SEEKS OPPORTUNITY**—Young man with good background in the construction industry, seeks opportunity with Contractor. Primary consideration chance to advance to executive position in future. College graduate. INQUIRE, Box 521, ARCHITECT & ENGINEER magazine, 68 Post St., San Francisco.

**COLLECTIONS**—Thoroughly experienced in all phases of the collection business; your interests protected at all times; bonded agents everywhere; no collection no charge; California Material Dealers Service Co., 925 Hearst Bldg., San Francisco. Ernest T. Langley, Manager.

**BUILDERS!** You can make more money; get information you need before it is published elsewhere; Subscribe to the daily ARCHITECTS REPORTS, only \$10.00 per month. Complete information from ARCHITECTS REPORTS, 68 Post Street, San Francisco. Phone DOuglas 2-8311.

**PHOTOGRAPHY.** For the best in construction photography, including exterior and interior, aerial, and progress views . . . you will find as many others have that it's the SKELTON STUDIOS, 875 O'Farrell St., San Francisco. Telephone PRospect 6-1841.

**ARCHITECTURAL SLIDING SLEEL SASH.** One lot only — new, half price. 13 units, assorted sizes, 353 square feet total. 3 at 7 ft. x 5 ft.; 4 at 7 ft. x 4 1/2 ft.; 1 at 6 ft. x 4 1/2 ft.; 2 at 6 ft. x 4 ft.; 1 at 7 ft. x 3 1/2 ft.; 1 at 4 1/2 ft. x 3 ft.; 1 at 3 ft. x 3 ft. Phone Delaware 3-7378, San Francisco.

ministration offices, 2-science rooms, home making unit, library, arts and crafts, art room, music room, cafeteria, combination gymnasium and auditorium, shop building, toilet rooms, reinforced concrete, wood roof trusses, \$1,378,000. ARCHITECT: J. Clarence Felciano, Santa Rosa. GENERAL CONTRACTOR: Rapp Const. Co., Santa Rosa.

**CHURCH ADDN.**, Kingsburg, Fresno county. Covenant Church, Kingsburg, owner. Addition to the present Church building, \$53,470. ARCHITECT: Benjamin F. Lippold, Fresno. GENERAL CONTRACTOR: Ellberg & Conklin, Kingsburg.

**AUTO SUPPLY BLDG.**, Eureka, Humboldt county. Kramer Auto Supply Co., Eureka, owner. 1-story frame construction, \$21,250. ARCHITECT: Frank T. Georgeson, Eureka.

GENERAL CONTRACTOR: H. Shlinkman, Fields Landing.

**SWIMMING POOL.** Watsonville, Santa Cruz county. Watsonville Joint Union High School District, Watsonville, owner. Reinforced concrete construction, heating and filtering system, \$91,000. ARCHITECT: John Lyon Reid, San Francisco. GENERAL CONTRACTOR: T. H. Rosewall, Watsonville.

**THEATRE BLDG.**, Carson City, Nevada. Carson Theatre, Carson City, owner. One story concrete block, wood roof trusses, 60x130 ft. ARCHITECT: Vincent G. Raney, San Francisco. GENERAL CONTRACTOR: Sture Svensson, Carson City, Nevada.

**PAROCHIAL SCHOOL.** Phoenix, Arizona. St. Francis Xavier Parish, Phoenix, owner. 1-story, ten room, stucco and masonry construction, tile roof, concrete and asphalt

tile floors, gas fired heat, air conditioning, insulation, plaster, sheet metal, steel sash, ceramic tile, \$70,000. ARCHITECT: Mathew E. Trudell, Phoenix. GENERAL CONTRACTOR: E. J. Wasielewski, Phoenix.

**CONVERT LODGE BLDG. TO RADIO STUDIO.** San Francisco. American Broadcasting Co., San Francisco, owner. Conversion of 4-story lodge building to radio and television studios; interior and exterior alterations, sound deadening, acoustics, electrical work, plastering, plumbing, \$1,500,000. ARCHITECT: Pereira & Luckman, Los Angeles. GENERAL CONTRACTOR: William Simpson Const. Co., Los Angeles.

**RECTORY.** St. Christopher's Rectory, San Jose, Santa Clara county. Roman Catholic Archbishop of San Francisco. San Francisco, owner. 1-story frame and stucco building containing 3200 sq. ft., some brick veneer. \$40,097. ARCHITECT: Vincent G. Raney, San Francisco. GENERAL CONTRACTOR: John A. Parsley, Cupertino.

**EL RANCHO SCHOOL.** South San Francisco. South San Francisco Unified School District, South San Francisco, owner. Single story frame and stucco new elementary school; 7-classrooms, administration, kindergarten, multi-purpose, kitchen and toilet rooms, \$289,982. ARCHITECT: Leslie G. Irwin, San Francisco. GENERAL CONTRACTOR: E. H. Moore & Son, San Francisco.

**ELEMENTARY SCHOOL.** Millbrae. Millbrae Elementary School District, Millbrae, owner. Frame and stucco new Glen Oaks Elementary School; 8-classrooms, kindergarten, administration, kitchen, multi-purpose rooms, and toilet rooms, \$221,892. ARCHITECT: Falk & Bach, San Francisco. GENERAL CONTRACTOR: Joel Johnson & Son, San Francisco.

designed  
with

## SCHOOL CLASSROOM IN MIND!

### HAWS Sink-Type Drinking Faucet Receptor



School classrooms may differ widely in their requirements. Realizing this, the new HAWS Sink-Type VANDAL PROOF Drinking Faucet Receptor was designed to accept practically any combination of HAWS Pantry Faucets—or Fill Glass Faucets—and HAWS bubbler-type Drinking Fountains.



● The HAWS Receptor is cast iron—beautifully finished in acid resisting white enamel. Stainless steel mounting rim prevents water running onto table or cabinet top and affords a water tight bond between sink and top surface.

Write today for brochure illustrating combinations of HAWS fixtures that may be utilized with Receptor. You'll find a combination to fit the school job you have on the board or are now planning!

**HAWS**

**DRINKING FAUCET CO.**

1441 FOURTH STREET (Since 1909) BERKELEY 10, CALIFORNIA

## SLEEPERS

**UNI-BOND—PRECAST—  
PERMANENT—NEVER ROT—  
PERMANENTLY  
NAIL PENETRABLE  
FIRE PROOF  
SECURELY BONDED TO  
THE CONCRETE SLAB**

**Make Solid Non-Squeaking  
Permanent Wood Flooring**

Used in spring floor construction for Gymnasiums and dance floors, also under solid wood floor construction. Spaced on any centers desired. Specifications and information available on request.

Territories open for qualified representatives. Free consultation service.

**LeROY OLSON  
COMPANY**

3070 Seventeenth Street,  
San Francisco, California



**APARTMENT BLDG.** West Los Angeles. Zundel Katz, Los Angeles, owner. 2-story, 15 family, 52 room, frame and stucco, apartment bldg.; composition roofing, oak linoleum and ceramic tile floors, interior plaster, insulation, individual gas water heaters, forced air heating units, tile baths and stall showers, electric bathroom heaters, stone veneer, sliding wardrobe doors, fireplace, garbage disposal units, built-in breakfast nooks, dishwashers, ceramic tile splashes and drains, steel casements, sliding plate glass doors, \$110,000. ARCHITECT: Herman C. Light, Los Angeles. CONTRACTS: By owner.

**CHURCH.** Inglewood. Holy Trinity Lutheran Church, Inglewood, owner. Frame and stucco auditorium and classroom building; Spanish tile roof, concrete slab floor, plaster and acoustic tile, toilets, electrical work, steel sash, forced air heating. ARCHITECT: John J. Landon, Los Angeles. GENERAL CONTRACTOR: Fred Olson, Los Angeles.

## IN THE NEWS

### ARCHITECT SELECTED

The architectural firm of Warnecke & Warnecke and the architectural firm of Carlett & Anderson, both of Oakland, have been selected by the Port of Oakland Commission to draft plans and specifications for the construction of a new passenger terminal building at the Oakland Municipal Airport.

It is estimated the cost of the new structure will be \$3,500,000.

### WINS ALASKA ARMY AWARD

The S. S. Mullen Company of Seattle were low bidders on proposed construction at the Etelson Air Force Base in Alaska with a bid of \$395,110. Government estimates on the job was \$373,365.

The work comprises construction of a two story communications center.

### SAN FRANCISCO FIRM BUILDS PLANT IN EAST

The Western Condensing Company of San Francisco has entered into a contract with the Luria Engineering Company of Bethlehem, Pa., for the construction of a 25,600 sq. ft. standardized steel warehouse in Appleton, Wisconsin.

The new facilities will serve as a mid-western sales and distribution center for the dairy by-products manufactured from whey.

### GAR WOOD NAMES MARK L. SHEPARD

Mark L. Shepard has been named manager of the Richmond (California) Division of Gar Wood Industries, according to an announcement by E. F. Fisher, president.

He succeeds J. B. Steed who has been transferred to the Wayne, Michigan, plant.

### APPOINTED DISTRIBUTOR

A. H. Scheffer, sales manager of the Chambers Company of Shelbyville, Ind., announces appointment of the Quality Television Corp., Los Angeles, as distributor for the Chambers console ranges and built-in equipment for the Los Angeles area.

Jack N. Smith is president of the Los Angeles organization.

### PORCELAIN ENAMEL INDUSTRY CONFERENCE

The uses of porcelain enamel as a large scale structural material will be the subject of a two-day Conference, November 12-13 at the National Academy of Sciences, Washington, D. C. The conference is under the sponsorship of the Porcelain Enamel Institute and the Academy's Research Advisory Board.

Four major sessions are scheduled and will consider 1) analysis of chemical and physical properties of porcelain enamel, 2) architectural applications of the material, 3) engineering properties and methods of sealing and insulating, and 4) its uses in combination with other materials.

Leading technicians, architects, contractors and industrial leaders will be represented at the meeting and take part in all programs.

### FIRE HOUSE FOR RENO

The City of Reno, Nevada, will build a new fire house, according to plans announced by the City.

The architectural firm of Ferris & Erskine, Reno, will design the plans. Estimated cost of the construction will be \$50,000.

### NEW HOSPITAL ADDITION

The Greater Bakersfield Memorial Hospital Association has announced plans for the construction of a new 103-bed hospital building in Bakersfield.

Plans for the building which will cost an estimated \$2,100,000 are being prepared by the architectural firm of Stone & Mulloy and S. P. Marracchini of San Fran-

cisco, and comprise a 2-story reinforced concrete structure of 58,000 sq. ft.

### BIG DEVELOPMENT FOR BURLINGAME

The Calview Realty Company of Los Angeles has announced plans for the immediate development of the old Mills property in Burlingame, California, into a combined residential, commercial, and industrial project.

Plans call for the construction of 2,500 residences of all types, a shopping center, and numerous facilities.

Plans are being prepared by Earl P. Wiley Company, Civil Engineer, and contract for construction has been awarded to the Trousdale Construction Company of Los Angeles.

## LOFT TO LEASE

30' x 40'

305 Grant Ave. — Corner Sutter

Suitable for Architect or Engineer

You will like the light and the rent!!

Telephone GARfield 1-2060



153 Sutter St.

San Francisco 4



*Built-in telephone facilities will make a hit with your clients*

Your clients will appreciate your thoughtfulness if you include built-in telephone facilities in your building plans. Concealed conduit for telephone wiring and conveniently located telephone outlets allow them to change the position of their telephone without detracting from the beauty of their home with exposed wiring.

Just call Pacific Telephone's free Architects and Builders service. We'll be glad to help you plan for better living tomorrow in the homes you are building today.

*Put built-in telephone facilities in your plans*



**Pacific Telephone**

## SACRAMENTO ANGLO BANK

The Anglo California National Bank will soon start construction of a bank building in Sacramento.

Plans, being prepared by architect Harry J. Devine, AIA, call for a single story reinforced concrete structure which will cost approximately \$354,000.

## OFFICE BUILDING FOR AZUSA

Architects Smith & Williams of Pasadena are completing plans for the construction of a new office building in Azusa for R. K. Merritt & Associates.

The structure will have a composition gravel roof, concrete slab, plywood and flexboard walls, radiant heating, and will contain 2000 sq. ft.

## MEDICAL BUILDING

Architects Riley & Levanos of Whittier are completing working drawings for the construction of a 1-story, reinforced brick

medical building to be built in Whittier for Dr. William F. Kroener.

The building will contain 4500 sq. ft. of floor space, built-up composition roofing, steel sash, concrete slab floor, and air conditioning.

## RESEARCH ENGINEERING DIVISION IS FORMED

Henry P. Sanders, engineering designer, has been appointed Director of the Research Engineering Division of Steelbilt, Inc., according to an announcement by W. C. Watkins, president of Steelbilt.

Product improvement, new product development and supervision of laboratory testing facilities will be under the direction of Sanders.

## NOVESKI APPOINTED SALES MANAGER

Joseph L. Noveski has been appointed National Sales Manager for the Sunbeam Lighting Company of Los Angeles, according to Philip Freeman, Sunbeam president.

Noveski has a broad background in the

electrical supply and lighting equipment field being formerly District Supply Sales Manager for the General Electric Supply Company in the Los Angeles area, including Tucson and Phoenix, Arizona.

## NEW MEXICO ADOPTS HIGHWAY BUDGET

The New Mexico State Highway Department has approved a 1953-54 highway budget of \$32,165,000, which is slightly less than the \$32,792,600 set up by the Arizona State Highway Department for the same period.

Major expenditures include: Federal construction, \$12,519,593; State construction (municipal arterial, \$1,600,000); rights of way and secondary roads, \$3,000,444; Road maintenance, \$5,433,720; Engineering, \$2,716,500; General administration, \$465,625; Planning and research, \$244,125; Debt interest principal \$2,003,000; and Debt interest, \$276,000.

## ARCHITECT SELECTED

The architectural firm of Swartz & Hyberg of Fresno, has been selected by the City of Hanford Trustees to draft plans and specifications for the construction of a new Fire House building.

Plans call for a 1-story, 16x84 ft. addition to present firehouse facilities.

## APPOINTED WEST COAST MANAGER

D. L. Bohon has been named west coast manager of the DeVilbiss Company and will assume complete charge of all west coast operations, according to an announcement by Henry M. Kidd, vice president and sales manager of the company's spray painting equipment division.

Bohon fills the vacancy created by the retirement of Charles E. Fosler who has been with the company for 22 years.

Other executive changes announced included J. W. Dayton to west coast district sales supervisor and L. C. Buckmaster, Santa Clara branch supervisor.

## LAS VEGAS HOTEL IMPROVEMENTS

Architect Arthur Froelich of Los Angeles, is completing plans for the construction of a new wing and breakfast room fronting on the swimming pool, and relocating of the Casino, for the Hotel Last Frontier in Las Vegas, Nevada.

The new wing will have accommodations for 100 guests and will be styled in a Western theme. Cost of the project is estimated at \$1,500,000.

## CHESTER W. BIRCH NAMED CONTROLLER

Chester W. Birch, assistant controller, has been elected controller of the L. J. Mueller Furnace Company, Milwaukee, Wis., succeeding Harry Wirth who passed away on June 30.

Birch is chairman of the Milwaukee Chapter of the Wisconsin Society of Certified Public Accountants, and a member of the American Institute of Accountants.

## COUNTY FIRE STATION

The Ventura county board of supervisors approved purchase of property in Melners Oaks, near Ojai, to be used as the site for a new County Fire Station.

## JOINS STAFF OF WELTON BECKET

Jack B. Beardwood, Portuguese Bend,

MECHANICAL                      ELECTRICAL                      INDUSTRIAL

## GEORGE S. ERSKINE & ASSOCIATES

CONSULTING ENGINEERS

1618 EL CAMINO REAL  
MENLO PARK, CALIFORNIA

PHONE COLLECT DAVENPORT 3-1396

TWENTY SEVEN YEARS    ::    FOUNDED 1926

## VALUABLE NEWS SERVICE

- BUILDING MATERIAL DEALERS
- CONTRACTORS
- SUB-CONTRACTORS
- MANUFACTURERS AND REPRESENTATIVES

**ARCHITECTS REPORTS** gives advance news on construction projects in Northern California, lists: name of projects, location, architect, proposed cost and other pertinent information.

**HANDY** individual slip-reports, issued daily at a total cost of only

\$10 a month

## ARCHITECT'S REPORTS

Published Daily

The ARCHITECT and ENGINEER, Inc.

68 Post Street, San Francisco - DO 2-8311

**CLASSIFIED  
ADVERTISING**  
Will Bring Results  
—USE—  
**ARCHITECT  
and  
ENGINEER**

68 Post St. San Francisco

**MULLEN MFG.  
COMPANY**

BANK, STORE AND OFFICE  
FIXTURES—CABINET WORK  
OF GUARANTEED QUALITY  
CHURCH SEATING

Office and Factory  
60-80 RAUSCH ST., Bet. 7th and 8th Sts.  
San Francisco  
Telephone UNDERhill 1-5815

**E. H. MOORE & SONS**

GENERAL  
CONTRACTORS



693 MISSION STREET  
SAN FRANCISCO

*Fine*  
**ENGRAVINGS**

**POOR  
RICHARD**  
PHOTO ENGRAVING CO.  
320-324 COMMERCIAL STREET  
SAN FRANCISCO, CALIF.

California, and formerly with the U.S. Department of Health, Education and Welfare, Washington, D. C., has been appointed Administrative Associate of the architectural firm of Welton Becket & Associates of Los Angeles, according to an announcement by Welton Becket, F.A.I.A., head of the firm.

Prior to joining the Palo Verdes Corp., in 1949, Beardwood was for 15 years active in newspaper and magazine work.

**TERMINAL BLOCKS  
WITH HINGED COVER**

A new heavy duty moulded terminal block with non-separable hinged cover which provides effective added protection to control and circuit wiring has just been introduced.

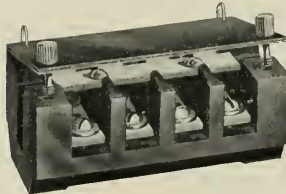

Manufactured by the Buchanan Electrical Products Corp. of Hillside, New Jersey, the blocks are available in either screw or solderless type contacts, and in 4, 6, 8, or 12 circuit sizes with either plain or numbered marking strips. Conservatively rated at 750 volts, 35 amperes (screw type) and 750 volts, 50-amperes for the solderless type.

**SITE PURCHASED  
FOR SAFEWAY**

The Bramwell Construction Company of Oakland, a division of the Safeway Stores, has acquired a site near the City of Santa Clara, Winchester Road and Stevens Creek, and will build a new Safeway Store.

**ARCHITECT  
SELECTED**

The architectural firm of Coates & Metz, A.I.A., Fresno, has been selected by the Fresno County Board of Supervisors to draft plans and specifications for the construction of a Hall of Records addition to the County Court House.

The proposed construction will be the addition of a 4th floor to the present 3-story building. Estimated cost will be \$325,000.

**NEWSPAPER  
BUILDING**

Architect Wm. Hastrup of Fresno is completing plans for the construction of a new newspaper building to be built in Fresno for the Fresno Guide.

The new building will contain 10,000 sq. ft. of floor space; 1-story and mezzanine; reinforced brick, concrete floor, wood roof with composition roofing.

**REPRESENTATIVE  
IS NAMED**

Donald Colburn has been appointed district sales manager of Alsynite Company of America for Southern California and Arizona, according to W. D. O'Morrow, sales manager of the San Diego plastic building material manufacturing firm.

Colburn will maintain offices in Hollywood, California. He was formerly associated with the Owens-Corning Fiberglas Corp. in an executive sales capacity.

**DINWIDDIE  
CONSTRUCTION  
COMPANY**  
•  
**BUILDERS**  
•

CROCKER BUILDING  
SAN FRANCISCO



**HERRICK  
IRON WORKS**  
STRUCTURAL STEEL  
REINFORCING STEEL

18TH AND CAMPBELL STS.  
OAKLAND, CALIF.  
Phone GLencourt 1-1767

Phone GARfield 1-1164

**Thomas B. Hunter**  
DESIGNER OF HEATING

AIR CONDITIONING  
VENTILATING AND WIRING  
SYSTEMS, MECHANICAL  
AND ELECTRICAL EQUIP-  
MENT OF BUILDINGS

☆  
41 SUTTER STREET  
ROOM 710

San Francisco California

Subscribe  
Now —

**ARCHITECT  
and  
ENGINEER**

\$3.00  
Per Year



**ABBOTT A. HANKS, INC.**  
**Engineers & Chemists**

INSPECTING — TESTING — CONSULTING  
 CONCRETE • STEEL • MATERIALS  
 CHEMICAL AND TESTING  
 LABORATORIES  
 • RESEARCH AND INVESTIGATION •  
 TESTS OF STRUCTURAL MATERIALS  
 DESIGN OF CONCRETE MIXES  
 SHOP AND ERECTION INSPECTION OF  
 STRUCTURES AND EQUIPMENT  
 INVESTIGATION OF STRUCTURES  
 AND MATERIALS  
 TESTS AND INVESTIGATION OF  
 FOUNDATION SOILS  
 FIRE RESISTANCE AND INSULATION  
 TESTS

624 Sacramento Street, San Francisco

**PITTSBURGH  
 TESTING LABORATORY**

**ENGINEERS AND CHEMISTS**

Testing and Inspection of Concrete,  
 Steel and Other Structural Materials

Design of Concrete Mixes

Offices in all principal cities

651 Howard St., San Francisco 5  
 EXbrook 2-1747

**MATTOCK  
 CONSTRUCTION  
 COMPANY**



**BUILDERS**



604 MISSION STREET  
 SAN FRANCISCO

**ARCHITECT  
 and  
 ENGINEER**

Please enter my subscription for  
 ..... year. My check in the  
 amount of \$..... is attached.

1 year . . . . . \$3.00  
 2 years . . . . . 5.00

Name .....

City.....

State.....

**Index to Advertisers**

ARCHITECTS Reports ..... 46  
 BARRETT & HILP, Contractors ..... 35  
 BETTANCOURT, J., Gen. Contractor 35  
 BLATTEIS Realty Co. .... 45  
 BY-CHEMICAL Products Co. .... \*

CALIFORNIA Metal Enameling Co. 31  
 CLAY Brick & Tile Association ..... \*

CLASSIFIED Advertising ..... 43  
 CLINTON Construction Company 36  
 DINWIDDIE Construction Company 47  
 ERSKINE, Geo. S. & Associates ..... 46  
 FINK & Schindler, The, Co. .... 32  
 FORDERER Cornice Works ..... 35  
 GENERAL CHEF ..... 3  
 GLADDING, McBean & Company ..... \*

GREENBERG'S, M. Sons ..... \*

HANKS, Abbott A., Inc. .... 48  
 HAAS & Haynie, Contractors ..... 36  
 HAWS Drinking Faucet Co. .... 44  
 HERRICK Iron Works ..... 47  
 HOGAN Lumber Co. .... 36  
 HUNT, Robert W. Company ..... 48  
 HUNTER, Thos. B. .... 47  
 INERTOL Co., Inc. .... 33  
 IDEAL Cement Co. .... \*

JOHNSON, S. T. Co. .... 34  
 JUDSON, Pacific-Murphy Corp. .... 36  
 KRAFTILE Company ..... 26  
 MARBLE Institute of America ..... \*

MATTOCK Construction Co. .... 48  
 MICHEL & Pfeffer Iron Works, Inc.  
 ..... Back Cover

MOORE, E. H. & Son ..... 47  
 MULLEN Mfg. Co. .... 47  
 OLSON, LeRoy Co. .... 44  
 PACIFIC Coast Aggregates ..... 27  
 PACIFIC Manufacturing Co. .... 37  
 PACIFIC Telephone & Telegraph Co. 45  
 PARKER, Steffens & Pearce ..... 35  
 PITTSBURGH Testing Laboratory ..... 48  
 POOR Richard Engraving Co. .... 47  
 PORCELAIN Enamel (Architectural  
 Division) Publicity Bureau ..... 34  
 REMILLARD-Dandini Co. .... 48  
 REPUBLIC Steel Corporation ..... 37  
 SCOTT Company ..... 48  
 SIMONDS Machinery Company ..... 37  
 SMOOT-Holman Company ..... 32  
 SUMMERBELL Roof Structures ..... 33  
 U. S. BONDS ..... Inside Back Cover

VERMONT Marble Company ..... 37  
 WEST Coast Screen Co. .... 38

\*Indicates Alternate Months

**REMILLARD-DANDINI Co.**

**Brick and  
 Masonry Products**



400 MONTGOMERY STREET  
 SAN FRANCISCO, CALIF.

**Scott Company**

**HEATING • PLUMBING  
 REFRIGERATION**



San Francisco  
 Oakland  
 San Jose  
 Los Angeles

**FOR ADVANCE  
 INFORMATION**

**ON  
 BUILDERS  
 CONTRACTORS  
 ENGINEERS**

Get

**ARCHITECTS  
 REPORTS**

68 Post St. Phone  
 San Francisco DO 2-8311

**ROBERT W. HUNT CO.**

**ENGINEERS  
 INSPECTING TESTING**

**STRUCTURAL MATERIALS  
 CONCRETE MIX DESIGN  
 CHEMICAL ANALYSIS  
 EQUIPMENT**

PRINCIPAL CITIES  
 UNITED STATES • EUROPE  
 SAN FRANCISCO LOS ANGELES  
 PORTLAND SEATTLE

# ARCHITECT AND ENGINEER

BOOKS DEPARTMENT STORE

San Francisco, California



WILLIAM H. HARRIS  
JOHN J. HARRIS  
ARCHITECTS

*Beaudin*

ROBERT M. HARRIS and C. M. DEAST, A.I.A., ARCHITECTS

OCTOBER

1953



Willow Glen High School, San Jose  
Morsh, Smith & Powell, Architects

## *Steel Windows & Doors*

ARISTON Steel Windows and Doors are especially designed and constructed to meet the particular requirements of each job.

*Arislide*

Michel & Pfeffer engineers are always available to assist architects in their preliminary and final plans.

## *Horizontal Sliding Doors*

- Fully Spring Bronze Weatherstripped
- Roller-bearing Bottom Rollers
- Smooth, Quiet Operation
- Bronze Handles and Foot Bolt
- Stainless Steel Capped Track



WRITE FOR LITERATURE: INQUIRIES INVITED

## **Michel & Pfeffer Iron Works**

N. K. JUVET, Manager Steel Window Division  
So. East Corner of So. Linden and Tanforan Avenues  
South San Francisco • Telephone Juniper 4-8362

Since 1912



# ARCHITECT

Vol. 195

No. 1

# AND ENGINEER

ARCHITECTS' REPORTS—Published Daily

## Contents for

# OCTOBER

**EDWIN H. WILDER**  
Editor

**J. WELLS HASTINGS**  
Contributing Editor

**PROF. LELAND VAUGHAN**  
Landscape Architecture

**JOHN A. BLUME**  
Structural Engineering

**MICHAEL GOODMAN**  
Planning

**JOHN S. BOLLES, A.I.A.**  
Book Reviews



### COVER PICTURE

**BROCK'S  
DEPARTMENT  
STORE**

Bakersfield, California

Robert N. Eddy and C. M. Deasy,  
A.I.A., Architects

Destroyed by earthquake, restored by modern architectural, engineering and construction design and materials . . . the new **BROCK'S** Department Store in Bakersfield, California, is an outstanding tribute to the construction industry of this modern age. For complete details of this project see Page 12.

*Photos by ROUNTREE*

**ERNEST McAVOY**  
Advertising Manager

*ARCHITECT & ENGINEER  
is indexed regularly by  
ENGINEERING INDEX, INC.*

EDITORIAL NOTES . . . . .	4
NEWS & COMMENT ON ART . . . . .	6
AUSTRALIA ENGINEERS PLAN JET AIRCRAFT AIRPORT— Sending Users Underground. Part II . . . . .	8
By JOHN LOUGHLIN	
CONCRETE MASONRY HOME COMPETITION—Winning Design . . . . .	10
KENNETH B. CLARK and LAWRENCE A. ENERSEN, Architects, Lincoln, Nebraska	
REHABILITATION OF BROCK'S DEPARTMENT STORE, Bakersfield, California . . . . .	12
By C. M. DEASY, AIA, Architect. ROBERT N. EDDY and C. M. DEASY, Architects; WILLIAM T. WHEELER, Structural Engineer; W. A. STAINS, Mechanical Engineer.	
EARTHQUAKE TESTS TO DETERMINE BUILDING ACCELERATIONS PRODUCED BY STRONG GROUND MOTIONS . . . . .	15
By DR. GEORGE W. HOUSNER, Prof. Civil Engineering, Calif. Inst. of Technology	
THE INSULATION OF UNDERGROUND STEAM LINES . . . . .	16
By GRANT AUSTIN, ME, Mgr. Underground Insulation Dept. Western Asbestos Co.	
ALTERATIONS OF BERNARD MOTORS, INC., Portland, Oregon . . . . .	17
MORGAN H. HARTFORD, AIA, Architect; PARKER-JOHNSON COMPANY, Contractors	
GENERAL OFFICES AND WAREHOUSE—Aluminum Lock Shingle Company, Portland, Oregon . . . . .	20
MORGAN H. HARTFORD, AIA, Architect; GEO. PETTINGELL & GRANT KELLEY, Electrical Engineers; R. O. BAER, Mechanical Engineer, and E. E. SETTERGREN, General Contractor.	
AN INVESTMENT BLUEPRINT for Architects and Engineers . . . . .	27
By FRANK KIME	
A.I.A. ACTIVITIES . . . . .	28
WITH THE ENGINEERS . . . . .	30
PRODUCERS COUNCIL PAGE . . . . .	32
Edited by STANLEY L. BASTERASH, Western Asbestos Co.	
PERSONALITIES . . . . .	34
RUSSELL MILLS, AIA Architect, Reno, Nevada	
BOOK REVIEWS, Pamphlets and Catalogues . . . . .	38
ESTIMATOR'S GUIDE, Building and Construction Materials . . . . .	41
ESTIMATOR'S DIRECTORY, Building and Construction Materials . . . . .	43
CONSTRUCTION CONTRACTS AWARDED and Miscellaneous Data . . . . .	44
BUILDING TRADES WAGE SCALES, Northern, Central & Southern California . . . . .	45
CLASSIFIED ADVERTISING . . . . .	45
IN THE NEWS . . . . .	47
INDEX TO ADVERTISERS . . . . .	50

**ARCHITECT AND ENGINEER** (Established 1905) is published on the 15th of the month by The Architect and Engineer, Inc., 68 Post St., San Francisco 4; Telephone EXbrook 2-7182. President, K. P. Kierulff; Vice-President and Manager, L. B. Penhorwood; Treasurer, E. N. Kierulff.

Los Angeles Office: Wentworth F. Green, 439 So. Western Ave., Los Angeles 5; Telephone DUnkirk 7-8135.

Entered as second class matter, November 2, 1905, at the Post Office in San Francisco, California, under the Act of March 3, 1879. Subscriptions United States and Pan America, \$3.00 a year; \$5.00 two years; foreign countries \$5.00 a year; single copy 50c. **ARCHITECTS' REPORTS** are published daily from this office, Vernon S. Yallop, Manager.

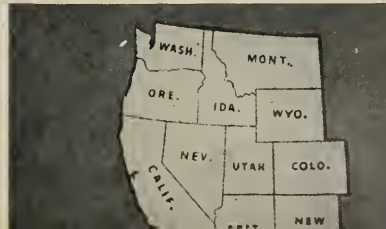

# EDITORIAL NOTES

## STRANGER THAN FICTION

Somewhere in the Aesops Fables' is a story about the left-handed man who didn't know what his right hand was doing, or visa versa.

Whether the man was right or left handed is probably immaterial, but there is an element of truth in the inference that the constructive effort of one hand may be nullified by the destructive effort of the other hand, and this situation may often apply to business institutions and professional organizations of today.

The untiring effort of a far sighted business executive to expand the scope of his firm's activities may be completely wiped out by the attitude of a few employees; the devotion of an individual professional man to build public confidence in the profession he represents, may be nullified by the actions of another member of the same profession. It's not an exception to the rule that such a thing occurs, in too many instances it's the rule.

\* \* \*

*Municipal taxes in the nation's 41 cities of 250,000 or more population averaged \$61 per person. In the District of Columbia where Congress is the taxing body, the average was \$128.61—highest tax in the nation.*

\* \* \*

## A GOOD NEIGHBOR

There is a way to be a good neighbor . . . a way to take care of the many who need all the help you can give.

The very young and the in-between, the troubled families, the older people, the ill and the handicapped, the men and women engaged in our national defense . . . their health and welfare is the first concern of the voluntary services that unite each fall in a campaign for funds to carry on their vital work.

Red Feather drives and united community campaigns in cities and towns all over the country will come to you this month for your contribution. When you give to your town's united health and welfare campaign you give to many causes . . . you give to many people in many ways.

GIVE GLADLY . . . THE UNITED WAY

\* \* \*

## FIRST YEAR OF CONSTRUCTION FREEDOM

A year ago construction was carried on in a controlled market. Materials were allocated, pri-

vate building was closely restricted, material prices were controlled, credit was controlled, rent was controlled, and wages were controlled.

Although the mounting materials production assured the end of controls sometime during 1953, government agencies—even late in 1952—were stating that this could not safely take place before the second half of the year.

The Eisenhower administration proceeded to dismantle the controls program. Mortgage credit controls were removed during the spring; materials controls were out by March; price and wage controls followed soon after; Federal rent controls went out in July, except in a few "critical areas."

So! Let's take a look at what happened under a free industry. The total dollar volume of construction activity during the first free year will exceed any year on record, thus continuing to an unexpected peak a spectacular eight-year rise, since the end of World War II.

The Department of Commerce estimates a year-end volume of more than \$34.6-billion of new construction activity and is conclusive proof that the Free Enterprise system is the Best System.

\* \* \*

## PAY-AS-YOU-GO HIGHWAYS

A number of Eastern areas have found that a partial answer to America's \$50-billion street and highway problem is the building of toll roads.

Perhaps if we are to finance properly a ten year program for an adequate highway system, the so-called "pay-as-you-go" program will develop into a vital, expanded role, in the American transportation program.

Exactly how large a part toll roads will play in solving the nation's major highway needs is still unknown, and many well qualified agencies and organizations are making extensive studies to determine the best approach to the fullest development of toll road possibilities.

Reactions of users and planners leave little doubt about the growing popularity of the idea. Mounting traffic figures and receipts on supertype, toll highways now in existence tell their own story. At least sixteen states have passed legislation for new or expanded toll highways in the past year, and new toll road work now under construction has been unofficially estimated at 1,000 miles, to cost some \$1.5-billion.

There are undoubtedly a number of situations in the West where toll roads could be constructed at an actual saving to motorists in general.



# WORLD'S SMALLEST COMPLETE KITCHEN!

ONLY 27½ INCHES WIDE!

Perfect For  
HOTELS APARTMENTS  
OFFICES FACTORIES  
INSTITUTIONS  
SMALL KITCHENS  
TRAILERS  
PATIOS

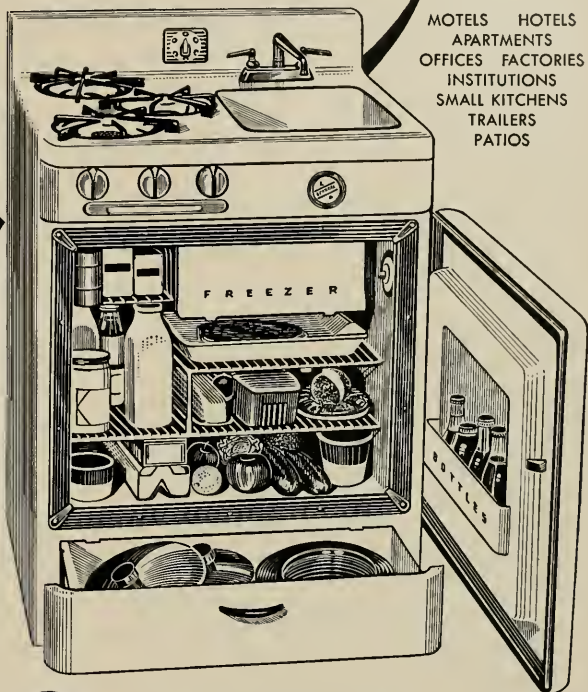

General Chef complete kitchen units fit in 5.4 square feet. The ideal solution wherever space and dollars are important.

**SINK** One-piece porcelain top of heavy gauge steel. Faucets and all hardware triple-chrome plated. Units also available without sink.

**BURNERS** Units come with 3 gas burners (easily adjusted for bottled, natural or manufactured [L.P.] gas), or 3 electric burners (220 V.) or 2 (110 V.).

**REFRIGERATOR** Four cubic feet of space. Electric (sealed, self-oiling Tecumseh unit). Owens-Corning Fiberglas insulation. Convenient bottle shelf in door.

**FREEZER** Holds 9 ice cube trays, or 12 standard frozen food packages.

**STORAGE DRAWER** Ample storage space for pots and pans.



## 5 YEAR GUARANTEE

Every General Chef Unit is guaranteed in writing to give trouble-free service for 5 years!

# General Chef

NATIONWIDE SALES AND SERVICE

NEW YORK: Dept. A, Suite 762, 11 W. 42nd St.; LOS ANGELES: Dept. A, 4536 E. Dunham St.  
CHICAGO: Dept. A, Room 1108, Merchandise Mart

**WRITE for complete information and specifications** if you are building, remodeling, designing — you will be interested in the space and money you can save with General Chef units. Several models are available. Fully guaranteed. **WRITE TODAY** for complete information and specifications on all General Chef units. We will also send you name and address of distributor nearest you.

GENERAL CHEF, Dept. A, 4536 E. Dunham Street, Los Angeles 23, Calif.

Please send me complete information and specifications on General Chef units, and name of nearest distributor.

NAME \_\_\_\_\_ STREET & NUMBER \_\_\_\_\_

CITY \_\_\_\_\_ ZONE \_\_\_\_\_ STATE \_\_\_\_\_





# NEWS and COMMENT ON ART



## SAN FRANCISCO MUSEUM OF ART

The San Francisco Museum of Art, War Memorial Building, Civic Center, is featuring exhibitions of Norwegian Serigraphs; a Design in Industry; Paintings by Alice Rahon Fitzgerald; and the 17th Annual Water Color Exhibition of the San Francisco Art Association during the month of October.

The regular Lecture Tours and Workshop activities are also included in the month's schedule of activities and events.

## CALIFORNIA PALACE OF THE LEGION OF HONOR

Located in Lincoln Park, San Francisco, under the direction of Thomas Carr Howe, Jr., a special group of exhibitions have been scheduled for October including an Exhibition of Japanese Folk and Provincial Art (from the Honolulu Academy);

Works of four contemporary artists, Jeremy Anderson, Ernest Briggs, Hassel Smith and James Weeks; Chinese Export Porcelain; Paintings by Helen Dunham; and Paintings and Watercolors from the Collection of J. Jerome Hill. Educational activities include painting classes, motion pictures, Organ recitals and television programs.

## M. H. deYOUNG MEMORIAL MUSEUM

The M. H. deYoung Memorial Museum, Golden Gate Park, San Francisco, under the direction of Walter Heil, is featuring an Art Exhibit of the South Pacific Islands during October. It is an important and comprehensive show of work assembled from Museums and Private Collections. Other special Exhibitions include Contemporary India Arts and Crafts; the 14th Annual Exhibit of the Society of Western Artists; and a showing of Contemporary Prints from France.



## M. H. deYOUNG

### MEMORIAL MUSEUM

Golden Gate Park, San Francisco

Canoe Prow Figure  
Central Solomon Islands

From Art of the South Pacific Islands—on important and comprehensive Show of 350 outstanding works, assembled from 20 museums and 19 foremost private collections.

Collection Nelson A. Rockefeller, New York

# Porcelain

## ENAMEL VENEER

ARCHITECTS: Robert N. Eddy and C. M. Deasy  
GENERAL CONTRACTOR: Guy E. Hall



*Why and how* Architectural Porcelain Enamel Veneer was used in recreating Brocks' Department Store in Bakersfield, California... severely damaged by earthquake, August 22, 1952... is best told in the Architect's own words.

"... the simplest and most effective treatment of the building face proved to be a continuous new skin broken only by new windows... only the very minimum of weight could be added to the old foundations, so the use of lightweight materials was mandatory. Almost 3500 square feet of Porcelain Enamel was used on the principal face and corner of the building, both as a background for the signs and as a means of establishing the scale of the building..."

*Ease of fabrication, lightness and lifetime retention of color makes ARCHITECTURAL PORCELAIN ENAMEL VENEER the one facing material that you can specify with complete confidence, always.*

*Architectural Division*

PORCELAIN ENAMEL PUBLICITY BUREAU  
P. O. BOX 186, EAST PASADENA STATION, PASADENA 8, CALIFORNIA  
ROOM 807, FRANKLIN BUILDING, OAKLAND 12, CALIFORNIA

• Write today for latest detailed information and color chart

\* From Notes by C. M. Deasy, A. I. A., Architect

# AUSTRALIA ENGINEERS PLAN JET AIRCRAFT AIRPORT SENDING USERS UNDERGROUND

PART TWO

By JOHN LOUGHLIN



Airport designers throughout the world are grappling with the problems of noise and blast nuisance from jet aircraft traffic; capital city airport model designed by Australia's engineers.

Mr. A. Hepburn, Director of Airports for the Australian Department of Civil Aviation, in discussing the engineered-planned development of the Commonwealth's commercial airports, to properly provide for present and future use of jet propelled aircraft, declares that "in the near future, although the landing areas will continue to be improved, more money will go into new buildings. The type of building in the passenger terminal area will be designed to meet the higher traffic density and the special requirements of jet aircraft. It will also remove such disabilities as the walk from terminal

buildings to the aircraft through bad weather and sorting of luggage in the rain.

"Such a building calls for original design. No structure has yet been erected to meet all the problems involved, and no such designs have been made public."

More airport buildings have been built in the United States since the war than in any other country, but the major airport designs were not applicable to Australian conditions, Mr. Hepburn asserted. In the American designs the solution of a traffic problem had to take second place to the need for raising revenue by increasing the number of "concessions" at an airport. Passengers had to be routed through the concession area.

"We believe that an airport terminal is essen-

(See Page 24)

---

*Editor's Note: This is the second and concluding installment dealing with planned handling of jet aircraft in commercial aviation. The first installment appeared in the September issue ED.*





# *Colorful* **CLAY BRICK** *saves taxpayers' money*

In selecting materials for Palo Alto's new City Hall, low cost of maintenance received utmost consideration, along with beauty, adaptability and permanence. Colorful Clay Brick supplied the answer... structural strength plus handsome appearance that will never require protection or embellishment. Thus Clay Brick, easy on the eyes and easy on the pocketbook, scores another achievement—for Architect Nichols, Palo Alto city fathers and the taxpayers.

**CITY HALL**  
*Palo Alto*

**Leslie I. Nichols, A. I. A.**  
*Architect*



*Inside or outside...*  
**A CLAY BRICK WALL**  
*... best finish of all*



## **CLAY BRICK & TILE ASSOCIATION**

SERVING NORTHERN CALIFORNIA

Affiliated with Structural Clay Products Institute

**55 NEW MONTGOMERY STREET, SAN FRANCISCO**

*In the interest of better brick and tile construction the following companies have contributed to the publication of this advertisement.*

KRAFTILE COMPANY  
L. P. McNEAR BRICK COMPANY  
PORT COSTA BRICK WORKS

REMILLARD-DANDINI COMPANY  
SAN JOSE BRICK AND TILE, LTD.  
STOCKTON BRICK AND TILE COMPANY  
UNITED MATERIALS & RICHMOND BRICK COMPANY

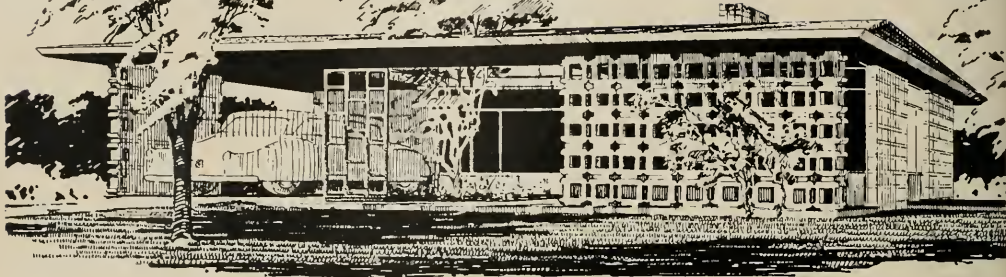

**CONSTRUCTION:**

Exterior Walls—8" concrete block, alternate courses conc. brick, painted.  
 Inside furred, with plaster or wood finish, or exposed.

Roof: Pitch 4 gravel, slope 2" in 12"

Floor: Conc. soffit tile, 2" conc. slab

Masonry Screen: Conc. pilaster block, conc. brick.

**INTERIOR FINISH:**

Room	Floor	Wall	Clg.
Living	Carpet	Pl. Conc. Bl.	Acous. Pl.
Dining	Tile	Wood	" "
Work-Play	Tile	Wd/Pl.	" "
Bedrooms	Carpet	Wd/Pl.	" "
Kitchen	Vinyl	K. Cem. Pl.	K. Cem. Pl.
Bath	Cer. Tile	Tile/Pl.	" " "

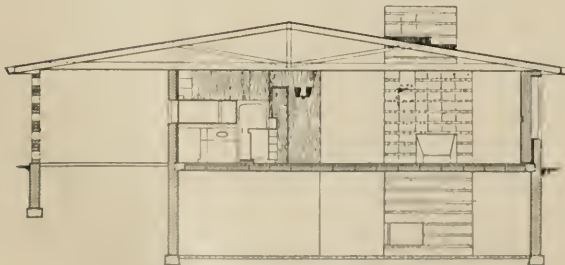

SECTION N.W. 1/4

**AREA:**

46' x 23' = 1058  
 16.4 x 8.5 = 138.8

# CONCRETE MASONRY HOME COMPETITION WINNING DESIGN

KENNETH B. CLARK and LAWRENCE A. ENERSEN

ARCHITECTS, AIA

CLARK & ENERSEN, Lincoln, Nebraska

Kenneth B. Clark and Lawrence A. Enersen, partners in the architectural firm of Clark and Enersen, Lincoln, Nebraska, were winners of first place and a \$1000 award in the Nebraska competition for the best new designs for small concrete masonry homes.

The award was announced at a quarterly meeting of the Nebraska Architects Association, chapter of The American Institute of Architects, which sponsored the competition with the Nebraska Concrete Masonry Association the donor.

A second place \$250 award was given to a design submitted by Sidney W. Campbell and Reginald E. Davies, associated with the firm of Unthank and Unthank of Lincoln.

Ten \$50 Awards of Merit were given to designs submitted by Alex Weinstein of Omaha; Clyde Bourgeois of Omaha; Mrs. Blanche Plunkett of Hastings; Ed C. Gross of Lincoln; Burkett E. Graf of Lincoln; John H. Aylor of Omaha; Woodrow Hull of Lincoln; James W. Nicas of Omaha; James

(See Page 36)



SOUTH ELEVATION 1/8" = 1'-0"

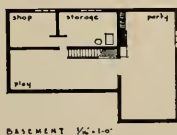

BASMENT 1/8" = 1'-0"

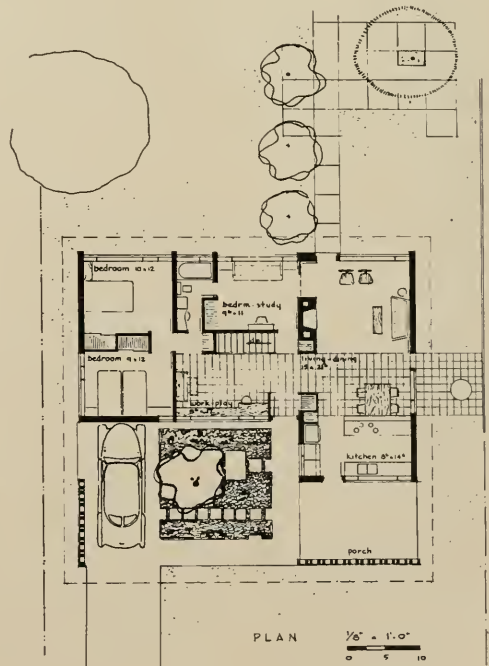

PLAN 1/8" = 1'-0"





**THIS IS BROCK'S DEPARTMENT STORE FOLLOWING DISASTROUS 1952 EARTHQUAKE**  
... Following Pictures Tell Rehabilitation Story

# REHABILITATION OF BROCK'S DEPARTMENT STORE

## BAKERSFIELD, CALIFORNIA

By **C. M. DEASY, AIA, Architect**

Within twenty-four hours after the big earthquake of 1952 that disrupted communication, transportation and the commercial activity of the lower San Joaquin Valley in California, the largest city to be effected, Bakersfield, began to dig out from under the tons of rubble that littered the city. Within a week the streets were cleared, dangerous structures evacuated and the city began to face the task of rebuilding.

Among major buildings seriously damaged was the four story building of Brock's Department Store. With the same kind of ingenuity and energy that had made this the largest department store in the San Joaquin Valley, the entire department store

operation was transferred to a huge circus tent until new quarters could be prepared.

Like many of the older reinforced concrete buildings in Bakersfield, damage to the Brock building was the result of very low strength concrete and lack of provision for seismic stresses. A painstaking study of the structure by Structural Engineer William T. Wheeler indicated that rehabilitation was possible and economically feasible by transferring part of the load from the low strength concrete to new very high strength gunite sections added to the beams and columns.

New gunite panels in certain of the old window openings provided the required resistance to seis-

ARCHITECTS: C. M. DEASY  
A. I. A. ROBERT N. EDDY

STRUCTURAL ENGINEER: WILLIAM T. WHEELER

MECHANICAL ENGINEER: W. A. STAINS

mic forces. It should be said here that a great part of the reconstruction program in Bakersfield could not have been achieved without gunite. Probably there is more gunite per square block in Bakersfield than any other city in the world and it is largely responsible for the amazing way the city has re-built since the disastrous shake.

Simply reinforcing the old building did not fit in with the Bakersfield determination to build a better city which the Brock executives thoroughly endorsed. A thorough face-lifting was also ordered. Having built a new and modern Men's Store beside the Department Store within the past five years, the problem was to bring the whole

**FORMER LARGE WINDOW AREAS FILLED WITH GUNITE . . . Porcelain Enamel Veneer Panels Being Installed To Form Continuous Outer Cover.**





**UNIQUE  
DESIGN  
DETAIL**

Initials of the store owner Milton Brock, "MB," are used to form interesting design on exterior of the building.

**MAIN FACADE**

Flood lighted at night presents on unusually attractive display.





block long structure into a unified design.

Due to the amount of structural reinforcing required and the number of window panels filled in with gunite, the simplest and most effective treatment of the building face proved to be a continuous new skin broken only by new windows at the fitting rooms and executive office areas.

The simplicity of this treatment on so large an area posed a problem of scale. For this reason two materials were used, cement plaster and porcelain veneer. Both were chosen because the weight factor was critical. Only the very minimum of weight could be added to the old foundations so the use of light weight materials was mandatory.

Almost fifty-five hundred square feet of porcelain enamel was used on the principal face and

corner of the building, both as a background for the signs and as a means of establishing the scale of the building. Large panels were used, three foot by four feet, with joints slightly emphasized. A bold spatter was applied over the base color of the panels to insure a surface quality that would read as porcelain enamel when seen at a distance. Over the regular grid of the panel joints another pattern of surface decoration was applied on alternate groups of panels in the form of an abstract set of initials.

Extending the Mens' Store marquee all around the Department Store, providing new show windows and a new face for the old building carefully coordinated with a structural rehabilitation have transformed this badly damaged building into a safe and thoroughly modern structure.

---

# EARTHQUAKE TESTS TO DETERMINE BUILDING ACCELERATIONS PRODUCED BY STRONG GROUND MOTIONS

By DR. GEORGE W. HOUSNER\*

Earthquake effect full scale tests to determine the building accelerations produced by strong ground motion, correlated with observations made from the 1940 El Centro (California) earthquake, and the recent Arvin-Tehachapi earthquake, have been made by the California Institute of Technology. The material herewith is confined to the tests and their results without venturing into the broad field of proper methods and factors for use in the design of earthquake-resistant structures.

Opportunity for the first test came with a decision to tear down a moderate sized reinforced concrete building in Los Angeles. This 40 foot by 125 foot structure had been designed with one row of interior columns and monolithic exterior walls and columns prior to realization of the importance of design for lateral forces other than wind. How-

ever the openings in the exterior walls were few in number, and nearly symmetrical.

The United States Coast and Geodetic Survey contributed many instruments for use in the tests as well as a rather unique "shaking" machine. Three wheels, only two of which turned in the same direction, were mounted on a frame and bolted to the fourth floor of the building. Eccentric weights were then mounted on these wheels such that an unbalanced horizontal force of 5,000 pounds could be applied with varying periods of vibration in a crosswise direction of the building, thus causing resistance to come primarily from the end walls.

The machine was deliberately designed so that only negligible unbalanced vertical forces were applied, for study has shown that the primary damage to structures in earthquakes occurs as the result of horizontal forces.

To estimate the amount of stress applied to the building, the natural periods of the building were first investigated. Large amplitudes of vibration

---

\*EDITOR'S NOTE: Dr. Housner is Professor of Civil Engineering and Applied Mechanics at the California Institute of Technology, and as an authority on engineering seismology, presented this material to members of the Structural Engineers Association of Southern California at a recent meeting.

were found at periods of 0.2 seconds, and of 0.4 seconds. With the shorter period, overall displacements of the magnitude of 0.10 inches were measured at the roof, corresponding to an acceleration of 3% "g", where "g" is the acceleration of a freely falling body under gravitational force.

The longer period demonstrated another interesting characteristic of buildings—that of torsion, or rotation of the floors. The machine had been placed off the center of the building to develop this motion, and accelerations of 4% "g" were measured. The machine thus produced motions in the building analogous to those of a small earthquake.

Opportunity for the second test came when the Minnesota Mining and Manufacturing Company planned to facilitate its operations by blasting a hillside near its Corona, California plant. Tunnels were driven up to 200 feet into the hill and filled with explosives at a location only 1,000 feet from the building selected for analysis during the blast.

It may be noted that such opportunities to obtain information on the actual motion of a structure are very helpful in determining the complex action of structures under lateral forces. The difficulties of trying to reconstruct the forces and motions causing the damage that is so often seen are obvious.

The three year old test structure consisted primarily of a sub-basement, a structural steel frame with a 6 inch concrete slab about 45 feet above the first floor, and 4 WF10 "X" bracing as the only resisting elements to lateral forces. The light super-structure and other characteristics of the building were such as to be negligible in comparison with the 200,000 pound weight of the elevated slab, and hence made the structure well suited to analysis in an effort to interpret the test results.

Strong ground motion of about 1 second duration, with 5 reversals, was measured in the sub-basement, and a maximum acceleration of 8% "g" was noted. During this period the amplitude of motion in the elevated slab built up through 10 reversals in about 2½ seconds, with a maximum of 11% "g" being reached somewhat before the maximum ground motion.

For comparative purposes it may be noted that many buildings have been designed on the basis of a lateral force of about 10% "g". However, the duration of the blast was only 1 second whereas most earthquakes have strong ground motions lasting 10 to 15 seconds or longer.

Computations to determine the particular properties of the building, particularly the damping characteristics, were made, and from these, esti-

mates of the motion of this building under actual earthquakes are possible. For example, with the 1940 El Centro earthquake, maximum ground accelerations of 30% "g" were found with a 25 second duration of strong ground motion, and would probably have resulted in an acceleration of 65% "g" on the elevated slab, if the structure would have taken these loads. Similarly the Arvin-Tehachapi earthquake with an 18% "g" ground acceleration might have produced 30% "g" in the elevated slab. This seems reasonable in view of the 11% "g" recorded in the slab under the effect of explosive charges located 1,000 feet from the building.

(See Page 40)

## THE INSULATION OF UNDERGROUND STEAM LINES

By **GRANT AUSTIN**  
Mechanical Engineer  
Mgr. Underground Insulation Dept.  
Western Asbestos Co.

Considering the general subject, "THERMAL INSULATION", it is probable that the specific field of underground installation is the most controversial. The inherent advantages of underground steam distribution versus overhead systems appear obvious. The greater problems involved are equally obvious.

Readily available in the market are numerous well designed and highly efficient thermal insulation materials, but such attributes in themselves do not necessarily insure satisfactory performance in underground installations.

In general, there are three types of systems available, all of which have mature experience records and can be described as follows:

1. The Split Tile Conduit.
2. The Pre-Sealed Conduit.
3. The Monolithic Conduit.

Underground pipe insulation systems must be designed to be adaptable to conditions often completely unknown until trenches have been opened. They must be designed to withstand conditions more destructive than installations of other types and be able to deliver year after year predictable efficiency and performance, with little or no maintenance expense.

Insulation designed for underground steam distribution systems must embody to the greatest possible degree, at least seven prime requirements. Not necessarily listed in the order of importance with the exception of requirement No. 1, they are as follows:

1. High in dielectric strength and as completely free from dissimilar metals in con-

(See Page 45)



BUILDING FOLLOWING COMPLETE MODERNIZATION

ALTERATION OF  
BARNARD MOTORS, INC.  
COMPLETE AUTOMOBILE AGENCY  
PORTLAND, OREGON

MORGAN H. HARTFORD, A.I.A. ARCHITECT

PARKER-JOHNSON COMPANY  
GENERAL CONTRACTOR



## BARNARD MOTORS, Portland . . .

A four story reinforced concrete building 115' x 121', built in 1911, located on an important intersection in Portland, Oregon, serves as an automotive distributing and display center and is known as Barnard Motors, Inc., Cadillac-Oldsmobile Agency.

The owners desired modernization of the structure and improved display for new cars. They stipulated that during the construction period, the premises must be maintained open for business as usual.

Consideration was given to various facing materials and structural glass was chosen because of relative light weight, minimum setting thickness, non fading color and permanence of polished surfaces and relative economy of application.

The entire concrete building was dressed down by removal of old fashioned belt courses, dentils, window trim and other outdated architectural embellishments. Cornice was streamlined and vaulted windows were squared off. Wood trim and old fashioned transom sash and wood entrances were removed.

New modern entrances and new full height plate glass display windows set in aluminum trim were installed. Terrazo steps with safety treads were installed at entrances.

Structural glass surfacing was accomplished on the three upper stories by anchoring aluminum angles to black coated concrete. Structural glass is held in place by mastic and the aluminum angles support the vertical weight.

On the first story, vertical weight of structural glass is supported by concealed clip angles and the ashlar are held in place by mastic. The upper stories of the building were faced with polished Cactus Green and the first story with polished Jade Green. The coping and belt course are covered with moulded aluminum trim. An ornamental aluminum pipe rail is mounted on the coping. Aluminum ribbon type letters are used across the face of building for the company name.

Existing wood windows of upper stories were painted green to match the color of first story structural glass. All neon signs were removed, reconditioned and painted two shades of green to harmonize with the two tones of green structural glass facing. The two shades of green selected approximate the official Cadillac Agency colors.

Steel pipe scaffolding was used for dressing the building down and for application of facing.

The Customer Service Department of Barnard Motors is located in a one story concrete 100' x 110' building built about 1920. The owners desired to modernize Customer and Employee's fa-

### APPEARANCE OF BUILDING PRIOR TO REMODELING PROGRAM





**CUSTOMER SERVICE DEPARTMENT**—Before alterations (top view) and the illustration below clearly shows architect's modernization of the office and customer service area as well as facilities for minor mechanical adjustments.

*Photos by Architect Morgan H. Hartford*



cilities in this Department and stipulated that business must go on as usual during alterations.

The alterations proceeded as outlined. Skylights were removed and decked over. Trusses were repaired and stiffened. A new roof was installed complete with necessary sheet metal work. A system of catwalks was installed connecting to roof deck hatchways. Next a system of wire and rod hangers was installed to support a metal channel grid system to which was hung a metal perforated insulated ceiling pan, painted white, known as Acoustisteel. Upon this surface was mounted the illumination system comprised of louvered fluorescent fixtures.

Temporary offices were built at one end of

building and used during construction of new facilities. A new overhead door with pedestrian pass was installed at entrance controlled by electric eye operators.

New Offices, Rest Rooms, Waiting Rooms were constructed and finished in white birch plywood. Asphalt tile floors were installed. Heating system was improved. New signs were added on exterior of building, which was repainted in light green with dark green trim.

Interior of main Service Department area received dark green ceramic tile wainscot with new plaster wall above painted light green. Upon completion of new offices, the temporary offices were removed and the renovation was completed.



## GENERAL OFFICES AND WAREHOUSE PORTLAND · OREGON

MORGAN H. HARTFORD, A.I.A., Architect  
GEO. PETTINGELL & GRANT KELLEY, Electrical Engineers  
R. O. BAER, Mechanical Engineer  
E. E. SETTERGREN, General Contractor



# . . . OFFICE & WAREHOUSE

## PLAN

Of Building showing the location of offices and storage area.

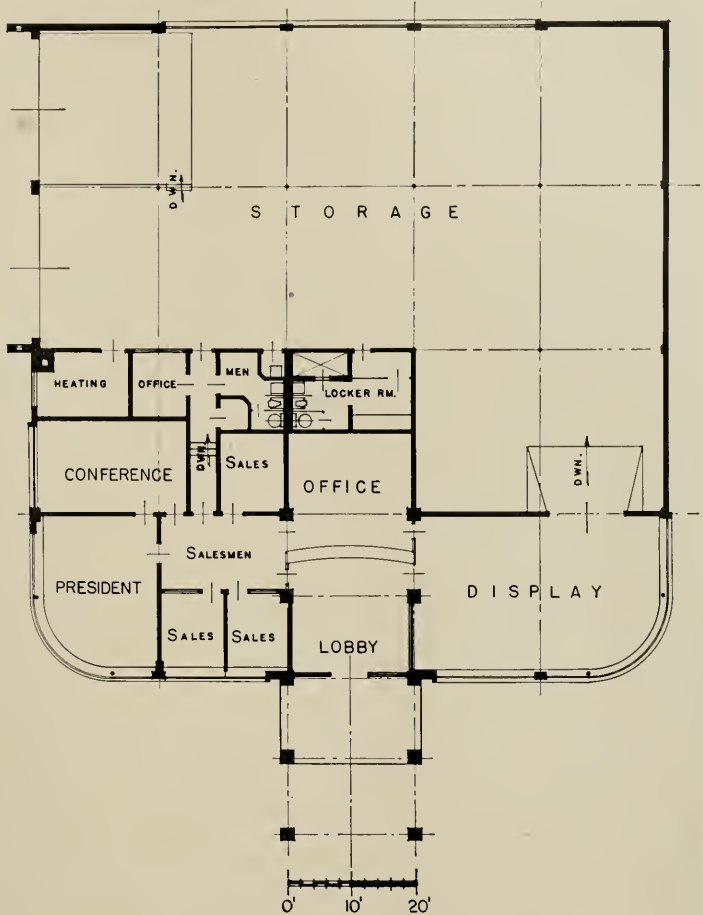

Photos by  
Morgan H. Hartford, A.I.A.,  
Architect

The new 100 x 100 one-story reinforced concrete combination sales office and warehouse of Aluminum Lock Shingle Corp. is a 10,000 square foot structure, together with fenced parking facilities, occupying a full city block at S. E. 7th and Powell Blvd., Portland, Oregon, with fronting on an important traffic arterial.

The building is of modern architectural design and provides offices for General Business, Sales, Shipping and Administration as well as expansive warehouse space with direct trucking facilities. Overhead truck doors are electrically operated. The plan features a combination walk and drive-in entrance covered by an illuminated canopy, which leads directly to a trim free standing all

glass and aluminum doorway connecting to a spacious reception lobby from which General Offices and Display Rooms can be visited. A handsome natural Birch curved counter with red and black plastic surface extends full width of Reception Area to receive visitors. The Reception Area is flanked by massive piers faced in rich red structural glass.

All ceilings are acoustical fibre board. Floors are asphalt tile with full carpeting in President's Office and Conference Room. Walls are painted plaster toned in pastel shades of gray-green and yellow and doors are natural Birch. Textured glass is used in Sales Office partitions.

Display Room ceiling is louvered aluminum

## OFFICE & WAREHOUSE . . .



**PRESIDENT'S OFFICE**—Large windows in circular form give light and feeling of spaciousness; acoustical tile ceiling, all modern installations for heating, cooling, ventilating. Top view.

**ILLUSTRATION** below is a view of the Display Room.



## . . . OFFICE & WAREHOUSE

aggregate with fluorescent lighting to provide the most even fall of light upon displays. Walls are to be decorated with murals featuring the use of the firm's Aluminum Lock Shingles.

The President's Office has a continuous curved window across two sides of the room. Walls are finished with natural matched Walnut Flexwood. Soft green carpeting extends from wall to wall. Ceiling is Acoustical Tile, windows are covered with aluminum venetian blinds and soft green draperies. Office furnishings are walnut leather and aluminum.

The exterior surface of building is waterproof stucco painted white with black structural glass trim. Green heat absorbing glass is used in office windows. Windows and Railings are aluminum. A protective marquee leads from parking area

across front window display to Main Entrance. Parking area and building are extensively landscaped and floodlighted.

A floodlighted four faced sign tower on the roof 50' wide and 60' high, advertises the Company's Products, as illustrated in the Architect's perspective on page 20.

Both Incandescent and Fluorescent Lighting recessed and surface types have been used throughout the building. A heating system composed of an oil fired hot water boiler circulating forced conditioned warm air through overhead anemostats and underground air returns, heats the building. Unit heaters are used in Warehouse. Auxiliary thermostatically controlled electric heat supplements the general system in Display Room and Lobby.

**NIGHT VIEW of distinctive Entrance—use of large glass plate and overhead lighting adds to attractiveness of business offices.**





# AUSTRALIA ENGINEERS PLAN JET AIRCRAFT AIRPORT

## That Sends Users Underground (from page 8)

tially for handling traffic", said Mr. Hepburn. "If any other objective is allowed to interfere with the future increases in traffic it will eventually result in major and costly modifications to the original design."

"This does not mean that we should avoid the commercial aspects at our airports. There is every indication that they could yield considerable revenue which would eventually give financial relief to the aircraft operator or permit revenue to approach the Commonwealth annual outlay. Our new buildings will take every advantage of this aspect."

"In major airport planning, therefore, Australia cannot afford to follow the example of other countries, but must seek its own solution."

D.C.A. was seeking the following advantages in developing a passenger and express freight terminal:

Reduction of unpleasant features created by present and future aircraft by allowing access from road transport to aircraft by the shortest possible means, avoiding passing through weather conditions, avoiding blast, and reducing engine noise to a minimum.

Provide mechanical arrangements for loading and unloading freight, luggage and cabin services, thus eliminating most apron apparatus.

Reduce capital cost by reduction of the apron areas.

To achieve these features the lounge and concession area in the airport plan has been kept at the natural surface level and the apron has been formed at roof height.

The Australian airport design was original in its general arrangement, said Mr. Hepburn, but there was nothing new in the various features. All had been tried and proved in other transport services. Elevators formed a normal means of transport on the London tube, for example.

Handling of aircraft on the slopes and on the limited width of the holding positions had been tested successfully on full scale with aircraft now operating on Australian services.

The scheme, according to Mr. Hepburn, takes into account existing conditions, and those required in the near future to handle present jet aircraft. But like every other section of aviation, airport design must take care of the more distant future as well.

It would be safe to expect continuous improvements in aircraft until civil planes on long routes were in the sonic speed range.

Australia is in a position to build passenger terminals that will meet the needs of jet traffic. Its present runway systems, says Mr. Hepburn, will meet the requirements of existing aircrafts. But it will have to consider further extensions of runway lengths on all airports handling overseas traffic to provide for future aircraft developments.

Advantages of the new airport design were summed up by D.C.A. supervising airport engineer, Mr. N. L. Keyes. He detailed the following eight points:

The scheme provides a means of handling jet aircraft without expensive mechanical equipment.

It permits passenger access to the aircraft with complete protection from the weather.

Congestion on the loading apron is minimized by eliminating loading platforms and vehicles, steps and other paraphernalia.

It eliminates danger to aircraft from vehicular traffic on the apron.

A considerable saving in pavement cost should result from the reduced pavement area and smaller loading "coastline" required.

A compact arrangement of loading bays and passenger and freight handling facilities is possible.

The unit arrangement allows for expansion dictated by traffic density.

Mr. W. H. Pickford, superintending airport engineer, D.C.A., said that the terminal building shown in the drawings was designed around 18 aircraft loading positions, but the scheme would lend itself to stage-by-stage developments.

The apron or triple taxiway had been designed with a down-grade of three per cent at the 18 loading positions. This was sufficiently steep to enable any aircraft to roll without aid of motors, even against strong head winds. The aircraft would normally roll away from the chocked position and would be stopped at a holding point before entering the main taxiway. This holding position would be sufficiently far removed from other aircraft, buildings, and staff for the safe starting of jet motors.

Operation of the aircraft was described by Mr. Pickford in the following stages:

### Outgoing Passenger

The outgoing passenger would arrive at the air-

port by airline bus or private car, enter the building and await his call to an elevator.

#### **Outgoing Luggage**

Outgoing luggage would be off-loaded from the bus and passed by chute to the outward luggage station at basement level. Luggage deposited at the airline office immediately inside the entrance would also reach this room. It would then be loaded on to trolleys and wheeled in to the elevator for the particular aircraft position. For some types of aircraft, luggage would have to be taken off the elevator at apron level and loaded into the aircraft by forklift truck.

#### **Incoming Passenger**

The incoming passenger would step out of the aircraft into the waiting elevator and descend to the lounge to await the airline bus.

#### **Incoming Luggage**

Incoming luggage would be loaded into the elevator and taken to the inward luggage station in the basement by trolley or passed down a luggage chute to the inward luggage station. It would then be taken by luggage elevator to the luggage dispatch at the bus dock where it would be available to the passenger or be loaded into the airline bus.

#### **Outgoing Freight**

Outgoing freight would be brought into the airport and unloaded into the freight store at the truck bay. It would be trucked to the elevator and loaded into the aircraft.

#### **Incoming Freight**

Incoming freight would be off-loaded from the aircraft into the elevator and from there, carried on trolleys to the freight store.

#### **Incoming Aircraft**

The apron manager would be responsible for apron positions. The incoming pilot, when taxi-ing towards the terminal after landing, would be given his apron position. The position would be defined on the apron for day or night operations.

The apron would be fitted with a system of interlocking chocks to prevent accidents. The apron manager would have the chocks for the particular aircraft raised so that it could not pass its correct position. The pilot would then taxi his aircraft to the top of the grade and drift down to the correct position on the apron.

#### **Outgoing Aircraft**

When all loading operations on an outgoing aircraft were complete, the chocks would be lowered and the pilot would drift the aircraft down to the start position. At this point, sufficiently distant from buildings or staff, motors would be started. In the event of a complete engine failure, aircraft would be towed to a holding apron.

#### **Operation of the Apron Elevators**

The apron manager would arrange parking order of the various incoming aircraft, taking care

to ensure that his parking arrangements allowed aircraft to depart on schedule, irrespective of the order of their arrival.

Tests had shown that pilots ought to be able to follow the well defined center line provided for accurate taxi-ing and parking. The center line would be illuminated for night operation.

In some cases it might even be necessary to taxi an aircraft around the circuit and back into the top positions again, but these would be rare. Operation of the apron would be facilitated if aircraft were limited to say one hour on a loading position.

Spacing between elevators is 115 ft. This could be varied, within limits. It was decided on as it provided enough space for nearly all modern types to park one behind the other.

The lateral separation of taxiways of 140 ft. on the inner taxiway and 160 ft. on the outer taxiway would provide for a Stratocruiser to pass a Constellation, but all large aircraft of this kind would be kept on the outside taxiway. An overseas apron dealing with the larger types of aircraft would probably require some variation for both separation of taxiways and spacing of elevators.

A movable section of the apron which would cover the elevator well, would need to be designed to support aircraft loading. Its movement would also have to be co-ordinated with the elevator movement and for both movements to be governed by sufficient safety devices to prevent possible accident.

#### **Refuelling Facilities**

Refuelling would be carried out by a high pressure hydrant system. Storage tanks would be located on the airport side of the apron and would be filled by mobile tankers. Aircraft would be refuelled by a small mobile hose and meter unit attached to the hydrant at each aircraft station.

#### **Ambulance and Fire Fighting Units**

These units could be located on the outside extremities of the apron which would command a good view of the airport and give quick access to all parts of the field.

#### **Stand-by or Freight Apron**

A stand-by or small freight loading apron could be provided close to the terminal apron. Freight loading normally takes longer than passenger loading.

One criticism so far levelled at the project is that it does not permit enough flexibility in handling traffic on the apron. But complete flexibility—the ability to withdraw aircraft from any position—would necessitate spreading aircraft parking positions and thus lengthening the apron, or would require the use of mechanical means. These alternatives were not acceptable, and it was decided that it would be better to suffer some problematical minor inconvenience to gain the obvious ad-

vantages. With intelligent operation, it is considered that the arrangement of 18 positions will provide for 40 aircraft movements per hour on the runway with maximum holding times of one hour on the apron and also give sufficient flexibility.

Another criticism pointed to the major earthworks involved and questioned the cost of the scheme. D.C.A. points out that while the earthworks are big in terms of methods of 30 years ago, today, using modern earthmoving equipment, the cost would be less than five per cent of the total cost of the project.

(Conclusion)

---

## **GLADDING, McBEAN & CO.**

### **BUY ANGELENO TILE CO.**

Availing itself of an opportunity to increase production capacity for glazed tile, Gladding, McBean & Company have acquired the land, buildings, machinery and equipment of the Angeleno Tile Co., 1704 Ruxton Lane, Redondo Beach, Fred B. Ortman, Board Chairman and President of Gladding, McBean Co., announced.

After the changeover in manufacturing techniques and raw materials, the output of the newly purchased plant will be sold under the name of Hermosa Clay Tile.

Sales activities will be under the direction of Verne W. Boget, Vice-President and Sales Manager of the Hermosa Division. Concurrent with the addition of production facilities, the Company will also manufacture and market a complete line of stainless steel drainboard cap, drainboards and other trim shapes for use with ceramic tile and other wall and floor coverings. These products will be sold under the name Selectsteel by the Hermosa Tile sales organization.

Constructed about four years ago the Redondo Beach plant is modern in every respect.

---

## **MORTGAGE CREDIT STILL BLOCK TO LOW COST NEW HOME MARKET**

Emanuel M. Spiegel, president of the National Association of Home Builders, emphasized, in a statement issued at the opening of the NAHB Directors Fall meeting in New Orleans, La., on October 10-11 that he is advising home builders not to start any new projects without firm financing commitments until there is unmistakable evidence that the mortgage drought actually has been broken.

"While there have been numerous hopeful signs of an improvement in the mortgage market in recent weeks, they have not yet been reflected at the builder end of the credit pipeline," he said.

"Home builders would be foolhardy to undertake any major operations at this time without solid assurance that the mortgage credit is available."

Spiegel said one of the most important recent developments has been the Eisenhower Administration's public acknowledgement that a strong home building industry is essential to the national prosperity and that the government has a responsibility for its continued vigor.

The NAHB President said that, while there has been no official word of a change in the Administration's "hard money" policy, recent market developments appear to indicate that Federal action in the coming months may be directed toward an easing of the credit supply.

"I am encouraged by signs of a growing sense of responsibility and statesmanship on the part of the great lending institutions upon which home building depends," he said.

Spiegel said most mortgage lenders recognize the prosperity of the housing industry and their own business depends upon the mass market which, in turn, requires a large volume of mortgage capital at terms the average American family can afford.

"It is the opinion of most observers that this sound judgment will prevail and excessive discount abuses, which have particularly hurt the middle and low income home buyer, will be eliminated in the near future," he said.

Given a stable mortgage market based on a stable Government fiscal policy, the home building industry can go forward with confidence to meet the still-unfilled demand of the American people for more and better housing in 1954."

---

## **ERIC MENDELSON FAMED ARCHITECT DIES**

Eric Mendelsohn, one of the pioneer greats of contemporary architecture who won international fame, died in San Francisco recently following a brief illness.

Mendelsohn, 66, was ranked with France's Le Corbusier and America's Frank Lloyd Wright in his professional career. Noted for scraping the gingerbread off buildings of the 19th Century, and designing structures for 20th Century living, Mendelsohn endowed his structures with sweep, breadth and light. What they lacked in orthodoxy, they gained in uncluttered space.

A native of Germany, he received his education in his native land. In 1919 he was commissioned



to build the Albert Einstein Tower in Pottsdam; in 1920's his Universum Cinema was built in Berlin. In 1933, Mendelsohn left Germany and took up residence in England where he practiced until 1941 when he came to the United States as consultant to the U.S. Department of War. He established residence in San Francisco in 1945 and among outstanding work is the Maimonides Health Center and the Hebrew Nursing Home, also designed by Mendelsohn were buildings at the University of California and structures in Palo Alto.

## CONSOLIDATION OF TWO ARCHITECTURAL OFFICES

Cejay Parsons, Architect, recently announced the consolidation of his architectural practice with the firm of Jack H. MacDonald, architect and engineer, in an association that will be known as Jack H. MacDonald & Cejay Parsons, Associated Architects and Engineers.

New headquarters of the firm will be located at 8943 Wilshire Blvd., Beverly Hills, with Los Angeles offices at 3123 W. 8th Street.

## STRUCTURAL ENGINEERS ADOPT UNIFORM JOB SIGN

Structural engineers throughout California who are members of the Structural Engineers Association have begun a cooperative program to identify their projects by use of a uniform job sign bearing the Association emblem.



Los Angeles engineer JOHN CASE points to newly designed "on the job" sign adopted by SEAC and appearing on construction projects throughout State.

throughout California is designed to make the public aware of the vital role the structural engineer plays in the West's vast building program. The structural Engineers Association of California is comprised of three groups—Southern, Central and Northern California.

## AN INVESTMENT BLUEPRINT for ARCHITECTS & ENGINEERS

By FRANK J. KIME

Lewis Albert Alesen, M.D., immediate past-president of the San Francisco Medical Society, is a small, dynamic physician with very definite ideas on the merits of individual liberty, versus the dangers of collectivism.

His conferees like and admire him; and about a year ago he concluded that too many young people were becoming inculcated with the virus of the welfare state, and, with characteristic energy and resolution, wrote his prescription. He sent a circular letter to key physicians throughout California in which he said in part:



FRANK J. KIME  
Consultant H. E. Work & Co.,  
San Francisco

"As you no doubt know, there are something over 1,500,000 marriages in this country each year... If, when called upon to make a gift to one of these young couples, instead of sending them the customary gold-plated towel-rack, or something else equally useless, we send a few shares of one of the lower-priced mutual investment funds, we shall have inserted an opening wedge in their thinking which can do much to help your country and mine return to economic and social sanity."

"These shares can be purchased in small denomination from your broker or banker. Each quarter thereafter, the young couple will receive a small dividend check and a statement of the trust operations for the preceding three months. Very soon, they will come to learn that what hurts business hurts them, and also what helps business helps them..."

Dr. Alesen's letters underscore the knowledge of mutual funds that characterizes most professional men and women and emphasizes the high regard in which these securities are held as investment media. Mutual fund shares evidence ownership of a corporation. In this they differ from bonds which evidence indebtedness.

A phenomena of the post-war period has been the growth of these funds. More than five billion dollars has been invested in the securities of some 150 mutual investment funds. Perhaps the most important reasons for this popularity are widespread diversification and sound selection of securities, and expert supervision and management.

The offering prices of mutual funds fluctuate with the market value of the investments they hold. There is also a sales charge, usually from 6% to 8%.

Shares of building and construction companies are prominent in the portfolios of many of these funds. The oldest and largest fund on June 30, 1953 held the following:

Shares	Common Stock	Market Value
34,000	Armstrong Cork Co. ....	\$1,836,000
75,000	Johns-Manville Corp. ....	5,550,000
67,500	Lane Star Cement Corp. ....	2,016,562
130,000	National Lead Co. ....	4,160,000
40,000	Pittsburgh Plate Glass Co. ....	2,547,250
32,000	Sherwin-Williams Co. ....	2,380,000
22,000	U. S. Gypsum Co. ....	2,579,500
10,000	Weyerhaeuser Timber Co. ....	697,500

Architects and engineers should find mutual fund shares of especial interest because of the emphasis placed upon building and construction securities by many funds. They should be able to evaluate the merits of the products manufactured by the various companies in the construction materials and maintenance fields.

Properly selected mutual funds are the ideal investment media for the architects or engineers who are accumulating a stake. Shares of many funds may be acquired on a periodic investment plan with a down payment of as little as \$20 and subsequent monthly payments of \$10 in one instance.

Just as each plan must be drawn for the needs of the particular client, so should the mutual fund selected, and there are more than 150 from which to pick, be the one best fitted for the needs of the individual architect or engineer.



Clair W. Ditchy, President  
 Norman J. Schlossman, 1st Vice-President  
 Howard Eichenbaum, 2nd Vice-President  
 George Bain Cummings, Secretary  
 Maurice J. Sullivan, Treasurer

National Headquarters—  
 1741 New York Avenue, N. W.  
 Washington, D. C.  
 Edmund R. Purves  
 Executive Secretary

#### Arizona Chapter:

Low Place (Tucson), President; Ralph Haver (Phoenix), Vice-President; Fred C. Knipe (Tucson), Secretary; James W. Elmora (Phoenix), Treasurer. Secretary Offices, 1324 E. Lester St., Tucson.

#### Coast Valleys Chapter:

Kurt Gross, President; Harold Ahnfeldt, Vice-President; Frank C. Treseder, Secretary; Jerome Kasavan, Treasurer. Directors: Hollis Logue and Gifford Sobey. Offices, 82 S. 3rd St., San Jose.

#### Central Valley of California:

John W. Bomberger, President; Nicholas Tomich, Vice-President; Albert B. Thomas, Secretary; Ted de Wolf, Treas.; Gordon Stafford, Director; Alternate to CCA, Silvio Barovetto; Sec. Office 718 Alhambra Blvd., Sacramento.

#### Colorado Chapter:

James M. Hunter, President, 2049 Broadway, Boulder; Casper F. Hegner, Secretary, 1659 Grant Street, Denver 5.

#### East Bay Chapter:

Malcolm D. Reynolds, President; Donald Hardison, Vice-President; John Lloyd, Secretary; Ed Cerruti, Treasurer. Directors: Chester Treichel, Ira Beals, Cecil Moyer. Secretary's office: 1171 Solano Ave., Albany.

#### Idaho Chapter:

C. V. Wayland, Boise, President; Cecil E. Jones, Twin Falls, Vice-President; Thomas M. I. Leake, Boise, Sec. Treas.; Anton Dropping, Boise, Exec. Comm. Member. Office of Secretary, Suite 405 Sun Bldg., Boise.

#### Montana Chapter:

E. Edward Sawcraft, President (Billings); J. Van Teylingen, Vice-President (Great Falls); H. C. Choever, Secretary-Treasurer. Secretary office, Bozeman.

#### Nevada Chapter:

Russell Mills, President, Reno; Harris P. Sharp, Vice-President, Las Vegas; E. Keith Lockard, Secretary, Reno; Edward S. Parsons, Treasurer, Reno. Directors: L. A. Ferris, David Vhay, Reno, and Walter Zick, Las Vegas. Office of President: 309 N. Virginia St., Reno.

#### Nevada State Board of Architects:

Russell Mills, Chairman, Reno; Aloysius MacDonald, Secretary, Las Vegas; Edward Parsons, L. A. Ferris, Reno, and Richard Stadlman, Las Vegas, Members. Office, 309 S. 5th St., Las Vegas.

#### Northern California Chapter:

Donn Emmons, President; Wendell R. Spackman, Vice-President; William Corlett, Secretary; Bernard J. Sabaroff, Treasurer. Directors: Charles S. Pope, Wm. Stephan Allen and Lawrence A. Kruse, Helen H. Ashton, Office Sec., Office, 26 O'Farrell St., San Francisco.

## SAN FRANCISCO ARCHITECTURAL CLUB SCHEDULES FALL CLASSES

The San Francisco Architectural Club, 507 Howard Street, have announced the schedule of classes in Engineering and Architecture for this Fall.

Classes in Structural Engineering for Architects, under the direction of George A. Sedgwick, offer a

*Remember it's*

# KRAFTILE

- for ★ GLAZED STRUCTURAL WALL UNITS
- ★ PATIO TILE
- ★ FACE AND ROMAN BRICK
- ★ ACID FLOOR BRICK
- ★ HEARTH BRICK
- ★ BRICKETTES
- ★ MINWAX TILE & CONCRETE FLOOR FINISH

For complete information and prompt service, phone or write



4-semester, 2-year course designed to prepare students for the structural section of the examination of the State Board of Architectural Examiners. Each semester consists of a minimum of 15-class meetings, one each week, starting October 1st.

A class in Architectural Specifications is being offered with Michael J. Sweeney, instructor, with 15-weeks devoted to consideration of the preparation of construction specifications with emphasis on materials and methods of construction. Complete information is available from offices of the San Francisco Architectural Club.

### OREGON CHAPTER

Regular meeting was held in conjunction with the Regional Convention in Sun Valley.

Announcement was made of appointment of Committees for 1953-54 and a number of Chairmen have already scheduled meetings to get their activities for the new year underway.

### SECOND ANNUAL CONFERENCE NORTHWEST REGIONAL COUNCIL

The Second Annual Conference of the Northwest Regional Council of the A.I.A. was held in Sun Valley, Idaho, October 9-11, with members of the Idaho Chapter of the A.I.A. serving as host Chapter.

Participating were architects from Washington, Oregon, California, and Idaho, with general seminar and business discussions devoted to pertinent phases of the practice of Architecture and the construction industry.

### PASADENA CHAPTER

"Developing Your Sales Personality" was the subject of a talk by C. C. Mullin of C. C. Mullin &

Orange County Chapter:  
Paul C. Davis (Los Angeles), President; Ralph Madjeski (Santa Ana), Vice-President; Geo. Lind (Newport Beach), Secretary; Wm. L. Faulkner (Santa Ana), Treasurer. Secretary's Office: 2919 Newport Blvd., Newport Beach.

Orcutt Chapter:  
Holman J. Barnes, President; Albert W. Hilgers, Vice-President; Donald W. Edmundson, Secretary; DeWitt C. Robinson, Treasurer, and H. Abbott Lawrence, Trustee. Office of Secretary, 325 Henry Bldg., Portland.

Pasadena Chapter:  
Robert E. Langdon, Jr., President; Wallace C. Bonsall, Vice-President; Robert L. Deines, Secretary; Henry C. Burge, Treasurer; and Directors John N. Douglas, R. VanBuren Livingston, Scott Quamin and Burton Romberger. Offices: 259 South Los Robles Ave., Pasadena 5.

San Diego Chapter:  
Donald Campbell, President; Victor L. Wulff, Jr., Vice-President; Richard L. Pinnel, Secretary; Edward G. Holliday, Treasurer; Louis A. Dean, Director. Office Sec., San Diego Trust & Savings Bldg.

San Joaquin Chapter:  
Maurice J. Metz (Fresno), President; Allastair Simpson, Vice-President; Al Bailey, Secretary; Robert Stevens, Treasurer. Directors: David H. Horn, Wm. Hyberg, Robert Kaestner. Secretary's Office, Fresno.

Santa Barbara Chapter:  
Miss Lutha Maria Rings, President; Roy C. Wilson, Vice-President; Chester L. Carjala, Secretary; Roy W. Cheesman, Treasurer. Carres. Sec.; Richard B. Nelson, 3033 Calle Rosales, Santa Barbara.

Southern California Chapter:  
Henry L. Wright, President; U. Floyd Rible, Vice-President; Carmelus M. Deasy, Secretary; Savo M. Stoshitch; Hugh R. Davies, S. Kenneth Johnson, Kemper Namland and Chas. E. Fry, Directors.  
Headquarters, 3723 Wilshire Blvd., Los Angeles 5.

Utah Chapter:  
W. J. Monroe, Jr., President, 433 Atlas Bldg., Salt Lake City; M. E. Harris, Jr., Secretary, 703 Newhouse Bldg., Salt Lake City.

Washington State Chapter:  
John S. Dettie, President; Ralf E. Decker, 1st Vice-President; Edwin T. Turner, 2nd Vice-President; Wendell H. Lovett,

Secretary, Arnold S. Gannes, Treas., Directors Paul Thiry, William I. Barr, J. Emil Anderson and Robert B. Price, Dayis Holcomb, Ex-Sec., 409 Central Bldg., Seattle 4.

Spokane Chapter:  
Tom Adkinson, President; Carroll Martel, Vice-President; Harry Welter, 2nd Vice-President; William James, Secretary; Lawrence Evanoff, Treasurer. Office of the Secretary, W. 524 - 4th Ave., Spokane.

Tacoma Society:  
E. N. Dugan, President; P. G. Ball, Vice-President; Lyle Swedberg, Secretary-Treasurer.

Hawaii Chapter:  
Kenji Onadera, President, 3518 McCristian St., Honolulu, T. H.; George J. Wimberly, Secretary, 315 Royal Hawaiian Ave., Honolulu, T. H.

CALIFORNIA COUNCIL OF ARCHITECTS  
Charles E. Fry, President, Los Angeles; Malcolm D. Reynolds, Oakland, Vice-President; Lawrence Gentry, Los Altos, Secretary; Louis A. Dean, San Diego, Treasurer; Fred A. Chase, Executive Secretary, 3723-A Wilshire Blvd., Los Angeles.

CALIFORNIA STATE BOARD ARCHITECTURAL EXAMINERS:  
Earl T. Heitschmidt (Los Angeles), President; Geo. P. Simonds (Oakland), Secretary; Norman Blanchard (San Francisco); C. J. Paderawski (San Diego); Ulysses Floyd Rible (Los Angeles). Exec. Sec.: Robert K. Kelley, Room 300, 507 Polk Street.

#### ALLIED ARCHITECTURAL ORGANIZATIONS

San Francisco Architectural Club:  
Joseph Scoma, President; Frank S. Gerner, Vice-President; Russell W. Pennell, Treasurer; Frank L. Barsatti, Secretary.  
Club Quarters: 507 Howard St., San Francisco.

Producers' Council—Southern California Chapter:  
Bert Taylor, President, Pittsburgh Plate Glass Company; G. Robert Raden, Jr., Vice-President, Truscon Steel Company; Malcolm G. Lowe, Secretary, Natural Gas Equipment Inc.; Richard Seaman, Treasurer, W. P. Fuller & Company; Vern Beget, National Director, Gladding McBean & Co.  
Producers' Council—Northern California Chapter (See Special Page)

Associates of Los Angeles at the October meeting.

Mullin's firm specializes in speech training courses for professional and business men and women.

#### NORTHERN CALIFORNIA CHAPTER

A number of special committee reports were made recently including Frank Ehrenthal on "Area Planning", which included San Francisco's "hot" Civic Center Plan; Bolton White on "Public Relations"; William Fox on "Codes", and Ralph Priestley's Committee on Building Types.

Charles Fry, President of the California Council of Architects also addressed the Chapter recently on the subject "California Council Activities" showing the CCA was extremely busy.

#### WASHINGTON STATE CHAPTER

An official Roster of membership in the Washington State Chapter, AIA, has been compiled and published. Listing of membership is broken down into various classifications and shows that the Chapter has a total membership at this time of approximately 343 members.

#### CALIFORNIA COUNCIL OF ARCHITECTS

The element of time prevents a complete report on Convention activities in Coronado, however, among major considerations of the four day conference is a plan for reorganization of the Council and adoption of an expanded state-wide program.

Recommended by the Council Board's Executive Committee was that the activities of the organization be separated into two separate functions, 1) Public Relations and Legislative, and 2) man-

agerial. The reorganization plan also calls for the employment of a new Executive Director, Frederic A. Chase present Council Executive Secretary having resigned to enter private field of public relations.

From all indications at the time of this writing,

(See Page 33)



**Two Building Tips  
That Are Really Pips!**

**DARACONE**  
*Invisible Water-Repellent*

Surest way to stop leaks, efflorescence and stains in brick, concrete, stucco. Daracone penetrates deeply into masonry, lining pores and cracks. Clear and colorless! Long-lasting!

**DAREX**  
**AEA**

World's leading brand of air-entraining agent! Concrete made with Darex places easier, finishes faster, is more durable! A trial will convince you!

*Distributed By*



**Pacific Coast  
Aggregates, Inc.**

CONTACT THE NEAREST P.C.A. SALES OFFICE  
SAN FRANCISCO OAKLAND SAN JOSE  
SACRAMENTO STOCKTON FRESNO



# WITH THE ENGINEERS

## Structural Engineers Association of California

John E. Rinne, President, San Francisco; Jack S. Barrish, Vice-President, Sacramento; Leslie W. Graham, Secretary-Treasurer, San Francisco. Directors John J. Gould, R. W. Binder, M. A. Ewing, Leslie W. Graham, Jack S. Barrish, Harold P. King, W. T. Wheeler, John E. Rinne and Donald F. Shugart. Secretary's office, c/o Associated Structural Engineers, 417 Market St., San Francisco 5.

## Structural Engineers Association of Northern California

George A. Sedgwick, President; Michael V. Pregnoff, Vice-President; John M. Sardis, Secretary; William K. Cloud, Treasurer; Robert P. Moffett, Asst. Sec.-Treas.; Directors, Robert D. Dalton, Robert D. Dewell, William H. Ellison, John J. Gould and J. Albert Paquette. Offices: 417 Market St., San Francisco.

## Structural Engineers Association of Central California

William H. Peterson, President; Walter S. Wassum, Vice-President; O. T. Illerich, Sec.-Treas.; Ernest D. Francis, M. A. Ewing, and Arthur A. Sauer, directors. Office O. T. Illerich, c/o Div. of Arch., Sacramento.

## American Society of Civil Engineers Los Angeles Section

Trent R. Dames, President; Stephenson B. Barnes, Vice-President; John M. Server, Vice-President; C. Martin Duke, Secretary, and John Merrell, Jr., Treasurer. Office of Secretary, 3066 Engineering Building, University of California, Los Angeles 24. BRANCHES: Orange County Branch, Harold Sprenger, Pres; Raymond R. Ribal, V-P; Earl K. Burdick, Sec-Tr, 12311 Chapman, Anaheim. San Bernardino-Riverside Counties Branch, Albert A. Webb, Pres; Wright M. Price, V-P; John L. Merriam,

## STRUCTURAL ENGINEERS ASSOCIATION OF CALIFORNIA

A number of outstanding speakers appeared before members at the Annual Convention in Yosemite, and at this time details of the conference were not available. However, scheduled to appear on technical programs were:

Verne Ketchum, Chief Engineer, Timber Structures, Inc., Portland, Oregon; T. R. Higgins, Director of Engineering, American Institute of Steel Construction, Inc., New York City; Arthur R. Anderson,

The Concrete Engineering Co., Tacoma, Washington; J. T. Silveria, manager Pacific Fire Rating Bureau, Los Angeles; Prof. N. M. Newmark, Research Professor of Structural Engineering, University of Illinois; Frank B. Durkee, Director of Public Works, State of California, and Charles M. Herd, Principal Structural Engineer, State of California, Division of Architecture.

Also scheduled for consideration was a panel discussion on "Human Relations in Engineering Practice"—John E. Rinne, President SEAOC, and Jonathan G. Wright, participating.

A more complete report on the Convention will be given in a later issue of A&E.

for CONSISTENCY,

ALWAYS SPECIFY **H A W S**  
ELECTRIC  
WATER  
COOLERS

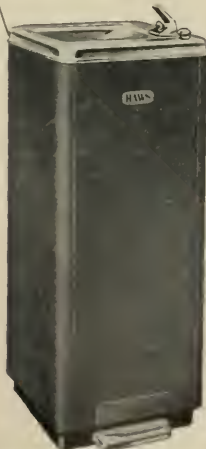

When you specify HAWS  
Electric Water Coolers, you  
are specifying a source of  
refreshing drinking water  
that is:

- Consistent in good design
- Consistent in sanitation
- Consistent in mechanical dependability

There is a HAWS Electric Water Cooler for every requirement.

See Sweet's... or write for  
new HAWS Catalog...NOW!

**HAWS** DRINKING FAUCET CO.  
1443 FOURTH STREET • BERKELEY 10, CALIFORNIA

## DR. MARIA TELKES NAMED RESEARCH ASSOCIATE

Dr. Maria Telkes, noted for her achievements in solar energy utilization and in the conversion of sea water to fresh drinking water, has been appointed a research associate in the Research Division of New York University's College of Engineering, according to an announcement by Dr. Harold K. Work, Director of the Division.

## STRUCTURAL ENGINEERS OF SOUTHERN CALIFORNIA

The October meeting was a joint meeting with the A.S.C.E. in the Rodger Young Auditorium with the program being devoted to a consideration of "Atomic Energy in Private Industry". Discussions were led by Richard B. Barton, Engineer of General Electric Company. General Electric has been the pioneer in developing and furthering the use of atomic energy in industrial applications, and manage the Hanford Atomic Products operation at Richland, Washington, for the Federal Government. They also carry on intensive research in this field at the Knolls Atomic Laboratory at Schenectady, New York. Many industrial applications of atomic energy will be utilized with turbines and

Sec-Tr; 4865 Park Ave., Riverside. Ventura-Santa Barbara Counties Branch, Robert L. Ryan, Pres; Richard E. Burnett, V-P; George Conahey, Sec-Tr, 649 Doris St., Oxnard.

**American Society of C. E.  
San Francisco Section**

J. G. Wright, President; J. E. Rinne, Vice-President; Howard C. Wood, Vice-President; John S. Longwell, Past President; H. C. Medbery, Secretary, and Richard C. Clark, Treasurer. Office Secretary, S. F. Water Dept., Millbrae.

**Structural Engineers Association of  
Southern California**

Ben Benioff, President; William T. Wright, Vice-President; Charles M. Corbit, Jr., Sec-Treas. Directors: Ben Benioff, William T. Wright, Harold P. King, Henry M. Layne, Joseph Sheffet, Robert J. Kadaw and Harald Omsted. Offices, 121 S. Alvarado St., Los Angeles 4.

**Structural Engineers Association of  
Oregon**

Lewis R. Ellingwood, President; Robert M. Bonney, Vice-President; Sully A. Ross, Secretary-Treasurer. Directors William J. Dorner, Roger V. Gillam, Leslie E.

Poole, Rowland S. Rosé. Offices 706 Board of Trade Bldg., 310 S.W. 4th Ave., Portland 4.

**Society of American Military  
Puget Sound Engineering Council  
(Washington)**

R. E. Kister, A. I. E. E., Chairman; E. R. McMillan, A. S. C. E., Vice Chairman; L. B. Cooper, A. S. M. E., Secretary; A. E. Nickerson, I. E. S., Treasurer. Offices, L. B. Cooper, c/o University of Washington, Seattle 5, Washington.

**American Society Testing Materials  
Northern California District**

L. A. O'Leary, Chairman; P. V. Garin, Vice-chairman; J. P. Hoopes, Sec. Office Sec., 1550 Powell St., Emeryville, Calif.

**Society of American Military  
Engineers—San Francisco Post**

CDR N. M. Martinsen, President; L. L. Wise, 1st Vice-President; Col. Paul Berrigan, 2nd Vice-President; R. M. Hamilton, Secretary; Thomas Hurley, Treasurer. Directors, RADM C. A. Trexel, J. G. Wright, LTCOL C. S. Lindsey, C. E. Bentley, F. R. Fowler, BRIGEN D. F. Johns, and RADM L. N. Moeller.

generators and as turbine engineer for GE, Barton is well acquainted with the most recent developments in the field.

Also on the program was "A is for Atom", GE's color cartoon which received the 1953 Oscar at the Cleveland Film Festival.

**STRUCTURAL ENGINEERS ASSOCIATION  
NORTHERN CALIFORNIA**

The regular October meeting was combined with the Annual Meeting of the Structural Engineers Association of California in Yosemite Park.

Recent new members include Thomas W. Power; and George F. Barnett and Conrad R. Sovig, Affiliates.

**KENTUCKY DEAN TO  
HEAD CIVIL ENGINEERS**

The American Society of Civil Engineers announces the election of Daniel V. Terrell of Lexington, Ky., as President. He is Dean of the College of Engineering at the University of Kentucky. Dean Terrell, succeeded Walter L. Huber of San Francisco, at the Society's annual meeting held recently in New York City.

Two Vice-president and six directors were also elected in a mail ballot of the more than 36,000 members. They were inducted into office also at the October convention.

The new Vice-presidents include: Enoch R. Needles for Zone 1 and Mason G. Lockwood for Zone 4. New Directors included Samuel B. Morris, manager and Chief Engineer, Los Angeles Department of Water and Power, District II; and Raymond F. Dawson of Austin, Professor of Civil Engineering at the University of Texas.

**CORROSION ENGINEERS OF  
WEST TO MEET IN NOVEMBER**

An opportunity for study and conferences on corrosion will be provided by the Western Region, National Association of Corrosion Engineers when a three day course on cathodic protection will be offered by the University of California at Los Angeles on November 16-20. NACE is sponsoring the

(See Page 33)

**HAWS**

**has the ANSWER**

...for every specification requiring a public source of refreshing, sanitary drinking water.

**RESTAURANT WATER COOLERS  
ELECTRIC WATER COOLERS  
DRINKING FOUNTAINS  
DRINKING FAUCETS**

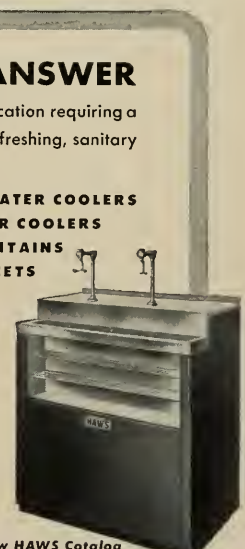

Single and multiple units to fit your requirements. Beauty to match the decor of any design. The utility you demand. Backed by a reputation for reliability since 1909.

See Sweets or write for the new HAWS Catalog

**HAWS**

**DRINKING FAUCET CO.**

1443 FOURTH STREET - BERKELEY 10, CALIFORNIA

# PRODUCER'S COUNCIL PAGE

The National Organization of Manufacturers of Quality Building Materials and Equipment  
(Northern California Chapter) affiliated with THE AMERICAN INSTITUTE OF ARCHITECTS

President, Roly MacNichol  
Libbey-Owens-Ford Glass Co.  
Rialto Bldg.

Vice-President, Ted Bakeman  
F. W. Wakefield Brass Co.  
445 Bryant Street

Secretary, John Cowley  
Hamilton Manufacturing Co.  
2833 3rd Street

Treasurer, Carl Frank  
Detroit Steel Products Co.  
Russ Building

Edited by Stanley L. Basterash--WESTERN ASBESTOS COMPANY

## "A GOOD BUILDING MUST BE BUILT WELL, WORK WELL, AND LOOK WELL."

The editor of this article offers a silver dollar to the reader who first identifies the architect who is accredited with first making the above statement. (Editor's firm excluded). Go way back boys.

### PRESIDENT RETURNS

Roly MacNichol has returned from Pittsburgh, Pa. where he attended the National Convention of the Producers' Council. Roly gave a talk on "How To Expand Chapter Activities Beyond Chapter Cities". This subject, in effort, is a very important part of the Northern California Chapter.

Roly said they kept him so busy he didn't have an opportunity to get beyond the confines of the hotel. However, I understand a few special stories were told. Try to get one for the next issue.

### MONTHLY INFORMATIONAL MEETINGS

Most of us have at one time or another attended one of the informational meetings. There are those who wouldn't miss one on a bet. Personally I have found the meetings fulfilling their purpose most satisfactorily.

The attendance is always good, comprised of Producer Council members and guests from the Architectural and Engineering professions. Many times it has been noted Producer Council mem-

bers outnumber the guests from these two professions.

In order to increase the guest attendance and also to give the Architect and Engineer more opportunity to obtain product information, the executive committee has decided to send two (2) guest names to each member company. One for the Producer's Council representative and one for the alternate.

Ted Bakeman informs me that the November meeting is to be sponsored by Great Lakes Steel Corporation through their representatives, Kyle Prefab Steel Co., San Francisco. Mr. Al Brinkman of Kyle Prefab will be in charge of the meeting. Also in attendance will be Mr. R. V. Langcor, Regional Manager for Great Lakes Steel Corporation and a representative from the Detroit office.

The program will consist of a new film covering steel production through to the fabrication of steel products. Also a demonstration on strasteel light gauge nailable frame, showing its uses and application in modern construction.

USE QUALITY PRODUCTS



CONSULT AN ARCHITECT



## WITH THE ENGINEERS

(From Page 31)

short course. November 19-20 will be devoted to the Third Annual Conference of Western Region NACE, when corrosion problems affecting pipelines, oil refineries and aircraft will be discussed.

The University of California course will be directed toward training personnel in the field installation and maintenance of cathodic protection systems.

At the regional conference some of NACE's technical committees are expected to make reports during the morning of November 19. Technical papers will be presented during the afternoon on gas and water pipeline corrosion. On the following morning, papers on corrosion problems in the aircraft industry will be given and in the afternoon corrosion problems in petroleum refineries will be discussed.

The week's activities affords an opportunity to listen to and discuss with some of the nation's leading corrosion engineers current corrosion problems and what is being accomplished in controlling corrosion damage.

## A.I.A. ACTIVITIES

(From Page 29)

attendance at Coronado will reach an all time high and subjects under consideration will make a new record in diversity.

## WRIGHT AWARDED BROWN MEDAL

Frank Lloyd Wright, architect, was awarded the Frank P. Brown Medal of The Franklin Institute of the State of Pennsylvania at the Institute's Medal Day ceremonies held October 21.

The award was made for: "No one man has had so much to do with the shaping of our external world during the past half century. . . . His name has become synonymous with architecture. In consideration of his very extensive contributions to the entire field of architecture over a period of more than a half century, by means of countless and varied buildings, by reason of his many writings and lectures and through his Fellowship at Taliesin".

## BARRETT & HILP DISSOLVE CONTRACTING PARTNERSHIP

J. F. Barrett and H. H. Hilp, of the forty-one year old general contracting firm of Barrett & Hilp, with headquarters in San Francisco, announced the dissolution of the firm.

The firm stated that it will not enter into any building contracts "the duration of which may extend beyond February 28, 1954". Present contracts will be completed, however, under the firm's name.

John Frank Barrett and Harry H. Hilp formed

their own firm in San Francisco in October, 1912 with total cash assets of approximately \$450. Last year their total volume of business was about \$20,000,000.

## ENGINEER NAMED FOR HOTEL PROJECT

Morris Steinbaum, president of the Morris Hotel Chain, operators of the Hotel Clark in Los Angeles and other large hotels throughout the country, recently announced that William M. Taggart, structural engineer, had been appointed to supervise important changes in the Hotel Clark.

Taggart is converting the hotel boilers from high to low pressure and installing the latest type of vacuum heating pump and combination gas-oil pressure boilers as part of a \$500,000 remodeling program.

## ARCHITECTURAL OFFICE CHANGES

Announcement has been made that Russell deLappe and Mitchell Van Bourg are continuing the practice of architecture at the offices of the firm in the Hotel Claremont, Berkeley, and that Herbert Malloy formerly with the firm of Russell Guerne deLappe & Associates is no longer associated with the firm.

SHOPPING FOR BETTER DISPLAY ILLUMINATION?

COLLEGIATE PM-284

look to..... **SMOOT-HOLMAN** for quality

SKYLIKE

These lighting requirements for a new supermarket were met by Smoot-Holman:

- continuous illumination throughout various counters
- simplified and economical installation procedures
- ease of maintenance for lamp changing and servicing
- eye appeal and quick identification of the products
- greater sales returns from better display of products
- uniformly styled appearance for contemporary interior
- engineering "know-how" in design and construction of the finest quality illumination equipment

# PERSONALITIES

**RUSSELL MILLS, A.I.A.**  
**ARCHITECT - ENGINEER**

RENO, NEVADA

Like so many professional men and women who gravitate from their early training into allied fields of practice Russell Mills was educated in the



**RUSSELL MILLS, A.I.A.**  
 Architect

entered the field of Architecture and began the

Mechanical and Electrical Engineering profession and turned to Architecture as a preferred endeavor.

Following attendance at the University of California where he studied Mechanical and Electrical Engineering Mills joined the Pacific Gas & Electric Company as a Valuation Engineer moving to Reno, Nevada, he

practice of Architecture as a principal in 1934. During the time he was doing engineering work, Mills designed many homes and buildings for real estate firms in Berkeley and architects in Reno. Mills took time out from his private practice in 1935-1938 to serve as Architectural Supervisor for the U. S. Government under the Home Owners Loan program and again during World War II, he served as Consultant for the U. S. Bureau of Yards and Docks; for the U. S. Treasury Department on many evaluation projects, and later served as Regional Architect for the National Housing Administration. Director of the OPA for the State of Nevada was another "public service" activity.

Included among work designed by Architect-Engineer Mills is a wide variety of large buildings; a good number of schools; and probably equally outstanding are more than one hundred residences in the City of Reno itself.

Architect-Engineer Mills has always taken an active part in community events and has contributed much in the way of Public Service to his Government, State and City, and to his profession. He is a Member of the National Council of Registration Boards; President of the Nevada Chapter of The American Institute of Architects;

# BRONZE PRODUCTS

by GREENBERG

Your best and nearest source for standard and special Bronze products



STABILITY since 1854

**M. GREENBERG'S SONS**

765 Folsom St. - San Francisco - Calif. - EXbrook 2-3143

Manufacturers of Fire Hydrants and Fire Protection  
 Brass Goods • Industrial, Navy and Maritime  
 Bronze Valves and Fittings • Plumbing and  
 Hardware Brass Specialties • Bronze Plaques,  
 Letters and Name Plates.

LOS ANGELES - PHOENIX - SEATTLE - PORTLAND - SPOKANE - SALT LAKE CITY - DENVER - KANSAS CITY - NEW ORLEANS - HONOLULU - NEW YORK - WASHINGTON, D. C.

Chairman of the Nevada Board of Architecture; Member of the Land Use Adjustment Committee of the City of Reno, and a number of other city and state committees and organizations.

Architect-Engineer Mills' office is currently engaged in quite a few projects throughout the State of Nevada.

WILL MOYSE, Edward Reno, Home Builders' Association, Chair.

### JOINT ENGINEERING COMMITTEE WINS LEON S. MOISSEIFF AWARD

The American Society of Civil Engineers has announced the award of the Leon S. Moisseiff Award for the paper "Lateral Forces of Earthquake and Wind," prepared by the Joint Lateral Force Committee representing the San Francisco Section of American Society of Civil Engineers, and the Structural Engineers Association of Northern California.

The award consisting of a medal and certificate is given each year to an important paper in the field of structural design, and will be presented to the winners at the annual convention of the Society in New York City on October 21.

Members of the committee are: John E. Payne, Chairman; Arthur W. Anderson, John A. Blume, Henry J. Degenkolb, Harold E. Humann, Edward M. Knapik, Henry L. Marchand, Henry C. Powers, G. A. Sedgwick, and Harold O. Sieberg.

### UNDERGROUND STEAMLINES

From Page 16

tract as possible.

2. Inherent structural strength, exclusive of the piping system itself.
3. Freedom of pipe movement within the insulator medium and as nearly "free floating" as possible.
4. Highly resistant to thermal shock.
5. High in moisture repellency.
6. Complete protection from underground water conditions even when submerged completely.
7. Predictable and stable thermal properties insuring efficiency over long periods of operation, both constant and intermittent.

It is unquestionably true that no system available today rates "perfection" in all the many requirements actually demanded for such installations. However, the designing function can, by proper evaluation and analysis, determine which particular type of installation will prove best for specific job conditions.

Corrosive soils and/or electrolysis is the prime enemy of underground piping insulation systems. Seldom can system failures be placed on the in-

stallation medium. The fact is that in many systems, failure of most of the insulation materials can be salvaged. System failures mean replacement of the piping proper or sections thereof, not the insulation material.

The foregoing statements are the reasons of the writers opinion that Requirement No. 1 is most important.

A very well known national industry has and is carrying on a large research program involving scientific methods protection for underground pipe line protection, so that electrical potentials may be in balance and electrolytic destruction relieved. Annual losses in damage to underground steel structures of all kinds due to electrolytic action is staggering until this accounts for a large percentage of annual steel production used for replacement purposes only.

Early but inconclusive reports indicate that this field of research may well have very important results in curtailing much of this total economic loss.

The writer has seen sections of underground in-

## Summerbell for SCHOOL ADMINISTRATION

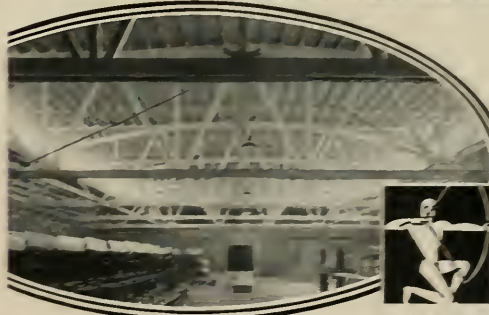

**SUMMERBELL** Bowstring Trusses play an increasingly important part in helping the Architects and School Administrators in keeping up with the constantly growing demand for more facilities in the face of limited budgets and a growing insistence for lower taxes. **SUMMERBELL** Bowstring Trusses and glued laminated arches and beams are the economical answer to the need for low-cost warehouses, shops, classrooms, gymnasiums and school buildings of all kinds.

Elanouse Public School Administration, Long Beach, Calif. Architect: Francis J. Neusel.

Structural Engineer, J. H. Davies, General Contractor, Willie-DeVore Inc.

Glued Laminated Construction • Summerbell Bowstring Trusses  
Lamella Roofs • All Types of Timber Structures

For quality, economy and satisfaction, specify **SUMMERBELL**

### Summerbell ROOF STRUCTURES

825 EAST 29TH STREET • BOX 218, STATION "K" • LOS ANGELES 11



sulated piping thoroughly perforated and pin-holed after only 6 months use. This unusual failure was brought about by an equally unusual condition, in that the job site was heavily interlaced with underground Direct Current electric cable lines and the acute "stray" current factor from such cables accelerated the damage tremendously. Another reinforcement for the importance of Requirement No. 1.

Out of service for the replacement of just one short section of piping, means shutdown for the whole system.

### ANNOUNCE NEW CONTRACTING FIRM OF HILP & RHODES

Harry H. Hilp, Sr., Theodore Rhodes and Harry H. Hilp, Jr., have announced formation of the general contracting firm of Hilp & Rhodes.

Offices of the new firm will be maintained at 16th and Kansas Streets in San Francisco, according to the announcement.

### OAKLAND ART GALLERY

The 21st Watercolor, Drawings and Prints Annual is being held this month in the Municipal Auditorium, Oakland.

### WOODEN FRONT DISHWASHER FOR NEW CUSTOM KITCHENS

Keeping pace with the desire of the construction industry to make available "optional" selection of modern home equipment, and to fulfill the desire of the homeowner for "installations" that will match the surrounding cabinets, a natural wood panel has been perfected that fits the GE undercounter dishwasher; available in most of the popular woods, such as knotty pine, birch, Honduras mahogany and oak.

The panels are designed to replace the standard metal panel normally supplied with the dishwasher, and can be installed in a matter of a few minutes without necessity of custom filling at the time of installation.

Available through GE Major Appliance dealers

or distributors, either finished or unfinished so that special coloring can be added at time of installa-



tion to match the shade and finish of adjoining cabinets. Blueprints for local construction are also available through GE.

### CONCRETE MASONRY'S WINNING HOME DESIGN

(From Page 11)

A. Lynch of Omaha; and Dale L. Gibbs, Roy C. Neumann, and Hedy C. Neumann of Lincoln.

The winners were introduced at the meeting by Martin I. Aitken of Lincoln, professional adviser for the competition, and awards were presented by Lew Anderson of Lincoln, president of the Nebraska Concrete Masonry Association; in charge of the meeting was Edward J. Sessinghaus of Omaha, president of the NAA.

Winning designs were chosen from a field of 31 entries by a Jury of Award consisting of Harold Spitznagle, architect, Sioux Falls, South Dakota; James T. Lendrum, executive director of the Small Homes Council, University of Illinois, Urbana, Illinois, and R. E. Copeland, director of engineering, National Concrete Masonry Association, Chicago, Illinois.

The first place design by Clark and Enerson is a three-bedroom house, 46 x 23 feet, with an added kitchen ell, plus covered porch and carport. It has a divided basement, and features a large living room and a large, open multi-purpose area.

In commenting upon the winning design, the jury noted that it employs carefully considered new uses for concrete masonry; that it shows a good basic relationship between rooms; that it is a direct and simple plan with an open quality; that it is advantageously oriented to the lot; and that its easily-supervised multiple-purpose area is unusual in a house of the size under consideration.

Announced purpose of the competition was to

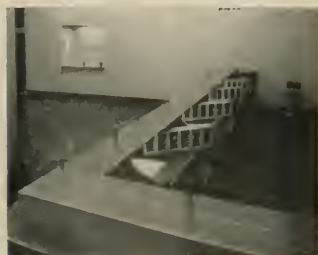

Customer's  
Counter  
Telephone  
Building  
Oakland,  
California

Thomsen and Wilson  
Architects

Manufactured and  
Installed by

## THE FINK & SCHINDLER CO.

Since 1882

552 Brannen Street San Francisco, Calif. EXbrook 2-1513

(1) stimulate new ideas for home builders in the moderate income class; (2) stimulate a greater interest in the use of concrete masonry for home construction; and (3) stimulate a further desire for architectural services in home design.

The designs were based on a lot, located anywhere within the state, with a frontage dimension not to exceed 60 feet and a depth of 125. Living area was restricted to 1200 square feet on one level with the basement not taken into consideration. Use of modular dimensioned concrete masonry in the construction of all exterior walls and chimneys was mandatory.

#### **POMONA TILE APPOINTS WOOLEY TO PERSONNEL**

Ben-Allen Wooley has been appointed personnel manager for Pomona Tile Manufacturing Co., according to Drew Schroeder, executive vice-president.

#### **ARCHITECT & ENGINEER MAGAZINE IS HONORED AT CALIFORNIA STATE FAIR**

Among outstanding county exhibits at the recent California State Fair was the diversified showing of Calaveras County's natural, economic and industrial resources.

Highlight of the industrial portion of the exhibit was a working model of the Calaveras Cement Company plant at San Andreas which was scaled to 1/8 inch to the foot. All moving parts turned at actual rates of speed of their genuine counterparts.



As a back-ground display a number of large illustrations were used showing the use of cement products, and among these was an enlarged illustration of a swimming pool constructed of Calaveras White Cement. This photograph had previously been used as a cover illustration on the July 1953 issue of Architect & Engineer magazine, but was so well liked by company officials that they used it in the Fair exhibit.

Barbara Lee Nutter, theme girl of the 1953 State Fair, calls attention to the model plant.

## **FORDERER CORNICE WORKS**

*Manufacturers of*

Hollow Metal Products • Interior Metal Trim  
Elevator Fronts and Cabs  
Metal Plaster Accessories • Sanitary Metal Base  
Flat and Roll Metal Screens  
Metal Cabinets • Commercial Refrigerators

**269 POTRERO AVE.**

**SAN FRANCISCO, CALIF. HEMLOCK 1-4100**

## **J. BETTANCOURT GENERAL CONTRACTOR AND BUILDER**

1015 SAN MATEO AVENUE

SAN BRUNO, CALIFORNIA

Phone: JUno 8-7525

## **Parker, Steffens & Pearce**

**BUILDERS**

135 South Park, San Francisco

Phone: EXbrook 2-4832

## **BARRETT & HILP**

**CONTRACTORS**

*Serving The Construction Field  
Since 1912*

**OUR FORTIETH YEAR**

918 Harrison Street • San Francisco  
Telephone DOuglas 2-0700

**CLINTON  
CONSTRUCTION CO.  
OF CALIFORNIA**

**General Contractors**

923 FOLSOM STREET • SAN FRANCISCO

Sutter 1-3440

**CONTRACTORS — QUARRIERS — FABRICATORS**

ALL TYPES OF

◆ **GRANITE** ◆

SPECIALIZING IN  
CALIFORNIA GRANITES

*Pacific Cut Stone & Granite Co.*

Home Office:

414 So. Marengo Ave.  
Alhambra, Calif.  
Box 30, Ph. CU 31711

BLACK  
DIAMOND  
◆  
GRANITE

Fabricating Plants  
at  
Alhambra, Calif.  
Clovis, Calif.

**HAAS and HAYNIE**

Formerly Haas Construction Company

Since 1898

275 PINE ST.

SAN FRANCISCO, CALIF.

Phone DOuglas 2-0678

**JUDSON PACIFIC-MURPHY CORP.**

**Steel Fabricators  
and  
Erectors**

**REINFORCING STEEL**

**STRUCTURAL STEEL**

**BRIDGE CRANES**

4300 EASTSHORE HWY.  
EMERYVILLE, CALIF.

Phone:  
OL 3-1717

**BOOK REVIEWS  
PAMPHLETS AND CATALOGUES**

**PRACTICAL HOUSE—For Contemporary Living.** By Jean and Don Graf. Architectural Record, 119 W. 40th St., New York 18. Price \$6.95.

Practical Houses for Contemporary Living presents what might be called forty success stories in home planning. The houses were selected because they admirably fulfill the living requirements of their owners and range in price from \$7500 upwards.

The book is divided into six main sections: Houses for One Person; Good Small Houses; Houses Planned for Children and Adults; Houses for Limited Lot Lines; Houses for Irregular Land; and They Knew What They Wanted. All houses are architect designed.

**FATIGUE OF METALS.** Philosophical Library Publishers, 15 E. 40th St., New York 16, N. Y. Price \$12.50.

Translated from Dr. R. Cazaud, French research expert, by A. J. Fenner, B.Sc (Eng.), A.M.I. Mech. E., Division of Atomic Energy (Production), Ministry of Supply, formerly of Engineering division, National Physical Laboratory, and contains a foreword by H. J. Gough, C.E., M.B.E., D.Sc., M.I. Mech. E., F.R.S.

Dr. Gough says in part "The extent of the literature on the characteristics and behaviours of metals, when subjected to cycle stresses, is so great as to present a real difficulty even to that specialized circle of engineers and scientists who must, for professional reasons, keep themselves closely informed of progress and knowledge, thought, experience and technical application in this field.

This "more recent material in the present work, an extensive, lucid and up-to-date review of fact, practice and experience which, if thoughtfully applied, should be most helpful towards the improvement of design, selection of material, the use of more suitable workshop methods and finishes, together with useful guidance at the inspection stage."

**ARCHITECTS DETAIL SHEETS.** By Edward D. Mills, F.R.I.B.A. Iliffe & Sons, Ltd., Publisher (British Book Center, 122 E. 55th St., N. Y.) Price \$5.50.

The question of detail design in modern buildings is one of considerable importance, for many of the early examples of contemporary architecture, while successful as broad concepts, failed in detail. Good architectural detailing is both a practical and an aesthetic problem, and the object of the detail sheets published in this book is to show in actual examples how contemporary designers have combined, in recent modern buildings, good construction and satisfactory appearances.

Ninety-six sheets are included consisting of specially prepared scale drawings, accompanied by photographs; arranged in appropriate groupings and cover a wide range of problems from windows and door openings to staircases, fireplaces and internal fittings and furniture. An English-German-Spanish glossary of the terms used is also provided.

**NEW CATALOGUES AVAILABLE**

*Architects, Engineers, Contractors, Planning Commission members—the catalogues, folders, new building products material, etc., described below may be obtained by directing your request to the name and address given in each item.*

**Prevent moisture damage.** A new pamphlet is available on methods and uses of Thompson's Water Seal to assure a maximum protection and minimize moisture damage to all types of buildings. Of particular interest to architect, engineers, concrete contractors, residential and industrial builders, paint contractors, and manufacturers and suppliers of building materials. Illustrated, gives numerous suggestions. Available by writing DEPT-A6E, By-Chemical Products Co., 1355 Market Street, San Francisco 3.

**Sizing pressure relief valves.** New 24-page booklet "Selection and Sizing Pressure Relief Valves to Comply With ASME Boiler Code Requirements, has been published as a contribution to the heating industry by Mc-Donnell & Miller, Inc., manufacturers of boiler controls. Although the ASME Code is explicit about the selection of pressure relief valves with capacity ratings to match gross heat output of the equipment, no guide procedure is readily available for calculating or de-



termining gross heat outputs—this booklet is intended to satisfy that need; to provide complete and easy to use data for accurately determining the output of all types of boilers, tanks and heaters. Formulas and tables cover recommended relief valves for cast iron boilers and steel boilers, as well as those boilers for which there is no nameplate data or set procedures for establishing the output; hot water supply heaters and tanks, heat exchangers and unfired pressure vessels are also covered. Write Dept. A&E, McDonnell & Miller, Inc., 3500 N. Spaulding Ave., Chicago, Ill.

**Machine tool attachments.** South Bend Lathe has collected into one large bulletin the complete story on their many machine tool attachments and accessories, entitled "165 Reasons Why"; offers birds eye view of the job range now possible with their lathes, drill presses and shapers; handy pocket size and 160 illustrations. Copy available by writing Dept. A&E, South Bend Lathe Works, South Bend 22, Indiana.

**New roof deck.** A new architectural design manual (A.I.A. FILE No. 37-D-2) for the use of Tectum roof deck has just been released. "Engineered Roof Deck" the book explains the methods of anchoring the material, specifications for its use, design data, and other architectural details; contains loading tables, technical drawings, and specifications. Also have available a catalog called "Tectum, The New Basic Building Material." For either, or both, write Dept. A&E, Tectum Corp., 105 S. 6th St., Newark, Ohio.

**Standard duty cylindrical locks.** New folder describes and pictures the CORBIN "Defender" line of Standard-Duty Cylindrical Locks and Latchsets. Contains detailed information; 13-functions, self-aligning, reversible, adjustable for 1 3/4" to 1 3/8" doors, master-keying. Auxiliary items, king-size rose plates, backset extension units, rabbeted, reinforcing frame for hollow metal doors, dummy trim, boring jigs and bits. Write Dept. A&E, P.&F. Corbin Division, American Hardware Corp., New Britain, Conn. for free copies.

**Oil generating burner.** A new combustion head, the greatest innovation in the oil heat industry since the gun type burner. When installed with any gun type burner, either new or existing, it provides more heat, cuts oil consumption from 30 to 50 percent and prevents carbon from forming on the spray nozzle; safe, efficient, economical; descriptive illustrations. Free copy, write Dept. A&E, Oilgas Generating Burner, Inc., 410 S. Jefferson St., New Castle, Pa.

**Silicone products.** The new 1953-54 reference guide to Dow-Corning Silicone Products is now available. Contains cross-reference application index, and products themselves are described largely in terms of operating and service characteristics; thorough, comprehensive, listing of silicone products; fifteen new products, ranging from adhesives to molding compounds; new applications for silicone fluid are described, and the performance of Silastic as a dielectric is also described. Free copy, write Dept. A&E, Dow-Corning Corp., Midland, Michigan.

**Fully automatic heavy fuel oil burners.** A new oil burner which will start, follow the load demand and then stop automatically is fully described in a booklet just released by the Ray Oil Burner Company. Operating cycle starts when temperature or pressure-actuated controls call for heat and an electric spark lights a gas pilot, which in turn ignites the oil; dual ignition on larger sizes. Various types of burners are described, hourly capacity ratings are given and construction features are covered in detail. For free copy write Dept. A&E, Ray Oil Burner Co., 1301 San Jose Avenue, San Francisco.

**Radiant panel heating.** Radiant Panel Heating with Pre-Formed Copper Tube Panel Grids is the title of a new brochure (A.I.A. 30-C-44) just released by the American Brass Company. The booklet contains descriptive data on panel heating; use of copper tubes; illustrations on methods of installation and use; layouts and charts of BTU output as applied to ceilings, floors, and a comprehensive tabulation of heat loss factors. Free copy available by writing Dept. A&E, The American Brass Co., Waterbury 20, Conn.

**Key switches and control components.** A complete, comprehensive catalog illustrating "telephone type" components for industrial use; a helpful guide to engineers, architects, and purchasers. Shows scores of photographs and devices, switch-board lamps, jacks and caps, and other control devices. Specification tables designed for easy ordering. Copies available by writing Dept. A&E, Automatic Electric Co., 1033 W. Van Buren St., Chicago 7, Ill.

## VERMONT MARBLE COMPANY

DOMESTIC AND IMPORTED MARBLES  
GRANITE VENEER

525 MARKET STREET • SAN FRANCISCO 5

Phone: SUtter 1-6747

3522 COUNCIL STREET • LOS ANGELES 4

Phone: DUmkirk 2-7834

The Most Complete Line of  
STEELS and STEEL BUILDING MATERIALS  
Made by a Single Producer



See Sweet's Catalog File or write us for  
full information.

REPUBLIC STEEL CORPORATION

GENERAL OFFICES: CLEVELAND, OHIO

DENVER, COLORADO . . . CONTINENTAL OIL BUILDING  
LOS ANGELES, CALIF. . . GENERAL PETROLEUM BUILDING  
SAN FRANCISCO, CALIFORNIA . . . RIALTO BUILDING  
SEATTLE, WASH. . . . . WHITE-HENRY-STUART BUILDING

## PACIFIC MANUFACTURING CO.

High Class Interior Finish Quality  
Millwork

16 Beale St., San Francisco  
GARfield 1-7755

2215 El Camino Real, San Mateo  
S. M. 5-0687

304 Bryant Street, Palo Alto  
P. A. 3373

2610 The Alameda, Santa Clara  
S. C. 607 (Factory)

6820 McKinley Avenue, Los Angeles  
THornwall 4176

MAIN OFFICE — SANTA CLARA

## "AMERICAN - MARSH" CONDENSATION UNIT

Pumping  
Machinery  
for  
Every  
Purpose

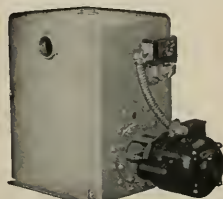

For Service  
Call  
DOuglas  
2-6794

or  
MUtual 8322

SIMONDS MACHINERY CO.  
SAN FRANCISCO 816 FOLSOM  
LOS ANGELES 485 EAST 4TH

## EARTHQUAKE TESTS

(From Page 16)

Many interesting speculations may be made about actions resulting with different thickness slabs, or with bracing of different flexibility. With very stiff bracing, accelerations should become close to that of the actual ground motion. Buildings with low damping characteristics tend to develop high accelerations.

After the Arvin-Tehachapi earthquake, analysis was made on some structures where the resisting elements could be isolated, and results indicate that actual accelerations of 30 to 35% "g" were present.

In conclusion, many structures have an inherent strength much greater than the 10% "g" design criteria would indicate when consideration is given to the ultimate strength of the materials. Then, too, many buildings have elements of stiffening which are customarily omitted in the design concept.

However it has been noted that even where older buildings have withstood severe first shocks, they have been loosened an appreciable amount. Then, when aftershocks of smaller magnitude occur weeks later, even more extensive damage has

been reported. Such was the case recently at Bakersfield, and also in 1935 at Helena, Montana.

The reduced stiffness of the building evidently leads to a longer period, at a time when the material has already been weakened. For example merely tightening bracing rods that already have been stretched an appreciable portion towards their breaking strength cannot possibly restore the structure to its original strength.

## CENTRAL VALLEY OF CALIFORNIA ACSE FORM NEW SECTION

John G. Meyer, District Engineer for the California Division of Highways, Stockton, was elected to serve as President of the newly chartered Central Valley sub-section of the Sacramento Section of the American Society of Civil Engineers, which was recently formed at a special meeting of engineers held at the Kentucky House on the Calaveras Cement Company property at San Andreas.

The meeting was presided over by Walter Schulz, President of the Sacramento Section, ASCE, and principal hydraulics engineer for the California State Division of Water Resources.

Ted Stivers, chief-engineer of the South San Joaquin Irrigation District, gave an illustrated talk on the Tri-Dam Project contemplated for the North Fork of the Stanislaus River.

E. M. Barker, Mel J. London and Grant Metzger of the cement company served as hosts and conducted the more than 100 visiting engineers on a tour through the Calaveras Cement plant.

Other officers elected to serve with Meyer included: Felix A. Wallace, head of the department of engineering at College of the Pacific, Vice-President; Frank Lucas, associate highway engineer State Division at Stockton, Secretary; Harry M. Moses, Civil Engineer, U. S. Bureau of Reclamation, Stockton, Treasurer; and Board Member at Large, J. Don Layson, City of Stockton engineering department.

## DESIGNER AMONG SPECIALISTS AIDING FRENCH MERCHANTISERS

Edgar I. Kober of the firm of Burke, Kober & Nicholais, Designers, Los Angeles, is among four American merchandising experts selected to share their know-how with consumer goods manufacturers and retailers of France.

Under sponsorship of the productivity and technical assistance program of the Foreign Operations Administration, the Americans will demonstrate modern selling techniques to businessmen in cities and town throughout France.

Other members of the group are Mark T. Shaw, chairman, South Pasadena; James S. Webster, Los Angeles; and Walker M. Thorn of San Mateo.



**HOLLYWOOD JUNIOR**  
COMBINATION  
SCREEN and METAL SASH DOOR  
★  
The "WEATHER-WISE"  
DOOR!!

**A VENTILATING SCREEN DOOR  
A SASH DOOR  
A PERMANENT OUTSIDE DOOR  
ALL 3 IN 1!**

Discriminating home owners and architects have chosen Hollywood Junior as the TRIPLE DOOR VALUE in the COMBINATION SCREEN and METAL SASH DOOR field! A sturdy dependable door, constructed of quality materials, HOLLYWOOD JUNIOR'S EXCLUSIVE PATENTED FEATURES have outmoded old-fashioned screen doors and other doors of its type antisly! . . . . .

**IT GUARANTEES YOU YEAR 'ROUND  
COMFORT, CONVENIENCE AND ECONOMY**

WE ALSO MANUFACTURE A COMPLETE LINE OF  
SHUTTERS, C. C. DOORS, SCREENS, SCREEN DOORS, LOUVRE DOORS

**WEST COAST SCREEN CO.**  
1145 EAST 53rd STREET \* LOS ANGELES, CALIFORNIA  
AD4445 1128

• • • • • WRITE FOR FREE ILLUSTRATED LITERATURE • • • • •

# ESTIMATOR'S GUIDE

## BUILDING AND CONSTRUCTION MATERIALS

PRICES GIVEN ARE FIGURING PRICES AND ARE MADE UP FROM AVERAGE QUOTATIONS FURNISHED BY MATERIAL HOUSES TO SAN FRANCISCO CONTRACTORS. 3% SALES TAX ON ALL MATERIALS BUT NOT LABOR

All prices and wages quoted are for San Francisco and the Bay District. There may be slight fluctuation of prices in the interior and southern part of the state. Freight cartage, at least, must be added in figuring country work.

**BONDS**—Performance or Performance plus Labor and Material Bond(s), \$10 per \$1000 on contract price. Labor & Material Bond(s) only, \$5.00 per \$1000 on contract price.

**BRICKWORK—MASONRY—**

Common Brick—Per 1 M laid—\$150.00 up (according to class of work).  
Face Brick—Per 1 M laid—\$200.00 and up (according to class of work).  
Brick Steps—\$3.00 and up.  
Common Brick Veneer on Frame Bldgs.—Approx. \$1.20 and up (according to class of work).  
Face Brick Veneer on Frame Bldgs.—Approx. \$2.00 and up (according to class of work).  
Common Brick—\$36.00 per M truckload lots, delivered.  
Face Brick—\$81.00 to \$106.00 per M, truckload lots, delivered.

**Glazed Structural Units—Walls Erected—**

Clear Glazed—  
2 x 6 x 12 Furring ..... \$2.00 per sq. ft.  
4 x 6 x 12 Partition ..... 2.25 per sq. ft.  
4 x 6 x 12 Double Faced  
Partition ..... 3.00 per sq. ft.  
For colored glaze add ..... 30 per sq. ft.  
Mantel Fire Brick \$150.00 per M—F.O.B. Pittsburgh.

Fire Brick—Per M—\$111.00 to \$147.00.  
Cartage—Approx. \$10.00 per M.  
Paving—\$75.00.

**Building Tile—**  
8x5 1/2 x 12-inches, per M ..... \$139.50  
6x5 1/2 x 12-inches, per M ..... 105.00  
4x5 1/2 x 12-inches, per M ..... 84.00

**Hollow Tile—**  
12x12x2-inches, per M ..... \$146.75  
12x12x3-inches, per M ..... 156.85  
12x12x4-inches, per M ..... 177.10  
12x12x6-inches, per M ..... 235.30  
F.O.B. Plant

**BUILDING PAPER & FELTS—**

1 ply per 1000 ft. roll ..... \$5.30  
2 ply per 1000 ft. roll ..... 7.80  
3 ply per 1000 ft. roll ..... 9.75  
Brownline, Standard 500 ft. roll ..... 6.80  
Siskkraft, reinforced, 500 ft. roll ..... 8.50

**Sheathing Papers—**  
Asphalt sheathing, 15-lb. roll ..... \$2.70  
30-lb. roll ..... 3.70  
Dampcourse, 216-ft. roll ..... 2.95  
Blue Plasterboard, 60-lb. roll ..... 5.10

**Felt Papers—**  
Deadening felt, 34-lb., 50-ft. roll ..... \$4.30  
Deadening felt, 1-lb. Heavy ..... 5.05  
Asphalt roofing, 15-lb. Heavy ..... 2.70  
Asphalt roofing, 30-lb. Heavy ..... 3.70

**Roofing Papers—**  
Standard Grade, 108-ft. roll, Light ..... \$2.50  
Smooth Surface, Medium ..... 2.90  
Heavy ..... 3.40  
M. S. Extra Heavy ..... 3.95

**BUILDING HARDWARE—**

Sash cord com. No. 7 ..... \$2.45 per 100 ft.  
Sash cord com. No. 8 ..... 3.00 per 100 ft.  
Sash cord spot No. 7 ..... 3.45 per 100 ft.  
Sash cord spot No. 8 ..... 3.35 per 100 ft.  
Sash weights, cast iron, \$100.00 ton ..... \$3.75  
1-Ton lots, per 100 lbs. Heavy ..... 4.75  
Less than 1-Ton lots, per 100 lbs. ..... 4.75  
Nails, per keg, base ..... \$12.55  
8-in. spikes ..... 12.45  
Rim Knob lock sets ..... \$1.80  
Butts, dull brass plated on steel, 3/2x3 1/2 ..... .76

**CONCRETE AGGREGATES—**

The following prices net to Contractors unless otherwise shown. Carload lots only.

	Bunker per ton	Del'd per ton
Gravel, all sizes	\$2.44	\$2.90
Top Sand	2.38	3.13
Concrete Mix	2.38	3.06
Crushed Rock, 1/4" to 3/4"	2.38	2.90
Crushed Rock, 3/4" to 1 1/2"	2.38	2.90
Roofing Gravel	2.81	2.90
River Sand	2.50	3.00

Sand—  
Lapis (Nos. 2 & 4) ..... 3.56 3.94  
Olympia (Nos. 1 & 2) ..... 3.56 3.88

**Cement—**

Common (all brands, paper sacks),  
Per Sack, small quantity (paper) ..... \$1.05  
Carload lots, in bulk, per bbl. .... 3.55  
Cash discount on carload lots, 10c a bbl., 10th Prox., less than carload lots, \$4.00 per bbl. f.o.b. warehouse or delivered.  
Cash discount 2% on L.C.L.  
Trinity White ..... { 1 to 100 sacks, \$3.50 sack  
warehouse or del.; \$9.56  
Medusa White ..... { bbl., carload lots.

**CONCRETE READY-MIX—**

Delivered in 4-yd. loads:  
Per cubic yard, 1-8 Mix ..... \$ 9.80  
1-7 Mix ..... 10.15  
1-6 Mix ..... 10.70  
1-5 Mix ..... 11.40  
Curing Compound, clear, drums,  
per gal. .... 1.03

**CONCRETE BLOCKS—**

	Haydite \$19	8a-salt \$19
4x8x16-inches, each	.23	.235
8x8x16-inches, each	.27	.27
8x8x16-inches, each	.27	.27
12x8x16-inches, each	.38	.40
12x8x24-inches, each	.....	.60

**Haydite Aggregates—**  
3/4-inch to 3/8-inch, per cu. yd. .... \$7.75  
3/8-inch to 3/4-inch, per cu. yd. .... 7.75  
No. 6 to 0-inch, per cu. yd. .... 7.75

**DAMP-PROOFING and Waterproofing—**

Two-coat work, \$9.00 per square.  
Membrane waterproofing—4 layers of saturated felt, \$10.00 per square.  
Hot coating work, \$5.00 per square.  
Medusa Waterproofing, \$3.50 per lb. San Francisco Warehouse.  
Tricosal concrete waterproofing, 60c a cubic yd. and up.

**ELECTRIC WIRING—**\$15 to \$20 per outlet for conduit work (including switches).  
Knob and tube average \$6.00 per outlet.

**ELEVATORS—**

Prices vary according to capacity, speed and type. Consult elevator companies. Average cost of installing a slow speed automatic passenger elevator in small four story apartment building, including entrance doors, about \$9,500.00.

**EXCAVATION—**

Sand, \$1.00; clay or shale, \$1.50 per yard.  
Trucks, \$30 to \$45 per day.  
Above figures are an average without water. Steam shovel work in large quantities, less; hard material, such as rock, will ..... considerably more.

**FIRE ESCAPES—**

Ten-foot galvanized iron balcony, with stairs, \$250 installed on new buildings; \$300 on old buildings.

**FLOORS—**

Asphalt Tile, 1/8 in. gauge 18c to 35c per sq. ft.  
Composition Floors, such as Magnesite, 40c-\$1.25 per sq. ft.  
Linoleum, standard gauge, sq. yd. .... \$2.75  
Mastipave—\$1.50 per sq. yd.  
Battleship Linoleum—1/8"—\$3.00 sq. yd.  
Terrazo Floors—\$2.00 per sq. ft.  
Terrazo Steps—\$2.50 per lin. ft.  
Mastic Wear Coat—according to type—  
20c to 35c.

**Hardwood Flooring—**

**Oak Flooring—T & G—Unfin.**  
Clear Old, White ..... \$3 1/2 x 1/2 x 2 3/4 x 2 \$ 425 \$ 405 \$ \$  
Clear Old, Red ..... 405 380  
Select Old, Red or White ..... 355 340  
Clear Pln., Red or White ..... 355 340 335 315  
Select Pln., Red or White ..... 340 330 325 300  
#1 Common, red or White 315 310 305 280  
#2 Common, Red or White 305

**Refinished Oak Flooring—**

	Prime	Standard
1/2 x 2	\$369.00	\$359.00
1/2 x 2 1/2	380.00	370.00
1/2 x 2 1/4	390.00	381.00
1/2 x 2 3/4	375.00	355.00
1/2 x 3 1/4	395.00	375.00
1/2 x 2 1/4 x 3/4 Ranch Plank	.....	415.00

**Unfinished Maple Flooring—**

3/4 x 2 1/4 First Grade	\$390.00
3/4 x 2 1/4 2nd Grade	365.00
3/4 x 2 1/4 2nd & Bjr. Grade	375.00
3/4 x 2 1/4 3rd Grade	240.00
3/4 x 3/4 3rd & Bjr. Jrd. EM	380.00
3/4 x 3/2 2nd & Bjr. Jrd. EM	390.00
3/4 x 3/2 x 2 1/4 First Grade	400.00
3/4 x 3/2 x 2 1/4 2nd Grade	360.00
3/4 x 3/2 x 2 1/4 3rd Grade	320.00
Floor Layer Wage \$2.83 hr.	

**GLASS—**

Single Strength Window Glass ..... \$ .30 per sq. ft.  
Double Strength Window Glass ..... 45 per sq. ft.  
Plate Glass, 1/4 polished to 75 ..... 1.60 per sq. ft.  
75 to 100 ..... 1.74 per sq. ft.  
1/4 in. Polished Wire Plate Glass ..... 2.50 per sq. ft.  
1/4 in. Reh. Wire Glass ..... .80 per sq. ft.  
1/4 in. Obscure Glass ..... .44 per sq. ft.  
3/8 in. Obscure Glass ..... .63 per sq. ft.  
1/2 in. Heat Absorbing Obscure ..... .54 per sq. ft.  
3/8 in. Heat Absorbing Wire ..... .72 per sq. ft.  
1/2 in. Ribbed ..... .44 per sq. ft.  
3/8 in. Ribbed ..... .63 per sq. ft.  
1/4 in. Rough ..... .44 per sq. ft.  
3/8 in. Rough ..... .63 per sq. ft.  
Glazing of above additional \$1.15 to 30 per sq. ft.  
Glass Blocks, set in place ..... 3.50 per sq. ft.

**HEATING—**

**Furnaces—Gas Fired**  
Floor Furnace, 25,000 BTU ..... \$ 70.50  
35,000 BTU ..... 77.00  
45,000 BTU ..... 90.50  
Automatic Control, Add. .... 39.00  
Dual Wall Furnaces, 25,000 BTU ..... 91.50  
35,000 BTU ..... 99.00  
45,000 BTU ..... 117.00  
With Automatic Control, Add. .... 39.00  
Unit Heaters, 50,000 BTU ..... 202.00  
Gravity Furnace, 65,000 BTU ..... 198.00  
Forced Air Furnace, 75,000 BTU ..... 313.50  
**Water Heaters—5-year guarantee**  
With Thermostat Control,  
20 gal. capacity ..... 87.50  
30 gal. capacity ..... 103.95  
40 gal. capacity ..... 120.00



## INSULATION AND WALLBOARD—

Rocwool Insulation—	
(2") Less than 1,000 sq. ft.	\$64.00
(2") Over 1,000 sq. ft.	\$9.00
Cotton Insulation—Full thickness	
(3 1/2")	\$95.50 per M sq. ft.
Sisalation Aluminum Insulation—Aluminum coated on both sides	\$23.50 per M sq. ft.
Tileboard—1/4" panel	\$9.00 per panel
Wallboard—1/2" thickness	\$55.00 per M sq. ft.
Finished Plank	\$9.00 per M sq. ft.
Ceiling Tileboard	\$9.00 per M sq. ft.

**IRON**—Cost of ornamental iron, cast iron, etc., depends on designs.

## LUMBER—

S4S No. 2 and better common	
O.P. or D.F., per M. f. b. m.	\$100.00
Rough, No. 2, common O.P. or D.F., per M. f. b. m.	95.00

## Flooring—

	Per M Delvd.
V.G.-D.F. B & Bir. 1 x 4 T & G Flooring	\$225.00
"C" and better—all	225.00
"D" and better—all	225.00
Rwd. Rustic—"A" grade, medium dry	185.00
8 to 24 ft.	

## Plywood, per M sq. ft.

1/4-inch, 4.0x8.0-515	\$135.00
1/2-inch, 4.0x8.0-515	219.00
3/4-inch, per M sq. ft.	292.00
Plywood	11 1/2¢ per ft.
Plyform	25¢ per ft.

## Shingles (Rwd. not available)—

Red Cedar No. 1—\$9.50 per square; No. 2, \$7.00; No. 3, \$5.00.
--

Average cost to lay shingles, \$6.00 per square.	
Cedar Shakes—1/2" to 3/4" x 24/26 in handsplit tapered or split resawn, per square.	\$15.25
3/4" to 1 1/4" x 24/26 in split resawn, per square	17.00
Average cost to lay shakes, \$8.00 per square.	

## Pressure Treated Lumber—

Wolmanized	Add \$35 per M to above
Crescoted	
8-lb. treatment	Add \$45 per M to above

## MARBLE—(See Dealers)

## METAL LATH EXPANDED—

Standard Diamond, 3.40, Copper Bearing, LCL, per 100 sq. yds.	\$43.50
Standard Ribbed, ditto	\$47.50

## MILLWORK—Standard.

D. F. \$150 per 1000, R. W. Rustic \$175 per 1000 (delivered).
--

Double hung box window frames, average with trim, \$12.50 and up, each.

Complete door unit, \$15 to \$25.

Screen doors, \$8.00 to \$12.00 each.

Patent screen windows, \$1.25 a sq. ft.

Cases for kitchen pantries seven ft. high, per lineal ft., upper \$9.00 to \$11.00; lower \$12.00 to \$13.00.

Dining room cases, \$20 per lineal foot. Rough and finish about \$1.00 per sq. ft.

Labor—Rough carpentry, warehouse heavy framing (average), \$75.00 per M.

For smaller work average, \$85.00 to \$100. per 1000.

## PAINTING—

Two-coat work	per yard 85c
Three-coat work	per yard \$1.10
Cold water painting	per yard 25c
Whitewashing	per yard 15c

## Linseed Oil, Strictly Pure

(Basis 7 1/2 lbs. per gal.)		Wholesale	
Light iron drums	per gal.	\$2.28	\$2.34
5-gallon cans	per gal.	2.40	2.46
1-gallon cans	each	2.52	2.58
Quart cans	each	.71	.72
Pint cans	each	.36	.39
1/2-pint cans	each	.24	.24

## Turpentine

(Basis, 7.2 lbs. per gal.)		Pure Gum	
Light iron cans	per gal.	\$1.85	
5-gallon cans	per gal.	1.76	
1-gallon cans	each	1.88	
Quart cans	each	.54	
Pint cans	each	.31	
1/2-pint cans	each	.20	

## Pioneer White Lead in Oil Heavy Paste and All-Purpose (Soft-Paste)

Net Weight	List Price	Price to Painters
Packages	lbs.	lbs.
100-lb. kegs	\$28.35	\$29.35
50-lb. kegs	30.05	15.03
25-lb. kegs	30.35	7.50
5-lb. cans*	33.35	1.34
1-lb. cans*	36.00	.36
500 lbs. (one delivery)	3/4¢	per pound less than above.

## Pioneer Dry White Lead—Litharge—Dry Red Lead Red Lead in Oil

	100	50	25
	lbs.	lbs.	lbs.
Dry White Lead	\$26.30	\$26.30	\$26.30
Litharge	25.95	26.40	26.90
Dry Red Lead	27.20	27.85	28.15
Red Lead in Oil	30.65	31.30	31.60

## PATENT CHIMNEYS—

6-inch	\$2.50 lineal foot
8-inch	3.00 lineal foot
10-inch	4.00 lineal foot
12-inch	5.00 lineal foot

## PLASTER—

Neat wall, per ton delivered in S. F. in paper bags, \$17.60.

## PLASTERING (Interior)—

3 Coats, metal lath and plaster	Yard	\$3.00
Keene cement on metal lath		3.50
Ceilings with 3/4 hot roll channels metal lath (lathed only)		3.00
Ceilings with 3/4 hot roll channels metal lath plastered		4.50
Single partition 3/4 channel lath 1 side (lath only)		3.00
Single partition 3/4 channel lath 2 inches thick plastered		8.00
4-inch double partition 3/4 channel lath 2 sides (lath only)		5.75
4-inch double partition 3/4 channel lath 2 sides plastered		8.75
Thermax single partition; 1" channels; 2 1/4" overall partition width. Plastered both sides		7.50
Thermax double partition; 1" channels; 4 1/4" overall partition width. Plastered both sides		11.00

3 Coats over 1" Thermax nailed to one side wood studs or joists..... 4.50

3 Coats over 1" Thermax suspended to one side wood studs with spring sound isolation clip ..... 5.00

Note—Channel lath controlled by limitation orders.

## PLASTERING (Exterior)—

2 coats cement finish, brick or concrete wall	Yard	\$2.50
3 coats cement finish, No. 18 gauge wire mesh		3.50

Lime—\$4.00 per bbl. at yard.

Processed Lime—\$4.15 per bbl. at yard.

Rock or Grip Lath—3/4"—30¢ per sq. yd.

1/2"—29¢ per sq. yd.

Composition Stucco—\$4.00 sq. yd. (applied).

## PLUMBING—

From \$200.00 per fixture up, according to grade, quality and runs.

## ROOFING—

"Standard" tar and gravel, 4 ply \$13.00 per sq. for 30 sqs. or over.

Less than 30 sqs. \$16.00 per sq.

Tile \$40.00 to \$50.00 per square.

No. 1 Redwood Shingles in place, 4 1/2 in. exposure, per square ..... \$18.25

5/2 No. 1 Cedar Shingles, 5 in. exposure, per square..... 14.50

5/8 x 16"—No. 1 Little Giant Cedar Shingles, 5" exposure, per square 18.25

4/2 No. 1 24" Royal Cedar Shingles 7 1/2" exposure, per square 23.00

Roof at with Gravel \$5.50 per sq.

Asbestos Shingles, \$27 to \$35 per sq. laid, 1/2 to 3/4 x 25". Resawn Cedar Shakes, 10" Exposure ..... \$30.00

3/4 to 1 1/4 x 25" Resawn Cedar Shakes, 10" Exposure ..... \$35.00

1 x 25" Resawn Cedar Shakes, 10" Exposure ..... \$22.00

Above prices are for shakes in place.

## SEWER PIPE—

C.I. 6-in. to 24-in. B. & S. Class B and heavier, per foot..... \$99.50

Vitrified, per foot: L.C.L. F.O.B. Warehouse, San Francisco.

Standard, 8-in. .... \$ .66

Standard, 12 in. .... 1.30

Standard, 24-in. .... 5.41

Clay Drain Pipe, per 1,000 L.F. L.C.L., F.O.B. Warehouse, San Francisco: Standard, 6-in. per M. .... \$240.00

Standard, 8-in. per M. .... 400.00

Standard, 12-in. per M. .... 400.00

Standard, 24-in. per M. .... 400.00

Windows—Metal, \$2.50 a sq. ft. Fire doors (average), including hardware \$2.00 per sq. ft., size 12'x12'. \$3.75 per sq. ft., size 3'x6'.

SKYLIGHTS—(not glazed)

Galvanized iron, per sq. ft. .... \$1.25

Vented hip skylights, per sq. ft. .... 2.25

Aluminum, puttless, (unglazed), per sq. ft. .... 1.25

(installed and glazed), per sq. ft. .... 1.85

STEEL—STRUCTURAL—

\$290 per ton erected, when out of mill, \$350 per ton erected, when out of stock.

STEEL REINFORCING—

\$200.00 per ton, in place.

1/4-in. Rd. (Less than 1 ton) per 100 lbs. .... \$8.90

3/8-in. Rd. (Less than 1 ton) per 100 lbs. .... 7.80

1/2-in. Rd. (Less than 1 ton) per 100 lbs. .... 7.50

5/8-in. Rd. (Less than 1 ton) per 100 lbs. .... 7.25

3/4-in. & 7/8-in. Rd. (Less than 1 ton) .... 7.15

1 in. & up (Less than 1 ton) .... 7.10

1 ton to 5 tons, deduct 25c.

STONE FRONTS—

Individual estimates recommended. See ESTIMATORS DIRECTORY for Architectural Veneer (3), and Mosaic Tile (35).

TILE—

Ceramic Tile Floors—Commercial \$1.20 to \$1.60 per sq. ft.

Cove Base—\$1.40 per lin. ft. Quarry Tile Floors, 6x6" with 6" base @ \$1.35 per sq. ft.

Tile Wainscots & Floors, Residential, 4 1/4 x 4 1/4", @ \$1.65 to \$2.00 per sq. ft.

Tile Wainscots, Commercial Jobs, 4 1/4 x 4 1/4" Tile, @ \$1.50 to \$1.65 per sq. ft.

Asphalt Tile Floor 1/4" x 3/4" @ \$.18 x .35 sq. yd. Light shades slightly higher.

Cork Tile—.70 per sq. ft. Mosaic Floors—See dealers.

Linoleum Tile, per sq. ft. .... \$ .65

Rubber tile, per sq. ft. .... \$ .55 to \$ .75

Finishing Tile

12 x 12, each..... F.O.B. S. F. \$1.17

Kraftile: Per square foot Small Large Lots Lots

12 x 12 x 3/8-inch, plain, \$ .40 \$ .36

6 x 12 x 3/8-inch, plain, .44 .39

6 x 6 x 3/8-inch, plain, .46 .42

Building Tile—

8 1/2 x 12 inches, per M \$139.50

6 1/2 x 12 inches, per M 105.00

4 1/2 x 12 inches, per M 84.00

Hollow Tile—

12 x 12 inches, per M \$146.75

12 x 12 inches, per M 156.85

12 x 12 inches, per M 177.10

12 x 12 inches, per M 235.30

F.O.B. Port

VENETIAN BLINDS—

75c per square foot and up. Installation extra.

WINDOWS—STEEL—INDUSTRIAL—

Cost depends on design and quality required.

# ARCHITECT AND ENGINEER ESTIMATOR'S DIRECTORY

## Building and Construction Materials

**EXPLANATION**—Building and construction materials are shown in major classified groups for general identification purposes with names and addresses of suppliers of materials listed in detail under group classification where name first appears—main offices are shown first with branch or district offices following. The numeral appearing in listings \*(3) refers to the major group classification where complete data on the dealer, or representative, may be found.

<p><b>ADHESIVES (1)</b> Wall and Floor Tile Adhesives THE CAMBRIDGE TILE MFG. CO. *(35)</p>	<p>KRAFFILE *(35) REMILLARD-DANDINI CO. San Francisco 4: 400 Montgomery St., EX 2-4988</p>	<p><b>FLOORS (15)</b> Hardwood Flooring HOGAN LUMBER COMPANY Oakland: Second and Alice Sts., GL 1-6861 Floor Tile GLADDING, McBEAN &amp; CO. *(3) KRAFFILE *(35) Floor Tile (Ceramic Mosaic) THE CAMBRIDGE TILE MFG. CO. *(35) Floor Treatment &amp; Maintenance HILLYARD SALES CO. (Western) San Francisco: 470 Alabama St., MA 1-7766 Los Angeles: 923 E. 3rd, TR 9282 Seattle: 3440 E. Marginal Way Diversified (Magnesite, Asphalt Tile, Composition, Etc.) LE ROY OLSON CO. San Francisco 10: 3070 - 17th St., HE 1-0188 Sleepers (composition) LE ROY OLSON CO.</p>
<p><b>AIR CONDITIONING (2)</b> Air Conditioning &amp; Cooling UTILITY APPLIANCE CORP. Los Angeles 58: 4851 S. Alameda St. San Francisco: 1355 Market St., UN 1-4908</p>	<p><b>BRONZE PRODUCTS (8)</b> GREENBERG'S, M. &amp; SONS *(6)</p>	<p><b>GLASS (16)</b> W. P. FULLER COMPANY San Francisco: 301 Mission St., EX 2-7151 Los Angeles, Calif. Portland, Ore.</p>
<p><b>ARCHITECTURAL PORCELAIN ENAMEL (2a)</b> CALIFORNIA METAL ENAMELING CO. Los Angeles: 6904 E. Slauson, UN 01268 San Francisco: O'Keefe's, 55-11th St., UN 3-4445 Portland: Beaver Sheet Metal &amp; Roofing Co., 924 N. Russell St., TR 6766 Seattle: Teclar Aluminum Co., 625 Yale Ave N., SE B494 Salt Lake City: S. A. Roberts &amp; Co., 109 W. 2nd South, Salt Lake 4-4431 Phoenix: Baker-Thomas Co., 300 S. 12th, Phoenix 4-5503 Tucson: Laing-Garrett Co., 19 S. Tyndall Ave., TU 2-2893 Albuquerque: Welch-Irwin Corp., 1726 Lomas Blvd. NE.</p>	<p><b>BUILDING PAPERS &amp; FELTS (9)</b> ANGIER PACIFIC CORP. San Francisco 5: 55 New Montgomery St., DO 2-4416 Los Angeles: 7424 Sunset Blvd. PACIFIC COAST AGGREGATES, INC. *(11) SISALKRAFF COMPANY San Francisco 5: 55 New Montgomery St., EX 2-3066 Chicago, Ill.: 205 West Wacker Drive</p>	<p><b>GRANITE (16a)</b> PACIFIC CUT STONE &amp; GRANITE CO. 414 South Marengo Ave., Alhambra, Calif.</p>
<p><b>ARCHITECTURAL PORCELAIN ENAMEL (2b)</b> CALIFORNIA METAL ENAMELING CO. Los Angeles: 6904 E. Slauson, UN 01268 San Francisco: O'Keefe's, 55-11th St., UN 3-4445 Portland: Beaver Sheet Metal &amp; Roofing Co., 924 N. Russell St., TR 6766 Seattle: Teclar Aluminum Co., 625 Yale Ave N., SE B494 Salt Lake City: S. A. Roberts &amp; Co., 109 W. 2nd South, Salt Lake 4-4431 Phoenix: Baker-Thomas Co., 300 S. 12th, Phoenix 4-5503 Tucson: Laing-Garrett Co., 19 S. Tyndall Ave., TU 2-2893 Albuquerque: Welch-Irwin Corp., 1726 Lomas Blvd. NE.</p>	<p><b>BUILDING HARDWARE (9a)</b> THE STANLEY WORKS San Francisco: Manadnock Bldg., YU 6-5914 New Britain, Conn.</p>	<p><b>HEATING (17)</b> S. T. JOHNSON CO. Oakland 8: 940 Arlington Ave., OL 2-6000 San Francisco: 585 Potrero Ave., MA 1-2757 Philadelphia 8, Pa.: 401 N. Broad St. SCOTT COMPANY San Francisco: 243 Minna St., YU 2-0400 Oakland: 113 - 10th St., GL 1-1937 San Jose, Calif. Los Angeles, Calif. UTILITY APPLIANCE CORP. *(12) Electric Heaters WESIX ELECTRIC HEATER CO. San Francisco 5: 390 First St., GA 1-2211 Los Angeles: 520 W. 7th St., MI 8096 Portland: Terminal Sales Bldg., BE 2050 Seattle: Securities Bldg., SE 5028 Designer of Heating THOMAS B. HUNTER San Francisco 4: 41 Sutter St., GA 1-1164</p>
<p><b>ARCHITECTURAL VENEER (3)</b> Ceramic Veneer GLADDING, McBEAN &amp; CO. San Francisco: Harrison at 9th St., UN 1-7400 Los Angeles: 2901 Los Feliz Blvd., OL 2121 Portland: 110 S.E. Main St., EA 6179 Seattle: 1500 First Ave. S., EL 4711 Spokane: 1102 N. Monroe St., BR 3259 THE CAMBRIDGE TILE MFG. CO. *(35) Porcelain Veneer PORCELAIN ENAMEL PUBLICITY BUREAU Oakland 12: Room 601 Franklin Building Pasadena 8: P. O. Box 186, East Pasadena Station Granite Veneer VERMONT MARBLE COMPANY San Francisco 5: 525 Market St., SU 1-6747 Los Angeles: 3522 Council St., DU 2-7834 Marble Veneer VERMONT MARBLE COMPANY San Francisco 5: 525 Market St., SU 1-6747 Los Angeles: 3522 Council St., DU 2-7834</p>	<p><b>CABINETS &amp; FIXTURES (9b)</b> FINK &amp; SCHINDLER, THE; CO. San Francisco: 522 Brannan St., EX 2-1513</p>	<p><b>INSULATION AND WALL BOARD (8)</b> LUMBER MANUFACTURING CO. San Francisco: 225 Industrial Ave., JU 7-1760 PACIFIC COAST AGGREGATES, INC. *(11) SISALKRAFF COMPANY *(19) WESTERN ASBESTOS COMPANY San Francisco: 675 Townsend St., KL 2-3868 Oakland: 251 Fifth Avenue, GL 1-2345 Stockton: 733 S. Van Buren, ST 4-9421 Sacramento 1331 - T St., HU 1-0125 Fresno: 434 - P St., FR 2-1600</p>
<p><b>ARCHITECTURAL VENEER (3)</b> Ceramic Veneer GLADDING, McBEAN &amp; CO. San Francisco: Harrison at 9th St., UN 1-7400 Los Angeles: 2901 Los Feliz Blvd., OL 2121 Portland: 110 S.E. Main St., EA 6179 Seattle: 1500 First Ave. S., EL 4711 Spokane: 1102 N. Monroe St., BR 3259 THE CAMBRIDGE TILE MFG. CO. *(35) Porcelain Veneer PORCELAIN ENAMEL PUBLICITY BUREAU Oakland 12: Room 601 Franklin Building Pasadena 8: P. O. Box 186, East Pasadena Station Granite Veneer VERMONT MARBLE COMPANY San Francisco 5: 525 Market St., SU 1-6747 Los Angeles: 3522 Council St., DU 2-7834 Marble Veneer VERMONT MARBLE COMPANY San Francisco 5: 525 Market St., SU 1-6747 Los Angeles: 3522 Council St., DU 2-7834</p>	<p><b>CEMENT (10)</b> IDEAL CEMENT COMPANY (Pacific Division) San Francisco 4: 310 Sansome St., GA 1-4100 PACIFIC COAST AGGREGATES, INC. *(11)</p>	<p><b>IRON—Ornamental (10)</b> MICHEL &amp; PFEFFER IRON WORKS, INC. *(13) MICHEL &amp; PFEFFER IRON WORKS, INC. *(13) MICHEL &amp; PFEFFER IRON WORKS, INC. *(13) MICHEL &amp; PFEFFER IRON WORKS, INC. *(13) MICHEL &amp; PFEFFER IRON WORKS, INC. *(13) MICHEL &amp; PFEFFER IRON WORKS, INC. *(13) MICHEL &amp; PFEFFER IRON WORKS, INC. *(13) MICHEL &amp; PFEFFER IRON WORKS, INC. *(13) MICHEL &amp; PFEFFER IRON WORKS, INC. *(13) MICHEL &amp; PFEFFER IRON WORKS, INC. *(13)</p>
<p><b>BANKS - FINANCING (4)</b> CROCKER FIRST NATIONAL BANK OF S. F. San Francisco, Post &amp; Montgomery Sts., EX 2-7700</p>	<p><b>CONCRETE AGGREGATES (11)</b> Ready Mixed Concrete PACIFIC COAST AGGREGATES, INC. San Francisco: 400 Alabama St., KL 2-1616 Sacramento: 16th and A Sts., GI 3-6586 San Jose: 790 Stockton Ave., CY 2-5620 Oakland: 2400 Peralta St., GL 1-0177 Stockton: 820 So. California St., ST 8-8643 Lightweight Aggregates AMERICAN PERLITE CORP. Richmond: 26th &amp; 8. St. - Yd. 2, RI 4307</p>	<p><b>LANDSCAPING (20)</b> Landscape Contractors HENRY C. SOTO CORP. Los Angeles: 13,000 S. Avalon Blvd., ME 4-6617</p>
<p><b>BATHROOM FIXTURES (5)</b> Metal THE CAMBRIDGE TILE MFG. CO. *(35) Ceramic THE CAMBRIDGE TILE MFG. CO. *(35)</p>	<p><b>DOORS (12)</b> Hollywood Doors WEST COAST SCREEN CO. Los Angeles: 1127 E. 63rd St., AD 1-1108 W. P. FULLER CO. Seattle, Tacoma, Portland NICOLAI DOOR SALES CO. San Francisco: 3045 19th St. F. M. COBB CO. Los Angeles &amp; San Diego SOUTHWESTERN SASH &amp; DOOR Phoenix, Tucson, Arizona El Paso, Texas HOUSTON SASH &amp; DOOR Houston, Texas Screen Doors WEST COAST SCREEN DOOR CO. (See above)</p>	<p><b>LIGHTING FIXTURES (21)</b> SMOOT-HOLMAN COMPANY Inglewood, Calif., OR 8-1217 San Francisco: 55 Mississippi St., MA 1-8474</p>
<p><b>BRASS PRODUCTS (6)</b> GREENBERG'S, M. &amp; SONS San Francisco 7: 765 Folsom, EX 2-3143 Los Angeles 23: 125B S. Boyle, AN 3-7108 Seattle 4: 1016 First Ave. So., MA 5140 Phoenix: 3009 N. 19th Ave., Apt. 92, PH 2-7663 Portland 4: 510 Builders Exch. Bldg., AT 6443</p>	<p><b>FIRE ESCAPES (13)</b> MICHEL &amp; PFEFFER IRON WORKS, INC. South Linden &amp; Tanforan Ave. South San Francisco: JU 4-8362</p>	<p><b>BRICKWORK (7)</b> Face Brick GLADDING, McBEAN &amp; CO. *(13)</p>
<p><b>BRICKWORK (7)</b> Face Brick GLADDING, McBEAN &amp; CO. *(13)</p>	<p><b>FIREPLACES (14)</b> Heat Circulating SUPERIOR FIREPLACE CO. Los Angeles: 1708 E. 15th St., PR 8393 Baltimore, Md.: 601 No. Point Rd.</p>	<p><b>LANDSCAPING (20)</b> Landscape Contractors HENRY C. SOTO CORP. Los Angeles: 13,000 S. Avalon Blvd., ME 4-6617</p>

**LUMBER (22)**

Shingles  
LUMBER MANUFACTURING CO. \*(18)

**MARBLE (23)**

VERMONT MARBLE COMPANY  
San Francisco 5: 525 Market St., SU 1-6747  
Los Angeles 4: 3522 Council St., DU 2-7834

**METAL LATH EXPANDED (24)**

PACIFIC COAST AGGREGATES, INC. \*(11)

**MILLWORK (25)**

FINK & SCHINDLER, THE, CO: \*(96)  
LUMBER MANUFACTURING COMPANY \*(18)  
MULLEN MANUFACTURING COMPANY  
San Francisco: 60-8D Rausch St., UN 1-5815  
PACIFIC MANUFACTURING COMPANY  
San Francisco: 16 Beale St., GA 1-7755  
Santa Clara: 2610 The Alameda, SC 607  
Los Angeles, 6820 McKinley Ave., TH 4196

**PAINTING (26)**

Patrol  
W. P. FULLER COMPANY \*(16)

**PLASTER (27)**

Interiors - Metal Lath & Trim  
PACIFIC COAST AGGREGATES, INC. \*(11)  
Exteriors  
PACIFIC PORTLAND CEMENT COMPANY \*(28)

**PLASTIC CEMENT (28)**

IDEAL CEMENT COMPANY  
San Francisco: 310 Sansome St., GA 1-4100

**PLUMBING (29)**

THE HALSEY TAYLOR COMPANY  
Redlands, Calif.  
Warren, Ohio  
THE SCOTT COMPANY \*(17)  
HAWS DRINKING FAUCET COMPANY  
Berkeley 10: 1435 Fourth St., LA 5-3341  
CONTINENTAL WATER HEATER COMPANY  
Los Angeles 31: 1801 Pasadena Ave., CA 6178  
SIMONDS MACHINERY COMPANY  
San Francisco: 816 Folsom St., DO 2-6794  
Los Angeles: 455 East 4th St., MU 8322  
SECURITY VALVE COMPANY  
Los Angeles 31: 410 San Fernando Rd., CA 6191

**RANGE-REFRIGERATOR (29a)**

Combinations  
GENERAL AIR CONDITIONING CORP.  
Los Angeles 23: 4542 E. Dunham St.  
San Francisco: 420 Market St., DO 2-4194

**RESILIENT TILE (30)**

LE ROY OLSON CO. \*(15)

**SEWER PIPE (32)**

GLADDING, McBEAN & CO. \*(13)

**SHEET METAL (32)**

Windows  
DETROIT STEEL PRODUCTS COMPANY  
Oakland 8: 1310 - 63rd St., OL 2-8826  
San Francisco: Russ Building, DO 2-0890  
MICHEL & PFEFFER IRON WORKS, INC. \*(13)  
PACIFIC COAST AGGREGATES, INC. \*(11)

**Fire Doors**

DETROIT STEEL PRODUCTS COMPANY

**Skylights**

DETROIT STEEL PRODUCTS COMPANY

**STEEL—STRUCTURAL (33)**

COLUMBIA STEEL CO.  
San Francisco: Russ Bldg., SU 1-2500  
Los Angeles: 2087 E. Slauson, LA 1171  
Portland: 2345 N. W. Nicolai, BE 7261  
Seattle 1331 3rd Ave. Bldg., MA 1972  
Salt Lake City: Walker Bank Bldg., SL 3-6733  
HERRICK IRON WORKS  
Oakland: 18th & Campbell Sts., GL 1-1767  
JUDSON PACIFIC-MURPHY CORP.  
Emeryville: 4300 Eastshore Highway, OL 3-1717  
REPUBLIC STEEL CORP.  
San Francisco: 116 N. Montgomery St., GA 1-0977  
Los Angeles: Edison Building  
Seattle: White-Henry-Stuart Building  
Salt Lake City: Walker Bank Building  
Denver: Continental Oil Building  
SAN JOSE STEEL COMPANY  
San Jose 19S North Thirtieth St., CO 4184

**STEEL—REINFORCING (34)**

REPUBLIC STEEL CORP. \*(13)  
HERRICK IRON WORKS \*(13)  
SAN JOSE STEEL CO. \*(13)  
COLUMBIA STEEL CO. \*(13)

**CLAY TILE (35)**

THE CAMBRIDGE TILE MFG. CO.  
San Francisco 10: 470 Alabama St., UN 3-1666  
Los Angeles 19: 1335 S. La Brea, WE 3-7800  
GLADDING, McBEAN & CO. \*(13)  
KRAFTILE  
Niles, Calif.: Niles 3611  
San Francisco 5: 50 Hawthorne St., DO 2-3780  
Los Angeles 13: 406 South Main St., MU 7241

**TIMBER—REINFORCING (36)**

Trusses

**Tacoma, Wash.**

WYERHAEUSER SALES CO.  
St. Paul, Minn.  
Newark, N. J.  
Treated Timber  
J. H. BAXTER CO.  
San Francisco 4: 333 Montgomery St., DO 2-3883  
Los Angeles 13: 601 West Fifth St., MI 6294

**WALL TILE (37)**

THE CAMBRIDGE TILE MFG. CO. \*(13)  
GLADDING, McBEAN & CO. \*(13)  
KRAFTILE COMPANY \*(13)

**WINDOWS STEEL (38)**

DETROIT STEEL PRODUCTS CO. \*(12)  
MICHEL & PFEFFER IRON WORKS, INC. \*(13)  
PACIFIC COAST AGGREGATES, INC. \*(11)

**GENERAL CONTRACTORS (39)**

BARRETT & HILP  
San Francisco: 918 Harrison St., DO 2-0700  
Los Angeles: 234 W. 37th Place, AD 3-8161  
J. BETANCOURT  
San Bruno: 1015 San Mateo Ave., JU No B-7525  
DINWIDDIE CONSTRUCTION COMPANY  
San Francisco: Crocker Building, YU 6-2718  
CLINTON CONSTRUCTION COMPANY  
San Francisco: 923 Folsom St., SU 1-3440  
MATTOCK CONSTRUCTION COMPANY  
San Francisco: 604 Mission St., GA 1-5516  
E. H. MOORE & SONS  
San Francisco: 693 Mission St., GA 1-8579  
PARKER, STEFFENS & PEARCE  
San Francisco: 135 So. Park, EX 2-6639

**TESTING LABORATORIES****(ENGINEERS & CHEMISTS (40))**

ABBOT A. HANKS, INC.  
San Francisco: 624 Sacramento St., GA 1-1697  
ROBERT W. HUNT COMPANY  
San Francisco: 251 Kearny St., EX 2-4634  
Los Angeles: 3050 E. Slauson, JE 9131  
Chicago, New York, Pittsburgh  
PITTSBURGH TESTING LABORATORY  
San Francisco: 651 Howard St., EX 2-1747

## CONSTRUCTION CONTRACTS AWARDED AND MISCELLANEOUS PERSONNEL DATA

**FIRE STATION.** San Luis Obispo. City of San Luis Obispo, owner. Concrete block, apparatus room, dormitory, shower facilities, office and kitchen, 3000 sq. ft., composition roofing, concrete and asphalt tile floors, metal sash, painting, plastering, plumbing, electrical work, \$32,000. ARCHITECT: Kenneth H. Hess, Ventura. GENERAL CONTRACTOR: Marino Construction Co., San Luis Obispo.

**FORD ASSEMBLY PLANT.** Milpitas, Santa Clara county, Ford Motor Co., Dearborn, Michigan, owner. One-story assembly bldg., 790x1,700 ft., structural steel frame, pre-cast reinforced concrete panels, aluminum sash, aluminum slide panels, metal roof deck, administration bldg., 2 story, and police

facilities, brick exterior; other bldgs., Utility, Loading dock, oil house, check-out, Oxygen-Acetylene, storage, vaporizer plant, industrial waste bldg., total floor area, 1,500,000 sq. ft., \$8,661,000. ARCHITECT: Albert Kahn & Associates, Detroit, Michigan. GENERAL CONTRACTOR: J. H. Pomeroy & Co., San Francisco.

**ELK CLUBHOUSE REMODEL.** Red Bluff, Tehama county. B.P.O. Elks No. 1250 Hall Association, Red Bluff, owner. Two story reinforced concrete and frame remodel and addition to the Elks Clubhouse, basement, \$100,000. ARCHITECT: Albert W. Kahn, San Mateo.

**SCHOOL ADDN.,** Oceanside, San Diego county, Oceanside-Libby Union School Dis-

trict, Oceanside, owner. Comprises alterations and additional facilities to the Ditmar Elementary School, \$189,571. ARCHITECT: Sam Hamill, San Diego. GENERAL CONTRACTOR: Colton Construction Co., Chula Vista.

**OFFICE BLDG.,** Fresno. Benner Packing Co., Fresno, owner. Two-story brick and structural steel construction, steel sash, composition roof, \$110,000. ARCHITECT: Alastair Simpson, Fresno. GENERAL CONTRACTOR: L. H. Hansen & Sons, Fresno.

**PHOTO DEVELOPMENT PLANT,** Berkeley, Alameda county, Bennetts Photo Service, Berkeley, owner. One-story concrete block and frame construction, 50x110 ft., \$46,500. ARCHITECT: C. W. Dennis, Oakland. GENERAL CONTRACTOR: Hans Dobkowitz, Berkeley.

**MACHINE SHOP,** Glendale, Los Angeles county. Superior Tool & Die Corp., Glendale, owner. Reinforced concrete manufacturing and machine shop building, composition roofing, concrete slab floor, steel beams, wood trusses, mezzanine, crane-way.



fire and metal doors, heating room, steel roll-up doors, toilets with ceramic tile, vault, offices with interior plaster, steel sash, brick planters, kitchen unit, asphalt paving, 171x213 ft., \$125,000. ENGINEER: Frank O. Bigelo, Pasadena. GENERAL CONTRACTOR: O. K. Earl, Jr., Pasadena.

**NEW JUNIOR HIGH SCHOOL, Sacramento.** Sacramento Board of Education, Sacramento, owner. Frame and stucco High School comprising 19-classes, administration offices, 4 home economics rooms, 4 shop rooms, 2 music rooms, speech, cafeteria, kitchen, shower, locker and toilet rooms,

120,000 sq. ft. floor area, \$1,705,000. ARCHITECT: Gordon Stafford, Sacramento. GENERAL CONTRACTOR: Continental Const. Co., Sacramento.

**TV BROADCASTING STATION, Stockton, San Joaquin county.** KFTN TV Station, Stockton, owner. Concrete block and frame construction, \$69,696. ARCHITECT: Mayo, Johnson & De Wolf, Stockton. GENERAL CONTRACTOR: Craft Const. Co., Stockton.

**SCHOOL ADDN., Orange Glen, San Diego county.** Orange Glen School District, San Diego, owner. Addition of a classroom to

the Orange Glen school, \$33,434. ARCHITECT: Walter C. See, San Diego. GENERAL CONTRACTOR: P. A. Oberhauser, Escondido.

**BANK BLDG., La Habra, Los Angeles county.** Bank of America, Los Angeles, owner. One story and mezzanine, frame and cement plaster bank building, composition roofing, concrete and terrazzo floor, asphalt tile floor covering, plate glass and metal trim, metal sash, painting, plastering, plumbing, electrical work, heating and ventilating, 10,375 sq. ft., \$104,600. ARCHITECT: Raymond Shaw (Capitol Co.), Los

## BUILDING TRADES WAGE (JOB SITES) NORTHERN, CENTRAL AND SOUTHERN CALIFORNIA

ATTENTION: The following are the PREVAILING hourly rates of compensation being paid and in effect by employers by agreement between employees and their union; or as recognized and determined by the U. S. Department of Labor. (June 1, 1953.)

CRAFT	San Francisco	Alameda	Contra Costa	Fresno	Sacramento	San Joaquin	Santa Clara	Solano	Los Angeles	San Bernardino	San Diego	Santa Barbara	Kern
ASBESTOS WORKERS	\$2.585	\$2.585	\$2.585	\$2.585	\$2.585	\$2.585	\$2.585	\$2.585	\$1.725	\$1.775	\$2.25	\$2.25	\$2.25
BOILERMAKERS	2.68	2.68	2.68	2.68	2.68	2.68	2.68	2.68	1.94	1.94	2.75	1.75	1.75
BRICKLAYERS	3.25	3.25	3.25	3.00	3.25	3.00	3.45	3.25	1.94	1.94	1.94	1.94	1.94
BRICKLAYERS, HODCARRIERS	2.45	2.45	2.45	2.00	2.40	2.25	2.45	2.45	1.94	1.94	1.94	1.94	1.94
CARPENTERS	2.60	2.60	2.54	2.54	2.54	2.54	2.54	2.54	2.57	2.57	2.57	2.57	2.65
CEMENT FINISHERS	2.57	2.57	2.57	2.57	2.57	2.57	2.57	2.57	2.57	2.57	2.57	2.57	2.57
CONCRETE MIXER—Skip Type (1-yd.)	2.28	2.28	2.28	2.28	2.28	2.28	2.28	2.28	2.38	2.38	2.38	2.38	2.38
ELECTRICIANS	3.00	3.00	3.00	3.00	3.00	3.00	3.00	3.00	3.00	3.00	3.00	3.00	3.00
ELEVATOR CONSTRUCTORS	2.75	2.75	2.45	2.75	2.915	2.915	2.915	2.915	2.25	2.25	2.25	2.25	2.25
ENGINEERS: MATERIAL HOIST	2.56	2.56	2.56	2.56	2.56	2.56	2.56	2.56	1.9875	1.9875	1.9875	1.9875	1.9875
GLAZIERS	2.30	2.30	2.30	2.30	2.25	2.30	2.30	2.50	2.26	2.26	2.26	2.26	2.26
IRONWORKERS: ORNAMENTAL	2.70	2.70	2.70	2.70	2.70	2.70	2.70	2.70	2.70	2.70	2.70	2.70	2.70
REINF. STREET	*2.60	2.60	2.60	2.60	2.60	2.60	2.60	2.60	2.61	2.61	2.61	2.61	2.61
STRUCTURAL STEEL	*2.85	2.85	2.85	2.85	2.85	2.85	2.85	2.85	2.70	2.70	2.70	2.70	2.70
LABORERS: BUILDING	1.85	1.85	1.85	1.85	1.85	1.85	1.85	1.85	1.94	1.94	1.94	1.94	1.94
CONCRETE	1.85	1.85	1.85	1.85	1.85	1.85	1.85	1.85	1.94	1.94	1.94	1.94	1.94
LATHERS	3.25	3.50	3.00	3.00	3.00	3.00	3.4375	3.00	3.125	3.125	3.125	3.125	3.125
MARBLE SETTERS	2.95	2.95	2.95	2.95	2.95	2.95	2.95	2.95	2.875	2.875	2.875	2.875	2.875
MOSAIC & TERRAZZO	2.76	2.76	2.76	2.76	2.76	2.76	2.76	2.76	2.40	2.40	2.40	2.40	2.40
PAINTERS—BRUSH	*2.60	2.60	2.60	2.60	2.625	2.45	2.45	2.27	2.56	2.50	2.53	2.22	2.22
PAINTERS—SPRAY					2.91	2.91	2.68						
PILEDRIVERS—OPERATOR	2.75	2.75	2.75	2.75	2.75	2.75	2.75	2.75	2.74	2.70	2.70	2.70	2.70
PLASTERERS	3.125	3.165	3.125	3.125	3.00	3.00	3.125	3.00	3.125	3.125	3.125	3.125	3.125
PLASTERERS, HODCARRIERS	2.60				2.50	2.50		2.50	2.375	2.25	2.30	2.00	2.00
PLUMBERS—STEAM FITTERS	2.90	2.90	2.875	2.75	2.90	2.75	2.75	2.90	2.90	2.90	2.90	2.90	2.90
ROOFERS	2.50	2.50	2.50	2.25	2.50	2.50	2.50	2.50	2.65	2.00	1.90	2.00	2.00
SHEET METAL WORKERS	2.475	2.475	3.3125	2.43	2.75	2.50	2.40	2.415	2.475	2.475	2.175	2.00	2.475
SPRINKLER FITTERS	2.75	2.70	2.70	2.425	2.625	2.625	2.75	2.75	2.25	2.25	2.25	2.25	2.25
STEAM FITTERS	2.75	2.90	2.75	2.625	2.625	2.75	2.75	2.90	2.90	2.90	2.90	2.90	2.90
TRACTOR OPERATOR	2.67	2.67	2.67	2.67	2.67	2.67	2.67	2.67	2.52	2.52	2.52	2.52	2.52
TRUCK DRIVERS—1/2 Ton or less	1.89	1.89	1.89	1.89	1.89	1.89	1.89	1.89	2.02	2.02	2.02	2.02	2.02
TILESETTERS	2.955	2.955	2.955	2.955	2.955	2.955	2.955	2.955	2.65	2.65	2.65	2.65	2.65

\* 6 Hour Day. \*\* 7 Hour Day. \*\*\* Before C.I.S.C for 15c increase.

Prepared and compiled by:

CENTRAL CALIFORNIA CHAPTER, ASSOCIATED GENERAL CONTRACTORS OF AMERICA, with the assistance and cooperation of secretaries of General Contractors Associations and Builders Exchanges of Northern California; and the above information for southern California is furnished by the Labor Relations Department of the Southern California Chapter, ASSOCIATED GENERAL CONTRACTORS OF AMERICA.

# CLASSIFIED ADVERTISING

RATE: 20c PER WORD . . . CASH WITH ORDER

MINIMUM \$5.00

**YOUNG MAN SEEKS OPPORTUNITY**—Young man with good background in the construction industry, seeks opportunity with Contractor. Primary consideration chance to advance to executive position in future. College graduate. INQUIRE, Box 521, ARCHITECT & ENGINEER magazine, 68 Post St., San Francisco.

**ARCHITECTURAL SLIDING SLEEL SASH.** One lot only — new, half price. 13 units, assorted sizes, 353 square feet total. 3 at 7 ft. x 5 ft.; 4 at 7 ft. x 4 1/2 ft.; 1 at 6 ft. x 4 1/2 ft.; 2 at 6 ft. x 4 ft.; 1 at 7 ft. x 3 1/2 ft.; 1 at 4 1/2 ft. x 3 ft.; 1 at 3 ft. x 3 ft. Phone Delaware 3-7378, San Francisco.

**COLLECTIONS**—Thoroughly experienced in all phases of the collection business; your interests protected at all times; bonded agents everywhere; no collection no charge; California Material Dealers Service Co., 925 Hearst Bldg., San Francisco. Ernest T. Langley, Manager.

**BUILDERS!** You can make more money; get information you need before it is published elsewhere; Subscribe to the daily ARCHITECTS REPORTS, only \$10.00 per month. Complete information from ARCHITECTS REPORTS, 68 Post Street, San Francisco. Phone DOuglas 2-8311.

**PHOTOGRAPHY.** For the best in construction photography, including exterior and interior, aerial, and progress views . . . you will find as many others have that it's the SKELTON STUDIOS, 875 O'Farrell St., San Francisco. Telephone PROspect 6-1841.

**ESTIMATING SERVICE for Architects and Engineers**—Quantity Surveys—Complete Estimates. CHARLES C. REID, 1333 W. 41st Place, Los Angeles. EXPERIENCED—ACCURATE—PROMPT—FEES REASONABLE.

**HOME BUYERS**—Now building moderate priced homes in Sacramento and Marysville area; we are in a position to serve your needs. "Better Built Homes" by Ronne, Ronne & Ronne, Builders, 520 9th Street, Sacramento.

Angels. GENERAL CONTRACTOR: Steed Bros., Alhambra.

**HOSPITAL ADDN.**, Sparks, Nevada. State of Nevada, State Planning Board, Carson City, owner. One-story, basement, reinforced concrete frame and roof, brick walls, to provide facilities for kitchen, commissary and cafeteria, \$210,033. ARCHITECT: Russell Mills, Reno. GENERAL CONTRACTOR: Walker Boudwin Const. Co., Reno.

**INDUSTRIAL BLDG.**, Whittier, Los Angeles county. Catalina, Inc., Whittier, Lessee. Reinforced brick and flagstone veneer, tapered steel girders, composition roofing, rotary roof ventilators, steel sash, fire sprinkler system, concrete slab, asphalt tile floor in office area, drywall partitions, steel overhead doors, toilets, asphalt paving, 140x120 ft., \$94,500. ENGINEER: George V. Novikoff, Los Angeles. GENERAL CONTRACTOR: Carpenter Building Co., Los Angeles.

**WAREHOUSE & OFFICE**, Los Angeles. Chase Brass & Copper Co., Los Angeles, owner. One-story reinforced concrete warehouse and office, composition roofing, concrete floor, asphalt tile floor covering, metal sash, skylights, acoustical work, painting, plastering, plumbing, electrical work, complete air conditioning in office area, fencing and asphalt concrete paving, 50,000 sq. ft. ARCHITECT: John J. Kewell, Los Angeles. GENERAL CONTRACTOR: George W. Carter Co., Los Angeles.

**SPALDING NASH HALL**, Coronado, San Diego county. Christ Episcopal Church, Coronado, owner. Two-story building will

contain 9-classrooms, toilets, built-up gravel roof, frame construction, warm air heating, terrazzo, plaster, \$32,804. ARCHITECT: Paderewski, Mitchell & Dean, San Diego. GENERAL CONTRACTOR: Riha Const. Co.,

**ELEMENTARY SCHOOL**, Gerber, Tehama county. Gerber Elementary School District, Gerber, owner. Frame and stucco Elementary School building, 10-classrooms, multipurpose rooms, kitchen, toilets, oil burner, forced hot water heating system, asphalt tile floors, \$343,530. ARCHITECT: Clayton Kantz, Redding.

**HIGH SCHOOL ADDN.**, Angels Camp, Calaveras county. Bret Harte Union High School District, Angeles Camp, owner. Structural steel combination gymnasium and music building addition to the High School, contains 12,285 sq. ft., \$123,997. ARCHITECT: Albert M. Dreyfus, Sacramento. GENERAL CONTRACTOR: Graham & Jensen, Merced.

**GIRLS GYMNASIUM BLDG.**, Sunnyvale, Santa Clara county. Fremont Union High School District, Sunnyvale, owner. Structural steel frame, frame and stucco, concrete floors, \$183,178. ARCHITECT: Masten & Hurd, San Francisco. GENERAL CONTRACTOR: N. A. Lamb, Campbell.

**NOSE DOCKS**, Fairchild Air Force Base, Spokane, Washington. Seattle District Corps of Engineers, Seattle, owner. Ten multipurpose airplane nose docks at the Fairchild AFB near Spokane, \$2,989,634. GENERAL CONTRACTOR: Campbell Const. & Equipment Co., San Francisco.

**HIGH SCHOOL ADDN.**, Tulare. Tulare Union High School District, Tulare, owner. 1-story reinforced concrete, 60x120 ft. Shop Building addition to High School, \$55,753. ARCHITECT: Robt. C. Kaestner, Visalia. GENERAL CONTRACTOR: Ralph Utter, Tulare.

**ST. VIBIANA CHURCH**, Los Angeles. St. Vibiana Church, Los Angeles, owner. Alterations to sacristy, includes new stud and plaster partitions, cabinet work, electrical work, gas heating unit, \$70,000. ENGINEERS: Beatty & Clar, Los Angeles. GENERAL CONTRACTOR: Ben K. Tanner & Son, Beverly Hills.

**OFFICE AND WAREHOUSE**, Long Beach. Continental Baking Co., Beverly Hills, owner. Concrete block, corrugated iron roof, concrete and asphalt tile floors, sliding wood doors, metal sash, interior plaster, toilet facilities, 10,200 sq. ft., \$40,000. Hollywood. GENERAL CONTRACTOR: M. L.

**NEWSPAPER BLDG.**, Fresno. The Fresno Guide, Fresno, owner. One-story and mezzanine, reinforced brick, concrete floors, wood roof with composition roofing, 10,000 sq. ft., \$74,999. ARCHITECT: Wm. Hastrup, Fresno. GENERAL CONTRACTOR: L. H. Hansen & Sons, Fresno. STRUCTURAL ENGINEER: M. J. Gabrielsen, Marvin Co., Los Angeles.

**REHABILITATE ELEMENTARY SCHOOL**, Horace Mann, Bakersfield. Bakersfield City School District, Bakersfield, owner. Rehabilitation of Horace Mann Elementary School; old building area; remove brick facing and replace with granite; install wood trusses; modernization 6-classrooms and 2-kindergartens; install linoleum, acoustic tile, cabinets and sinks, diagonal sheathing for roof with built-up roofing,

\$115,277. ARCHITECT: Ernest L. McCoy, Bakersfield. GENERAL CONTRACTOR: L. H. Neudock, Bakersfield.

**CITY HALL ADDN.**, Los Banos, Merced County. City of Los Banos, Los Banos, owner. Remodel interior of existing Clerk's Office and convert for use by the Chief of Police; brick and reinforced concrete construction, tile roof, Class I type, \$59,800. ARCHITECT: Jas. P. Lockett, Visalia. GENERAL CONTRACTOR: Ted Falasco, Los Banos.

**STORE BLDG.**, Ventura. Steel frame store building, 100x80 ft. area, tapered steel girders, wood roof framing, composition roofing, porcelain enamel and ceramic tile facing. ARCHITECT: Carl L. Maston, Los Angeles.

**SCHOOL CAFETERIA**, Elementary School, Cypress, Orange county. Cypress Elementary School District, Cypress, owner. Frame bldg, 65x52 ft., composition roofing, wood roof trusses, hardwood and plywood floors with asphalt tile and linoleum flooring, metal kitchen equipment, plumbing and electrical work, and miscellaneous cabinet and mill work, \$51,145. ARCHITECT: Harold C. Wildman, Long Beach. GENERAL CONTRACTOR: J. Ray Construction Co., Corona Del Mar.

**RICE DRYING PLANT**, Stockton, San Joaquin county. Rosenberg Bros. & Co. San Francisco, owners. Eight 25 ft. in diameter and 100 ft. high, reinforced concrete grain storage silos, \$500,000. ENGINEER: MacDonald Engineering Co., San Francisco. GENERAL CONTRACTOR: Mac Donald Engineering Company, San Francisco.

**BANK & OFFICE BLDG.**, Reno, Nevada. First National Bank of Nevada, Reno, owner. 4-story, with basement and pent-house; type II structural steel frame, reinforced concrete, terra cotta front, \$587,000. ARCHITECT: Ferris & Erskine, Reno. GENERAL CONTRACTOR: Haas & Haynie, San Francisco.

**ATHLETIC FIELD LIGHTING**, El Rancho High School, Rivera, Orange County. Whittier Union High School District, Whittier, owner. Installation of complete equipment for flood-lighting athletic field, \$32,988. ARCHITECT: William H. Harris, Los Angeles. GENERAL CONTRACTOR: Sutton & Frost, Los Angeles.

**HIGH SCHOOL ADDN.**, Orisi, Tulare county. Orisi Union High School Orisi, owner. 7-Classroom, administration, music, shower and locker rooms, and toilet rooms, frame and stucco construction, \$505,971. ARCHITECT: Robert Kaestner, Visalia. GENERAL CONTRACTOR: Harris Construction Co., Fresno.

**DWELLING**, Barstow. Leonard M. Jones, Barstow, owner. Three bedroom frame and stucco; 1200 sq. ft., white rock wall, slab and cork floors, interior plaster, wall heaters, laminated plastic in kitchen, brick fireplace, plate glass slab doors, double sink, automatic washer and dryer, horizontal sliding windows, insulation, evaporative cooler, cabinet work, sliding wardrobe doors, cesspool and septic tank, plumbing, electrical work. ARCHITECT: Michael J. Murphy, San Bernardino.

**MARINE OIL TERMINAL**, Oleum, Contra Costa county. Union Oil Company, Los Angeles, owner. T-shaped pier, 136x1250 ft. long; small office building of reinforced concrete construction, \$5,000,000. DRAWINGS: Engineering Department of Union

## SLEEPERS

UNI-BOND—PRECAST—  
PERMANENT—NEVER ROT—  
PERMANENTLY  
NAIL PENETRABLE  
FIRE PROOF  
SECURELY BONDED TO  
THE CONCRETE SLAB

Make Solid Non-Squeaking  
Permanent Wood Flooring

Used in spring floor construction for  
Gymnasiums and dance floors, also  
under solid wood floor construction.  
Spaced on any centers desired. Specifications and information available on request.

Territories open for qualified representatives. Free consultation service.

**LeROY OLSON  
COMPANY**

3070 Seventeenth Street,  
San Francisco, California





the buildings which will be of reinforced concrete and will cost approximately \$2,750,000.

#### GROUND BROKEN FOR NEW FACTORY

Ground has been broken and construction started on the new plant of the Plexolite Corp in El Segundo, adjacent to the Los Angeles International Airport. It will contain over 30,000 sq. ft. of manufacturing floor space, general offices, railroad siding and automobile and truck parking.

Designed by George Novikoff, the new manufacturing facilities will represent an investment of \$250,000, and according to David S. Perry, president of Plexolite, the plant will be the largest of its kind in the nation and will be adequate to meet the expanding demand for the firms manufactured products which are used extensively in residential and industrial application.

#### PHOENIX AREA HAS SHOPPING CENTERS

The steady growth of Phoenix, Arizona, is accompanied by a continued construction of shopping centers and a recent survey discloses the following projects.

Homes & Son Construction Company have

a new center in Northwest Village to provide facilities for 23 stores and will cost \$400,000.

Farmer & Godfrey Construction Company has a \$55,000 contract for an 8-unit store building at 500 E. Camelback Road.

The John Long Construction Company has a \$200,000 shopping center underway in the Maryvale Home area.

The H. & J. Construction Company is erecting a building at N. 16th Street and Missouri Ave. at a cost of \$110,000, and Kim Tang is building an 8-unit store building at E. Indian School Road and 24th St. at a cost of \$100,000.

#### HAWAIIAN HOTEL

Architects Oleg N. Ivanitsky and Roy G. Watanabe of El Cerrito, California, have been commissioned to draft plans and specifications for the construction of an 8-story, 250 room reinforced concrete hotel building to be built in Honolulu, Hawaii.

Estimated cost of the project is \$1,500,000.

#### PAPER PULP PLANT AT FLAGSTAFF

The first paper pulp plant in Arizona is built near Flagstaff by the Coconino Pulp

and Paper Company. Daily production will be 25-tons of a crude type of paper known as wet lamp mats which will be sent to the west coast for further processing.

James M. Potter, Phoenix, is president of the company, capitalized at \$3,000,000. Twenty to thirty men will be employed in the plant with additional crews in the forests cutting and hauling jack pines.

#### ARCHITECT SELECTED

Directors of the Parks Victory Memorial Hospital, Napa, California, commissioned architect Gene Verge of Los Angeles to draw plans and specifications for the construction a new 100-Bed Hospital Building to be built in Napa.

Facilities of the new building will include surgery, X-Ray, and various laboratories.

#### ARCHITECT MOVES OFFICES

Architect Donald G. French, has announced the opening of new offices at 757 Kains Avenue, San Bruno, California, where he will continue the general practice of architecture. Offices were formerly located a 217½ El Camino Real, same city.

#### NEW EASY-FIT RADIATOR COVERS

Easy-fit radiator enclosures are available now in 34 convenient readymade sizes, and are available in department stores, furniture stores, and hardware dealers. Recently introduced, they are attracting attention of style and budget conscious homemakers who want to cover up radiators.

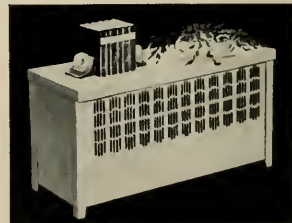

Made in four choice finishes—walnut, mahogany, ivory and white—all are baked-on enamel; made of heavy furniture steel, rigidly welded, built in valve door. Protect walls and draperies from dust and smudge, but do not retard radiator heat.

Built by Quaker City Metal Products Corp., 200 N. 14th St., Brooklyn, New York.

#### AIR FORCE FUNDS RECENTLY APPROVED

Among Army, Navy and Air Force projects throughout northern California recently receiving appropriation approvals were:

Herlong - Lassen County - Sierra Ordinance Depot storage and operational facilities, \$543,000;

Alameda, Alameda County Naval Air Station jet engine test cells, \$1,700,000;

Merced, Merced County - Castle Air Force Base, airfield pavements, aircraft maintenance, storage facilities and utility installations, \$1,370,000;

Sacramento, Sacramento County - McClellan Air Force Base, airfield, pavements, liquid fuel storage and dispensing, communications and air field lighting opera-

MECHANICAL ELECTRICAL INDUSTRIAL

## GEORGE S. ERSKINE & ASSOCIATES

CONSULTING ENGINEERS

1618 EL CAMINO REAL

MENLO PARK, CALIFORNIA

PHONE COLLECT GAVENPORT 3-1396

TWENTY SEVEN YEARS :: FOUNDED 1926

## VALUABLE NEWS SERVICE

- BUILDING MATERIAL DEALERS
- CONTRACTORS
- SUB-CONTRACTORS
- MANUFACTURERS AND REPRESENTATIVES

**ARCHITECTS REPORTS** gives advance news on construction projects in Northern California, lists: name of projects, location, architect, proposed cost and other pertinent information.

**HANDY** individual slip-reports, issued daily at a total cost of only

\$10 a month

## ARCHITECT'S REPORTS

Published Daily

The ARCHITECT and ENGINEER, Inc.

68 Post Street, San Francisco - DO 2-8311

## MULLEN MFG. COMPANY

BANK, STORE AND OFFICE  
FIXTURES—CABINET WORK  
OF GUARANTEED QUALITY  
CHURCH SEATING

Office and Factory  
60-80 RAUSCH ST., Bet. 7th and 8th Sts.  
San Francisco  
Telephone UNDERhill 1-5815

## E. H. MOORE & SONS

GENERAL  
CONTRACTORS



693 MISSION STREET  
SAN FRANCISCO

## CLASSIFIED ADVERTISING

Will Bring Results

—USE—

ARCHITECT  
and  
ENGINEER

68 Post St. San Francisco

*Fine*  
**ENGRAVINGS**

**POOR  
RICHARD**  
PHOTO ENGRAVING CO.  
320-324 COMMERCIAL STREET  
SAN FRANCISCO 31

tional and air craft maintenance facilities,  
\$5,638,000;

Fairfield, Solano County—Travis Air  
Force Base, storage facilities, \$37,000;

San Rafael, Marin County—Hamilton  
Air Force Base, storage facilities, \$162,000;

Sacramento, Sacramento County—Mather  
Air Force Base, airfield, pavements, liquid  
fuel storage and dispensing, airfield light-  
ing, operation, mess facilities, utilities, land  
and storage, \$1,847,000.

### SHOPPING CENTER STORE COMPLETED

The Expectation Shops, located in down-  
town San Francisco, has completed con-  
struction of the interior of a new store in  
Stonestown Shopping Center and will soon  
occupy the site.

The architectural firm of Hertzka &  
Knowles, AIA, were designers of the new  
store facilities.

### NEW TYPE FILTER FOR PLANT WATER

A new type filter employing diatomite  
filtering for plant water has been intro-  
duced by the Sparkler Mfg. Co. of Munde-  
lein, Ill. Fine uniform filtering is obtained  
with a surface type diatomite filter and  
can be used for large volume water filter-  
ing with complete success, according to  
the manufacturer.

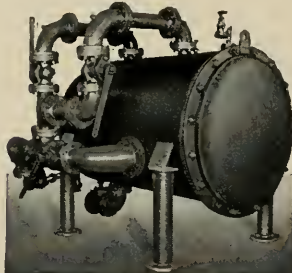

Operating engineers report that daily  
laboratory tests show this filter will com-  
pletely remove suspended matter either col-  
loidal or solid, bacteria 80% to 100% de-  
pending upon type of bacteria and grade of  
diatomite used. Thus reducing the re-  
quired chlorination to a very low point.  
Sizes vary from 25 sq. ft. to 100 sq. ft. of  
filtering surface; flow capacities over  
2½M/G/D per unit.

### GARAGE BUILDING

The City of Reno, Nevada, has entered  
into a contract with Reno Garages Inc.,  
for construction of a 4-story, reinforced  
concrete garage building that will provide  
for 500 car parking.

The new garage is to be built on West  
1st Street, next to the Security National  
Bank Building.

Contract for the construction has been  
awarded to Haas & Haynie Contractors of  
San Francisco. Estimated cost is \$1,000,000.

### LEONA WICKHAM NAMED ADVERTISING MANAGER

Leona Wickham has been appointed ad-  
vertising and customer relations manager  
for the Bobrick Manufacturing Corp., Los  
Angeles, according to William S. Louch-  
heim, president.

Mrs. Wickham was formerly with the  
Barton A. Stebbens Advertising Agency,  
Los Angeles office.



## HERRICK IRON WORKS STRUCTURAL STEEL REINFORCING STEEL

18TH AND CAMPBELL STS.  
OAKLAND, CALIF.  
Phone GLencourt 1-1767

Phone GARfield 1-1164

## Thomas B. Hunter

DESIGNER OF HEATING

AIR CONDITIONING  
VENTILATING AND WIRING  
SYSTEMS, MECHANICAL  
AND ELECTRICAL EQUIP-  
MENT OF BUILDINGS



41 SUTTER STREET  
ROOM 710

San Francisco

California

Subscribe  
Now —

ARCHITECT  
and  
ENGINEER

\$3.00  
Per Year

DINWIDDIE  
CONSTRUCTION  
COMPANY

BUILDERS

CROCKER BUILDING  
SAN FRANCISCO

**PITTSBURGH  
TESTING LABORATORY**

**ENGINEERS AND CHEMISTS**

Testing and Inspection of Concrete,  
Steel and Other Structural Materials

Design of Concrete Mixes  
Offices in all principal cities

651 Howard St., San Francisco 5  
EXbrook 2-1747

**MATTOCK  
CONSTRUCTION  
COMPANY**



**BUILDERS**



604 MISSION STREET  
SAN FRANCISCO

**ARCHITECT  
and  
ENGINEER**

Please enter my subscription for  
..... year.... My check in the  
amount of \$..... is attached.

1 year . . . . \$3.00  
2 years . . . . 5.00

Name .....

City.....

State.....

**ABBOT A. HANKS, INC.  
Engineers & Chemists**

INSPECTING — TESTING — CONSULTING  
CONCRETE • STEEL • MATERIALS  
CHEMICAL AND TESTING  
LABORATORIES

- RESEARCH AND INVESTIGATION •
- TESTS OF STRUCTURAL MATERIALS
- DESIGN OF CONCRETE MIXES
- SHOP AND ERECTION INSPECTION OF  
STRUCTURES AND EQUIPMENT
- INVESTIGATION OF STRUCTURES  
AND MATERIALS
- TESTS AND INVESTIGATION OF  
FOUNDATION SOILS
- FIRE RESISTANCE AND INSULATION  
TESTS

624 Sacramento Street, San Francisco

**Index to Advertisers**

ARCHITECTS Reports . . . . . 48

BETTANCOURT, Jos. .... 37

CAMBRIDGE Tile Mfg. Company..... \*

CLAY Brick & Tile Association..... 9

CLASSIFIED Advertising ..... 45

CLINTON Construction Company..... 38

CROCKER First National Bank..... \*

DINWIDDIE Construction Company .. 49

ERSKINE, Geo. S. & Associates..... 48

FINK & SCHINDLER Co., The ..... 36

FORMERER Cornice Works..... 37

GENERAL Chef ..... 5

GLADDING, McBean & Company..... 1

GREENBERG'S, M. Sons..... 34

HAAS & HAYNIE Const. Co..... 38

HANKS, Abbott A., Inc..... 50

HAWS Drinking Faucet Co.....30 & 31

HERRICK Iron Works..... 49

HOGAN Lumber Co..... 38

HUNT, Robert W. Company..... 50

HUNTER, Thos. B. .... 49

IDEAL Cement Co..... Back Cover

JOHNSON, S. T. Co. .... \*

JUDSON, Pacific-Murphy Corp..... 38

KRAFTILE Company ..... 28

MARBLE Institute of America..... 2

MATTOCK Construction Co..... 50

MICHEL & Pfeffer Iron Works,  
Inc..... Inside Front Cover

MOORE, E. H. & Son..... 49

MULLEN Mfg. Co..... 49

OLSON, LeRoy Co..... 46

PACIFIC Coast Aggregates..... 29

PACIFIC Cut Stone & Granite Co..... 38

PACIFIC Manufacturing Co..... 39

PACIFIC Telephone & Telegraph Co... 47

PARKER, Steffens & Pearce..... 37

PITTSBURGH Testing Laboratory..... 50

POOR Richard Engraving Co..... 49

PORCELAIN Enamel (Architectural  
Division) Publicity Bureau ..... 7

REMILLARD-Dandini Co. .... 50

REPUBLIC Steel Corporation. .... 39

SCOTT Company ..... 50

SIMONDS Machinery Company..... 39

SMOOT-Holman Company ..... 33

SUMMERBELL Roof Structures..... 35

U. S. Bonds..... Inside Back Cover

VERMONT Marble Company..... 39

WEST Coast Screen Co..... 40

\*Indicates Alternate Months

**Scott Company**

**HEATING • PLUMBING  
REFRIGERATION**



San Francisco  
Oakland  
San Jose  
Los Angeles

**FOR ADVANCE  
INFORMATION**

**ON  
BUILDERS  
CONTRACTORS  
ENGINEERS**

Get

**ARCHITECTS  
REPORTS**

68 Past St. Phone  
San Francisco DO 2-8311

**ROBERT W. HUNT CO.**

**ENGINEERS  
INSPECTING TESTING**

**STRUCTURAL MATERIALS  
CONCRETE MIX DESIGN  
CHEMICAL ANALYSIS  
EQUIPMENT**

PRINCIPAL CITIES  
UNITED STATES • EUROPE  
SAN FRANCISCO LOS ANGELES  
PORTLAND SEATTLE

**REMILLARD-DANDINI Co.**

**Brick and  
Masonry Products**



400 MONTGOMERY STREET  
SAN FRANCISCO, CALIF.



# ARCHITECT AND ENGINEER

A NEW DAY DAWNS IN 1854 . . . For a Western Pioneer



M. GREENBERG'S SONS . . . 100th ANNIVERSAR

NOVEMBER

1953

# DECIMA

F WIRE, LETTER

DRILL SIZE No.	DECIMAL
80	.0135
79	.0145
<b>1/64</b>	<b>.0156</b>
78	.0160
77	.0180
76	.0200
75	.0210
74	.0225
73	.0240
72	.0250
71	.0260
70	.0280
69	.0292
68	.0310
<b>1/32</b>	<b>.0313</b>
67	.0320
66	.0330
65	.0350
64	.0360
63	.0370
62	.0380
61	.0390
60	.0400
59	.0420
58	.0430
57	.0430
56	.0485
<b>3/64</b>	<b>.0469</b>
55	.0520
54	.0550
53	.0595
<b>1/16</b>	<b>.0625</b>
52	.0635
51	.0670
50	.0710
49	.0730
48	.0760
<b>5/64</b>	<b>.0781</b>
47	.0785
46	.0810
45	.0820
44	.0860
43	.0890
42	.0935
<b>3/32</b>	<b>.0937</b>
41	.0960
40	.0980
39	.0995
38	.1015
37	.1040
36	.1065
<b>7/64</b>	<b>.1093</b>
35	.1100
34	.1110
33	.1130
32	.1160
31	.1200
<b>1/8</b>	<b>.1250</b>
30	.1285



**COLLEGIATE fits the  
LIGHT to the JOB**



**COLLEGIATE PM-284**

Increased seeing efficiency comes from fitting the light to the job — not job to light. Like all Smoot-Holman luminaires, beautiful Collegiate Slimline is a specialist. Designed for close visual tasks, it delivers illumination engineered to the eye's most rigid requirements. Simplified installation and low maintenance fit Collegiate quality to the budget, too. Specify the very best.



ILLUMINATION EQUIPMENT  
BRANCH OFFICE AND  
WAREHOUSE SAN FRANCISCO

# ARCHITECT

Vol. 195 No. 2

# AND ENGINEER

ARCHITECTS' REPORTS—Published Daily

**EDWIN H. WILDER**  
Editor

**I. WELLS HASTINGS**  
Contributing Editor

**PROF. LELAND VAUGHAN**  
Landscape Architecture

**JOHN A. BLUME**  
Structural Engineering

**MICHAEL GOODMAN**  
Planning

**JOHN S. BOLLES, A.I.A.**  
Book Reviews



## COVER PICTURE

A NEW DAY  
DAWNS IN  
1854

The West was just beginning to grow when M. Greenberg arrived in San Francisco with his wife and family, following a most hectic trip by sea from France.

Today the firm of M. Greenberg's Sons stands as a glowing tribute to a pioneer with vision of the future and Sons with the ability to "carry on." See Page 14 for complete details.

—Photo by Fred Mae

**ERNEST McAVOY**  
Advertising Manager

ARCHITECT & ENGINEER  
is indexed regularly by  
ENGINEERING INDEX, INC.

## Contents for

# NOVEMBER

EDITORIAL NOTES . . . . .	2
NEWS & COMMENT ON ART . . . . .	4
HOW TO GET THE MOST FROM THE HIGHWAY CONSTRUCTION DOLLAR By B. B. ARMSTRONG, President, Associated Contractors of New Mexico	6
NEW HEADQUARTERS NORTHERN CALIFORNIA CHAPTER, The American Institute of Architects, San Francisco, California . . . . .	8
G-E YOUNG AMERICA HOME, Medina Manor, Seattle, Washington . . . . . BLAINE McCOOL, Architect, CHARLES REISDORFF, Builder	10
TERMITE INFESTATION PREVENTION—DAVIS AVENUE SCHOOL, Los Gatos, California JOHN M. EVANS, A.I.A., Architect	12
WRITTEN IN BRONZE—and COURAGE . . . The Story of M. Greenberg's Sons By ROBERT O'BRIEN	14
ANNUAL MEETING . . . STRUCTURAL ENGINEERS ASSOCIATION of California, Yosemite Park . . . . .	23
AN INVESTMENT BLUEPRINT for ARCHITECTS AND ENGINEERS By FRANK J. KIHM, Consultant, H. E. Work & Co.	25
A.I.A. ACTIVITIES . . . . .	26
WITH THE ENGINEERS . . . . .	28
PRODUCERS COUNCIL PAGE Edited by STANLEY L. BASTERASH, Western Asbestos Co.	30
PERSONALITIES RICHARD L. RONNE—Contractor-Home Builder, Sacramento, California	32
BOOK REVIEWS, Pamphlets and Catalogues . . . . .	36
ESTIMATOR'S GUIDE, Building and Construction Materials . . . . .	39
ESTIMATOR'S DIRECTORY, Building and Construction Materials . . . . .	41
CONSTRUCTION CONTRACTS AWARDED and Miscellaneous Data . . . . .	42
BUILDING TRADES WAGE SCALES, Northern, Central & Southern California . . . . .	43
CLASSIFIED ADVERTISING . . . . .	43
IN THE NEWS . . . . .	45
INDEX TO ADVERTISERS . . . . .	48

ARCHITECT AND ENGINEER (Established 1905) is published on the 15th of the month by The Architect and Engineer, Inc., 68 Post St., San Francisco 4; Telephone EXbrook 2-7182. President, K. P. Kierulff; Vice-President and Manager, L. B. Penhorwood; Treasurer, E. N. Kierulff.

Los Angeles Office: Wentworth F. Green, 439 So. Western Ave., Los Angeles 5; Telephone DUnkirk 7-8135.

Entered as second class matter, November 2, 1905, at the Post Office in San Francisco, California, under the Act of March 3, 1879. Subscriptions United States and Pan America, \$3.00 a year; \$5.00 two years; foreign countries \$5.00 a year; single copy 50c. ARCHITECTS' REPORTS are published daily from this office, Vernon S. Yallop, Manager. Telephone DOuglas 2-8311.





# EDITORIAL NOTES

## FEDERAL LANDS

When Uncle Sam decided to stake a claim for future Americans in the vast lands of the West during the last century, his reasons were clear and just and can be summed up in one word—Conservation.

Conservation was needed in the West's vast expanse of forests and plains where too many people, prompted by what seemed limitless resources, took what they could from the land, and moved on.

The Federal government set aside parts of the public domain to preserve its resources—timber, minerals, grazing acreages, water supplies and oil. In recent years some private lands have been acquired for the purpose of conservation, and such a policy is continuing.

Today, the Federal government owns over one-half of the land in 11 western states, and as the West's largest land owner pays no taxes. Cattlemen, lumbermen and mining operators who depend upon the use of federal lands for their livelihood, and who justify this use by developing the nation's natural resources and thereby increase its wealth, are hampered by some of the restrictions imposed on the lands.

Public interest also requires due regard for conservation of the land. The public has a right to assurance that the national parks, with their game and protected wildlife, and opportunities for recreation, shall be preserved.

The problem is quite complex, except that without question, the water resources, the timber, the grazing lands, the oil reserves, and the mineral wealth should be consumed by private enterprise and government so as to properly conserve them for future use.

*Automatic tax cuts scheduled in the next 14 months would save American taxpayers an estimated \$2,750,000,000 in the fiscal year beginning July 1, if they are permitted to go into effect.*

TRY THIS ON . . . For Sizel

A national magazine circulated extensively in the construction industry, recently emphasized the following promotion material in its quest for support and business:

"How would you like a nationally known Architect to design your new home at a total cost to you of \$5.00?"

The appeal then goes on to point-out that "375,

000 home plans have been sold", representing residential construction in a price range of from "8,000 to \$20,000" per house.

Taking an average of \$12,000 per house, and 375,000 houses, the nation's Architectural Profession has been deprived of an income of some \$270-million on a Fee basis of 6% . . . according to our way of figuring.

By striking contrast ARCHITECT & ENGINEER magazine, which has been published on the West Coast every month since 1909, is continuously emphasizing Editorially, through the news columns, and by featured articles, the many advantages to be derived by employing the services of an Architect.

We, as publishers of a magazine commissioned to advance the architectural profession, have never compiled architectural material to be peddled direct to the public. To do so would be to engage in business in direct competition with the Architect.

On the other hand, ARCHITECT & ENGINEER magazines, answers many inquiries relative to the practice of architecture by reference to recognized, authoritative architectural associations and groups. It is our desire to serve . . . not compete with professions of the Construction Industry!

*Since 1940 the number of families with 3 children has increased by 77%, those with 4 children by 50% and those with 5 children by 27%.*

## FEDERAL HOUSING

A study is underway which may spell the end of another long-term excursion by the Federal government into the realm of private enterprise at the expense of the taxpayer.

It is an analysis being conducted by the Housing and Home Finance Administrator into the low-rent public housing program. The study was ordered by Congress, which asked for a report of the Administrator's recommendations by February 1, 1954.

The low-rent program was initiated under the U.S. Housing Act of 1937, as a relief program, and many contend that present-day conditions do not justify further Federal government participation in the financing of public subsidized housing.

*Industrial research laboratories once were considered a luxury, a kind of insurance—today they are recognized as one of the essential ingredients required to keep our industrial corporations running.*

# WORLD'S SMALLEST COMPLETE KITCHEN!

ONLY 27 1/2 INCHES WIDE!

Perfect For  
MOTELS HOTELS  
APARTMENTS  
OFFICES FACTORIES  
INSTITUTIONS  
SMALL KITCHENS  
TRAILERS  
PATIOS

**General Chef complete kitchen units fit in 5.4 square feet. The ideal solution wherever space and dollars are important.**

**SINK** One-piece porcelain top of heavy gauge steel. Faucets and all hardware triple-chrome plated. Units also available without sink.

**BURNERS** Units come with 3 gas burners (easily adjusted for bottled, natural or manufactured [L.P.] gas), or 3 electric burners (220 V.) or 2 (110 V.).

**REFRIGERATOR** Four cubic feet of space. Electric (sealed, self-oiling Tecumseh unit). Owens-Corning Fiberglas insulation. Convenient bottle shelf in door.

**FREEZER** Holds 9 ice cube trays, or 12 standard frozen food packages.

**STORAGE DRAWER** Ample storage space for pots and pans.

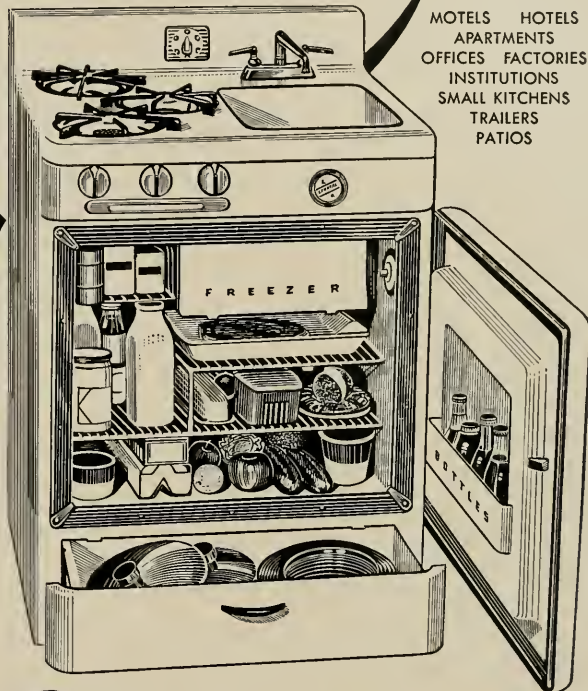

## 5 YEAR GUARANTEE

Every General Chef Unit is guaranteed in writing to give trouble-free service for 5 years!



## WRITE for complete information and specifications

if you are building, remodeling, designing — you will be interested in the space and money you can save with General Chef units. Several models are available. Fully guaranteed. WRITE TODAY for complete information and specifications on all General Chef units. We will also send you name and address of distributor nearest you.

# General Chef

NATIONWIDE SALES AND SERVICE

NEW YORK: Dept. A, Suite 762, 11 W. 42nd St.; LOS ANGELES: Dept. A, 4536 E. Dunham St.  
CHICAGO: Dept. A, Room 1108, Merchandise Mart

GENERAL CHEF, Dept. A, 4536 E. Dunham Street, Los Angeles 23, Calif.

Please send me complete information and specifications on General Chef units, and name of nearest distributor.

NAME \_\_\_\_\_ STREET & NUMBER \_\_\_\_\_  
CITY \_\_\_\_\_ ZONE \_\_\_\_\_ STATE \_\_\_\_\_



# NEWS and COMMENT ON ART



## CITY OF PARIS

The Rotunda Gallery of the City of Paris, San Francisco, under the direction of Beatrice Judd Ryan, has scheduled an Exhibition of Paintings by Victor Arnautoff, George Post and Gerald Wasserman, for showing during November.

The Pictures Of The Month, will feature new paintings from Paris by F. Gall and Louis Dali.

## CALIFORNIA PALACE OF THE LEGION OF HONOR

Located in Lincoln Park, San Francisco, under the direction of Thomas Carr Howe, Jr., a group of November exhibitions include:

Three Centuries of Great Spanish Prints From Goya to the Present, lent by the Prado Museum of Madrid; Painted Faces—Religious, Decorative and Festive; Tree, European and American small woodware of various periods; Exhibition of Japanese Folk and Provincial Art, from the Honolulu

Academy of Arts; and Works by Four Contemporary Artists, Jeremy Anderson, Ernest Briggs, Hassel Smith and James Weeks.

Educational activities include painting for children; motion picture series; Organ recital each Sunday at 3 p.m.; and continuation of the TV series each Tuesday afternoon.

## M. H. deYOUNG MEMORIAL MUSEUM

The M. H. deYoung Memorial Museum, Golden Gate Park, San Francisco, under the direction of Walter Heil, offers a number of outstanding exhibitions during the month of November, including the following:

ART OF THE SOUTH PACIFIC ISLANDS, a comprehensive show of 350 outstanding works, assembled from 20 museums and 19 foremost private collections. FOUR ARTISTS OF THE SAN FRAN-

(See Page 35)



## SAN FRANCISCO MUSEUM OF ART

War Memorial Building  
Civic Center  
San Francisco

HEAD OF STRAVINSKY  
bronze, 9" high  
By Marino Marini

Collection of the San Francisco  
Museum of Art, a gift of  
Mr. and Mrs. Walter A. Hoos



# A New Day dawned in 1850



*Afire with hope for a better life,  
a foundered ship, an interrupted  
journey, but all alive to start anew...  
this was the Greenbergs' introduction  
to the New World*

## 1854 saw the beginning of a remarkable San Francisco enterprise, M. GREENBERG'S SONS

Stories of the fabulous gold strike in far-off California were the lure that induced a young foundryman, his good wife, and two children to leave Paris, France, and come to this far-off "Utopia."

Arriving in San Francisco after being shipwrecked in the Straits of Magellan, this young pioneer finally, in 1854, established his own foundry, at 58 Halleck Street (where the Bank of California now stands).

For a hundred years three generations of the family have served industry and the public in the best American tradition, a record of which they are justly proud.

Today, the imposing modern plant on Folsom at 4th Street, and its 18 offices, serve the Plumbing, Heating, Fire Protection and Art-Bronze requirements of the nation, plus the territories of Alaska, Hawaii, the Philippines and Far East.

Twenty-five years ago M. Greenberg's Sons became exclusive distributors of Josam Drainage Products in the West through its wholly-owned subsidiary Josam Pacific Co.

From Morris Greenberg, the founder, his sons and grandsons, to the present head, a grandson Stuart N. Greenberg, the firm has kept pace with the solid growth of the West.



*In derby and apron, workers pose in front of the plant just before the 1906 quake*

Manufacturers of:

UNDERWRITERS APPROVED Fire Hydrants, Valves and Fittings, Fire Protection Hose Goods • Industrial, Navy and Maritime Bronze Valves and Fittings • Plumbing and Hardware Brass Specialties • Bronze Plaques, Letters and Name Plates • Crematory and Cemetery Bronze Products

*In our 100th Year*

Atlanta, Ga. • Boston, Mass. • Dallas, Texas  
Honolulu, T. H. • Houston, Texas  
Kansas City, Mo. • Miami Beach, Fla.  
New Orleans, La. • New York, N. Y.  
Philippine Islands • Portland, Ore.  
Spokane, Wash. • Washington, D. C.  
Los Angeles, Calif. • Seattle, Wash.  
Phoenix, Ariz. • Salt Lake City, Utah



STABILITY since 1854

## M. GREENBERG'S SONS

765 Folsom Street  
San Francisco 7, California

# HOW TO GET THE MOST FROM THE HIGHWAY CONSTRUCTION DOLLAR

By **B. B. ARMSTRONG\***, President  
Associated Contractors of New Mexico

## PART I

A tremendous road construction program faces the United States. Most groups that have studied our highway and street deficiencies place America's highway needs at \$50 to \$60 billion; the American Association of State Highway Officials in a



**B. B. ARMSTRONG**  
Contractor  
Roswell, New Mexico

recent study place the needs on the 664,000 mile Federal-aid system alone at \$32 billion. According to the National Safety Council last year's traffic accidents cost the United States \$36 billion with 53 million motor vehicles in use at the end of the year.

Reliable organizations predict that by 1975 between 65 and 75 million vehicles will be registered and others forecast the total registration by 1975 would reach the staggering figure of 85 million. In any case, the work of overcoming America's highway deficiencies will demand maximum benefit from every highway construction dollar invested. Because of this fact, I am pleased to have this opportunity, on behalf of the Associated General Contractors of America, Inc., which has a membership of 6,400 firms of which nearly fifty percent engage in highway work, to outline to you recommended methods to obtain maximum economy on road construction.

### Co-Operative Effort Is Very Important

The AGC believes, and we know this feeling is shared by all state highway officials, that much can be accomplished on problems in construction of highways through the Joint Cooperative Committee of the American Association of State High-

way Officials and AGC. An invitation was extended by the AASHO and AGC early in 1919, shortly after the formation of our association, to further understanding of the difficulties encountered by contractors in building highways and to encourage cooperation between the two associations. As a result of this invitation, an organizational meeting was held on December 11, 1920, and the Committee's work was fully initiated in 1921.

Since then, the Joint Cooperative Committee has worked harmoniously and effectively in obtaining workable solutions to important and frequently highly involved problems related to highway construction. This cooperative action between the State Highway Department and the members of the AGC has proven an effective method of ironing out problems arising on highway construction programs.

The National Joint Cooperative Committee meetings work well in solving the problems that cover wide areas. Through the years the joint cooperative action has resulted in improved conditions of benefit to both the contractor and the highway departments.

1. Better contract documents and administrative procedures.
2. Improved specifications.
3. Improved design for more economical construction.
4. Better pay for engineers in the Highway Departments and procedures relieving engineers of non-engineering work to help offset the shortage of engineers.
5. Improved public relations on highway construction programs.
6. Performance of maintenance by contract.
7. Preparation and adoption of satisfactory freight rate escalator clauses.
8. Adoption by numerous state highway departments of clauses for their construction contracts that would permit these contracts to be cancelled

\*NOTE—Address was delivered by Mr. B. B. Armstrong, manager of the firm of Armstrong & Armstrong, General Contractors of Roswell, New Mexico, at the recent 32nd Annual Convention of the Western Association of State Highway Officials held in Santa Fe, New Mexico. Many pertinent factors relative to western highway construction and problems are covered by Mr. Armstrong. ED

in a national emergency.

But there are innumerable problems that often cause local friction that can best be tackled in a local area by a local joint cooperative committee of highway officials and AGC members of which there are many local committees.

### **Long-Range Planning Important**

We believe one of the greatest potential means of saving the highway construction dollar lies in the long-range planning and advance purchasing or safeguarding of right-of-way to be needed later. Since the right-of-way for express-ways and high-ways is becoming more and more expensive, long-range planning should be used in determining the ultimate width of right-of-way to be required. If at all possible, this should be made a part of the initial project. We all know the rate of increase in highway traffic during the last 10 years, and we all know what to expect during the next 10 and 20 years. Of all the things that could be used to obtain the most for the highway dollar, of greatest importance, we believe, is the skillful planning for acquisition of adequate right-of-way well ahead of the time the land becomes occupied by costly buildings and other improvements.

### **Land Costs Eight Times Construction On Detroit Expressway**

Let me give you an illustration—last June in his testimony before the Subcommittee on Roads, P. M. Thornton, highway contractor of Hancock, Michigan, and AGC Highway Division Chairman for this year, cited an example of the cost on a Michigan highway project. In the widening of three miles of Woodward Avenue in Detroit, the cost of acquiring the property was more than \$9,800,000 out of a total cost of approximately \$11,000,000. In other words, the last cost or that for needed land was almost eight times the cost of construction. This is an extreme example, but this is the experience today in almost all large cities.

### **California Establishes Special Fund**

In contrast, here is a happier story. The 1952 Special Session of the Legislature of the State of California passed an act relating to the acquisition of properties for State highway purposes, and made an appropriation of \$10 million to the highway right-of-way acquisition fund. It was the intent and purpose of this law that the monies appropriated should be expended only on properties required for highway purposes and because of the imminent probability of development, prompt acquisition would be required to prevent such development and consequently, higher acquisition and construction costs.

A letter received this summer from the California State Highway engineer states that properties with an appraised value of \$8,620,572 were either

purchased or in the process of negotiation at the time. In accordance with the terms of the law, each of the properties had been presented to and authorized for acquisition by the California Highway Commission. The estimated cost of acquiring these properties at a later date, after development had been permitted to proceed, is placed at \$46,993,707, and this estimated amount is believed to be conservative. In other words, by acquiring the right-of-way at this time it was possible to save over \$38,000,000 and to get the property for about one-fifth what it would have cost later.

The original fund was increased at the last session of the California legislature from \$10 million to \$30 million, and now I understand it is \$50 million. Provisions were made so that it will be used as a revolving fund. This California Fund has been termed a "highway protection fund." How very rightly it is named.

The United States needs highways now. Funds are available for at least part of the needed construction. Let's build now with the funds now available, but in the process, plan for the future, too. To put it another way, this meeting of highway engineers and contractors is interested in the expenditure for highways of funds for the actual construction not for real estate to be used for the construction placement.

What we spend 10 years from now for actual construction does not have to be a fraction of that spent for acquisition of needed real estate if adequate planning and location are used and provision is made for purchase of needed land on a logical basis.

### **Engineers Must Be Better Paid**

Another very good investment to obtain maximum benefit for each highway dollar is an adequately trained, high-caliber, well-paid engineering staff. Without it the long-range foresight and planning; the active construction program; and the liaison work between highway departments and the state and federal government and the construction industry will miss the opportunity of saving large sums of money.

We all know that the problems encountered in planning and getting approved and under way a highway program are many. Of prime importance in assuring success in such undertakings are the engineers who are responsible for the project. Continued efforts should be made in building up the highway department's staff, and in training such personnel to do the job.

### **Steps Taken To Relieve Engineer Shortage**

Shortage of engineers has been a concern of every industry in the country that employs engineers. The highway industry, particularly the state highway department, has been in the worst plight.

(To Be Concluded Next Month)





NEW HEADQUARTERS  
NORTHERN CALIFORNIA CHAPTER

The American Institute of Architects  
San Francisco, California

## . . . A. I. A. OFFICES

The Northern California Chapter of The American Institute of Architects recently opened new offices at 26 O'Farrell Street, San Francisco, after having been located at 369 Bush Street for more than a decade. The new offices were designed by William Reiner, a Junior Associate member, who won the competition held for Junior Associates.

An opaque glass door opens into the entry, which is separated from the main office by a free-standing storage wall of color, embellished with an official emblem of the organization.

The office proper has acoustic plaster ceiling of eggshell color and walls partially painted green and partially covered with burlap, with an over-size peg board for display purposes. The floor is gray asphalt tile with coral accents. Furnishings consist of built-in cabinets made of natural finish birch. Matching birch door slabs have been used as desk tops, set on standard metal desk bases.

The storage wall contains recessed standard metal file cabinets, with storage space overhead, and a walk-in closet complete with wash basin and space for the addressograph machine.



**Filing Area and  
General Utility Room**

### **EXECUTIVE OFFICE**

*Photos by Morley*





*Photos by Lorenzo Daponte*

# G-E YOUNG AMERICA HOME MEDINA MANOR SEATTLE, WASHINGTON

**BLAINE McCOOL, ARCHITECT (Left)**  
**CHARLES REISDORFF, BUILDER (Right)**



Medina Manor is a restricted subdivision in Seattle's Bellevue area, just north of a new golf and country club, and is featured by well contoured roads, natural settings, territorial views, wide streets, and proximity to the Country Club and complete shopping center in Bellevue.

The G-E "Young America Home" was designed by the architect to attract people to Medina Manor and



at the same time offer a type of home to which people have become accustomed in the north-west, with an extra something that would have more than passing appeal.

From the standpoint of design, the home is simple, economical and definitely "livable" with attractive landscaping. The floor plan creates an interior space that is completely usable from all standpoints. A minimum of hall area is used and circulation within the house is ideal as one may go from the entry to any part of the home direct without passing through any other part. From the kitchen and work areas, the bedrooms, bath, entry, family room and utility room are readily available.

Bedroom windows are kept high from floor to allow any desired grouping of furniture; perimeter heating system provides warm air outlet in each room with location of furnace in utility room. Special low-voltage light switch system allows for continuous light pattern throughout the house and lights may be turned on or off from any location.

Highlight of the home is the combination "family" room and kitchen which has been equipped with all modern conveniences. Two small ranges



The Newly Designed and Equipped Kitchen

are separated by a maple chopping block. Metal cabinets were used throughout the kitchen with coral colored counter top to lend warmth.

Exterior materials were chosen to represent typical natural material of the Northwest. Heavy hand split shakes were used on the roof.

More than 8000 people inspected the home during the time it was open, attesting to the acceptance of its architectural design and modern features.

**PLOT  
FLOOR  
PLAN**



Photos Courtesy  
General Electric  
Company

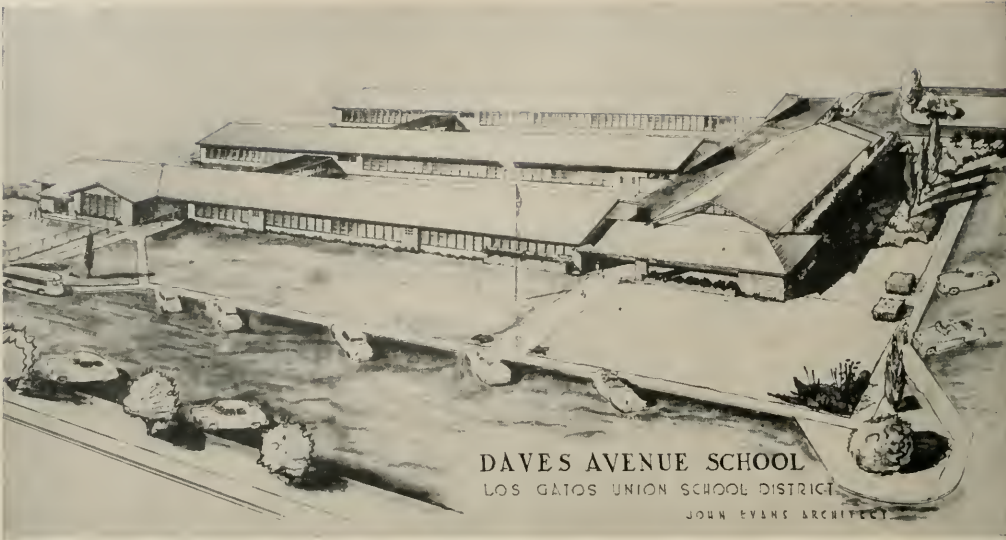

# Termite Infestation Prevention

## DAVES AVENUE SCHOOL

### Los Gatos, California

JOHN M. EVANS, A.I.A., ARCHITECT



School districts and Architects are being, and will continue to be, confronted with the growing problem of termite infestation in wood frame school buildings.

In the area around Los Gatos, three recently built schools have been infested by termites; two buildings by the dry wood type, during construction, and one by the subterranean type, after completion.

The two schools under construction were fumigated after completion at the expense of the contractor, but such treatment is no guarantee against return of the insects.



**LEFT —** Termite treated overhead wooden rafters in place.

**LOWER view shows** chemanite treated siding and extent of school building.







"Great Oaks From Small Acorns Grow"

# WRITTEN IN BRONZE ..... AND COURAGE

... THE STORY OF M. GREENBERG'S SONS

By ROBERT O'BRIEN

IT WAS 1854 and the city was pushing up the flank of windswept Nob Hill to the west and Telegraph Hill to the north, and sprawling in tent settlements across the sand dunes south of Market Street. Half a thousand bare-sparred ships of the Gold Rush fleet swung at anchor in San Francisco Bay.

Stocky, dark-haired Morris Greenberg of Paris,

France—he and his wife, Annette, and their two children had sailed around the Horn to the gold-fields three years before—stood in the bustle of Portsmouth Square and studied the hillsides. Amid the bedlam of Long Wharf he looked out at the ships that had been abandoned by their gold-hungry mates and crews.

"Men take more than gold from the earth," he

said to himself. "And San Francisco—its new houses, these ships, when the crews come back—will need more than gold."

He was thinking back to the years of his apprenticeship in Paris, recalling the reek of the foundry smoke, the roar of the furnaces, the weight and swing of scorched-black molding sand in the shovel, and molten metal that streamed like white liquid fire from the dark crucibles.

This was what he knew. This was what he had to contribute to the life and commerce of the booming young seaport.

On a little street three blocks long, hard by the waterfront, he found a tiny, one-story frame building, No. 58 Halleck Street. Over the narrow doorway he hammered a painted sign: "Eagle Brass Foundry."

Bottoms of beached ships yielded copper for his melting pots. From the dunes by Rincon Point he dug sand for his molds. While the summer fogs billowed in from the sea that year, Morris Greenberg bent industriously over the molds and crucibles in the little foundry, casting keys and hinges and chandelier fittings for the houses going up on the hills, and spikes of bronze for the planks of ships, and bells for Gold Rush churches . . .

Later, bronze cannons cast by Morris Greenberg for the Union Army thundered across the Civil War battlefields, and water gushing from his great



**MORRIS GREENBERG**  
of Paris  
Founder of the firm of  
M. Greenberg's Sons

monitor nozzles tore at the placer earth of the Mother Lode foothills for gold for the Union Cause.

The little frame building in Halleck Street was already far in the foundry's past. The plant had grown with the city, and as the city pushed its waterfront east into the bay and adapted itself to its changing shoreline and growing population,

**100 YEARS OF PROGRESS . . . Today's Ultra Modern Industrial Building**





**STUART N. GREENBERG**  
Grandson of the founder  
is executive head of firm

the foundry shifted to 121 Battery Street, then to 120 Bush Street and at last across Market Street to 43 First, and finally reached Tar Flat, a marlin-spike's throw from Mission Wharf. There, at 205 Fremont Street, Morris Greenberg erected a foundry, pattern shop, machine shop and plating works that housed his flourishing business for the next 14 years.

Greenberg's copper now came in ingots from the mines of Lake Superior, Lehigh coal blazed in his furnaces, and square-riggers with Greenberg castings in their holds fared west through the Golden Gate for China.

During their first years in San Francisco, Morris, Annette and their two children occupied a house on Sacramento Street, and there in 1854, the year of the foundry's beginning, they became the parents of their third child, Joseph. As a two-year old Joseph lay awake in his crib and listened to the tramp of drilling Vigilantes on the plank sidewalks; during the dramatic months of their war against cut-throats and criminals in the spring of 1856, they sand-bagged the appraisers' storehouse next to the Greenberg home, and converted it into their headquarters, "Fort Gunnybags."

A few years later, the Greenbergs joined the flight of the affluent to the south, across Market Street, and to a commodious home at 661 Harrison Street, high on the slope of fashionable Rincon Hill and well above the foundry fumes of Tar Flat. Down its wide flowered walk each morning strode father and son, Morris and Joseph. As they parted on the Harrison Street sidewalk, the father bent his footsteps down the hill to the foundry; the lad tucked his schoolbooks under his arm, turned his alert, inquisitive face west, and hurried along the



**Today's  
Department  
Executives  
and  
Office  
Personnel**



five blocks to Fifth Street's Lincoln Grammar School.

In the spring of 1868, Morris beamed proudly as he conducted a reporter from the **Daily Alta California** through his busy, up-to-date plant. And as he talked on, the reporter noted facts and figures and impressions for his newspaper:

"Amount of castings at this foundry daily, about 300 pounds . . . 15 employees, 10 lathes . . . Supplied gas company with large amounts of fittings . . . Recently cast brass rudder for U. S. Quartermaster's steamer **Gen. McPherson** . . . Furnished big conveyor pumps to the Philadelphia and the Stock breweries . . . Great activity . . . Furnaces in full blaze . . ."

There came a time, in 1878, when Morris had more impressive news for reporters than this. With the help of Joseph, who had entered the business in 1871, he had perfected the first complete unit ever manufactured at the foundry . . . the California-type fire hydrant.

Swift and dependable in action, with independent valves that insured a steady constant pressure, it won Morris, Joseph and the firm the gratitude of smoke-eaters from Seattle to San Diego, who, for years, had been handicapped in their

fight against fire by complex and unreliable Eastern hydrants.

The invention was an achievement that lighted the last years of the pioneer's life. On May 8, 1884, three years after he had moved the plant to still larger quarters at 225-227 Beale Street, Morris, now 61, started his morning walk down First Street to work.

There was a jauntiness in his step, a youthful pride in his bearing: two days before, he and Joseph had toasted the 30th anniversary of the firm's establishment. But half-way down Rincon Hill, his step faltered. He collapsed to the sidewalk. A passing carriage rushed him home. Twenty minutes later he was dead.

Supervision of the business passed to Joseph's hands—hands rendered capable by 15 years of experience under his father's careful guidance. During a brief partnership with his brother, Leon, Joseph ordered a new sign painted across the foundry's facade. "M. Greenberg's Sons," it read, in tribute to their emigrant father and to the 30 years of honest toil that he had contributed to the commercial life of San Francisco.

Down on the waterfront the eight coke furnaces of the Beale Street plant burned as hotly and as

**Some of today's more than 250 employees, who in observing the firm's 100th birthday and anniversary, look forward to continuing the outstanding progress of M. Greenberg's Sons.**





#### FOUNDRY

Interesting view at left shows the Foundry in one of its early stages of development

Lower View Shows modern plant as it appears today

brightly as ever to furnish the bronze and the brass for castings that ranged from hydrants and lift pumps to tinkling bells for San Francisco's cable cars.

When, in 1906, the Earthquake shook the city, the foundry roof and walls crashed about the furnaces. The very flames that had been the foundry's life set them blazing. Eighteen days later, on May 6—52 years to the day since Morris had opened the Eagle Brass Foundry on Halleck Street—M. Greenberg's Sons was again in operation.

The wooden walls were new and raw; the foundry was open to the sky; but from the molds by the hundreds came the bright castings for buildings that would rise upon the smoking ruins of the devastated city.

Joseph lived to see them rise, and on his death in 1912, San Francisco mourned the passing not only of the head of one of its pioneer industrial firms, but also of a civic leader whose devotion to the city of his youth found its clearest expression in his unflagging activity in behalf of the Lincoln





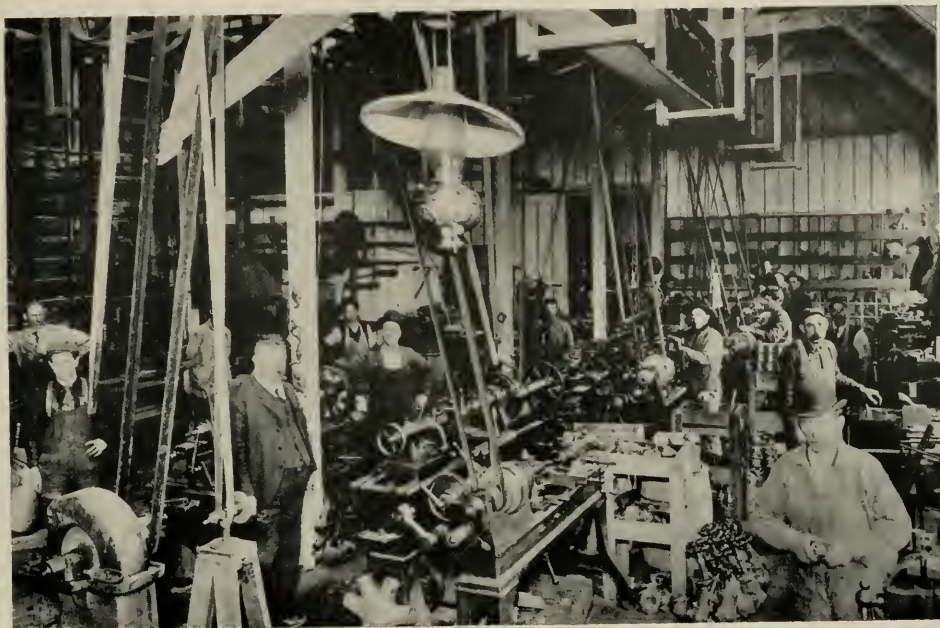

SHOP area in upper picture is prior to modernization.  
LOWER illustration shows strictly modern manufacturing shop.







Grammar School Association, of which he had been one of the founders and first president. Another organization benefitting from his keen interest in civic affairs was the Native Sons of the Golden West; he had been the founder of the Leland Stanford chapter of San Francisco, named in honor of his close friend, Governor Leland Stanford.

Once more, however, a Greenberg stood ready to take a father's place. Joseph's elder son, Maurice, at the age of 22, became the head of the firm. In 1913, a year later, he was joined by his brother, Stuart N. Greenberg.

Alert to the development of all the West and eager to grow with it, the young brothers moved to extend the frontiers of M. Greenberg's Sons. While Maurice devoted himself to the administration of the business, Stuart compiled the first catalogue of the foundry's products, tucked it into his brief case and hit a long road that took him from Canada to Mexico and east to Denver. Orders from new accounts demanded stepped-up production. Soon oil instead of coke flared in the foundry's furnaces in a technical improvement which doubled their melting capacity from 2,000 to 4,000 pounds.

*Congratulations*  
to  
**M. GREENBERG'S SONS**  
*in their 100th Year.*

**HAMERSLAG  
EQUIPMENT CO.**

45 ELMIRA ST., SAN FRANCISCO



**MODERN  
MATERIALS  
HANDLING**

**FIRE FIGHTING MONITOR NOZZLE**

This installation of an M. Greenberg's Sons "fire fighting" Monitor Nozzle on a State of California Fire Boat, "The Dennis Sullivan" is typical of similar installations in New York and elsewhere. The nozzle is a modernization of the "Monitor" used extensively in placer gold mining.

*Congratulations*  
to  
**M. GREENBERG'S SONS**  
*in their 100th Year*

**OGDEN**

**COMMERCIAL PRINTING**

Garfield 1-6440

251 FOURTH STREET
SAN FRANCISCO 3

*Congratulations*  
to  
**M. GREENBERG'S SONS**  
*in their 100th Year*

**PHOENIX IRON WORKS**

CASTINGS SINCE 1901 • OAKLAND, CALIF.

Machine and Pattern Work • Gray Iron • Semi-Steel  
Phoenixloy • Nickel-Chromium-Alloy • Castings



**FIRE SYSTEM**

**HYDRANTS**

Many cities have installed this type of fire hydrant in their fire protection systems . . . here is a finished group ready for shipment and immediate installation.

*Moulin Photos*

Shortly after the First World War, the Southern Pacific Company bought the Beale Street property for use as a freight terminal. A new and expanded foundry and office building rose at 765 Folsom Street, a site across which Morris must have gazed many times as he sat on the porch of his Rincon Hill home, and looked west to Twin Peaks.

Seven years later, in the depression year of 1930, San Francisco financial writers eyed with respect the survival and steady growth of the firm. Full-time employees numbered 75. The annual payroll topped \$150,000.

"Converting a million pounds of brass a year into dozen of varied products, the firm's 'gross

*Congratulations*  
from

**A. J. LYNCH & COMPANY**

Los Angeles

San Francisco

*Metal Finishing Supplies  
and Equipment*



*Manufacturers*

*Since 1906*

**GARRETT M. GOLDBERG PAINT CO.**

1019 Mission Street

San Francisco 3, California

*Congratulations*

M. GREENBERG'S SONS

*in their 100th Year*

from

**BARRETT CONSTRUCTION CO.**

and

**HILP & RHODES**

GENERAL CONTRACTORS

**WRITTEN IN BRONZE . . .**

annual," they wrote, "is steadily climbing to the half-million-dollar mark."

The pace never slackened. In 1934, Stuart's ingenuity tackled the problems of accidents in the congested traffic of city streets, accidents that resulted in sheared-off hydrants and geysers shooting skyward from fractured mains. Soon he had developed and patented an improvement in the California hydrant: an automatic check valve which functioned instantly to shut off the flow of water from a broken hydrant.

With a backlog of orders straining production



**VALVES — a completed lot ready for shipment to users throughout the world**

***Congratulations to***  
**M. GREENBERG'S SONS**

on a

***"Century of Progress"***

**American Brass & Copper Co.**

Oakland, Calif.

**KUCHEL & SIEVERS**  
**ELECTRIC WORKS, LTD.**

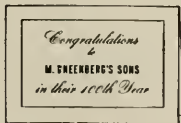

**INDUSTRIAL & COMMERCIAL**  
**WIRING • MOTOR SERVICE**  
**REWINDING • REPAIRS**

**Kuchel & Sievers Electric Works, Ltd.**

350 Kansas Street

San Francisco 3

Telephone UNDERhill 1-8261

facilities to their utmost, Maurice and Stuart, in 1937, announced construction of a \$250,000 addition to the plant at 765 Folsom Street. Once more M. Greenberg's Sons furnished copy for San Francisco's financial writers: eager for signs of recovery from depression, they viewed with optimism this first major construction project in the South of Market industrial area since 1934.

"We are putting up this new building," the Greenberg brothers said, "primarily because we need space for a growing plant." But, they added, it was permanent; M. Greenberg's Sons was in San Francisco to stay. "It will completely express our faith in the city in which we were born, and which three generations have had good reason to believe is a mighty good business site."

The addition provided the facilities for the expanded activity of the firm as it reached out into

(See Page 33)

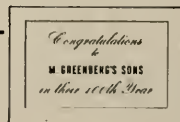

**C. A. WORTH & Co.**

Established 1850

**DRAYING AND POOL CAR DISTRIBUTION**

350 SECOND STREET

SAN FRANCISCO 7

EXbrook 2-1250





ANNUAL MEETING  
STRUCTURAL ENGINEERS  
ASSOCIATION OF CALIFORNIA  
YOSEMITE, CALIFORNIA



**NEWLY  
ELECTED OFFICERS  
FOR 1954**

Elected at the Annual Meeting  
to serve as officers of the  
Structural Engineers Asso-  
ciation of California for the  
ensuing year were:

**HAROLD KING**  
(Center), President,  
Sherman Oaks, Calif.

**JAMES SHEFFET**  
(Left), Secretary-Treasurer,  
Pasadena, Calif.

**MERLE A. EWING,**  
Vice-President,  
Sacramento, Calif.



**CONVENTION SCENES**

**TOP:** Speakers at Technical Session: M. A. Ewing, SEAOC, Pres. (left to right): Ted R. Higgins, American Institute Steel Construction; John E. Rinne, Past President, SEAOC; Verne Ketchum, Timber Structures and H. M. Pitney, Bethlehem Pacific Steel. **SECOND ROW:** J. T. Silveria, Pacific Fire Rating Bureau; Arthur Anderson, Concrete Engineering Co.; Prof. N. M. Newmark, University of Illinois; Ben Benioff, Pres., SEAOSC. **THIRD ROW:** Henry C. Powers, Don Wiltse, Leray Greene, Harry B. Corlett, Geo. E. Brandow. **BOTTOM ROW:** Jack Y. Long, Geo. E. Gaodall, David M. Wilson, Walter Dickey, James L. Stratta, and Janathon G. Wright.



**LADIES' KNIT FASHION SHOW**, held at the Structural Engineers Association Convention at Yosemite. Left to right: Mrs. Marvin Kudroff; Mrs. Jack Horner; Mrs. George Maurer; Mrs. Art Sedgwick; Mrs. John Minosian; Mrs. William Brewer; Mrs. George Brandow; Mrs. James Stratta, Mrs. Kay Quimby; and Mrs. Byron Nishkian.





# Gift Subscription For Christmas 1954

**A**S a service to its readers GIFT SUBSCRIPTIONS to ARCHITECT & ENGINEER magazine are available for this year's Christmas giving.

REGULAR SUBSCRIPTION Rate will apply:

United States and Pan America  
\$3.00 a year; two years \$5.00  
Foreign Countries \$5.00 a year

PLEASE SEND ARCHITECT & ENGINEER  
AS A GIFT To:

name..... occupation.....

address..... city..... zone..... state.....

Sign my gift card: From.....

name..... occupation.....

address..... city..... zone..... state.....

Sign my gift card: From.....

name..... occupation.....

address..... city..... zone..... state.....

Sign my gift card: From.....

Your Name.....

address..... city..... zone..... state.....

Enclosed is my check for.....

## AN INVESTMENT BLUEPRINT for ARCHITECTS & ENGINEERS

By FRANK KIHM\*

How to keep what you earn is a problem when high income taxes prevail, and moderate relief promised for the near future.

An effective way to save on taxes is offered to those in the upper income brackets through investing in municipal bonds. Income from these securities is exempt, under present regulations, from Federal income tax. California municipals are exempt from the State income tax and from personal property taxes.

Further enhancing the attractiveness of these securities is the present yield schedule resulting from comparatively lower prices. At the end of October average yield on 20 bonds, as computed by the authoritative publication, "Bond Buyer," stood at 2.72% as against 2.39% a year earlier.



FRANK J. KIHM  
Consultant H. E. Work & Co.,  
San Francisco

Now 2.72% does not seem a high return for invested funds. But remember you can keep all income from municipal bonds. This feature emphasizes some interesting aspects when considered in relation to individual income.

Let us assume that you are married, and that you file joint tax returns on an annual income, after exemptions and deductions, in the \$28,000 to \$32,000 bracket. Dividing this by two because of the joint return puts you in the \$14,000 to \$16,000 bracket.

Your tax liability on this income is 53%. In other words you pay 53% tax on income from taxable investments such as interest on bank accounts, savings and loan, or stock dividends and corporate bond interest. It would be necessary for such investments to yield 5.85% in order to equal the 2.75% from the tax free municipal bond.

Take a typical California issue—City of Los Angeles, Department of Water Power Electric Plant Revenue Bonds 2 3/4% coupon rate, maturing October 1, 1983, offered at par to yield 2.75%. Bonds are rated AA and regarded as a desirable security. The "equivalent yield" is shown in the following table:

*Income After Exemptions and Deductions	Return needed from Taxable Securities
\$10,000-\$12,000	4.75%
12,000- 14,000	5.29
14,000- 16,000	5.85

\*For a single person, to find the taxable equivalent yield for taxpayers filing joint returns, divide the entire surtax net income by two, and use the income bracket applicable to the amount thus obtained.

Thus, a taxpayer in the \$50,000 bracket, even though filing joint returns, would have to find a taxable security yielding better than 8% to equal the 2.75% municipal bond yield. And it would be difficult to find a security with this return, and the safety of principal that characterizes good municipals.

Other attractive features of municipal bonds are high collateral value and ready marketability. Banks and other lending agencies will loan from 80% to 90% of the market value of good bonds. Quotations may be readily obtained from banks, stock brokerage houses, and investment banking firms, and purchases and sales may be readily effected.

Like any other investments, municipal bonds must be carefully selected. Prices fluctuate reflecting supply and demand. Those investors who can hold bonds until maturity are assured of payment of interest and return of principal. However, if a sale is necessary when bond prices are depressed, the seller may take a loss.

In the past only wealthy individuals, and institutions were interested in municipal bonds. Today the high income tax rates are responsible for widespread interest on the part of well informed investors with relatively moderate incomes.

*\*(EDITOR'S NOTE: Mr. Kihm is well qualified to discuss the investment needs of professional people. He was Executive Secretary of the San Francisco Medical Society from 1945 to 1952, and City Editor of the Wall Street Journal (San Francisco) from 1939 to 1945, and has contributed articles to Barron's and other business publication. He is now with the San Francisco investment banking firm of H. E. Work & Co.)*



# American Institute



# of Architects

Clair W. Ditchy, President  
Norman J. Schlossman, 1st Vice-President  
Howard Eichenbaum, 2nd Vice-President  
George Bain Cummings, Secretary  
Maurice J. Sullivan, Treasurer

National Headquarters—  
1741 New York Avenue, N. W.  
Washington, D. C.

Edmund R. Purves  
Executive Secretary

#### Arizona Chapter:

Low Place (Tucson), President; Ralph Haver (Phoenix), Vice-President; Fred O. Knipe (Tucson), Secretary; James W. Elmore (Phoenix), Treasurer. Secretary Offices, 1324 E. Lester St., Tucson.

#### Coast Valleys Chapter:

Kurt Gross, President; Harold Ahnfeldt, Vice-President; Frank C. Tressler, Secretary; Jerome Kasavan, Treasurer. Directors, Hollis Logue and Gifford Sobey. Offices, 82 S. 3rd St., San Jose.

#### Central Valley of California:

John W. Bomberger, President; Nicholas Tomich, Vice-President; Albert B. Thomas, Secretary; Ted de Wolf, Treas.; Gordon Stafford, Director; Alternate to CCA, Silvio Barovetto; Sec. Office 718 Alhambra Blvd., Sacramento.

#### Colorado Chapter:

James M. Hunter, President, 2049 Broadway, Boulder; Casper F. Hegner, Secretary, 1659 Grant Street, Denver 5.

#### East Bay Chapter:

Malcolm D. Reynolds, President; Donald Hardison, Vice-President; John Lloyd, Secretary; Ed Cernuti, Treasurer. Directors: Chester Trichel, Ira Eeals, Cecil Moyer. Secretary's office: 1171 Solano Ave., Albany.

#### Idaho Chapter:

C. V. Woyland, Boise, President; Cecil E. Jones, Twin Falls, Vice-President; Thomas M. I. Leake, Boise, Sec. Treas.; Anton Dropping, Boise, Exec. Comm. Member. Office of Secretary, Suite 405 Sun Bldg., Boise.

#### Montana Chapter:

E. Edward Scowcroft, President (Billings); J. Van Teylingen, Vice-President (Great Falls); H. C. Cheever, Secretary-Treasurer. Secretary office, Bozeman.

#### Nevada Chapter:

Russell Mills, President, Reno; Harris P. Sharp, Vice-President, Las Vegas; E. Keith Lockard, Secretary, Reno; Edward S. Parsons, Treasurer, Reno. Directors: L. A. Ferris, David Vhay, Reno, and Walte Zick, Las Vegas. Office of President: 309 N. Virginia St., Reno.

#### Nevada State Board of Architects:

Russell Mills, Chairman, Reno; Aloysius MacDonald, Secretary, Las Vegas; Edward Parsons, L. A. Ferris, Reno, and Richard Stadleman, Los Vegas, Members. Office, 309 S. 5th St., Las Vegas.

#### Northern California Chapter:

Donn Emmons, President; Wendell R. Spackman, Vice-President; William Corlett, Secretary; Bernard J. Sabaroff, Treasurer. Directors: Charles S. Pope, Wm. Stephan Allen and Lawrence A. Kruse, Helen H. Ashton. Office Secv. Office, 26 O'Farrell St., San Francisco.

## PASADENA CHAPTER

"The Monorail System and its Application to the Southern California Area" was the subject of a talk by Colonel George D. Roberts at the November meeting. Col. Roberts is president of Monorail Engineering Construction Corporation and in addition to a general discussion of the subject,

*Remember it's*

# KRAFTILE

- for ★ GLAZED STRUCTURAL WALL UNITS
- ★ PATIO TILE
- ★ FACE AND ROMAN BRICK
- ★ ACID FLOOR BRICK
- ★ HEARTH BRICK
- ★ BRICKETTES
- ★ MINWAX TILE & CONCRETE FLOOR FINISH

For complete information and prompt service, phone or write

## KRAFTILE COMPANY

NILES, CALIFORNIA NILES 3611

LOS ANGELES 13: 406 South Main Street—Mutual 7241

showed a 16mm motion picture of Monorail systems in operation in Europe.

Membership Certificates were presented to Miles Perlis and Walter Culver, Jr.

## NORTHERN CALIFORNIA CHAPTER

Architect Frank Lloyd Wright was the honored guest at the November meeting on the 17th, with representatives of the University of California and Stanford and the San Francisco Architectural Club joining with the membership in honoring this distinguished guest.

An exhibit of city planning in twelve major cities in the United States, Europe and South America was shown in the Rotunda of the San Francisco City Hall, November 16-30. The exhibit featured photographs, plans and models of civic centers and like areas which have been re-developed in recent years, and included original drawings for the proposed development of the San Francisco Civic Center.

## CLAREMONT COLLEGE NAMES ALLISON

David C. Allison, F.A.I.A., retired architect and a member of the Southern California Chapter of the A.I.A., has been elected to the Board of Trustees of Claremont College, central coordinating institution and Graduate Colleges at Claremont, California.

## OREGON CHAPTER

Consideration is being given to the possibility that architects should be given an opportunity to qualify under Federal Social Security. Letters have been addressed to representatives in Con-

Orange County Chapter:  
 Paul O. Davis (Los Angeles), President; Ralph Modjeski (Santa Ana), Vice-President; Geo. Lind (Newport Beach), Secretary; Wm. L. Faulkner (Santa Ana), Treasurer. Secretary's Office: 2919 Newport Blvd., Newport Beach.

Oregon Chapter:  
 Holman J. Barnes, President; Albert W. Hilgers, Vice-President; Donald W. Edmundson, Secretary; DeWitt C. Robinson, Treasurer; and H. Abbott Lawrence, Trustee. Office of Secretary, 325 Henry Bldg., Portland.

Pasadena Chapter:  
 Robert E. Langdon, Jr., President; Wallace C. Bonsall, Vice-President; Robert L. Deines, Secretary; Henry C. Burge, Treasurer; and Directors John N. Douglas, R. VanBuren Livingston, Scott Quintin and Burton Romberger. Offices: 259 South Los Robles Ave., Pasadena 5.

San Diego Chapter:  
 Donald Campbell, President; Victor L. Wulfi, Jr., Vice-President; Richard L. Pinnel, Secretary; Edward G. Holliday, Treasurer; Louis A. Dean, Director. Office Sec., San Diego Trust & Savings Bldg.

San Joaquin Chapter:  
 Maurice J. Metz (Fresno), President; Allastair Simpson, Vice-President; Al Bailey, Secretary; Robert Stevens, Treasurer. Directors: David H. Horn, Wm. Hyberg, Robert Kaestner. Secretary's Office, Fresno.

San Jose Chapter:  
 Miss Lutch Maria Riggs, President; Roy C. Wilson, Vice-President; Chester L. Carjola, Secretary; Roy W. Cheesman, Treasurer. Corres. Secy.; Richard B. Nelson, 3033 Calle Realces, Santa Barbara.

Southern California Chapter:  
 Henry L. Wright, President; U. Floyd Rible, Vice-President; Cornelius M. Deasy, Secretary; Savio M. Stoshitch; Hugh E. Davies, S. Kenneth Johnson, Kemper Nomland and Chas. E. Fry, Directors.  
 Headquarters, 3723 Wilshire Blvd., Los Angeles 5.

Utah Chapter:  
 W. J. Monroe, Jr., President, 433 Atlas Bldg., Salt Lake City; M. E. Harris, Jr., Secretary, 703 Newhouse Bldg., Salt Lake City.

Washington State Chapter:  
 John S. Dettlie, President; Ralf E. Decker, 1st Vice-President;

Edwin T. Turner, 2nd Vice-President; Wendell H. Lovett, Secretary; Arnold G. Gagnnes, Treas. Directors Paul Thiry, William J. Bain, J. Emil Anderson and Robert B. Price, Day's Holcomb, Ex-Sec., 409 Central Bldg., Seattle 4.

Spokane Chapter:  
 Tom Adkinson, President; Carroll Martel, Vice-President; Harry Weller, 2nd Vice-President; William James, Secretary; Lawrence Ewamoff, Treasurer. Office of the Secretary, W. 524 4th Ave., Spokane.

Tacoma Society:  
 E. N. Dugan, President; P. G. Ball, Vice-President; Lyle Swedberg, Secretary-Treasurer.

Hawaii Chapter:  
 Kenji Onodera, President, 3518 McCorrison St., Honolulu, T. H.; George J. Wimberly, Secretary, 315 Royal Hawaiian Ave., Honolulu, T. H.

CALIFORNIA COUNCIL OF ARCHITECTS  
 Charles E. Fry, President, Los Angeles; Malcolm D. Reynolds, Oakland, Vice-President; Lawrence Gentry, Los Altos, Secretary; Louis A. Dean, San Diego, Treasurer; Fred A. Chase, Executive Secretary, 3723-A Wilshire Blvd., Los Angeles.

CALIFORNIA STATE BOARD ARCHITECTURAL EXAMINERS:  
 George P. Simonds (Oakland), President; Ulysses Floyd Rible (Los Angeles, Secretary; Earl T. Heitschmidt (Los Angeles); C. J. Paderewski (San Diego); Norman K. Blumhard (San Francisco), Exec. Secy.; Robert K. Kelley, Room 712, 145 S. Spring St., Los Angeles; San Francisco Office, Room 300, 507 Polk Street.

ALLIED ARCHITECTURAL ORGANIZATIONS

San Francisco Architectural Club:  
 Joseph Sooma, President; Frank S. Gerner, Vice-President; Russell W. Pennell, Treasurer; Frank L. Barsotti, Secretary. Club Quarters: 507 Howard St., San Francisco.

Producers' Council—Southern California Chapter:  
 Bert Taylor, President, Pittsburgh Plate Glass Company; G. Robert Roden, Jr., Vice-President, Truscon Steel Company; Malcolm G. Lowe, Secretary, Natural Gas Equipment Inc.; Richard Seaman, Treasurer, W. P. Fuller & Company; Vern Boget, National Director, Gladding McBean & Co. Producers' Council—Northern California Chapter (See Special Page)

gress requesting detailed information on the subject.

The Civic Design Committee, comprising Gill Davis, chairman, reported at a recent meeting that the proposed Seminar has been postponed pending obtaining suitable space.

#### ARCHITECT ASSISTS COUNTY SUPERVISOR

Bernard J. Sabaroff, treasurer of the San Francisco A.I.A. Chapter, has been named chairman of a special AIA committee to assist Mrs. Vera Schultz, Marin County Supervisor, and a Marin County Citizens Committee on several proposals involving the location of county governmental buildings.

Three proposals have been submitted; remodel the present building and remain on the present site in San Rafael; re-locate the buildings on the outskirts of the city; and relocate the buildings on the site of a former military academy in San Rafael.

#### ARCHITECT OFFICE MOVES

The architectural firm of William Decker Holdredge, A.I.A., announced recently that they had moved into larger quarters at 1604 Monterey Street, San Luis Obispo, California. The mail address, Post Office Box 412, remains unchanged.

#### SOUTHERN CALIFORNIA CHAPTER

"Modern Brazilian Architecture" was the subject of an illustrated talk by Raul de Smandex, Brazilian Consul, at the regular November meeting in the Rodger Young Auditorium. The program presented Brazil through Brazilian eyes and music as special musical numbers also featured the program.

The December Chapter meeting will be held on the 8th in Long Beach at the Lakewood Country Club, according to Robert Field, program chairman. The program is being arranged by the Long Beach architects.

## NEW F. H. A. REQUIREMENT!

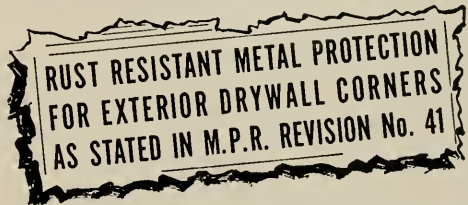

## RICHBEAD MEETS THIS REQUIREMENT!

This ruling means all F.H.A. financed homes must have rust-resistant metal protection for all exterior drywall corners.

Made of aluminum, Richbead is strong and rust-resistant. Protects all corners from banging and nicking. Use in both new building and redecorating.

Richbead is easy to install. It requires no special tools — just cut it and fit it. Saves time, labor and material.

Distributed By



CONTACT THE NEAREST P.C.A. SALES OFFICE  
 SAN FRANCISCO      OAKLAND      SAN JOSE  
 SACRAMENTO      STOCKTON      FRESNO

# WITH THE ENGINEERS

## Structural Engineers Association of California

John E. Rinne, President, San Francisco; Jack S. Barish, Vice-President, Sacramento; Leslie W. Graham, Secretary-Treasurer, San Francisco. Directors John J. Gould, R. W. Binder, M. A. Ewing, Leslie W. Graham, Jack S. Barish, Harold P. King, W. T. Wheeler, John E. Rinne and Donald F. Shugart. Secretary's office, c/o Associated Structural Engineers, 417 Market St., San Francisco 5.

## Structural Engineers Association of Northern California

George A. Sedgwick, President; Michael V. Pregnoff, Vice-President; John M. Sardis, Secretary; William K. Cloud, Treasurer; Robert P. Moffett, Asst. Sec.-Treas.; Directors, Robert D. Dalton, Robert D. Dewell, William H. Ellison, John J. Gould and J. Albert Paquette. Offices: 417 Market St., San Francisco.

## Structural Engineers Association of Central California

William H. Peterson, President; Walter S. Wassum, Vice-President; O. T. Illerich, Sec.-Treas.; Ernest D. Francis, M. A. Ewing, and Arthur A. Sauer, directors. Office O. T. Illerich, c/o Div. of Arch., Sacramento.

## American Society of Civil Engineers Los Angeles Section

Trent R. Dames, President; Stephenson B. Barnes, Vice-President; John M. Server, Vice-President; C. Martin Duke, Secretary, and John Merrell, Jr., Treasurer. Office of Secretary, 3066 Engineering Building, University of California, Los Angeles 24. BRANCHES: Orange County Branch, Harold Sprenger, Pres; Raymond R. Ribal, V-P; Earl K. Burdick, Sec-Tr, 12311 Chapman, Anaheim. San Bernardino-Riverside Counties Branch, Albert A. Webb, Pres; Wright M. Price, V-P; John L. Merriam,

## FEMINEERS

The "Femineers" November meeting, held in the Elks Club, San Francisco, was devoted to an election of officers, committee reports and a colorful demonstration and discussion on "Yule Decorations" which was given by Mrs. Zoe Lindgren, a member of the group.

Another outstanding November event was the annual Semi-Formal Dinner Dance at the St. Francis Yacht Club on San Francisco Bay.

## STRUCTURAL ENGINEERS ASSOCIATION SOUTHERN CALIFORNIA

"Structural Effects of Nuclear Explosions" was the subject of a talk by Frederick A. Grasier, Regional Engineer of the Federal Civil Defense Administration, at the November meeting, held in the Rodger Young Auditorium in Los Angeles.

Grasier presented many ideas of the F.C.D.A. regarding design of buildings, recommended loads, recommended stresses, and design and detailing practice. The Atomic Energy Commission and the Federal Civil Defense Administration conducted "Operation Doorstep" in March of this year, and in this project typical structures were subjected to nuclear explosions. Results of these and other tests were reviewed. An illustrated sound film was also shown.

Three subcommittees have been formed to study structural concrete: John Minasian is chairman of the Precast Concrete Subcommittee and is preparing reports on "Control of Shrinkage at Grouted or Poured Joints," "Diaphragms of Precast Concrete," "Design of Vertical Diaphragms Anchored to Foundations," and "Bearing Wall Design and Test Reports." The second committee, of which Cecil Armour is chairman, is the Prestressed Concrete Subcommittee and a tentative report is being prepared on "Design Stresses and Safety Factors," "Material Specifications," and "Field Practice."

The Fire Resistive Standards of Concrete Subcommittee, F. T. Collins, chairman, is studying recent Fire Underwriters Laboratory tests made on concrete floors, and a special committee is being formed from this committee and the Prestressed Concrete Committee to collaborate with U.C.L.A. in a "Fire Test on Prestressed Concrete" program in which full scale fire tests will be made.

New Members include Harold L. Epstein, ASSOCIATE, and Ralph E. Lind, Jr., MEMBER.

## CALIFORNIA SOCIETY OF PROFESSIONAL ENGINEERS

The largest group of professional engineers ever to assemble on the Pacific Coast will converge on San Francisco when the California Society of Professional Engineers annual convention and trade show will be held next May 27-29.

Professional Engineers is a highly specialized group of executives representing every branch of industry, government, public utilities, manufacturing, and construction.

C. D. Allen, president of the Society and Ignatius H. McCarty, convention chairman, are already working on plans for the event.

## STRUCTURAL ENGINEERS ASSOCIATION OF NORTHERN CALIFORNIA

The November meeting, held in the Engineers Club, San Francisco, was devoted to a discussion of "Earthquake Stresses in a Fifteen-story Building" with the discussion being led by John E. Rinne, Structural Engineer for the Standard Oil Company of California.

Rinne, currently president of the Structural Engineers Association of California, was chairman of the Joint Committee which was recently awarded the Leon S. Moisseiff Award by the American Society of Civil Engineers for their paper "Lateral Forces of Earthquake and Wind."



Sec-Tr; 4865 Park Ave., Riverside. Ventura-Santa Barbara Counties Branch, Robert L. Ryan, Pres; Richard E. Burnett, V-P; George Conahy, Sec-Tr, 649 Doris St., Oxnard.

**American Society of C. E.  
San Francisco Section**

J. G. Wright, President; J. E. Rinne, Vice-President; Howard C. Wood, Vice-President; John S. Longwell, Past President; H. C. Medbery, Secretary, and Richard C. Clark, Treasurer. Office Secretary, S. F. Water Dept., Millbrae.

**Structural Engineers Association of  
Southern California**

Ben Benioff, President; William T. Wright, Vice-President; Charles M. Corbit, Jr., Sec-Treas. Directors: Ben Benioff, William T. Wright, Harold P. King, Henry M. Layne, Joseph Sheffet, Robert J. Kadow and Harold Orsted. Offices, 121 S. Alvarado St., Los Angeles 4.

**Structural Engineers Association of  
Oregon**

Lewis R. Ellingwood, President; Robert M. Bonney, Vice-President; Sully A. Ross, Secretary-Treasurer. Directors William J. Dorner, Roger V. Gillam, Leslie E.

Poole, Rowland S. Rosé. Offices 706 Board of Trade Bldg., 310 S.W. 4th Ave., Portland 4.

**Society of American Military  
Puget Sound Engineering Council  
(Washington)**

R. E. Kister, A. I. E. E., Chairman; E. R. McMillan, A. S. C. E., Vice Chairman; L. B. Cooper, A. S. M. E., Secretary; A. E. Nickerson, I. E. S., Treasurer. Offices. L. B. Cooper, c/o University of Washington, Seattle 5, Washington.

**American Society Testing Materials  
Northern California District**

L. A. O'Leary, Chairman; P. V. Garin, Vice-chairman; H. P. Hoopes, Sec. Office Sec., 1550 Powell St., Emeryville, Calif.

**Society of American Military  
Engineers—San Francisco Post**

CDR N. M. Martinsen, President; L. L. Wise, 1st Vice-President; Col. Paul Berrigan, 2nd Vice-President; R. M. Hamilton, Secretary; Thomas Hurley, Treasurer. Directors, RADM C. A. Trexel, J. G. Wright, LTCOL C. S. Lindsey, C. E. Bentley, F. R. Fowler, BRIGEN D. F. Johns, and RADM L. N. Moeller.

The meeting's discussion centered on the results and engineering significance of a rigorous mathematical analysis by E. C. Robison of the vibration characteristics of the fifteen-story Alexander Building. Subjects included the relative importance of the fundamental and higher modes of vibration; correlation of study with recommendations of the Joint Committee on Lateral Forces, and possible modifications that should be made to earlier recommendations.

A special committee of School Construction Costs has been appointed with George McKee, Chairman.

**AMERICAN SOCIETY OF CIVIL  
ENGINEERS—San Francisco**

Dr. Donald H. McLaughlin, who has been Chairman of the Department of Geology at Harvard University, Dean of the College of Engineering at the University of California, Chairman of the A.E.C. Advisory Committee on Raw Materials, a Director of the American Trust Company, and currently a Regent of the University of California, will speak at the December 2 meeting on the subject "Gold—Still Our Monetary Metal."

The meeting is scheduled for the Marines Memorial Building, San Francisco.

**APPLICANTS PASSING THE  
CALIFORNIA EXAMINATION**

Engineers who passed Structural Engineering examinations held by the State of California, and heretofore unpublished by A&E, include:

Norman Barsh, Cydonor M. Biddison, Walter D. Buehler, Frederick Cheesebrough, O. L. Christensen, Walter Bertin Clausen, Jr., Adolph A. Cohan, Robert D. Dalton, Jr., John R. DeClue, Jr., Raymond H. Deddens, John T. Dibble, Byrne Eggenberger,

Michael Graves, James P. Hawke, William E. Heller, Lawrence J. Hutchison, Coleman W. Jenkins, Harold S. Kellam, Jr., Gordon H. Klippel, Walter A. Leichtfuss, Seymour D. Lester, Ralph Edward Lind, Jr., Donald B. Mauser, Frank Edward McClure, Jack Weston Meadville, W. E. Milburn, Clare F. Myer, Joseph P. Nicoletti, Albert S. Pratt, Jr., Richard F. Silberstein, Albert T. Simpson, Leon Stein, Donald Melvin Teixeira, Paul J. Toien, Arthur Reid Watson, Floyd Edward Weaver, Robert Francis Wildman, Robert Andrew Williamson and Wendell H. Wilson.

**CONSULTING ENGINEERS ASSOCIATION  
OF CALIFORNIA HOLD CONFAB**

One hundred and fifty engineers representing the Consulting Engineers Association of California recently heard a discussion on the problem of "Unfair Competition Between Consulting Engineers in Private Practice and Governmental Agencies," with James Mussatti, general manager of the California State Chamber of Commerce, the principal speaker.

The meeting was held in San Francisco with Mark Falk of Falk & Booth, presiding, and Pecos H. Calahan, formerly Executive Secretary of the California State Board of Registration for Civil and Professional Engineers, serving as Secretary.

**STRUCTURAL ENGINEERS  
FORM NEW ORGANIZATION**

Robert D. Dalton, Structural Engineer, and Robert D. Dalton, Jr., Structural Engineer, have announced the formation of the partnership of Dalton and Dalton, Consulting Structural Engineers, for the practice of Structural Engineering.

Offices of the new firm have been opened at 374 Seventeenth Street in Oakland, California.

# PRODUCER'S COUNCIL PAGE

The National Organization of Manufacturers of Quality Building Materials and Equipment  
(Northern California Chapter) affiliated with THE AMERICAN INSTITUTE OF ARCHITECTS

President, Roly MacNichol  
Libbey-Owens-Ford Glass Co.  
Rialto Bldg.

Vice-President, Ted Bakeman  
F. W. Wakefield Brass Co.  
445 Bryant Street

Secretary, John Cowley  
Hamilton Manufacturing Co.  
2833 3rd Street

Treasurer, Carl Frank  
Detroit Steel Products Co.  
Russ Building

Edited by Stanley L. Basterash—WESTERN ASBESTOS COMPANY

## PRESIDENT'S CONFERENCE NOTES

The annual Producer's Council meeting and President's Conference was a tremendous success, being both informative and interesting.

The reports given by various committees of the national organization gave nothing but encouragement because of the efforts these committees are putting forth to make the Producer's Council a worthwhile and valuable organization to all members. The committees work very closely with the national AIA, NAHB and AGC as well as with most of the government agencies and organizations that concern themselves with the housing and building field.

One of the meetings consisted of round table discussion of all chapter presidents prompting some excellent ideas. Our President's impression was one of complete satisfaction in the performance of the Northern California Chapter. He states we do not have to take a back seat to anyone as far as organization and activities.

The Honorable Albert M. Cole, Administrator of the Housing and Home Finance Agency of the Government, gave an excellent talk entitled "Whose Business is Housing?" Mr. Cole explained relationship between the economy and the housing and building field is getting more and more recognition from every segment of the economy for its importance to the entire economy. Incidentally, he predicted a better than average year in building for next year.

We have been discussing the traveling table top exhibit for some time. This exhibit is to be organized at the national level and moved from city to city, thereby taking a considerable work load from the local chapters. The exhibit would provide better and more uniform display of the quality building materials represented by our organization. We hope there will be more info on this project soon.

Several architects spoke before the assembled group, giving their ideas on the importance and value of the relationship of the Producers' Council to the AIA and their ideas gave confidence to our President that our efforts in the Producers' Council were not in vain; our organization was certainly very much worthwhile.

**"A good building must be built well, work well and look well."**

The award offered for identifying the above statement in the October issue is still open.

VITAMINS do wonders for a guy when you try to build on seven hills.

USE QUALITY PRODUCTS



CONSULT AN ARCHITECT

#### BUILDING INSPECTOR RETIRES

Lyman L. Pope, city building inspector for the City of Santa Barbara for nearly a quarter of a century, has resigned his position with the city to enter private business as a consultant in the construction industry.

#### SOUTHWEST RESEARCH INSTITUTE NAMES NEW RESEARCH EXECUTIVE

Dr. George L. Cunningham, nationally known industrial scientist and research executive, has been named to the staff of Southwest Research Institute, according to an announcement by Dr. Louis Koenig.

An inventor and holder of many patents, Dr. Cunningham will head a group of technologists working toward the advancement of the science and technology of inorganic chemistry and inorganic manufacturing.

#### ALASKA CONTRACT AWARD ANNOUNCED

The Alaska District, Corps of Engineers at Anchorage, recently announced the awarding of a \$2,796,073 construction contract to the firm of Lease-Leighland and M-B Construction companies of Seattle, Washington, as joint venturers.

The contract covers the construction of outside utilities, POL laboratory, guardhouse, package petroleum storage, ammunition shop, ammunition booster station, and the paving of roads, streets, and walks at Fort Richardson.

#### ARCHITECT SELECTED

Architect Mario J. Ciampi of San Francisco has been commissioned by the Board of the Jefferson Union High School District of Daly City, San Mateo County, to draw plans and specifications for the construction of a new High School Building.

Estimated cost of the project is \$2,000,000.

#### NEW ARMORIES ARIZONA GUARD

Plans for construction of five National Guard armories in Arizona have been submitted to the Department of the Army, according to Brig. Gen. Frank E. Fraser, guard adjutant general. Armories would be built at Yuma, Kingman, Mesa, Tempe and Chandler. Estimated cost is \$375,000.

#### NEW OFFICES OPENED FOR HOME BUILDERS INSTITUTE

The Home Builders Institute of Los Angeles county has moved into new offices, according to an announcement by K. Sande Senness, president.

Location of the Institute's offices is at 2330 W. 3rd Street, Los Angeles.

The Institute membership comprises large scale operative builders throughout the county.

#### PASADENA WILL BE "REPLANNED"

Pasadena has been selected for a 10-month city planning study by 63 fifth-year students of the University of Southern California School of Architecture.

Under the direction of Si Eisner, professor and professional community planner, the class project is intended as a part of the university's program to give professional education to students as well as to assist the community of Pasadena.

In cooperation with the Pasadena City Planning Commission, students will study

phases of community development in their economic, social, political and industrial activities. At the conclusion of the study 16 master plans will be submitted to city officials for their use and study.

#### HAROLD'S CLUB REMODELS

Plans are underway for remodeling and construction of an addition to Harold's Club in Reno, Nevada, according to Harold Smith, owner.

The new building will be of 9-story and basement, structural steel frame and reinforced concrete construction, and will cost approximately \$750,000.

Ferris & Erskine of Reno are the Architects.

#### SACRAMENTO AIRPORT ADMINISTRATION

Architect Leonard F. Starks of Sacramento, has completed plans for the construction of a new Administrative Build-

ing at the Sacramento Municipal Airport, Sacramento.

Cost of the 2-story reinforced concrete building will be \$35,000.

#### ARIZONA ENGINEERS HOLD PHOENIX MEET

A joint meeting of the parent engineering societies of Arizona was held early this month in Phoenix.

Host for the joint conference was the Arizona Section of the National Society of Professional Engineers.

#### CALIFORNIA REPORTS ON SUBDIVISIONS

The California State Division of Real Estate reported recently that there were 190 new California subdivisions filed for in September and that this was slightly less than the 12-month average of 200.

The first two months of the fiscal year, 397 new tracts have been filed, compared with 378 a year ago.

**ARCHITECTURAL  
PORCELAIN  
BY  
CAMEO  
SINCE 1911**

When you modernize a store, add customer-appeal and showmanship by specifying Cameo architectural porcelain enamel. You know that it is lightweight, easy to fabricate and construct in any shape or size you desire. But do you know about the new type of porcelain enamel construction, which conforms to the up-to-the-minute trends in building. For engineering specifications, write or call today.

ARCHITECTURAL  
DIVISION



CALIFORNIA Metal Enameling COMPANY

6904 E. SLAUSON AVE., LOS ANGELES 22, CALIFORNIA • Underhill 0-1268



# PERSONALITIES

## **RICHARD L. RONNE, Contractor Home Builder**

SACRAMENTO, CALIFORNIA

Among outstanding personalities in the Construction Industry of California's famous Sacramento Valley is Richard L. Ronne, Executive head of



**RICHARD RONNE**  
Contractor-Home Builder

the firm of **RONNE, RONNE & RONNE**, Contractor and Home Builder, with general offices in the City of Sacramento and branch offices in Marysville and San Francisco.

"Dick" Ronne was born in Nebraska where he lived on a farm as a boy; received his early education in the public schools; and like most youngsters of his age, "dreamed" of the day when he could "go out

West" and seek his fortune in the land of golden opportunity, California.

It was not until 1928 that Ronne had an opportunity to visit the West, and in 1933 he accepted a position with an engineering school in San Francisco as an instructor, also taking charge of details in connection with publication of material used in conjunction with a correspondence course.

Soon tiring of the "big city," Ronne moved to Sacramento where he started in the construction industry as a home builder in 1935. Since that time he has completed many projects in the Sacramento area, and has also built homes and commercial projects in Grass Valley, Richmond, Santa Cruz, Marysville, Vallejo and San Francisco.

Richard Ronne has been very active in development of the Associated Home Builders Association of Sacramento and is currently serving as President of the organization, which represents contractors and builders of Sacramento. He is a Director of the National Home Builders Association with headquarters in Washington, D. C.; a member of the North Sacramento Rotary Club; and a member of the Advisory Board of the Salvation Army.

Ronne resides with his wife and daughter in North Sacramento.

*NEXT MONTH: John A. Blume, Structural Engineer, San Francisco.*

## **ROBERTS APPOINTED CHAIRMAN CALIFORNIA CONTRACTORS BOARD**

H. Cedric Roberts, Southern California contractor, has been elected chairman of the California Contractors' State License Board to serve for the fiscal year ending June 30, 1954.

Roberts has served in various official capacities since his appointment to the board in 1944.

## **REORGANIZATION OF ARCHITECT OFFICE**

Reorganization of the firm of Lance, McGuire & Muri, Architects, in Tacoma, Washington, has been completed and the new firm of McGuire & Muri, Architects, is continuing the practice of architecture from the firm's offices at 231 Broadway, Tacoma, Washington.

## **APPOINTED ON NATIONAL CHURCH PLANNING GROUP**

Walter Hagedohm, Los Angeles A.I.A. architect has been appointed to the church architecture committee of the Lutheran Church, Missouri Synod.

Other members of the committee include Bernard Gunter of New York; Clifford Ramey of Wichita, Kansas; Edgar Stubenrauch of Sheboygan, Wisconsin, and Kenneth E. Wishmeyer, St. Louis, Missouri.

**GEORGE GOBER**  
Architectural Consultant  
**ARTHUR HOLYOKE**  
Contractor



What is conceived on the drawing board may be more practically and more economically achieved with

## **PORCELAIN ENAMEL VENEER**

than with any other facing material on the market today.

WRITE, TODAY, FOR FULL INFORMATION AND COLOR CHART

*Architectural Division*

**PORCELAIN ENAMEL PUBLICITY BUREAU**  
P. O. BOX 186, EAST PASADENA STATION, PASADENA 8, CALIFORNIA  
ROOM 601, FRANKLIN BUILDING, OAKLAND 12, CALIFORNIA

## WRITTEN IN BRONZE

(From Page 22)

the sales territory of the 11 Western States, Hawaii, Alaska and the Philippines. But four short years after its festive dedication, flags stood at half-staff over 765 Folsom Street solemnly to signalize Maurice's sudden death, at the age of 52. On the plant's lobby wall, in his memory, is mounted a bronze plaque. Its lettering reads, "His words and deeds were an inspiration to all who knew him."

The responsibility of guiding the firm through the war years and on toward its second century fell upon Stuart, whose year-in and year-out association with the business had been broken only twice since 1913, for engineering studies at the University of California, and during the First World War, for a tour of duty as a pilot in the U.S. Army Air Corps.

In 1943, at the height of the war effort, more than 500 representatives of the State and city governments, labor, management and the armed forces, and employees of M. Greenberg's Sons and their wives, gathered at a banquet in the Gold Ballroom of The Palace Hotel, to celebrate the firm's 90th birthday.

Morris was gone, and his son Joseph, and his grandson Maurice, but at the speakers' table, as host and managing owner, was his second grandson, Stuart.

Behind him and his co-workers lay 90 years of stability and quality—and a decade of modern expansion during which the foundry had turned out bronze valves by the thousand, and solid bronze faucet handles shaped like birds and chipmunks for the wealthy clientele of V. C. Morris of Maiden Lane; Josam roof and floor drains, and gold-plated shower doors for the San Simeon castle of William Randolph Hearst; brass flanged fittings, and bronze ladders for the swimming pools of Lawrence Tibbett and Will Rogers; bronze bearing plates that held up the Bay and Golden Gate Bridges, and monitor nozzles for fireboats, and hydrants for the City of Manila.

But now the seven oil and gas furnaces of M. Greenberg's Sons were blazing day and night, and the foundry and the machine shop lathes were working at 10 times their normal production rate to make the bronze and brass valves, the flanges and hydrants and couplings desperately needed by the Navy, the Maritime Commission and the Army.

One by one, scores of loyal and old-time employees stepped to the speaker's table to receive from Stuart their service pins, tiny gold replicas of Greenberg fire hydrants. Then, with the praise and congratulations of the speakers ringing in their ears, they smiled with pleasure and satis-

faction as Stuart proudly cut the great white birthday cake.

Surmounting it were tiers of flickering candles and a frosting miniature of No. 58 Halleck Street. In his brief remarks, Stuart had recalled how his grandfather, when he wanted molding sand, would open the foundry's back door, and let the sand blow in from the slope of Nob Hill; and how, when he wanted core sand, he opened the front door, and let in sand from the beach and waterfront.

"Today," he said, "we are producing more in a day than my grandfather produced in a year."

Now, as Stuart sliced the birthday cake in the glare of news photographers' flash bulbs, the workers—some of whom had been with the firm for more than 30 years—thought of their three-story, steel-and-concrete plant on Folsom Street. As they applauded Stuart, they said to each other, "How far we've come since then. How much has been done in 90 years."

The Stars and Stripes rippled triumphantly over 756 Folsom Street during the war years.

General MacArthur cabled Stuart and his employees from the South Pacific: "... We soldiers on the firing line give thanks to you soldiers on the production line for the sinews of war that make

## Summerbell for CHURCHES



Methodist Church,  
Sherman Oaks, Calif.  
Architects,  
Frick & Frick.  
General Contractors,  
J. H. Baum & Sons.

**SUMMERBELL** glued laminated arches and beams give the Architect the widest latitude in designing for the modern or the traditional...for the large cathedral or the small chapel. In addition to their lasting beauty, they provide structural advantages which effect substantial economies in overall costs. Write for illustrated brochure.

Glued Laminated Construction • Summerbell Bowstring Trusses  
Lamella Roofs & All Types of Timber Structures

For quality, economy and satisfaction, specify **SUMMERBELL**

**Summerbell** ROOF STRUCTURES  
825 EAST 29TH STREET • BOX 218, STATION "K" • LOS ANGELES 11

victory possible . . .

General Eisenhower radioed him from North Africa: "Our fighting men, standing shoulder to shoulder with our gallant allies, the British and the French, have driven the enemy out of North Africa. . . . There is glory for us all in this achievement."

Rear Admiral E. L. Cochrane wired Stuart from Washington, three days before the invasion of Normandy: "Your excellent performance of duty . . . has made it possible for the building yards to exceed the quotas of landing craft set by the combined chiefs of staff. . . . The Bureau of Ships desires to pass to all hands concerned the message, 'Well and smartly done.'"

Today, commemorating his firm's 100th birthday and looking forward to the beginning of a second century of service, Stuart N. Greenberg remains a modest, unassuming, cheerful, confident, shirt-sleeved executive whose 250 employees from drafting room to foundry call him by his first name.

He directs the \$4,500,000-a-year affairs of the largest manufacturing plant of bronze products in the West from an air-conditioned office paneled in bleached walnut, and is pleased when discerning visitors express their admiration of the smart Chinese modern decor of the plant's impressive bamboo-papered conference room.

Among his employees, who share an annual payroll of \$1,250,000 and enjoy the protection of the firm's own pension and insurance program, are two up-and-coming members of the fourth generation of Greenbergs, Stuart, Jr., and Maurice's son, John M. Greenberg.

On the third floor, above Stuart's second-floor office, the machine shop lathes spin ceaselessly, and draughtsmen bend over their north-lighted drawing tables. On the ground floor the foundry furnaces blaze and roar all day long, and foundrymen pour the white-hot metal that streams like liquid fire from crucible to mold.

In the shipping rooms stand row upon row of freshly painted, applegreen and Underwriters' approved fire hydrants awaiting shipment to Oregon and New Mexico, South America and Alaska and Saudi-Arabia; anti-magnetic bronze fittings for Navy mine-sweepers; bronze valves for ships that will ply the seven seas to every port in the world; gleaming brass nozzles for fireboat hoses; heavy, highly polished bronze crematory urns; bronze markers for the graves of the Nation's war dead; massive bronze name plates and historical plaques; Underwriters' approved standpipes for the West's new industrial plants and skyscrapers; Josam brass and iron drains and other Josam drainage products destined for hotel and hospital projects; shining, mellow-toned silicon bronze bells for the bridges of the Navy's fighting ships.

To the east, the mighty towers of the Bay bridge cast their shadows across the sites of the Beale and Fremont Street plants. To the north, in the heart of San Francisco's busy financial district, the granite-pillared Bank of California covers the location of Morris Greenberg's little Gold Rush foundry.

"Our story is written in bronze," Greenberg employees say.

There is more to it—and it is more enduring—than that; for it is also written in the deeds and lives, the faith, courage and industry of a pioneer, and his sons, and his grandsons.



Interior  
Woodwork

Saks Fifth Ave.  
San Francisco

Manufactured and  
Installed by

## THE FINK & SCHINDLER CO.

Since 1882

552 Brannan Street San Francisco, Calif. EXbrook 2-1513

CONTRACTORS — QUARRIERS — FABRICATORS

ALL TYPES OF

◆ GRANITE ◆

SPECIALIZING IN  
CALIFORNIA GRANITES

*Pacific Cut Stone & Granite Co.*

Home Office:  
414 So. Marengo Ave.  
Alhambra, Calif.  
Box 30, Ph. CU 31711

BLACK  
DIAMOND  
◆  
GRANITE

Fabricating Plants  
at  
Alhambra, Calif.  
Clovis, Calif.

### PRESIDENT EISENHOWER APPOINTS WILLIAMS

Paul Williams, Southern California A.I.A. Architect, has been appointed by President Eisenhower to serve on the newly appointed Housing Advisory Commission.

Williams has served as a member of the California State Housing Commission and the Los Angeles Municipal Housing Commission.

### ARCHITECTURAL FIRM ANNOUNCES OPENING

Wm. Glenn Balch, Louis L. Bryan, John Loring Perkins and W. K. Hutchason have announced

ARCHITECT AND ENGINEER



the formation of the architectural firm of Balch, Bryan, Perkins & Hutchason for the general practice of architecture.

Offices of the new firm are located at 2933 Rowena Avenue, Los Angeles, California.

#### MOSAIC TILE COMPANY EXPANDS ON COAST

Opening of a new showroom and warehouse in Seattle, and opening of a Fresno warehouse were recently announced by Thomas B. Jordan, Western Manager of the Mosaic Tile Company.

The new Seattle building features contemporary styling and occupies 6,000 sq. ft., 800 of which is devoted to office space and showroom. Special facilities have been provided for loading and unloading trucks.



New Seattle Offices

Activities of the Seattle district are under the direction of R. Burton Corcoran, manager of the Washington operations of the firm for the past two years.

The Fresno warehouse and showroom, while under the supervision of A. E. Guerra, district supervisor of the San Francisco, Salt Lake, and Fresno offices, will be managed by Howard DeWeese, formerly warehouse manager in San Francisco.

In making the announcement Thomas B. Jordan said, "This expansion on the West Coast is in line with our policy of best possible service to the customer."

#### NEWS & COMMENT ON ART

(From Page 4)

CISCO ART ASSOCIATION; CONTEMPORARY AMERICAN INDIAN ARTS AND CRAFTS, in cooperation with the U. S. Department of the Interior; PAINTINGS BY MAX HEIMANN, retrospective exhibition; DRAWINGS BY FRANCIS DE ERDELY, and SOCIETY OF WESTERN ARTISTS, 14th Annual Exhibition.

Special activities include Museum tours, and adult and children classes in painting.

## J. BETTANCOURT GENERAL CONTRACTOR AND BUILDER

1015 SAN MATEO AVENUE  
SAN BRUNO, CALIFORNIA  
Phone: JUnO 8-7525

## Parker, Steffens & Pearce BUILDERS

135 South Park, San Francisco  
Phone: EXbrook 2-4832

## FORORDERER CORNICE WORKS

Manufacturers of

Hollow Metal Products • Interior Metal Trim  
Elevator Fronts and Cabs  
Metal Plaster Accessories • Sanitary Metal Base  
Flat and Roll Metal Screens  
Metal Cabinets • Commercial Refrigerators

269 POTRERO AVE.

SAN FRANCISCO, CALIF. HEMLOCK 1-4100

## CLASSIFIED ADVERTISING

Do YOU want to hire, buy, sell, rent, find, lose, and otherwise transact business with others in the Construction Industry? If so, your best bet is a CLASSIFIED ad in ARCHITECT & ENGINEER magazine.

SELL that used equipment at a good price; secure competent employees; buy good used equipment; obtain information on wanted materials, etc.

Rates are low 20 cents per word—cash with order—minimum 3 lines. "Position Wanted" ads are half-rate. Forms close 20th of month preceding date of publication.

ARCHITECT & ENGINEER  
MAGAZINE

68 Post Street

San Francisco

# HOGAN LUMBER CO.

Wholesale and Retail

## LUMBER

MILL WORK • SASH & DOORS

Office, Mill, Yard and Docks

SECOND AND ALICE STREETS • OAKLAND, CALIF.

Telephone GLencourt 1-6861

# HAAS and HAYNIE

Formerly Haas Construction Company

Since 1898

275 PINE ST.

SAN FRANCISCO, CALIF.

Phone DOuglas 2-0678

# JUDSON PACIFIC-MURPHY CORP.

Steel Fabricators  
and  
Erectors

REINFORCING STEEL

STRUCTURAL STEEL

BRIDGE CRANES

4300 EASTSHORE HWY.  
EMERYVILLE, CALIF.

Phone:  
OL 3-1717

# CLINTON CONSTRUCTION CO. OF CALIFORNIA

General Contractors

923 FOLSOM STREET • SAN FRANCISCO

SUtter 1-3440

## BOOK REVIEWS PAMPHLETS AND CATALOGUES

**SCHOOL RESEARCH THESIS.** Department of Architecture. Pratt Institute, Brooklyn 5, N. Y.

The New York State State Association of School Business Officials released this study in cooperation with the Department of Architecture of Pratt Institute.

During the next two decades, school business officers and architects will jointly plan and erect billions of dollars worth of new or modernized school plants. No other aspect of public expenditure will affect so many people, or have as lasting and vital an impact upon our American way of life. Architects, engineers, school administrators, teachers, and public spirited citizens can all gain much if new American schools are efficiently planned, attractively designed, and economically constructed. This publication contains many drawings, charts, and study surveys.

**POWER IN BUILDINGS. An Artist's View on Contemporary Architecture.** By Hugh Ferriss. Columbia University Press, 2960 Broadway, New York 27. Price \$8.50.

Through sixty impressive drawings and a nontechnical, explanatory text, this book gives the reader a vivid impression of the power of building in the United States today.

Drawings portray outstanding structures designed since 1929. A brief introduction sketches architectural developments previous to that date as the author saw them at first hand, and traces the development of the contemporary architectural character through the buildings shown. Illustrations include viaduct, bridge anchorage, grain elevator, power dam, and lead through industrial plants and office buildings.

Architects, engineers, city-planners, students and contractors will be interested in this book.

**ARCHITECTURE THROUGH THE AGES.** By Tolbot Hamlin. G. P. Putnam's Sons, publishers, 210 Madison Ave., New York City. Price \$10.

The author, Tolbot Hamlin, is the well known Prof. of Architecture at Columbia University, and in this book revises the rapid growth of architectural knowledge and the maturing and clarification of the movement generally called Modern Architecture. Many of the older illustrations have been re-engraved and some 23 new illustrations covering the work of the post-war period have been added.

The aim of the book, designed for the general reader as well as for the architect and the student of architecture, is to show that buildings are not isolated objects existing arbitrarily in one or another of the recognized set styles, but rather the inevitable results of the ways of living, governing, worshipping, and doing business in practice at the time they were built.

## NEW CATALOGUES AVAILABLE

*Architects, Engineers, Contractors, Planning Commission members—the catalogues, folders, new building products material, etc., described below may be obtained by directing your request to the name and address given in each item.*

**Marble for the home.** A Marble Forecast for 1953-54 entitled "Marble For The Home" has just been prepared for distribution to architects, engineers, and contractors by the Marble Institute of America; contains considerable data on types and uses of marble. For free copy write Dept. A&E, Marble Institute of America, Inc., 108 Forster Avenue, Mount Vernon, New York.

**Channel frames and fittings.** New catalog contains installation photographs, illustrations and information on various types and sizes of channel frame and fittings, engineering data charts, and how and where to buy and other useful material; featuring Multi-A-Frame, fully-locking, completely reusable; can be quickly assembled or disassembled. Write for booklet Dept. A&E, Multi-A-Frame Division, 1471 E. Atwater St., Detroit, Mich.

**Soap dispensers.** New multi-colored catalog illustrating extensive Bobrick line of quality soap dispensers, valves and tanks is now available to architects, engineers, contractors and specifiers; contains data on capacity, dimensions, and individual features of each model illustrated. Free copy write Dept. A&E, Bobrick Mfg. Corp., 1214 Nostrand Ave., Brooklyn 25, N. Y.

**Solenoid valves.** New catalog on Eclipse "DO" Solenoid Valves is now available. Contains valve illustrations; drawings of operation; dimensions of valves and a complete table of specifications and prices. For free copy write Dept. A&E, Eclipse Fuel Engineering Co., 1001 Buchanan St., Rockford, Ill.

**Plywoods.** New full-color catalog on Malarkey plywoods and full line of panel and flush doors with complete architectural and other data is now available, to architects, specifiers and contractors. It includes several new products including PT Boat Panels, Fir and redwood Shadowwood with matching Shadowwood moldings, plate rails and battens. Write Dept. A&E, M and M Wood Working Co., 2310 N. Columbia Blvd., Portland, Oregon.

**World's smallest complete kitchen.** Now available complete information and specifications on the GENERAL CHEF complete kitchen unit. Ideal for motels, hotels, apartments, offices, factories, trailers; new installations or for remodeling where space saving is a factor. Write Dept. A&E, GENERAL CHEF, 4536 E. Dunham Street, Chicago, Ill., or Suite 762, 11 West 42nd St., Los Angeles.

**Floors and Floor Problems.** An attractive 24-page brochure offering authoritative discussion of floor covering problems; well illustrated, drawings, and diagrams—covering various types of floors, how they are built, what factors enter into their deterioration, and how floor troubles can be diagnosed and treated. Divided into 10-sections. Copies of A.I.A. File No. 23D, 25G, may be obtained by writing Dept. A&E, The Tremco Mfg. Co., 8701 Kinsman Road, Cleveland, Ohio.

**Steel rolling service doors.** New 12-Page catalog, Bulletin No. 301, gives illustrative data on fire doors, grilles, aluminum rolling counter doors and specialty doors. Featured is a series of charts designed to simplify selection of proper gauge and type of slats, guide type, power units and other components. Blueprints on 12-basic door types show necessary architectural dimensions; Underwriter's Laboratory Label requirements fully outlined. Complete architectural specifications. Designed to use in warehouses, garages, factories, and other commercial and industrial applications. For free copy write Dept. A&E, The Cookson Co., 1525 Cortland Ave., San Francisco 10.

**Storage partitions.** Storage partitions made of thin studless walls are described in an illustrated 8-page non-technical booklet just issued by the University of Illinois Small Homes Council. Walls are slimmed by using a studless panel made of 3/8" gypsum board bonded with linoleum paste to 1/8" hard-board. Units 12, 16, or 24" deep, fitted with shelves, rods, or drawers as needed; fit side-by-side or back-to-back. Single copies of "STORAGE PARTITIONS", No. C5.11, are available by writing Dept. A&E, Small Homes Council, Mumford House, University of Illinois, Urbana, Ill.

**Metal lath centering.** Illustrated brochure just off the press shows types of metal lath used in centering, details and sample specifications for installation, spans and safe loads for 3/8" and 1/2" rib lath and sheet lath. Technical Bulletin No. 6, for free copy write Dept. A&E, Metal Lath Manufacturers Ass'n., Engineers Building, Cleveland 14, Ohio.

**Standard steel or aluminum buildings.** Complete information is now available in a new catalog issued by the Soule' Steel Company on "Standard Steel or Aluminum Pre-Engineered Buildings". The 24-page, illustrated catalog gives full data on construction, erection details, and facts about all-bolted units. Pictures show some of the varied materials, unit combinations, and designs that add eye appeal to industrial and commercial buildings. For free copies write Dept. A&E, Soule' Steel Company, 1750 Army St., San Francisco.

**Contemporary lighting fixtures.** Just published comprehensive brochure on contemporary lighting fixtures; Recessed—12 pages in color, fully illustrated, detailing dimensions, wattage and framing-in details for flush lights, Surface Fixtures and Portable Lamps—8 pages, illustrated detail on full line of modern fixtures; wide range of colors and finishes; ideal for new construction and remodeling. A.I.A. File No. 31-F-23. Write Dept. A&E, The Prescolite Mfg. Corp., 2229 4th Street, Berkeley 10, for free copy.

**Marble forecast.** The Marble Institute of America, Inc., has just issued a brochure entitled "Marble Forecast 1953-1954"—Marble for the Home in color giving complete and interesting information on the use of Marble in construction—new and remodeling. Write Dept. A&E, Marble Institute of America, Inc., 108 Forster Avenue, Mount Vernon, New York.

**The Most Complete Line of  
STEELS and STEEL BUILDING MATERIALS  
Made by a Single Producer**



See Sweet's Catalog File or write us for full information.

**REPUBLIC STEEL CORPORATION**

GENERAL OFFICES: CLEVELAND, OHIO

DENVER, COLORADO . . . . . CONTINENTAL OIL BUILDING  
LOS ANGELES, CALIF. . . . . GENERAL PETROLEUM BUILDING  
SAN FRANCISCO, CALIFORNIA . . . . . RIALTO BUILDING  
SEATTLE, WASH. . . . . WHITE-HENRY-STUART BUILDING

**PACIFIC  
MANUFACTURING CO.**

**High Class Interior Finish Quality  
Millwork**

16 Beale St., San Francisco  
GARfield 1-7755

2215 El Camino Real, San Mateo  
Fireside 5-3531

2610 The Alameda, Santa Clara  
AXminster 6-2040 (Factory)

6820 McKinley Avenue, Los Angeles  
PLeasant 8-4196

MAIN OFFICE — SANTA CLARA

**"AMERICAN - MARSH"  
CONDENSATION UNIT**

Pumping  
Machinery  
for  
Every  
Purpose

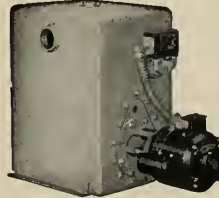

For Service  
Call  
DOuglas  
2-6794  
or  
MUtual 8322

**SIMONDS MACHINERY CO.**  
SAN FRANCISCO 816 FOLSOM  
LOS ANGELES 455 EAST 4TH

**VERMONT  
MARBLE COMPANY**

**DOMESTIC AND IMPORTED MARBLES  
GRANITE VENEER**

525 MARKET STREET • SAN FRANCISCO 5

Phone: SUtter 1-6747

3522 COUNCIL STREET • LOS ANGELES 4

Phone: DUmkirk 2-7834



**BUILDING INDUSTRY CONFERENCE  
BOARD HOLDS ANNUAL DINNER**

The Annual Achievement Awards Dinner of the Building Industry Conference Board of Northern California was held at the Palace Hotel on November 12.

James W. Follin, Director of the Slum Clearance and Urban Re-development Division of the Housing and Home Finance Agency, Washington, D. C. was the principal speaker.

The Annual Awards Dinner has become an important part of the construction industry of Northern California and the Awards are made annually for outstanding achievement and for service to the industry.

Participating organizations in the Conference Board are the Northern California Chapter The American Institute of Architects; San Francisco Section, American Society of Civil Engineers; Structural Engineers Association of Northern California; The Producers Council, San Francisco Chapter; Building Owners & Managers Association of San Francisco; Associated Home Builders of San Francisco; Central California Chapter, The Associated General Contractors of America, Inc.;

Golden Gate Chapter, American Society of Heating and Ventilating Engineers; San Francisco Federal Savings and Loan Association; Consulting Engineers Association of California, and the Association of Landscape Architects.

**KRAFTILE AWARDED HONORS  
AT CALIFORNIA STATE FAIR**

Recognition was accorded the Kraftile Company at the recent California State Fair, held in Sacramento, for "the Best Display of Tile Products" at the 1953 fair.



Above illustration shows Harry Bartell, member of the Alameda County Board of Supervisors, presenting Jos. B. Peebles, Sales Promotion Manager of Kraftile Company, Niles, California, the coveted Blue Ribbon designating 1st Prize.

**DONALD H. HERAK APPOINTED  
DISTRICT ENGINEER AT SPOKANE**

Donald H. Herak has been appointed District Engineer of the Spokane office of the Portland Cement Association, according to an announcement by Carl D. Franks, association president. He succeeds Robert E. Tobin.

Graduating in 1946 from Gonzaga University, Spokane, Herak joined the U.S. Bureau of Reclamation as a construction engineer at Hungry Horse Dam in Montana. He joined the Portland Cement Association in 1951 as field engineer for the Spokane office, and as the new District Engineer will direct Association activities in eastern Washington and northern Idaho.

**OPENS ARCHITECTURAL OFFICES  
IN MERCED, CALIFORNIA**

Paul C. Shattuck, A.I.A., architect, has opened new offices in Merced, California, for the general practice of architecture. He was formerly associated with Architect Robert Jones, A.I.A., of Carmel.

Architect Shattuck has been commissioned to design a new Professional Building to be built in Merced at an estimated cost of \$125,000.00.

**HOLLYWOOD JUNIOR  
COMBINATION  
SCREEN and METAL SASH DOOR  
★  
The "WEATHER-WISE"  
DOOR!!**

**A VENTILATING SCREEN DOOR  
A SASH DOOR  
A PERMANENT OUTSIDE DOOR  
ALL 3 IN 1!**

Discriminating home owners and architects have chosen Hollywood Junior as the TRIPLE DOOR VALUE in the COMBINATION SCREEN and METAL SASH DOOR field! A sturdy dependable door, constructed of quality materials, HOLLYWOOD JUNIOR'S EXCLUSIVE PATENTED FEATURES have outmoded old-fashioned screen doors and other doors of its type entirely!

**IT GUARANTEES YOU YEAR 'ROUND  
COMFORT, CONVENIENCE and ECONOMY**

WE ALSO MANUFACTURE A COMPLETE LINE OF  
SHUTTERS, C. C. DOORS, SCREENS, SCREEN DOORS, LOUVRE DOORS

**WEST COAST SCREEN CO.**  
1145 EAST 63rd STREET      LOS ANGELES, CALIFORNIA  
ADAMS 11108

WRITE FOR FREE ILLUSTRATED LITERATURE

# ESTIMATOR'S GUIDE

## BUILDING AND CONSTRUCTION MATERIALS

PRICES GIVEN ARE FIGURING PRICES AND ARE MADE UP FROM AVERAGE QUOTATIONS FURNISHED BY MATERIAL HOUSES TO SAN FRANCISCO CONTRACTORS. 3% SALES TAX ON ALL MATERIALS BUT NOT LABOR

All prices and wages quoted are for San Francisco and the Bay District. There may be slight fluctuation of prices in the interior and southern part of the state. Freight charge, at least, must be added in figuring country work.

**BONDS**—Performance or Performance plus Labor and Material Bond(s), \$10 per \$1000 on contract price. Labor & Material Bond(s) only, \$5.00 per \$1000 on contract price.

**BRICKWORK—MASONRY—**

Common Brick—Per 1 M laid—\$150.00 up (according to class of work).  
 Face Brick—Per 1 M laid—\$200.00 and up (according to class of work).  
 Brick Steps—\$3.00 and up.  
 Common Brick Veneer on Frame Bldgs.—Approx. \$1.20 and up—(according to class of work).  
 Face Brick Veneer on Frame Bldgs.—Approx. \$2.00 and up (according to class of work).  
 Common Brick—\$36.00 per M truckload lots, delivered.  
 Face Brick—\$81.00 to \$106.00 per M, truckload lots, delivered.

**Glazed Structural Units—Walls Erected—**

Clear Glaze—  
 2 x 6 x 12 Furring ..... \$2.00 per sq. ft.  
 4 x 6 x 12 Partition ..... \$2.25 per sq. ft.  
 4 x 6 x 12 Double Faced  
 Partition ..... 3.00 per sq. ft.  
 For colored glaze add ..... .30 per sq. ft.  
 Mantel Fire Brick \$150.00 per M—F.O.B. Pittsburgh.

Fire Brick—Per M—\$111.00 to \$147.00.

Carriage—Approx. \$10.00 per M.

Paving—\$75.00.

**Building Tile—**

8x5 1/2x12-inches, per M ..... \$139.50

6x5 1/2x12-inches, per M ..... 105.00

4x5 1/2x12-inches, per M ..... 84.00

**Hollow Tile—**

12x12x2-inches, per M ..... \$146.75

12x12x3-inches, per M ..... 156.85

12x12x4-inches, per M ..... 177.10

12x12x6-inches, per M ..... 235.30

F.O.B. Plant

**BUILDING PAPER & FELTS—**

1 ply per 1000 ft. roll ..... \$5.30

2 ply per 1000 ft. roll ..... 7.80

3 ply per 1000 ft. roll ..... 9.70

Brownskin, Standard 500 ft. roll ..... 6.85

Sisal kraft, reinforced, 500 ft. roll ..... 8.50

**Sheathing Papers—**

Asphalt sheathing, 15-lb. roll ..... \$2.70

30-lb. roll ..... 3.70

Dampcourse, 216-ft. roll ..... 2.95

Blue Plasterboard, 60-lb. roll ..... 5.10

**Felt Papers—**

Deadening felt, 3/4-lb., 50-ft. roll ..... \$4.30

Deadening felt, 1-lb. .... 5.05

Asphalt roofing, 15-lbs. .... 2.70

Asphalt roofing, 30-lbs. .... 3.70

**Roofing Papers—**

Standard Grade, 108-ft. roll, Light ..... \$2.50

Smooth Surface, Medium ..... 2.90

Heavy ..... 3.40

M. S. Extra Heavy ..... 3.95

**BUILDING HARDWARE—**

Sash cord com. No. 7 ..... \$2.65 per 100 ft.

Sash cord com. No. 8 ..... 3.00 per 100 ft.

Sash cord spot No. 7 ..... 3.65 per 100 ft.

Sash cord spot No. 8 ..... 3.35 per 100 ft.

Sash weights, cast iron, \$100.00 ton. .... \$3.75

1-Ton lots, per 100 lbs. .... 4.75

Less than 1-Ton lots, per 100 lbs. .... 4.75

Nails, per keg, base ..... \$12.55

8-in. spikes ..... 12.45

Rim Knob lock sets, No. 8 ..... \$1.80

Butts, dull brass plated on steel, 3/2x3/32" ..... .76

**CONCRETE AGGREGATES—**

The following prices net to Contractors unless otherwise shown. Carload lots only.

	Bunker per ton	Del'd per ton
Gravel, all sizes.....	\$2.44	\$2.90
Top Sand.....	2.38	3.13
Concrete Mix.....	2.38	3.06
Crushed Rock, 1/4" to 3/4".....	2.38	2.90
Crushed Rock, 3/4" to 1 1/2".....	2.38	2.90
Roofing Gravel.....	2.81	2.90
River Sand.....	2.50	3.00
Sand—		
Lapis (Nos. 2 & 4).....	3.56	3.94
Olympia (Nos. 1 & 2).....	3.56	3.88
Cement—		
Common (all brands, paper sacks), Per Sack, small quantity (paper).....	\$1.05	
Carload lots, in bulk, per bbl.).....	3.55	
Cash discount on carload lots, 10c a bbl, 10th Prox., less than carload lots, \$4.00 per bbl. f.o.b. warehouse or delivered.		
Cash discount 2% on L.C.L.		
Trinity White.....	1 to 100 sacks, \$3.50 sack warehouse or del.; \$9.56 bbl. carload lots.	
Medusa White.....		

**CONCRETE READY-MIX—**

Delivered in 4-yd. loads:  
 Per cubic yard, 1-8 Mix..... \$ 9.80  
 1-7 Mix..... 10.15  
 1-6 Mix..... 10.70  
 1-5 Mix..... 11.40  
 Curing Compound, clear, drums, per gal. .... 1.03

**CONCRETE BLOCKS—**

	Haydite	Ba-salt
4x8x16-inches, each.....	\$.19	\$.19
6x8x16-inches, each.....	.23	.235
8x8x16-inches, each.....	.27	.27
12x8x16-inches, each.....	.38	.40
12x8x24-inches, each.....		.60
Haydite Aggregates—		
3/4-inch to 3/8-inch, per cu. yd.....	\$7.75	
3/8-inch to 1/2-inch, per cu. yd.....	7.75	
No. 6 to 0-inch, per cu. yd.....	7.75	

**DAMP-PROOFING and Waterproofing—**

Two-coat work, \$9.00 per square.  
 Membrane waterproofing—4 layers of saturated felt, \$10.00 per square.  
 Hot coating work, \$5.00 per square.  
 Medusa Waterproofing, \$3.50 per lb. San Francisco Warehouse.  
 Tricosal concrete waterproofing, 60c a cubic yd. end up.

**ELECTRIC WIRING—**\$15 to \$20 per outlet for conduit work (including switches).  
 Knob and tube average \$6.00 per outlet.

**ELEVATORS—**

Prices vary according to capacity, speed and type. Consult elevator companies. Average cost of installing a slow speed automatic passenger elevator in small four story apartment building, including entrance doors, about \$9,500.00.

**EXCAVATION—**

Sand, \$1.00; clay or shale, \$1.50 per yard. Trucks, \$30 to \$45 per day.

Above figures are an average without water. Steam shovel work in large quantities, less; hard material, such as rock, will be considerably more.

**FIRE ESCAPES—**

Ten-foot galvanized iron balcony, with stairs, \$250 installed on new buildings; \$300 on old buildings.

**FLOORS—**

Asphalt Tile, 1/8 in. gauge 18c to 35c per sq. ft.  
 Composition Floors, such as Magnesite, 40c-\$1.25 per sq. ft.  
 Linoleum, standard gauge, sq. yd.....\$2.75  
 Mastipave—\$1.50 per sq. yd.  
 Battleship Linoleum—1/8"—\$3.00 sq. yd.  
 Terrazo Floors—\$2.00 per sq. ft.  
 Terrazo Steps—\$2.50 per lin. ft.  
 Mastic Wear Coat—according to type—20c to 35c.

**Hardwood Flooring—**

**Oak Flooring—T & G—Unfin.—**

	3 1/2x2 1/4	1 1/2x2 3/8x2	3/8x2 1/2
Clear Qtd., White.....	\$425	\$405	\$
Clear Qtd., Red.....	405	380	
Select Qtd., Red or White.....	355	340	
Clear Pln., Red or White.....	355	340	335 315
Select Pln., Red or White.....	340	330	325 300
#1 Common, Red or White 315	310	305	280
#2 Common, Red or White 305			

**Refinished Oak Flooring—**

	Prime	Standard
1/2 x 2.....	\$369.00	\$359.00
1/2 x 2 1/2.....	380.00	370.00
3/4 x 2 1/2.....	390.00	380.00
3/4 x 3.....	375.00	365.00
3/4 x 3 1/2.....	395.00	375.00
3/4 x 2 1/4 & 3/4 Ranch Plank.....		415.00

**Unfinished Maple Flooring—**

3/4 x 2 1/4 First Grade.....	\$390.00
3/4 x 2 1/4 2nd Grade.....	365.00
3/4 x 2 1/4 2nd & Btr. Grade.....	375.00
3/4 x 2 1/4 3rd Grade.....	240.00
3/4 x 3/4 3rd & Btr. Jrd. EM.....	380.00
3/4 x 3/2 2nd & Btr. Jrd. EM.....	390.00
33/32 x 2 1/4 First Grade.....	400.00
33/32 x 2 1/4 2nd Grade.....	360.00
33/32 x 2 1/4 3rd Grade.....	320.00
Floor Layer Wage \$2.83 per hr.	

**GLASS—**

Single Strength Window Glass.....\$ .30 per sq. ft.  
 Double Strength Window Glass..... .45 per sq. ft.  
 Plate Glass, 1/4 polished to 75..... 1.60 per sq. ft.  
 75 to 100..... 1.74 per sq. ft.  
 1/4 in. Polished Wire Plate Glass..... 2.50 per sq. ft.  
 1/4 in. Rgh. Wire Glass..... .80 per sq. ft.  
 1/4 in. Obscure Glass..... .44 per sq. ft.  
 3/8 in. Obscure Glass..... .63 per sq. ft.  
 1/2 in. Heat Absorbing Obscure..... .54 per sq. ft.  
 3/4 in. Heat Absorbing Wire..... .72 per sq. ft.  
 1/2 in. Ribbed..... .44 per sq. ft.  
 3/8 in. Ribbed..... .63 per sq. ft.  
 1/4 in. Rough..... .44 per sq. ft.  
 3/8 in. Rough..... .63 per sq. ft.  
 Glazing of above additional \$15 to \$30 per sq. ft.  
 Glass Blocks, set in place..... 3.50 per sq. ft.

**HEATING—**

**Furnaces—Gas Fired**

Floor Furnace, 25,000 BTU.....	\$ 70.50
35,000 BTU.....	77.00
45,000 BTU.....	90.50
Automatic Control, Add.....	39.00
Dual Wall Furnaces, 25,000 BTU.....	91.50
35,000 BTU.....	99.00
45,000 BTU.....	117.00
With Automatic Control, Add.....	39.00
Unit Heaters, 50,000 BTU.....	202.00
Gravity Furnace, 65,000 BTU.....	198.00
Forced Air Furnace, 75,000 BTU.....	313.50

**Water Heaters—5-year guarantee**  
 With Thermostat Control,  
 20 gal. capacity..... 87.50  
 30 gal. capacity..... 103.95  
 40 gal. capacity..... 120.00

## INSULATION AND WALLBOARD—

Rockwool Insulation—	
(2") Less than 1,000 sq. ft.	\$64.00
(2") Over 1,000 sq. ft.	\$9.00
Cotton Insulation—Full thickness (3½")	\$.95 50 per M sq. ft.
Sisalation Aluminum Insulation—Aluminum coated on both sides	\$23.50 per M sq. ft.
Tileboard—4"x6" panel	\$9.00 per panel
Wallboard—½" thickness	\$55.00 per M sq. ft.
Finished Plank	\$9.00 per M sq. ft.
Ceiling Tileboard	\$9.00 per M sq. ft.

**IRON**—Cost of ornamental iron, cast iron, etc., depends on designs.

## LUMBER—

S4S No. 2 and better common O.P. or D.F., per M. f.b.m.	\$100.00
Rough, No. 2 common O.P. or D.F., per M. f.b.m.	95.00

## Flooring—

V.G.—D.F. B & Efr. 1 x 4 T & G Flooring	\$225.00
"C" and better—all	225.00
"D" and better—all	225.00
Rwd. Rustic—"A" grade, medium dry, 8 to 24 ft.	185.00

plywood, per M sq. ft.	
½-inch, 4,0x8-0-15	\$125.00
½-inch, 4,0x8-0-15	219.00
¾-inch, per M sq. ft.	292.00
Plyscord	11½¢ per ft.
Plyform	25¢ per ft.

Shingles (Rwd. not available)—	
Red Cedar No. 1—\$9.50 per square; No. 2, \$7.00; No. 3, \$5.00.	
Average cost to lay shingles, \$6.00 per square.	
Cedar Shakes—½" to ¾" x 24/26 in hand-split tapered or split resawn, per square	\$15.25
¾" to 1½" x 24/26 in split resawn, per square	17.00
Average cost to lay shakes, \$8.00 per square.	
Pressure Treated Lumber—	
Wolmanized—Add \$35 per M to above Creosoted.	
8-lb. treatment	Add \$45 per M to above

## MARBLE—(See Dealers)

## METAL LATH EXPANDED—

Standard Diamond, 3.40, Copper Bearing, LCL, per 100 sq. yds.	\$43.50
Standard Ribbed, ditto	\$47.50

## MILLWORK—Standard.

D. F. \$150 per 1000, R. W. Rustic \$175 per 1000 (delivered).	
Double hung box window frames, average with trim, \$12.50 and up, each.	
Complete door unit, \$15 to \$25.	
Screen doors, \$8.00 to \$12.00 each.	
Patent screen windows, \$1.25 a sq. ft.	
Cases for kitchen pantries seven ft. high, per lineal ft., upper \$9.00 to \$11.00; lower \$12.00 to \$13.00.	
Dining room cases, \$20 per lineal foot. Rough and finish about \$1.00 per sq. ft.	
Labor—Rough carpentry, warehouse heavy framing (average), \$75.00 per M.	
For smaller work average, \$85.00 to \$100. per 1000.	

## PAINTING—

Two-coat work	per yard 85c
Three-coat work	per yard \$1.10
Cold water painting	per yard 25c
Whitewashing	per yard 15c

Linsed Oil, Strictly Pure	Wholesale
(Base 7½ lbs. per gal.)	
Light iron drums	per gal. \$2.20 \$2.34
5-gallon cans	per gal. 2.40 2.46
1-gallon cans	each 2.52 2.58
Quart cans	each 71 72
Pint cans	each 38 39
½-pint cans	each 24 24
Turpentine	Pure Gum
(Base 7.2 lbs. per gal.)	Spirits
Light drums	per gal. \$1.65
5-gallon cans	per gal. 1.76
1-gallon cans	each 1.88
Quart cans	each 54
Pint cans	each 31
½-pint cans	each 20

## Pioneer White Lead in Oil-Paste and All-Purpose (Soft-Hasty)

Net Weight	100 lbs.	50 lbs.	25 lbs.
Packages	100-lb. kegs	50-lb. kegs	25-lb. kegs
List Price	\$28.35	\$30.05	\$30.35
Price to Painters	\$27.50	\$28.45	\$28.45
Pr. per 100 lbs.	\$27.50	\$28.45	\$28.45
Pr. per 50 lbs.	\$27.50	\$28.45	\$28.45
Pr. per 25 lbs.	\$27.50	\$28.45	\$28.45
5-lb. cans*	33.35	1.34	31.25
1-lb. cans*	36.00	.36	33.75
500 lbs. (one delivery)	¾¢ per pound less than above.		

## Pioneer Dry White Lead—Litharge—Dry Red Lead

Price to Painters—Price Per 100 Pounds	100 lbs.	50 lbs.	25 lbs.
Dry White Lead	\$26.30	\$26.30	\$26.30
Litharge	25.95	26.60	26.90
Dry Red Lead	27.20	27.85	28.15
Red Lead in Oil	30.65	31.30	31.60
Found cans, \$37 per lb.			

## PATENT CHIMNEYS—

6-inch	\$2.50 lineal foot
8-inch	3.00 lineal foot
10-inch	4.00 lineal foot
12-inch	5.00 lineal foot

## PLASTER—

Neat wall, per ton delivered in S. F. in paper bags, \$17.60.

## PLASTERING (Interior)—

3 Coats, metal lath and plaster.	Yard \$3.00
Keene cement on metal lath.	3.50
Ceilings with ¾ roll channels metal lath (lathed only)	3.00
Ceilings with ¾ roll channels metal lath plastered	4.50
Single partition ¾ channels and metal lath 1 side (lath only)	3.00
Single partition ¾ channels and metal lath 2 inches thick plastered	8.00
4-inch double partition ¾ channels and metal lath 2 sides (lath only)	5.75
4-inch double partition ¾ channels and metal lath 2 sides plastered	8.75
Thermax single partition; 1" channels; 2¼" overall partition width. Plastered both sides	7.50
Thermax double partition; 1" channels; 4¾" overall partition width. Plastered both sides	11.00
3 Coats over 1" Thermax nailed to one side wood studs or joists	4.50
3 Coats over 1" Thermax suspended to one side wood studs with spring sound isolation clip	5.00

## PLASTERING (Exterior)—

2 coats cement finish, brick or concrete wall	Yard \$2.50
3 coats cement finish, No. 18 gauge wire mesh	3.50
Lime—\$4.00 per bbl. at yard.	
Processed Lime—\$4.15 per bbl. at yard.	
Rock or Grip Lath—¾" —30¢ per sq. yd.	
¾" —29¢ per sq. yd.	
Composition Stucco—\$4.00 sq. yd. (applied).	

## PLUMBING—

From \$200.00 per fixture up, according to grade, quality and runs.

## ROOFING—

"Standard" tar and gravel, 4 ply.	\$13.00 per sq. for 30 sqs. or over.
Less than 30 sqs.	\$16.00 per sq.
Tile \$40.00 to \$50.00 per square.	
No. 1 Redwood Shingles in place.	
4½ in. exposure, per square	\$18.25
5/2 No. 1 Cedar Shingles, 5 in. exposure, per square	14.50
5/8 x 16"—No. 1 Little Giant Cedar Shingles, 5" exposure, per square	18.25
4/2 No. 1-24" Royal Cedar Shingles 7½" exposure, per square	23.00
Roofing with Gravel \$5.50 per sq.	

Asbestos Shingles, \$27 to \$35 per sq. laid.	
½ to ¾ x 25" Resawn Cedar Shakes, 10" Exposure	\$30.00
¾ to 1¼ x 25" Resawn Cedar Shakes, 10" Exposure	\$35.00
1 x 25" Resawn Cedar Shakes, 10" Exposure	\$22.00
Above prices are for shakes in place.	

## SEWER PIPE—

C.I. 6-in. to 24-in. B. & S. Class B and heavier, per top	\$99.50
Vitrified, per foot: L.C.L. F.O.B. Warehouse, San Francisco.	
Standard, 8-in.	\$.66
Standard, 12-in.	1.30
Standard, 24-in.	5.41
Clay Drain Pipe, per 1,000 L.F.	
L.C.L. F.O.B. Warehouse, San Francisco:	
Standard, 6-in, per M.	\$240.00
Standard, 8-in, per M.	400.00

## SHEET METAL—

Windows—Metal, \$2.50 a sq. ft.	
Fire doors (average), including hardware	\$2.80 per sq. ft., size 12'x12'. \$3.75 per sq. ft., size 3'x6'.

## SKYLIGHTS—(not glazed)

Galvanized iron, per sq. ft.	\$1.25
Vented hgt skylights, per sq. ft.	2.25
Aluminum, ptytless, (unglazed), per sq. ft.	1.25
(installed and glazed), per sq. ft.	1.85

## STEEL—STRUCTURAL—

\$290 per ton erected, when out of mill.	
\$350 per ton erected, when out of stock.	

## STEEL REINFORCING—

\$200.00 per ton, in place.	
½-in. Rd. (Less than 1 ton) per 100 lbs.	\$8.90
¾-in. Rd. (Less than 1 ton) per 100 lbs.	7.80
1-in. Rd. (Less than 1 ton) per 100 lbs.	7.50
¾-in. Rd. (Less than 1 ton) per 100 lbs.	7.25
¾-in. & 7/8-in. Rd. (Less than 1 ton) 1 in. & up (Less than 1 ton)	7.15
1 ton to 5 tons, deduct 25c.	7.10

## STORE FRONTS—

Individual estimates recommended. See ESTIMATORS DIRECTORY for Architectural Veneer (3), and Mosaic Tile (35).

## TILE—

Ceramic Tile Floors—Commercial \$1.20 to \$1.60 per sq. ft.	
Cove Base—\$1.40 per lin. ft.	
Quarry Tile Floors, 6x6" with 6" base @ \$1.35 per sq. ft.	
Tile Wainscots & Floors, Residential, 4¼x4¼", @ \$1.65 to \$2.00 per sq. ft.	
Tile Wainscots, Commercial Jobs, 4¼x4¼" Tile, @ \$1.50 to \$1.65 per sq. ft.	
Asphalt Tile Floor ½" x ½" . \$ .18 x .35 sq. ft.	
Light shades slightly higher.	
Cork Tile—\$.70 per sq. ft.	
Mosaic Floors—See dealers.	
Linoleum tile, per sq. ft.	\$5
Rubber tile, per sq. ft.	\$.55 to \$.75

Furring Tile	F.O.B. S. F.
Scored	\$.17
12 x 12, each	
Kraflite—Per square foot	Small Large
Patio Tile—Niles Red	Lots Lots
12 x 12 x 7/8 inch, plain	\$ .40 \$ .36
6 x 12 x 7/8 inch, plain	.44 .39
6 x 6 x 7/8 inch, plain	.46 .42

Building Tile—	
8x5½x12-inches, per M	\$139.50
6x5½x12-inches, per M	105.00
4x5½x12-inches, per M	84.00

Hollow Tile—	
12x12x2-inches, per M	\$146.75
12x12x3-inches, per M	156.85
12x12x4-inches, per M	177.10
12x12x6-inches, per M	235.30
F.O.B. Plant	

## VENETIAN BLINDS—

75c per square foot end up. Installation extra.

## WINDOWS—STEEL—INDUSTRIAL—

Cost depends on design and quality required.



# ARCHITECT AND ENGINEER ESTIMATOR'S DIRECTORY

## Building and Construction Materials

**EXPLANATION**—Building and construction materials are shown in major classified groups for general identification purposes with names and addresses of suppliers of materials listed in detail under group classification where name first appears—main offices are shown first with branch or district offices following. The numeral appearing in listings \*(3) refers to the major group classification where complete data on the dealer, or representative, may be found.

<b>ADHESIVES (11)</b> Wall and Floor Tile Adhesives <b>THE CAMBRIDGE TILE MFG. CO. * (135)</b>	<b>KRAFTILE * (135)</b> <b>REMILLARD-DANDINI CO.</b> San Francisco 4: 400 Montgomery St., EX 2-4988	<b>FLOORS (15)</b> Hardwood Flooring <b>HOGAN LUMBER COMPANY</b> Oakland: Second and Alice Sts., GL 1-6861
<b>AIR CONDITIONING (2)</b> Air Conditioning & Cooling <b>UTILITY APPLIANCE CORP.</b> Los Angeles 58: 4851 S. Alameda St. San Francisco: 1355 Market St., UN 1-4908	<b>BRONZE PRODUCTS (8)</b> <b>GREENBERG'S, M. &amp; SONS * (16)</b>	Floor Tile <b>GLADDING, McBEAN &amp; CO. * (3)</b> <b>KRAFTILE * (35)</b> Floor Tile (Ceramic Mosaic) <b>THE CAMBRIDGE TILE MFG. CO. * (135)</b>
<b>ARCHITECTURAL PORCELAIN ENAMEL (2a)</b> <b>CALIFORNIA METAL ENAMELING CO.</b> Los Angeles: 6904 E. Slauson, UN 01268 San Francisco: O'Keefe's, 55-111th St., UN 3-4445 Portland: Beaver Sheet Metal & Roofing Co., 924 N. Russell St., TR 6766 Seattle: Teclar Aluminum Co., 625 Yale Ave N., SE 8494 Salt Lake City: S. A. Roberts & Co., 109 W. 2nd South, Salt Lake 4-4431 Phoenix: Baker-Thomas Co., 300 S. 12th, Phoenix 4-5503 Tucson: Laing-Garrett Co., 19 S. Tyndall Ave., TU 2-2893 Albuquerque: Welch-Irwin Corp., 1726 Lomas Blvd. NE.	<b>BUILDING PAPERS &amp; FELTS (9)</b> <b>ANGIER PACIFIC CORP.</b> San Francisco 5: 55 New Montgomery St., DO 2-4416 Los Angeles: 7424 Sunset Blvd. <b>PACIFIC COAST AGGREGATES, INC. * (11)</b> <b>SISALKRAFT COMPANY</b> San Francisco 5: 55 New Montgomery St., EX 2-3066 Chicago, Ill.: 205 West Wacker Drive	Floor Treatment & Maintenance <b>HILLYARD SALES CO. (Western)</b> San Francisco: 470 Alabama St., MA 1-7766 Los Angeles: 923 E. 3rd, TR 8282 Seattle: 3440 E. Marginal Way Diversified (Magnesite, Asphalt Tile, Composition, Etc.) <b>LE ROY OLSON CO.</b> San Francisco 10: 3070 - 17th St., HE 1-0188 Sleepers (composition) <b>LE ROY OLSON CO.</b>
<b>ARCHITECTURAL VENEER (3)</b> Ceramic Veneer	<b>BUILDING HARDWARE (9a)</b> <b>THE STANLEY WORKS</b> San Francisco: Monadnock Bldg., YU 6-5914 New Britain, Conn.	<b>GLASS (16)</b> <b>W. P. FULLER COMPANY</b> San Francisco: 301 Mission St., EX 2-7151 Los Angeles, Calif. Portland, Ore.
<b>GLADDING, McBEAN &amp; CO.</b> San Francisco: Harrison at 9th St., UN 1-7400 Los Angeles: 2901 Los Feliz Blvd., OL 2121 Portland: 110 S.E. Main St., EA 6179 Seattle: 1500 First Ave. S., EL 4711 Spokane: 1102 N. Monroe St., BR 3259 <b>THE CAMBRIDGE TILE MFG. CO. * (135)</b> Porcelain Veneer <b>PORCELAIN ENAMEL PUBLICITY BUREAU</b> Oakland 12: Room 601 Franklin Building Pasadena B: P. O. Box 186. East Pasadena Station Granite Veneer <b>VERMONT MARBLE COMPANY</b> San Francisco 5: 525 Market St., SU 1-6747 Los Angeles: 3522 Council St., DU 2-7834 Marble Veneer <b>VERMONT MARBLE COMPANY</b> San Francisco 5: 525 Market St., SU 1-6747 Los Angeles: 3522 Council St., DU 2-7834	<b>CABINETS &amp; FIXTURES (9b)</b> <b>FINK &amp; SCHINDLER, THE CO.</b> San Francisco: 522 Brannan St., EX 2-1513	<b>GRANITE (16a)</b> <b>PACIFIC CUT STONE &amp; GRANITE CO.</b> 414 South Marengo Ave., Alhambra, Calif.
<b>BANKS - FINANCING (4)</b> <b>CROCKER FIRST NATIONAL BANK OF S. F.</b> San Francisco, Post & Montgomery Sts., EX 2-7700	<b>CEMENT (10)</b> <b>IDEAL CEMENT COMPANY (Pacific Division)</b> San Francisco 4: 310 Sansome St., GA 1-1100 <b>PACIFIC COAST AGGREGATES, INC. * (11)</b>	<b>HEATING (17)</b> <b>S. T. JOHNSON CO.</b> Oakland B: 940 Arlington Ave., DL 2-6000 San Francisco: 585 Potrero Ave., MA 1-2757 Philadelphia B. Pa.: 401 N. Broad St. <b>SCOTT COMPANY</b> San Francisco: 243 Minna St., YU 2-0400 Oakland: 113 - 10th St., GL 1-1937 San Jose, Calif. Los Angeles, Calif. <b>UTILITY APPLIANCE CORP. * (2)</b> Electric Heaters <b>WEST ELECTRIC HEATER CO.</b> San Francisco 5: 390 First St., GA 1-2211 Los Angeles: 520 W. 7th St., MI 8096 Portland: Terminal Sales Bldg., BE 2050 Seattle: Securities Bldg., SE 8028 Designer of Heating <b>THOMAS B. HUNTER</b> San Francisco 4: 41 Sutter St., GA 1-1164
<b>BATHROOM FIXTURES (5)</b> Metal <b>THE CAMBRIDGE TILE MFG. CO. * (135)</b> Ceramic <b>THE CAMBRIDGE TILE MFG. CO. * (135)</b>	<b>CONCRETE AGGREGATES (11)</b> Ready Mixed Concrete <b>PACIFIC COAST AGGREGATES, INC.</b> San Francisco: 400 Alabama St., KL 2-1616 Sacramento: 16th and A Sts., GI 3-6586 San Jose: 790 Stockton Ave., CY 2-5620 Oakland: 2400 Peralta St., GL 1-0177 Stockton: 820 So. California St., ST 8-8643 Lightweight Aggregates <b>AMERICAN PERLITE CORP.</b> Richmond: 26th & B. St. - Yd. 2, RI 4307	<b>INSULATION AND WALL BOARD (18)</b> <b>LUMBER MANUFACTURING CO.</b> San Francisco: 225 Industrial Ave., JU 7-1760 <b>PACIFIC COAST AGGREGATES, INC. * (11)</b> <b>SISALKRAFT COMPANY * (9)</b> <b>WESTERN ASBESTOS COMPANY</b> San Francisco: 675 Townsend St., KL 2-3868 Oakland: 251 Fifth Avenue, GL 1-2345 Stockton: 733 S. Van Buren, ST 4-9421 Sacramento 1331 - T St., HU 1-0125 Fresno: 434 - P St., FR 2-1600
<b>BRASS PRODUCTS (6)</b> <b>GREENBERG'S, M. &amp; SONS</b> San Francisco 7: 765 Folsom, EX 2-3143 Los Angeles 23: 1258 S. Boyle, AN 3-7108 Seattle 4: 1016 First Ave. So., MA 5140 Phoenix: 3009 N. 19th Ave., Apt. 92, PH 2-7663 Portland 4: 510 Builders Exch. Bldg., AT 6443	<b>DOORS (12)</b> Hollywood Doors <b>WEST COAST SCREEN CO.</b> Los Angeles: 1127 E. 63rd St., AD 1-1108 <b>W. P. FULLER CO.</b> Seattle, Tacoma, Portland <b>NICOLAI DOOR SALES CO.</b> San Francisco: 3045 19th St. <b>F. M. COBB CO.</b> Los Angeles & San Diego <b>SOUTHWESTERN SASH &amp; DOOR</b> Phoenix, Tucson, Arizona El Paso, Texas <b>HOUSTON SASH &amp; DOOR</b> Houston, Texas Screen Doors <b>WEST COAST SCREEN DOOR CO.</b> (See above)	<b>IRON—Ornamental (10)</b> <b>MICHEL &amp; PFEFFER IRON WORKS, INC. * (13)</b>
<b>BRICKWORK (7)</b> Face Brick <b>GLADDING, McBEAN &amp; CO. * (13)</b>	<b>FIRE ESCAPES (13)</b> <b>MICHEL &amp; PFEFFER IRON WORKS, INC.</b> South Linden & Tanforan Ave. South San Francisco: JU 4-8362	<b>LANDSCAPING (20)</b> Landscape Contractors <b>HENRY C. SOTO CORP.</b> Los Angeles: 13,000 S. Avalon Blvd., ME 4-6617
	<b>FIREPLACES (14)</b> Heat Circulating <b>SUPERIOR FIREPLACE CO.</b> Los Angeles: 1708 E. 15th St., PR 8393 Baltimore, Md.: 601 No. Point Rd.	<b>LIGHTING FIXTURES (21)</b> <b>SMOOT-HOLMAN COMPANY</b> Inglewood, Calif., OR 8-1217 San Francisco: 55 Mississippi St., MA 1-8474

**LUMBER (22)**  
Shingles  
LUMBER MANUFACTURING CO. \*(18)

**MARBLE (23)**  
VERMONT MARBLE COMPANY  
San Francisco 5: 525 Market St., SU 1-6747  
Los Angeles 4: 3522 Council St., DU 2-7834

**METAL LATH EXPANDED (24)**  
PACIFIC COAST AGGREGATES, INC. \*(11)

**MILLWORK (25)**  
FINK & SCHINDLER, THE; CO. \*(96)  
LUMBER MANUFACTURING COMPANY \*(18)  
MULLEN MANUFACTURING COMPANY  
San Francisco: 60-80 Rausch St., UN 1-5815  
PACIFIC MANUFACTURING COMPANY  
San Francisco: 16 Beale St., GA 1-7755  
Santa Clara: 2610 The Alameda, SA 607  
Los Angeles, 6820 McKinley Ave., TH 4196

**PAINTING (26)**  
Paint  
W. P. FULLER COMPANY \*(16)

**PLASTER (27)**  
Interiors - Metal Lath & Trim  
PACIFIC COAST AGGREGATES, INC. \*(11)  
Exteriors  
PACIFIC PORTLAND CEMENT COMPANY \*(28)

**PLASTIC CEMENT (28)**  
TOTAL CEMENT COMPANY  
San Francisco: 310 Sansome St., GA 1-4100

**PLUMBING (29)**  
THE HALSEY TAYLOR COMPANY  
Redlands, Calif.  
Warren, Ohio  
THE SCOTT COMPANY \*(17)  
HAWES DRINKING FAUCET COMPANY  
Berkeley 10: 1435 Fourth St., LA 5-3341  
CONTINENTAL WATER HEATER COMPANY  
Los Angeles 31: 1801 Pasadena Ave., CA 6178  
SIMONDS MACHINERY COMPANY  
San Francisco: 816 Folsom St., DO 2-6794  
Los Angeles: 455 East 4th St., MU 8322  
SECURITY VALVE COMPANY  
Los Angeles 31: 410 San Fernando Rd., CA 6191

**RANGE-REFRIGERATOR (29a)**  
Combinations  
GENERAL AIR CONDITIONING CORP.  
Los Angeles 23: 4542 E. Dunham St.  
San Francisco: 1355 Market St., KL 2-2311, Ext. 104

**RESILIENT TILE (30)**  
LE ROY OLSON CO. \*(15)

**SEWER PIPE (32)**  
GLADDING, McBEAN & CO. \*(31)

**SHEET METAL (32)**  
Windows  
DETROIT STEEL PRODUCTS COMPANY  
Oakland 8: 1310 - 63rd St., OL 2-8826  
San Francisco: Russ Building, DO 2-0890  
MICHEL & PFEFFER IRON WORKS, INC. \*(13)  
PACIFIC COAST AGGREGATES, INC. \*(11)

Fire Doors  
DETROIT STEEL PRODUCTS COMPANY  
Skylights  
DETROIT STEEL PRODUCTS COMPANY

**STEEL—STRUCTURAL (33)**  
COLUMBIA-GENEVA DIVISION, U. S. STEEL CORP.  
San Francisco: Russ Bldg., SU 1-2500  
Los Angeles: 2087 E. Slauson, LA 1171  
Portland: 2345 N. W. Nicolai, BE 7261  
Seattle 1331 3rd Ave. Bldg., MA 1972  
Salt Lake City: Walker Bank Bldg., SL 3-6733  
HERRICK IRON WORKS  
Oakland: 18th & Campbell Sts., GL 1-1767  
JUDSON PACIFIC-MURPHY CORP.  
Emeryville: 4300 Eastshore Highway, OL 3-1717  
REPUBLIC STEEL CORP.  
San Francisco: 116 N. Montgomery St., GA 1-0977  
Los Angeles: Edison Building  
Seattle: White-Henry-Stuart Building  
Salt Lake City: Walker Bank Building  
Denver: Continental Oil Building  
SAN JOSE STEEL COMPANY  
San Jose 195 North Thirtieth St., CO 4184

**STEEL—REINFORCING (34)**  
REPUBLIC STEEL CORP. \*(33)  
HERRICK IRON WORKS \*(33)  
SAN JOSE STEEL CO. \*(33)  
COLUMBIA-GENEVA DIVISION, U. S. STEEL CORP. \*(33)

**CLAY TILE (35)**  
THE CAMBRIDGE TILE MFG. CO.  
San Francisco 10: 470 Alabama St., UN 3-1666  
Los Angeles 19: 1335 S. La Brea, WE 3-7800  
GLADDING, McMEAN & CO. \*(31)  
KRAFTILE  
Niles, Calif.: Niles 3611  
San Francisco 5: 50 Hawthorne St., DO 2-3780  
Los Angeles 13: 406 South Main St., MU 7241

**TIMBER—REINFORCING (36)**  
Trusses

Tacoma, Wash.  
WYERHAEUSER SALES CO.  
St. Paul, Minn.  
Newark, N. J.  
Treated Timber  
J. H. BAXTER CO.  
San Francisco 4: 333 Montgomery St., DO 2-3883  
Los Angeles 13: 601 West Fifth St., MI 6294

**WALL TILE (37)**  
THE CAMBRIDGE TILE MFG. CO. \*(35)  
GLADDING, McBEAN & CO. \*(31)  
KRAFTILE COMPANY \*(35)

**WINDOWS STEEL (38)**  
DETROIT STEEL PRODUCTS CO. \*(32)  
MICHEL & PFEFFER IRON WORKS, INC. \*(13)  
PACIFIC COAST AGGREGATES, INC. \*(11)

**GENERAL CONTRACTORS (39)**  
BARRETT & HILP  
San Francisco: 918 Harrison St., DO 2-0700  
Los Angeles: 234 W. 37th Place, AD 3-8161  
J. BETTANCOURT  
San Bruno: 1015 San Mateo Ave., JU 8-7525  
DINWIDDIE CONSTRUCTION COMPANY  
San Francisco: Crocker Building, YU 6-2718  
CLINTON CONSTRUCTION COMPANY  
San Francisco: 923 Folsom St., SU 1-3440  
MATTOCK CONSTRUCTION COMPANY  
San Francisco: 604 Mission St., GA 1-5516  
E. H. MOORE & SONS  
San Francisco: 693 Mission St., GA 1-8579  
PARKER, STEFFENS & PEARCE  
San Francisco: 135 So. Park, EX 2-6639

**TESTING LABORATORIES**  
**ENGINEERS & CHEMISTS (40)**  
ABBOT A. HANKS, INC.  
San Francisco: 624 Sacramento St., GA 1-1697  
ROBERT W. HUNT COMPANY  
San Francisco: 500 Iowa, MI 7-0224  
Los Angeles: 3050 E. Slauson, JE 9131  
Chicago, New York, Pittsburgh  
PITTSBURGH TESTING LABORATORY  
San Francisco: 651 Howard St., EX 2-1747

## CONSTRUCTION CONTRACTS AWARDED AND MISCELLANEOUS PERSONNEL DATA

**HOTEL ADDN.**, Las Vegas, Nevada, Elwell Hotel Las Vegas, owner. One-story addition to present hotel building, \$100,000. ARCHITECT: Aloysius McDonald, Las Vegas. GENERAL CONTRACTOR: Lembke Const. Co., Las Vegas, Nevada.

**CHURCH BLDG.**, Lynwood, Los Angeles county, Lynwood Methodist Church, Lynwood, owner. Frame and stucco church building, wood and composition roofing, concrete slab floor, forced air heating, plastering, toilets, electrical work, \$150,500. ARCHITECT: Frick & Frick, Pasadena. GENERAL CONTRACTOR: James J. Mullen Co., Los Angeles Beach.

**MANUFACTURING BLDG.**, Rosemead, California, Rosemead Co., Los Angeles, owner.

Concrete block clothing manufacturing building; 10,500 sq. ft., composition roofing, concrete slab floors, metal sash, skylights, forced air heating, toilets, offices, electrical work. ARCHITECT: Broo Freeman, Pasadena. GENERAL CONTRACTOR: Wm. Chilton, Arcadia.

**HOSPITAL ADDN.**, San Francisco, Garden Hospital, San Francisco, owner. Three-story and basement addition to the Garden Hospital, type I, reinforced concrete, steel sash, asphalt tile and linoleum floors, tile baths, \$130,000. ARCHITECT: Warren C. Perry, San Francisco. GENERAL CONTRACTOR: Wm. Horstmyer Co., San Francisco.

**LOW RENT HOUSING**, Paoloma, Los Angeles county City and County of Los An-

geles, owner. 73-Two story, 8-1 story dwellings, 448 units plus management, maintenance bldg.; frame and stucco and concrete block, composition roofing, slab floors, asphalt tile and linoleum floor covering, wood sash, painting, plastering, plumbing, electrical, grading, clearing, demolition, landscaping, \$3,188,000. ARCHITECT: Arthur Gallion and Victor Gruen, Los Angeles. GENERAL CONTRACTOR: Richards Construction Co., Studio City.

**SERVICE BLDG.**, San Leandro, Alameda county, County of Alameda, Oakland, owner. 2-story reinforced concrete, some structural steel, aluminum sash, concrete floors, quarry tile and linoleum floors, metal lath and plaster partitions, \$841,316. ARCHITECT: Edward D. Cerruti, Oakland. GENERAL CONTRACTOR: California Builders Co., Oakland.

**PORTABLE CLASSROOMS**, San Diego, San Diego Unified School District, San Diego, owner. 10-Portable classroom buildings, 1-portable toilet unit, 1-portable school, \$92,000. ARCHITECT: Johnson, Hatch & Wulff,

San Diego. GENERAL CONTRACTOR: I. C. Curry, San Diego.

**GYMNASIUM.** San Mateo county. Borel Elementary School, San Mateo, owner. Frame and stucco construction, \$124,221. ARCHITECT: Falk & Booth, San Francisco.

**INDIAN SCHOOL.** Window Rock, Arizona. Housing and Home Finance Agency, Phoenix, owner. Elementary school-High School and living quarters on the Navajo Indian Reservation near Window Rock, \$879,540. ARCHITECT: Edward L. Varney-Associates, Architects and Engineers, Phoenix. GEN-

ERAL CONTRACTOR: M. M. Sundt Construction Co., Tucson, Arizona.

**CHURCH.** Burbank, Los Angeles county. Village Church of Burbank, Burbank, owner. Concrete block, seating capacity 500; composition roofing, concrete slab floor, laminated wood arches, frame and stucco superstructure, steel sash, balcony, forced air heating, ENGINEER: C. F. Ewald, Burbank.

**MASONIC TEMPLE.** El Monte, Los Angeles county. Masonic Temple Ass'n., El Monte,

owner. 1-Story concrete block; 105x115 ft. area; built-up composition and rock roofing, wood trusses, steel trussom sash, fireproof doors, acoustical ceilings, concrete slab floor, interior plaster and stucco; lodge room seats 450, dining room accommodates 510; wood floor stage and raised platform, folding doors, toilet rooms, kitchen facilities, \$75,000. STRUCTURAL ENGINEER: Justin A. Shjarback, Alhambra.

**APARTMENT.** Beverly Hills, Los Angeles county. Wagner Construction Co., Beverly Hills, owner. 2-Story, 7-family, frame and stucco with wood siding; 42x72 ft., com-

## BUILDING TRADES WAGE (JOB SITES) NORTHERN, CENTRAL AND SOUTHERN CALIFORNIA

ATTENTION: The following are the PREVAILING hourly rates of compensation being paid and in effect by employers by agreement between employees and their union; or as recognized and determined by the U. S. Department of Labor. (June 1, 1953.)

CRAFT	San Francisco	Alameda	Contra Costa	Fresno	Sacramento	San Joaquin	Santa Clara	Solano	Los Angeles	San Bernardino	San Diego	Santa Barbara	Kern
	\$2.585	\$2.585	\$2.585	\$2.585	\$2.585	\$2.585	\$2.585	\$2.585	\$2.25	\$2.25	\$2.25	\$2.25	\$2.25
ASBESTOS WORKERS	2.68	2.68	2.68	2.68	2.68	2.68	2.68	2.68	3.175	3.175	2.75	3.175	3.175
BOILERMAKERS	3.25	3.25	3.25	3.00	3.25	3.00	3.45	3.25	1.94	1.94	1.94	1.94	1.94
BRICKLAYERS	2.45	2.45	2.45	2.00	2.40	2.25	2.45	2.45	2.57	2.57	2.57	2.57	2.65
BRICKLAYERS, HODCARRIERS	2.57	2.57	2.57	2.57	2.57	2.57	2.57	2.57	2.57	2.57	2.57	2.57	2.57
CARPENTERS	2.28	2.28	2.28	2.28	2.28	2.28	2.28	2.28	2.38	2.38	2.38	2.38	2.38
CEMENT FINISHERS	3.00	3.00	3.00	3.00	3.00	2.75	3.00	2.50	3.00	3.00	3.00	3.00	3.00
CONCRETE MIXER—Skip Type (1-1/2)...	2.75	2.70	2.65	2.75	2.915	2.915	2.915	2.915	2.25	2.25	2.25	2.25	2.25
ELECTRICIANS	2.56	2.56	2.56	2.56	2.56	2.56	2.56	2.56	1.9875	1.9875	1.9875	1.9875	1.9875
ELEVATOR CONSTRUCTORS	2.30	2.30	2.30	2.30	2.25	2.30	2.30	2.50	2.26	2.26	2.26	2.26	2.26
ENGINEERS: MATERIAL HOIST	2.70	2.70	2.70	2.70	2.70	2.70	2.70	2.70	2.70	2.70	2.70	2.70	2.70
GLAZIERS	*2.60	2.60	2.60	2.60	2.60	2.60	2.60	2.60	2.61	2.61	2.61	2.61	2.61
IRONWORKERS: ORNAMENTAL REINF. STREET	2.85	2.85	2.85	2.85	2.85	2.85	2.85	2.85	2.70	2.70	2.70	2.70	2.70
LABORERS: BUILDING CONCRETE	1.85	1.85	1.85	1.85	1.85	1.85	1.85	1.85	1.94	1.94	1.94	1.94	1.94
LATHERS	3.25	3.00	3.50	3.00	3.00	3.00	3.4375	3.00	3.125	3.125	3.125	3.125	3.125
MARBLE SETTERS	2.95	2.95	2.95	2.95	2.95	2.95	2.95	2.95	2.875	2.875	2.875	2.875	2.875
MOSAIC & TERRAZZO	2.76	2.76	2.76	2.76	2.76	2.76	2.76	2.76	2.40	2.40	2.40	2.40	2.40
PAINTERS—BRUSH	**2.60	2.60	2.60	2.60	2.60	2.60	2.625	2.625	2.56	2.50	2.53	2.22	2.22
PAINTER—SPRAY				2.91	2.91	2.70			2.68				
PILEDRIVERS—OPERATOR	2.75	2.75	2.75	2.75	2.75	2.75	2.75	2.75	2.74	2.70	2.70	2.70	2.70
PLASTERERS	3.125	3.165	3.125	3.125	3.00	3.00	3.125	3.00	3.125	3.125	3.125	3.125	3.125
PLASTERERS, HODCARRIERS	2.60			2.50	2.50	2.50	2.50	2.50	2.675	2.25	2.30	2.00	2.00
PLUMBERS—STEAM FITTERS	2.90	2.90	2.875	2.75	2.90	2.75	2.75	2.90	2.90	2.90	2.90	2.90	2.90
ROOFERS	2.50	2.50	2.50	2.25	2.50	2.50	2.50	2.50	2.65	2.00	1.90	2.00	2.00
SHEET METAL WORKERS	2.475	2.475	3.3125	2.43	2.75	2.50	2.40	2.415	2.475	2.475	2.175	2.00	2.475
SPRINKLER FITTERS	2.75	2.70	2.70	2.625	2.625	2.455	2.75	2.75	2.25	2.25	2.25	2.25	2.25
STEAMFITTERS	2.75	2.90	2.90	2.75	2.625	2.625	2.75	2.75	2.90	2.90	2.90	2.90	2.90
TRACTOR OPERATOR	2.67	2.67	2.67	2.67	2.67	2.67	2.67	2.67	2.52	2.52	2.52	2.52	2.52
TRUCK DRIVERS—1/2 Ton or less.	1.89	1.89	1.89	1.89	1.89	1.89	1.89	1.89	2.02	2.02	2.02	2.02	2.02
TILESETTERS	2.955	2.955	2.955	2.955	2.955	2.955	2.955	2.955	2.65	2.65	2.65	2.65	2.65

\* 6 Hour Day. \*\* 7 Hour Day. \*\*\* Before C.I.S.C. for 15c increase.

Prepared and compiled by:

CENTRAL CALIFORNIA CHAPTER, ASSOCIATED GENERAL CONTRACTORS OF AMERICA, with the assistance and cooperation of secretaries of General Contractors Associations and Builders Exchanges of Northern California; and the above information for southern California is furnished by the Labor Relations Department of the Southern California Chapter, ASSOCIATED GENERAL CONTRACTORS OF AMERICA.

# CLASSIFIED ADVERTISING

RATE: 20c PER WORD . . . CASH WITH ORDER

MINIMUM \$5.00

**YOUNG MAN SEEKS OPPORTUNITY**—Young man with good background in the construction industry, seeks opportunity with Contractor. Primary consideration chance to advance to executive position in future. College graduate. INQUIRE, Box 521, ARCHITECT & ENGINEER magazine, 68 Post St., San Francisco.

**ARCHITECTURAL SLIDING SLEEL SASH.** One lot only — new, half price. 13 units, assorted sizes, 353 square feet total. 3 at 7 ft. x 5 ft.; 4 at 7 ft. x 4 1/2 ft.; 1 at 6 ft. x 4 1/2 ft.; 2 at 6 ft. x 4 ft.; 1 at 7 ft. x 3 1/2 ft.; 1 at 4 1/2 ft. x 3 ft.; 1 at 3 ft. x 3 ft. Phone Delaware 3-7378, San Francisco.

**COLLECTIONS**—Thoroughly experienced in all phases of the collection business; your interests protected at all times; bonded agents everywhere; no collection no charge; California Material Dealers Service Co., 925 Hearst Bldg., San Francisco. Ernest T. Langley, Manager.

**BUILDERS!** You can make more money; get information you need before it is published elsewhere; Subscribe to the daily ARCHITECTS REPORTS, only \$10.00 per month. Complete information from ARCHITECTS REPORTS, 68 Post Street, San Francisco. Phone DOUGLAS 2-8311.

**PHOTOGRAPHY.** For the best in construction photography, including exterior and interior, aerial, and progress views . . . you will find as many others have that it's the SKELTON STUDIOS, 875 O'Farrell St., San Francisco. Telephone PR0JECT 6-1841.

**ESTIMATING SERVICE for Architects and Engineers**—Quantity Surveys—Complete Estimates. CHARLES C. REID, 1333 W. 41st Place, Los Angeles. EXPERIENCED—ACCURATE—PROMPT—FEES REASONABLE.

**HOME BUYERS**—Now building moderate priced homes in Sacramento and Marysville areas; we are in a position to serve your needs. "Better Built Homes" by Ronne, Ronne & Ronne, Builders, 520 9th Street, Sacramento.



position and gravel roofing, carpeted, asphalt tile and rubber tile floors, interior plaster, insulation, individual gas water heaters, dual gas wall heaters, tile baths and showers, electric bathroom heaters, sliding wardrobe doors, \$29,000. ARCHITECT: Martin Stern, Jr., Beverly Hills.

**OFFICE BLDG.**, Bakersfield, Kern county, Kern County Land Co., Bakersfield, owner. 1-Story "H" shaped Ranch-style, frame construction, tile roof, steel sash, asphalt tile floors, air conditioning, vault doors, 20,000 sq. ft., \$415,000. ARCHITECT: Ernest L. McCoy, Bakersfield. GENERAL CONTRACTOR: O. D. Williams, Bakersfield.

**LIBRARY**, East Campus, Contra Costa county, Contra Costa Junior College District, Martinez, owner. 2-Story reinforced concrete and structural steel, brick veneer,

steel sash, asphalt tile floors, \$288,000. ARCHITECT: Harry Nakahara, Martinez. GENERAL CONTRACTORS: M. A. Little, Jr., San Mateo.

**GRANADA THEATER**, Reno, Nevada, United California Theatres, Inc., San Francisco, owner. Class "A" construction, 1000 seats, brick and metal frame. ARCHITECT: Ferris & Erskine, Reno. GENERAL CONTRACTOR: Nomellini Construction Co., Stockton.

**JUNIOR HIGH SCHOOL**, Napa, Napa county, Napa Union High School District, Napa, owner. Stretcrete and light structural steel frame, poured gypsum roof deck, corridors, metal roof deck, asphalt tile floors; 14 - classrooms, administration, library, science, home making, arts & crafts, cafeteria, gymnasium and shops, \$963,850. ARCHITECT: John L. Reid, San Francisco.

GENERAL CONTRACTOR: Trewhiitt, Shields & Fisher, Fresno.

**SEASIDE HOSPITAL**, Crescent City, Del Norte county, Del Norte County Local Hospital District, Crescent City, owner. 1-Story type 3 construction; reinforced concrete and frame, zincite floors, \$205,593. ARCHITECT: Alvin Fingado & Geo. T. Kern, Oakland. GENERAL CONTRACTOR: D. W. Scott & Osborne & Whellon Const. Co., Crescent City.

**OFFICE UNION OIL**, San Francisco. Union Oil Company, San Francisco, owner. 3-Story and penthouse, structural steel frame, reinforced concrete, porcelain enameled exterior, \$500,000. ARCHITECT: Ralph N. Kerr, Oakland. GENERAL CONTRACTOR: Engineers, Ltd., San Francisco.

**ELKS CLUB**, San Mateo, San Mateo county, Elks Hall Ass'n., San Mateo, owner. 1-Story frame and stucco, concrete slab floors, steel sash, composition roofing, warm air heating, swimming pool, \$236,370. ARCHITECT: E. Jay Miller, San Mateo. GENERAL CONTRACTOR: Morris Daley & Harry Kime and Son, (J-V) Burlingame.

**BANK BLDG.**, Red Bluff, Tehama county, Anglo California National Bank, San Francisco, owner. 1-Story reinforced concrete, terra cotta trim, \$150,000. ARCHITECT: By Bank. GENERAL CONTRACTOR: Stolte, Inc., Oakland.

**COUNTY OFFICES-COURTS**, Richmond, Contra Costa county, Contra Costa County, Martinez, owner. 2-Story and penthouse "H" shaped, structural steel frame, reinforced concrete, brick veneer, porcelain

designed  
with

## SCHOOL CLASSROOM IN MIND!

### HAWS Deck-Type Drinking Fountain



HAWS Series No. 2000



School classrooms may differ widely in their requirements. Realizing this, the new HAWS Deck-Type VANDAL-PROOF Drinking Fountain was designed to accept practically any combination of HAWS Pantry Faucets—or Fill Glass Faucets—and HAWS bubbler-type Drinking Faucets.

● **The HAWS Receptor** is cast iron—beautifully finished in acid resisting white enamel. Stainless steel mounting rim prevents water running onto table or cabinet top and affords a water tight bond between sink and top surface.

**Write today** for brochure illustrating combinations of HAWS fixtures that may be utilized with Receptor. You'll find a combination to fit the school job you have on the board or are now planning!

## FLOORS

FOR EVERY PURSE  
OR PURPOSE

HOSPITALS • COMMERCIAL BUILDINGS • WINERIES • CANNERIES • FOOD PROCESSING • INDUSTRIAL BUILDINGS • WAREHOUSES • RESTAURANTS • SCHOOLS

Territories open for Qualified Representatives

Specifications and information available on request

Free Consultation Service

**LeROY OLSON  
COMPANY**

3070 Seventeenth Street,  
San Francisco, California

**HAWS**

**DRINKING FAUCET CO.**

1441 FOURTH STREET (Since 1909) BERKELEY 10, CALIFORNIA

ARCHITECT AND ENGINEER

enamel exterior, aluminum windows, linoleum and marble floors, movable partitions, 57,000 sq. ft., \$1,407,892. ARCHITECT: Donald L. Hardison, Richmond. GENERAL CONTRACTOR: Stolte, Inc., Oakland.

**FIRE HOUSE.** Reno, Nevada. City of Reno, Reno, owner. BRICK and frame construction, \$49,400. ARCHITECT: Ferris & Erskine, Reno. GENERAL CONTRACTOR: G. Panieri, Reno.

## IN THE NEWS

### ARCHITECT SELECTED

Architect Donald F. Haines, San Francisco, has been selected by the Stockton Medical Center, Inc. of Stockton, to draw plans and specifications for the construction of a new 8-story, and basement, Medical-Dental Building.

The building will be erected on the N.W. corner of Sutter and Fremont in Stockton and will comprise a 1-story structure of 150 x 150 feet and an 8-story tower 60 x 150 ft. Parking facilities are being provided for in basement and portion of roof of 1-story building.

Cost of the project is estimated at \$1,300,000.

### SCHOOL BONDS VOTED

Electors of the Martinez Elementary School District recently approved a School Bond issue of \$532,000 at a special election.

Funds are to be used for the construction of a new Elementary School in Martinez and for the addition of facilities to present school buildings.

John L. Reid, San Francisco, is the architect.

### ARCHITECT SELECTED

The architectural firm of William G. Corlett and Arthur W. Anderson of Oakland, have been commissioned by the Board of Regents of the University of California to design and compile specifications for the construction of an Electronics Research Laboratory Building to be built in the Radiation Hill area of the University campus at Berkeley.

### SECHLER APPOINTED LOS ANGELES MANAGER

R. Eldon Sechler has been appointed manager of the Los Angeles District of Detroit Steel Products Company, according to an announcement by E. C. Hodges, vice-president in charge of sales.

The Los Angeles district includes all of Southern California and the Phoenix area in Arizona.

### FEDERAL AID ROADS ASSIST ARIZONA

The Bureau of Public Roads in Washington, D.C., reports a \$6,367,000 federal-aid highways construction program is underway in the State of Arizona which involves some 89 miles. The federal government is providing \$4,529,000 with the balance coming from the state.

### SALT LAKE FIRM GETS ARIZONA CONTRACT

The Oakland Construction Co. of Salt Lake City, Utah, submitted the low bid of \$433,000 to the Veterans Administration,

Washington, D. C. for the construction of a boiler plant and incinerator building at the Ft. Whipple Hospital in Prescott.

### BENEFIEL NAMED GE DISTRICT SALES REP.

Richard J. Benefiel has been named District Sales Representative for the Carboloy department of the General Electric Company.

Benefiel, with headquarters in Oakland, will cover Northern California, Oregon and Washington.

### ARCHITECT SELECTED

Paul C. Shattuck of Merced has been commissioned by the Board of Supervisors of Merced County to design a new School Library and Audio-Visual Building for Merced schools.

### LEROY COLEMAN JOINS KINSEY

Leroy Coleman, prominent in the field of architectural design in Southern California, has become associated with Kersey Kinsey, builder, according to a recent announcement.

Coleman will serve in a managerial capacity and will supervise cost and construction control.

### WAREHAM PROMOTED: MOVES TO OAKLAND

T. R. Wareham, Regional Sales Manager of the Pacific Coast Division of Detroit Steel Products Company, who has been serving also as Los Angeles Division manager, has moved his offices to company headquarters in Oakland, Cali-

fornia, in order that he may better serve the company's clients throughout the western states.

### WESTINGHOUSE ELEVATOR NAMES WAGNER ENGINEER

Robert H. Wagner, engineering graduate of the University of Washington, has been appointed general application engineer manager of the Westinghouse Elevator Division in Jersey City, N. J.

Wagner served the company as Pacific Coast district manager prior to assuming his new duties.

### HARE RESIGNS AS ARIZONA FHA HEAD

Richard S. Hare, director of the Arizona district Federal Housing Administration, Phoenix, has resigned to enter private business.

He joined FHA in 1934 and has been director of the Arizona offices since 1946.

### ARCHITECT SELECTED

Donald S. Mackey of Oakland, has been commissioned by the Board of Regents of the University of California to draft plans and specifications for the construction of the Nematode Research Greenhouse and Head House Building to be built on the University of California campus at Davis, California.

### ALASKA CONSTRUCTION CONTRACTS ANNOUNCED

The Alaska District Corps of Engineers recently announced the awarding of a contract to S. Macri & Sons Co. of Anchorage, \$2,642,000, for the construction of road, street and sidewalk paving and construc-

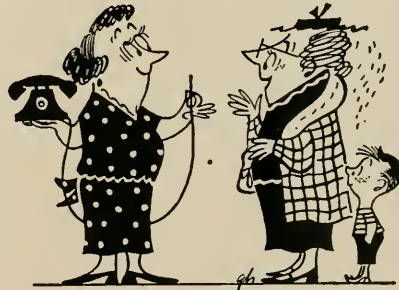

## Why built-in telephone facilities mean happier clients for you

Home owners like to tell their friends about the little "extras" you include in their building plans. That's why planned telephone facilities always appeal. People like the idea of concealed telephone wires and conveniently located telephone outlets to take care of their initial and future telephone installations and changes.

Just call Pacific Telephone's free Architects and Builders service. We'll be glad to help you plan for better living tomorrow in the homes you are building today.

*Put built-in telephone facilities in your plans*



**Pacific Telephone**

tion of storm drainage at the Elmdorff Air Force Base.

A contract for construction of communication facilities and navigational aids at Elmdorff was given Einar M. Peterson of Spenard, \$10,535.

#### PENNEY STORE BUILDING

Architects Ward & Bowles of San Francisco, are designing a new building for the J. C. Penney Company to be built in Sunnyvale's new Plaza Shopping Center, Santa Clara county.

The new building will be 1-story, with basement, reinforced concrete tilt-up construction, structural steel frame and will contain 12,000 sq. ft.

#### LABORATORY OF LIGHTING DESIGN IS ESTABLISHED

A Laboratory of Lighting Design has been established in the School of Architecture and Planning at the Massachusetts Institute of Technology with an initial grant from the F. W. Wakefield Brass Company.

Prof. Lawrence E. Anderson, head of the M.I.T. Department of Architecture says the new laboratory will inaugurate a broad program of study of all factors of en-

vironment which contribute to the process of seeing.

#### SOMETHING NEW—THE SICO "BY" TABLE

Designed to merge benefits of a rolling, folding table with permanence and low cost of rigid seating equipment; for mass seating in schools and industrial plants; seats 16 adults and up to 24 children.



Its mobility, fold-ability and small storage space requirements makes the Sico "BY" Table suitable for daily conversion of open floor area to a cafeteria or meeting room; or for permanent seating.

Light in weight, it is strongly construct-

ed of all-welded structural steel, with zinc-lustron plated structural members; chassis mounted on 4" rubber casters; table top 27" from floor is of 3/4" exterior fir plywood; benches vertical grain fir; 30 ft. sq. table top; unfolded 12 ft., width, including benches, 4' 2 3/4". Complete information from Dept. KP, Seating Inc., 6045 Pillsbury Ave., Minneapolis, Minn.

#### YOUTH CENTER BUILDING

Work has started on the construction of a 1-story frame and stucco Youth Center Building in the City of Monterey.

The architectural firm of Butner, Holm & Waterbury of Salinas are drafting plans and specifications.

#### SCHOOL BONDS APPROVED

Voters of the Monrovia City School District, approved a proposal to issue \$500,000 in school bonds to finance the construction of 26 new classrooms, a new cafeteria at the Mayflower School; a new shop building at the Clifton School, and an addition to the Plymouth School library.

#### FIRE STATION ADDITION

The City of Las Vegas, Nevada, is completing plans for the construction of a dormitory addition to the Central Fire Station. The addition will be of concrete block construction, built-up roof, asphalt tile floor, electric heat, refrigerated air conditioning and some ceramic tile.

Floyd E. Brewster of Las Vegas is the Architect.

#### ADDITIONS TO TAFT HOSPITAL

The Taft Westside Hospital District, Kern county, is contemplating making extensive alterations to the Westside Hospital in Taft.

Work includes demolition of a portion of the existing building, rehabilitation for new radio-graphic and laboratory areas.

Ernest L. McCoy of Bakersfield is the Architect. Walker, Kalionzes and Klingerman of Los Angeles are consulting architects.

#### SELF PARKING GARAGE

A self-parking garage is being built in Oakland at 17th and San Pablo Avenue for the Western Department Stores.

A 1-story structure the building will be 226x300 ft., structural steel frame, reinforced concrete floor and roof, and some concrete walls. Provision is also being made for auto parking on the roof.

R. H. Cooley of Oakland is the Structural Engineer. John J. Moore Company of Oakland is the contractor.

#### ELECTED PRESIDENT CANADIAN NICKEL

Ralph D. Parker was elected president of the Canadian Nickel Company, Ltd., Inco subsidiary at the annual election of officers.

He has served as vice-president and general manager of Canadian Operations of The International Nickel Company of Canada, Ltd., since May, 1952.

#### EQUITABLE LIFE BUILDING PLANS

The Equitable Life Assurance Society, San Francisco, has announced plans for the construction of a new 25-story building on the northeast corner of Montgomery and Sutter streets in San Francisco.

The first 15 floors will be topped by a

MECHANICAL

ELECTRICAL

INDUSTRIAL

GEORGE S. ERSKINE & ASSOCIATES

CONSULTING ENGINEERS

1618 EL CAMINO REAL

MENLO PARK, CALIFORNIA

PHONE COLLECT DAVENPORT 3-1396

TWENTY SEVEN YEARS :: FOUNDED 1926

VALUABLE  
NEWS SERVICE

- BUILDING MATERIAL DEALERS
- CONTRACTORS
- SUB-CONTRACTORS
- MANUFACTURERS AND REPRESENTATIVES

**ARCHITECTS REPORTS** gives advance news on construction projects in Northern California, lists: name of projects, location, architect, proposed cost and other pertinent information.

**HANDY** individual slip-reports, issued daily at a total cost of only

\$10 a month

ARCHITECT'S REPORTS

Published Daily

The ARCHITECT and ENGINEER, Inc.

68 Post Street, San Francisco - DO 2-8311



# E. H. MOORE & SONS

GENERAL  
CONTRACTORS



693 MISSION STREET  
SAN FRANCISCO

10 story tower 161x121 ft. Estimated cost of the project is \$10,500,000, according to Society Officials.

W. D. Peugh, San Francisco, has been selected as the architect, with Irwin Clavan of New York City to act as Consulting Architect.

F. W. Kellberg, San Francisco, has been named Structural Engineer, and the firm of Bayha, Weir & Finato, San Francisco, will serve as Electrical Engineers on the project.

## FENESTRA MOVES OFFICES IN SAN FRANCISCO

Announcement was recently made of the change of address of Fenestra in San Francisco to the district office of the Detroit Steel Products Company at 821 Larkin St.

The move was made to provide larger quarters and better customer parking facilities, according to George Quamby, District Manager, who pointed out that the San Francisco office served as the focal point for Fenestra steel products in Northern California, Nevada, and the Hawaiian Islands.

## STATEMENT REQUIRED BY THE ACT OF AUGUST 24, 1912, AS AMENDED BY THE ACTS OF MARCH 3, 1933, AND JULY 2, 1946 (Title 39, United States Code, Section 233) SHOWING THE OWN- ERSHIP, MANAGEMENT, AND CIRCULATION OF

Architect and Engineer, published monthly at San Francisco, Calif., for October 1, 1953.

1. The names and addresses of the publisher, editor, managing editor, and business managers are:

Publisher, The Architect and Engineer, Inc., 68 Post St., San Francisco, Calif.

Editor, Edwin H. Wilder, 68 Post St., San Francisco, Calif.

Managing Editor, None.

Business Editor, L. B. Penhorwood, 68 Post St., San Francisco, Calif.

2. The owner is: (If owned by a corporation, its name and address must be stated and also immediately thereunder the names and addresses of stockholders owning or holding 1 percent or more of total amount of stock. If not owned by a corporation, the names and addresses of the individual owners must be given. If owned by a partnership or other unincorporated firm, its name and address, as well as that of each individual member, must be given.)

The Architect and Engineer, Inc., 68 Post St., San Francisco, Calif.

K. P. Kierulff, 68 Post St., San Francisco, Calif.

E. N. Kierulff, 68 Post St., San Francisco, Calif.

L. B. Penhorwood, 68 Post St., San Francisco, Calif.

F. W. Jones, 1153 McKinley Ave., Oakland, Calif.

V. S. Yallop, 68 Post St., San Francisco, Calif.

E. J. Cardinal, 942 Howard St., San Francisco, Calif.

Sevall Smith, Lafayette, Calif.

3. The known bondholders, mortgagees, and other security holders owning or holding 1 percent or more of total amount of bonds, mortgages, or other securities are: (If there are none, so state.)

None.

4. Paragraphs 2 and 3 include, in cases where the stockholder or security holder appears upon the books of the company as trustee or in any other fiduciary relation, the name of the person or corporation for whom such trustee is acting; also the statements in the two paragraphs show the affiant's full knowledge and belief as to the circumstances and conditions under which stockholders and security holders who do not appear upon the books of the company as trustees, hold stock and securities in a capacity other than that of a bona fide owner.

5. The average number of copies of each issue of this publication sold or distributed, through the mails or otherwise, to paid subscribers during the 12 months preceding the date shown above was: (This information is required from daily, weekly, semiweekly, and triweekly newspapers only.)

L. B. Penhorwood, Business Mgr.

Sworn to and subscribed before me this 29th day of September, 1953.

(SEAL) IRENE CRESPI  
Notary Public in and for the City and County of San Francisco, State of California.

(My commission expires Jan. 3, 1955)

Phone GARfield 1-1164

# Thomas B. Hunter

DESIGNER OF HEATING

AIR CONDITIONING  
VENTILATING AND WIRING  
SYSTEMS, MECHANICAL  
AND ELECTRICAL EQUIP-  
MENT OF BUILDINGS



41 SUTTER STREET  
ROOM 710

San Francisco California

# CLASSIFIED ADVERTISING

Will Bring Results

—USE—

# ARCHITECT and ENGINEER

68 Post St. San Francisco

Subscribe  
Now —

# ARCHITECT and ENGINEER

\$3.00  
Per Year

# MULLEN MFG. COMPANY

BANK, STORE AND OFFICE  
FIXTURES—CABINET WORK  
OF GUARANTEED QUALITY  
CHURCH SEATING

Office and Factory  
40-80 RAUSCH ST., bet. 7th and 8th Sts.  
San Francisco  
Telephone UNderhill 1-5815

# DINWIDDIE CONSTRUCTION COMPANY

# BUILDERS

CROCKER BUILDING  
SAN FRANCISCO



HERRICK  
IRON WORKS  
STRUCTURAL STEEL  
REINFORCING STEEL

18TH AND CAMPBELL STS.  
OAKLAND, CALIF.  
Phone GLencourt 1-1767

Fine  
**ENGRAVINGS**  
**POOR  
RICHARD**  
PHOTO ENGRAVING CO.  
220-224 COMMERCIAL STREET  
SAN FRANCISCO, CALIF.

**MATTOCK  
CONSTRUCTION  
COMPANY**

★  
**BUILDERS**

★  
604 MISSION STREET  
SAN FRANCISCO

**ARCHITECT  
and  
ENGINEER**

Please enter my subscription for  
..... year..... My check in the  
amount of \$..... is attached.  
1 year . . . . \$3.00  
2 years . . . . 5.00

Name.....  
City.....  
State.....

**ABBOT A. HANKS, INC.  
Engineers & Chemists**

INSPECTING — TESTING — CONSULTING  
CONCRETE • STEEL • MATERIALS  
CHEMICAL AND TESTING  
LABORATORIES  
• RESEARCH AND INVESTIGATION •  
TESTS OF STRUCTURAL MATERIALS  
DESIGN OF CONCRETE MIXES  
SHOP AND ERECTION INSPECTION OF  
STRUCTURES AND EQUIPMENT  
INVESTIGATION OF STRUCTURES  
AND MATERIALS  
TESTS AND INVESTIGATION OF  
FOUNDATION SOILS  
FIRE RESISTANCE AND INSULATION  
TESTS

624 Sacramento Street, San Francisco

**PITTSBURGH  
TESTING LABORATORY**

**ENGINEERS AND CHEMISTS**

Testing and Inspection of Concrete,  
Steel and Other Structural Materials

Design of Concrete Mixes

Offices in all principal cities

651 Howard St., San Francisco 5  
EXbrook 2-1747

**Index to Advertisers**

AMERICAN Brass & Copper Co.....	22
ARCHITECTS Reports .....	46
BARRETT Construction Co.....	21
BETTANCOURT, J., Gen. Contractor	35
CALIFORNIA Metal Enameling Co..	31
CLAY Brick & Tile Association.....	4
CLASSIFIED Advertising .....	* 3
CLINTON Construction Company.....	36
DINWIDDIE Construction Company .	47
ERSKINE, Geo. S. & Associates.....	46
FINK & Schindler, The, Co.....	34
FORDERER Cornice Works .....	35
GENERAL CHEF .....	3
GLADDING, McBean & Company.....	*
GOLDBERG Paint Co., Garrell M.....	21
GREENBERG'S, M. Sons.....	5
HAMERSLAG Equipment Co.....	20
HANKS, Abbott A., Inc.....	48
HAAS & Haynie, Contractors.....	36
HAWS Drinking Faucet Co.....	44
HILP & Rhodes.....	21
HERRICK Iron Works.....	47
HOGAN Lumber Co.....	36
HUNT, Robert W. Company.....	48
HUNTER, Thos. B.....	47
IDEAL Cement Co.....	*
JOHNSON, S. T. Co.....	*
JUDSON, Pacific-Murphy Corp.....	36
KRAFTILE Company .....	26
KUCHEL & Sievers Electric Works...	22
LYNCH, A. J., & Co.....	21
MARBLE Institute of America.....	*
MATTOCK Construction Co.....	48
MICHEL & Pfeffer Iron Works, Inc. .... Back Cover	
MOORE, E. H. & Son.....	47
MULLEN Mfg. Co.....	47
OGDEN Commercial Printing.....	20
OLSON, LeRoy Co.....	44
PACIFIC Coast Aggregates.....	27
PACIFIC Cut Stone & Granite Co....	34
PACIFIC Manufacturing Co.....	37
PACIFIC Telephone & Telegraph Co.	45
PARKER, Steffens & Pearce.....	35
PHOENIX Iron Co.....	20
PITTSBURGH Testing Laboratory.....	48
POOR Richard Engraving Co.....	47
PORCELAIN Enamel (Architectural Division) Publicity Bureau.....	32
REMILLARD-Dandini Co.....	48
REPUBLIC Steel Corporation .....	37
SCOTT Company .....	48
SIMONDS Machinery Company .....	37
SMOOT-Holman Company .....	Inside Front Cover
SUMMERBELL Roof Structures .....	33
U. S. BONDS .....	Inside Back Cover
VERMONT Marble Company .....	37
WEST Coast Screen Co.....	38
WORTH, C. A., & Co.....	22

\*Indicates Alternate Months

**FOR ADVANCE  
INFORMATION**

**ON  
BUILDERS  
CONTRACTORS  
ENGINEERS**

Get

**ARCHITECTS  
REPORTS**

68 Post St. Phone  
San Francisco DO 2-8311

**ROBERT W. HUNT CO.**

**ENGINEERS  
INSPECTING TESTING**

**STRUCTURAL MATERIALS  
CONCRETE MIX DESIGN  
CHEMICAL ANALYSIS  
EQUIPMENT**

PRINCIPAL CITIES  
UNITED STATES • EUROPE  
SAN FRANCISCO LOS ANGELES  
PORTLAND SEATTLE

**REMILLARD-DANDINI Co.**

**Brick and  
Masonry Products**

★

400 MONTGOMERY STREET  
SAN FRANCISCO, CALIF.

**Scott Company**

**HEATING • PLUMBING  
REFRIGERATION**

★

San Francisco  
Oakland  
San Jose  
Los Angeles

# ARCHITECT AND ENGINEER

WESTERN CHURCHES



LEADERSHIP IN ARCHITECTURAL DESIGN

DECEMBER

1953



**MATTOCK  
CONSTRUCTION  
COMPANY**

★  
**BUILDERS**

★  
604 MISSION STREET  
SAN FRANCISCO

**ARCHITECT  
and  
ENGINEER**

Please enter my subscription for  
..... year..... My check in the  
amount of \$..... is attached.  
1 year . . . . \$3.00  
2 years . . . . 5.00

Name.....  
City.....  
State.....

**ABBOT A. HANKS, INC.  
Engineers & Chemists**

INSPECTING — TESTING — CONSULTING  
CONCRETE • STEEL • MATERIALS  
CHEMICAL AND TESTING  
LABORATORIES  
• RESEARCH AND INVESTIGATION •  
TESTS OF STRUCTURAL MATERIALS  
DESIGN OF CONCRETE MIXES  
SHOP AND ERECTION INSPECTION OF  
STRUCTURES AND EQUIPMENT  
INVESTIGATION OF STRUCTURES  
AND MATERIALS  
TESTS AND INVESTIGATION OF  
FOUNDATION SOILS  
FIRE RESISTANCE AND INSULATION  
TESTS

624 Sacramento Street, San Francisco

**PITTSBURGH  
TESTING LABORATORY**

**ENGINEERS AND CHEMISTS**

Testing and Inspection of Concrete,  
Steel and Other Structural Materials

Design of Concrete Mixes

Offices in all principal cities

651 Howard St., San Francisco 5  
EXbrook 2-1747

**Index to Advertisers**

AMERICAN Brass & Copper Co.	33
ARCHITECTS Report	46
BARRETT Construction Co.	11
BETTANCOURT Construction Co.	18
CALIFORNIA Metal Erecting	31
CLAY B. & T. Co. Association	7
CLASSIFIED Advertising	93
CLINTON Construction Co.	16
DINWIDDIE Construction Co.	47
ERSKINE Geol. S. & Associates	40
FINK & S. Hinder The Co.	34
FORDERER Concrete Works	12
GENERAL CHEF	3
GLADDING, M. Bean & Company	7
GOLDBERG Paint Co. Game M.	11
GREENBERG'S, M. Son	5
HAMERSLAG Equipment Co.	20
HANKS Abbott A. Inc.	40
HAAS & Haynie Contract	10
HAWS Drinking Fount. Co.	44
HILP & Rhodes	71
HERRICK Iron Works	47
HOGAN Lumber Co.	16
HUNT Robert W. Company	46
HUNTER, Thos. B.	47
IDEAL Cement Co.	11
JOHNSON, S. T. Co.	11
JUDSON, Pacific Murphy Corp.	11
KRAFTILE Company	11
KUCHEL & Sievers Electric W.	11
LYNCH, A. J., & Co.	11
MARBLE Institute of America	11
MATTOCK Construction Co.	11
MICHEL & Pfeffer Iron Work	11
Inc.	6a
MOORE, E. H. & Son	11
MULLEN Mfg. Co.	11
OGDEN Commercial Printing	11
OLSON, LeRoy Co.	11
PACIFIC Coast Aggregates	11
PACIFIC Cut Stone & Granite	11
PACIFIC Manufacturing Co.	11
PACIFIC Telephone & Tel.	11
PARKER, Steffens & Pearl	11
PHOENIX Iron Co.	11
PITTSBURGH Testing Lab.	11
POOR, Richard	11
PORCELAIN (Division)	11
REMILLAR	11
REPUBLIC	11
SCOTT	11
SIMON	11
SMITH	11
SPENCER	11

FOR  
INT.

6  
5

FOR ADVERTISING  
INQUIRIES  
OR  
ORDER  
CONTRACTS  
ENGINEERS  
OR  
ARCHITECTS  
REPLY  
101 Post St.  
San Francisco, Calif.

# ARCHITECTURE AND ENGINEERING

AND  
ENGINEERING

ROBERT W. ...  
ENGINEER  
INSPECTOR  
STRUCTURAL  
CONCRETE  
CHEMICAL  
DIPLOMA  
REGISTERED  
1914-1920  
1921-1922

## DECEMBER

- ARTICLES . . . . .
- FROM THE HIGHWAY  
LAR. Part II (Conclusion) . . . . .  
President, Associated Contractors of New York
- ERIAN CHURCH, Roseville, California  
AIA, Architect; Victor Abrahamson, AIA, Supervisor  
Propper, Contractor.
- THEOLOGICAL SEMINARY,  
Marin County, California  
AIA, Architect.
- MODERN MOOD . . . . .  
RIAULX. Featuring work of a group of western Architects  
CED CONCRETE BEAM . . . . .  
Structural Engineer.
- REPRINT for ARCHITECTS and ENGINEERS  
M, Financial Consultant, H. E. Work & Co.
- MEMBERS . . . . .
- COUNCIL PAGE . . . . .  
ANLEY L. BASTERASH, Western Asbestos Co.  
BLUME, Structural Engineer, San Francisco.  
Pamphlets and Catalogues . . . . .
- GUIDE, Building and Construction Materials . . . . .
- DIRECTORY, Building and Construction Materials . . . . .
- ION CONTRACTS AWARDED and Miscellaneous . . . . .
- TRADES WAGE SCALES, Northern, Central & Southern . . . . .
- ADVERTISING . . . . .
- NEWS . . . . .
- ADVERTISERS . . . . .
- PHOTO ARTICLES & ILLUSTRATIONS, VOL. 192-195, 1953 . . . . .

Published on the 15th of the month  
San Francisco 4; Telephone EXbrook  
Editor and Manager, L. B. Penhorwood;

100 Western Ave., Los Angeles 5,

at the Post Office in San Francisco,  
Subscriptions United States and Pan  
American Countries \$5.00 a year; single copy 50c.  
at this office, Vernon S. Yallop, Manager.

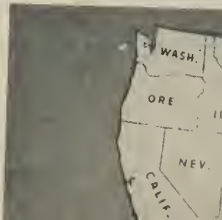



# *Colorful* **CLAY BRICK** *saves taxpayers' money*

In selecting materials for Palo Alto's new City Hall, low cost of maintenance received utmost consideration, along with beauty, adaptability and permanence. Colorful Clay Brick supplied the answer... structural strength plus handsome appearance that will never require protection or embellishment. Thus Clay Brick, easy on the eyes and easy on the pocketbook, scores another achievement — for Architect Nichols, Palo Alto city fathers and the taxpayers.

**CITY HALL**  
*Palo Alto*

**Leslie I. Nichols, A. I. A.**  
*Architect*



*Inside or outside...*  
**A CLAY BRICK WALL**  
*... best finish of all*



## **CLAY BRICK & TILE ASSOCIATION**

*SERVING NORTHERN CALIFORNIA*

Affiliated with Structural Clay Products Institute

**55 NEW MONTGOMERY STREET, SAN FRANCISCO**

*In the interest of better brick and tile construction the following companies have contributed to the publication of this advertisement.*

KRAFTILE COMPANY  
L P McNEAR BRICK COMPANY  
PORT COSTA BRICK WORKS

UNITED MATERIALS & RICHMOND BRICK COMPANY

REMILLARD DANDINI COMPANY  
SAN JOSE BRICK AND TILE, LTD  
STOCKTON BRICK AND TILE COMPANY



# ARCHITECT

Vol. 195

No. 3

# AND ENGINEER

ARCHITECTS' REPORTS—Published Daily

## Contents for

# DECEMBER

EDITORIAL NOTES . . . . .	2
NEWS & COMMENT ON ART . . . . .	4
HOW TO GET THE MOST FROM THE HIGHWAY CONSTRUCTION DOLLAR. Part II (Conclusion) . . . . .	6
By B. B. ARMSTRONG, President, Associated Contractors of New Mexico.	
REMODEL FIRST PRESBYTERIAN CHURCH, Roseville, California . . . . .	8
William Henry Rowe, AIA, Architect; Victor Abrahamson, AIA, Supervising Architect; Frank Propper, Contractor.	
GOLDEN GATE BAPTIST THEOLOGICAL SEMINARY, Site and Development, Marin County, California . . . . .	10
John Carl Warnecke, AIA, Architect.	
CHURCHES IN THE MODERN MOOD . . . . .	12
By ARTHUR W. PRIAULX. Featuring work of a group of western Architects.	
DESIGN OF REINFORCED CONCRETE BEAM . . . . .	24
By W. D. BIGLER, Structural Engineer.	
AN INVESTMENT BLUEPRINT for ARCHITECTS and ENGINEERS . . . . .	25
By FRANK KIHM, Financial Consultant, H. E. Work & Co.	
A.I.A. ACTIVITIES . . . . .	26
WITH THE ENGINEERS . . . . .	28
PRODUCERS COUNCIL PAGE . . . . .	30
Edited by STANLEY L. BASTERASH, Western Asbestos Co.	
PERSONALITIES . . . . .	32
JOHN A. BLUME, Structural Engineer, San Francisco.	
BOOK REVIEWS, Pamphlets and Catalogues . . . . .	36
ESTIMATOR'S GUIDE, Building and Construction Materials . . . . .	39
ESTIMATOR'S DIRECTORY, Building and Construction Materials . . . . .	41
CONSTRUCTION CONTRACTS AWARDED and Miscellaneous Data . . . . .	42
BUILDING TRADES WAGE SCALES, Northern, Central & Southern California . . . . .	43
CLASSIFIED ADVERTISING . . . . .	43
IN THE NEWS . . . . .	45
INDEX TO ADVERTISERS . . . . .	48
INDEX TO TO ARTICLES & ILLUSTRATIONS, VOL. 192-195, 1953 . . . . .	49

EDWIN H. WILDER  
Editor

J. WELLS HASTINGS  
Contributing Editor

PROF. LELAND VAUGHAN  
Landscape Architecture

JOHN A. BLUME  
Structural Engineering

MICHAEL GOODMAN  
Planning

JOHN S. BOLLES, A.I.A.  
Book Reviews



### COVER PICTURE

COMMUNITY  
FIRST CONGREGATIONAL  
CHURCH

Bellevue, Wash.

A dramatic combination of brick, glass and timber made even more cathedral by ingenious use of indirect lighting . . . designed by Robert L. Durham & Associates, Seattle, Wash. For complete story on CHURCHES IN THE MODERN MOOD, see Page 12.

*Photo by  
Kenneth S. Brown*

ERNEST McAVOY  
Advertising Manager

ARCHITECT & ENGINEER  
is indexed regularly by  
ENGINEERING INDEX, INC.

ARCHITECT AND ENGINEER (Established 1905) is published on the 15th of the month by The Architect and Engineer, Inc., 68 Post St., San Francisco 4; Telephone EXbrook 2-7182. President, K. P. Kierulff; Vice-President and Manager, L. B. Penhorwood; Treasurer, E. N. Kierulff.

Los Angeles Office: Wentworth F. Green, 439 So. Western Ave., Los Angeles 5. Telephone DUnkirk 7-8135.

Entered as second class matter, November 2, 1905, at the Post Office in San Francisco, California, under the Act of March 3, 1879. Subscriptions United States and Pan America, \$3.00 a year; \$5.00 two years; foreign countries \$5.00 a year; single copy 50c. ARCHITECTS' REPORTS are published daily from this office, Vernon S. Yallop, Manager. Telephone DOuglas 2-8311.



# . EDITORIAL NOTES .

---

---



For many years it has been our pleasure to extend Sincerest Holiday Greetings to our friends through the pages of ARCHITECT and ENGINEER.

As you gather in your homes to celebrate the Christmas holiday, and prepare for the New Year, we hope this wish will in some small measure add to your pleasure at this time of the year—

May You and Yours enjoy the blessings of a most happy Christmas and happy New Year.

ARCHITECT and ENGINEER



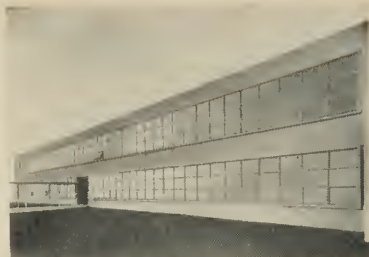

Willow Glen High School, San Jose  
Marsh, Smith & Powell, Architects

## *Steel Windows & Doors*

*Arislide*

ARISTON Steel Windows and Doors are especially designed and constructed to meet the particular requirements of each job.

Michel & Pfeffer engineers are always available to assist architects in their preliminary and final plans.

## *Horizontal Sliding Doors*

- Fully Spring Bronze Weatherstripped
- Roller-bearing Bottom Rollers
- Smooth, Quiet Operation
- Bronze Handles and Foot Bolt
- Stainless Steel Capped Track



WRITE FOR LITERATURE: INQUIRIES INVITED

## **Michel & Pfeffer Iron Works**

N. K. JUVET, Manager Steel Window Division  
So. East Corner of So. Linden and Tenforan Avenues  
South San Francisco • Telephone Juniper 4-8362

Since 1912



# NEWS and COMMENT ON ART

## M. H. deYOUNG MEMORIAL MUSEUM

The M. H. deYoung Memorial Museum, Golden Gate Park, San Francisco, under the direction of Walter Heil, presents a special Holiday Season program of Exhibitions including:

Civic Center Planning, sponsored by the Northern California Chapter of The American Institute of Architects; Dolls—Pageant of the Past, from members' collections of the San Francisco Dolls Club of the United Federation; Gifts Through Five Years, anniversary exhibition of the deYoung Museum Society; Four Artists of the San Francisco Art Association, Show No. 1; Paintings by Max Heimann, retrospective exhibition; Drawings by Francis de Erdely; and Contemporary Indian Arts and Crafts, shown in cooperation with the U.S. Dept. of the Interior.

## SAN FRANCISCO MUSEUM OF ART

The San Francisco Museum of Art, War Memorial Building, Civic Center, is presenting the following schedule of events and exhibitions for the Holidays:

EXHIBITIONS: Landscape Painting; Paintings by Robert McChesney, Nicholas Roukes, Bryan Wilson and Polia Pillin; 28th Annual Exhibition of the San Francisco Women Artists, and the Albert M. Bender Collection. An added feature is the Christmas Gift Selection of Paintings and Sculpture, and Christmas Decorations of table ornaments and trees.

EVENTS will be highlighted by the annual Christmas Party, Lecture Tours, Discussions, Films, Television programs, and Classes in Art for the Layman and Children.

## SPECIAL EXHIBITION OF CIVIC CENTERS

An exhibition of models, photographs, maps and architectural plans illustrating civic center planning in twenty-five cities, both here and abroad, is being shown at the M. H. deYoung Memorial Museum, San Francisco. The exhibition, the first of its kind, is sponsored by the Northern California Chapter of The American Institute of Architects. It offers a comparative study upon which expansion plans for the present San Francisco civic center might be based.

### SAN FRANCISCO

War Memorial Building

### MUSEUM OF ART

Civic Center



View of installation of the cut painted paper designs by Henri Matisse for the stained glass windows in the Chapel of the Rosary at Vence, France. In the foreground, Matisse's crucifix for the altar. (From the exhibition, THE ART OF HENRI MATISSE, shown at the San Francisco Museum of Art, May 23 - July 6, 1952.)

The display contains examples of civic design in India and Columbia; and in England, Germany, and Italy, both before and after the second world war. Some of the European cities illustrated were damaged by the war; others untouched by it. In the United States are illustration of redeveloped civic centers which Philadelphia, Detroit, Brooklyn and other major cities had outgrown. California civic centers included are those of Los Angeles, Sacramento, Richmond and Oakland.

Frank F. Ehrental, chairman of the Area Planning Committee of the A.I.A., pointed out that when the San Francisco civic center was built in 1911 it was recognized both nationally and internationally as a pioneer project. And plans for succeeding civic centers were based upon it. But

since that time advancements have been made in other large cities pointing the way to expansion and adjustments that might be effected locally to meet present day needs.

Mr. Ehrental stressed the need for city planning not only for more efficient movement of people and vehicles and better physical well being but for better mental health.

#### CITY OF PARIS

The Rotunda Gallery of the City of Paris, San Francisco, under the direction of Beatrice Judd Ryan, is offering an Exhibition of Painting and Sculpture by fifty-six artists of the Rotunda Circle entitled "The Cocktail Hour".

Also featured as a part of the holiday season is a group of landscapes and sculpture.

**M. H. deYOUNG**

**MEMORIAL MUSEUM**

**Golden Gate Park, San Francisco**

#### "THE PAINTER ETIENNE JEAURAT"

Is by the French artist Jean  
Baptiste Greuze (1725-1805).

It is an oil painting donated recently  
by Roscoe and Margaret Oakes  
to hang in one of the Galleries  
adjoining the French 18th Century  
Rooms in the re-decorated central  
wing.



# HOW TO GET THE MOST FROM THE HIGHWAY CONSTRUCTION DOLLAR

By **B. B. ARMSTRONG\***, President  
Associated Contractors of New Mexico

## PART II

Shortage of engineers has been a concern of every industry in the country that employs engineers. The highway industry, particularly the state highway department, has been in the worst plight.

Through the efforts of the American Association of State Highway Officials, the American Society for Engineering Education, and the Associated General Contractors, and others, this shortage of the key man has been given serious study and steps taken to secure relief.

It is good to report that major progress has been made.



**B. B. ARMSTRONG**  
Contractor  
Roswell, New Mexico

### COMPETITION FOR ROAD CONSTRUCTION CONTRACTS

You all know of the AGC's position with regard to construction by contract. That the contract method provides the best construction at the most economical figure is undisputable and time proven. It must be added that competition between contractors brings about greater and greater efficiency through the constant improvement in methods of construction, in machinery and equipment. Moreover, through the cooperative work being done by our association nationally and by our chapters locally with their highway departments in improving design, specifications, contract documents, administration procedures and other matters the benefits of the contract system continue to be extended.

*\*NOTE—Address was delivered by Mr. B. B. Armstrong, manager of the firm of Armstrong & Armstrong, General Contractors of Roswell, New Mexico, at the recent 32nd Annual Convention of the Western Association of State Highway Officials held in Santa Fe, New Mexico. Many pertinent factors relative to western highway construction and problems are covered by Mr. Armstrong. ED*

Right here it must be added that competition is extremely keen for highway construction contracts. The Bureau of Public Roads reports that Nationally, the average number of bids on federal projects for 1946 or seven years ago, was 3.9. Last calendar year the average was 5.0 bids and many bids were well below the engineers' estimate.

Competition this year is even keener. Figures of the Bureau of Public Roads place the average for the first six months of 1953 at 6.5 bids per Federal-aid project.

### 99% of Federal-Aid Program Done By Contract

That contract construction is doing the job is evidenced by the fact that during the last seven years, 1946 to 1952 inclusive, 98.9 percent of the Federal-aid highway construction program was executed by contract. Moreover, more and more states are finding that maintenance by contract is the solution to the manpower problem and a means of saving money.

The items discussed so far will bring about large savings in the long-range program. But I suppose you are saying "What can be done to bring about savings in our construction program this year?"

### Methods to Obtain Economy

The AGC is a contractors' organization and not a design engineers group and we shall not attempt to tell you how to prepare detailed designs regarded as the most economical. However, from the standpoint of overall economy, we do strongly recommend:

- a. That in preparing his design the engineer constantly keep in mind the methods to be used for economical construction by the contractor.
- b. That the engineer be responsible for the accuracy of borings and subsurface data shown on plans.
- c. That engineering plans be complete and definitive, yet sufficiently flexi-

(See Page 34)



ROSEVILLE,  
CALIFORNIA



REMODEL  
FIRST PRESBYTERIAN  
CHURCH

**CHURCH**  
Prior To  
Extensive  
Remodeling  
Program



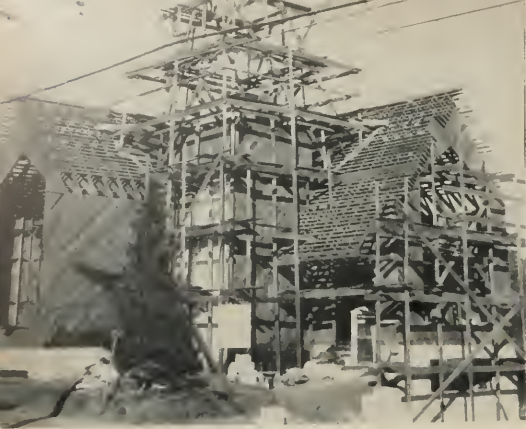

**REMODELING IN PROGRESS**

**THE SITE:** Ideally located on a rise in the center of the city. Although extremely limited in size, it has great value in its accessibility and as a familiar landmark, as well as having a high property value.

**FLOOR PLAN OF BUILDING—BEFORE**



WILLIAM HENRY ROWE, A.I.A.

Architect

VICTOR ABRAHAMSON, A.I.A.

Supervising Architect

FRANK TROPPER

Contractor



**THE PROBLEM:**

To remodel existing church (c. 1911) that was inadequate in facilities and structural strength.

Provide maximum seating in the sanctuary with provisions for overflow.

Improve worshipful atmosphere and general appearance of the building at a minimum cost.

Strengthen entire structure to meet accepted engineering standards.

Modernize plumbing, heating and cooling facilities.

**THE SOLUTION:**

Church school facilities were moved to a recently purchased residence located at the rear of the church. A new education building on the site is planned for future construction.

The Sanctuary was expanded as far as the site allowed, and by utilizing space released by relocating the church school, seating was increased from 175 to 375 plus overflow.

Judicious use of materials and revamping the building's lines and main masses (as far as it was economically feasible) improved the building's atmosphere and appearance.







AERIAL VIEW OF BUILDING SITE ON STRAWBERRY POINT

SITE AND DEVELOPMENT

# GOLDEN GATE BAPTIST THEOLOGICAL SEMINARY

MARIN COUNTY, CALIFORNIA

\$10,000,000.00 PROJECT



JOHN CARL WARNECKE, A.I.A.  
Architect

AT LEFT—John Carl Warnecke, A.I.A. Architect, pointing to Strawberry Point Campus site of the Golden Gate Baptist Theological Seminary.

Dr. Harold K. Graves, President of the Seminary, discusses architectural development of the 125-acre site with Architect Warnecke.

*May all who see the new campus of Golden Gate Baptist Theological Seminary, when completed, be impressed with the greatness of human life and the glory of the divine calling.*

The above statement, from a prominent Baptist clergyman in the deep south, is but one of many inspiring messages brought forth by announcement of plans for a complete new campus of Golden Gate Baptist Theological Seminary on Strawberry Point in Marin County.

This project is one which is naturally of great interest in religious and educational circles on the Pacific Coast. The news was made public on October 2, 1953, that the seminary trustees had authorized purchase of a 125-acre piece of Strawberry Point from Samuel R. Neider for an undisclosed sum, with John Carl Warnecke, A.I.A., of San Francisco and Oakland, as architect for the entire project, which will continue over an estimated ten years and involve some \$10,000,000 investment. Since that time, the purchase has been completed and the new property owners have been granted a use permit by the Marin County Board of Supervisors.

In expressing his appreciation of the prompt action of the Marin planning authorities and the



**CHAPEL . . . Louisville**

supervisors, the seminary's president, Dr. Harold K. Graves, made the following statement:

"We feel that we have found just the right spot for the new campus. It has everything we could wish for. We have now been made to feel that we are welcome to the county and the community of Strawberry Point and we hope to be good citizens and neighbors."

To many people, such an ambitious program, carefully projected and soundly supported by an

(See Page 31)

**Typical  
of the Baptist  
Theological Semi-  
naries is the  
Southern Baptist  
Seminary at  
Louisville, Ky. It  
is the oldest of  
all.**





**FAUNTLEROY CONGREGATIONAL CHURCH—Seattle, Washington. Robert L. Durham & Associates, Architects. Open Chancel gives natural view of trees and wooded area immediately beyond Church.**

# CHURCHES IN THE MODERN WOOD

By **ARTHUR W. PRIAULX**

It is in contemporary church design that the western architect has risen to heights of magnificent imagination, yet retaining the sacred and traditional habiliments and form of the church of the ages.

Whether it is the great Washington Cathedral or a neighborhood church of a poor parish, the architect and designer has met the challenge in designing a sacred house of worship in the spirit of our age of change.

There has been no abandonment of the influence of the hallowed temples of ancient Egypt and Greece, nor a sharp departure from the traditional Roman and Gothic forms which have through the ages been identified as the classic religious styling. Nor have the modern designers lost contact with the influence of simplicity introduced in early American churches.

But, the needs of the modern have changed, and so must the architecture to be functional. From



solely a place of worship, the modern church in every faith has evolved into a more complex structure. Today the church is a community center. It has the sacred rooms for services, the less formal rooms for Sunday school, and all manner of new rooms for social affairs, extra-curricular activities not exactly religious in character, but properly considered today a function of the church. Youth activities have expanded, thus increasing the multi-purpose nature of the new church.

The modern architect is creating a church in the modern mood, patterned, it is true, after ancient and medieval originals, but designed for the changing scope of religious activities.

We are in the midst of a vast church building period, probably unsurpassed in history. More than one billion dollars worth of church construction is presently planned or contemplated. The challenge to the architectural profession to utilize this opportunity to create a contemporary ecclesiastical styling as distinctive as that of ancient, me-

dieval, or early American periods is being met with enthusiasm, daring and original expression which is both exciting and satisfying.

It is apparent that a definite 20th century sacred style is evolving from all this vast activity. Architects find their requirements somewhat similar and pressed always for economy, they gravitate to the sturdy, modified-classical, contemporary house of worship. Churches seldom become obsolete, old age enhancing rather than reducing values. Therefore, age-tested materials, such as stone, cement, glass and wood are used.

Here in the field of new materials lies the op-

---

*PHOTO CREDITS:—Cover, Kenneth S. Brown; Page 12, Kenneth S. Brown; Page 13, Timber Structures, Inc.; Page 14, Summerbell Roof Structures (Top), Timber Structures, Inc.; Page 15, Associated Wood Products; Page 16, Louis S. Gamble; Page 17, Timber Structures, Inc.; Page 18, Summerbell Roof Structures; Page 19, Summerbell Roof Structures (Top), Chaix & Johnson; Page 20, Summerbell Roof Structures; Page 21, Timber Structures, Inc.; Page 22, Timber Structures, Inc.; Page 23, Summerbell Roof Structures (Top), Timber Structures, Inc.*

**SEVENTH DAY ADVENTIST CHURCH—Boulder, Colorado. Jones and Hunter, Architects.  
Sweeping arches provide a nave to accommodate one thousand worshippers.**





**LUTHERAN CHURCH OF THE REDEEMER, Van Nuys, California. John Fleming, Architect. Interesting use of cross members & king bolt reaching to roof apex which serve to ornament the simple arches.**

portunity for the architects to develop distinctive designs. New lighting methods, such as the fluorescent tubes, have opened up tremendous possibilities in lighting. Improved heating systems, while not influencing design particularly, have given the architect opportunity for expansive rooms once considered too barnlike to design. New glass walls and glass bricks as well as new tile and ceramic styles have presented the designers with a fine new arsenal of materials.

In a church structure, when you shape your roof, you have set your design. The roof dominates virtually all ecclesiastical buildings. Certainly, then, the most impressive and dramatic evolution in the entire field of church design is the perfection of a new engineering material which has given wings to architect's imagination. This new engineering material has been known to man since the time of Solomon, but never exploited commercially until the past decade and a half. It is a new engineering material made from the oldest known structural material—glue-laminated wooden trusses and arches.

Unquestionably the advancement made by architects in the design of vastly improved church structures and the development of a wide range of economical styles has been due to the amazing flexibility of these tailor-made wooden members.

With a truss or arch that can be shaped almost at will to meet the demands of a design problem, the architect has been handed tools he never possessed before. Beautiful, long sweeping arches, reaching heavenward from the church floor release almost all limits on the imagination and ingenuity of the designer. The architect can create massive laminated arches several feet in thickness, which will support the tallest church roof, and without posts or obstructions of any kind, cover a room large enough to seat comfortably 1000 people. Or, he can have a truss, arch or beam laminated small and dainty for specific purposes where strength is not important. The de-



**QUEEN OF THE ANGELS CHURCH**

**Port Angeles, Washington**

**John W. Maloney, AIA, Architect**

**Combered beams lend a tone to this beautiful church not ordinarily seen.**

signer can have built of wood arches in almost any shape, size or style, with almost any desired curvature or taper built into the wooden structure.

Wood has been associated with churches in the minds of man down through all the ages. Architects honor this tradition by leaving these massive and beautiful wooden arches exposed whenever possible. New exterior glues are important where beams in belfries and other exposed places must withstand weather and exposure.

Wood serves as well to bind the present with the past, for as new methods, designs and techniques appear, wood comes up in many structural and decorative forms. The combination of structural performance of the glue-laminated arches with graceful lines has increased the popularity of the wooden arch and truss among church designers.

When the trusses were erected for the Fauntleroy Congregational Church, Seattle (see Page 12), they created such a dramatic focal point against the green background of trees that Architects Robert L. Durham and Associates designed a remarkable full glass chancel wall which gives the church an extraordinarily unique expression. The design is extremely simple and pleasing. Trusses were spaced eleven feet apart, making possible the use of 3-inch T&G hemlock planking placed directly on the top member of the truss without use of purlins. The window mullions of the chancel wall are of spruce to give the strength needed in 30-foot lengths. Handsplit cedar shingles cover the roof and the walls have been built up of cedar boards and batts. The basic design of this truss was not dictated by any wish to be stylistic, but merely to give a graceful line which would create the effect of as much height as possible in this church intended to seat 340 persons. Trusses were brought down at pew ends to encourage use of



**HOLY CROSS LUTHERAN CHURCH, Portland, Oregon. James L. Payne, Architect. Narrow Churches can have lofty height when arches are designed with proper camber and delicate taper.**

side aisles, expressing added length to the nave.

Architects Robert L. Durham and John C. Lindahl, and associate architects, had a different problem in designing another Seattle church, the Community First Congregational at Bellevue (see Cover). A slightly larger basic design to seat 370 with 15-foot pews called for wider spacing so parabolic arches were used. The arch was coordinated with a clerestory design in which 2x8 studs were placed 12 inches apart. This gives a very light interior without glass area visible to the worshiper. Below the soffits on each side, angular screened walls were used so that light comes

**KERN PARK  
CHRISTIAN CHURCH**

**Portland, Oregon**

**Danald W. Edmondson,  
Architect.**

**Delicate curves and  
sweeping lines create a  
feeling of height in this  
rather wide nave.**





## CHURCHES . . .

in every four feet, without glass being evident to the person in the pew. Since there is a basement below, the bottoms of the trusses were tied together with laminated beams supporting joist construction.

"We are pleased," Robert L. Durham stated, "that the flexibility of using laminated trusses has allowed us to create two designs in churches of similar size with entirely different atmospheres." The church at Fauntleroy received the 1952 honor award from the Washington state chapter of AIA.

Architect James M. Hunter, AIA, Boulder, Colorado (see Page 13), in designing the Seventh Day Adventist Church of that city, had the problem of creating a structure large enough so the nave would seat 750 people and still keep costs down to a minimum. To get beauty as well as utility, he went to a 61-foot, four inch laminated bent arch for

his structural skelton. The bents are pin-coupled at the ridge and the entire load is carried directly to the foundation where it is tied across with a steel rod. This permitted the designers to effect considerable saving in the masonry work and avoided load-carrying piers. Hunter believes the wooden arches provided a maximum span for a minimum expense and gave added ceiling height over and above what any other truss would have provided.

"We have used laminated wood," Hunter said, "to a considerable extent in the past few years, in an effort to reduce building costs, both in church construction, in schools and public work."

A western contemporary church which has attracted much attention in California is the St. Albert the Great Church in Compton, designed by Chaix and Johnson, architects, AIA, Los Angeles

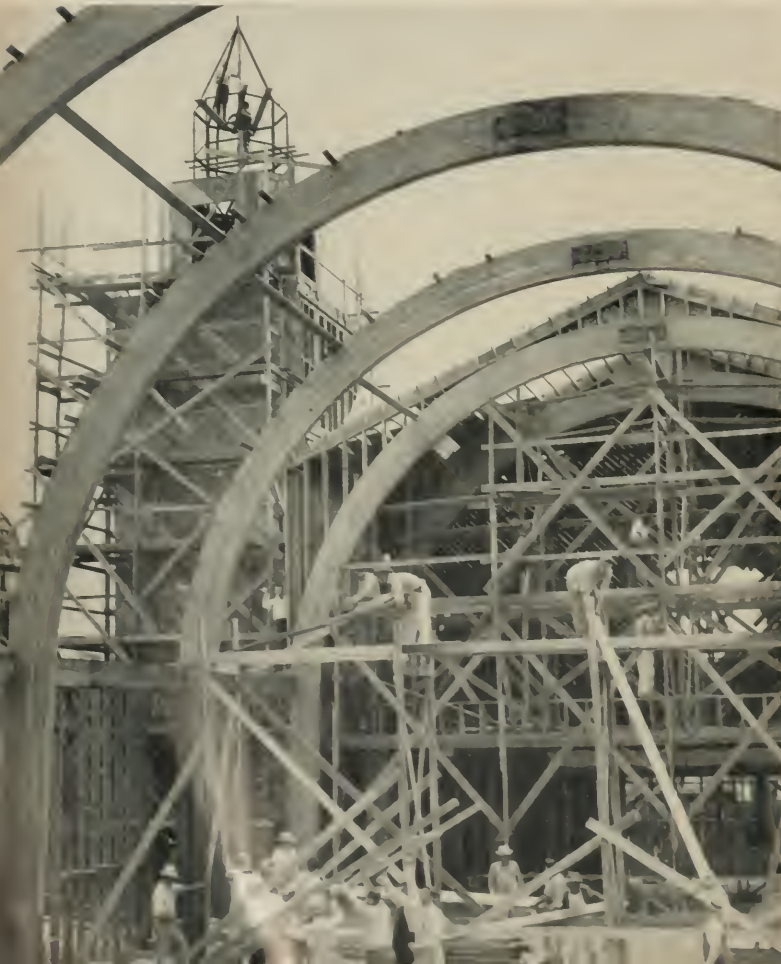

**TRINITY  
BAPTIST  
CHURCH**

**Santa Monica,  
California**

**Louis L. Gamble  
& Associates  
Designer.**

**Construction progress  
view displays the  
economy of construction  
when parabolic arches  
are used.**

(see Page 19). The keynote of this design is simplicity, originality and economy. The curving laminations are restful relief from the straight line severity of the contemporary simplicity of design. A clear view of the altar may be had from the wall which connects by folding doors on one side and nursery chapel on the other. Hall roof is constructed of laminated beams, and the hall and church together seat 600. Lighting is concealed behind laminated wood trusses, so there are no hanging light fixtures to mar the simplicity of the huge nave. "Wood trusses," Chaix and Johnson declare, "are the only method of construction for this type of building which would allow an unobstructed roof interior and still give the warmth and texture that only natural wood can have."

The Lutheran Church of the Redeemer of Van Nuys (Page 14, top), California, may well establish a style for small churches where cost is a controlling factor. The attractive, modern house of worship was designed by Jno. H. Fleming, AIA, Glendale, and has already been copied by three other church groups. The church could be called a growth-church, for it has been so designed by Architect Fleming that additional space can be added to the nave without structural changes by adding additional laminated arches.



Interior View

Architect Fleming used laminated arches to get height in the nave, which money often fails to permit in small churches; also, in designing for horizontal forces, this type of arch is economical in a small high structure. Present plans for this building call for a "U" shaped structure with an educational unit at rear tying the present building to the future larger sanctuary. To get maximum economy, roof decking was left exposed to

**ST. PHILIP NERI CATHOLIC CHURCH, Portland, Oregon. Pietro Belluschi, Architect.**  
 Symbolic form of this remarkable edifice did not interfere with designer's striving for complete utility.



## CHURCHES . . .

form an attractive ceiling which fits well with the exposed beams and purlins. The glue-laminated rib has a very definite appeal, says Architect Fleming, in small church interiors because of its simplicity and honesty.

One of the northwest's best known church designers is John W. Maloney, AIA, Seattle, who has developed one of his usually fine buildings in the Queen of the Angels Church at Port Angeles, Washington (Page 14, bottom). He used six 48-foot cambered and tapered laminated beams on 14-foot eight-inch centers for his roof section. The effect is one of rugged simplicity. This is an example of the flexibility of laminated beams and gives an idea of the added latitude afforded an architect when going to this form of roof support.

Donald W. Edmundson, AIA, Portland, has given his talents to many an outstanding church in the

northwest. A fine craftsman, his houses of worship always are distinctive, like the new Kern Park Christian Church, in Portland (Page 15, bottom). Again Edmundson has drawn from the lovely small parish church of the English rural areas for his motif. The V-type arch with parabolic curve is the ideal shape for roof where timber is to be such a dominant part of the church interior. Exposed purlins and roof sections match the texture of highly polished wood in the arches. There is an intimacy about these parish-type buildings which seem to reach out to the worshiper.

One of the best examples of the cathedral effect of lofty height in a small and narrow church structure has been obtained by Architect James L. Payne, Portland, in his Holy Cross Lutheran Church (Page 15, top), of that city. Tall, boomerang-type arches give an illusion of great loft in this building which carries the general feeling of up-



**LA CRESCENTA  
METHODIST  
CHURCH**

**La Crescenta,  
California.**

**Frick and Frick,  
AIA, Architects.**

**Hinged arches insure  
horizontal stability in  
this dainty but sturdy  
house of worship built in  
earth-quake area.**



ward sweep even into the chancel where a more modified form of arch serves in a narrower area. Decking has been installed vertically, laid against purlins and left exposed to give an atmosphere of reflected warmth from the soft-textured fir arches and decking. Architect Payne has departed from the traditional by installing rows of low windows along both walls at head height when worshipers are seated. A number of contemporary western churches include this feature. In such cases the traditional, stained-glass windows are generally eliminated in favor of the more utilitarian glass areas.

Parabolic arches, which sweep upward away from the walls in graceful curves to snug up underneath the roof which they support, create a structure of unusual architectural beauty in the First Lutheran Church of Alhambra, California,



Some idea of the simplicity of erection problems can be had by a look at this skeleton of laminated arches which provide all the structural elements of the St. Albert the Great Church.

**ST. ALBERT THE GREAT CHURCH, Compton, California. Chaix and Johnson, AIA, Architects. Lighting is subdued in this unique nave and chancel to create a soft and restful atmosphere.**



which Culver Heaton, AIA, Pasadena, has designed (Page 20). Heaton has created a church which has both dignity and great strength. The exposed arches break the square lines and give a flowing unity to the design plan. It is an altogether remarkable building, a tribute to the imagination of the designer.

To get maximum safety in their church structures where earthquakes are a threat, Architects Frick and Frick, AIA, Pasadena, have used hinged arches to give adequate horizontal bracing. These laminated arches have several features that we particularly like, Arthur Frick advises. They combine a clean structural system with the utmost in economy and the results provide space that is particularly appropriate for church use. They offer any number of possibilities for interior design as the slope of the roof structure and width of span is completely flexible. "We have used laminated arches," Arthur Frick pointed out, "which have

the same beauty of clean structure and allow the architect to use the full extent of his imagination." The La Crescenta Methodist Church (Page 18) is typical of the splendid church structures which this brother architectural team has been creating in California.

Much of the beauty of the traditional church has been retained in the lovely Immanuel Christian Reformed Church of Ripon, California (Page 21), designed by Architect G. N. Hilburn, Modesto. He has used a series of five glulam arches forty-three feet long which have been built up with an interesting camber at heel and ridge. An extra thickness has been built into the arches at the ridge to give an effect of greater weight in the roof section. An illusion of increased depth with effective shadows and character has been obtained by creating two different pitches in the lower line of the arches and the line of the roof decking.

San Gabriel's First Methodist Church, designed

**FIRST LUTHERAN CHURCH OF ALHAMBRA, Alhambra, California. Culver Heaton, AIA, Architect. Remarkable effect of a double structure is realized by curving arch members away from side walls.**



by Architects Quintin-Westburg, (Page 23, top), is still another example of the wide range of flexibility of modern structural materials and their impact on modern church design. In this instance, the designers used triangle arches for framing with a super-structure of lighter framing reaching to the ceiling apex. These structural members are held firmly to the arch with iron straps which serve both for structural purposes as well as beauty. The decking has been left exposed in this church, but laid diagonally on the purlins in each section in an interesting pattern.

Church enrollments are growing at a rapid rate, so the architect with an eye to practical problems must consider this factor in designing the basic floor plan as Kurt Schuett, AIA, Portland, did when he created the lovely St. John's Evangelical Lutheran Church of that city (Page 23, bottom). It is another growth-church. The chancel wall is built so that it can be moved as new arch sections are added. Eventually the church will be L-shaped

and the present nave will serve as overflow for future church. Schuett likes the dramatic and colorful effect of the natural wood and has left the two-inch fir decking exposed as well as the purlins and laminated ecclesiastical arches.

No review of church structures on the Pacific Coast would be complete without at least one of Pietro Belluschi's unique architectural conceptions. One of his most distinctive is the remarkably conceived St. Philip Neri Catholic Church in Portland (Page 17). There is much symbolism in the outward facade of this building, a daring sweep to the structural lines which is most attractive. There has been no sacrifice of graceful utility. The lofty roof of the nave and chancel is supported by glue-laminated split beams with purlins engineered to match the great strength of the roof section. There is a vastness about this nave not apparent from the outer expanse of the building. It seems this effect has been gained by getting a maximum, unencumbered clear wall sweep. The

**IMMANUEL CHRISTIAN REFORMED CHURCH, Ripon, California. G. N. Hilburn, Architect. Flexibility of modern lamination techniques is illustrated in these arches built up at heel and peak.**





## CHURCHES . . .

use of slit windows also does not detract from the effect of height. This is Belluschi at his imaginative peak.

Somewhat off the traditional in church architecture is the clean-lined, simple motif of the Sacramento Church of the Brethren (Page 22), a creation of Architect Lloyd Osborne. He used massive boomerang-type laminated arches which join in a parabolic curve, tapering to almost dainty proportions at the V-joint. In turn this curved structure supports a T-shaped lighter wooden structure which extends into the roof apex. The structure and arch are hinged together to give added horizontal stability. To continue the theme of extreme severity, decking has been laid on rafters set on the purlins. The entire upper structure of wood has been left exposed, as has been the case in many of the contemporary western designed ecclesiastical buildings.

In a good many cases architects have specified that these exposed members of wood be left untreated, unstained and unpainted. The desire is to get the delicate effect of well-worn and aged wood

common to houses of worship in older countries. In a few cases, decking and exposed beams have been given a coating of clear varnishes to retain as faithfully as possible the natural color and tone of the wood.

Native western woods afford the architect a fine selection of species with which to design his church structures. A part of the region, with an affinity for the soil, these woods blend well with stone, brick and glass to create structures of rare charm, beauty and durability. One of the finest possible recommendations for native woods, whether in the form of glued arches and beams, or in the form of timbers and lumber, is the matter of economy in costs. Most architects are frank to admit they use native materials because they can save money, and money is always a paramount consideration in limiting church design excesses. They are also just as quick to proclaim the virtues of wood and the great freedom this oldest known structural material gives them in design latitude. Unquestionably, the development of the glulamined arch and beam as an engineering

**CHURCH OF THE BRETHERN, Sacramento, California. Lloyd Osborne, Architect. Massive are these arches which impart a definite strength of character to this overly simple nave.**



material has opened up entire new fields for the architect in church design. He can let his imagination run almost unhampered, he can create structures of exquisite loveliness, he can retain the traditions of the Gothic arch with modern variations and improvements, he can capture the religious spirit in his buildings and yet give worshipers inspiring architecture to earn their continued interest and approval.

Western architects are leading the way nationally in the creation of a contemporary church form. Aided by these new materials, they are doing some of the outstanding designing in the entire nation. Gradually, a western contemporary church form is emerging. It combines the best of the old with the knowledge of needs of today. It clings to church dogma, yet sparkles in new ideas of church function. It provides reverently for religion's traditional ceremonies at the altar and chancel by using modern techniques to glorify the chancel area with newly learned methods of lighting and acoustics. This new form does not affront even the most devout, and certainly it is not so intended. It is intended to bring into this most popular of all public gathering places, the comforts and advantages learned from modern science and invention, and the lessons learned and practiced by architects free to use their skills and arts in a field too long bound by unyielding tradition.



**FIRST METHODIST CHURCH, Son Gabriel, California. Quintin Westberg, Architects. This unique California church is noted for its simplicity of lines.**

**ST. JOHN'S EVANGELICAL LUTHERAN CHURCH, Portland, Oregon. Kurt Schuett, AIA, Architect, Portland. Growth churches which can be expanded readily are the answer to increasing enrollments.**



# DESIGN OF REINFORCED-CONCRETE BEAM LOADED DIAGONALLY

By **W. D. BIGLER, Structural Engineer**

Design of a reinforced-concrete beam flexed by bending moment in two directions can be solved by fixing the direction of the neutral axis on a selected slope. The beam in Fig. 1 is loaded with a vertical bending moment of 32,000 ft lbs and a lateral moment of 16,000 ft lbs. Allowed stresses are 1200 psi in the concrete and 20,000 psi in the steel, and  $n$  equals 10.

The cross section of the beam is drawn with  $d$  equal to 10 units on any convenient scale. The width of the beam from right-hand edge to left-hand bar is proportioned as desired; in this case it is shown as  $.67d$ . The point  $O$  through which the neutral axis passes is on the line connecting the left-hand bar with the upper right-hand corner, at a distance  $kd$  vertically from the top.

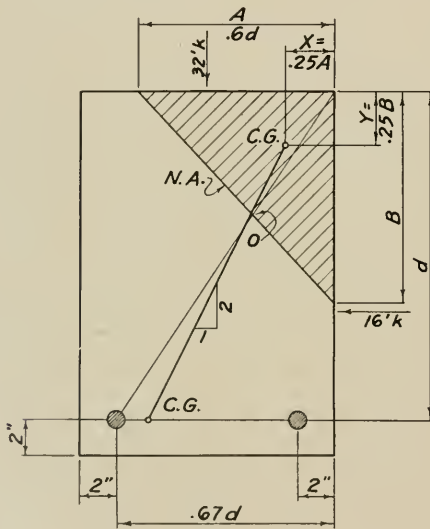

FIG. 1

The length  $A$  of the compressive area is selected so that the lower end of the internal moment arm will, when drawn later, pass approximately through the quarter point of the distance between bars. The selected compressive area may be triangular or trapezoidal. If triangular, distances  $X$  and  $Y$  to the center of gravity of the compressive force are one-fourth of  $A$  and  $B$  respectively. If

the area is trapezoidal, these distances and  $F$ , the internal tensile and compressive force, may be computed in terms of  $d$  by exact methods, or they may be found by the empirical formulas (2), (3), and (4) of Fig. 2, in which  $B'$  is the vertical height of the compressive area on the left-hand side.

$A$  is here selected as  $.60d$ , whence  $B$  scales  $.645d$ . From the c. g. of the compressive force the internal moment arm is drawn parallel to the vector sum of the two externally applied moments to intersect the line of tensile steel; in Fig. 1 it terminates at the scaled distance of  $.569d$  from the right-hand edge.

$$(1) kd = d \frac{f_c}{\frac{f_c}{n} + f_c} = d \frac{1200}{\frac{1200}{10} + 1200} = .375d$$

$$(2) X = .25A \left[ 1 + \left( \frac{B'}{B} \right)^2 \right] \quad \text{FOR TRAPEZOID}$$

$$(3) Y = .25B + \left( \frac{B'}{B} \right)^2 \times .083B \quad \text{"}$$

$$(4) F = \left[ .167 + \left( \frac{B'}{B} \right)^2 \times .333 \right] f_c A B \quad \text{"}$$

$$(5) F = \frac{f_c A B}{6} \quad \text{FOR TRIANGLE}$$

$$(6) F = \frac{32,000 \text{ "}}{d - Y}$$

$$(7) F = \frac{32,000 \text{ "} \times 12}{\left( 1 - \frac{.645}{4} \right) d} = \frac{1200 \text{ "} \times 6d \times .645d}{6}$$

$$d = 18.08 \text{ "} \quad F = 25,400 \text{ "}$$

$$(8) .67 \times 18.08 \text{ "} - 2.00 \text{ "} = 10.10 \text{ "}$$

$$(9) 25,400 \text{ "} \times \frac{.569 \times 18.08 \text{ "} - 2.00 \text{ "}}{10.10 \text{ "}} = 20,800 \text{ "}$$

$$(10) \frac{25,400 \text{ "} - 20,800 \text{ "}}{20,000 \text{ "}} \times \frac{1.075d}{.474d} = .52 \text{ "}$$

FIG. 2

Computations are shown in Fig. 2. By combining formula (4) or (5) with (6),  $d$  and likewise  $F$  can be found. As shown by equation (7)  $F$  is 25,400 lbs and  $d$  is 18.08 in., and the scale of the drawing is established. According to (8) the distance between bars is 10.10 in. Taking moments about the right-hand bar in (9) shows that the force in the left-hand bar is 20,800 lbs, and at 20,000 psi 1.04 sq in. is required. Since the unit tensile stress in each bar is proportional to its distance from the neutral axis, (10) shows that the re-

(See Page 35)





# Gift Subscription For Christmas 1954

**A**S a service to its readers GIFT SUBSCRIPTIONS to ARCHITECT & ENGINEER magazine are available for this year's Christmas giving.

REGULAR SUBSCRIPTION Rate will apply:

United States and Pan America  
\$3.00 a year; two years \$5.00

Foreign Countries \$5.00 a year

PLEASE SEND ARCHITECT & ENGINEER  
AS A GIFT TO:

name..... occupation.....

address..... city..... zone..... state.....

Sign my gift card: From.....

name..... occupation.....

address..... city..... zone..... state.....

Sign my gift card: From.....

name..... occupation.....

address..... city..... zone..... state.....

Sign my gift card: From.....

Your Name.....

address..... city..... zone..... state.....

Enclosed is my check for.....

## AN INVESTMENT BLUEPRINT for ARCHITECTS & ENGINEERS

By FRANK KIHM\*

The professional services of an architect who conceives, plans and supervises the construction of a building, or the engineer who designs a bridge or dam are roughly comparable to those rendered by the economists, security analysis, and statisticians who direct the investment of funds pooled by many shareholders in investment companies. There is an important difference, however: architecture and engineering are most exact sciences, but managing money is an art, based upon knowledge derived from formal education, continuous research, experience, objectivity, and good judgement plus the ability to translate decisions into action.



FRANK J. KIHM  
Consultant H. E. Work & Co.,  
San Francisco

Thus the primary asset of a mutual fund or investment company is its management. The progress or retrogression of an investment company is a direct reflection of the degree of the management's skill. And the results are plainly charted. Under provisions of the Investment Act passed by Congress in 1940, investment companies must furnish stockholders at least twice a year complete data about its operations. Most companies report every three months. Investment holdings are shown, and in many cases portfolio changes—securities added or eliminated—are listed. Net asset value per

share, which represents the company's net resources after deduction of all liabilities divided by the number of shares outstanding, is usually reported on a comparative basis. Investment companies compute net asset value daily and are the basis of "bid" prices of sponsors or issuers which are usually carried by metropolitan papers daily under the caption "Investment Co. Funds". Thus the investor knows at all times what his shares are worth.

Discussion of current economic conditions are sometimes included in reports of investment companies. The president of one of the leading funds had this to say in a letter to shareholders dated October 20, 1953: "The evidence presently at hand does not suggest that the country is facing a substantial business depression. Sustained government expending for defense purposes, prospective cuts in personal and corporate income taxes, the large reservoir of personal savings, continual rapid growth of population and forthcoming application in industry of recent scientific and technological developments, all in your management's judgement, work toward maintaining a high level of national income. Against this background, it is your management's current opinion that carefully selected common stocks today represent excellent values for the purposes of the Fund—all the more so after the declines witnessed in the security markets this year."

There are about 150 investment companies operating at present. Managements vary—some achieved better success than others. None are omniscient or infallible. There is a sales charge to the investor averaging 7½%, covering the purchase, and the fees of these securities. There is also an annual management fee averaging ½ of 1% of the amount invested.

Just as the architect's fee is a most invaluable factor in the cost of a building project, so are the charges, involving expert selection and supervision and widespread diversification of securities an invaluable item in an investment program.

*Editor's Note: This is the third of a series of special articles written for ARCHITECT & ENGINEER magazine by Mr. Frank J. Kihm relating to financial relationships with the construction industry. Another article will appear next month.*



Clair W. Ditchy, President  
 Norman J. Schlossman, 1st Vice-President  
 Howard Eichenbaum, 2nd Vice-President  
 George Bain Cummings, Secretary  
 Maurice J. Sullivan, Treasurer

National Headquarters—  
 1741 New York Avenue, N. W.  
 Washington, D. C.  
 Edmund R. Purves  
 Executive Secretary

#### Arizona Chapter:

Low Place (Tucson), President; Ralph Haver (Phoenix), Vice-President; Fred O. Knips (Tucson), Secretary; James W. Elmore (Phoenix), Treasurer. Secretary Offices, 1324 E. Lester St., Tucson.

#### Coast Valleys Chapter:

Kurt Gross, President; Harold Ahnfeldt, Vice-President; Frank C. Tressler, Secretary; Jerome Kasavan, Treasurer. Directors, Hollis Logue and Gifford Sobey. Offices, 82 S. 3rd St., San Jose.

#### Central Valley of California:

John W. Bomberger, President; Nicholas Tomich, Vice-President; Albert B. Thomas, Secretary; Ted de Wolf, Treas.; Gordon Stafford, Director; Alternate to CCA, Silvio Barovetto; Sec. Office 718 Alhambra Blvd., Sacramento.

#### Colorado Chapter:

James M. Hunter, President, 2049 Broadway, Boulder; Casper F. Hegner, Secretary, 1659 Grant Street, Denver 5.

#### East Bay Chapter:

Malcolm D. Reynolds, President; Donald Hardison, Vice-President; John Lloyd, Secretary; Ed Cerrulli, Treasurer. Directors: Chester Treichel, Ira Beals, Cecil Moyer. Secretary's office: 1171 Solano Ave., Albany.

#### Idaho Chapter:

C. V. Weyland, Boise, President; Cecil E. Jones, Twin Falls, Vice-President; Thomas M. I. Leake, Boise, Sec.; Treas.; Anton Dropping, Boise, Exec. Comm. Member. Office of Secretary, Suite 405 Sun Bldg., Boise.

#### Montana Chapter:

E. Edward Scowcroft, President (Billings); J. Van Teylingen, Vice-President (Great Falls); H. C. Cheever, Secretary-Treasurer. Secretary office, Bozeman.

#### Nevada Chapter:

Russell Mills, President, Reno; Harris P. Sharp, Vice-President, Las Vegas; E. Keith Lockard, Secretary, Reno; Edward S. Parsons, Treasurer, Reno. Directors: L. A. Ferris, David Whay, Reno, and Walter Zick, Las Vegas. Office of President: 309 N. Virginia St., Reno.

#### Nevada State Board of Architects:

Russell Mills, Chairman, Reno; Aloysius MacDonald, Secretary, Las Vegas; Edward Parsons, L. A. Ferris, Reno, and Richard Stadlerman, Los Vegas, Members. Office, 309 S. 5th St., Las Vegas.

#### Northern California Chapter:

Donn Emmons, President; Wendell R. Spackman, Vice-President; William Corlett, Secretary; Bernard J. Sabaroff, Treasurer. Directors: Charles S. Pope, Wm. Stephan Allen and Lawrence A. Kruse, Helen H. Ashton, Office Sec., Office, 26 O'Farrell St., San Francisco.

## WASHINGTON STATE CHAPTER

The December meeting was a review of the Chapter's activities during the past 59½ years, with Senior members being given a place of honor in recognition of their promotion of the architectural profession and community service.

A number of Committee reports were given and

general discussion centered on the program for next year. It was agreed that the year ending had been a "busy" one, but, next year would be even more so.

## SAN DIEGO CHAPTER

"Recent School Buildings In California" was the theme of the December meeting. Through the co-operation of "Pat" Paderewski, a number of colored picture slides of outstanding school buildings in California were shown and accompanied by a running commentary by "Pat".

Nominating committee for election of officers at the January meeting was named.

## NORTHERN CALIFORNIA CHAPTER

Frank Lloyd Wright was honored, the latter part of November, when some six hundred and thirty architects, architectural students and guests turned out to hear Wright censure the architectural profession at a dinner given in his honor.

In his customary, headline capturing manner, Wright declared "I am ashamed of my profession" in his opening statement, and as expected his comment made the daily papers.

Assisting in the event were members of the Women's Architectural League, Mrs. Leffler Miller, president.

National AIA awards of merit were presented to Stephen Allen and Robert Anshen for their Santa Clara house, and to George Rockrise for a Marin County residence, prior to the address by Wright.

## OREGON CHAPTER

Reports of recent AIA meetings featured a re-

Remember it's

**KRAFTILE**

- for ★ GLAZED STRUCTURAL WALL UNITS  
 ★ PATIO TILE  
 ★ FACE AND ROMAN BRICK  
 ★ ACID FLOOR BRICK  
 ★ HEARTH BRICK  
 ★ BRICKETTES  
 ★ MINWAX TILE & CONCRETE FLOOR FINISH

For complete information and prompt service, phone or write

**KRAFTILE COMPANY**

NILES, CALIFORNIA

NILES 3611

LOS ANGELES 12: 406 South Main Street—Mutual 7241

#### Orange County Chapter:

Paul O. Davis (Los Angeles), President; Ralph Modjeski (Santa Ana), Vice-President; Geo. Lind (Newport Beach), Secretary; Wm. L. Faulkner (Santa Ana), Treasurer. Secretary's Office: 2319 Newport Blvd., Newport Beach.

#### Oregon Chapter:

Holman J. Barnes, President; Albert W. Hilgers, Vice-President; Donald W. Edmondson, Secretary; DeWitt C. Robinson, Treasurer, and H. Abbott Lawrence, Trustee. Office of Secretary, 325 Henry Bldg., Portland.

#### Pasadena Chapter:

Robert E. Langdon, Jr., President; Wallace C. Bonsel, Vice-President; Robert L. Deines, Secretary; Henry C. Burge, Treasurer; and Directors John N. Douglas, R. VanBuren Livingston, Scott Quintin and Burton Romberger. Offices: 259 South Los Robles Ave., Pasadena 5.

#### San Diego Chapter:

Donald Campbell, President; Victor L. Wulff, Jr., Vice-President; Richard L. Pinnel, Secretary; Edward G. Holliday, Treasurer; Louis A. Dean, Director. Office Sec., San Diego Trust & Savings Bldg.

#### San Joaquin Chapter:

Maurice J. Meiz (Fresno), President; Allastair Simpson, Vice-President; Al Bailey, Secretary; Robert Stevens, Treasurer. Directors: David H. Horn, Wm. Hyberg, Robert Kaestner. Secretary's Office, Fresno.

#### Santa Barbara Chapter:

Miss Lulah Maria Riggs, President; Roy C. Wilson, Vice-President; Chester L. Carjola, Secretary; Roy W. Cheesman, Treasurer. Corres. Secy.; Richard B. Nelson, 3033 Calle Rosales, Santa Barbara.

#### Southern California Chapter:

Henry L. Wright, President; U. Floyd Ribbe, Vice-President; Cornelius M. Deasy, Secretary; Savo M. Stoshitch; Hugh R. Davies; S. Kenneth Johnson, Kemper Nomland and Chas. E. Fry, Directors.

Headquarters, 3723 Wilshire Blvd., Los Angeles 5.

#### Utah Chapter:

W. J. Monroe, Jr., President, 433 Atlas Bldg., Salt Lake City; M. E. Harris, Jr., Secretary, 703 Newhouse Bldg., Salt Lake City.

#### Washington State Chapter:

John S. Dettle, President; Ralf E. Decker, 1st Vice-President;

Edwin T. Turner, 2nd Vice-President; Wendell H. Lovett, Secretary; Arnold G. Gagnans, Treas. Directors Paul Tracy, William J. Bain, J. Emil Anderson and Robert E. Price. Days Holcomb, Ex-Sec., 409 Central Bldg., Seattle 4.

#### Spokane Chapter:

Tom Adkinson, President; Carroll Martel, Vice-President; Harry Weller, 2nd Vice-President; William James, Secretary; Lawrence Evanoff, Treasurer. Office of the Secretary, W. 524 - 4th Ave., Spokane.

#### Tacoma Society:

E. N. Dugan, President; P. G. Ball, Vice-President; Lyle Svedberg, Secretary-Treasurer.

#### Hawaii Chapter:

Kenji Onodera, President, 3518 McCorkriston St., Honolulu, T. H.; George J. Wimberly, Secretary, 315 Royal Hawaiian Ave., Honolulu, T. H.

#### CALIFORNIA COUNCIL OF ARCHITECTS

Charles E. Fry, President, Los Angeles; Malcolm D. Reynolds, Oakland, Vice-President; Lawrence Gentry, Los Altos, Secretary; Louis A. Dean, San Diego, Treasurer; Fred A. Chase, Executive Secretary, 3723-A Wilshire Blvd., Los Angeles.

#### CALIFORNIA STATE BOARD ARCHITECTURAL EXAMINERS:

George P. Simonds (Oakland), President; Ulysses Floyd Ribbe (Los Angeles), Secretary; Earl T. Heitschmidt (Los Angeles); G. J. Federewski (San Diego); Norman K. Blanchard (San Francisco), Exec. Secy., Robert K. Kelley, Room 712, 145 S. Spring St., Los Angeles; San Francisco Office, Room 300, 507 Polk Street.

#### ALLIED ARCHITECTURAL ORGANIZATIONS

##### San Francisco Architectural Club:

Joseph Scoma, President; Frank S. Gerner, Vice-President; Russell W. Pennell, Treasurer; Frank L. Barsotti, Secretary. Club Quarters: 507 Howard St., San Francisco.

##### Producers' Council—Southern California Chapter:

Bert Taylor, President, Pittsburgh Plate Glass Company; G. Robert Roden, Jr., Vice-President, Truscon Steel Company; Malcolm G. Lowe, Secretary, Natural Gas Equipment Inc.; Richard Seaman, Treasurer, W. P. Fuller & Company; Vern Boget, National Director, Gladding McBean & Co.

Producers' Council—Northern California Chapter (See Special Page)

cent meeting of the Chapter. Waldo Christensen, Regional AIA Director, discussed a Board meeting, and Ralph Decker, vice-president of the Washington State Chapter, reported on a number of cooperative activities of the Washington Chapter dealing with city and community planning.

A conference on School Planning was conducted on the Campus of the University of Oregon, sponsored by the Oregon State Department of Education and the School of Education at the University of Oregon. Representing the architectural profession was Jack Annand.

#### PASADENA CHAPTER

William Manker, well known and distinguished color consultant, was the principle speaker at the December meeting, taking as his subject "Architectural Interiors". Manker maintains offices in Los Angeles and Padua Hills.

#### SOUTHERN CALIFORNIA CHAPTER

The December meeting was a joint meeting with the Long Beach Association of Architects, and was held at the Lakewood Country Club, Long Beach, with the Long Beach Club hosts of the meeting.

Cornelius M. Deasy, Secretary of the Southern California Chapter AIA, was the principal speaker and gave a resume of his recent trip through Western Germany as a member of a U.S. team to study reconstruction procedures and community planning. His talk was accompanied by the showing of colored slides.

#### WASHINGTON'S NEW ARCHITECTS

Stephen M. Dam, Douglas P. Haner, Lois Jane

Hastings, Donn L. Rothe, William Trogdon, and Anne Detwyler Warren, all recently passed the 1953 examination and have been granted licenses to practice Architecture in the State of Washington.



## Here's Why ANTI-HYDRO IS THE BUY

### When You Want Durable Concrete

1. Increases slump of concrete.
2. Permits use of less water in concrete mix.
3. Permits control of hardening time of concrete.
4. Produces early strength concrete with Portland cement.
5. Steps up the strength of concrete.
6. Reduces shrinkage over untreated concrete.
7. Produced 100% watertight concrete in government tests.
8. Protects steel reinforcing from corrosion.
9. Effects a perfect bond between mortars and concrete.
10. Cuts cost of cement finishers' time.
11. Internally cures, hardens, dustproofs concrete floors.
12. Offers field inspection service on jobs to be guaranteed.



Distributed By



CONTACT THE NEAREST P.C.A. SALES OFFICE  
SAN FRANCISCO OAKLAND SAN JOSE  
SACRAMENTO STOCKTON FRESNO



# WITH THE ENGINEERS

## Structural Engineers Association of California

Harold P. King, President, Sherman Oaks; M. A. Ewing, Vice-President, Sacramento; Joseph Sheffet, Sec.-Treas., Hollywood. Directors, Ben Benioff, Ernest D. Francis, John J. Gould, L. W. Graham, G. A. Sedgwick, and W. T. Wheeler. Secretary's Office, 844 Seward St., Hollywood 38.

## Structural Engineers Association of Northern California

George A. Sedgwick, President; Michael V. Pregnoff, Vice-President; John M. Sardis, Secretary; William K. Cloud, Treasurer; Robert P. Moffett, Asst. Sec.-Treas.; Directors, Robert D. Dalton, Robert D. Dewell, William H. Ellison, John J. Gould and J. Albert Paquette. Offices: 417 Market St., San Francisco.

## Structural Engineers Association of Central California

William H. Peterson, President; Walter S. Wassum, Vice-President; O. T. Illerich, Sec.-Treas.; Ernest D. Francis, M. A. Ewing, and Arthur A. Sauer, directors. Office O. T. Illerich, c/a Div. of Arch., Sacramento.

## American Society of Civil Engineers Los Angeles Section

Trent R. Dames, President; Stephenson B. Barnes, Vice-President; John M. Server, Vice-President; C. Martin Duke, Secretary, and John Merrell, Jr., Treasurer. Office of Secretary, 3066 Engineering Building, University of California, Los Angeles 24. BRANCHES: Orange County Branch, Harold Sprenger, Pres; Raymond R. Ribal, V-P; Earl K. Burdick, Sec-Tr, 12311 Chapman, Anaheim. San Bernardino-Riverside Counties Branch, Albert A. Webb, Pres; Wright M. Price, V-P; John L. Merriam,

## TRAINING COURSE FOR SCHOOL CONSTRUCTION INSPECTORS

A course designed to train building inspectors for school construction inspection is being held in Los Angeles under sponsorship of the Structural Engineers Association of Southern California and the Southern California Chapter of The American Institute of Architects.

The California Legislature, shortly after the disastrous 1933 Long Beach earthquake, enacted laws requiring school districts to carry on continuous inspection of all public school buildings under

construction. The purpose of the training program, therefore is to improve and unify field inspection and construction of school buildings.

General subjects to be covered by lectures include: Overall duties and responsibilities of school construction inspectors; structural inspection requirements; mechanical finish inspection requirements; electrical and architectural inspection requirements.

## ON EVERY SCHOOL JOB...

### THE NEW HAWS



HAWS Model No. 2000 Series

### DECK TYPE VANDAL PROOF DRINKING FOUNTAIN

can be installed with practically any combination of HAWS Fixtures...Pantry Faucets...bubbler type Drinking Faucets...Fill Glass Faucets or HAWS Emergency Eye Wash Fountain! The ideal deck type drinking fountain for all school classroom and laboratory requirements. Adaptable for industry, too! Finished in acid resisting white enamel with stainless steel mounting rim.

• WRITE TODAY for brochure showing versatile applications and details!

**HAWS DRINKING FAUCET CO.**  
1437 FOURTH STREET (Since 1909) BERKELEY 10, CALIFORNIA



Assisting in training program are: Henry Layne (left), SEASC; Arthur Henlon, AIA. Architect: Robert Kadou; Harry Bolin, Donald Cuniff and Milton Nigg, all of the SEASC.

Lecturers for the course from the SEAOSC include Harry Bolin, principal structural engineer, and Bernard S. Harder and Milton S. Nigg, district structural engineers, of the Los Angeles office, State Division of Architecture; Donald Cuniff, assistant maintenance and operations manager, Los Angeles Board of Education; John Glaser, director of buildings and grounds, Pasadena City School system; and Robert Cousineau, John Minasian, Lewis Osborn, Henry Layne and Charles Peterson, structural engineers.

Representing the AIA as lecturers will be Henry Wright, president of the Southern California chap-

Sec-Tr; 4865 Park Ave., Riverside. Ventura-Santa Barbara Counties Branch, Robert L. Ryan, Pres; Richard E. Burnett, V-P; George Conahey, Sec-Tr, 649 Doris St., Oxnard.

**American Society of C. E.  
San Francisco Section**

J. G. Wright, President; J. E. Rinne, Vice-President; Howard C. Wood, Vice-President; John S. Longwell, Past President; H. C. Medbery, Secretary, and Richard C. Clark, Treasurer. Office Secretary, S. F. Water Dept., Millbrae.

**Structural Engineers Association of  
Southern California**

Ben Benicoff, President; William T. Wright, Vice-President; Charles M. Corbit, Jr., Sec-Treas. Directors: Ben Benicoff, William T. Wright, Harold P. King, Henry M. Layne, Joseph Sheffet, Robert J. Kadow and Harold Omsted. Offices, 121 S. Alvarado St., Los Angeles 4.

**Structural Engineers Association of  
Oregon**

Lewis R. Ellingwood, President; Robert M. Bonney, Vice-President; Sully A. Ross, Secretary-Treasurer. Directors William J. Dorner, Roger V. Gillam, Leslie E.

Poole, Rowland S. Rosé. Offices 706 Board of Trade Bldg., 310 S.W. 4th Ave., Portland 4.

**Society of American Military  
Puget Sound Engineering Council  
(Washington)**

R. E. Kister, A. I. E. E., Chairman; E. R. McMillan, A. S. C. E., Vice Chairman; L. B. Cooper, A. S. M. E., Secretary; A. E. Nickerson, I. E. S., Treasurer. Offices L. B. Cooper, c/o University of Washington, Seattle 5, Washington.

**American Society Testing Materials  
Northern California District**

L. A. O'Leary, Chairman; P. V. Garin, Vice-chairman; H. P. Hoopes, Sec. Office Sec., 1550 Powell St., Emeryville, Calif.

**Society of American Military  
Engineers—San Francisco Post**

CDR N. M. Martinsen, President; L. L. Wise, 1st Vice-President; Col. Paul Berrigan, 2nd Vice-President; R. M. Hamilton, Secretary; Thomas Hurley, Treasurer. Directors, RADM C. A. Trexel, J. G. Wright, LTCOL C. S. Lindsey, C. E. Bentley, F. R. Fowler, BRIGEN D. F. Johns, and RADM L. N. Moeller.

ter, and Arthur Rendon.

Robert Kadow of the SEAOSC is the class administrator, assisted by George Youngclaus.

The course was suggested by the State Division of Architecture's local office. A committee of the Structural Engineers Association of Southern California, headed by Henry Layne, developed the program in cooperation with the State Division of Architecture and the Southern California chapter of the American Institute of Architects.

## FEMINEERS

The FEMINEERS, wives of members of the SEAONC, took over the Tonga Room of the Fairmont Hotel, San Francisco, for their annual Christmas Party on the 16th of December. Highlight of the luncheon was presentation of the Atens Water Follies program "Here Comes Santa Claus" starring Olympic swim champions.

Special invitations were extended members of the American Society of Civil Engineers, East Bay Structural Engineers, and Structural Engineers of Northern California. The program was in charge of Mesdames C. R. Graff, Wesley Hayes, H. S. Kellam, William Moore, Theodore Newman, Michael Pregnoff, Burr Randolph, Howard Schirmer, George Washington, and R. J. Woodward.

## PUGET SOUND CHAPTER AMERICAN SOCIETY FOR METALS

Francis G. Tatnall, director of research for the testing machine department of the Baldwin-Southwark Corp., discussed "Translation of Laboratory Tests Into An Improved Product" at a recent meeting of the Society held in Seattle.

Tatnall gave an outstanding presentation of a relatively new approach to the solution of the problem of metal failures. He feels the subject should be approached in forms of complex structures operating under multiple and varying dy-

namic loads. This requires new techniques of measuring the capabilities of materials and incorporating them into efficient design. These techniques consist of running tests on actual models or complete structures rather than the separate evaluation of component parts.

Complementing these are structural fatigue tests of entire assemblies, and high speed motion pictures of machine operations under varying conditions of dynamic loading.

**for CONSISTENCY,  
ALWAYS SPECIFY **HAWS**  
ELECTRIC  
WATER  
COOLERS**

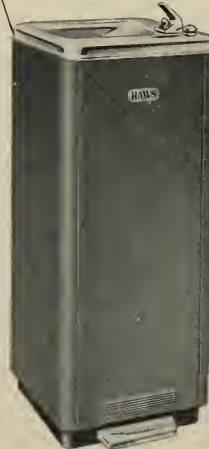

When you specify HAWS Electric Water Coolers, you are specifying a source of refreshing drinking water that is:

- Consistent in good design
- Consistent in sanitation
- Consistent in mechanical dependability

There is a HAWS Electric Water Cooler for every requirement.

See Sweet's... or write for new HAWS Catalog...NOW!

**HAWS DRINKING FAUCET CO.**  
1443 FOURTH STREET • BERKELEY 10, CALIFORNIA

# PRODUCER'S COUNCIL PAGE

The National Organization of Manufacturers of Quality Building Materials and Equipment  
(Northern California Chapter) affiliated with THE AMERICAN INSTITUTE OF ARCHITECTS

President, Roly MacNichol  
Libbey-Owens-Ford Glass Co.  
Rialto Bldg.

Vice-President, Ted Bakeman  
F. W. Wakefield Brass Co.  
445 Bryant Street

Secretary, John Cowley  
Hamilton Manufacturing Co.  
2833 3rd Street

Treasurer, Carl Frank  
Detroit Steel Products Co.  
Russ Building

Edited by Stanley L. Basterash—WESTERN ASBESTOS COMPANY

Phil Brown, Otis Elevator and John Cowley, The Bookman Co. attended the Architects Convention as representatives of the Northern California Chapter Producer's Council. They were good enough to get together and write up the following good reading.

## CONVENTION AFTER-THOUGHTS

The Regional Convention of the California Council of Architects was held at the Hotel Del Coronado on October 15, 16 and 17 and, while a thing of the past, there were several events and deeds which bear repeating.

The San Francisco Chapter of the Producers' Council was represented by about 12 of its local members and though weak in number, they were strong in spirit and, on occasion, strong in "spirits." We were guests of the Los Angeles Chapter and rendered assistance to the southerners in the social activities that they fostered. Of particular note was the swim show consisting of the stalwart talents from the Los Angeles Athletic Club, the Sportsmen's Dinner on Saturday night where John Doe presented the beliefs and viewpoints of a fugitive communist architect, and what he thought should be done to the architectural profession here in California to benefit all of the common people and several cocktail parties where a group of students from the Architectural School at Cal-Poly held the limelight with their singing.

As is usually the case, however, the most outstanding feature of the Convention was the annual struggle between the north and the south for athletic supremacy. The score this year again was in favor of the south, 21-14. For those who did not

participate and for those who are not aware of this contest, this is a baseball game and not football as the score would indicate.

In the dressing room after the game, (the bar) the coach advised that the game was actually a lot closer than the score would indicate and that it was only due to their very clever scouting that they were able to exploit our weaknesses.

These weaknesses consisted of poor fielding, poorer pitching, and the inability to hit the ball. There was an exception to this for it seemed that Ed Dill had some kind of an arrangement with the southern pitcher so that he consistently hit home runs.

The north was playing under a bit of a handicap inasmuch as the umpire at home plate was the wife of the southern catcher and the third base umpire was the daughter of the southern catcher. This family combination, the Herman Lights of Los Angeles, was just one of the psychological weapons used by the southern team to take advantage of our small weakness in our athletic ability.

One of the heroes of the game for the north, and a candidate for the award of Future Farmer of America was Clayton Kantz, architect from Redding, who ploughed a furrow straight and long between home and first base with his nose and eyeglasses. A runner-up in the dirt thrashing department was Berny Sabaroff, architect.

All in all, the game was a success and the trophy remained in the hands of the southerners but with the cries in the background by the northerners of "Wait Until Next Year."

USE QUALITY PRODUCTS CONSULT AN ARCHITECT





## GOLDEN GATE SEMINARY

(From Page 11)

extensive church organization in 22 southern States of the Southern Baptist Convention, came somewhat as a surprise. The explanation is forthcoming from Southern Baptists themselves that while they are comparative newcomers to California, their churches here have grown very fast and there is now great need for trained preachers, religious workers and church musicians of every category. The small plant of the young seminary, at present located in Berkeley, has become altogether inadequate and in order to accommodate its present student body of nearly 300, is using almost every type of temporary facility available.

The new campus is being planned to accommodate from 1200 to 1500 students, many of whom will be married and will live on the grounds with their wives and children. It will therefore need housing of various types, from dormitories to multi-family housing units.

To the Southern Baptists themselves and to most people throughout the south, such a project is not surprising. To explain this point, Dr. Graves has stated:

"The first Baptist theological school in the South was founded in 1859 at Greenville, South Carolina. It was moved to Louisville in 1877. That school now occupies a beautiful 70-acre campus in the finest section of the city and holds property with improvements worth well over \$5,000,000. Its beautiful Georgian Colonial buildings provide a memorable spectacle to thousands of visitors annually. The institution has held a significant place in Louisville's community life through the years.

"Forth Worth and New Orleans have likewise been hospitable homes for our seminaries. Students have come from all over the world to study at the seminaries in these cities, and their graduates have covered the earth in missionary work.

"So beneficial has been the influence of our seminaries, and so wide their recognition, that when a committee of Southern Baptists was looking for a city in which to locate a new seminary in the Southeast three years ago, a score of cities made bids. Atlanta promised \$1,000,000 as a beginning if it should locate there. After establishing a new seminary at a location finally decided upon at Wake Forest, North Carolina; that same committee turned to the Baptist seminary operating in Berkeley under the Southern Baptist Convention of California as the institution worthy of support in the West."

The architect for the project, John Carl Warnecke, son of the East Bay's architect Carl I. Warnecke, first came to the attention of the Southern Baptists through his now very well-known Mira

(See Page 33)



Architect:  
Stanley Fuller Davis

## PORCELAIN ENAMEL VENEER

### ECCLIASTICAL DIGNITY

preserved and displayed for all time  
to come... with decorum, with classic  
beauty, with PORCELAIN ENAMEL  
VENEER.

## Architectural Division

PORCELAIN ENAMEL PUBLICITY BUREAU  
ROOM 601, FRANKLIN BUILDING, OAKLAND 12, CALIFORNIA  
P. O. BOX 186, EAST PASADENA STATION, PASADENA 8, CALIFORNIA

water

FOR  
EVERY  
INDUSTRIAL  
AND  
COMMERCIAL  
NEED

WATER  
LoPrest  
CONDITIONING

### SOFTENERS, DEMINERALIZERS, DE-ALKALIZERS, FILTERS . . . WATER TREATMENT, SERVICE, EQUIPMENT AND SUPPLIES

Like everything else, water-conditioning nowadays is different! New high-capacity ion-exchange resins, miracle of modern science, have brought softer water within the reach of every water user.

In the west, Lo Prest engineers have pioneered the use of latest water conditioning techniques for over 25 years. Softeners now occupy less space than ever before . . . de-alkalizers now regenerate without acid . . . demineralizers now produce mineral-free water at a fraction of distillation costs.

Almost all natural water is hard. If you use water, you can increase efficiency, save money, reduce breakdowns with up-to-date approved methods and materials. Call or write for literature and analysis of your own problems.

A. C. LoPREST CO.  
DEPT. J1, 551 MINNA ST.  
SAN FRANCISCO, CALIF.  
PHONE: MARKET 1-1923

complete West Coast manufacturing, engineering, testing and service facilities for the production of industrial water supplies

# PERSONALITIES

**JOHN A. BLUME,**  
Structural Engineer San Francisco, California

A native Californian, John August Blume was born in Gonzales and raised in San Francisco where he attended Lowell High School, and later obtained two engineering degrees at Stanford



**JOHN A. BLUME**  
Structural Engineer

University. His schooling, like many engineers, was not without interruption, adventure and practical experience—traveling and living in the Hawaiian Islands, working in the construction industry as a laborer, truck driver, steel erector, riveter, carpenter, and surveyor.

Blume has had an intense interest in the earthquake problem since experiencing the Santa Barbara earthquake of 1925. Earthquake-resistant

designs and research are as much a hobby as a part of his work.

In this field he has worked with Dr. Lydik S. Jacobsen at Stanford University, in mathematical research on building dynamics, on models of buildings for shaking table research, and in developing and using a portable machine for vibrating buildings, dams and bridges in the Western States. Since then he has worked in design standards, codes, committees, and has given papers and written many articles and books on various phases of engineering seismology. He believes that structures can and should be designed and constructed at little or no extra cost to resist anticipated earthquakes and, further, that this involves professional judgement and not merely the blind following of building codes and mathematical formulae.

Since 1945 Blume has had his own offices in San Francisco for the practice of civil and structural engineering and has been responsible for wharves, docks, towers, special buildings and structures as well as the structural design of a great many schools, public buildings, commercial and industrial buildings, theatres and office buildings.

Engineer Blume is active in professional organizations and public service.

**NEXT MONTH:** John Carl Warnecke, AIA, Bay Area Architect.

# BRONZE PRODUCTS by GREENBERG

Your best and nearest source for standard and special Bronze products



STABILITY since 1954

**M. GREENBERG'S SONS**

765 Folsom St • San Francisco • Calif • EXbrook 2-3143

Manufacturers of Fire Hydrants and Fire Protection  
Brass Goods • Industrial, Navy and Maritime  
Bronze Valves and Fittings • Plumbing and  
Hardware Brass Specialties • Bronze Plaques,  
Letters and Name Plates

LOS ANGELES • PHOENIX • SEATTLE • PORTLAND • SPOKANE • SALT LAKE CITY • DENVER • KANSAS CITY • NEW ORLEANS • HONOLULU • NEW YORK • WASHINGTON, D. C.

ARCHITECT AND ENGINEER

## GOLDEN GATE SEMINARY

(From Page 31)

Vista Elementary School in El Cerrito (Richmond School District). At the headquarter's at Nashville, Tennessee, church architects there had read about Mira Vista and liked its character. In time, the Warnecke firm was engaged to make preliminary studies and site analyses for the Golden Gate seminary and on December 12, 1952, was commissioned for the entire project—even though at that time no site had been acquired.

In the meantime, the Warnecke firm has been occupied with a two-fold task. The first, to find a suitable site; the second, to make a complete program for the development of such a campus. For the most part, the actual needs of the institution were not even known to its own people. It took almost endless hours of conferences between the architectural staff, the administrative staff of the seminary and the faculty, to get such a program under way. It will now require some months of hard work in adapting this program to the actual site and in developing a full site utilization plan before specific buildings can be designed. In this part of the work the firm will be assisted by its planning consultant, Lawrence Livingston Jr.

Although no actual buildings have as yet been projected in anything like a definitive form, one thing is definite: the Southern Baptists have no idea of bringing traditional Southern architecture to California. They want the new campus to be developed along functional lines and adapted to Bay area living, while yet retaining the dignity and inspiration of a religious institution.

Strawberry Point, once considered a site for UN headquarters, is admirable for such a development. With natural beauties completely unspoiled, it has pleasantly rolling contours and some higher elevations which lend themselves to dramatic development. A great chapel, to seat upwards of 1500, is to be the central feature of the campus and will be so located and designed that it will be visible for miles.

From the architectural point of view, the Strawberry Point development should provide continuing interest for years to come. And from the religious and educational points of view, Golden Gate Baptist Theological Seminary, with its strong emphasis on evangelical and missionary work, can add immeasurably to the Bay area's influence in the Pacific area. To quote its president again, "... something which will symbolize the hopes, the dreams, the culture and the spiritual foundation of our civilization."

*all under one roof*



 <p>CX-1000S</p>	<p><i>schools</i></p>
 <p>PM-284</p>	<p><i>offices</i></p>
 <p>NE-2661</p>	<p><i>factories</i></p>
 <p>master</p>	<p><i>outdoors</i></p>

## Summerbell for CHURCHES



SUMMERBELL glued laminated arches and beams give the Architect the widest latitude in designing for the modern or the traditional...for the large cathedral or the small chapel. In addition to their lasting beauty, they provide structural advantages which effect substantial economies in overall costs. Write for illustrated brochure.

Methodist Church,  
Sherman Oaks, Calif.  
Architects,  
Frick & Frick,  
General Contractors,  
J. H. Baum & Sons.

Glued Laminated Construction • Summerbell Bowstring Trusses  
Lomella Roofs & All Types of Timber Structures

For quality, economy and satisfaction, specify SUMMERBELL

## Summerbell ROOF STRUCTURES

825 EAST 29TH STREET • BOX 218, STATION "K" • LOS ANGELES 11



## HIGHWAY CONSTRUCTION DOLLAR

(From Page 6)

- ble so that they may be adapted without loss of time and, if possible, without increases in costs, when conditions change in the field.
- d. That interpretation of specifications in the field be entrusted to supervisory personnel who have had practical experience with contractors and who understand their methods of obtaining results and who have authority to make binding decisions.
  - e. That regularly scheduled field meetings be held between engineer and contractor representatives to discuss the work so as to be of mutual assistance when problems arise.
  - f. That where separate specialty designs are involved they may be thoroughly coordinated in advance, with field conditions in mind.
  - g. That it be remembered that a design that appears most economical from a purely design standpoint may actually be more costly if it calls for special construction methods.

Might the AGC further suggest that the awarding agencies seeking greater economy aid the contracting industry by the following logical steps:

1. Write specifications defining precisely and accurately the results you wish to obtain without specifying methods and means for securing the results.
2. Consider new methods of construction, such as prestressing, welding and the use of high-tensile-strength bolted connections.
3. Prepare designs whenever possible that permit duplicate use of formwork.
4. Design and specify the reinforcing steel layouts, the steel detailing, the formwork, the machinery and methods of assembly as simply as good design and construction will allow.
5. Prepare specifications that permit the most economical use of construction equipment and the use of large units whenever possible.
6. Provide inspectors that are experienced mature men able to interpret the specifications accurately without making unreasonable restrictions on the contractors operations.
7. Also provide sufficient inspectors that the contractor can operate "round-the-clock" if conditions require; the contractor's investment in equipment is large and economical methods demand long hours of use of this machinery when weather permits.
8. Prepare designs that make use of a maximum of local materials.
9. Seek for a balanced construction program each year, that is, do not have a lot of culvert construction one year and none the next.
10. Award programs in contracts of various sizes to provide work for the large and small contractors alike, and thereby secure maximum competition.
11. Make each year's construction season as long as possible by awarding all projects as early as possible.
12. Pay the contractor promptly for completed work, his workmen demand that they be paid each pay day and prompt payment of vouchers from equipment distributors and materials men results in lower prices.



### Library Furniture

Parkside Library  
San Francisco

Appleton  
and  
Wolfard  
Architects

Manufactured by

## THE FINK & SCHINDLER CO.

Since 1882

552 Brannan Street San Francisco, Calif. EXbrook 2-1513

## CONTRACTORS — QUARRIERS — FABRICATORS

ALL TYPES OF

# ◆ GRANITE ◆

SPECIALIZING IN  
CALIFORNIA GRANITES

*Pacific Cut Stone & Granite Co.*

Home Office  
414 So. Marango Ave.  
Alhambra, Calif.  
Box 30, Ph. CU 31711

BLACK  
DIAMOND  
◆  
GRANITE

Fabricating Plants  
at  
Alhambra, Calif.  
Clovis, Calif.

13. Before a contract is awarded make certain that all the necessary right-of-way is available, when a contractor moves all of his expensive equipment onto a project only to have his operations delayed seriously by right-of-way difficulties this adds greatly to his costs and may result in higher bids when he bids at the next letting.

#### Engineers and Contractors Are Ready

The nation is becoming increasingly aware of the highway problem this country faces. As the public relations activities of those groups selling good roads becomes effective at the grass roots level and all highway users are made increasingly aware of the loss this country undergoes each year because of inadequate highways, the American people will demand and will be willing to pay for a bigger road construction program.

You, the state highway employees working with the Bureau of Public Roads and the local highway agencies, will plan and design better roads. We, the contracting industry, will build them. There is no doubt in my mind that when the general public finances a larger highway improvement program we will be able to give them their good roads promptly and that in doing so we will give them their money's worth by continuing to place great stress on improved and more economical construction procedures.

(Conclusion)

#### REINFORCED-CONCRETE BEAM

(From Page 24)

quired area of section of the right-hand bar is .52 sq in. Width of beam required is 10.10 in. plus 4 in. or 14.10 in., and depth is 18.08 in. plus 2 in. or 20.08 in.

Use 14 x 21 in. beam with a 1-in. sq or No. 9 bar at the left and a 7/8-in. bar at the right near the lower face, and near the top face add two 1/2-in. bars as suitable top steel. The maximum stresses in this beam when solved by exact methods are found to be 1135 psi in the concrete and 19,000 psi in the steel.

#### ARCHITECTURAL OFFICE OPENED

The formation of a partnership between Kurt Gross, AIA, and Fred Marburg, Architect, to be known as GURT GROSS, AIA—FRED MARBURG, ARCHITECTS, has been announced.

Offices of the new architectural firm, which will engage in the general practice of architecture, will be located at 390 Park Avenue, San Jose, California.

## Parker, Steffens & Pearce

BUILDERS

135 South Park, San Francisco

Phone: EXbrook 2-4832

## FORDERER CORNICE WORKS

Manufacturers of

Hollow Metal Products • Interior Metal Trim  
Elevator Fronts and Cabs

Metal Plaster Accessories • Sanitary Metal Base  
Flat and Roll Metal Screens

Metal Cabinets • Commercial Refrigerators

269 POTRERO AVE.

SAN FRANCISCO, CALIF.

HEMLOCK 1-4100

## J. BETTANCOURT GENERAL CONTRACTOR AND BUILDER

1015 SAN MATEO AVENUE

SAN BRUNO, CALIFORNIA

Phone: JUno 8-7525

## CLASSIFIED ADVERTISING

Do YOU want to hire, buy, sell, rent, find, lose, and otherwise transact business with others in the Construction Industry? If so, your best bet is a CLASSIFIED ad in ARCHITECT & ENGINEER magazine.

SELL that used equipment at a good price; secure competent employees; buy good used equipment; obtain information on wanted materials, etc.

Rates are low 20 cents per word—cash with order—minimum 3 lines. "Position Wanted" ads are half-rate.

Forms close 20th of month preceding date of publication.

## ARCHITECT & ENGINEER MAGAZINE

68 Post Street

San Francisco

# HAAS and HAYNIE

Formerly Haas Construction Company

Since 1898

275 PINE ST.

SAN FRANCISCO, CALIF.

Phone DOuglas 2-0678

## JUDSON PACIFIC - MURPHY CORP.

Steel Fabricators  
and  
Erectors

REINFORCING STEEL  
STRUCTURAL STEEL  
BRIDGE CRANES

4300 EASTSHORE HWY.  
EMERYVILLE, CALIF.

Phone:  
OL 3-1717

## CLINTON CONSTRUCTION CO. OF CALIFORNIA

General Contractors

923 FOLSOM STREET • SAN FRANCISCO

Utter 1-3440

## HOGAN LUMBER CO.

Wholesale and Retail

LUMBER

MILL WORK • SASH & DOORS

Office, Mill, Yard and Docks  
SECOND AND ALICE STREETS • OAKLAND, CALIF.

Telephone GLencourt 1-6861

## BOOK REVIEWS PAMPHLETS AND CATALOGUES

**MODERN SCHOOL SHOP PLANNING.** Prakken Publications.  
Ann Arbor, Michigan. Price \$2.50.

A complete coverage of all phases of planning for all types of school shops, it answers many questions on planning, laying-out and equipping school shops of all types and sizes.

This 113-page book, including 139 illustrations, is a factual, authoritative volume containing precise, practical suggestions for overall planning and individual shops, i.e. general shops, automotive shops, drafting shops, electrical, radio, TV-Shops, graphic arts shops, machine shops, metal working shops, and woodworking shops.

It has been written for those who are interested in new construction, remodeling, and planning. Includes principles of purchasing and safety in the school shop.

**SUNSET IDEAS FOR HILLSIDE HOMES.** Lane Publishing Co.,  
Menlo Park, California. Price \$1.00.

A new book packed with tested and proven ideas that hill dwellers have used to get the greatest value out of their homes and homesties. It shows with 100 clear "how-to" illustrations and 132 photographs, how you can take the fullest advantage of your view; utilize your space for pleasant outdoor living; avoid excessive stair traffic; provide protection from prevailing winds; prepare your hillside for planting and drainage; select the plants best suited for your sloping garden; use decks and terraces for fullest enjoyment.

Solutions to many problems contained in this book will be of help to every hillside home owner, and to those who are planning hillside homes.

**AN OPPORTUNITY TO REBUILD CHICAGO THROUGH INDUSTRIAL DEVELOPMENT ON THE CENTRAL SOUTH SIDE.** Published by South Side Planning Board, 2018 S. Calumet Ave., Chicago 16. Price \$2.00.

Contains thirty-two pages of illustrations, maps, diagrams, and text. Is the result of a four-year study in collaboration with twenty local public and private agencies concerned with urban redevelopment. "The proposal opens vast opportunities for the individual manufacturer who seeks an efficient in-lying plant location; for the industrial developer who looks for a profitable investment; for the adjacent community where residential and institutional redevelopment are well under way; and for the city as a whole whose economic future is dependent on the existence of a sound economic base."

**Dock board for service.** New brochure on Beacon Dock Boards for Service and Quality is available; showing illustrations of uses, permanent and temporary. Describes sizes, and gives many suggestions; designed to specifications. Write Dept. A&E, Hamerslag Equipment Co., 45 Elmira St., San Francisco, for free copy.

### NEW CATALOGUES AVAILABLE

*Architects, Engineers, Contractors, Planning Commission members—the catalogues, folders, new building products material, etc., described below may be obtained by directing your request to the name and address given in each item.*

**Flush-valves.** New Hand Book and Catalog No. 53 just issued by Coyne & Delany Co., features many details and features on the installation and practical use of flushometers, and is the most complete hand book of its kind ever printed. Blueprints show installation details and specifications covering every known type of installation—exposed and concealed. Write on firm letterhead to Dept. A&E, Engineering Dept., Coyne & Delany Co., Inc., 834 Kent Ave., Brooklyn 5, N. Y.

**Copper water tube.** A 16-page catalog containing technical section giving design and installation data to help in proper selection and application of copper water tube, has just been issued by Triangle Conduit & Cable Co. For free copy write Dept. A&E, Brass and Copper Tube Division, Triangle Conduit & Cable Co., Inc., New Brunswick, New Jersey. Ask for Catalog BC-1.

**Tennis Courts.** A new 12-page, 4-color booklet, for engineers and architects with detailed specifications, color photographs of typical installations, information concerning basic types and styles of all weather LAYKOLD and GRASSTEX tennis courts.



Includes section on cost, maintenance, resurfacing and player acceptance; courts are playable minutes after rain because true-plane surfaces are engineered to drain off rapidly. Available in colors. Write DEPT. A&E, American Bitumuls & Asphalt Co., 200 Bush St., San Francisco 4, for free copy of booklet.

**Aluminum entrances.** STYLINE Catalog (A.I.A. File No. 16), shows many design combinations possible in aluminum entrances. Illustrations give examples; specifications and details; hardware combinations and trim; bronze lettering; 21 traceable drawings of typical working details. For free copy write DEPT. A&E, Seattle Bronze Company, Inc., 315 2nd Avenue West, Seattle 99, Washington.

**Malarkey plywood.** A new 8-page catalog (A.I.A. File No. 23-L) shows in color the company's plywoods, lumber and mouldings. Included are specifications, suggested finishes and uses. Copies available FREE by writing DEPT-A&E, M and M Wood Working Co., 2310 N. Columbia Blvd., Portland 17, Oregon.

**Estimating Metal Roofs.** "How to Estimate Cost of Material and Labor for Metal Roofs" is the title of a new booklet published by the Follansbee Steel Corp. on Terne Metal Roofs. Designed for estimators and roofing contractors, the bulletin is of interest to architects, engineers, and contractors; contains complete data and work tables for determining roof areas by measurement or calculation; work tables—for copies write DEPT-A&E, Follansbee Steel Corp., Pittsburg 30, Pa.

**Sewage and Sump Pumps.** For engineers, architects and contractors, a new 8-page bulletin is available; describes in detail three types of pumps—vertical wet pit single or duplex; vertical dry pit; and horizontal. Complete specifications are given for all types and optional equipment is illustrated and explained. Performance tables on pump capacity; dimension drawings; explanation of material. For free copy write DEPT-A&E, American Marsh Pumps, Inc., Battle Creek, Michigan, Bulletin 325-A.

**Corrosion Resisting Valves.** Two corrosion resisting valve bulletins are now available. Section "A" illustrates Needle Valves and Section "E" illustrates safety and relief valves. Construction details, dimensions and capacity tables are included. For a free copy of either or both of these new Bulletins write, DEPT-A&E, Associated Valve & Engineering Co., 1150 West Marquette Road, Chicago 21, Ill.

**Facebrick.** A new full color booklet on contemporary uses of FACEBRICK is now available from Gladding, McBean & Company. In addition to showing many handsome applications of modular NORMAN and ROMAN FACEBRICK, this literature provides typical specifications and valuable architectural data. To obtain a free copy write DEPT-A&E, Gladding, McBean & Co., 2901 Los Feliz Blvd., Los Angeles, California. (A.I.A. 3-F-1)

**Hydraulic Hoists.** Two completely new arm-type hydraulic hoists for on or off highway application with 25 and 30 ton payload capacities are featured in brochure by Gar-Wood. Seventy degree dump angle assures quick, sure clean-out, even with slick materials in scoop-end bodies. Manufactured in Wayne, Michigan, and Richmond, California. Free copy of informative data write DEPT-A&E, Gar Wood Industries, Customer Service Dept., Wayne, Michigan, Form No. W-129.

**Radiant Heating.** Although one of oldest and most fundamental forms of heating, today's installation methods and modern materials are little understood. This brochure gives the fundamental facts, explains equipment, installation, etc. For Free copy write DEPT-A&E, Tom W. Booth, Radiant Heating, 3377 Mt. Diablo Blvd., Lafayette, California.

**New Boiler Base.** A new base for waterleg type boilers which overcomes the major problems which attend ordinary bases for the waterleg type boiler is explained in booklet (A.I.A. File No. 30-C-14 NN). Constructed of steel the base is shop fabricated and can be assembled by two men in less than an hour. For complete data write DEPT-A&E, Plibrico Co., 1800 Kingsbury St., Chicago 14, Ill.

**How Can Citizens Help Their Schools.** A number of booklets are available in the form of working guides on how to help in solving the school problem; prepared in conjunction with the National Citizens Commission for the Public Schools. Free copies may be obtained by writing DEPT-A&E, National Citizens Commission for the Public Schools, 2 West 45th Street, New York 36, N. Y.

**Hardening Stainless Steel.** Mr. C. U. Scott, recognized Dean of the American Heat Treaters, has just published an illustrated 64-page booklet on a method of hardening stainless steel; termed Super-Scotsonizing method hardens precision stainless steel parts subject to excessive wear. Booklet explains method and procedure. Write DEPT-A&E, C. U. Scott & Son, Inc., Rock Island, Illinois.

## PACIFIC MANUFACTURING CO.

High Class Interior Finish Quality Millwork

16 Beale St., San Francisco  
GARfield 1-7755

2215 El Camino Real, San Mateo  
Fireside 5-3531

2610 The Alameda, Santa Clara  
AXminster 6-2040 (Factory)

6820 McKinley Avenue, Los Angeles  
PLEasant 8-4196

MAIN OFFICE — SANTA CLARA

## "AMERICAN - MARSH" CONDENSATION UNIT

Pumping  
Machinery  
for  
Every  
Purpose

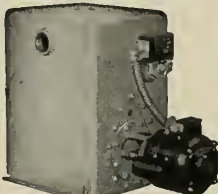

For Service  
Call  
DOuglas  
2-6794  
or  
MUltoo 8322

**SIMONDS MACHINERY CO.**  
SAN FRANCISCO 816 FOLSOM  
LOS ANGELES 455 EAST 4TH

## VERMONT MARBLE COMPANY

DOMESTIC AND IMPORTED MARBLES  
GRANITE VENEER

525 MARKET STREET • SAN FRANCISCO 5

Phone: SUtter 1-6747

3522 COUNCIL STREET • LOS ANGELES 4

Phone: DUkirk 2-7834

The Most Complete Line of  
STEELS and STEEL BUILDING MATERIALS  
Made by a Single Producer



See Sweet's Catalog File or write us for  
full information.

**REPUBLIC STEEL CORPORATION**

GENERAL OFFICES: CLEVELAND, OHIO

DENVER, COLORADO . . . . . CONTINENTAL OIL BUILDING  
LOS ANGELES, CALIF. . . . . GENERAL PETROLEUM BUILDING  
SAN FRANCISCO, CALIFORNIA . . . . . RIALTO BUILDING  
SEATTLE, WASH. . . . . WHITE-HENRY-STUART BUILDING

**CAMBRIDGE TILE MOVES  
OFFICES TO REDWOOD CITY**

The general service offices of the Cambridge Tile Company, which are under the supervision of Emil te Groen, division manager, have been moved to 132 Wilson Street in Redwood City, California.



**EMIL te GROEN**  
Division Manager

Location of the new offices on the San Mateo Peninsula will afford the firm more space for conduct of its business, and will make it much easier for customers as congested traffic and parking problems have been eliminated.

The offices, which were formerly located in San Francisco, serve the construction industry throughout Northern California, Oregon, Washington, Idaho, Wyoming, Utah, Colorado, and Nevada.

**TOM DILLON DEVELOPS  
SAFETY-GRIP BAR**

The newest development in a continuous expansion program, with the original adobe home of the Munras family as a nucleus, is the Convention and Recreation building, heated swimming pool and 12-unit cottage building, all designed by architect Robert R. Jones, of Carmel.

The Dillon Safety-Grip Bar, illustrated above, was invented by Tom Dillon of the Dillon Tile Company of San Francisco, to meet the requirements of an accident proof, safety grip with concealed mountings for installation in the Minimum Security Prison, State of California, at Soledad. The idea has subsequently been developed for use in hospitals, hotels, and recreational facilities such as the Casa Munras Hotel in Monterey, California.



J. Huerzenga (left) General Contractor; Walter Burde, Associate Architect; Robt. R. Jones, A.I.A.; John Parent, Sales Manager, Dillon Tile Supply Co.; Gordon Hooley, Gen.-Mgr., Casa Munras.

**HOLLYWOOD JUNIOR  
COMBINATION  
SCREEN and METAL SASH DOOR  
★  
The "WEATHER-WISE"  
DOOR!!**

**A VENTILATING SCREEN DOOR  
A SASH DOOR  
A PERMANENT OUTSIDE DOOR  
ALL 3 IN 1!**

Discriminating home owners and architects have chosen Hollywood Junior as the TRIPLE DOOR VALUE in the COMBINATION SCREEN and METAL SASH DOOR field. A sturdy dependable door, constructed of quality materials, HOLLYWOOD JUNIOR'S EXCLUSIVE PATENTED FEATURES have outmoded old-fashioned screen doors and other doors of its type entirely!

**IT GUARANTEES YOU YEAR 'ROUND  
COMFORT, CONVENIENCE and ECONOMY**

WE ALSO MANUFACTURE A COMPLETE LINE OF  
SHUTTERS, C. C. DOORS, SCREENS, SCREEN DOORS, LOUVRE DOORS

**WEST COAST SCREEN CO.**  
1145 EAST 33rd STREET LOS ANGELES, CALIFORNIA

◆ ◆ ◆ WRITE FOR FREE ILLUSTRATED LITERATURE ◆ ◆ ◆

**WOODWORK INSTITUTE OF  
CALIFORNIA MEETING**

The quarterly meeting of the Woodwork Institute of California, meeting in San Francisco recently, heard Carl A. Rasmussen, director of the Research Laboratory of the Western Pine Association in Portland, Oregon, give an illustrated lecture on "Research and Wood Products".

Special committee reports were given by S. Karns, Bush-Hollenbeck Company of Fresno, who stated additional technical material would soon be available and distributed for inclusion in the Institute's Manual which was distributed to the construction industry about a year ago.

Russell Bjorn, managing director of the Institute, reported on membership gains and finances.

Robert Hogan, Hogan Lumber Company, Oakland, president, presided.

# ESTIMATOR'S GUIDE

## BUILDING AND CONSTRUCTION MATERIALS

PRICES GIVEN ARE FIGURING PRICES AND ARE MADE UP FROM AVERAGE QUOTATIONS FURNISHED BY MATERIAL HOUSES TO SAN FRANCISCO CONTRACTORS. 3% SALES TAX ON ALL MATERIALS BUT NOT LABOR

All prices and wages quoted are for San Francisco and the Bay District. There may be slight fluctuation of prices in the interior and southern part of the state. Freight cartage, at least, must be added in figuring country work.

**BONDS**—Performance or Performance plus Labor and Material Bond(s), \$10 per \$1000 on contract price. Labor & Material Bond(s) only, \$5.00 per \$1000 on contract price.

**BRICKWORK—MASONRY—**

Common Brick—Per 1 M laid—\$150.00 up (according to class of work).  
 Face Brick—Per 1 M laid—\$200.00 and up (according to class of work).  
 Brick Steps—\$3.00 and up.  
 Common Brick Veneer on Frame Bldgs.—Approx. \$1.20 and up—(according to class of work).  
 Face Brick Veneer on Frame Bldgs.—Approx. \$2.00 and up (according to class of work).  
 Common Brick—\$36.00 per M truckload lots, delivered.

**Glassed Structural Units—Walls Erected—**

Clear Glazed  
 2 x 6 x 12 Furring .....\$2.00 per sq. ft.  
 4 x 6 x 12 Partition ..... 2.25 per sq. ft.  
 4 x 6 x 12 Double Faced  
 Partition ..... 3.00 per sq. ft.  
 For colored glaze add ..... .30 per sq. ft.  
 Metal Fire Brick \$150.00 per M—F.O.B. Pittsburgh.

Fire Brick—Per M—\$111.00 to \$147.00.  
 Cartage—Approx. \$10.00 per M.  
 Paving—\$75.00.

**Building Tile—**

8x5 1/2 x 12-inches, per M.....\$139.50  
 6x5 1/2 x 12-inches, per M..... 105.00  
 4x5 1/2 x 12-inches, per M..... 84.00

**Hollow Tile—**

12x12x2-inches, per M.....\$146.75  
 12x12x3-inches, per M..... 156.85  
 12x12x4-inches, per M..... 177.10  
 12x12x6-inches, per M..... 235.30  
 F.O.B. Plant

**BUILDING PAPER & FELTS—**

1 ply per 1000 ft. roll.....\$5.30  
 2 ply per 1000 ft. roll..... 7.80  
 3 ply per 1000 ft. roll..... 9.70  
 Brownkin, Standard 500 ft. roll..... 6.85  
 Sisalkraft, reinforced, 500 ft. roll..... 8.50

**Sheathing Papers—**

Asphalt sheathing, 15-lb. roll.....\$2.70  
 30-lb. roll..... 3.70  
 Dempcoer, 216-ft. roll..... 2.95  
 Blue Plasterboard, 60-lb. roll..... 5.10

**Felt Papers—**

Deadening felt, 3/4-lb., 50-ft. roll.....\$4.30  
 Deadening felt, 1-lb., 50-ft. roll..... 5.05  
 Asphalt roofing, 15-lbs..... 2.70  
 Asphalt roofing, 30-lbs..... 3.70

**Roofing Papers—**

Standard Grade, 108-ft. roll, Light.....\$2.50  
 Smooth Surface, Medium..... 2.90  
 Heavy..... 3.40  
 M. 5, Extra Heavy..... 3.95

**BUILDING HARDWARE—**

Sash cord com. No. 7.....\$2.65 per 100 ft.  
 Sash cord com. No. 8..... 3.00 per 100 ft.  
 Sash cord spot No. 7..... 3.65 per 100 ft.  
 Sash cord spot No. 8..... 3.35 per 100 ft.  
 Sash weights, cast iron, \$100.00 ton.....  
 1-Ton lots, per 100 lbs.....\$3.75  
 Less than 1-ton lots, per 100 lbs..... 4.75  
 Nails, per keg, base.....\$12.55  
 8-in. spikes..... 12.45  
 Rim Knob lock sets..... \$1.80  
 Butts, dull brass plated on steel, 3/2x3/2..... .76

**CONCRETE AGGREGATES—**

The following prices net to Contractors unless otherwise shown. Carload lots only.

	Bunker per ton	Del'd per ton
Gravel, all sizes.....	\$2.44	\$2.90
Top Sand.....	2.38	3.13
Concrete Mix.....	2.38	3.06
Crushed Rock, 1/4" to 3/4".....	2.38	2.90
Crushed Rock, 3/4" to 1 1/2".....	2.38	2.90
Roofing Gravel.....	2.81	2.90
River Sand.....	2.50	3.00
<b>Sand—</b>		
Lapis (Nos. 2 & 4).....	3.56	3.94
Olympic (Nos. 1 & 2).....	3.56	3.88

**Cement—**

Common (all brands, paper sacks),  
 Per Sack, small quantity (paper).....\$1.05  
 Carload lots, in bulk, per bbl..... 3.55  
 Cash discount on carload lots, 10c a bbl., 10th Prox., less than carload lots, \$4.00 per bbl. f.o.b. warehouse or delivered.  
 Cash discount 2% on L.C.L.  
 Trinity White..... 1 to 100 sacks, \$3.50 sack  
 Medusa White..... warehouse or del.; \$7.56  
 bbl. carload lots.

**CONCRETE READY-MIX—**

Delivered in 4-yd. loads:  
 Per cubic yard, 1-8 Mix.....\$ 9.80  
 1-7 Mix..... 10.15  
 1-6 Mix..... 10.70  
 1-5 Mix..... 11.40

Curing Compound, clear, drums,  
 per gal. .... 1.03

**CONCRETE BLOCKS—**

	Hay-dite	Basalt
4x8x16-inches, each.....	\$.19	\$.19
6x8x16-inches, each.....	.23	.235
8x8x16-inches, each.....	.27	.27
12x8x16-inches, each.....	.38	.40
12x8x24-inches, each.....	..	.60

**Haydite Aggregates—**

3/4-inch to 3/8-inch, per cu. yd.....\$7.75  
 3/8-inch to 3/4-inch, per cu. yd..... 7.75  
 No. 6 to 0-inch, per cu. yd..... 7.75

**DAMP-PROOFING and Waterproofing—**

Two-coat work, \$9.00 per square.  
 Membrane waterproofing—4 layers of saturated felt, \$10.00 per square.  
 Hot coating work, \$5.00 per square.  
 Medusa Waterproofing, \$3.50 per lb. San Francisco Warehouse.  
 Tricocon concrete waterproofing, 60c a cubic yd. and up.

**ELECTRIC WIRING—**\$15 to \$20 per outlet for conduit work (including switches).  
 Knob and tube average \$6.00 per outlet.

**ELEVATORS—**

Prices vary according to capacity, speed and type. Consult elevator companies.  
 Average cost of installing a slow speed automatic passenger elevator in small four story apartment building, including entrance doors, about \$9,500.00.

**EXCAVATION—**

Sand, \$1.00; clay or shale, \$1.50 per yard.  
 Trucks, \$30 to \$45 per day.  
 Above figures are an average without water. Steam shovel work in large quantities, less; hard material, such as rock, will run considerably more.

**FIRE ESCAPES—**

Ten-foot galvanized iron balcony, with stairs, \$250 installed on new buildings; \$300 on old buildings.

**FLOORS—**

Asphalt Tile, 1/8 in. gauge 18c to 35c per sq. ft.  
 Composition Floors, such as Magnesite, 40c-\$1.25 per sq. ft.  
 Linoleum, standard gauge, sq. yd.....\$2.75  
 Mastipave—\$1.50 per sq. yd.  
 Battleship Linoleum—1/8"—\$3.00 sq. yd.  
 Terazzo Floors—\$2.00 per sq. ft.  
 Terazzo Steps—\$2.50 per lin. ft.  
 Mastix Wear Coat—according to type—20c to 35c.

**Hardwood Flooring—**

**Oak Flooring—T & G—Fin—**

	3/4x2 1/4	1/2x2 1/4	3/4x2 1/4	1/2x2 1/4
Clear Old., White.....	\$425	\$405	\$	\$
Clear Old., Red.....	405	380		
Select Old., Red or White.....	355	340		
Clear Pln., Red or White.....	365	340	335	315
Select Pln., Red or White.....	340	330	325	300
#1 Common, Red or White 315	310	305	280	
#2 Common, Red or White 305				

**Prefinished Oak Flooring—**

	Prime	Standard
1/2 x 2.....	\$369.00	\$359.00
1/2 x 2 1/2.....	380.00	370.00
3/4 x 2 1/4.....	390.00	381.00
3/4 x 2 3/4.....	375.00	365.00
3/4 x 3.....	395.00	375.00
3/4 x 2 1/4 & 3/4 Ranch Plank.....		415.00

**Unfinished Maple Flooring—**

3/4 x 2 1/4 First Grade.....	\$370.00
3/4 x 2 1/4 2nd Grade.....	365.00
3/4 x 2 1/4 2nd & Btr. Grade.....	375.00
3/4 x 2 1/4 3rd Grade.....	240.00
3/4 x 3/4 3rd & Btr. Jtd. EM.....	380.00
3/4 x 3/2 2nd & Btr. Jtd. EM.....	390.00
3/4 x 2 1/4 First Grade.....	400.00
3/4 x 2 1/4 2nd Grade.....	360.00
3/4 x 2 1/4 3rd Grade.....	320.00

Floor Layer Wage \$2.83 per hr.

**GLASS—**

Single Strength Window Glass.....	\$ .30 per sq. ft.
Double Strength Window Glass.....	.45 per sq. ft.
Plate Glass, 1/4 polished to 75.....	1.60 per sq. ft.
75 to 100.....	1.74 per sq. ft.
1/4 in. Polished Wire Plate Glass.....	2.50 per sq. ft.
1/4 in. Rgh. Wire Glass.....	.80 per sq. ft.
1/4 in. Obscure Glass.....	.44 per sq. ft.
1/2 in. Obscure Glass.....	.63 per sq. ft.
1/2 in. Heat Absorbing Obscure.....	.54 per sq. ft.
3/8 in. Heat Absorbing Wire.....	.72 per sq. ft.
1/2 in. Ribbed.....	.44 per sq. ft.
1/2 in. Ribbed.....	.63 per sq. ft.
1/2 in. Rough.....	.44 per sq. ft.
3/8 in. Rough.....	.63 per sq. ft.
Glazing of above additional \$1.15 to	.30 per sq. ft.
Glass Blocks, set in place.....	3.50 per sq. ft.

**HEATING—**

**Furnaces—Gas Fired**

Floor Furnace, 25,000 BTU.....	\$ 70.50
35,000 BTU.....	77.00
45,000 BTU.....	90.50
Automatic Control, Add.....	39.00
Dual Wall Furnace, 25,000 BTU.....	91.50
35,000 BTU.....	99.00
45,000 BTU.....	117.00
With Automatic Control, Add.....	39.00
Unit Heaters, 50,000 BTU.....	202.00
Gravity Furnace, 65,000 BTU.....	198.00
Forced Air Furnace, 75,000 BTU.....	313.50

**Water Heaters—5-year guarantee**  
 With Thermostat Control,  
 20 gal. capacity..... \$7.50  
 30 gal. capacity..... 103.95  
 40 gal. capacity..... 120.00



## INSULATION AND WALLBOARD

Rockwool Insulation—	
(2") Less than 1,000 sq. ft.	\$64.00
(2") Over 1,000 sq. ft.	59.00
Cotton Insulation—Full thickness	
(3%)	\$95.50 per M sq. ft.
Sisalation Aluminum Insulation—Aluminum coated on both sides.	\$23.50 per M sq. ft.
Tileboard— $\frac{1}{2}$ " panel	\$9.00 per panel
Wallboard— $\frac{1}{2}$ " thickness	\$55.00 per M sq. ft.
Finished Plank	69.00 per M sq. ft.
Ceiling Tileboard	69.00 per M sq. ft.

IRON—Cost of ornamental iron, cast iron, etc., depends on designs.

## LUMBER—

S4S No. 2 and better common	
O.P. or D.F., per M, f.b.m.	\$100.00
Rough, No. 2 common O.P. or D.F., per M, f.b.m.	95.00

## Flooring—

	Per M Delvd.
V.G.-D.F. B & Btr, 1 x 4 T & G Flooring.	\$225.00
"D" and better—all	225.00
"D" and better—all	225.00
Rwd. Rustic—"A" grade, medium dry, 8 to 24 ft.	165.00

## Plywood, per M sq. ft.

$\frac{1}{4}$ -inch, 4.0x8.0-S15	\$135.00
$\frac{1}{2}$ -inch, 4.0x8.0-S15	219.00
$\frac{3}{4}$ -inch, per M sq. ft.	292.00
Plycard	111 $\frac{1}{2}$ ¢ per ft.
Plyform	25¢ per ft.

## Shingles (Rwd., not available)—

Red Cedar No. 1—\$9.50 per square; No. 2, \$7.00; No. 3, \$5.00.
--

Average cost to lay shingles, \$6.00 per square.

Cedar Shakes— $\frac{1}{2}$ " to  $\frac{3}{4}$ " x 24/26 in handsplit tapered or split resawn, per square

$\frac{3}{4}$ " to  $1\frac{1}{4}$ " x 24/26 in split resawn, per square

Average cost to lay shakes, \$8.00 per square.

## Pressure Treated Lumber—

Salt Treated. Add \$35 per M to above

Crossed, 8-lb. treatment. Add \$45 per M to above

## MARBLE—(See Dealers)

## METAL LATH EXPANDED—

Standard Diamond, 3.40, Copper Bearing, LCL, per 100 sq. yds. \$43.50

Standard Ribbed, ditto. \$47.50

## MILLWORK—Standard.

D. F. \$150 per 1000, R. W. Rustic \$175 per 1000 (delivered).

Double hung bow window frames, average with trim, \$12.50 and up, each.

Complete door unit, \$15 to \$25.

Screen doors, \$8.00 to \$12.00 each.

Patent screen windows, \$1.25 a sq. ft.

Cases for kitchen pantries seven ft. high, per lineal ft., upper \$9.00 to \$11.00; lower \$12.00 to \$13.00.

Dining room cases, \$20 per lineal foot. Rough and finish about \$1.00 per sq. ft.

Labor—Rough carpentry, warehouse heavy framing (average), \$75.00 per M.

For smaller work average, \$85.00 to \$100. per 1000.

## PAINTING—

Two-coat work per yard 85¢

Three-coat work per yard \$1.10

Cold water painting, per yard 25¢

Whitewashing per yard 15¢

Linseed Oil, Strictly Pure Wholesale

(Basis 7 $\frac{1}{2}$ lbs. per gal.)	Row	Boiled
Light iron drums	per gal.	\$2.28
5-gallon cans	per gal.	2.40
1-gallon cans	per gal.	2.52
Quart cans	each	71
Pint cans	each	38
$\frac{1}{2}$ -pint cans	each	24

Turpentine	Pure Gum
(Basis, 7.2 lbs. per gal.)	Spirits
Light iron drums	per gal.
5-gallon cans	per gal.
1-gallon cans	each
Quart cans	each
Pint cans	each
$\frac{1}{2}$ -pint cans	each

## Pioneer White Lead in Oil Heavy Paste and All-Purpose (Soft-Paste)

	Net Weight Packages	Per 100 lbs.	Fr. per pkg.	Price to Painters lbs.	Per, per pkg.
100-lb. kegs	\$28.35	\$29.35	\$27.50	\$27.50	\$27.50
50-lb. kegs	30.05	15.00	28.15	14.08	
25-lb. kegs	30.35	7.50	28.45	7.12	
5-lb. cans	33.35	1.34	31.25	1.25	
1-lb. cans	36.00	.36	33.75	.34	

500 lbs. (one delivery)  $\frac{3}{4}$ ¢ per pound less than above.

\*Heavy Paste only.  
Pioneer Dry White Lead—Litharge—Dry Red Lead Red Lead in Oil

	Price to Painters—Price Per 100 Pounds
	100 lbs.
	50 lbs.
	25 lbs.
Dry White Lead	\$26.30
Litharge	25.95
Dry Red Lead	27.20
Red Lead in Oil	30.65

## PATENT CHIMNEYS—

6-inch	\$2.50 lineal foot
8-inch	3.00 lineal foot
10-inch	4.00 lineal foot
12-inch	5.00 lineal foot

## PLASTER—

Neat wall, per ton delivered in S. F. in paper bags, \$17.60.

## PLASTERING (Interior)—

3 Coats, metal lath and plaster	3.00
Keene cement on metal lath	\$5.00
Ceilings with $\frac{3}{4}$ " hot roll channels metal lath (lathed only)	3.00
Ceilings with $\frac{3}{4}$ " hot roll channels metal lath plastered	4.50
Single partition $\frac{3}{4}$ " channels and metal lath 1 side (lath only)	3.00
Single partition $\frac{3}{4}$ " channels and metal lath 2 inches thick plastered	6.00
4-inch double partition $\frac{3}{4}$ " channels and metal lath 2 sides (lath only)	5.75
4-inch double partition $\frac{3}{4}$ " channels and metal lath 2 sides plastered	8.75
Thermax single partition; 1" channels; 2 $\frac{1}{4}$ " overall partition width. Plastered both sides	7.50
Thermax double partition; 1" channels; 4 $\frac{1}{2}$ " overall partition width. Plastered both sides	11.00
3 Coats over 1" Thermax nailed to one side wood studs or joists	4.50
3 Coats over 1" Thermax suspended to one side wood studs with spring sound isolation clip	5.00

## PLASTERING (Exterior)—

2 coats cement finish, brick or concrete wall	2.50
3 coats cement finish, No. 18 gauge wire mesh	3.50
Lime—\$4.00 per bbl. at yard.	
Processed Lime—\$4.15 per bbl. at yard.	
Rock or Grip Lath— $\frac{3}{8}$ "—30¢ per sq. yd.	
$\frac{1}{2}$ "—29¢ per sq. yd.	
Composition Stucco—\$4.00 sq. yd. (applied).	

## PLUMBING—

From \$200.00 per fixture up, according to grade, quality and runs.

## ROOFING—

'Standard' tar and gravel, 4 ply \$13.00 per sq. for 30 sqs. or over.

Less than 30 sqs. \$16.00 per sq.

Tile \$40.00 to \$50.00 per square.

No. 1 Redwood Shingles in place.

$\frac{1}{2}$ " in. exposure, per square. \$18.25

5/2 No. 1 Cedar Shingles, 5 in. exposure, per square. 14.50

5/8 x 16"—No. 1 Little Giant Cedar Shingles, 5" exposure, per square. 18.25

4/2 No. 1-24" Royal Cedar Shingles 7 $\frac{1}{2}$ " exposure, per square. 23.00

Re-coat with Gravel \$5.50 per sq.

Asbestos Shingles, \$27 to \$35 per sq. laid.

$\frac{1}{2}$  to  $\frac{3}{4}$  x 25" Resawn Cedar Shakes, 10" Exposure \$30.00

$\frac{3}{4}$  to  $1\frac{1}{4}$  x 25" Resawn Cedar Shakes, 10" Exposure \$35.00

1 x 25" Resawn Cedar Shakes, 10" Exposure \$22.00

Above prices are for shakes in place.

## SEWER PIPE—

C.I. 6-in. to 24-in. B. & S. Class B and heavier, per top. \$99.50

Vitrified, per foot: L.C.L. F.O.B. Warehouse, San Francisco.

Standard, 8-in. \$ .66

Standard, 12 in. 1.30

Standard, 24-in. 5.41

Clay Drain Pipe, per 1,000 L.F. L.C.L., F.O.B. Warehouse, San Francisco:

Standard, 6-in. per M. \$24.00

Standard, 8-in. per M. 400.00

## SHEET METAL—

Windows—Metal, \$2.50 a sq. ft.

Fire doors (average), including hardware \$2.80 per sq. ft., size 12'x12'. \$3.75 per sq. ft., size 3'x6'.

## SKYLIGHTS—(not glazed)

Galvanized iron, per sq. ft. \$1.25

Vented hip skylights, per sq. ft. 2.25

Aluminum, puttless, (unglazed), per sq. ft. 1.25

(installed and glazed), per sq. ft. 1.85

## STEEL—STRUCTURAL—

\$290 per ton erected, when out of mill.

\$350 per ton erected, when out of stock.

## STEEL REINFORCING—

\$200.00 per ton, in place.

$\frac{1}{4}$ -in. Rd. (Less than 1 ton) per 100 lbs. \$8.90

$\frac{3}{8}$ -in. Rd. (Less than 1 ton) per 100 lbs. 7.80

$\frac{1}{2}$ -in. Rd. (Less than 1 ton) per 100 lbs. 7.50

$\frac{3}{4}$ -in. Rd. (Less than 1 ton) per 100 lbs. 7.25

$\frac{1}{2}$ -in. &  $\frac{3}{8}$ -in. Rd. (Less than 1 ton) 7.10

1 in. & up (Less than 1 ton) 7.10

1 ton to 5 tons, deduct 25¢.

## STORE FRONTS—

Individual estimates recommended. See ESTIMATORS DIRECTORY for Architectural Veneer (3), and Mosaic Tile (35).

## TILE—

Ceramic Tile Floors—Commercial \$1.20 to \$1.60 per sq. ft.

Cove Base—\$1.40 per lin. ft.

Quarry Tile Floors, 6x6" with 6" base @ \$1.35 per sq. ft.

Tile Wainscots & Floors, Residential, 4 $\frac{1}{4}$ x4 $\frac{1}{4}$ " @ \$1.65 to \$2.00 per sq. ft.

Tile Wainscots, Commercial Jobs, 4 $\frac{1}{4}$ x4 $\frac{1}{4}$ " Tile, @ \$1.50 to \$1.65 per sq. ft.

Asphalt Tile Floor  $\frac{1}{8}$ " x  $\frac{1}{8}$ " x  $\frac{1}{8}$ " \$ .18 - \$ .35 sq. yd.

Light shades slightly higher.

Cork Tile—\$ .70 per sq. ft.

Mosaic Floors—See dealers.

Linoleum tile, per sq. ft. \$ .65

Rubber tile, per sq. ft. \$ .55 to \$ .75

## Furring Tile

Scored	F.O.B. S. F.
12 x 12, each	\$ .17

Krafftile: Per square foot	Small	Large
Patio Tile—Niles Red	Lots	Lots
12 x 12 x $\frac{3}{8}$ -inch, plain	\$ .40	\$ .36
6 x 12 x $\frac{3}{8}$ -inch, plain	.44	.39
6 x 6 x $\frac{3}{8}$ -inch, plain	.46	.42

## Building Tile

8 $\frac{1}{2}$ "x12 inches, per M	\$139.50
6 $\frac{1}{2}$ "x12 inches, per M	105.00
4 $\frac{1}{2}$ "x12 inches, per M	84.00

## Hollow Tile

12x12x2 inches, per M	\$146.75
12x12x3 inches, per M	156.85
12x12x4 inches, per M	177.10
12x12x6 inches, per M	235.30

F.O.B. Plant

## VENETIAN BLINDS—

75¢ per square foot and up. Installation extra.

## WINDOWS—STEEL—INDUSTRIAL—

Cost depends on design and quality required.

# ARCHITECT AND ENGINEER ESTIMATOR'S DIRECTORY

## Building and Construction Materials

**EXPLANATION**—Building and construction materials are shown in major classified groups for general identification purposes with names and addresses of suppliers of materials listed in detail under group classification where name first appears—main offices are shown first with branch or district offices following. The numeral appearing in listings \*(3) refers to the major group classification where complete data on the dealer, or representative, may be found.

### ADHESIVES (1)

Wall and Floor Tile Adhesives  
THE CAMBRIDGE TILE MFG. CO. \*(135)

### AIR CONDITIONING (2)

Air Conditioning & Cooling  
UTILITY APPLIANCE CORP.  
Los Angeles 58: 4851 S. Alameda St.  
San Francisco: 1355 Market St., UN 1-4908

### ARCHITECTURAL PORCELAIN ENAMEL (2a)

CALIFORNIA METAL ENAMELING CO.  
Los Angeles: 6904 E. Slauson, UN 01268  
San Francisco: O'Keefe's, 55-11th St., UN 3-4445  
Portland: Beaver Sheet Metal & Roofing Co.,  
924 N. Russell St., TR 6766  
Seattle: Teclar Aluminum Co.,  
625 Yale Ave. N., SE 8494  
Salt Lake City: S. A. Roberts & Co.,  
109 W. 2nd South, Salt Lake 4-4431  
Phoenix: Baker-Thomas Co.,  
300 S. 12th, Phoenix 4-5503  
Tucson: Laing-Garrett Co.,  
19 S. Tyn dall Ave., TU 2-2893  
Albuquerque: Welch-Irwin Corp., 1726 Lomas Blvd. NE.

### ARCHITECTURAL VENEER (3)

Ceramic Veneer  
GLADDING, McBEAN & CO.  
San Francisco: Harrison at 9th St., UN 1-7400  
Los Angeles: 2901 Los Feliz Blvd., OL 2121  
Portland: 110 S.E. Main St., EA 6179  
Seattle: 1500 First Ave. S., EL 4711  
Spokane: 1102 N. Monroe St., BR 3259  
THE CAMBRIDGE TILE MFG. CO. \*(135)  
Porcelain Veneer  
PORCELAIN ENAMEL PUBLICITY BUREAU  
Oakland 12: Room 601 Franklin Building  
Pasadena 8: P. O. Box 186, East Pasadena Station  
Granite Veneer  
VERMONT MARBLE COMPANY  
San Francisco 5: 525 Market St., SU 1-6747  
Los Angeles: 3522 Council St., DU 2-7834  
Marble Veneer  
VERMONT MARBLE COMPANY  
San Francisco 5: 525 Market St., SU 1-6747  
Los Angeles: 3522 Council St., DU 2-7834

### BANKS - FINANCING (4)

CROCKER FIRST NATIONAL BANK OF S. F.  
San Francisco, Post & Montgomery Sts., EX 2-7700

### BATHROOM FIXTURES (5)

Metal  
THE CAMBRIDGE TILE MFG. CO. \*(135)  
Ceramic  
THE CAMBRIDGE TILE MFG. CO. \*(135)

### BRASS PRODUCTS (6)

GREENBERG'S, M. & SONS  
San Francisco 7: 765 Folsom, EX 2-3143  
Los Angeles 23: 1258 S. Boyle, AN 3-7108  
Seattle 4: 1016 First Ave. So., MA 5140  
Phoenix: 3009 N. 19th Ave., Apt. 92, PH 2-7663  
Portland 4: 510 Builders Exch. Bldg., AT 6443

### BRICKWORK (7)

Face Brick  
GLADDING, McBEAN & CO. \*(13)

KRAFTILE \*(135)  
REMILLARD-DANDINI CO.  
San Francisco 4: 400 Montgomery St., EX 2-4988

### BRONZE PRODUCTS (8)

GREENBERG'S, M. & SONS \*(161)  
BUILDING PAPERS & FELTS (9)  
ANGIER PACIFIC CORP.  
San Francisco 5: 55 New Montgomery St., DO 2-4416  
Los Angeles: 7424 Sunset Blvd.  
PACIFIC COAST AGGREGATES, INC. \*(111)  
SISALKRAFT COMPANY  
San Francisco 5: 55 New Montgomery St., EX 2-3066  
Chicago, Ill.: 205 West Wacker Drive

### BUILDING HARDWARE (9a)

THE STANLEY WORKS  
San Francisco: Monadnock Bldg., YU 6-5914  
New Britain, Conn.

### CABINETS & FIXTURES (9b)

FINK & SCHINDLER, THE; CO.  
San Francisco: 522 Brannan St., EX 2-1513

### CEMENT (10)

IDEAL CEMENT COMPANY (Pacific Division)  
San Francisco 4: 310 Sansome St., GA 1-4100  
PACIFIC COAST AGGREGATES, INC. \*(111)

### CONCRETE AGGREGATES (11)

Ready Mixed Concrete  
PACIFIC COAST AGGREGATES, INC.  
San Francisco: 400 Alabama St., KL 2-1616  
Sacramento: 16th and A Sts., GL 3-6586  
San Jose: 790 Stockton Ave., CY 2-5620  
Oakland: 2400 Perilla St., GL 1-0177  
Stockton: 820 So. California St., ST 8-8643  
Lightweight Aggregates  
AMERICAN PERLITE CORP.  
Richmond: 26th & B. St. - Yd. 2, RI 4307

### DOORS (12)

Hollywood Doors  
WEST COAST SCREEN CO.  
Los Angeles: 1127 E. 63rd St., AD 1-1108  
W. P. FULLER CO.  
Seattle, Tacoma, Portland  
NICOLAI DOOR SALES CO.  
San Francisco: 3045 19th St.  
F. M. COBB CO.  
Los Angeles & San Diego  
SOUTHWESTERN SASH & DOOR  
Phoenix, Tucson, Arizona  
El Paso, Texas  
HOUSTON SASH & DOOR  
Houston, Texas  
Screen Doors  
WEST COAST SCREEN DOOR CO.  
(See above)

### FIRE ESCAPES (13)

MICHEL & PFEFFER IRON WORKS, INC.  
South Linden & Tanforan Ave.  
South San Francisco: JU 4-8362

### FIREPLACES (14)

Heat Circulating  
SUPERIOR FIREPLACE CO.  
Los Angeles: 1708 E. 15th St., PR 8393  
Baltimore, Md.: 601 No. Point Rd.

### FLOORS (15)

Hardwood Flooring  
HOGAN LUMBER COMPANY  
Oakland: Second and Alice Sts., GL 1-6861  
Floor Tile  
GLADDING, McBEAN & CO. \*(13)  
KRAFTILE \*(135)  
Floor Tile (Ceramic Mosaic)  
THE CAMBRIDGE TILE MFG. CO. \*(135)  
Floor Treatment & Maintenance  
HILLYARD SALES CO. (Western)  
San Francisco: 470 Alabama St., MA 1-7766  
Los Angeles: 923 E. 3rd, TR B282  
Seattle: 3440 E. Marginal Way  
Diversified (Magnesite, Asphalt Tile, Composition, Etc.)  
LE ROY OLSON CO.  
San Francisco 10: 3070 - 17th St., HE 1-0188  
Sleepers (composition)  
LE ROY OLSON CO.

### GLASS (16)

W. P. FULLER COMPANY  
San Francisco: 301 Mission St., EX 2-7151  
Los Angeles, Calif.  
Portland, Ore.

### GRANITE (16a)

PACIFIC CUT STONE & GRANITE CO.  
414 South Marengo Ave., Alhambra, Calif.

### HEATING (17)

S. T. JOHNSON CO.  
Oakland 8: 940 Arlington Ave., OL 2-6000  
San Francisco: 585 Potrero Ave., MA 1-2757  
Philadelphia 8, Pa.: 401 N. Broad St.  
SCOTT COMPANY  
San Francisco: 243 Minna St., YU 2-0400  
Oakland: 113 - 10th St., GL 1-1937  
Los Angeles, Calif.  
UTILITY APPLIANCE CORP. \*(12)  
Electric Heaters  
WESIX ELECTRIC HEATER CO.  
San Francisco 5: 390 First St., GA 1-2211  
Los Angeles: 520 W. 7th St., MI 8096  
Portland: Terminal Sales Bldg., BE 2050  
Seattle: Securities Bldg., SE 5028

### Designer of Heating

THOMAS B. HUNTER  
San Francisco 4: 41 Sutter St., GA 1-1164

### INSULATION AND WALL BOARD (18)

LUMBER MANUFACTURING CO.  
San Francisco: 225 Industrial Ave., JU 7-1760  
PACIFIC COAST AGGREGATES, INC. \*(111)  
SISALKRAFT COMPANY \*(19)  
WESTERN ASBESTOS COMPANY  
San Francisco: 675 Townsend St., KL 2-3868  
Oakland: 251 Fifth Avenue, GL 1-2345  
Stockton: 733 S. Van Buren, ST 4-9421  
Sacramento 1331 - T St., HU 1-0125  
Fresno: 434 - P St., FR 2-1600

### IRON—Ornamental (10)

MICHEL & PFEFFER IRON WORKS, INC. \*(13)

### LANDSCAPING (20)

Landscape Contractors  
HENRY C. SOTO CORP.  
Los Angeles: 13,000 S. Avalon Blvd., ME 4-6617

### LIGHTING FIXTURES (21)

SMOOTH-HOLMAN COMPANY  
Inglewood, Calif., OR 8-1217  
San Francisco: 55 Mississippi St., MA 1-8474

**LUMBER (22)**  
Shingles  
LUMBER MANUFACTURING CO. \* (18)

**MARBLE (23)**  
VERMONT MARBLE COMPANY  
San Francisco 5: 525 Market St., SU 1-6747  
Los Angeles 4: 3522 Council St., DU 2-7834

**METAL LATH EXPANDED (24)**  
PACIFIC COAST AGGREGATES, INC. \* (11)

**MILLWORK (25)**  
FINK & SCHINDLER, THE; CO: \* (96)  
LUMBER MANUFACTURING COMPANY \* (18)  
MULLEN MANUFACTURING COMPANY  
San Francisco: 60-80 Rausch St., UN 1-5815  
PACIFIC MANUFACTURING COMPANY  
San Francisco: 16 Beale St., GA 1-7755  
Santa Clara: 2610 The Alameda, SC 607  
Los Angeles, 6820 McKinley Ave., TH 4196

**PAINTING (26)**  
Paint  
W. P. FULLER COMPANY \* (16)

**PLASTER (27)**  
Interiors - Metal Lath & Trim  
PACIFIC COAST AGGREGATES, INC. \* (11)  
Exteriors  
PACIFIC PORTLAND CEMENT COMPANY \* (28)

**PLASTIC CEMENT (28)**  
IDEAL CEMENT COMPANY  
San Francisco: 310 Sansome St., GA 1-4100

**PLUMBING (29)**  
THE HALSEY TAYLOR COMPANY  
Redlands, Calif.  
Warren, Ohio  
THE SCOTT COMPANY \* (17)  
HAWS DRINKING FAUCET COMPANY  
Berkeley 10: 1435 Fourth St., LA 5-3341  
CONTINENTAL WATER HEATER COMPANY  
Los Angeles 31: 1801 Pasadena Ave., CA 6178  
SIMONDS MACHINERY COMPANY  
San Francisco: 816 Folsom St., DO 2-6794  
Los Angeles: 455 East 4th St., MU 8322  
SECURITY VALVE COMPANY  
Los Angeles 31: 410 San Fernando Rd., CA 6191

**RANGE-REFRIGERATOR (29a)**  
Combinations  
GENERAL AIR CONDITIONING CORPN.  
Los Angeles 23: 4542 E. Dunham St.  
San Francisco: 1355 Market St., KL 2-2311, Ext. 104

**RESILIENT TILE (30)**  
LE ROY OLSON CO. \* (15)

**SEWER PIPE (32)**  
GLADDING, McBEAN & CO. \* (3)

**SHEET METAL (32)**  
Windows  
DETROIT STEEL PRODUCTS COMPANY  
Oakland 8: 1310 - 63rd St., OL 2-8826  
San Francisco: Russ Building, DO 2-D890  
MICHEL & PFEFFER IRON WORKS, INC. \* (13)  
PACIFIC COAST AGGREGATES, INC. \* (11)

Fire Doors  
DETROIT STEEL PRODUCTS COMPANY  
Skylights  
DETROIT STEEL PRODUCTS COMPANY  
**STEEL—STRUCTURAL (33)**  
COLUMBIA-GENEVA DIVISION, U. S. STEEL CORP.  
San Francisco: Russ Bldg., SU 1-2500  
Los Angeles: 2087 E. Slauson, LA 1171  
Portland: 2345 N. W. Nicolai, BE 7261  
Seattle 1331 3rd Ave. Bldg., WA 1971  
Salt Lake City: Walker Bank Bldg., SL 3-6733  
HERRICK IRON WORKS  
Oakland: 18th & Campbell Sts., GL 1-1767  
JUDSON PACIFIC-MURPHY CORP.  
Emeryville: 4300 Eastshore Highway, OL 3-1717  
REPUBLIC STEEL CORP.  
San Francisco: 116 N. Montgomery St., GA 1-0977  
Los Angeles: Edison Building  
Seattle: White-Henry-Stuart Building  
Salt Lake City: Walker Bank Building  
Denver: Continental Oil Building  
SAN JOSE STEEL COMPANY  
San Jose 195 North Thirtieth St., CO 4184

**STEEL—REINFORCING (34)**  
REPUBLIC STEEL CORP. \* (33)  
HERRICK IRON WORKS \* (33)  
SAN JOSE STEEL CO. \* (33)  
COLUMBIA-GENEVA DIVISION, U. S. STEEL CORP. \* (33)

**CLAY TILE (35)**  
THE CAMBRIDGE TILE MFG. CO.  
San Francisco 10: 47D Alabama St., UN 3-1666  
Los Angeles 19: 1335 S. La Brea, WE 3-7800  
GLADDING, McBEAN & CO. \* (3)  
KRAFTILE  
Niles, Calif.: Niles 3611  
San Francisco 5: 5D Hawthorne St., DO 2-3780  
Los Angeles 13: 406 South Main St., MU 7241

**TIMBER—REINFORCING (36)**  
Trusses

Tacoma, Wash.  
WYERHAEUSER SALES CO.  
St. Paul, Minn.  
Newark, N. J.  
Treated Timber  
J. H. BAXTER CO.  
San Francisco 4: 333 Montgomery St., DO 2-3888  
Los Angeles 13: 601 West Fifth St., MI 6294

**WALL TILE (37)**  
THE CAMBRIDGE TILE MFG. CO. \* (35)  
GLADDING, McBEAN & CO. \* (3)  
KRAFTILE COMPANY \* (35)

**WINDOWS STEEL (38)**  
DETROIT STEEL PRODUCTS CO. \* (32)  
MICHEL & PFEFFER IRON WORKS, INC. \* (13)  
PACIFIC COAST AGGREGATES, INC. \* (11)

**GENERAL CONTRACTORS (39)**  
BARRETT & HILP  
San Francisco: 918 Harrison St., DO 2-0700  
Los Angeles: 234 W. 37th Place, AD 3-8161  
J. BETTANCOURT  
San Bruno: 1015 San Mateo Ave., JUnO 8-7525  
DINWIDDIE CONSTRUCTION COMPANY  
San Francisco: Crocker Building, YU 6-2718  
CLINTON CONSTRUCTION COMPANY  
San Francisco: 923 Folsom St., SU 1-3440  
MATTOCK CONSTRUCTION COMPANY  
San Francisco: 604 Mission St., GA 1-5516  
E. H. MOORE & SONS  
San Francisco: 693 Mission St., GA 1-8579  
PARKER, STEFFENS & PEARCE  
San Francisco: 135 So. Park, EX 2-6639

**TESTING LABORATORIES**  
**(ENGINEERS & CHEMISTS (40))**  
ABBOT A. HANKS, INC.  
San Francisco: 624 Sacramento St., GA 1-1697  
ROBERT W. HUNT COMPANY  
San Francisco: 50D Iowa, MI 7-0224  
Los Angeles: 305D E. Slauson, JE 9131  
Chicago, New York, Pittsburgh  
PITTSBURGH TESTING LABORATORY  
San Francisco: 651 Howard St., EX 2-1747

## CONSTRUCTION CONTRACTS AWARDED AND MISCELLANEOUS PERSONNEL DATA

**MEMORIAL UNION**, Davis Campus University of California, Yolo county. University of California, Davis, owner. 1-Story, basement, reinforced concrete with brick exterior facing, Memorial Union Building, 38,000 sq. ft., \$834,321. ARCHITECT: Conifer & Willis, Oakland. GENERAL CONTRACTOR: Stolte, Inc., Oakland.

**TELEPHONE BLDG.**, El Centro, Pacific Tel. & Tel., Los Angeles, owner. 2-Story reinforced concrete, with alternate architectural concrete or masonry walls, composition roofing, slab and asphalt tile floor, terrazzo work, plaster interior, metal sash, insulation, acoustical work, heating and air conditioning, electrical, 45,000 sq. ft., \$600,000. ARCHITECT: A. J. Ribbe,

Los Angeles. GENERAL CONTRACTOR: Louis C. Dunn Co., Los Angeles.

**STEEL BLEACHERS**, San Juan High School, Sacramento County. San Juan Union High School District, Sacramento, owner. Erection of steel bleachers at high school athletic field, \$19,278. ARCHITECT: Chas. F. Dean, Sacramento. GENERAL CONTRACTOR: Fred J. Chapek, Sacramento.

**ELEMENTARY SCHOOL**, Woodland, Yolo County, Woodland Elementary School District, Woodland, owner. Frame and concrete floor covered with asphalt tile; radiant heating, steel sash, acoustical ceilings; 5 classrooms, kindergarten, teachers room,

toilets, \$91,928. ARCHITECT: Russell G. deLappe & Mitchel Van Bourg, Berkeley. GENERAL CONTRACTOR: Jay Bailey Construction Co., Woodland.

**SOCIAL HALL**, Sacramento. El Camino Community Church, Sacramento, owner. 1-Story frame and stucco social hall and Sunday School, \$45,000. ARCHITECT: Chas. F. Dean, Sacramento. GENERAL CONTRACTOR: John Knapp, Sacramento.

**OFFICE & WAREHOUSE**, San Francisco. Minnesota Mining & Mfg. Co., San Francisco, owner. 1-story, reinforced concrete, wood roof, 10,000 sq. ft. in office and 30,000 sq. ft. in warehouse, \$400,000. STRUCTURAL ENGINEER: J. Y. Long Co., Oakland. GENERAL CONTRACTOR: Van Bickelen-Cole Co., Oakland.

**ELEMENTARY SCHOOL**, Crescent City, Del Norte County. Pine Grove Elementary School District, Crescent City, owner. Frame construction, 7 classrooms, administration,



multi-purpose, kindergarten, kitchen, toilets, \$299,217. ARCHITECT: Ernest F. Winkle, San Francisco. GENERAL CONTRACTOR: Glover Bros., Santa Rosa.

**SHOP BLDG.**, Whittier, Alaska. Alaska District Corps of Engineers, Seattle, Washington, owner. Construction comprises composite shop building, \$1,236,440. GENERAL CONTRACTOR: J. H. Pomeroy & Co., San Francisco, Calif.

**CHURCH ADDN.**, San Pedro, Los Angeles County. First Presbyterian Church, San Pedro, owner. 1-Story masonry addition, composition roofing, concrete floor, wood studs and plastering, metal sash, painting,

plastering, plumbing, electrical work, 9000 sq. ft., \$102,000. ARCHITECT: Armet & Davis, Los Angeles. GENERAL CONTRACTOR: F. Olson, Los Angeles.

**PUBLIC GARAGE**, Reno, Nevada. Harold's Club, Reno, owner. 3-story reinforced steel and concrete structure with 6 parking tiers for automobiles, \$300,000. PLANS BY GENERAL CONTRACTOR: Pigeonhole Parking Company of California, Los Angeles.

**FACTORY & OFFICE**, Whittier, Los Angeles County. Union Die Casting Co., Vernon, owner. 1-Story, tilt-up precast concrete factory and 1-Story masonry office; composition roofing, wood frame roof, metal

sash, concrete floor, laminated wood trusses, space heaters, air conditioning in office, conveyors, bridge cranes, paving, fencing, 46,800 sq. ft. in factory, 3405 sq. ft. office. ARCHITECT: Stiles Clements, Associated Architects and Engineers, Los Angeles. GENERAL CONTRACTOR: George W. Carter Co., Los Angeles.

**EIGHT BUILDINGS**, Richland, Washington. Atomic Energy Commission, Engineering and Construction Division, Richland, Washington, owner. Largest of 8 buildings will be 1-Story administration 20x60 ft.; 2 others will be 17x56 ft. and 12x50 ft.; steel frame with asbestos-cement corrugated siding,

## BUILDING TRADES WAGE (JOB SITES) NORTHERN, CENTRAL AND SOUTHERN CALIFORNIA

ATTENTION: The following are the PREVAILING hourly rates of compensation being paid and in effect by employers by agreement between employees and their union; or as recognized and determined by the U. S. Department of Labor. (Dec. 1, 1953.)

CRAFT	San Francisco	Alameda	Contra Costa	Fresno	Sacramento	San Joaquin	Santa Clara	Solano	Los Angeles	San Bernardino	San Diego	Santa Barbara	Kern
ASBESTOS WORKERS	\$3.05	\$3.05	\$3.05	\$3.05	\$3.05	\$3.05	\$3.05	\$3.05	\$2.25	\$2.25	\$2.25	\$2.25	\$2.25
BOILERMAKERS	2.68	2.68	2.68	2.68	2.68	2.68	2.68	2.68	3.175	3.175	3.175	3.175	3.175
BRICKLAYERS	3.40	3.45	3.45	3.40	3.40	3.40	3.40	3.40	1.94	1.94	1.94	1.94	1.94
BRICKLAYERS, HODCARRIERS	2.45	2.45	2.45	2.00	2.40	2.25	2.45	2.45	2.70	2.70	2.70	2.70	2.70
CARPENTERS	2.70	2.70	2.70	2.70	2.70	2.70	2.70	2.70	2.70	2.70	2.70	2.70	2.70
CEMENT FINISHERS	2.67	2.67	2.67	2.67	2.67	2.67	2.67	2.67	2.70	2.70	2.70	2.70	2.70
CONCRETE MIXER—Skip Type (1-yd.)	2.38	2.38	2.38	2.38	2.38	2.38	2.38	2.38	2.50	2.50	2.50	2.50	2.50
ELECTRICIANS	3.00	3.00	3.00	3.00	3.00	3.00	3.00	3.00	3.10	3.10	3.10	3.10	3.10
ELEVATOR CONSTRUCTORS	2.75	2.70	2.65	2.75	2.915	2.915	2.915	2.915	2.25	2.25	2.25	2.25	2.25
ENGINEERS: MATERIAL HOIST	2.56	2.56	2.56	2.56	2.56	2.56	2.56	2.56	1.9875	1.9875	1.9875	1.9875	1.9875
GLAZIERS	2.55	2.55	2.55	2.55	2.55	2.53	2.53	2.53	2.395	2.395	2.395	2.395	2.395
IRONWORKERS: ORNAMENTAL	2.85	2.85	2.85	2.85	2.85	2.85	2.85	2.85	3.00	3.00	3.00	3.00	3.00
REFIN. STREET	*2.75	2.75	2.75	2.75	2.75	2.75	2.75	2.75	2.74	2.74	2.74	2.74	2.74
STRUCTURAL STEEL	3.00	3.00	3.00	3.00	3.00	3.00	3.00	3.00	3.00	3.00	3.00	3.00	3.00
LABORERS: BUILDING	2.00	2.00	2.00	2.00	2.00	2.00	2.00	2.00	2.05	2.05	2.05	2.05	2.05
CONCRETE	2.00	2.00	2.00	2.00	2.00	2.00	2.00	2.00	2.05	2.05	2.05	2.05	2.05
LATHERS	3.35	3.35	3.35	3.35	3.35	3.35	3.35	3.35	3.175	3.175	3.175	3.175	3.175
MARBLE SETTERS	2.95	2.95	2.95	2.95	2.95	2.95	2.95	2.95	2.875	2.875	2.875	2.875	2.875
MOSAIC & TERRAZZO	2.76	2.76	2.76	2.76	2.76	2.76	2.76	2.76	2.40	2.40	2.40	2.40	2.40
PAINTERS—BRUSH	**2.70	2.70	2.70	2.70	2.725	2.53	2.70	2.37	2.66	2.60	2.64	2.32	2.32
PAINTER—SPRAY	2.83	2.83	2.83	2.83	2.91	2.55	2.91	2.88	2.68	2.68	2.68	2.68	2.68
PILEDRIVERS—OPERATOR	3.27	3.165	3.165	3.00	3.00	3.00	3.00	3.00	3.125	2.88	3.125	3.125	2.88
PLASTERERS	2.85	2.85	2.85	2.85	2.85	2.85	2.85	2.85	2.875	2.25	2.30	2.00	2.00
PLASTERERS, HODCARRIERS	3.125	3.125	3.125	3.125	3.125	3.125	3.125	3.125	3.125	3.125	3.125	3.125	3.125
PLUMBERS—STEAM FITTERS	2.75	2.75	2.75	2.50	2.75	2.75	2.75	2.75	2.65	2.00	1.90	2.00	2.00
ROOFERS	2.85	2.85	3.125	2.43	2.75	2.50	2.40	2.415	2.625	2.625	2.25	2.25	2.25
SHEET METAL WORKERS	2.75	2.70	2.70	2.625	2.625	2.625	2.75	2.75	2.90	2.90	2.90	2.90	2.90
SPRINKLER FITTERS	2.75	2.90	2.90	2.75	2.625	2.625	2.75	2.75	2.77	2.77	2.77	2.77	2.77
STEAMFITTERS	2.77	2.77	2.77	2.77	2.77	2.77	2.77	2.77	2.45	2.45	2.45	2.45	2.45
TRACTOR OPERATOR	1.99	1.99	1.99	1.99	1.99	1.99	1.99	1.99	2.13	2.13	2.13	2.13	2.13
TUCK DRIVERS—1/2 Ton or less	3.00	3.00	3.00	3.00	3.00	3.00	3.00	3.00	2.65	2.65	2.65	2.65	2.65
TILESETTERS													

\* 6 Hour Day. \*\* 7 Hour Day. \*\*\* Before C.I.S.C for 15c increase.

Prepared and compiled by:

CENTRAL CALIFORNIA CHAPTER, ASSOCIATED GENERAL CONTRACTORS OF AMERICA, with the assistance and cooperation of secretaries of General Contractors Associations and Builders Exchanges of Northern California; and the above information for southern California is furnished by the Labor Relations Department of the Southern California Chapter, ASSOCIATED GENERAL CONTRACTORS OF AMERICA.

# CLASSIFIED ADVERTISING

RATE: 20c PER WORD . . . CASH WITH ORDER

MINIMUM \$5.00

**YOUNG MAN SEEKS OPPORTUNITY**—Young man with good background in the construction industry, seeks opportunity with Contractor. Primary consideration chance to advance to executive position in future. College graduate. INQUIRE, Box 521, ARCHITECT & ENGINEER magazine, 68 Post St., San Francisco.

**ARCHITECTURAL SLIDING SLEEVE SASH.** One lot only — new, half price. 13 units, assorted sizes, 353 square feet total. 3 at 7 ft. x 5 ft.; 4 at 7 ft. x 4 1/2 ft.; 1 at 6 ft. x 4 1/2 ft.; 2 at 6 ft. x 4 ft.; 1 at 7 ft. x 3 1/2 ft.; 1 at 4 1/2 ft. x 3 ft.; 1 at 3 ft. x 3 ft. Phone Delaware 3-7378, San Francisco.

**COLLECTIONS**—Thoroughly experienced in all phases of the collection business; your interests protected at all times; bonded agents everywhere; no collection no charge; California Material Dealers Service Co., 925 Hearst Bldg., San Francisco. Ernest T. Langley, Manager.

**BUILDERS!** You can make more money; get information you need before it is published elsewhere; Subscribe to the daily ARCHITECTS REPORTS, only \$10.00 per month. Complete information from ARCHITECTS REPORTS, 68 Post Street, San Francisco. Phone DOuglas 2-8311.

**PHOTOGRAPHY.** For the best in construction photography, including exterior and

interior, aerial, and progress views . . . you will find as many others have that it's the SKELTON STUDIOS, 875 O'Farrell St., San Francisco. Telephone PROspect 6-1841.

**REGISTERED ARCHITECT**, residential and commercial, 18 years experience, seeks association with medium sized firm. Independent work, design, specifications, supervision, client contact. Write BOX 5F, Architect & Engineer, 68 Post Street, San Francisco, California.

**HOME BUYERS**—Now building moderate priced homes in Sacramento and Marysville area; we are in a position to serve your needs. "Better Built Homes" by Ronna, Ronna & Ronna, Builders, 520 9th Street, Sacramento.

concrete floors; 3 other buildings will be similar monitoring, 8 ft. sq.; guard house 15x14 ft., \$545,100. GENERAL CONTRACTOR: L. H. Hoffman, Portland, Oregon.

**CHURCH.** Los Angeles. Lutheran Church of Our Redeemer, Los Angeles, owner. Frame, single tile roofing, laminated wood trusses, concrete work, stone work, asphalt tile and carpeting; painting, plastering, plumbing, electrical work, forced air heating, 95x45 ft., \$76,830. ARCHITECT: Chaix & Johnson, Los Angeles. GENERAL CONTRACTOR: Samuelson Bros., La Canada.

**BOTTLING PLANT.** San Pedro, Los Angeles County. H. W. Levitt, Los Angeles, owner. Concrete, composition roofing, concrete slab floors, asphalt tile flooring, steel sash, reinforcing steel, toilets, vault, acoustical and ceramic tile, skylights, gas heating, locker room, \$70,000. ENGINEER: C. F. Knowlton, Los Angeles. GENERAL CONTRACTOR: Russell J. Baingo, Los Angeles.

**HOSPITAL REMODEL.** San Francisco. University of California, Berkeley, owner. Remodel of the U. C. Hospital in San Francisco (interior), \$100,000. ARCHITECT: John Funk, San Francisco. GENERAL CONTRACTOR: Erbenbraut & Summers, San Francisco.

**CHURCH ADDITION.** Carmel, Monterey county. 1st Church of Christ Scientist, Carmel, owner. Single story adobe brick and wood frame construction, \$104,627. ARCHITECT: Robert R. Jones, Carmel. GENERAL CONTRACTOR: Harold G. Geyer, Monterey.

**HIGH SCHOOL ADD'N.,** Clovis, Fresno County. Clovis Union High School District, Clovis, owner. Frame and stucco, gymna-

sium, reinforced concrete frame; 13 classrooms, music room, and additions to shop, gymnasium and shower and locker building, and toilet rooms, \$524,000. ARCHITECT: Wm. Hatrup, Fresno. GENERAL CONTRACTOR: Clarence Ward Construction Co., Fresno.

**PAROCHIAL SCHOOL.** Healdsburg, Sonoma county. Roman Catholic Archbishop of San Francisco, San Francisco, owner. 4-Classroom and toilet room addition to the St. Johns School, frame and stucco, \$66,880. ARCHITECT: Clarence Felciano, Santa Rosa. GENERAL CONTRACTOR: Frank Towle, Healdsburg.

**PUBLIC GARAGE.** Alhambra, Los Angeles County. Joe Terella, Alhambra, owner. 1-Story concrete block, built-up composition roofing, steel sash, concrete slab floor, electrical work, toilet rooms, 35x30 ft. ARCHITECT: R. L. Wilson, Los Angeles. GENERAL CONTRACTOR: Foss Construction Co., Pasadena.

**HIGH SCHOOL ADDITION.** San Carlos, San Mateo County. Sequoia Union High School District, Redwood City, owner. Reinforced concrete and frame, structural steel roof trusses, addition to the Carlmont High School, \$599,706. ARCHITECT: Frank Wynkoop & Associates, Carmel. GENERAL CONTRACTOR: E. A. Hathaway & Co., San Jose.

**NEWSPAPER BLDG.,** Visalia, Tulare County. Times-Delta Publishing Company, Visalia, owner. 1-Story brick and structural steel addition to present building, concrete floors, \$22,530. ARCHITECT: Lloyd J. Fletcher, Visalia. GENERAL CONTRACTOR: Perry & Wilson, Visalia.

**MORTUARY ADD'N.,** Los Gatos, Santa Clara County. Place Funeral Home, Los Gatos, owner. 1-Story, basement, concrete block and frame, 26x40 ft., \$24,363. ARCHITECT: Clifford E. Sobey, Los Gatos. GENERAL CONTRACTOR: Knopf Bros., Los Gatos.

**JUNIOR & SENIOR HIGH SCHOOL.** Paradise, Butte county. Paradise Unified School District, Paradise, owner. Frame and stucco, reinforced concrete, classrooms, administration, toilets, and utility area, \$538,100. ARCHITECT: Koblik & Fisher, Sacramento. GENERAL CONTRACTOR: B. & R. Construction Co., San Francisco.

**FACTORY & OFFICE.** Sunnyvale, Santa Clara county. Personal Products Corp., Milltown, N. J., owner. 1-Story combination factory and office building, reinforced concrete fill-up, structural steel frame, wood roof, 200x240 ft., \$750,000. ARCHITECT: Ward & Bolles, San Francisco. GENERAL CONTRACTOR: Hilp & Rhodes, San Francisco.

**SERVICE BLDG.,** Bakersfield, Kern County. County of Kern, Bakersfield, owner. Removing faced brick of Kern County General Hospital; gutting exterior walls, tile roof, heating and air conditioning, some structural steel, new incinerator and new shop building 50x80 ft. of reinforced concrete, \$17,579. ARCHITECT: C. B. Altord & W. J. Thomas Associates, Bakersfield. GENERAL CONTRACTOR: Stalte Inc., Bakersfield.

**EXPERIMENTAL LABORATORY BLDG.,** Richland, Washington. Atomic Energy Commission, Richland, owner. New experimental building at the Hanford Works known as

positive ion accelerator; 1-story, part reinforced concrete and part frame, concrete floors, 70x30 ft., \$58,284. GENERAL CONTRACTOR: Lewis Hopkins Co., Yakima, Washington.

**OFFICE BLDG.,** Bakersfield, Kern county. National Auto Club, Bakersfield, owner. Concrete block construction, composition roof, concrete and vinyl tile floors, forced-air heat, air conditioning, glass blocks, plaster, plate glass, steel sash, 15x40 ft., \$14,640. ARCHITECT: Wright, Metcalf & Parsons, Bakersfield. GENERAL CONTRACTOR: Kenneth Wheeler, Bakersfield.

**COUNTY HOSPITAL ADDN.** Redding, Shasta county. Shasta County, Redding, owner. One-story and basement, reinforced concrete, steel sash, composition roofing, linoleum floors, 50 beds, \$352,621. ARCHITECT: E. Geoffrey Bangs, San Francisco. GENERAL CONTRACTOR: Stalte, Inc., Oakland.

**COUNTY OFFICE BLDG.,** Watsonville, Santa Cruz county. Santa Cruz County, Santa Cruz, owner. One-story frame and stucco construction with shake roof, vinylite tile floors, \$139,105. ARCHITECT: John I. Easterly, Watsonville. GENERAL CONTRACTOR: T. H. Rosewall, Watsonville.

**GYM & SWIMMING POOL.** Atherton, San Mateo county. Sequoia Union High School District, Redwood City, owner. Reinforced concrete and concrete block construction, \$377,500. ARCHITECT: Arthur D. Janssen, Menlo Park. GENERAL CONTRACTOR: Bogdanich Const. Co., Santa Clara.

**CHURCH,** San Francisco. Bethel Full Gospel Church, San Francisco, owner. Reinforced concrete, structural steel, aluminum sash, some electrical work, \$87,950. ARCHITECT: Kitchen & Hunt, San Francisco. GENERAL CONTRACTOR: Jacks & Irvine, San Francisco.

**GEOPHYSICS BLDG.,** Stanford University, Santa Clara county. Board of Trustees of Stanford University, Palo Alto, owner. One-story, reinforced concrete geophysics laboratory building, \$44,385. ARCHITECT: Spencer & Ambrose, San Francisco. GENERAL CONTRACTOR: Wagner & Martinez, San Francisco.

**SHOP BLDG.,** San Leandro, Alameda county. Aladdin Heating Corp., Oakland, owner. 1-story structural steel frame, wood and corrugated steel exteriors, steel sash, concrete floors; 57,000 sq. ft.; 21,000 sq. ft. concrete slab outside building, \$192,000. STRUCTURAL ENGINEER: J. Y. Long Co., Oakland. GENERAL CONTRACTOR: Beckett & Federighi, Oakland.

**MOTEL,** San Francisco. Barney Norwitz, owner. 2-story class 1 construction, \$149,750. ARCHITECT: Jennings & McClure, San Francisco. GENERAL CONTRACTOR: Associated Construction & Engineering Co., San Francisco.

**KINDERGARTEN,** Fortuna, Humboldt county. Fortuna Elementary School District, Fortuna, owner. Single story frame construction, \$58,490. ARCHITECT: Masten & Hurd, San Francisco. GENERAL CONTRACTOR: R. H. Douglas, Fortuna.

**PARISH HALL.** San Jose, Santa Clara County. St. Fran. de Episcopal Church, San Jose, owner. 1-Story frame and stucco, adobe & shingle roof, laminated ar-les, steel sash, concrete floor, radiant heating, asphalt tile

## SLEEPERS

**UNI-BOND—PRECAST—  
PERMANENT—NEVER ROT—  
PERMANENTLY  
NAIL PENETRABLE  
FIRE PROOF  
SECURELY BONDED TO  
THE CONCRETE SLAB**

**Make Solid Non-Squeaking  
Permanent Wood Flooring**

Used in spring floor construction for  
Gymnasiums and dance floors, also  
under solid wood floor construction.  
Spaced on any centers desired. Specifi-  
cations and information available on  
request.

Territories open for qualified repre-  
sentatives. Free consultation service.

**LeROY OLSON  
COMPANY**

3070 Seventeenth Street,  
San Francisco, California

floors, Parish hall and kitchen, \$44,395. ARCHITECT: Higgins & Root, San Jose. GENERAL CONTRACTOR: Alken Construction Co., San Jose.

**PRIMARY SCHOOL.** Yreka, Siskiyou County, Yreka Union Elementary School District, Yreka, owner. Frame and stucco, 4 classrooms, administration, toilets, \$60,139. ARCHITECT: Clayton Kantz, Redding. GENERAL CONTRACTOR: Ausland & Dodson, Ashland, Oregon.

**LIBRARY.** San Francisco. City and County of San Francisco, owner. 1-Story reinforced concrete and brick veneer construction, \$154,300. ARCHITECT: Appleton & Wolford, San Francisco. GENERAL CONTRACTOR: William Horstmeier Co., San Francisco.

## IN THE NEWS

### STATE OFFICE BUILDING

The State of California announced plans for the construction of a new State Office Building to be built in San Francisco on Golden Gate Avenue, between Palk and Larkin, at an estimated cost of \$4,500,000.

The structure will be 6-stories in height, will be of structural steel frame and reinforced concrete construction and will contain a basement.

### CHURCH, RIVERSIDE

The Trinity Evangelical Lutheran Church in Riverside recently commissioned the architectural firm of Orr, Strange & Inslee of Los Angeles, to draw plans and specifications for the construction of a new masonry church in Riverside.

The building will comprise 250,000 cu. ft., will have composition roof, steel frame, concrete slab floors and asphalt tile covering, steel sash, toilets, forced air heating and ventilating, tile roof and asphalt paving.

### ARCHITECT SELECTED

John W. Bomberger, architect of Modesto, has been selected by the Board of the Rising Sun Joint School District of Vernalis, Stanislaus county, to draw plans for the construction of an addition to the Elementary School.

The addition will include 4 classrooms, multi-purpose, kitchen and toilet rooms.

### MEN'S RESIDENCE HALL STANFORD UNIVERSITY

Construction of eight 3-story dormitory buildings, together with an administration building, kitchen and dining room building with connecting corridors and lounges, will be started on the Stanford University campus in the immediate future, according to an announcement by the Stanford Board of Trustees.

The buildings will be of reinforced concrete construction and the project will cost an estimated \$2,750,000.

Spencer & Ambrose of San Francisco, are the architects.

### NEW APARTMENT FOR PHOENIX

A \$500,000 City of Phoenix, Arizona, building permit has been issued to Park Central Development Company for the construction of 95-units of one bedroom apartments which are expected to cost \$1,000,000 when completed.

They will be known as Park Central Terrace Apartments, and will be built on the east side of 7th Avenue at Avalon in Phoenix.

### PRE-WIRED LIGHTING SYSTEM SAVES TIME

Silvray Skylite, a complete factory pre-wired and pre-assembly unit for recessed lighting systems; can be installed in 4 time saving steps.



Installer nails, or wires, frame in ceiling opening, connects service conduit to outlet, locks socket screws to reflector in special key-hole slots and engages unit mounting screws to frame. Beautifully styled in smart, contemporary louvered design, finished in baked enamel; unit or multiple installation.

Unit is fully approved by Underwriters' Laboratories; manufactured by SMOOT-HOLMAN Co., Inglewood, California.

### ARCHITECT SELECTED

The architectural firm of Corlett & Anderson, Oakland, has been commissioned by

the County of Alameda to draft plans for the construction of an Out-patient Clinic Building to become a part of the Highland Hospital in Oakland.

Estimated cost of the project is \$1,500,000.

### PROMINENT EUREKA ARCHITECT DIES

Franklin T. Georgeson, 64, one of Northern California's well and popularly known architects, died at his home in Eureka, California, the latter part of October.

Born in San Francisco, Georgeson moved to Eureka as a child, and established an office for the practice of architecture more than forty years ago, following graduation from the University of California.

His better known works include the Christian Science Church, Eureka; St. Josephs Hospital, Eureka; Santa Rosa Memorial Hospital, Santa Rosa; Oxnard Hospital, Oxnard, California; the O'Connor Hospital in San Jose; and at the time of his death was working on the Merch Hospital of Bakersfield, and additions to the St. Francis and St. Mary's Hospitals in San Francisco.

A veteran of World War I, Georgeson was active in civic and fraternal affairs of Eureka.

### ODD FELLOWS BUILDING

The Odd Fellows Hall Association of Gilroy, Santa Clara county, have announced plans for the construction of a new Office and Lodge Building to be built in Gilroy at a cost of \$90,000.

The new building will be 2-story, reinforced concrete and frame and will contain

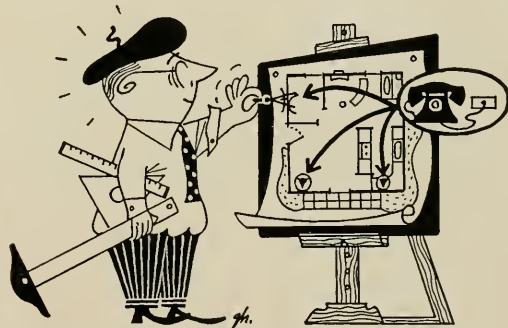

## Don't forget the 'master' touch of built-in telephone facilities

Your clients will appreciate the idea of concealed wiring and neat telephone outlets conveniently located to take care of their present and future telephone installations and changes. Wise home-owners today know the advantages of low-in-cost, high-in-satisfaction planned telephone facilities.

Just call Pacific Telephone's free Architects and Builders service. We'll gladly help you plan telephone facilities for greater beauty tomorrow in homes you are building today.

Put built-in telephone facilities in your plans



Pacific Telephone



tain 12,000 sq. ft. Lodge offices will be on the first floor with lodge facilities occupying the second floor.

O. B. Christensen of Santa Clara, is the architect.

#### PROFESSIONAL BUILDING

Architect Paul C. Shattuck of Merced is working on preliminary drawings for a Professional Building to be erected in the City of Merced at an estimated cost of \$125,000.

The new building will be 2-story in height; frame and stucco.

#### APARTMENT BUILDING FOR SAN FRANCISCO

Theo. G. Meyer & Sons have announced plans for the construction of a 12-story Apartment Building at the corner of Clay and Jones streets in San Francisco.

Cost of the new building is estimated at \$1,000,000.

H. C. Baumann, San Francisco, is the architect.

#### JAMES A. WHITE APPOINTED

James A. White has been appointed sales representative of the Calaveras Cement Company for Stanislaus, Merced and Mariposa counties in California according to an announcement by Mel J. London, vice-president and general sales manager.

White has established headquarters in Modesto.

#### SCHOOL BONDS APPROVED

Electors of the Brentwood Union Elementary School District, Brentwood, recently

approved the issuance of \$100,000 in School Bonds for the purpose of constructing an addition to the Edna Hill Elementary School.

The addition will be of frame and stucco construction.

#### OFFICE AND FACTORY

H. M. O'Neil, Structural Engineer of Oakland, is working on a combination office and factory building to be built in San Leandro for the Electric Engraving Works.

The combination building will be of 1-story tilt-up concrete construction with wood roof and will contain 20,000 sq. ft. Estimated cost is \$125,000.

#### LARGE CALIFORNIA OFFICE BUILDING

The State of California has appropriated funds for the construction of a new office building to be built in the City of Sacramento.

The new building will house the State's Employment Department and will be 2-blocks long; steel frame and reinforced concrete construction, and will contain 500,000 sq. ft. of floor space.

More than \$9,500,000 has been appropriated for cost of construction.

#### APPOINTED SALES MANAGER

R. T. Miller has been appointed Manager of Sales of Hardboard Products of the Weyerhaeuser Sales Company, St. Paul, Minnesota, according to R. S. Douglas, vice-president and general manager of the organization.

Miller will head a new activity of the firm consisting of marketing products of a

new plant being constructed at Klamath Falls, Oregon, although his headquarters will be in St. Paul.

Prior to becoming associated with Weyerhaeuser, Miller was with the Simpson Logging Company, and before that with the Masonite Corporation of Chicago.

#### POST OFFICE ANNEX

The U. S. Post Office Department will construct an annex to the present Post Office building in San Mateo, according to plans announced by the architectural firm of Sharps & Brown of San Mateo.

The Annex will be 1-story, reinforced tilt-up concrete construction with wood roof.

#### SCHOOL BONDS APPROVED

Voters of the Martinez Elementary School District, Contra Costa county, approved a \$532,000 School Bond issue at a special election.

Funds of the bond issue are to be used in the construction of a new Elementary School and to add to present school facilities in the City of Martinez.

#### HARRY J. WILLIAMS PROMOTED BY U. S. STEEL

Harry J. Williams has been appointed Director of Public Relations for the Western District of the U. S. Steel Corp., according to an announcement by J. Carlisle MacDonald, assistant to the chairman of the Board.

The Western District headquarters are in San Francisco.

#### HOSPITAL BONDS APPROVED

Electors of the Antelope Valley Hospital District, Palmdale, California, approved a proposal to issue \$300,000 in bonds to finance a portion of the construction of a new hospital for the district.

#### STANDARD OIL ENLARGES PLANT

A \$30,000,000 refinery program designed to increase substantially the quality and octane rating of motor gasolines will include the construction of one large catalytic reformer at the Richmond, California, plant according to an announcement by T. S. Petersen, president of Standard Oil Company of California.

Another similar reformer will be built at the company's El Segundo plant in Southern California. Construction of the two new units will start immediately.

#### ROBERT W. HUNT CO. ADDRESS CHANGE

The Robert W. Hunt Company, inspection and testing laboratory, has moved into new and larger quarters at 500 Iowa Street, San Francisco.

The firm's office was formerly located at 251 Kearny Street. Other offices are maintained in Los Angeles, Portland and Seattle.

#### NEW HIGH SCHOOL FOR LAS VEGAS

A new Senior High School will be built in Las Vegas, Nevada, for the Las Vegas Union School District, according to Claud Beelman, architect and engineer.

The building will be 1-story concrete block, 125,000 sq. ft.; steel beams and columns, insulated roof deck, concrete slab, hardwood and asphalt tile floors, steam heating, evaporative cooling, acoustic tile ceilings, toilets, lockers and gymnasium

## VALUABLE NEWS SERVICE

- BUILDING MATERIAL DEALERS
- CONTRACTORS
- SUB-CONTRACTORS
- MANUFACTURERS AND REPRESENTATIVES

**ARCHITECTS REPORTS** gives advance news on construction projects in Northern California, lists: name of projects, location, architect, proposed cost and other pertinent information.

**HANDY** individual slip-reports, issued daily at a total cost of only

\$10 a month

## ARCHITECT'S REPORTS

Published Daily

The ARCHITECT and ENGINEER, Inc.

68 Post Street, San Francisco - DO 2-8311

# CLASSIFIED ADVERTISING

Will Bring Results

—USE—

## ARCHITECT and ENGINEER

68 Post St. San Francisco

## MULLEN MFG. COMPANY

BANK, STORE AND OFFICE  
FIXTURES—CABINET WORK  
OF GUARANTEED QUALITY  
CHURCH SEATING

Office and Factory

60-80 RAUSCH ST., Bet. 7th and 8th Sts.  
San Francisco

Telephone UNderhill 1-5815

## E. H. MOORE & SONS

GENERAL  
CONTRACTORS



693 MISSION STREET  
SAN FRANCISCO

with folding bleachers seating 3000.

Robert E. Langdon and Ernest C. Wilson  
are Associate Architects, and Brandow &  
Johnston of Los Angeles are the engineers.

### NEW KNOCKED-DOWN STEEL DOOR FRAME

This new steel door frame is designed to  
conserve valuable storage space and cut  
down on costs; is shipped from factory in  
4 pieces, 2 jambs, head and spreader bar;  
easy to assemble using a simple tab con-  
nection and 4 sheet metal screws. Spreader  
bar is used to keep frame in alignment.



Steelcraft knocked-down door frames are  
manufactured in all standard sizes, bond-  
erized and painted with a baked-on grey  
primer. They are available through all  
regular STEELCRAFT distributors.

### NEW COUNTY HOSPITAL

Architect Albert W. Kahl of San Mateo is  
working on plans and specifications for the  
construction of a 20-Bed Hospital building  
for the County of Tehama, California.

Estimated cost of the project is \$100,000.

### APPOINTED DISTRIBUTOR

The Air Filter Sales & Service Co., Inc.,  
San Francisco, has been appointed North-  
ern California sales and service representa-  
tive for the Farr Company of Los Angeles,  
according to J. D. McCampbell, Farr sales  
manager.

### SCHOOL BONDS APPROVED

Voters of the Rockford Elementary School  
District, Porterville, California, recently ap-  
proved issuance of \$55,000 in school bonds  
for the construction of a 6 classroom, admin-  
istration and kitchen, addition to the Ele-  
mentary School. A State Aid of \$200,000  
has also been secured.

### PACIFIC CLAY PRODUCTS BUILDING LABORATORY

A new \$100,000 research laboratory is  
being constructed in Los Nietos, Califor-  
nia, for Pacific Clay Products, according to  
a recent announcement by John D.  
Fredericks, president.

Studies will be conducted to improve the  
firm's products and to reduce manufac-  
turing costs.

It was also announced that Meredith C.  
Brown, formerly director of Research and  
Development, has been appointed Vice-  
president in charge of Research and De-  
velopment. Brown will head the research  
activities in the new laboratory.

Subscribe  
Now —

## ARCHITECT and ENGINEER

\$3.00  
Per Year

## DINWIDDIE CONSTRUCTION COMPANY

## BUILDERS

CROCKER BUILDING  
SAN FRANCISCO



## HERRICK IRON WORKS

STRUCTURAL STEEL  
REINFORCING STEEL

18TH AND CAMPBELL STS.  
OAKLAND, CALIF.  
Phone GLencourt 1-1767

Phone GARfield 1-1164

## Thomas B. Hunter

DESIGNER OF HEATING

AIR CONDITIONING  
VENTILATING AND WIRING  
SYSTEMS, MECHANICAL  
AND ELECTRICAL EQUIP-  
MENT OF BUILDINGS

★  
41 SUTTER STREET  
ROOM 710

San Francisco

California

*Fine*  
**ENGRAVINGS**

**POOR  
RICHARD**

PHOTO ENGRAVING CO.  
320-324 COMMERCIAL STREET  
SAN FRANCISCO, CALIF.

# ARCHITECT and ENGINEER

Please enter my subscription for  
..... year..... My check in the  
amount of \$..... is attached.  
1 year . . . . \$3.00  
2 years . . . . 5.00

Name.....  
City.....  
State.....

## ABBOT A. HANKS, INC. Engineers & Chemists

INSPECTING — TESTING — CONSULTING  
CONCRETE • STEEL • MATERIALS  
CHEMICAL AND TESTING  
LABORATORIES  
• RESEARCH AND INVESTIGATION •  
TESTS OF STRUCTURAL MATERIALS  
DESIGN OF CONCRETE MIXES  
SHOP AND ERECTION INSPECTION OF  
STRUCTURES AND EQUIPMENT  
INVESTIGATION OF STRUCTURES  
AND MATERIALS  
TESTS AND INVESTIGATION OF  
FOUNDATION SOILS  
FIRE RESISTANCE AND INSULATION  
TESTS

624 Sacramento Street, San Francisco

## PITTSBURGH TESTING LABORATORY

### ENGINEERS AND CHEMISTS

Testing and Inspection of Concrete,  
Steel and Other Structural Materials

Design of Concrete Mixes

Offices in all principal cities

651 Howard St., San Francisco 5  
EXbrook 2-1747

## MATTOCK CONSTRUCTION COMPANY



### BUILDERS



604 MISSION STREET  
SAN FRANCISCO

## Index to Advertisers

ARCHITECTS Reports .....	46
BETTANCOURT, Jos. ....	35
CAMBRIDGE Tile Mfg. Company..... *	
CLAY Brick & Tile Association .....Inside Front Cover	
CLASSIFIED Advertising .....	43
CLINTON Construction Company ....	36
DINWIDDIE Construction Company ..	47
ERSKINE Geo. S. & Associates .....	*
FINK & SCHINDLER Co., The .....	34
FORDERER Cornice Works .....	35
GENERAL Chef .....	*
GLADDING, McBean & Company .....	*
GREENBERG'S M. Sons .....	32
HAAS & HAYNIE Const. Co. ....	36
HANKS, Abbott A., Inc. ....	48
HAWS Drinking Faucet Co. ....	28 & 29
HERRICK Iron Works .....	47
HOGAN Lumber Co. ....	36
HUNT, Robert W. Company .....	48
HUNTER Thos. B. ....	47
IDEAL Cement Co. .... Back Cover	
JOHNSON S. T. Co. .... *	
JUDSON, Pacific-Murphy Corp. ....	36
KRAFTILE Company .....	26
LoPREST, A. C., Co. ....	31
MARBLE Institute of America .....	*
MATTOCK Construction Co. ....	48
MICHEL & Pfeffer Iron Works, Inc. ....	3
MOORE, E. H. & Son .....	47
MULLEN Mfg. Co. ....	47
OLSON, LeRoy Co. ....	44
PACIFIC Coast Aggregates .....	27
PACIFIC Cut Stone & Granite Co. ....	34
PACIFIC Manufacturing Co. ....	37
PACIFIC Telephone & Telegraph Co. ....	45
PARKER, Steffens & Pearce .....	35
PITTSBURGH Testing Laboratory .....	48
POOR Richard Engraving Co. ....	47
PORCELAIN Enamel (Architectural Division) Publicity Bureau .....	31
REMILLARD-Dandini Co. ....	48
REPUBLIC Steel Corporation .....	37
SCOTT Company .....	48
SIMONDS Machinery Company .....	37
SMOOT-Holman Company .....	33
SUMMERBELL Roof Structure .....	33
U. S. Bricks .....	Inside Back Cover
VERMONT Marble Company .....	37
WEST Coast Screen Co. ....	38

\*Indicates Alternate Months

## ROBERT W. HUNT CO.

### ENGINEERS INSPECTING TESTING

### STRUCTURAL MATERIALS CONCRETE MIX DESIGN CHEMICAL ANALYSIS EQUIPMENT

PRINCIPAL CITIES  
UNITED STATES • EUROPE  
SAN FRANCISCO LOS ANGELES  
PORTLAND SEATTLE

## REMILLARD-DANDINI Co.

### Brick and Masonry Products



400 MONTGOMERY STREET  
SAN FRANCISCO, CALIF.

## Scott Company

### HEATING • PLUMBING REFRIGERATION



San Francisco  
Oakland  
San Jose  
Los Angeles

## FOR ADVANCE INFORMATION

### ON BUILDERS CONTRACTORS ENGINEERS

Get

## ARCHITECTS REPORTS

68 Post St. Phone  
San Francisco DO 2-8311



# ARCHITECT AND ENGINEER

## INDEX OF ARTICLES AND ILLUSTRATIONS

### VOLUMES 192 - 195 - 1953

A	Page	Issue
A. I. A. Activities .....	26	Jan.-Dec.
Airplane View of San Francisco .....	Cover	Nov.
Airport, Jet Aircraft, Planned by Australia Engineers, (John Loughlin) .....	23	Sept.
Airport, Jet Aircraft, Planned by Australia Eigneers (John Loughlin) .....	8	Oct.
Art, News & Comment .....	6	Jan.-Dec.

B	Page	Issue
Bank, of America, Sacramento Branch (L. J. Hendy) ..	23	Feb.
Bank, Citizens Natl. Trust & Savings, Westwood, LA (Stiles Clement) .....	Cover-8	March
Bank, Amer. Trust & Savings, San Bruno .....	20	Aug.
Bettancourt, J., Work of .....	16	Aug.
Book Reviews .....	36	Jan.-Dec.

C	Page	Issue
Church, First Presbyterian, Roseville, (Wm. Henry Rowe) .....	7	Dec.
Churches in the Modern Wood (A. W. Priaulx) .....	12	Dec.
Church, Fauntleroy Congregational, Seattle, (Robt. L. Durham & Associates) .....	12	Dec.
Church, Seventh Day Adventist, (Jones & Hunier) Boulder, Colo. ....	13	Dec.
Church, Lutheran Church of the Redeemer, Van Nuys, (John Fleming) .....	14	Dec.
Church, Queen of the Angels, Port Angeles, Wn., (John W. Maloney) .....	14	Dec.
Church, Holy Cross Lutheran, Portland (Jas. L. Payne) .....	15	Dec.
Church, Kern Park Christian, Portland (Donald W. Edmondson) .....	15	Dec.
Church, Trinity Baptist, Sta Monica, (Louis A. Gamble) .....	16	Dec.
Church, St. Philip Neri, Portland (Pietro Balluschi) ..	17	Dec.
Church, La Crescenta Methodist, (Frick & Frick) .....	18	Dec.
Church, Ar. Albert the Great, Compton (Chaix & Johnson) .....	19	Dec.
Church First Lutheran of Alhambra, (Culver Heaton) ..	20	Dec.
Church, Immanuel Christian, Ripon, (G. N. Hilburn) ..	21	Dec.
Church of the Brethren, Sacramento (Lloyd Osborne) ..	22	Dec.
Church, First Methodist, San Gabriel, (Quinton & Westberg) .....	23	Dec.

Page	Issue	
Church, St. John Evangelical, Portland (Kurt Schuett) .....	23	Dec.
Concrete Beam, Design of Reinforced, (W. D. Bigler) ..	24	Dec.
Classified Advertising .....	43	Jan.-Dec.
Concrete in Building .....	11	Aug.
Competition Ahead for the Building Industry .....	8	April
Competition, Winning Design—Concrete Masonry (Clark & Ennerson) .....	10	Oct.
Construction Contracts Awarded .....	44	Jan.-Dec.

E	Page	Issue
Editorial Notes .....	4	Jan.-Dec.
Earthquake Tests on Building Accelerations (Geo. Houser) .....	15	Oct.
Engineers, With the, .....	28	Jan.-Dec.
Engineers, Structural, Annual Meeting at Yosemite ..	23	Nov.
Estimators' Guide .....	39	Jan.-Dec.
Estimators' Directory .....	41	Jan.-Dec.

F	Page	Issue
Factory Building, Southern Calif. Gas, Van Nuys (Allison & Rible) .....	22	Feb.
Factory Building, Continental Can, Pittsburg, Calif. ...	24	May
Factory Building, Amer. Reinforced Paper Co., Tracy, (Wm. Corlett) .....	6	Sept.
Factory Building, M. Greenberg's Sons, San Francisco ..	15	Nov.

G	Page	Issue
Greenberg's Sons, M., Story of .....	14	Nov.
Ground Water Grade Slabs (C. LeRoy Olson) .....	3	July
Ground Water Grade Slabs (C. LeRoy Olson) .....	8	Aug.

H	Page	Issue
Highway Construction Dollar, How to Get the Most Out of it, (B. B. Armstrong) .....	6	Nov.-Dec.
Hospital, San Mateo County Sanitorium (Stone & Mulloy) .....	Cover-14	Feb.
Hospital, Pioneers Memorial, Mojave Desert (Walker, Kalionzes, & Klingman) .....	10	Feb.
Hospital, Veterans Adm., Omaha (Dr. Wm. Schweisheimer) .....	12	Feb.
Hospital, Veterans, Clarksburg, W. Va. ....	13	Feb.
Hospital, Veterans, Shreveport, La. ....	13	Feb.
Hospitals and Room Temperature (Darrell B. Harmon) ..	36	Feb.

## I

In the News (Edwin H. Wilder.....)	46	Jan.-Dec.
Investment Blueprint for Architects and Engineers (Frank Kihm) .....	27	Oct.
Investment Blueprint for Architects and Engineers (Frank Kihm) .....	25	Nov.-Dec.

## M

Motor Court, Town Chalet, Longview, Wn., (Laurence B. Rice) .....	12	March
--	----	-------

## O

Office Building, Jos. Bettancourt, San Bruno.....	17	Aug.
Office Building, New AIA Headquarters, San Francisco .....	8	Oct.
Office Building and Warehouse, Portland (Morgan H. Hartford) .....	20	Oct.

## P

Playground and Recreation Center, Golden Gate Oakland, (Reynolds & Chamberlain).....	7	March
Producers Council Page .....	30	Jan.-Dec.
Public Building, Calif. State Capitol, Sacramento— East Wing (Anson Boyd).....	25	April
Public Building, Calif. State Capitol, Sacramento..	11	Aug.
Public Building, Police Facilities, Los Angeles (Welton Beckett & J. E. Stanton).....	7	May
Public Building, City Hall, San Bruno (Henry Rowe)...	24	Aug.
Public Building, Post Office, First Drive-In, Los Angeles (Welton Beckett).....	8	June
Public Relations for Architects (Culver Heaton).....	3	March
Public Relations for Architects (Culver Heaton).....	7	April

## R

Residence, Nils B. Hult, Eugene, Ore. (Clare K. Hamlin) .....	12	Jan.
Residence, Ranch House Built in a Day, Columbia Basin .....	7	Jan.
Residence, Twin Peaks, San Francisco, (Bolton J. White) .....	8	Jan.
Residence, Australian Homes, (Geo. Farwell).....	20	Jan.
Residence, Bent to Fit the Site, Longview, Wm. A. W. Priaulx (A. C. Wollen).....	14	May
Residence, Jas. M. Marshall Farm House, Sacramento River Delta (W. R. Yelland) .....	20	May
Residence, C. B. Noyes, Berkeley, Marcia Lee (Kitchen & Hunt) .....	10	June
Residence, D. J. Shaw, Hillsborough .....	27	Aug.
Residence, Serran River, Lebanon, Ore. (Southwell & Drury) .....	16	Sept.
Residence, Leño Gattward, Paradise Cove, (Bruce Haeser) .....	11	Sept.
Residence, G. E. Young America Development, Seattle, Wn. (Boina McCool) .....	10	Nov.

## S

School Building, Greenbrae Elementary (Wm. Corlett) .....	20	April
School Building, Encinite Elem., Rosemead (Marsh, Smith & Powell).....	10	April
School, Adam Grwoth, Community Expansion, A. W. Priaulx, Eugene, (Clare K. Hamlin).....	12	April
School Building, Parkside Grade, Multnomah Co., Oregon (Annand & Boone) .....	10	May
School, Madison Elementary, Boise, Ida. (Anton Dropping & Victor N. Jones).....	14	June
School, Australia's New Tropic, Norman Bartlett.....	20	June
School, Bayview Elementary, San Pablo (Schmidts & Hardmann).....	Cover	Aug.
School, Hogan Jr. High, Vallejo (Harry J. Devine)....	19	Aug.
School, Elmer Lafayette, Vallejo, (Jos. J. Buchter)....	21	Aug.
School, Hillsborough Elementary (Kump & Falk).....	23	Aug.
School, Daves Ave., Los Gatos (John M. Evans).....	12	Nov.
Seminary, Golden Gate Baptist Theological, Marin County (John Carl Warnecke).....	10	Dec.
Store Building, Atkins, San Mateo (Burke, Boker & Nicolais) .....	18	March
Store Building, Foreman's, San Mateo, (Burke, Boker & Nicolais) .....	22	March
Store Building, Cadillac Agency, Stonestown, (Welton Beckett) .....	16	July
Store Building, Safeway, San Bruno, (Mathew Lehman) .....	23	Aug.
Store and Warehouse, Redwood City Groc. Co.....	25	Aug.
Store Building, Liberty House, Honolulu, (Burke, Kober & Nicalais) .....	25	Sept.
Store Building, Brocks Dept., Bakersfield (Robt. H. Eddy and C. M. Deasy).....	12	Oct.
Store Building, Barnard Motors, Portland Morgan H. Hartford) .....	17	Oct.
Swimming Pool, Residence, Woodside, (Gardner Dailey) .....	8	July
Swimming Pool, Municipal, Ferguson, Mo.....	6	July
Swimming Pool, Sands Hotel, Las Vegas (W. D. McAllister) .....	9	July
Swimming Pool, Rancho Rafael, Ignacio (Jno. M. McWilliams) .....	10	July
Swimming Pool, Municipal, La Mesa (Eggers & Faddis) .....	12	July

## T

Termite Infestation Prevention in Daves Ace. School, Los Gatos .....	12	Nov.
Title Exhibit at Oakland Home Show.....	27	June
Title in Patio, Techniques by Kraftite....	24	July

## W

Wage Scale, Building Trades .....	42	Jan. Dec.
Welded Structural Design, Don Wiltse .....	5	March





