







# ARCHITECT AND ENGINEER

PUBLIC LIBRARY

SEQUOIA HOSPITAL—Redwood City, California



PARKER, STEFFENS & PEARCE, General Contractor

**JANUARY**

**1951**

# A Daily Report Service

On building construction projects in Northern California.

The name of project, location, architect, proposed cost and other valuable news on building and construction projects in Northern California . . . at less than 1c per name.

Use the REPORTS to develop new customers.

Don't Delay—Subscribe Today!

Mailed to you daily at a flat rate of \$10 per month.

## ARCHITECTS REPORTS

DOuglas 2-8311

EXbrook 2-7182

Published DAILY by

ARCHITECT & ENGINEER, Inc.

68 Post Street

San Francisco, California

# ARCHITECT

Vol. 184

No. 1

AND

659414

# ENGINEER

ARCHITECTS' REPORTS—Published Daily

## Contents for

# JANUARY

**EDWIN H. WILDER**  
Editor

**MARK DANIELS, A.I.A.**  
Associate Editor

**J. WELLS HASTINGS**  
Contributing Editor

**PROF. LELAND VAUGHAN**  
Landscape Architecture

**JOHN A. BLUME**  
Structural Engineering

**MICHAEL GOODMAN**  
Planning

**JOHN S. BOLLES, A.I.A.**  
Book Reviews



### COVER PICTURE:

**NEW SEQUOIA HOSPITAL**  
Redwood City, California

Air view of the new 100 bed general hospital designed by architect Douglas Dacre Stone and Lou B. Mulloy and Silvio P. Marraccini, associate architect. It is the first hospital to be built in California under terms of the Federal hospital district act. (See complete story on page 12.)

Air Photo by  
Jon Howard Wells

*ARCHITECT & ENGINEER*  
*is indexed regularly by*

*ENGINEERING INDEX, INC.*

EDITORIAL NOTES	4
JOINT INFORMATION COMMITTEE	6
American Institute of Architects & Producers Council, Inc.	
URBAN TRAFFIC IMPROVEMENT, The Effect of Freeways and Expressways on Business and Property.	7
By FRANK C. BALFOUR, Chief Right of Way Agent, Department of Public Works, State of California.	
CENTENNIAL EXHIBIT—THE ENGINEERS PROFESSION	8
NEWS & COMMENT ON ART	9
REVISED SAFETY CODE APPLIED IN NATIONAL HOSPITAL SURVEY	10
NEW GENERAL SEQUOIA HOSPITAL, Redwood City, California	12
DOUGLAS DACRE STONE & LOU B. MULLOY, Architects.	
SILVIO P. MARRACCINI, Associate Architect.	
PARKER STEFFENS & PEARCE, General Contractors.	
NEW MEDICAL-DENTAL BUILDING, West Slope District, Portland, Oregon	18
MORGAN H. HARTFORD, A.I.A., Architect. By ARTHUR W. PRIAULX	
OUT OF THE TRAFFIC LOCATION FOR ORTHODONTICS OFFICE, Dallas, Texas	22
BERYL C. STEGALL, Architect. HENRY C. BENNETT, General Contractor.	
SANTA BARBARA COUNTY'S NEW TUBERCULOSIS HOSPITAL, Santa Barbara	23
CHESTER L. CARJOLA, Architect. DONALD F. SHUGART, Structural Engineer.	
H. H. HODGES, General Contractor.	
UTILITY USE OF ALUMINUM	24
WILLIAM WILSON WURSTER, Architect, and VICTOR GRUEN, Architect.	
By MARCIA LEE	
A.I.A. ACTIVITIES	28
WITH THE ENGINEERS	30
PRODUCERS COUNCIL PAGE	32
Edited by CARL B. FRANK, Detroit Steel Products.	
BOOK REVIEWS, Pamphlets and Catalogues	36
ESTIMATOR'S GUIDE, Building and Construction Materials	39
ESTIMATOR'S DIRECTORY, Building and Construction Materials	41
BUILDING TRADES WAGE SCALES, Northern, Central & Southern California	42
CLASSIFIED ADVERTISING	42
CONSTRUCTION CONTRACTS AWARDED, General Data	44
IN THE NEWS	46
INDEX TO ADVERTISERS	48

ARCHITECT AND ENGINEER (Established 1905) is published on the 15th of the month by The Architect and Engineer, Inc., 68 Post St., San Francisco 4; Telephone EX3ROK 2-7182. President, K. P. Kierulff; Vice-President and Manager, L. B. Penhorwood; Treasurer, E. N. Kierulff.

Los Angeles Office: Wentworth F. Green, 6605 Hollywood Blvd., Los Angeles 28. Telephone HEMpstead 3171.

Entered as second class matter, November 2, 1905, at the Post Office in San Francisco, California, under the Act of March 3, 1879. Subscriptions United States and Pan America, \$3.00 a year; \$5.00 two years; foreign countries \$5.00 a year; single copy 50c. ARCHITECTS' REPORTS are published daily from this office, Vernon S. Yallop, Manager. Telephone DOUGles 2-8311.



# EDITORIAL NOTES

## RESULTS ARE IMPRESSIVE

If you accept security and opportunity as a basic criterion for judging future progress in America, a good case in favor of these factors can be made by reviewing the first half of the present century, as the records will show it to be the most fruitful in the history of our Republic.

In these fifty years there has been a greater expansion of opportunity in the United States than has ever taken place in a like period anywhere in the world. Probably few people actually realize how great an enhancement of opportunity has resulted from the increased productivity in our economic system . . . a system that should be guarded and preserved for future generations.

\* \* \*

## DISTANT PASTURES ARE NOT THE GREENEST!

We have long contended the greater opportunities in the construction industry are stiffened in the west, and that such opportunities include the practice of Architecture and Engineering; they include the constructor and allied interests, and they include the manufacturer and distributor of building materials and supplies.

The West in a comparatively new country. A new country offers new opportunities.

It is our belief therefore that just a normal growth and development of industry and commerce will result in a tremendous volume of construction. However, world-wide developments have placed an important emphasis on the far-flung Pacific Area, so that today the unusual situation has developed of a "new country" plus a vast expansion in the area of activity.

Some interesting facts were disclosed recently in a nation-wide survey of building and engineering contracts. The survey indicated there would be a decline of some nineteen per cent in volume of construction in the thirty-seven states of the Rockies during the new year.

It is highly probable that such an estimated decline may reach a substantially larger figure when the actual results of government curbs and controls are known. We predict, however, that construction activities throughout the West will continue to expand and those who are seeking the greenest pastures in the building industry will look more and more to the West.

\* \* \*

## THE NEED FOR MORE

The demands for more production are large and compelling and come from many different direc-

tions. The most important demand for more output comes, of course, from the huge unsatisfied needs of people for goods. Another strong demand comes from the need for increased support of those members of the community who are not able to work. These people consist, in the main, of two groups—the elderly and the disabled.

There are about 7.6 million persons above 65 years of age who are neither earners nor wives of earners. A large number of these persons live on meager incomes provided through pensions or old age assistance.

In addition there are about 3.7 million other persons of working age who are temporarily or permanently unable to engage in a gainful occupation or to follow other normal pursuits. Larger incomes for the elderly and disabled mean larger claims on the output on the producers in the community.

Hence, if increased support for the elderly and disabled is not to retard the rise in real wages, the increase in output of industry must be accelerated.

\* \* \*

## IT'S WORTH IT!

A house designed for you and constructed under the supervision of your architect is created to meet your special desires and particular needs. It is the home in which you will live, and the care going into its design and construction will result in added satisfaction for many years. In no sense should an architect's services be regarded as an extra cost against the house. The architect's fee should be considered as insurance on your investment: insurance against loss resulting from poor design, inferior construction, early obsolescence and rapid deterioration. In addition, architect-designed houses usually command a higher resale value in the real estate market, and a higher appraisal value on the mortgage market.

The architect is your personal advisor on building or remodeling problems. He is an expert at his job and his service is a public function. He is a responsible citizen whose profession is one in which the highest degree of integrity is required, and maintained. You can be certain that when you consult with him, the advice he gives you is the product of long experience, and is the best that within the framework of his knowledge he can give. You can also be sure that it is impartial, as he has no financial interest in any product or building operation.

# SEQUOIA HOSPITAL

REDWOOD CITY, CALIFORNIA

DOUGLAS DACRE STONE & LOU B. MULLOY, Architects

---

PARKER, STEFFENS & PEARCE  
BUILDERS

135 SOUTH PARK · SAN FRANCISCO

Phone EXbrook 2-6639

# JOINT INFORMATION COMMITTEE

AMERICAN INSTITUTE OF ARCHITECTS and THE PRODUCERS COUNCIL, INC.

## A SYSTEM FOR BETTER SPECIFICATIONS AND MANUFACTURING LITERATURE

Which Will Help the Architect, Contractor, Manufacturer and Trades.

By F. BOURN HAYNE, A. I. E.\*

(PART THREE)

A great saving in time and printed matter could be accomplished for everybody concerned. Dozens of standard building procedures could be briefly covered in architectural specifications merely by referring to the required A.I.A. specification number. Only exceptions or additions and the scope of the work need be noted in the actual specification. Even Building Codes could refer to A.I.A. specifications for standards.

The work involved for the completion of such a system would be considerable, and the expenses—by the time that it was finished—would be great, but the writing of a good cook book is lots of work too and that isn't printed free of charge. There are so many vast monied interests concerned with the building industry which would benefit that the technical staff required and the printing costs involved ought to be no deterrent whatsoever. The Engineers, the Producers' Council, the Associated General Contractors, the various Architectural magazines, the United States Government, Architectural Schools and Labor Unions could all be called upon for financial and other types of help, since all these agencies are coming to realize the great necessity for a proper system.

After due thought is given to the actual form for presentation of the basic A.I.A. specification cards, much of the writing can be divided up among eminent men in the building field. Professors in various Architectural schools will most likely be only too willing to contribute. Outstanding members of the A.I.A. will most likely contribute if assigned to definite subjects. It is my opinion that trade union instructors and leaders out to be asked to help, and these basic A.I.A. specifications could be used as reference material in the proper training of apprentices. Manufacturers will doubtless furnish much technical information upon request. All that is needed is for the A.I.A. to take

\* Concluding article of a series of three specially prepared for ARCHITECT & ENGINEER magazine by Architect F. Bourn Hayne, A.I.A.

the leadership and establish the form and the system, to act as the clearing house and editing department, and to set the ball rolling.

### MANUFACTURERS' CARDS

As soon as the A.I.A. officially adopts this 5" x 8" specification card (or any better sized card) system, a national campaign can be started to get the numerous manufacturers to cooperate. Dummy cards can easily be sent out to manufacturers with a letter of instructions as to the new A.I.A. system and requirements. Manufacturers could then write up their own specifications, and send them to an A.I.A. editing or advising bureau so that finished specifications can all be written up in the same sort of studied, concise, and all-inclusive order and style. When the manufacturers' specifications are thus completed, the cards can be distributed directly through the mail with a one cent stamp to the architects and builders, or be sent in packages of six or eight as may be necessary. Each manufacturer's card will have its appropriate A.I.A. filing number in the upper right-hand corner as well as its own special number in the upper left-hand corner. The date of publication ought always be some place, say in the upper center position. Thus when products change, or require new specifications, it will be a very simple and cheap matter for the manufacturers to issue and mail new cards which will replace the old ones. The reprinting of thousands of tons of useless advertisement matter will thus be avoided.

The card index system will be of great benefit to large concerns which manufacture several different types of materials. Each specification can readily be slipped into the card file under its proper heading. The small concern which manufactures, say, a single item can also benefit just as much in that its single card, mailed for one cent, can easily find its proper nook for quick reference. These cards distributed directly by the manufacturers can be of various vivid colors, can even

(See Page 25)

NOTE: This news space is being contributed by ARCHITECT & ENGINEER Magazine to the JOINT INFORMATION COMMITTEE representing the Northern California Chapter of The American Institute of Architects and the Northern California Chapter of the Producer's Council, Inc., and is available to this Committee for the purpose of bringing to the attention of leaders within the Construction Industry various phases of the Architectural profession and building materials industry procedures for general consideration and comment. Your "ideas" and any suggestions for the better pooling of thoughts along these lines should be sent to "Joint Information Committee, c/o The Architect & Engineer, 68 Post Street, San Francisco," where they will be immediately forwarded to the proper committee members.



# URBAN TRAFFIC IMPROVEMENT

## THE EFFECT OF FREEWAYS AND EXPRESSWAYS ON BUSINESS AND PROPERTY

By **FRANK C. BALFOUR**, chief right of way agent,  
Department of Public Works, State of California

Do you remember 35 or 40 years ago when automotive transportation was in its infancy — the prejudice against the horseless carriage—the ordinances that sprung up in every city and town restricting the speed limit to six, eight, or twelve miles an hour? What caused this situation? "MENTAL HAZARD!" Fear of the local merchants that the "Merry Oldsmobile" would scare the farmers' horses; result, the farmer would not come to town to patronize the merchant.

Thirty-five or forty years later we again find fear on the part of the local merchant when the expressway or freeway is suggested to permit through traffic to bypass the city or circumvent the business district. Again in this modern age up springs "MENTAL HAZARDS" on the part of local business men and local realtors.

The loss of through traffic in the mind of the local businessman means loss of patronage, economic stagnation, probable financial ruin. To the local real estate man it means loss of property values, no more real estate sales; obviously no more commissions.

### MOTELS

The roadside motel operators as a group continued to present formidable opposition to California's freeway and expressway program. They blame the modern highway for their economic condition even though less than 5% of their locations have been affected to date. The plain truth of the matter is the law of supply and demand has caught up with them—there are just too many motel units in California for the number of potential patrons.

### CALIFORNIA'S LAND ECONOMIC STUDIES

Our California Highway Commission and my superior, State Highway Engineer G. T. McCoy, believing that the affected public and property owners are entitled to the facts, instructed me to create within the State Highway Right of Way Department a land economics research section.

Immediately upon completion of every freeway or expressway project our Land Economics Section

begins its studies. These studies take time because the minimum period required to develop factual information of any value is at least one year immediately preceding the improvement as compared to a one year period following the opening of the improvement to traffic.

Information must be secured on the affect of freeway and expressway construction upon abutting property, also upon the economic affect of the project on entire neighborhoods, the town or the city.

Complete economic information must be secured upon the affect on properties that formerly abutted upon and had unrestricted access to the through lanes of traffic, which upon completion of the improvement front upon a frontage road which parallels the expressway or freeway and connect to the through lanes of traffic only at points designated by public authority.

Information must be secured to determine the affect upon real estate values when access is tightly restricted along expressways.

The study must include positive facts as to what the affect has been upon business and real estate values (we use the sales tax returns of the merchants submitted to the State Board of Equalization over their sworn affidavit.) No real estate sales are considered unless we have a bonafide sale of the property during the "before" period and a bonafide sale during the "after" period, and then the sale is used only after exhaustive study to determine what has happened to comparable properties at other locations in the general vicinity where there has been on change in access conditions.

Our studies of volume of increase or decrease in retail sales cover all different types of business establishments affected by the modern highway improvement as compared to the same type of business establishments in other comparable locations or other comparable cities in the same general vicinity where no highway change has taken place.

We will continue to study the cities and towns where through traffic has been removed from the business section as compared to other comparable cities and communities to keep a close and accu-

*EDITOR'S NOTE: This is the text of an address delivered by Frank C. Balfour at the recent Businessmen's Conference on Urban Problems, Washington, D. C., which was sponsored by the Chamber of Commerce of the United States and highlighted numerous phases of Urban Traffic Improvement.*

rate check on what will happen to the affected communities under changing economic conditions.

Now let us hurriedly analyze a few of the results of our economic studies to date.

One of the most interesting facts brought out by our economic studies is as follows:

(a) Twenty-one California cities varying from 112,125 to 3,393 population have never had a state highway carrying through traffic into or through their business district. However, census information for 1950 discloses that this group of cities collectively show a 67% increase in population as compared to a 42% increase in the population of all other cities in California combined for the 10-year period 1940-1950.

(b) Twenty-seven California cities varying in population from 3,879 to 244,251 have had through traffic removed from their business districts during the last fifteen years. However, the 1950 preliminary census figures disclosed that these cities have enjoyed a 50% increase in population as compared to a 42% increase in the population in all other cities in California during the 1940-1950 decade.

Unfortunately, we do not at this time have the sales tax figures available on these two groups

of cities.

This population trend is certainly a clear indicator that through traffic is not required or necessarily desirable, to the welfare and expansion of a city even though that city may be located in a state that attracts hundreds of thousands of tourists each year. The new citizen finds the city where he desires to reside even though it is not on the main highway.

Now let us review a few of California's completed economic studies.

North Sacramento: Located on U. S. Highway 40 just across the American River from California's capital—Sacramento; population 6,016—period of study two years prior to October 1, 1947, compared to two years after—length of bypass 4 miles—traffic volume before 39,950—change in highway traffic 44%. Total number of business establishments studied, 224; number of "before" and "after" real estate transactions studied, 66; number of "before" and "after" sales, 8, result average increase of 30% in value.

Present valuation at 100% locations; \$350 to \$400 F. F.—land value trend continuing to substantially increase. The comparison of retail sales

(See Page 33)

---

## Centennial Exhibit Scheduled Featuring THE ENGINEERING PROFESSION

Eleven national technical societies and one from Canada have taken formal action to participate in the international convocation which will celebrate one hundred years of engineering as an organized profession in the United States. This convocation, organized under Centennial of Engineering, 1952, Inc., is designed to "Provide an opportunity for all engineers to gather to exchange ideas and information of value to one another with no one group taking a place of special prominence."

At a recent meeting the incorporators of Centennial of Engineering authorized President Lenox R. Lohr to extend invitations to an additional sixty technical societies in this country, and to appropriate societies of international scope, or of national scope in other countries. The international societies will be invited to hold their annual meetings in Chicago during the Centennial Convocation from September 3 to 13, 1952. Where it is not feasible for the societies of other countries to hold meetings in this country, it is hoped that they will send representatives to the convocation.

### Early Engineers

Before the year 1800, the only engineers were military engineers. For centuries they were the designers of fortifications, and were called keepers

of the king's engines—catapults, battering rams, and scaling towers. Elements of the civilian economy, such as bridges, roads, viaducts, mines and buildings, were built largely by artisans with empirical designs developed from the experiences of their predecessors. The small industries of the day—cotton and flour mills, stonecutters and shoemakers—were largely family concerns utilizing limited help from their neighbors and not requiring the service of engineers.

Up to this time the United States had lacked even military engineers, and during the Revolutionary War had utilized Europeans. In the year 1802, West Point was founded, not primarily as a training school for officers, but to develop military engineers, and while its basic function has changed, it has remained under the supervision of the Corps of Engineers ever since.

### March of Progress

With the march of progress it was realized that engineering had a scientific and economic basis, so the Corps of Engineers was called upon to build such projects as the Baltimore and Ohio Railroad. Even as late as the 1850's, the lack of American engineers made necessary the use of British en-

(See Page 35)



# NEWS AND COMMENT ON ART

## SAN FRANCISCO MUSEUM OF ART

The San Francisco Museum of Art, War Memorial Building, Civic Center, will feature the following exhibits and events for the month of January:

Exhibitions. Sculpture by Jacques Lipschitz; Second Annual Decorative Arts Competition; A New Vision—Wolfgang Paalen Lee Mullican, Gordon Onslow-Ford; the Albert M. Bender Memorial Exhibition; the Joseph Raphael Memorial, from the Bender Collection, and Art of Today in paintings, sculpture, prints, and photography in supplementary exhibitions in other galleries.

Events will include: Gallery Tours on Sunday and Tuesday under the direction of Mrs. E. Morris Cox and Mrs. Earl B. Murray, docents. A course in Modern Art for the Layman, history and techniques by Museum lecturers start on Monday, January 29th, and Studio Art for the Layman by Henry Schaefer-Simmern, Tuesday mornings.

Classes in Adventures In Drawing and Painting will start early in January and will be continued each Friday evening 7:30 to 9:30. Children's Saturday Morning Art classes at 10 each week.

Advance announcement is made of a Sonata Recital on February 19th, featuring Mr. Lev Shorr, pianist, and Miss Frances Wiener, violinist.

## PORTLAND ART MUSEUM

Thomas C. Colt, Jr., Director of the Portland Art Museum, West Park and Madison, has announced the following exhibitions for the month of January:

American Academicians, from the Museum's collections; A Summary of the Museum's year's work; Recent Print Accessories; and Oils and Tempera by Donald Boyd and Richard Prasch.

The Museum is open daily 12 noon to 5 p.m.; Wednesday's from noon to 10 p.m. Admission is free.

## M. H. de YOUNG MEMORIAL MUSEUM

The M. H. de Young Memorial Museum is Golden Gate Park, San Francisco, has scheduled the following exhibits for the month of January, according to Walter Heil, director:

Paintings, Watercolors, Collage by Laszlo Moholy-Nagy; Paintings of the War Years by Morris Graves; and Paintings by Vera Southby.

## CITY OF PARIS

The Rotunda Art Gallery of the City of Paris, San Francisco, will feature an Exhibit of Oils by

Clement Serveau, and Oils, Watercolors and Drawings by French artists during the month of January, according to an announcement by Beatrice Judd Ryan, Curator.

Also on exhibition will be the Sculpture of two Californians, and the Pictures of the Month will feature Portraits by Herbert Fleming.

## SAN FRANCISCO ART ASSOCIATION

The works of seven Bay Area artists are included in the Metropolitan Museum's first national exhibition entitled American Painting Today—1950, which is currently on exhibit at the San Francisco Art Association, 800 Chestnut Street.

The Regional Western Jury and the National Jury of Selection accepted the paintings submitted by Ruth Armer, Jean Varda, John Haley, Erle Loran, Ward Lockwood and Lee Mullican. Felix Ruvolo, faculty member of the University of California was one of four U. C. artists who successfully competed for the Metropolitan Show.

## NATIONAL CERAMIC EXHIBITION

The 15th National Ceramic Exhibition, sponsored jointly by the Syracuse Museum and the Onondaga Pottery Company, has opened in Syracuse with 1500 entries being submitted to the regional juries by artists in thirty-four states, Hawaii and Canada. Following awarding of prizes the exhibition will go on a one year national tour.

Among San Franciscans receiving awards were Whitney Atchley, Don Siegfried and Hal Riegger.

## ANNUAL PAINTING EXHIBITION SAN FRANCISCO ART ASSOCIATION

The 70th Annual Exhibition of Painting and Sculptures of the San Francisco Art Association, 800 Chestnut Street, will be held this year from February 28th to April 8.

Indications point to a record number of exhibits covering a greatly diversified classification of subjects.

Construction has started on a new \$1,000,000 art building on the Los Angeles campus of the University of California, containing 68,000 sq. ft. The building was designed by architect Paul Robbinson Hunter.

# REVISED SAFETY CODE Applied In NATIONAL HOSPITAL SURVEY

Safety and fire protection of hospitals and sanitariums, especially with respect to the application of nationally approved standard safety codes, have been studied intensively following disastrous hospital fires in the past year. Some of the results of these studies are now available in the new tenth edition of the Building Exits Code. Principal revisions deal with conditions for safety in hospitals.

This safety code, developed under the guidance of the National Fire Protection Association, has been announced as an American Standard. As such it represents a consensus of all who are affected in any way by hazardous conditions in all types of public buildings, as provided by the basic principles of the American Standards Association. For these reasons the code is being used to an increasing extent as the basis of enforceable state, county, and municipal codes.

Based on this code to a large extent, as well as on other applicable safety codes, a nationwide survey of hospitals has been initiated. A written report is to be made on every hospital, sanitarium, nursing home, and similar institution in the United States. These reports are in the form of questionnaires with 133 major questions to be answered, many being a combination of several questions under one head.

The survey is being conducted under the guid-

ance of the National Board of Fire Underwriters, the American Hospital Association, and Association of Casualty and Surety Companies, with 50 other cooperating organizations. From one and a half to two years will be required to complete the survey and prepare a report. This report will be used as a basis for recommendations aimed at increased assurance of hospital safety and adequate protection of life if fires break out.

Present evidence indicates that the application and proper maintenance of nationally approved standards for fire protection in hospitals and related institutions have become greater problems than the development and maintenance of up-to-date codes. The Building Exits Code offers the best known practical provisions against fire and fire casualties in the construction and arrangement of new buildings for hospitals. In spite of the availability of this information, in some existing buildings used for hospitals, sanitariums, nursing homes, and homes for the aged, conditions little short of appalling are being reported by building inspectors. Even the fundamentals of life safety from fire have been found lacking. Exit doors have been found locked. Corridors are found too narrow or restricted to permit rapid removal of patients. Inadequate exits and doors opening against exit travel are still being found.

The code, on the other hand, is under constant



**Smoldering ruins of the mental ward of Mercy Hospital, Davenport, Iowa, where 38 lives were lost in the recent hospital disaster.**

*Acme Photo*

surveillance by representatives of national organizations and governmental agencies, and its provisions are based on latest experience subject to majority agreement in the responsible committee. The present code is the tenth in 22 years.

Foundations for the code were laid in 1913 by the National Fire Protection Association's Committee on Safety to Life. Its early studies and reports on major fires in which many lives were lost resulted in the formulation of standard safe practices.

Development of the Building Exits Code now benefits by contribution of 26 national organizations.

Codes and standards developed are never static but are subject to constant improvement. Ten editions of the Building Exits Code since 1927 testify to the activity of the organizations represented. Hospitals are, of course, only one phase of its coverage. It also applies to schools, stores, factories, hotels, apartment houses, office buildings, and places of public assembly. In the new edition jails and penal institutions have been reclassified separate from hospitals and sanitariums for the first time.

#### **New Hospital Provisions**

Among significant additions to the new code applying to hospitals are strong recommendations for horizontal exits and the provision of two or more compartments separated by smoke barriers or fire walls in both new and existing buildings. The latter is one means of providing a horizontal exit, which means protected openings through or around a fire wall or a fire partition. Such an exit may also be one or more bridges connecting two buildings on the same level. Fire alarms and fire drills are also given more emphasis in order to be sure that hospital personnel at every level will be familiar with signals and procedure under varied conditions day and night.

With regard to horizontal exits a new recommendation in the code is that "In the planning of hospital exits it is essential that arrangements are made to facilitate the transfer of patients in their beds from one section of a floor housing patients to another section of the same floor separated by a fire wall or smoke barrier. . . . Where the building design will permit, the section of the corridor containing an elevator lobby should be separated from corridors leading from it by smoke barriers. Such an arrangement, where elevators are centrally located, will, in effect, produce a smoke lock, placing a double barrier between the area to which patients may be taken and the area from which they may be evacuated because of threatening smoke and fire."

Defining compartments, the new code states that "Each story in which 35 or more patients are housed shall be divided into at least two compartments by smoke barriers, and the enforcing authority may require stories housing a lesser number of patients to be divided into compartments when, in his judgment, such division is essential to the protection of the patients."

"No more than 150 feet of corridor without barrier against the lateral passage of smoke shall be permitted," and the code recommends that enforcing authorities "may order fire wall, or smoke barriers, or both, to be built in new and existing buildings." Doors in smoke barriers may normally be kept open but either close automatically or may be released manually to self-closing action.



**These swinging doors in the Lynn High School were a major factor in saving the balance of the school when the auditorium section burned with a loss estimated at \$250,000.**

Minimum width of aisles and corridors requiring passage of beds has been increased from 60 to 96 inches for new buildings. However, 60 inches is still permissible in existing hospital buildings.

Hospital fire alarms and drills are defined more specifically in the new code, recognizing the differences in conditions from those in buildings for other purposes. It states that "Manually operated fire alarm systems shall be provided . . . which sound an audible alarm in departmental offices, the engineering office, fire brigade headquarters, nurses' quarters, and other locations" where they will not disturb patients. Distinctive visual alarms must be installed at each nurse's station and be used only for fire alarms. Although more fire drills are emphasized for irregular intervals, it is not intended that infirm and bedridden patients be moved.

(See Page 34)

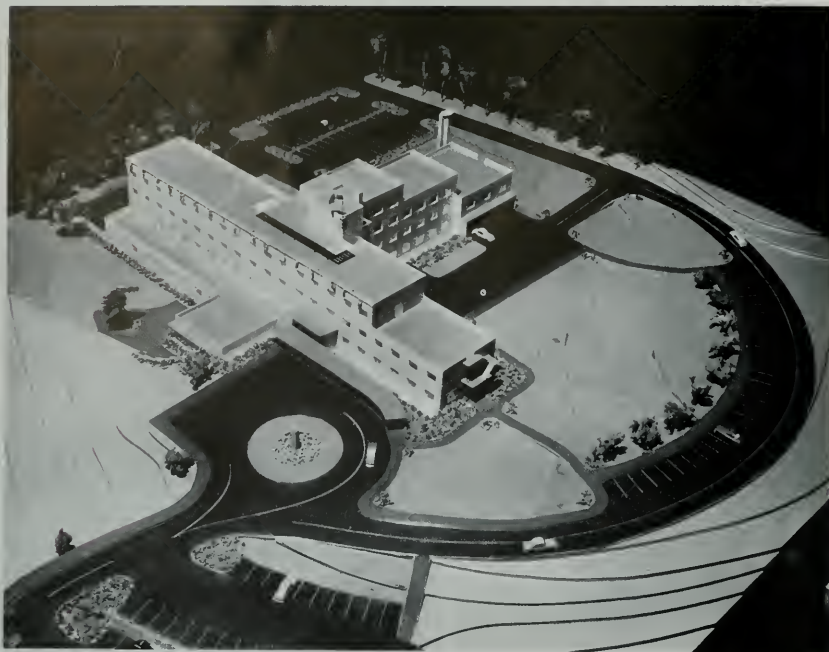

ARCHITECT'S MODEL SHOWING THE FIRST STAGE OF CONSTRUCTION

NEW GENERAL  
SEQUOIA HOSPITAL

REDWOOD CITY, CALIFORNIA

ARCHITECTS: Douglas Dacre Stone &  
Lou B. Mulloy  
Silvio P. Marraccini,  
Associate Architect

CONTRACTOR: Parker, Steffens & Pearce



A dream that began to take shape back in the middle "thirties" became a reality with the completion recently of the Sequoia Hospital at Redwood City, California, and its operation under the direction of Max E. Gerfen, hospital administrator.

Started in the interests of community development and to serve the needs of the Sequoia district for a modern hospital, the project was first presented to the Redwood City Council who authorized a survey and later reported favorably on the undertaking. Previous commitments for bond issues to finance other public works, precluded any possibility of immediate action and it was not until 1944 that the matter again became one of great public interest.

Through the support of the Redwood City Chamber of Commerce, and the City Council, another hospital committee was appointed and in 1945 it was recommended that the hospital district plan, which had been passed by the California Legislature be developed. The Sequoia Hospital District was approved by the voters at an election in 1946, a contract for construction awarded to Parker, Steffens and Pearce, General Contractors, and work on the \$2,000,000 venture began early in 1948.

The first stage of construction provides complete facilities for a 100 bed general hospital. Overall plans provide for additional construction which will double this capacity.

The site is on a rising hill overlooking lower San Francisco Bay and the immediate suburban residential area. The buildings are placed well back on the 12 acre site and approaches to the hospital for public and service have been segregated, as well as traffic patterns, service courts and parking areas within the site. The initial construction has been developed around a highly concentrated service core. All hospital functions radiate from the centralized grouping of nurses' station, dumbwaiter, elevators, stairs, food service, utility and treatment rooms. This arrangement makes for minimum efficiency and convenience with a minimum of labor and operational expense.

In planning and equipment nothing has been overlooked which would make for more efficient and economical operation. The well-being of the patient and the provision for the most up-to-date facilities for medical and surgical technique have been paramount considerations, yet extravagance has been avoided by clear cut functional simplicity of design and construction.

Labor saving devices are numerous. In the dietetics department, a central tray service has been installed. Trays are set up and served in the kitchen area from steam tables and then sent to the floor pantries by means of vertical conveyors. Soiled dishes are similarly returned to the ground floor dishwashing room. All soiled linen and trash are dropped to ground floor collection areas by

Architect  
D. D. Stone's  
Painting of  
Hospital under  
Construction



## SEQUOIA HOSPITAL . . .

chutes. Supplies from storage and issue areas are delivered to the core nursing unit by dumbwaiters. A pneumatic tube system connects various stations and departments to carry records, samples, X-ray films, messages and other small items, eliminating the great majority of messenger traffic. A two way speaker control system connects all patient's rooms with nurses' stations, reducing nursing labor greatly as well as providing control of the nursing units.

As noted in the plans and photographs, all service facilities are located on the ground floor. The receiving court serves both the general storage area and the kitchens. The kitchen area consists of a large unit comprising day storage, segregated refrigeration rooms, food preparation areas, cooking area, bakery, scullery, tray set-up area, diet kitchen and office for the chef and dietician. The dishwashing area is adjacent, as are dining rooms for staff and employees. Lockers, restrooms and toilet rooms are provided for employees, nurses and technicians. A record storage room connects



with the first floor record room and acts as a message center for the pneumatic tube system.

The clean linen storage room, the soiled linen room and the housekeepers office are adjacent to the laundry. The boiler room, repair shop, and electrical equipment rooms are also located on this floor.

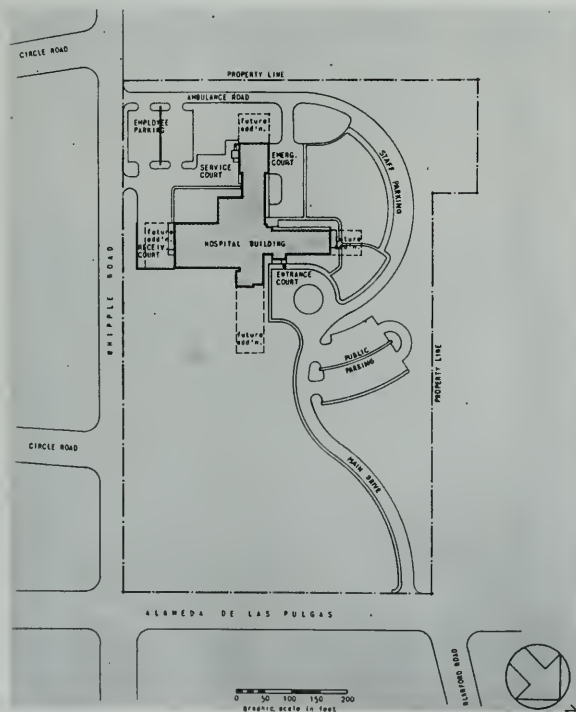

Top: View of Administrator's Office showing spacious windows.

PLOT PLAN OF THE SEQUOIA HOSPITAL BUILDING AND AREA

### TYPICAL HALLWAY

Showing traffic dispersal area—elevators at right, public telephone at left, nurses station at hallway intersection, and bed-rooms and special service rooms along hall.

*Fred Mae Photo*



The public entrance and lounge wing, and the business and administrative offices are located on the first floor. Connected to the record room are the staff library and the doctor's lounge. Medical bedrooms on the first floor open to wide roof terraces. The centrally located nurses station has visual control of the corridor, elevators, stairway, floor waiting rooms and service kitchens.

The rear wing of the first floor contains all the diagnostic facilities, X-ray department, film storage space, general laboratory, electrocardiograph, basal metabolism, hydrotherapy and physical

therapy and adjunct service areas. In this part of the building a large emergency department has been included comprising an emergency operating room, treatment room, sub-utility, waiting room, nurses' station and office. Entrance is from a shielded ambulance court.

The nurses units, including the pediatrics department and surgical beds, are controlled and served by a centrally located nurses' station on the second floor. An entire wing of the second floor is taken up by the surgical department. Four large operating rooms are paired with connecting

### GROUND FLOOR PLAN . . .

Provision has been made for the addition of extensions at each of the "wing" ends. This floor is devoted largely to service facilities.

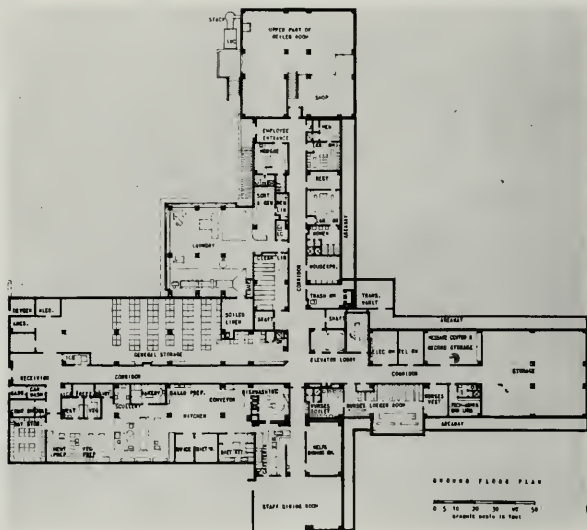





**MEDICAL LIBRARY**  
 Additional lighting is provided from  
 fluorescent tubes placed behind  
 board facing at top of book shelves.

*Fred Mae Photo*



secretary are also a part of this department.

The third floor is devoted to the maternity and obstetrical department. Maternity beds and accompanying nursing facilities are in one separate wing. In another wing are the segregated nurseries. Each normal nursery contains 14 cubicles, separated by examination and work rooms. The separated real wing contains the delivery and labor rooms, preparation rooms, nurses and doctors lockers, supervisor's office and recording secretary's desk.

All bedrooms in the hospital have been designed for two beds and each room has a private toilet

and built-in lavatory. One of the two centrally placed elevators has front and rear doors, thereby serving both wings of each floor.

The construction is earthquake proof, reinforced concrete. Exterior finish is specially treated concrete. Interior finishes are designed for durability and minimum upkeep. Flooring for all patient and administrative areas is resilient asphalt tile. Terrazzo is used in surgeries and similar areas. Quarry tile is used in the kitchens, laboratories and wet work areas. Ceilings throughout are acoustically treated. All sash are steel. The present construction has a floor area of 87,163 sq. ft.

**SECOND FLOOR PLAN . . .**

Surgery, and technical facilities, together with nurses' work area and a larger number of beds for patients.

The **THIRD FLOOR** includes maternity ward.

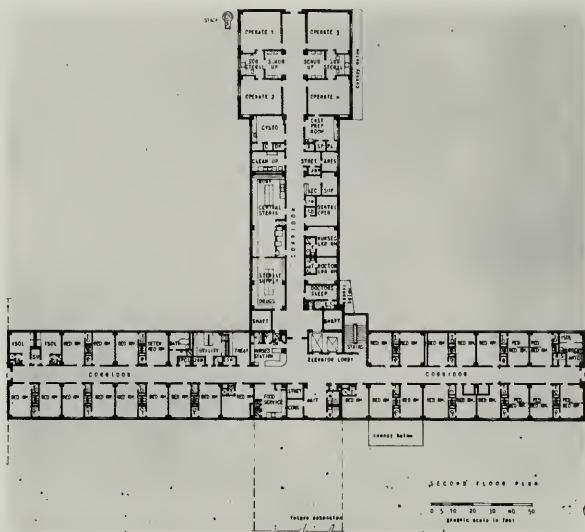



*Ackroyd Photography, Inc. Photos*

NEW  
MEDICAL-DENTAL BUILDING  
West Slope District — Portland, Oregon

By **ARTHUR W. PRIAULX**

ARCHITECT: Morgan H. Hartford, A.I.A.

DOCTORS: K. P. Caveny, M.D.

R. J. Rutten, D.D.S.

## . . . MEDICAL-DENTAL BUILDING

This ultra-modern designed single story, flat roofed building of veneer frame construction contains complete facilities for the professional practice of a Physician and a Dentist as individual enterprises.

The Plan of the buildings has been designed by architect Morgan H. Hartford so that a spacious common Patio, reached by cement walk from the street, serves to connect the separate Medical and Dental Units. These Medical and Dental Units are individually owned and the structures have been placed on the building site so that the center line of the two privately owned lots between the buildings passes through the approach walk and the Patio. Entrance into the Units from the Patio have been "staggered" so that they do not face each other.

Each building unit is complete within itself and entirely independent of the other. Separate utilities serve each building and each has an individual heating and ventilation plant. The Dental Unit contains a large reception area, two operations

rooms, a utility room, office and building maintenance storage space, toilets, and an exit at the rear of the building (opposite the Patio) which leads via sidewalk to the street fronting the property.

The Medical Unit has an entrance into the Reception Room which distributes traffic into medical service rooms and a business office. Complete facilities have been provided for adult and children's examination rooms, separate from each other, and for X-ray laboratory including dark room. This Unit also contains a rear exit which leads to the front street.

Both the Medical Unit and the Dental Unit have been equipped with the most modern equipment and facilities which are in keeping with the new building atmosphere.

The Patio roof which extends from the Dental Unit to overlap the Medical Unit roof is the only direct tie-in between the two buildings. This serves to bring the buildings together architecturally and gives the general overall appearance of one large

MEDICAL UNIT—1320 sq. ft.

DENTAL UNIT—745 sq. ft.

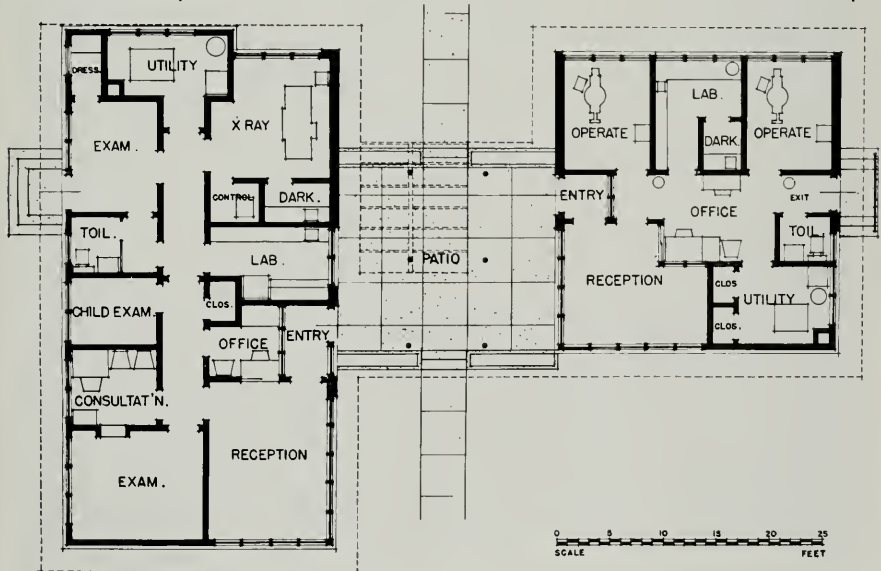

## MEDICAL-DENTAL BUILDING . . .

structure, rather than the actual two smaller ones.

Materials and detailed construction of the two buildings are almost identical. The floors are of asphalt tile throughout; the ceilings are of Acousti Celotex, and the walls are of painted plaster.

A distinctive appearance has been added by the use of slab Birch doors on the Offices. The Reception rooms are joined with the Offices by a special service window so that persons in the Reception area can contact office personnel without entering the office proper.

The exterior construction is based upon concrete with split tile veneer walls extending up to the base of the window sills and oiled Cedar boarding over the windows sills, on eave soffits and ceiling of the Patio roof. An aluminum foil cap sheet is used on the flat roof to reflect the sun's rays. Eaves of the roof extend sufficiently to serve as a glare protection and storm protection for the

windows. The roof space is ventilated through a series of slotted eave boards and the roof is insulated with two inches of rock wool.

The two individual heating plants are oil fired, forced filtered air, type, with ample capacity to assure complete heating at all seasons of the year. The two buildings are lighted with incandescent and fluorescent lighting. Lighting fixtures have been placed overhead in most instances, but in the entrance and reception area, wall installations are also applied.

One of the features of the Reception Rooms is the floor to ceiling modern windows which overlook the Patio and Garden.

As the buildings face south and are featured by the high windows, undue light exposure and sun ray's are minimized by overhanging eaves, particularly during the midday position of the sun during the summer time.

### TYPICAL RECEPTION ROOM



MEDICAL-DENTAL BUILDING

DENTAL OPERATING ROOM



BUSINESS OFFICE AREA



*Flapan Studio Photo*

## Out of Traffic Location For ORTHODONTICS OFFICE DALLAS, TEXAS

Patient safety and transportation convenience were the motivating factors behind the out-of-traffic location for the new orthodontics offices of Drs. Brooks Bell, Joe Favors and Frank Roark, and their four women assistants. Every facility for patient comfort; parking space for 20 cars; and 3,200 sq. ft. of laboratory and working space are provided.

Functional in design, and employing insulating glass in all window openings to lighten the load of the air conditioning plant and maintaining even temperatures, the building is a two-story structure having stone facing on the street side, and side walls of brick and hollow tile. The building is erected on a concrete slab which houses all copper pipes for air, water, gas and electricity. Partitions are movable.

### ARCHITECT:

Beryl C. Stegall

### GENERAL CONTRACTOR:

Henry C. Bennett

On the ground floor are located eight treatment rooms, two laboratories, technicians' lounge, technical equipment room, private offices, and reception room. The second floor contains executive offices of a commercial concern.





*Norcross Photo*

# Santa Barbara County's New TUBERCULOSIS HOSPITAL

## SANTA BARBARA, CALIFORNIA

ARCHITECT:

Chester L. Carjola

STRUCTURAL ENGINEER:

Donald F. Shugart

GENERAL CONTRACTOR:

H. M. Hodges

about five miles north of the famed City of Santa Barbara.

According to medical and health authorities, the hospital represents one of the most modern Tubercular treatment plants in the West, and was designed by the architect and engineer to take advantage of the area's favorable climatic conditions, plus the use of newest developments in the field of construction materials and service facilities.

The new Santa Barbara County Tuberculosis Hospital was built on an ideal site located on State Highway 101, the scenic Coast Highway,

Constructed of lightweight concrete and reinforced structural steel the building is three stories in height. Large windows have sun and glare protection from built-in shades, and interior is designed for maximum hospital utility use.



ALUMINUM SIDING APPLIED VERTICALLY THROUGHOUT

## UTILITY USE OF ALUMINUM IN

Attractive Residence  
Mandeville, Canyon  
Los Angeles, County

WILLIAM WILSON WURSTER,  
Architect

Aluminum siding, one third the weight of wood, is fabricated with slightly concave face giving sufficient rigidity to overcome any tendency to ripple and also makes possible a tensioned, weatherproof lock.



*Photos by Kaiser Aluminum & Chemical Sales, Inc.*



Aluminum siding extending from the top of shelf cases to the ceiling achieves the effect of individual specialty shops in the new R. H. Macy & Co. store in San Francisco, California.



## Interior Remodel R. H. Macy & Co. San Francisco

VICTOR GRUEN,  
Architect

# RESIDENTIAL and COMMERCIAL CONSTRUCTION

By **MARCIA LEE**

Aluminum siding has proven to be a very versatile product in the construction industry, and its uses have not been restricted to commercial or industrial buildings, nor in the construction of apartment houses and residences.

For example in searching for a means of creating "the intimate appearance and feeling of separate shops" in the recent remodeling of R. H.

The Aluminum "breathing walls" are painted in soft background tones, the colors varying to enhance the feeling of separation between departments.



Macy & Company's department store, without sacrifice of any factor of ventilation which is so important to a non-airconditioned building, the architectural firm of Gruen & Krummeck developed the use of aluminum siding panels to form what architect Victor Gruen describes as "breathing walls."

The aluminum siding, originally planned for use in home construction, is available in strips cut to the size required for any particular installation and in the Macy instance are 6 feet in length. They are fastened at the top to channels in the siding and at the bottom to channels in the top of the shelf cases. The panels are set several inches apart and at an angle, so spaced that their ends overlap and thus permitting circulation of air while cutting off through vision from any point not directly in line with the opening. The panels were prime coated prior to installation and then painted on the job to match the decor of the particular department which they enclose.

An equally important purpose of the architect in selecting the aluminum paneling was to achieve maximum flexibility at minimum expense. The light weight of the aluminum panels makes it possible to create a new department or "shop" almost overnight without damage to the material. New effects may be achieved by shifting of the panels, re-decorating, and the material can be re-used

indefinitely without serious damage.

Another instance where aluminum panels were used effectively was in the Macy's new Kansas City store.

Here, although the store is airconditioned throughout, the primary purpose of the aluminum "curtain walls," according to architect Gruen, was to achieve a maximum of flexibility with economy. Where greater than the store's normal circulation of air was desired the panel construction used was identical with the installation in the San Francisco store. For the most part however, the curtain walls were constructed of flush aluminum panels fabricated of 3SO alloy, .025 gauge, in six different patterns. Where it was desirable to vary wall lines with rounded contours, aluminum louvers, similar in construction to the panels of aluminum awnings, were set up in tracks laid on top of floor coverings.

Aluminum siding is now being used with notable success by several contractors in various parts of the country, particularly in new home construction where the product is being used for re-siding among other things. It is reported that a crew experienced in its uses can build a house comparable to any other at several advantages to the home owner. Maintenance expense, it is claimed, represent a minimum factor.

The use of aluminum siding in the construction of a modern home is illustrated in the attractive Mandeville Canyon residence in Los Angeles County which was designed by architect William W. Wurster. The plain upper edge of each aluminum strip slips into the slotted lower edge of the strip above. Nailing down the lower edge through pre-punched nail slots produces a strong tension and a rigid, weatherproof joint with all nail heads completely hidden.

While in most cases the aluminum siding is applied horizontally for home construction, an interesting variation is made in the Mandeville Canyon home where architect William W. Wurster has designed the products use for a vertical application.

## WILL OUTLAST YOUR BUILDINGS

**NEW  
STANLEY  
"Full-  
Jeweled"  
ball bearing  
butt  
hinge**

*takes both lateral  
and vertical thrust*

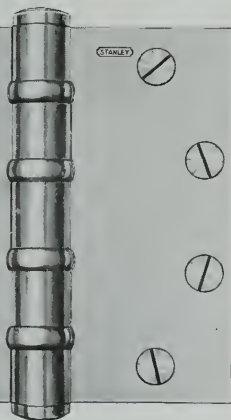

The Stanley Works  
New Britain, Connecticut



**HARDWARE • TOOLS • ELECTRIC TOOLS  
STEEL STRAPPING • STEEL**

## BETTER SPECIFICATIONS

(From Page 6)

carry pictures and illustrations and editorial comment as to virtues and benefits. BUT the essence of the cards will be its A.I.A. filing number, the date of its publication, and a properly edited, brief and pithy specification which the Architect can have typed directly into his own specification sheets.

There is practically no limit to the use of the Manufacturer's imagination as far as the printing of these cards are concerned as soon as the A.I.A. sets up a dummy specification schedule for him to follow, and this dummy specification will point out clearly to the manufacturer just what sort of information the Architect wants. Just as long as this

specification is plainly printed on the card with the proper rate and numbers for identification the manufacturer can go "hog-wild" if he likes, as for a color, texture, and material of his special cards. They can be made out of stiff building paper, copper, or sheetmetal, thin wood, wallpaper, or linoleum. The recommendations however, of the A.I.A. ought to guide the manufacturer as to what the architect likes best, which I believe is something on the simpler side with some extra space provided for his personal notes concerning the product.

If it is necessary for the manufacturer to put out an advertising circular of the standard letter size, let him do so as he has been doing, and cover it with all the colors and dramatic pictures he likes, BUT let the rear cover have a 5" x 8" perforated area on which is printed the concise type of specification data that the architect wants, as well as the A.I.A. and manufacturer's file numbers and the date. **Reference** can also be made to the full, standard-sized catalogue or booklet of the manufacturer on the 5" x 8" area. Upon receipt of the manufacturer's literature, the architect will then tear off the specification card and file it in his proper place in his 5" x 8" specification file, and will next file the standard letter-sized catalogue in his old filing drawers. Thus a reference card in the smaller file can direct one to the larger and more bulky file. In many, many cases, however, and especially with new products of the household, gadgety type, one or two carefully worded cards will contain more than enough pertinent information for the architect. Then again, if the manufacturer feels sure that he wants the architect to have at his finger tips a vast number of tables, charts, and schedules, such information can be printed on a series of cards and all inserted into a special 5" x 8" envelope which will be duly numbered. A slight change in one of the charts or tables will mean that the manufacturer has to change only one or two cards and not reprint an entire new catalogue. If, however, he wants to stick to the usual type of bound catalogue, this might be made 5" x 8" in size to fit the new file. This is a most convenient pocket size and almost the same dimensions of the Institute's journal, which makes handy reading for the commuter in trains or bus. There are many angles for development too numerous to foresee at this time, but it seems to me that such an idea of basic standardization has promise. All I am sure of is that if I move my material and appliance file today I move about two tons of printed paper, most of which has the wrong information printed on it in the first place—most of which is undated and much of it is sodly out of date. It is full of beautifully colored lithographs and pictures, however, and would make a swell source of supply for a children's welfare clinic which had a scrap book urge.

Some sort of a flexible card system would serve to great advantage in keeping the Architect and Contractor posted in regard to the rapid changes in cost. This cost situation is a huge problem and a field unto itself, but one needing much attention. Thought of this ought to be considered in the initial plan for standardization.

Many manufacturers' advertisements, though lovely in form, color and artistry, often contain not

one whit of information that can be used for a specification. Various organizations and associations publish endless booklets on information for all sorts of things but the booklets seem to contain a vast amount of repetition, and the search for the few brief, concise sentences that are necessary is sometimes a great task and a time consumer. Then, alas, with the slightest change in technique or method of material, all those booklets become out-of-date, and ought to be scrapped. It seems to me that the time has come for the A.I.A. to set up a department which shall act as a day-by-day watch dog for all such changes and by the method of mailing a few cards every few months to its members can thus keep them adequately informed.

#### ARCHITECT OPENS OFFICE

Donald G. French, architect, recently opened offices in San Bruno (California) for the general practice of architecture. He is interested in receiving catalogs and literature on building materials and equipment. Offices are located at 217½ El Camino Real.

#### CHANGES NAME

The architectural firm of Dragon, Schmidts & Hardman has recently announced changing of the firm's name to Schmidts & Hardman, Architects. Change in the firm name was due to the death of Paul L. Dragon, some time ago.

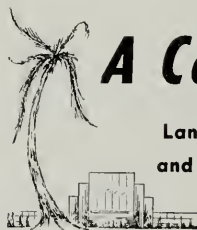

## A Combined

Landscape Architecture  
and Contracting Service

for

Tract, Industrial and Residential  
Development

We can do the Complete Job for you

- Landscape Architecture
- Finish Grading and Landscaping
- Asphalt Drives and Parking Lots
- Chain Link Fencing

**HENRY C. SOTO CORPORATION**  
*Landscape Contractors*

13000 SO. AVALON BLVD. LOS ANGELES 61, CALIF.

Phone ME nlo 4-6617

# American Institute



# of Architects

Ralph Walker, president  
Glenn Stanton, 1st vice president  
Kenneth E. Wischmeyer, 2nd vice president  
Clair W. Ditchy, secretary  
Charles F. Cellarius, treasurer

**Arizona Chapter:**  
Edward L. Varney, President; Ralph B. Haver, Secretary,  
35 W. Oregon Street, Phoenix, Arizona.

**Central Valley of California:**  
William Koblik, President; Gordon Stafford, Vice-President;  
John W. Bombberger, Secretary; Albert E. Thomas, Treasurer,  
Secretary's Offices P. O. Box 1943, Modesto.

**Coast Valleys Chapter:**  
Wm. Hempel, President; Lawrence Gentry, Vice-President;  
Walter Stromquist, Sec. Treas.; Directors: Chas. Butler and  
Thos. S. Elston, Office, 227 State Street, Los Altos.

**Colorado Chapter:**  
Henry J. Van Wyl, President; Charles H. Overholt, Secretary,  
2509 W. 36th Avenue, Denver, Colorado.

National Headquarters —  
1741 New York Avenue, N. W.  
Washington 6, D. C.

Edmund R. Purves  
Executive Secretary

**Northern California Chapter:**  
Ralph N. Pollack, President; Francis J. McCarthy, Vice-  
President; William B. McCormick, Secretary; George A.  
Downs, Treasurer, Offices 369 Pine St. San Francisco.

**Oregon Chapter:**  
Herman Brookman, President; Donald J. Stewart, Vice-  
President; Raymond Kermit Thompson, Secretary; Millard  
H. Schmeier, Jr., Treasurer, Secretary's office 429 S. W. 4th  
Avenue, Portland.

**Pasadena Chapter (California):**  
Burton Bombberger, President; Georgius Y. Cannon, Vice-  
President; Donald E. Neptune, Treasurer; William H. Taylor,  
Secretary. Directors: Boyd E. Georgi, Roland E. Coate,  
Edwin Westberg and Robert H. Ainsworth. Office 1041 E.  
Green St., Pasadena.

## APPOINTED LECTURER STANFORD UNIVERSITY

Dr. Jaroslav J. Polivka, outstanding European construction engineer and nationally known U. S. consulting engineer, has been appointed a lecturer in architecture at Stanford University.

He will teach a course in structures, one of three technical classes being offered this year by the newly formed Stanford Art and Architecture Department.

Dr. Polivka is a member of the Masaryk Acad-

emy, the American Societies of Civil and Mechanical Engineering, and the Mexican Society of Engineers and Architects.

## OREGON SOCIETY OF ARCHITECTS

The Oregon Society of Architects was recently organized as a non-profit, unincorporated organization, with Charles W. Endicott, Eugene, Oregon, being named president.

Other officers include Sidney W. Little, Dean of the School of Architecture, University of Oregon, Vice-president; Frederick Hanaford, Secretary-Treasurer, and Clare K. Hamil and John L. Reynolds, Directors.

Objectives of the organization are to unite the architectural profession in southern Oregon; to stimulate and encourage continual improvement within the profession; to co-operate with other professions; to promote and participate in matters of general public welfare, to represent and act for the architectural profession in the area served by the membership; and to promote educational and public relations programs for the advancement of the architectural profession.

Membership constitutes registered architects, and Associate members.

## LARGE NUMBER OF ARCHITECTS PASS CALIFORNIA EXAMINATION

More than fifty-seven new architects have received their license from the State of California and are now qualified to practice their profession, according to a recent list released by the State Board of Architectural Examiners.

Among those receiving their license in architecture were: Irene M. Pierce, Ralph C. Digham, Mathew Lapota, David B. Aldrich, John Coleman, John B. Fish, Edward W. Genter, Carey K. Jenkins, Charles H. Jones, William Krisel, Dion Neutra, Chester C. Smith, Richard A. Tom, James E. West-

Remember it's

# KRAFTILE

for GLAZED STRUCTURAL WALL UNITS  
PATIO TILE  
SWIMMING POOL OVERFLOW  
GUTTER  
QUARRY TILE  
FACE AND ROMAN BRICK  
ACID BRICK  
BRICKETTES  
MINWAX TILE & CONCRETE  
FLOOR FINISH  
STRAN-STEEL FRAMING  
QUONSET BUILDINGS

For complete information and prompt service, phone or write

## KRAFTILE COMPANY

NILES, CALIFORNIA NILES 3411  
SAN FRANCISCO 5: 30 Hawthorne St.—DOUGLAS 2-3780  
LOS ANGELES 13: 406 South Main Street—MUNIAL 7241



**East Bay Chapter:**

James H. Anderson, President; Loy Chamberlain, Vice-President; William Corlett, Secretary; Chester Treichel, Treasurer; Office 470 Sec., Bank of America Bldg., Oakland.

**Montana Chapter:**

Orr Pickering, President; H. C. Cheever, Secretary, Montana State College, Bozeman, Montana.

**Nevada Chapter:**

George L. F. O'Brien, President; Aloysius McDonald, Vice-President; Graham Atkins, Secretary; Edward S. Parsons, Treasurer. Offices 160 Chestnut St., Reno.

**Nevada State Board of Architects:**

L. A. Ferris, President, Reno; Walter Zick, Secretary, Las Vegas; Directors, Aloysius MacDonald, Las Vegas; Russell Mills and Edward Oarsons, Reno. Office, P. O. Box 2107, Las Vegas, Nevada.

**San Diego Chapter:**

George C. Hatch, President; Jack R. Lewis, Vice-President; Louis A. Dean, Secretary; Donald Campbell, Treasurer; Directors, C. J. Padesewski, Walter C. See, Louis H. Bodner, and Wm. Templeton Johnson. Offices Suite 206 Fifth Avenue Building.

**San Joaquin Chapter: (California)**

Fred L. Swartz, President, Fresno; Lloyd J. Fletcher, Vice President, Visalia; Walter Wagner, Secretary, Fresno; Robert W. Stevens, Treasurer, Fresno. Directors: Alastain Simpson, William D. Coats, William F. Baxter. Maurice J. Metz, Delegate California Council of Architects. Office, Sec. Fulton-Fresno Bldg.

**Santa Barbara Chapter (California):**

Robert I. Hoyt, President; Harold E. Burket, Vice-President; Roy W. Cheesman, Secretary; Lutah M. Riggs, Treasurer. Address, 232 San Marcos Bldg.

**CALIFORNIA COUNCIL OF ARCHITECTS**

Frank V. Mayo, President; Frederick A. Chase, Executive Secretary, Office, 3757 Wilshire Blvd., Los Angeles 5.

**Southern California Chapter:**

John J. Landon, President; Chas. Frey, Vice-President; C. Day Woodford, Secretary; Wm. G. Balch, Treasurer, Director; Henry Wright, John Rex, and Kemper Nomland, Chapter Headquarters, 3757 Wilshire Blvd., Los Angeles 5.

**Spokane Chapter:**

Richard H. Eddy, President; Harry C. Weller, Vice-President 1; Kenneth D. Stormont, Vice-President 2; Victor L. Wullst, Secretary, and Carl Johnson, Treasurer. Office 1023 W. Riverside Ave., Spokane, Washington.

**Utah Chapter:**

Howell G. Cannon, President; William J. Monroe, Jr., Secretary, 3707 South 32nd West Street, Salt Lake City 7, Utah.

**Washington State Chapter:**

Perry B. Johanson, President; Paul Thiry, 1st Vice-President; Thomas F. Harris, Jr., 2nd Vice-President; John S. Delle, Secretary; Lawrence G. Waldron, Treasurer. Office 714 American Bldg., Seattle 4.

**Tacoma Society:**

E. N. Dugan, President; P. G. Ball, Vice-President; Lyle Swedberg, Secretary-Treasurer.

**Hawaii Chapter:**

James C. Samms, President; Alfred Preis, Secretary, 1507 Kapiolani Blvd., Honolulu, T. H.

phall, Draver Wilson and Charles Luckman all of Los Angeles.

Tolbert V. Anthony II, Compton; Robert O. Appleton, Donald R. Hollingsbery, John G. Minton and Grover W. Taylor, San Francisco; William E. Biurock, Laguna Beach; Alfred A. Boeke and Lawrence E. Harlow, Pasadena; Corwin Booth and James H. Hofmann, Oakland; Everett L. Child, Delma J. Daniel, Jr., Edward A. Killingsworth, Dixon D. Power and Paul L. Williamson, Long Beach.

Pierre P. Claeysens, Santa Monica; Edwin R. Cleaveland, Burbank; Rapiet R. Coghlan, San Gabriel; Joseph Colonelli, Riverside; Alvin K. Duse, Hayward; J. Thomas Erchul, San Diego; Donald G. French, San Bruno; Henry J. Friel, Redondo Beach; Wendell W. Galt, Canoga Park; John R. Harper, Concord; Robert W. Hunn, Jr., Culver City; Bernard Leuin, Van Nuys.

John B. Lundburg, South San Francisco; Gerald D. Matson, Belmont; Richard I. Mitcham, San Bernardino; Charles H. Mullen, Sacramento; Gale F. Parmelee, Whittier; Paul W. Reiter, Hollywood; Barron E. Sharp and Morris D. Verger, Inglewood; Donald M. Shaw, Walnut Creek; Victor K. Thompson and Ellis L. Jacobs, Palo Alto; Robert E. Wear, Berkeley; Russell J. Wood, La Crescenta; and Robert B. Wright, Redwood City.

**SOUTHERN CALIFORNIA CHAPTER**

The January meeting was the annual business session and installation of officers for the new year. Frank V. Mayo, President of the California Council of Architects made the installation this year and retiring Chapter president John Rex turned the gavel over to the new president John J. Landon. Guest speaker was Fred Beck, columnist of the Los Angeles Examiner. Other officers in-

stalled include: Chas. Frey, Vice-president; C. Day Woodford, Secretary; Wm. G. Balch, Treasurer, and Paul O. Davis, Henry Wright, John Rex, and Kemper Nomland were installed as Directors.

**BAXTER COMPANY SECURES THE CHEMONITE PROCESS FOR WOOD**

C. A. Chadbourne, General Manager of J. H. Baxter & Co., San Francisco, announces that J. H. Baxter & Co. have purchased from Dr. Aaron Gordon his rights to the Chemonite process for wood preservation for the states West of the Mississippi. The Chemonite process, developed over a period of years by Dr. Gordon and associates at the University of California, is the most outstanding development in the timber preservation field since creosote was first used for this purpose. It is suitable for the treatment of poles and piling as well as lumber.

Service records and tests by Governmental agencies and private users show Chemonite to be outstanding in many particulars. Recent availability of improved chemicals, including technically pure copper hydroxide, permits the Chemonite process to produce treated material which is clean, odorless, paintable and non-conductive to electrical current as well as being a permanently insoluble preservative. The Federal Government has included Chemonite in the new issue of the Federal Specifications, and many prominent Western utility and manufacturing organizations as well as American Association of State Highway Officials include it in their regular specifications.

Chadbourne stated it is the intention of the Baxter company to make the Chemonite process available at strategically located plants throughout the Western States.

# WITH THE ENGINEERS

## Structural Engineers Association of Northern California

John E. Rinne, President; John J. Gould, Vice-President; Wm. W. Brewer, Sec.; Franklin P. Ulrich, Treas.; Directors, Walter L. Dickey, Leslie W. Graham, Hyman Rosenthal, and Howard A. Schirmer.

## Structural Engineers Association of Central California

William H. Petersen, President; Walter S. Wassum, Vice President; O. T. Illerich, Sec. Treas.; Ernest D. Francis, M. A. Ewing, and Arthur A. Souer, directors. Office O. T. Illerich, c/o Div. of Arch., Sacramento.

## American Society of C. E. San Francisco Section

A. W. Earl, President; G. B. Woodruff, Vice President; C. T. Wiskocil, Vice President; R. D. Dewell, Secretary-Treasurer. Secretary's Office, 604 Mission Street, San Francisco.

## Structural Engineers Association of Southern California

Donald F. Shugart, President; Harold P. King, Vice President; Robert J. Short, sec. Treas.; Directors, William T. Wheeler, William T. Wright, Ernest C. Hillman, Jr., John Case, and John K. Minassian. Office, 202 Architects Bldg., Los Angeles 13.

## Structural Engineers Association of Oregon

R. Evan Kennedy, President; Guy H. Taylor, Vice President; James R. Griffith, Secretary-Treasurer; Directors Jerome A. McDevitt, H. Loren Thompson, and Robert L. Tidball. Offices, Portland.

## Puget Sound Engineering Council (Washington)

R. E. Kister, A. I. E. E., Chairman; E. R. McMillan, A. S. C. E., Vice Chairman; L. B. Cooper, A. S. M. E., Secretary; A. E. Nickerson, I. E. S., Treasurer. Offices, L. B. Cooper, c/o University of Washington, Seattle 5, Washington.

## AMERICAN SOCIETY OF CIVIL ENGINEERS

Organization of a new Engineering Mechanics Division of the American Society of Civil Engineers has been announced with the appointment of an executive committee to direct operations.

Object of the group will be to foster "activity and development in applied mechanics and other basic branches of knowledge, which form the background and foundation of the civil engineering profession."

Chairman of the new committee is Dr. L. E. Grinter, Member, ASCE; Research Professor of Civil Engineering and Mechanics at Illinois Institute of Technology. Committee members include:

Prof. Arthur T. Ippen, M. ASCE; Massachusetts Institute of Technology, Cambridge, Mass., Prof. Nathan M. Newmark, M. ASCE; University of Illinois, Urbana, Ill., Prof. Ralph E. Fadum, Associate M. ASCE; Head, Department of Civil Engineering, North Carolina State College, Raleigh, N. C., and Douglas McHenry, M. ASCE; Head of Structural Research Section, Bureau of Reclamation, Denver, Colorado.

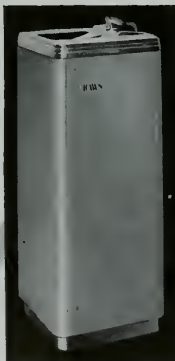

Always  
Specify

**Haws**

for Highest  
Quality

- Sanitary Drinking Fountains • Electric Water Coolers • Drinking Faucets, Equipment, Filters and Accessories.

A reputation for reliability since 1909.  
Check in Sweet's or write for complete Haws catalog.

**HAWS DRINKING FAUCET CO.**  
1441 FOURTH STREET (Since 1909) BERKELEY 10, CALIFORNIA  
Agents and Sales Representatives in All Principal Cities

## STRUCTURAL ENGINEERS ASSOCIATION SOUTHERN CALIFORNIA

The January meeting was devoted to a discussion of "The Material Supply Situation Today vs. Pre-World War II", with representatives of the Portland Cement Company, the Southwestern Cement Company, Columbia Steel Company, the U. S. Plywood Company, and Timber Products taking part.

On December 6th, the regular monthly dinner meeting was held with Ernest C. Hillman, winding up a most successful year as President.

Following the introduction of guests, President Hillman called for reports from the Chairman of all active 1950 committees, as well as a financial report from the Secretary-Treasurer, Bob Short. This portion of the meeting indicated all of the 1950 Committees had been quite active and there was no question but what the organization will greatly benefit from their conscientious efforts.

## ELECTION

The main item of business for the evening was the election of new officers for the coming year. The report of the Nominating Committee was submitted and as there were no nominations from the floor a vote was immediately taken. Unani-

mously elected for the year 1951 were the following officers:

President—Donald F. Shugart; Vice President—Harold P. King; Secretary-Treasurer—Robert J. Short; New Directors—William T. Wheeler and William T. Wright. Directors Held Over—Ernest C. Hillman, Jr. (Past President), John Case and John K. Minasian.

At the termination of the business meeting the installation of new officers was effected by the passing over of the gavel to incoming President Don Shugart.

Following the business meeting a film was exhibited showing the fabrication and erection of steel for the United Nations' Secretariat Building. The movie was presented by the Columbia Steel Company and covered all phases of the steel work of this most interesting project from the footing grillages to the framing of the roof. The film was in color and accompanied by a narrative description, insuring a most informative and pleasurable presentation.

#### STRUCTURAL ENGINEERS ASSOCIATION NORTHERN CALIFORNIA

John R. Stillinger, Chief of the Industrial Service Section of the Oregon Forests Products Laboratory spoke at the January meeting on the subject, "Recent Tests on Diagonal Sheathing".

He discussed recent tests on 24 quarter-scale models of diagonally sheathed shear walls and showed pictures and data that disclosed interesting and rather unexpected results.

#### ELECTED PRESIDENT

John E. Rinne, head of the civil engineer and architectural division for Standard Oil Company of California, San Francisco, has been elected president of the Structural Engineers Association of Northern California for the coming year.



JOHN E. RINNE  
SEANG President

Other directors named for the year include John J. Gould, vice president and Walter L. Dickey, Leslie W. Graham, Hyman Rosenthal, and Howard A. Schirmer.

Rinne has been chairman of a joint committee with the San Francisco section, American Society of Engineers, and was responsible for a recent study of the design and construction of buildings

and other structures to resist wind and earthquake. The committee's report has received worldwide attention. A new building code provision for lateral forces included in the report is presently being considered for adoption in San Francisco.

#### U. C. ENGINEERING EXTENSION NAMES NEW TERM INSTRUCTORS

Appointment of fifteen new instructors to the engineering teaching staff of University of California Extension has been announced by L. M. K. Boelter, Dean of the College of Engineering on the Los Angeles campus of the University of California and head of Engineering Extension.

The new faculty members, all of whom will conduct classes in the Los Angeles area, will begin teaching duties during the opening week of the spring semester, February 5.

Complete list of new instructors as released by Dean Boelter includes: George A. Hoffman, Jackson E. Wignot, Emil S. Mamrelli, Leon W. Camp, Robert Cornog, Richard B. Canright, Alexander A. Toben, Michael Dublin, Alan M. Firestone, James W. Dunham, Kenneth P. Peel, John H. Carr, Walter H. Munk, John D. Isaacs, and Robert S. Arthur.

Over 100 engineering courses planned for this area are offered in the spring curriculum.

# NOW

you can SPECIFY and GET

## IMMEDIATE DELIVERY

ON THE POPULAR

# HAWS

MODEL No. 7A

## DRINKING FOUNTAIN



For the complete line of highest quality

Fountains, Electric Water Coolers, Faucets,

Equipment, Filters and Accessories, check in

Sweet's or write for complete HAWS catalog.

A REPUTATION FOR RELIABILITY SINCE 1909

### HAWS DRINKING FAUCET CO.

1441 FOURTH STREET (Since 1909) BERKELEY 10, CALIFORNIA  
Agents and Sales Representatives in All Principal Cities

# PRODUCER'S COUNCIL PAGE

The National Organization of Manufacturers of Quality Building Materials and Equipment  
affiliated with the AMERICAN INSTITUTE OF ARCHITECTS

President, Arthur C. Staat  
Natural Gas Equipment, Inc.  
1150 Folsom Street

Vice-President, Fred A. Figone  
Otis Elevator Company  
1 Beach Street

Secretary, Howard Noleen  
E. F. Hauserman Company  
500 Second Street

Treasurer, A. L. West, Jr.  
Aluminum Company of America  
Russ Bldg.

Edited by Carl B. Frank, DETROIT STEEL PRODUCTS CO.

## PRODUCERS HOLD ANNUAL ELECTIONS OR QUICK DEMISE OF THE TWO PARTY SYSTEM

With the conclusion of a highly successful year in 1950, the time for elections was upon us once again. The year ended with the largest and best Christmas Jinx put on by any Chapter in the history of The Producers' Council, on December 1, at the Claremont Hotel, all thanks to the able guidance of George Conley, president for the preceding year.

The Grand Council of Past Presidents, better known as the Nominating Committee, got together, and when you consider the fact that you must have a waistline of at least 36" to sit in, came up with a very fine slate for our 1951 year which was unanimously approved by a vote of the membership at our first meeting of this year. The new President is Arthur C. Staat, Manager of the Space Heating Division of Natural Gas Equipment, Inc., and Art certainly has the background that is required for this position as he has been very active in our local Chapter for years. Not only has he been through most of the chairs, but has been a member of just about every committee that has had a place in the Council's activities. The new Vice President is Fred A. Figone of Otis Elevator Company; the Treasurer is A. L. West, Jr., of the Aluminum Company of America; and the Secretary is Howard Noleen of E. F. Hauserman Company. With the above gentlemen in office, we are most certainly assured of another highly successful year.



President  
**ARTHUR C. STAAT**  
Manager Space Heating Div.,  
Natural Gas Equipment, Inc.

The Council has a permanent group of six committees which are as follows, along with their chairmen:

Joint Technical Committee — Tait Smith, Ceco Steel Products Company.

Fellowship Committee — James R. Ferguson, Johns-Manville Sales Corporation.

Membership Committee — John Cowley, The Brookman Company.

Program Committee — Fred Figone, Otis Elevator Company.

Advisory Committee — George Conley, Johns-Manville Sales Corporation.

Public Relations — Carl Frank, Detroit Steel Products Company.

### Educational Committee

The Council is this year setting up a seventh committee to be known as the Educational Committee, headed by Herb Duncan of Natural Gas Equipment, Inc. This committee's main objective will be to put before the students of the University of California School of Architecture, various educational films put out by the member companies of the Council showing our better technical pictures. These pictures will preferably show the fabrication and/or erection of various products.

Herb is in a fine position to head this committee as he is a graduate of the School of Architecture at California. The instructors from the University for these sessions will be Michael Czaja and George Downes of the Architectural Department. The meetings will be held on every other Friday from 1:00 to 2:00 P.M. at the Auditorium of the Architecture Building on the Berkeley campus.

As this program is to be one of technical information as much as possible, it is the committee's intent to use those films which have a minimum amount of sales talk. We felt that it might be a good idea to have a representative of the Company sponsoring the film on hand to answer any

(See Page 35)

USE QUALITY PRODUCTS CONSULT AN ARCHITECT





## URBAN TRAFFIC

(From Page 8)

volume of the two-year "after" period as compared to the two year "before" period as compared to the Sacramento County shows the following affect upon retail business as a result of removing 21,800 vehicles per day from the main business street of North Sacramento.

All businesses combined: City +48.5%; County +27%. A difference in favor of the bypassed business district of approximately 21%. Cafes and bars in North Sacramento +13%; in the County +1.5%.

Next comes the surprising figure: service stations in North Sacramento +38.5. In Sacramento County +15%. All other business establishments except cafes, bars, and service stations show +54.5% in North Sacramento; +33% in the County.

In other words, the grocery, hardware, furniture, clothing and other normal commodity stores showed a 21½% greater increase in volume of retail sales in North Sacramento than in the other cities of Sacramento County.

Auburn: While North Sacramento lies immediately adjacent to a large industrial area, the City of Auburn, with a population of 4,577, is located 40 miles east of Sacramento also on U. S. Highway 40. It is at the westerly gateway of northern California's mountain and lake recreational areas —principal income derived from deciduous fruit ranches.

The Auburn study represents two years before and two years after November 1, 1947. The freeway circumventing the business district is two miles in length and approximately 5500 vehicles per day were removed from the business section.

What has happened to real estate values? We find 100% locations now selling at an average of \$300 to \$375 F. F., with a continued moderate uptrend in recent sales as compared to \$250 to \$300 F. F. sales during the prior two-year period.

What has happened to business? Auburn shows in the two year "after" period +17% as compared to +14% in other comparable cities. Service stations show a +17% in Auburn and a -4% in comparable cities. All other businesses show +20% as compared to the same +20% in comparable types of businesses in other localities.

Now, here are two interesting figures: Cafes and bars show a -6% in Auburn as compared to a -11% in all other comparable localities but parking meters in the city of Auburn show a +2½% increase in return in the two-year "after" period as compared to the two year "before" period.

Perhaps this substantial increase in parking

(See Page 43)

Men have Died for a Brand

Any good, modern-day cowboy — from 6 to 60 — can tell you the importance of a brand.

"You stole my brand, you rat — and now my six gun's agoin' to do my talkin' fer me! Bang!"

That was the Old West.

The new west pays less attention to cattle and more to houses. Thousands . . . maybe millions . . . are built out here every year. And a man can become pretty proud of the brand his house carries. In many cases the branding iron is in YOUR HANDS. You can give that house a good brand the buyer will brag about and fight for.

You can specify *Certified Adequate Wiring* in the plans and thereby brand that house as having the finest wiring it needs for years to come. You brand yourself, too, podner, as a "good guy" with your clients when you specify *Certified Adequate Wiring*.

And everybody knows the good guys always win.

**Northern California Electrical Bureau**  
1335 MARKET STREET - SAN FRANCISCO - 3

## Another famous western brand

The West's accepted brand of quality in lighting equipment. Look for this mark of excellence in meeting your lighting needs. Smoot-Holman illumination is distinguished by outstanding design, superior construction and economical performance in commercial, industrial and institutional uses.

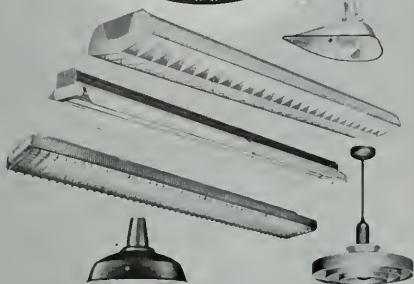

SMOOT-HOLMAN COMPANY, Inglewood, Calif. Offices in Principal Western Cities • Branch and Warehouse in San Francisco

## YOU PROTECT THESE WEAK SPOTS from termites and decay

1. SUB FLOOR
2. FLOOR JOISTS
3. MUDSILL

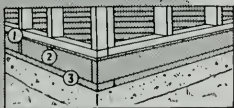

## WHEN YOU SPECIFY..



Refer to  
1949-1950  
AEC  
Catalogue for  
Complete  
specification data

# J. H. BAXTER & CO.

333 MONTGOMERY ST. - SAN FRANCISCO 4, CALIF. - DOUGLAS 2-3883

## NATIONAL HOSPITAL SURVEY

(From Page 11)

Locations for alarm sending stations are also recommended. "Every hospital of more than fifty beds and more than two stories in height shall be equipped with an approved interconnected fire alerting system suitable for alerting all persons charged with duties for patient care and all employees of the hospital who are within the building. The fire alerting system shall be capable of being operated from the telephone switchboard and the administrative office."

Hospitals should be patrolled thoroughly at least every hour of the day, the new code states, and sufficient personnel should be charged with responsibility for taking effective action in case of fire.

In existing buildings that do not meet code requirements for fire resistance or fire propagation, new provisions have been added. Wood frame buildings with floor areas up to 7500 square feet may be occupied in the two lower stories (but not in basements) when provided with automatic sprinkler protection, protection of vertical openings, and enclosed stairways. Buildings of masonry wall and wood joist or heavy timber construction may be occupied in the three lower stories (but not in basements) when all vertical openings are protected, stairways are properly enclosed, and automatic sprinklers are provided. Four stories may be occupied if walls, ceilings and partitions have a minimum fire rating of one hour. Buildings of fire resistive construction may be occupied in the eight lower stories when all vertical openings are protected and stairways are enclosed. Occupancy is limited to four stories if defined hazardous areas are not protected by an automatic sprinkler system.

Automatic fire detection systems or automatic sprinkler systems are now recommended for such hazardous areas as boiler rooms, rooms for storing combustible materials, carpenter shops, paint shops, and others, along with adequate supervision to assure satisfactory operation whenever they may be required.

The provisions described are but a small portion of the code for hospitals and sanitariums and indicate only the most important changes incorporated in the tenth edition. Other better-known provisions have been in effect for many years. These cover building construction, adequate exits, housekeeping, ramps, elevators, slide escapes, fire extinguishing equipment, signs and lighting, assembly halls, boiler rooms, air conditioning, and various conditions peculiar to hospitals and sanitariums.

## ENGINEERING EXHIBIT

(From Page 8)

gineers in designing the Northwestern Railroad. And to this day the engines run on the left-hand side of the track—according to the British practice.

With the introduction of steam power and the rapid economic expansion of the country, large manufacturing plants and major engineering works were developed and the need of civilian engineers was realized. Civil engineering was first taught in the 1820's. In the year 1852 the ASCE was founded. The designation civil engineer was quite different from that accepted today, being used to differentiate them from the specialized work of the military engineer. It included all branches of the engineering profession as well as architects. As the industrial revolution expanded to the giant concerns of today and as with the other professions, specialization became necessary. Various groups of engineers such as mining, mechanical, electrical, and chemical formed societies of their own, but all had their inception in the original society of civilian engineers founded in 1852.

### Modern Engineers

America today enjoys the highest standard of living of any nation in the world. With 6 per cent of the world's population it has 70 per cent of the world's automobiles, 50 per cent of the world's telephones, 48 per cent of the radios, and we produce 32 per cent of the world's manufactured goods. Without the engineer with his scientific background, mass production and mass distribution as we know it today would have been impossible. In general, he has been the unseen force behind management, operating under the aegis of our free-enterprise system that has made the United States the most powerful and prosperous nation in the world.

During the one hundred years that have passed since the founding of the American Society of Civil Engineers, the branches of the engineering profession have grown more specialized and less generally informed about the activity of the profession at large. The Centennial Convocation will give the engineers of the country an opportunity to attend meetings and hear technical papers of the other branches of engineering, and to obtain pertinent information on the developments available to them from specialties outside their own fields.

An important part of the Centennial of Engineering celebration will be an Exposition during the months of July, August, and September 1952. The incorporators of the Centennial of Engineering have stated, "The purpose of the Centennial Exposition should be to tell the story of engineering and industry to the general public." The story of engineering and industry is one story. To take either without the other would be almost impossible. For

this reason it is essential to the engineer that our industrial system be preserved on the same freely competitive basis on which it has been built.

This story will be told in many ways at the Exposition which will be held at the Chicago Museum of Science and Industry. First in public appeal will be a stage production in the thousand-seat main auditorium of the museum. This show will be a dramatic human interest pageant about America—how it grew and prospered over the years, and how it can continue to grow. The essential role of the engineer and his industrial machine will be woven into the story just as it has been woven into our daily lives.

### Engineering Museum

A permanent engineering exhibit will be built in the museum, where it may be open to visitors the year around for five years or more. This exhibit, occupying over eight thousand square feet of floor space, will utilize dioramas, models, and full-sized equipment to show the evolution of engineering and of the engineer over the last hundred years. This exhibit will contain examples of every field of engineering, and will be planned to show how the products of dozens of different specialties come together to make one complete complex machine.

An ideal setting for the Centennial Exposition is found in the Museum of Science and Industry, since it already contains scientific and industrial displays by many of the foremost companies in the United States. One of the many impressive exhibits is the full-scale coal mine. There are other exhibits in communication, transportation, and the sciences, which will be enlarged and expanded where needed for this great engineering fair.

---

## PRODUCERS COUNCIL

(From Page 32)

possible questions by the students. However, before being allowed to enter the gates of the Berkeley campus, each such representative must take an oath before a Notary Public that he is not armed, and that all blank contract forms have been left in the office.

The A.I.A. has for some time realized the value of selling their organization to the students, and have awarded medals in student competitions to accomplish this end. Our program will serve a double purpose in not only familiarizing the future architects with The Producers' Council, but also in improving the students' working knowledge with building materials.

## JUDSON PACIFIC-MURPHY CORP.

Steel Fabricators  
and  
Erectors

REINFORCING STEEL  
STRUCTURAL STEEL  
BRIDGE CRANES

4300 EASTSHORE HWY.  
EMERYVILLE, CALIF.

Phone:  
OL 3-1717

## CLINTON CONSTRUCTION CO. OF CALIFORNIA

General Contractors

923 FOLSOM STREET • SAN FRANCISCO

SUtter 1-3440

## HOGAN LUMBER CO.

Wholesale and Retail

LUMBER

MILL WORK • SASH & DOORS

Office, Mill, Yard and Docks  
SECOND AND ALICE STREETS • OAKLAND, CALIF.

Telephone GLencourt 1-6861



**SISALATION**  
REFLECTIVE INSULATION

**COSTS 50%  
LESS THAN "BULK" or  
"BLANKET" TYPES OF INSULATION**  
... AND, IN ADDITION, ACTS AS A VAPOR-  
BARRIER (MEETS FHA REQUIREMENTS). COSTS  
LESS TO APPLY. WRITE FOR SAMPLES AND  
FULL INFORMATION ON ALL USES!

The SISALKRAFT CO.

55 New Montgomery St. San Francisco 5, California

## BOOK REVIEWS PAMPHLETS AND CATALOGUES

**STRENGTH OF STAINLESS STEEL STRUCTURAL MEMBERS AS FUNCTION OF DESIGN.** By Michael Watter & Rush A. Lincoln. Allegheny Ludlum Steel Corp'n by The Republic Press, Pittsburgh, Pa. Price \$5.00.

This is the First Edition and contains for the most part data taken from the unpublished reports D-1 and 110 by Dr. Michael Watter and members of the Research and Development Department of The Budd Company. The material has been organized and supplemented by Dr. R. A. Lincoln of the Allegheny Ludlum Steel Corporation.

The volume contains numerous Charts, formulæ and illustration.

**THE ARCHITECTURE OF THE SOUTHWEST—Indian, Spanish, American.** By Trent E. Sanford, W. W. Norton & Company Inc., New York. Price \$5.00.

For centuries the American Southwest has been the scene of a continuous building tradition and this volume tells the story of the cliff dwellings and pueblos of pre-Spanish Indians; of the Spanish conquest and building of missions, churches, and presidios; of the westward expansion of Americans with highways and cities.

The author describes, with the aid of maps and many illustrations, the architecture of Texas, New Mexico, Arizona and California.

**PRODUCTION AND MARKETING OF ASPHALT TILE.** By Robert F. Lanzillotti, Bureau of Economic and Business Research, State College of Washington, Pullman, Washington. Price \$.75.

This study by the Author, who is Assistant Professor of Economics at the State College of Washington, examines the economic aspects of the production and marketing of asphalt tile. The purpose is twofold: to assemble economic data pertaining to this industry and to analyze the feasibility of producing asphalt tile in the Pacific Northwest.

The market; competitive aspects of the industry including pricing policies and practices; and future prospects are covered in the booklet.

Numerous tables and charts are used.

**CALIFORNIA CIVIL ENGINEER REGISTRATION EXAMINATIONS And Their Solutions.** By A. E. Waegemann, San Francisco. Price \$1.00.

This is a new supplement to the original publication of July 1949. Contains questions for the fall 1949 and spring 1950 Engineer in training and Professional Civil Engineer examinations—all questions given by the California State Board of Registration for Civil and Professional Engineers from 1940 to July 1949, together with their solutions in the original volume.

### NEW CATALOGUES AVAILABLE

Any of the catalogues or folders described here may be obtained by forwarding your request as indicated in the coupon below to the office of the ARCHITECT & ENGINEER. Merely mark the items you want and clip or paste the coupon to your letterhead.

#### 241. INSTRUCTION SHEET FOR STRAND GARAGE DOOR.

Instructions for installing the Strand 9-Foot Track-Type Garage Door is a new punched folder in the standard 8½ x 11" file size, just released by Strand Garage Door Division of Detroit Steel Products Company. This is a handy reference for dealers and builders, and also for distribution with the new 9-wide doors. Sketches, diagrams and photos show the simple step-by-step procedure in checking door openings, and installing the door. Four pages illustrated, 1-51.

#### 242. G. E. TEXTOLITE PLASTICS SURFACING.

A new bulletin, "G. E. Textolite Plastics Surfacing" has been published by General Electric's Chemical Department, with headquarters in Pittsfield, Mass., which illustrates in full color the new line of G-E Textolite colors and patterns which have been awarded the 1951 Fashion Academy Gold Medal for distinctive styling. Home applications for "Textolite", the registered trademark for General Electric's plastics surfacing, including kitchen counters, dinette tables, and bathroom lavatory vanities, are described



and complete construction details are given. 16 pages illus. CDL-18, 12-50.

**243. FIBERGLAS ACOUSTICAL TILE.** A design data sheet describing "Fiberglas Textured and Perforated Acoustical Tile" has been published by Owens-Corning Fiberglas Corp. The publication includes data on the textured and perforated acoustical products, application methods by adhesive, mechanical suspension or clipping on wood lurring strips and specifications. This design data sheet is another of the series that won certificates of merit awarded by the American Institute of Architects and Producers Council, Inc. for product literature of a character which best serves the architect in the selection and specification of building materials. A.I.A. 39-B, 8 pages illus., 10-50.

**244. VULCAN'S 1951 RADI-VECTOR CATALOG WITH I-B-R RATINGS.** The Vulcan Radiator Company of Hartford, Conn. recently announced its new Radi-Vector (Vulcan Baseboard) catalog (No. 53) containing up-to-date technical information helpful to engineers, contractors and architects in designing and installing Vulcan Radi-Vector (Baseboard) systems. The 1951 catalog gives the complete I-B-R ratings and pipe-sizing tables for use in designing Radi-Vector system in series; tables for use in designing 2-pipe steam systems, 2-pipe forced hot water systems, 2-pipe gravity hot water systems. 16 pages illus., No. 53, 1-51.

**245. EXPFRIMENTAL LAYOUT KIT.** 1/4" Scale Models. Designed to demonstrate the values obtained from 3-dimensional planning, "Visual" Planning Equipment Company has announced a 200 piece kit of machines, benches, trucks, conveyers, materials handling equipment, office and toilet equipment together with a 12" x 18" lucite planning board, columns and layout tape. The planning kit will not plan a specific plant, but will enable the user to test the merit of this type of planning before accepting or rejecting its values.

**246. TEST REPORT ON A SILICONE FORMATION FOR MASONRY WATER REPELLENT.** Without changing their appearance at all, porous masonry walls can now be made to shed water with a product said to work on an entirely different principle than previous types of transparent waterproofings. The product is easily brushed or sprayed on exterior, above-grade masonry walls of all types, including cinder block, concrete, brick, limestone and asbestos shingles. Copies of the Report are available without cost.

**247. MAINTENANCE COATING—Liquid, Air Curing.** A new brochure has been published showing the use of a new liquid maintenance that can be used on steel, wood, and cement. May be applied over old coatings and is temperature and abrasion resistant. Also resists fumes, acids, and oils, and may be applied with a minimum of effort.

**ARCHITECT AND ENGINEER**  
68 Post Street, San Francisco, Calif.

I would like to have a copy of each of the New Catalogues I have circled.

241            242            243            244  
245            246            247

Please send to the address on my letterhead, or as I have indicated, and to my attention. (Please print your name—no literature will be sent on this coupon after February, 1951.—A. & E.)

**COLLEGE OF ENGINEERING**  
**OFFICIALLY RECOGNIZED**

Approval of the College of Engineering on the Los Angeles campus of the University of California by the Committee on Engineering Schools of the Engineering Council for Professional Development has been announced.

Curriculum offered by the relatively new U. C. L. A. college was found worthy of accreditation after a thorough examination by the Council inspection committee.

**"AMERICAN - MARSH"**

CONDENSATION UNIT

Pumping  
Machinery  
for  
Every  
Purpose

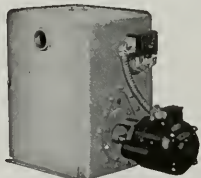

For Service  
Call  
DOuglas  
2-6794  
or  
MtuAl 8322

**SIMONDS MACHINERY CO.**  
SAN FRANCISCO            LOS ANGELES  
816 FOLSOM                455 EAST 4TH

**VERMONT**  
**MARBLE COMPANY**

DOMESTIC AND IMPORTED MARBLES  
GRANITE VENEER

525 MARKET STREET • SAN FRANCISCO

Phone: SUffer 1-6747

3522 COUNCIL STREET • LOS ANGELES

Phone: DUankirk 2-7831

**The Most Complete Line of**  
**STEELS and STEEL BUILDING MATERIALS**  
*Made by a Single Producer*



See Sweet's Catalog File or write us for  
full information.

**REPUBLIC STEEL CORPORATION**

GENERAL OFFICES: CLEVELAND, OHIO

DENVER, COLORADO . . . . . CONTINENTAL OIL BUILDING  
LOS ANGELES, CALIF. . . . . GENERAL PETROLEUM BUILDING  
SAN FRANCISCO, CALIFORNIA . . . . . RIALTO BUILDING  
SEATTLE, WASH. . . . . WHITE-HENRY-STUART BUILDING

**PACIFIC**  
**MANUFACTURING CO.**

*High Class Interior Finish Quality*  
*Millwork*

16 Beale St., San Francisco  
GARfield 1-7755

2215 El Camino Real, San Mateo  
S. M. 5-0687

304 Bryant Street, Palo Alto  
P. A. 3373

2610 The Alameda, Santa Clara  
S. C. 607 (Factory)

6820 McKinley Avenue, Los Angeles  
THornwall 4196

MAIN OFFICE — SANTA CLARA



## TREND IN HOME DEVELOPMENT IS UNCERTAIN

By CLIFFORD L. RAWSON

Secretary-Manager, Home Builders Institute, Inc.,  
Los Angeles, California

It is difficult to see a clearly defined pattern for home development in this country.

The Urban Land Institute, for example, is more frequently reporting the development of big concentrated housing projects—garden apartment developments especially.

A faint trend is indicated partially by the fact that in the more highly congested areas, in eastern portions of our country, garden-type and large-scale multiple housing in concentrated areas seems to be on the increase.

In the western half of our nation the opposite trend is evident. Relatively few large scale multiple developments have occurred, even in the more densely populated areas. The construction of apartment houses is on the wane. Single houses, duplexes, three and four-family dwellings constitute the large volume home building, particularly on the Pacific Coast; and this type of

residential construction appears to be on the upgrade.

Is it a matter of supply, demand or rent control? Which of these has most to do with influencing this situation is a matter of conjecture. The larger multiple housing developments of the east may be the result of necessity, due to density of population and scarcity of land. The Western and Southwestern areas of the United States are favored with conditions of low population density and ample land, plus a marked western psychology of living that demands more open space and greater freedom in out-of-door environment.

In the absence of a national pattern for housing the people of this country—excepting possibly trends influenced by government legislation imposed and administered by the Federal Housing Administration—it would appear a matter of good judgment and wisdom for Pacific Coast builders not to imitate construction patterns of the eastern part of the nation, especially when physical and economic conditions are quite dissimilar.

Logically then, building industry leaders of western states might well turn their attention to **research, surveys and studied solutions** of residential construction design peculiarly related to climate, topography, and living habits of people living in the west. Great advantages would accrue if such studies were made by architects and builders jointly, concurrently and continuously.

With the average family hard pressed to meet essential living costs: food, clothing, medical care and the ever increasing percentage of earnings being withheld from pay-checks for the payment of larger city, state and federal taxes, the possibilities of saving the amount of cash necessary for the first payment on a home under the new curbs is an utter impossibility.

## Looked into all these lately?

It's growing all the time—the list of uses for which gas is superior:

Cooking	House heating
Refrigeration	Clothes drying
Water heating	Garbage disposal
All-year air conditioning	

If your technical data files are low on any of these, why not get in touch with your Gas Company for details?

The West  
prefers

# GAS

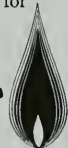

BETTER • QUICKER • CHEAPER

### ENGINEER KILLED IN KOREA

A recent casualty list of U. S. Army officers killed in the Korean action included the name of Col. Frank H. Forney, an officer in the Corps of Engineers for twenty-one years.

Col. Forney was District Engineer at Buffalo, N. Y., when the Korean hostilities started. His degree in civil engineering was received at the University of California in 1932.

• • •

LUDWIG Mies van der Rohe, former director of the Bauhaus in Dessau and one of the world's foremost modern architects, has designed the new 110 acre campus now under construction at Illinois Institute of Technology.

# ESTIMATOR'S GUIDE

## BUILDING AND CONSTRUCTION MATERIALS

PRICES GIVEN ARE FIGURING PRICES AND ARE MADE UP FROM AVERAGE QUOTATIONS FURNISHED BY MATERIAL HOUSES TO SAN FRANCISCO CONTRACTORS. 3% SALES TAX ON ALL MATERIALS BUT NOT LABOR

All prices and wages quoted are for San Francisco and the Bay District. There may be slight fluctuation of prices in the interior and southern part of the state. Freight charge, at least, must be added in figuring country work.

**BONDS—Performance or Performance plus Labor and Material Bond(s), \$10 per \$1000 on contract price. Labor & Material Bond(s) only, \$5.00 per \$1000 on contract price.**

### BRICKWORK—MASONRY—

Common Brick—Per 1 M laid—\$100.00 up (according to class of work).  
Face Brick—Per 1 M laid—\$200.00 and up (according to class of work).  
Brick Steps—\$3.00 and up.  
Common Brick Veneer on Frame Bldgs.—Approx. \$1.20 and up (according to class of work).  
Face Brick Veneer on Frame Bldgs.—Approx. \$2.00 and up (according to class of work).  
Common Brick—\$36.00 per M—truckload lots, delivered.  
Face Brick—\$81.00 to \$106.00 per M, truckload lots, delivered.

### Glazed Structural Units—

Clear Glazed—  
2 x 6 x 12 Furring.....\$1.50 per sq. ft.  
4 x 6 x 12 Partition.....1.75 per sq. ft.  
4 x 6 x 12 Double Faced  
Partition.....2.10 per sq. ft.  
For colored glass add.....25 per sq. ft.  
Mantel Fire Brick—\$100.00 per M—F.O.B. Pittsburgh.  
Fire Brick—Per M—\$106.00 to \$140.00.  
Cottage—Approx. \$9.00 per M.  
Paving—\$75.00.

**Building Tile—**  
8 5/8 x 12 inches, per M.....\$139.50  
6 5/8 x 12 inches, per M.....105.00  
4 5/8 x 12 inches, per M.....84.00  
**Hollow Tile—**  
12 x 12 x 2 inches, per M.....\$127.00  
12 x 13 inches, per M.....136.40  
12 x 14 inches, per M.....154.00  
12 x 16 inches, per M.....204.00  
F.O.B. Plant

### BUILDING PAPER & FELTS

1 ply per 1000 ft. roll.....\$5.30  
2 ply per 1000 ft. roll.....7.80  
3 ply per 1000 ft. roll.....9.70  
Brownkin, Standard 500 ft. roll.....6.85  
Sisal/lin, reinforced, 36 in. by 500 ft. roll.....7.00

**Sheathing Papers—**  
Asphalt sheathing, 15-lb. roll.....\$1.90  
" " " " 30-lb. roll.....2.66  
Dampcourse, 216 ft. roll.....2.10  
Blue Plysterboard, 60-lb. roll.....5.95

**Felt Papers—**  
Deadening felt, 3/4-lb., 50-ft. roll.....\$3.08  
Deadening felt, 1-lb.,.....3.61  
Asphalt roofing, 15 lbs.,.....1.90  
Asphalt roofing, 30 lbs.,.....2.66

**Roofing Papers—**  
Asphalt Rig., 15 lb.,.....\$2.09  
Standard Grade, 108-ft. roll, Light.....1.81  
" " " " " " Medium.....2.10  
" " " " " " Heavy.....2.49  
" " " " " " Extra Heavy.....2.88

### BUILDING HARDWARE—

Sash cord com. No. 7.....\$2.65 per 100 ft.  
Sash cord com. No. 8.....3.90 per 100 ft.  
Sash cord spf. No. 7.....3.65 per 100 ft.  
Sash cord spf. No. 8.....3.35 per 100 ft.  
Sash weights, cast iron \$100.00 ton.  
1-Ton lots, per 100 lbs.....\$4.75  
Less than 1-ton lots, per 100 lbs.....\$3.75  
1/2" Reg. base.....11.00  
8-in. spikes.....11.00  
Rim Knob lock sets.....1.80  
Butts, dull brass plated on steel, 3/2 x 3/2......71

### CONCRETE AGGREGATES—

The following prices net to Contractors unless otherwise shown. Carload lots only.

	Bunker Per ton	Del'd warehouse or del.; per ton
Gravel, all sizes.....	\$2.44	\$2.90
Top Sand.....	2.38	3.13
Concrete Mix.....	2.38	3.06
Crushed Rock, 1/4" to 3/4".....	2.38	2.90
Crushed Rock, 3/4" to 1 1/2".....	2.38	2.90
Roofing Gravel.....	2.81	2.90
River Sand.....	2.50	3.00
<b>Sand—</b>		
Lepis (Nos. 2 & 4).....	3.56	3.94
Olympic (Nos. 1 & 2).....	3.56	3.88

**Common** (all brands, paper sects), carload lots, \$3.39 per bbl. f.o.b. car; delivered \$3.60. Per Sack, small quantity (paper).....\$1.05  
Carload lots, in bulk per bbl.....2.79  
Cash discount on carload lots, 10c a bbl., 10th Prox., less than carload lots \$4.00 per bbl. f.o.b. warehouse or delivered.  
Cash discount 2% on L.C.L.

Trinity White { 1 to 100 sects, \$3.13 sect  
Madusa White { warehouse or del.; \$7.54  
bbl. carload lots.

### CONCRETE READY-MIX—

1-2-4 mix, to 10 yards.....\$12.00  
10 to 100 yards.....11.00  
100 to 500 yards.....10.50  
Over 500 yards.....10.30  
\* Delivered to site.

### CONCRETE BLOCKS—

	Hay-dite	Ba-salt
4x8x16-inches each.....	\$.17	\$.165
6x8x16-inches, each.....	.22	.22
8x8x16-inches, each.....	.24	.24
12x8x16-inches, each.....	.34	.39
12x8x24-inches, each.....	..	.60

**Haydite Aggregates—**  
3/4-inch to 1/2-inch, per cu. yd.....\$6.75  
1/2-inch to 3/8-inch, per cu. yd.....6.75  
No. 6 to 0-inch per cu. yd.....7.25

### DAMP-PROOFING and Waterproofing—

Two-coat work, \$9.00 per square.  
Membrane waterproofing—4 layers of saturated felt, \$10.00 per square.  
Hot coating work, \$5.00 per square.  
Medusa Waterproofing, \$3.50 per lb. San Francisco Warehouse.

Tricrete concrete waterproofing, 60c a cubic yd. and up.

**ELECTRIC WIRING—\$15 to \$20 per outlet for conduit work (including switches).**  
Knob and tube average \$6.00 per outlet.

### ELEVATORS—

Prices vary according to capacity, speed and type. Consult elevator companies. Average cost of installing a slow speed automatic passenger elevator in small four story apartment building, including entrance doors, about \$9,500.00.

### EXCAVATION—

Sand, \$1.00; clay or shale, \$1.50 per yerd. Trucks, \$30 to \$45 per day.

Above figures are an average without water. Steam shovel work in large quantities, less; hard material, such as rock, will run considerably more.

### FIRE ESCAPES—

Ten-foot galvanized iron balcony, with stairs, \$250 installed on new buildings; \$300 on old buildings.

### FLOORS—

Asphalt Tile, 1/2 in. gauge 18c to 35c per sq. ft.

Composition Floors, such as Magnesite, 50c per square foot.

Linoleum, standard gauge, sq. yd.....\$2.75

Mastipave—\$1.50 per sq. yd.

Battleship Linoleum—1/8"—\$3.00 sq. yd.

Terazzo Floors—\$1.50 per sq. ft.

Terazzo Steps—\$2.50 per lin. ft.

Mastic Wear Coat—according to type—20c to 35c.

### Hardwood Flooring—

Oak Flooring—T & G—Unfin.—

	1 1/2" x 2 1/2"	1 1/2" x 2"	3/4" x 2"	3/4" x 2 1/2"
Clear Old, White.....	\$425	\$405	\$	\$
Clear Old, Red.....	405	380	\$	\$
Select Old, Red or White.....	355	340		
Clear Pin, Red or White.....	340	335	315	
Select Pin, Red or White.....	340	330	325	300
#1 Common, Red or White.....	315	310	305	280
#2 Common, Red or White.....	305	300	295	270

### Unfinished Oak Flooring—

	Prime	Standard
1/2 x 2.....	\$349.00	\$359.00
1/2 x 2 1/2.....	380.00	370.00
3/4 x 2 1/2.....	390.00	381.00
3/4 x 2.....	375.00	355.00
3/4 x 3/4.....	395.00	375.00
3/4 x 2 1/4 Ranch Plank.....		415.00

### Unfinished Maple Flooring—

3/4 x 2 1/4 First Grade.....	\$390.00
3/4 x 2 1/4 2nd Grade.....	365.00
3/4 x 2 1/4 2nd & Btr. Grade.....	375.00
3/4 x 2 1/4 3rd Grade.....	240.00
3/4 x 3/4 3rd & Btr. Jrd. EM.....	380.00
3/4 x 3/4 2nd & Btr. Jrd. EM.....	390.00
3/4 x 2 1/4 First Grade.....	375.00
3/4 x 2 1/4 2nd Grade.....	365.00
3/4 x 2 1/4 2nd Grade.....	320.00
Floor Layer's Wage \$2.50 hr.	

### GLASS—

Single Strength Window Glass . . . \$30 per sq. ft.  
Double Strength Window Glass . . . 45 per sq. ft.  
Plate Glass, 1/4 polished to 75 . . . 1.60 per sq. ft.  
75 to 100 . . . 1.74 per sq. ft.  
1/4 in. Polished Wire Plate Glass . . . 2.35 per sq. ft.  
1/4 in. Rgh. Wire Glass . . . .71 per sq. ft.  
1/4 in. Polished Wire Plate Glass . . . 2.00 per sq. ft.  
1/4 in. Rgh. Wire Glass . . . .64 per sq. ft.  
1/2 in. Obscure Glass . . . .40 per sq. ft.  
1/2 in. Obscure Glass . . . .64 per sq. ft.  
1/2 in. Heat Absorbing Obscure . . . 58 per sq. ft.  
1/4 in. Heat Absorbing Wire . . . .86 per sq. ft.  
Glazing of above additional \$1.50 to 3.00 per sq. ft.  
Glass Blocks, set in place . . . 3.50 per sq. ft.

### HEATING—

Average, \$3.50 to \$4.00 per sq. ft. of radiation, according to conditions.  
Warm air (gravity) average \$64 per register.  
Forced air average \$91 per register.

### INSULATION AND WALLBOARD—

Rockwool Insulation—	
(2") Less than 1,000 □ ft.	564.00
(2") Over 1,000 □ ft.	59.00
Cotton Insulation—Full-thickness	
(3½")	\$95.50 per M sq. ft.
Insulation—Aluminum Insulation—Aluminum coated on both sides	\$23.50 per M sq. ft.
Tileboard—4/8" panel	\$9.00 per panel
Wallboard—1/2" thickness	\$55.00 per M sq. ft.
Finished Plank	\$49.00 per M sq. ft.
Ceiling Tileboard	\$69.00 per M sq. ft.

**IRON**—Cost of ornamental iron, cast iron, etc., depends on designs.

### LUMBER—

S4S No. 2 and better common	
O.P. or D.F., per M. f.b.m.	\$100.00
Rough, No. 2 common O.P. or	
D.F., per M. f.b.m.	100.00

### Flooring—

	Per M Devid.
V.G.—D.F. B & Btr. 1 x 4 T & G Flooring	\$25.00
"C" and better—all	\$25.00
"D" and better—all	25.00
Rwd. Rustic—"A" grade, medium dry	185.00
	B to 24 ft.

Plywood, per M sq. ft.	
1/4-inch, 4,08,0-515	\$170.00
1/2-inch, 4,08,0-515	250.00
3/4-inch, per M sq. ft.	315.00
Plywood	11½¢ per sq. ft.
Pyram	25¢ per sq. ft.

### Shingles (Rwd. not available)—

Red Cedar No. 1—\$9.50 per square; No. 2, \$7.00;	
No. 3, \$5.00.	
Average cost to lay shingles, \$6.00 per square.	
Cedar Shakes—1/2" to 3/4" x 24/26 in hand split tapered or split resawn, per square	\$15.25
3/4" to 1 1/4" x 24/26 in split resawn, per square	17.00
Average cost to lay shakes, —8.00 per square	
Pressure Treated Lumber—	
Walmalized	Add 35¢ per M to above
Created.	
8-lb. treatment	Add 45¢ per M to above

### MARBLE—(See Dealers)

### METAL LATH EXPANDED—

Standard Diamond, 3,40, Copper	
Bearing, LCL, per 100 sq. yds.	\$41.00
Standard Ribbed, ditto	\$43.00

### MILLWORK—Standard.

D. F. \$150 per 1000. R. W. Rustic \$175 per 1000 (delivered).	
Double hung box window frames, average with trim, \$12.50 end up, each.	
Complete door unit, \$15 to \$25.	
Screen doors, \$8.00 to \$12.00 each.	
Patent screen windows, \$1.25 e sq. ft.	
Cases for kitchen pantries seven ft. high, per lineal ft., upper \$9.00 to \$11.00; lower \$12.00 to \$13.00.	
Dining room cases, \$20.00 per lineal foot. Rough and finish about \$1.00 per sq. ft.	
Labor—Rough carpentry, warehouse heavy framing (average), \$75.00 per M.	
For smaller work average, \$85.00 to \$100. per 1000.	

### PAINTING—

Two-coat work	per yard 85¢
Three-coat work	per yard \$1.10
Cold water painting	per yard 25¢
Whitewashing	per yard 15¢

Linseed Oil, Strictly Pure	Wholesale
(8½¢ 7½ lbs. per gal.)	Raw
Light iron drums	per gal. \$1.92
5-gallon cans	per gal. 2.04
1-gallon cans	each 2.15
Quart cans	each .61
Pint cans	each .34
Turpentine	Pure Gum
(8½¢ 7.2 lbs. per gal.)	Spirits
Light iron drums	per gal. \$1.47
5-gallon cans	per gal. 1.59
1-gallon cans	each 1.71
Quart cans	each .51
Pint cans	each .28

Replacement Oil—\$2.75 per gal. in drums. \$2.75 per gal. in 5-gal. containers. Use Replacement Oil—\$3.00 per gal. in 1 gal. cont. A deposit of \$7.50 required on all drums.

### PATENT CHIMNEYS—

6-inch	\$2.50 lineal foot
8-inch	3.00 lineal foot
10-inch	4.00 lineal foot
12-inch	5.00 lineal foot

### PLASTER—

Neat wall, per ton delivered in S. F. in paper bags, \$17.60.

### PLASTERING (Interior)—

3 Coats, metal lath and plaster	Yard \$3.00
Keene cement on metal lath	3.50
Ceilings with 3/4 hot roll channels metal lath (lath only)	3.00
Ceilings with 3/4 hot roll channels metal lath plastered	4.50
Single partition 3/4 channel lath 1 side (lath only)	3.00
Single partition 3/4 channel lath 2 inches thick plastered	8.00
4-inch double partition 3/4 channel lath 2 sides (lath only)	5.75
4-inch double partition 3/4 channel lath 2 sides plastered	8.75
Thermax single partition; 1" channels; 2 1/4" overall partition width. Plastered both sides	7.50
Thermax double partition; 1" channels; 4 1/4" overall partition width. Plastered both sides	11.00
3 Coats over 1" Thermax nailed to one side wood studs or joists	4.50
3 Coats over 1" Thermax suspended to one side wood studs with spring sound insulation clip	5.00
Note—Channel lath controlled by limitation orders.	

### PLASTERING (Exterior)—

2 coats cement finish, brick or concrete wall	Yard \$2.50
3 coats cement finish, No. 18 gauge wire mesh	3.50
Line—\$4.00 per bbl. at yard.	
Processed LULME—\$4.15 per bbl. at yard.	
Rock or Grip Lath—3/4"—30¢ per sq. yd.	
"A"—27¢ per sq. yd.	

Composition Stucco—\$4.00 sq. yard (applied).

### PLUMBING—

From \$200.00 per fixture up, according to grade, quality and runs.

### ROOFING—

"Standard" tar and gravel, 4 ply—\$11.00 per sq. for 30 sqs. or over.	
Less than 30 sqs. \$14.00 per sq.	
Tile \$40.00 to \$50.00 per square.	
No. 1 Redwood Shingles in place.	
4/2 in. exposure, per square	\$18.25
5/2 No. 1 Cedar Shingles, 5 in. exposure, per square	14.50
5/8 x 16"—No. 1 Little Giant Cedar Shingles, 5" exposure, per square.	18.25
4/2 No. 1-24" Royal Cedar Shingles	
7/2" exposure, per square	23.00
Re-coat with Gravel \$5.50 per sq.	

Asbestos Shingles, \$27 to \$35 per sq. laid. 1/2 to 3/4 x 25" Resawn Cedar Shakes, 10" Exposure \$30.00. 3/4 to 1 1/4 x 25" Resawn Cedar Shakes, 10" Exposure \$35.00. 1 x 25" Resawn Cedar Shakes, 10" Exposure \$22.00. Above prices are for shakes in place.

### SEWER PIPE—

C.I., 6-in. to 24-in. B. & S. Class B and heavier, per ton	\$99.50
Vitrified, per foot:	
Standard, 8-in.	\$ .60
Standard, 12-in.	1.17
Standard, 24-in.	5.04
Clay Drain Pipe, per 1,000 L.F. in carload lots:	
Standard, 6-in.	\$225.00
Standard, 8-in.	375.00

### SHEET METAL—

Windows—Metal, \$2.50 a sq. ft. Fire doors (average), including hardware \$2.80 per sq. ft., size 12'x12'. \$3.75 per sq. ft., size 3'x6'.

### SKYLIGHTS—(not glazed)

Copper, \$1.25 sq. ft. (flat). Galvanized iron, 65¢ sq. ft. (flat). Vented hip skylights, \$1.50 sq. ft.

### STEEL—STRUCTURAL—

\$220 per ton erected, when out of mill. \$270 per ton erected, when out of stock.

### STEEL REINFORCING—

\$200.00 per ton, in place.	
1/4-in. Rd. (Less than 1 ton)	\$8.40
3/8-in. Rd. (Less than 1 ton)	7.30
1/2-in. Rd. (Less than 1 ton)	7.00
5/8-in. Rd. (Less than 1 ton)	6.75
3/4-in. & 7/8-in. Rd. (Less than 1 ton)	6.65
1-in. & up (Less than 1 ton)	6.60
1 ton to 5 tons, deduct 25¢.	

### STORE FRONTS (None available).

### TILE—

Ceramic Tile Floors—Commercial \$1.20 to \$1.60 per sq. ft.	
Cove Base—\$1.40 per lin. ft.	
Quarry Tile Floors, 6x6" with 6" base @ \$1.35 per sq. ft.	
Tile Wainscots & Floors, Residential, 4/4x4/4", @ \$1.65 to \$2.00 per sq. ft.	
Tile Wainscots, Commercial Jobs, 4/4x4/4" Tile, @ \$1.50 to \$1.65 per sq. ft.	
Asphalt Tile Floor 1/2" x 3/4" @ .18 - .35 sq. yd. Light shades slightly higher.	
Dark Tile—\$ .70 per sq. ft.	
Mosaic Floors—See dealers.	
Lino-Tile—\$1.00 per sq. ft.	
Rubber Tile—\$ .55 to \$ .75 per sq. ft.	
Wall Tile—Glazed Structural Units—	
2 x 6 x 12	\$1.50 sq. ft.
4 x 6 x 12	1.75 sq. ft.
4 x 6 x 12 Double Faced Partition	2.10 sq. ft.
For colored glaze, add .25 sq. ft.	
Building Tile—	
8 1/2"x12-inches, per M.	\$139.50
6 1/2"x12-inches, per M.	105.00
4 1/2"x12-inches, per M.	84.00
Hollow Tile—	
12x12x2-inches, per M.	\$116.00
12x12x3-inches, per M.	124.00
12x12x4-inches, per M.	140.00
12x12x6-inches, per M.	186.00
	F.O.B. Plant

### VENETIAN BLINDS—

75¢ per square foot end up. Installation extra.

### WINDOVS—STEEL—INDUSTRIAL

Cost depends on design and quality required.

# ARCHITECT AND ENGINEER ESTIMATOR'S DIRECTORY

## Building And Construction Materials

EXPLANATION—Building and construction materials are shown in major classified groups for general identification purposes with names and addresses of suppliers of materials listed in detail under group classification where name first appears—main offices are shown first, with branch or district offices following. The numeral appearing in listings refers to the major group classification where complete data on the dealer, or representative, may be found.

### ARCHITECTURAL VENEER (a)

**Ceramic Veneer**  
**PACIFIC CLAY PRODUCTS**  
 San Francisco: 605 Market St., GA 1-3970  
 Los Angeles, Portland, Salt Lake City  
**GLADDING, McBEAN & CO. \* (1)**  
**Porcelain Veneer**  
**PORCELAIN ENAMEL PUBLICITY BUREAU**  
 (Dept. AE-450)  
 Room 601, Franklin Building, Oakland 12, California  
 P. O. Box 186, East Pasadena Station, Pasadena 8,  
 California  
**Granite Veneer**  
**VERMONT MARBLE COMPANY**  
 San Francisco: 525 Market Street, SU 1-6747  
**Marble Veneer**  
**VERMONT MARBLE COMPANY**  
 San Francisco: 525 Market Street, SU 1-6747

### BRASS PRODUCTS (1a)

**GREENBERG'S, M. & SONS**  
 San Francisco, Calif.: 765 Folsom, EXbrook 2-3143

### BRICKWORK (1)

**Brick**  
**GLADDING, McBEAN & CO.**  
 San Francisco: Herrison at 9th Sts., UN 1-7400  
 Los Angeles: 2901 Los Feliz Blvd., OL 2121  
 Offices at Portland, Seattle, Spokane  
**KRAFTILE**  
 Niles, California, Niles 3611  
 San Francisco 5: 50 Hawthorne St., DO 2-3780  
 Los Angeles 13: 406 South Main St., MU 7241  
**REMILLARD-DANDINI CO.**  
 San Francisco: 400 Montgomery St., EX 2-4988

### IRON PRODUCTS (1b)

**GREENBERG'S M. & SONS**  
 San Francisco, Calif.: 765 Folsom, EXbrook 2-3143

### BUILDING PAPER & FELTS (2)

**SISALKRAFT COMPANY**  
 San Francisco: 55 New Montgomery St., EX 2-3066  
 Chicago, Ill.: 205 West Wacker Drive  
**ANGIER PACIFIC CORP.**  
 San Francisco 5: 55 New Montgomery St., DO 2-4416  
 Los Angeles: 7424 Sunset Boulevard

### BUILDING HARDWARE (3)

**THE STANLEY WORKS**  
 San Francisco: Monadnock Bldg., YU 6-5914  
 New Britain, Conn.

### CEMENT (c)

**PACIFIC PORTLAND CEMENT**  
 San Francisco: 417 Montgomery St., GA 1-4100

### CONCRETE AGGREGATES (4)

**Lightweight Aggregates**  
**AMERICAN PERLITE CORP.**  
 Richmond, Calif.: 26th & B Sts.—Yard 2, RI 4307

### FIRE ESCAPES (5)

**SOULE STEEL**  
 San Francisco: 1750 Army St., VA 4-4141  
 Los Angeles, Calif.—LA 0911  
 Portland, Ore.—BE 5155  
 Seattle, Wash.—SE 3010

### MICHAEL & PFEFFER IRON WORKS, INC. Shingles

San Francisco 3: Tenth & Harrison Sts.,  
 MA 1-5966

### FLOORS (6)

**Hardwood Flooring**  
**HOGAN LUMBER COMPANY**  
 Oakland: Second and Alice Sts., GL 1-6861  
**E. K. WOOD LUMBER CO.**  
 Los Angeles: 4710 S. Alameda St., JE 3111  
 Oakland: 727 Kennedy St., KE 4-8466  
 Portland: 827 Terminal Sales Building

### GLASS (7)

**W. P. FULLER COMPANY**  
 San Francisco: 301 Mission St., EX 2-7151  
 Los Angeles, Calif.  
 Portland, Oregon

### HEATING (8)

**HENDERSON FURNACE & MFG. CO.**  
 Sebastopol, Calif.  
**S. T. JOHNSON CO.**  
 Oakland 8: 940 Arlington Ave., OL 2-6000  
 San Francisco: 585 Potrero Ave., MA 1-2757  
 Philadelphia 8, Pa.: 401 No. Broad St.  
**SCOTT COMPANY**  
 San Francisco: 243 Minne St., YU 2-0400  
 Oakland: 113 - 10th St., GL 1-1937  
 San Jose, Calif.  
 Los Angeles, Calif.  
**THOMAS B. HUNTER (Designer)**  
 San Francisco: 41 Sutter St., GA 1-1164

### INSULATION AND WALLBOARD (9)

**LUMBER MANUFACTURING CO.**  
 San Francisco: 225 Industrial Ave., JU 7-1760  
**SISALKRAFT COMPANY \* (2)**  
**WESTERN ASBESTOS COMPANY**  
 San Francisco: 675 Townsend St., KL 2-3868  
 Oakland: 251 Fifth Avenue, GL 1-2345  
 Sacramento: 1224 I Street, 2-8993  
 Stockton: 1120 E. Weber Ave., 4-1863  
 Fresno: 1837 Merced Street, 3-3277  
 San Jose: 201 So. Market St., BA 4359-J

### IRON—Ornamental (10)

**MICHAEL & PFEFFER IRON WORKS, INC. \* (5)**

### LIGHTING FIXTURES (11)

**SMOOT-HOLMAN COMPANY**  
 Inglewood, Calif., OR 8-1217  
 San Francisco: 55 Mississippi St., MA 1-8474

### LUMBER (12)

**HOGAN LUMBER COMPANY \* (6)**  
**LUMBER MANUFACTURING CO. \* (9)**  
**E. K. WOOD LUMBER CO \* (6)**

**SIDEWALL LUMBER COMPANY**  
 San Francisco 24: 1995 Oakdale Ave., AT 2-8112

### MARBLE (13)

**VERMONT MARBLE COMPANY**  
 San Francisco: 525 Market St., SU 1-6747  
 Los Angeles 4: 3522 Council St., FA 7834

### METAL LATH EXPANDED (14)

**FORORDER CORNICE WORKS**  
 San Francisco: 269 Potrero Ave., HE 1-4100  
**SOULE STEEL \* (5)**

### MILLWORK (15)

**PACIFIC MANUFACTURING COMPANY**  
 San Francisco: 16 Beale St., GA 1-7755  
 Santa Clara: 2610 The Alameda, SC 607  
 Los Angeles: 6820 McKinley Ave., TH 4196  
**MULLEN MANUFACTURING COMPANY**  
 San Francisco: 60-80 Rausch St., UN 1-5815  
**LUMBER MANUFACTURING COMPANY \* (9)**

### PAINTING (16)

**Paint**  
**W. P. FULLER COMPANY \* (7)**

### PLASTER (17)

**Exteriors**  
**PACIFIC PORTLAND CEMENT COMPANY \* (4)**  
**Interiors—Metal Lath & Trim**  
**FORORDER CORNICE WORKS \* (14)**

### PLASTIC CEMENT (f)

**PACIFIC PORTLAND CEMENT CO.**  
 San Francisco: 417 Montgomery St., GA 1-4100

### PLUMBING (18)

**THE SCOTT COMPANY \* (8)**  
**THE HALSEY TAYLOR COMPANY**  
 Redlands, Calif.  
 Warren, Ohio  
**HAWS DRINKING FAUCET COMPANY**  
 Berkeley 10: 1435 Fourth St., LA 5-3341  
**CONTINENTAL WATER HEATER COMPANY**  
 Los Angeles 31: 1801 Pasadena Ave., CA 6178  
**SIMONDS MACHINERY COMPANY**  
 San Francisco: 816 Folsom St., DO 2-6794  
 Los Angeles: 455 East 4th St., MU 8322  
**SECURITY VALVE COMPANY**  
 Los Angeles 31: 410 San Fernando Rd., CA 6191  
**SEWER PIPE (19)**  
**GLADDING, McBEAN & CO. \* (1)**



PACIFIC CLAY PRODUCTS  
San Francisco: 605 Market St., GA 1-3970  
Los Angeles, Portland, Salt Lake City

SAN JOSE STEEL COMPANY  
San Jose: 195 North Thirtieth St., CO 4184

MICHEL & PFEFFER IRON WORKS, INC. \* (5)  
SOULE STEEL COMPANY \* (5)

**SHEET METAL (20)**

Windows  
DETROIT STEEL PRODUCTS COMPANY  
Oakland 8: 1310 - 63rd St., OL 2-8826  
San Francisco: Russ Building, DO 2-0890  
MICHEL & PFEFFER IRON WORKS, INC. \* (5)  
SOULE STEEL COMPANY \* (5)

Fire Doors  
DETROIT STEEL PRODUCTS COMPANY  
Sightings  
DETROIT STEEL PRODUCTS COMPANY

**STEEL—STRUCTURAL (21)**

COLUMBIA STEEL CO.  
San Francisco: Russ Bldg., SU 1-2500  
Los Angeles: 2087 E. Slauson, LA 1171  
Portland: 2345 N. W. Nicolai, BE 7261  
Seattle: 1331 3rd Ave. Bldg., MA 1972  
Salt Lake City: Walker Bank Bldg., SL 3-6733  
HERRICK IRON WORKS  
Oakland: 1818 & Campbell Sts., GL 1-1767  
JUDSON PACIFIC-MURPHY CORP.  
Emeryville: 4300 Eastshore Highway, OL 3-1717  
REPUBLIC STEEL CORP.  
San Francisco: 116 N. Montgomery St., GA 1-0977  
Los Angeles: Edison Building  
Seattle: White-Henry-Stuart Building  
Salt Lake City: Walker Bank Building  
Denver: Continental Oil Building  
KRAFTLIE COMPANY \* (1)

**STEEL—REINFORCING (22)**  
REPUBLIC STEEL CORP. \* (21)  
HERRICK IRON WORKS \* (21)  
SAN JOSE STEEL CO. \* (21)  
COLUMBIA STEEL CO. \* (21)

**TILE (23)**  
GLADDING, McBEAN & CO. \* (1)  
KRAFTLIE COMPANY \* (1)  
PACIFIC CLAY PRODUCTS  
San Francisco: 605 Market St., GA 1-3970  
Los Angeles, Portland, Salt Lake City

**TIMBER—REINFORCING (b)**

Trusses  
WEYERHAEUSER SALES CO.  
Tacoma, Wash.  
St. Paul, Minn.  
Newark, N. J.  
Treated Timber  
J. H. BAXTER CO.  
San Francisco: 4 333 Montgomery St., DO 2-3883  
Los Angeles 13: 601 West Fifth St., MI 6294

**WALL TILE (24)**

GLADDING, McBEAN & CO. \* (1)  
KRAFTLIE COMPANY \* (1)

**WINDOWS STEEL (25)**

DETROIT STEEL PRODUCTS CO. \* (20)

**GENERAL CONTRACTORS (26)**  
DINWIDDIE CONSTRUCTION COMPANY  
San Francisco: Crocker Building, YU 6-2718  
CLINTON CONSTRUCTION COMPANY  
San Francisco: 923 Folsom St., SU 1-3440  
MATCOX CONSTRUCTION COMPANY  
San Francisco: 604 Mission St., GA 1-5516  
PARKER, STEFFENS & PEARCE  
San Francisco: 135 So. Park, EX 2-6639  
STOLTE, INC.  
Oakland: 8451 San Leandro Blvd., TR 2-1064  
SWINERTON & WALBERG COMPANY  
San Francisco: 225 Bush St., GA 1-2980  
Oakland: 1723 Webster St., HI 4-9322  
Los Angeles, Sacramento, Denver  
P. J. WALKER COMPANY  
San Francisco: 391 Sutter St., YU 6-5916  
Los Angeles: 3920 Whiteside St., AN 9-8567

**TESTING LABORATORIES (ENGINEERS & CHEMISTS) (27)**

ABBOT A. HANKS, INC.  
San Francisco: 624 Sacramento St., GA 1-1697  
ROBERT W. HUNT COMPANY  
San Francisco: 251 Kearny St., EX 2-4634  
Los Angeles: 3050 E. Slauson, JE 9131  
Chicago, New York, Pittsburgh  
PITTSBURGH TESTING LABORATORY  
San Francisco: 651 Howard St., EX 2-1747

**BUILDING TRADES WAGE (JOB SITES) NORTHERN, CENTRAL AND SOUTHERN CALIFORNIA**

ATTENTION: The following are the PREVAILING hourly rates of compensation being paid and in effect by employers by agreement between employees and their union; or as recognized and determined by the U. S. Department of Labor. [Revised to Sept. 1, 1949.]

CRAFT	San Francisco		Alameda		Costa		Fresno		Sacramento		Clare		Solano		Stockton		Los Angeles		San Bernardino		San Diego		Barber		Kern
	San	Contra	San	Contra	San	Contra	San	Contra	San	Contra	San	Contra	San	Contra	San	Contra	San	Contra	San	Contra	San	Contra	San	Contra	
ASBESTOS WORKERS	\$2.16	\$2.16	\$2.16	\$2.16	\$2.16	\$2.16	\$2.16	\$2.16	\$2.16	\$2.16	\$2.16	\$2.16	\$2.16	\$2.16	\$2.16	\$2.16	\$2.16	\$2.25	\$2.25	\$2.25	\$2.25	\$2.25	\$2.25	\$2.25	\$2.25
BRICKLAYERS	2.00*	2.00	2.00	2.00	2.00	2.00	2.00	2.00	2.00	2.00	2.00	2.00	2.00	2.00	2.00	2.00	2.00	2.00	2.00	2.00	2.00	2.00	2.00	2.00	2.00
BRICKLAYERS, HODCARRIERS	2.25	2.25	2.25	2.25	2.25	2.25	2.25	2.25	2.25	2.25	2.25	2.25	2.25	2.25	2.25	2.25	2.25	2.25	2.25	2.25	2.25	2.25	2.25	2.25	2.25
CARPENTERS	2.16	2.16	2.175	2.175	2.175	2.175	2.175	2.175	2.175	2.175	2.175	2.175	2.175	2.175	2.175	2.175	2.175	2.20	2.20	2.20	2.20	2.20	2.20	2.20	2.20
CEMENT FINISHERS	2.00	2.00	2.00	2.00	2.00	2.00	2.00	2.00	2.00	2.00	2.00	2.00	2.00	2.00	2.00	2.00	2.00	2.00	2.00	2.00	2.00	2.00	2.00	2.00	2.00
ELECTRICIANS	2.50	2.50	2.50	2.25	2.25	2.50	2.50	2.50	2.50	2.50	2.50	2.50	2.50	2.50	2.50	2.50	2.50	2.50	2.50	2.50	2.50	2.50	2.50	2.50	2.50
ELEVATOR CONSTRUCTORS	2.25	2.45	2.45	2.45	2.45	2.45	2.45	2.45	2.45	2.45	2.45	2.45	2.45	2.45	2.45	2.45	2.45	2.25	2.25	2.25	2.25	2.25	2.25	2.25	2.25
ENGINEERS: MATERIAL HOIST	2.19	2.19	2.19	2.19	2.19	2.19	2.19	2.19	2.19	2.19	2.19	2.19	2.19	2.19	2.19	2.19	2.19	1.9875	1.9875	1.9875	1.9875	1.9875	1.9875	1.9875	1.9875
FILE DRIVER	2.44	2.44	2.44	2.44	2.44	2.44	2.44	2.44	2.44	2.44	2.44	2.44	2.44	2.44	2.44	2.44	2.44	2.32	2.32	2.32	2.32	2.32	2.32	2.32	2.32
STRUCTURAL STEEL	2.46	2.46	2.46	2.46	2.46	2.46	2.46	2.46	2.46	2.46	2.46	2.46	2.46	2.46	2.46	2.46	2.46	2.30	2.30	2.30	2.30	2.30	2.30	2.30	2.30
GLAZIERS	2.00	2.00	2.00	2.00	2.00	2.00	2.00	2.00	2.00	2.00	2.00	2.00	2.00	2.00	2.00	2.00	2.00	2.00	2.00	2.00	2.00	2.00	2.00	2.00	2.00
IRONWORKERS: ORNAMENTAL	2.35	2.35	2.35	2.35	2.35	2.35	2.35	2.35	2.35	2.35	2.35	2.35	2.35	2.35	2.35	2.35	2.35	2.25	2.25	2.25	2.25	2.25	2.25	2.25	2.25
REINF. RODMEN	2.25	2.25	2.25	2.25	2.25	2.25	2.25	2.25	2.25	2.25	2.25	2.25	2.25	2.25	2.25	2.25	2.25	2.28	2.28	2.28	2.28	2.28	2.28	2.28	2.28
STEELWORKERS	2.50	2.50	2.50	2.50	2.50	2.50	2.50	2.50	2.50	2.50	2.50	2.50	2.50	2.50	2.50	2.50	2.50	2.30	2.30	2.30	2.30	2.30	2.30	2.30	2.30
LABORERS: BUILDING	1.55	1.55	1.45	1.45	1.55	1.45	1.55	1.45	1.55	1.45	1.55	1.45	1.55	1.45	1.55	1.45	1.55	1.45	1.45	1.45	1.45	1.45	1.45	1.45	1.45
CONCRETE	1.55	1.55	1.55	1.45	1.55	1.45	1.55	1.45	1.55	1.45	1.55	1.45	1.55	1.45	1.55	1.45	1.55	1.45	1.45	1.45	1.45	1.45	1.45	1.45	1.45
LATHERS	2.8125	2.8125	2.8125	2.8125	2.8125	2.8125	2.8125	2.8125	2.8125	2.8125	2.8125	2.8125	2.8125	2.8125	2.8125	2.8125	2.8125	2.50	2.50	2.50	2.50	2.50	2.50	2.50	2.50
MARBLE SETTERS	2.375	2.375	2.375	2.375	2.375	2.375	2.375	2.375	2.375	2.375	2.375	2.375	2.375	2.375	2.375	2.375	2.375	2.25	2.25	2.25	2.25	2.25	2.25	2.25	2.25
MOOSAIC & TERRAZZO	2.00	2.00	2.00	2.00	2.00	2.00	2.00	2.00	2.00	2.00	2.00	2.00	2.00	2.00	2.00	2.00	2.00	2.00	2.00	2.00	2.00	2.00	2.00	2.00	2.00
PAINTERS	2.15**	2.15**	2.15**	2.15**	2.15**	2.15**	2.15**	2.15**	2.15**	2.15**	2.15**	2.15**	2.15**	2.15**	2.15**	2.15**	2.15**	2.22	2.22	2.22	2.22	2.22	2.22	2.22	2.22
PLEDRIVERS	2.25	2.25	2.25	2.25	2.25	2.25	2.25	2.25	2.25	2.25	2.25	2.25	2.25	2.25	2.25	2.25	2.25	2.33	2.33	2.33	2.33	2.33	2.33	2.33	2.33
PLASTERERS	2.8125	2.8125	2.8125	2.8125	2.8125	2.8125	2.8125	2.8125	2.8125	2.8125	2.8125	2.8125	2.8125	2.8125	2.8125	2.8125	2.8125	2.50	2.50	2.50	2.50	2.50	2.50	2.50	2.50
PLASTERERS, HODCARRIERS	2.50	2.25*	2.25*	1.775*	2.00*	2.00*	2.00*	2.00*	2.00*	2.00*	2.00*	2.00*	2.00*	2.00*	2.00*	2.00*	2.00*	2.15	2.15	2.15	2.15	2.15	2.15	2.15	2.15
PLUMBERS	2.50	2.50	2.50	2.50	2.50	2.50	2.50	2.50	2.50	2.50	2.50	2.50	2.50	2.50	2.50	2.50	2.50	2.50	2.50	2.50	2.50	2.50	2.50	2.50	2.50
ROOFERS	2.25	2.25	2.25	1.875	2.00	2.00	2.00	2.00	2.00	2.00	2.00	2.00	2.00	2.00	2.00	2.00	2.00	2.25	2.25	2.25	2.25	2.25	2.25	2.25	2.25
SHEET METAL WORKERS	2.25	2.25	2.25	2.125	2.30	2.40	2.125	2.30	2.40	2.125	2.30	2.40	2.125	2.30	2.40	2.125	2.30	2.15	2.15	2.15	2.15	2.15	2.15	2.15	2.15
SPRINKLER FITTERS	2.50	2.50	2.50	2.50	2.50	2.50	2.50	2.50	2.50	2.50	2.50	2.50	2.50	2.50	2.50	2.50	2.50	2.25	2.25	2.25	2.25	2.25	2.25	2.25	2.25
STEAMFITTERS	2.50	2.50	2.50	2.50	2.50	2.50	2.50	2.50	2.50	2.50	2.50	2.50	2.50	2.50	2.50	2.50	2.50	2.50	2.50	2.50	2.50	2.50	2.50	2.50	2.50
STONESETTERS (MASONS)	3.00	2.8125	2.8125	2.25*	2.8125	2.8125	2.8125	2.8125	2.8125	2.8125	2.8125	2.8125	2.8125	2.8125	2.8125	2.8125	2.8125	1.50	1.50	1.50	1.50	1.50	1.50	1.50	1.50
TILESSETTERS	2.75	2.675	2.675	2.15	2.00	2.675	2.675	2.675	2.675	2.675	2.675	2.675	2.675	2.675	2.675	2.675	2.675	2.50	2.50	2.50	2.50	2.50	2.50	2.50	2.50

\* 6 Hour Day. \*\* 7 Hour Day.

Prepared and compiled by:

CENTRAL CALIFORNIA CHAPTER, ASSOCIATED GENERAL CONTRACTORS OF AMERICA, with the assistance and cooperation of secretaries of General Contractor Associations and Builders Exchanges of Northern California; and the above information for southern California is furnished by the Labor Relations Department of the Southern California Chapter, ASSOCIATED GENERAL CONTRACTORS OF AMERICA.

**CLASSIFIED ADVERTISING**

RATE: 20c PER WORD ... CASH WITH ORDER

MINIMUM \$5.00

**PLANNING CHURCH BUILDINGS.** Portland—64 oversized pages 144 cuts; floor plans, exterior and interior views; recently planned buildings costing \$30,000 upward. Largest collection plans of Protestant churches assembled. Price \$2.00 p.p. WRITE Bureau of Architecture, 300 Fourth Ave., New York 10, N. Y.

**BUILDERS!** You can make more money; get information you need before it is published elsewhere; Subscribe to the daily ARCHITECTS REPORTS, only \$10.00 per month. Complete information from ARCHITECTS REPORTS, 68 Post Street, San Francisco. Phone Douglas 2-8311.

**ADVERTISERS** wishing to sell building materials and products, GET THE BEST RESULTS from regular advertising schedules in ARCHITECT & ENGINEER magazine. Write for complete information, including rates, circulation, etc., 68 Post Street, San Francisco.

GET THE BEST, don't be satisfied with anything but the best. Window sash, Doors, Cabinets, etc. Town Talk Sash & Door Mill, 524 9th St., Sacramento.

**PHOTOGRAPHY.** For the best in construction photography, including exterior and interior, aerial, and progress views . . . you will find as many others have that it's the SKELTON STUDIO'S, 137 Harlan Place, San Francisco. Telephone YUkon 6-6321.

**FLOOR COVERINGS** for industrial, commercial, and residential construction. Complete lines, one of the oldest, best established organizations in the Sacramento Valley. LATIN'S, INC., 1519 Alhambra Blvd., Sacramento.



## URBAN TRAFFIC

(From Page 33)

meter income would indicate that there is a considerably larger volume of buying traffic now entering the business district, while a considerably reduced number of non-buying through vehicles are stopping in Auburn to patronize the cocktail bars.

A total of 89 business establishments were included in the Auburn study. Fourteen new retail business outlets opened in newly constructed store buildings since the freeway was open to traffic; these are not included in the study.

Fairfield: A city of 3,603 population. The new bypass misses Fairfield by approximately 2½ miles, is 4.7 miles long as compared to the old route, 6.3 miles long. The bypass carries approximately 12,000 vehicles per day. The main business street of Fairfield now has approximately 25% of its "former" volume of traffic.

Period of study one year "before" as compared to one year "after" July 1, 1949.

100% business locations show sales of \$350 to \$400 F. F., after opening of the new freeway—an increase of approximately 17%. The trend indicates a general increase. What has happened to retail business?

Cafes and bars in Fairfield show a decrease of 30% as compared to a decrease of 5.6% in other comparable cities in Solano County. Service stations show a —33% in Fairfield as compared to —9.8% in other Solano County cities.

But here again comes a very interesting figure. All other types of business; namely, the stable, permanent merchants, including the grocer, the hardware store, furniture, wearing apparel, etc., shows in Fairfield +22.6% as compared to +8.5% in the other cities of the County and a 3.1% increase in parking meter income in the "after" period as compared to the "before" period.

The increase in parking meter income clearly indicates an increase in the volume of buying traffic using the main business street in Fairfield.

Frontage Roads: Perhaps some information regarding roadside business establishments along frontage roads in rural areas will be brought out later. However, if your highway engineers can not or will not fully justify the freeway bypass they are not entitled to your support. If they can and do justify the freeway bypass, you owe them your full support when the noisy minority, the selfish with political strength, or the misinformed well meaning groups, attack the program. Your lack of support of a sound, well justified freeway improvement today can mean misplaced, improperly designed highways and economic distortion tomorrow.

## Parker, Steffens & Pearce

BUILDERS

135 South Park, San Francisco

Phone: EXbrook 2-6639

## FORDERER CORNICE WORKS

Manufacturers of

Hollow Metal Products • Interior Metal Trim  
Elevator Fronts and Cabs  
Metal Plaster Accessories • Sanitary Metal Base  
Flat and Roll Metal Screens  
Metal Cabinets • Commercial Refrigerators

269 POTRERO AVE.

SAN FRANCISCO, CALIF.

HEMLOCK 1-4100

## VALUABLE NEWS SERVICE

- BUILDING MATERIAL DEALERS
- CONTRACTORS
- ENGINEERS
- FINANCIAL INSTITUTIONS

ARCHITECTS REPORTS gives advance news on construction projects in Northern California, lists: name of projects, location, architect, proposed cost and other pertinent information.

HANDY individual slip-reports, issued daily at a total cost of only  
\$10 a month

## ARCHITECT'S REPORTS

Published Daily

The ARCHITECT and ENGINEER, Inc.

68 Post Street, San Francisco - DO 8311

## CONSTRUCTION CONTRACTS AWARDED AND MISCELLANEOUS PERSONNEL DATA

**BEAMER GRAMMAR SCHOOL ADDITION.** Woodland, Yolo County. Woodland Board of Education, owner. 6 classrooms, toilet room, \$149,995. ARCHITECT: Dragon, Schmidts & Hardman, Berkeley. Frame & stucco & brick veneer. GENERAL CONTRACTOR: G. S. Herrington, Auburn.

**NEW GRAMMAR SCHOOL.** Santa Rosa, Sonoma County. Wright Elementary School District, owner. 8 classrooms, offices, etc. & toilet room, \$171,261. ARCHITECT: J. Clarence Feliciano, Santa Rosa. Frame & stucco construction. GENERAL CONTRACTOR: Francies Construction Co., Santa Rosa.

**MOTEL BUILDING.** Oakland, Alameda County. August Maquet, owner. 63 rooms & baths, \$120,000. DRAFTSMAN: Martin McPeak, Oakland. 2 story, frame & stucco construction.

**OFFICE REMODEL.** Sacramento, Sacramento County. W. P. Fuller & Co., owner. \$53,635. ARCHITECT: Kohlb & Fisher, Sacramento. GENERAL CONTRACTOR: Lawrence Construction Co., Sacramento.

**CATERERIA BUILDING.** McFarland Kern County. McFarland Union High School District, owner. \$149,941. ARCHITECT: Wright, Metcalf & Parsons, Bakersfield. Frame & stucco construction, tile roof. GENERAL CONTRACTOR: Ashby & Opperman, Bakersfield.

**GYMNASIUM, SHOWER & LOCKER BUILDING.** Strathmore, Tulare County. Strathmore Union High School District, owner. \$193,708. ARCHITECT: Robt. G. Gaestner, Visalia. GENERAL CONTRACTOR: L. H. Hansen & Son, Fresno.

**GRAMMAR SCHOOL ADDITION.** Pleasanton, Alameda County. Pleasanton Elementary School District, owner. \$73,997. ARCHITECT: Ralph N. Kerr, Oakland. Frame & stucco construction. GENERAL CONTRACTOR: Steadman & Powell, Oakland.

**BANK BUILDING REMODEL.** San Francisco, Anglo Calif. Nat'l Bank, owner. \$80,000. ARCHITECT: Appleton & Wolford, San Francisco. 1 story & basement, complete interior & exterior remodel, ceramic veneer exterior. GENERAL CONTRACTOR: Stolte, Inc., Oakland.

### PANACALITE

The Standard for Perlite Aggregates  
An Engineered Product—Engineering  
Service

Air Classified—Sized & Graded for  
Plaster, Concrete & Stucco  
Aggregates

Listed Underwriters' Laboratories  
Re-examination Service

Fire Ratings:  
Non-Bearing Walls—2 hours  
Floor and Beam—4 hours  
Column—2 & 3 hours  
Suspended Ceiling—4 hours  
Others

Manufactured by  
American Perlite Corporation  
26th & B Sts.—Yard 2—Richmond  
BECen 5-1385

**OFFICE & WAREHOUSE.** Santa Rosa, Sonoma County. Wellman Peck & Co., owner. Fire rebuild, \$80,000. ENGINEER: H. L. Marchand, San Francisco. 1 story brick & structural steel frame, wood roof, concrete floor. GENERAL CONTRACTOR: Swinerton & Walberg, San Francisco.

**RED CROSS BUILDING REMODEL.** Berkeley, Alameda County. Berkeley Red Cross, owner. \$59,000. ARCHITECT: Walter T. Steilberg, Berkeley. Interior & exterior remodel. GENERAL CONTRACTOR: C. M. Teigland, Berkeley.

**GRAMMAR SCHOOL.** Healdsburg, Sonoma County. Alexander Valley Elementary School District, owner. 4 classrooms, offices & toilet room, \$74,702. ARCHITECT: C. A. Caultkins, Santa Rosa. Frame & stucco construction, concrete floors, asphalt tile & radiant heating. GENERAL CONTRACTOR: D. L. Fawell, Santa Rosa.

**GRAMMAR SCHOOL ADDITION.** Glen Ellen, Sonoma County. Dunbar Union Elementary School District, owner. 3 classrooms, kindergarten, toilet room, \$89,000. ARCHITECT: J. Clarence Feliciano, Santa Rosa. Frame & stucco construction, concrete floors, wood sash. GENERAL CONTRACTOR: Francies Construction Co., Santa Rosa.

**EI CAMINO HIGH SCHOOL ADDITION.** Fair Oaks, Sacramento County. San Juan Union High School District, owner. Home making unit, \$89,000. ARCHITECT: Chas. F. Dean, Sacramento, frame & stucco construction. GENERAL CONTRACTOR: Arthur Odman, Fair Oaks.

**CLAREMONT JR. HIGH SCHOOL ADDITION.** Oakland, Alameda County. Oakland Board of Education, owner. Classrooms, shop & cafeteria, \$364,821. ARCHITECT: John B. Anthony, Oakland. Frame & Stucco construction, 27,000 sq. ft. GENERAL CONTRACTOR: John E. Branagh & Son, Piedmont.

**CHURCH.** Richmond, Contra Costa County. Mira Vista Congregation Church, owner. \$62,666. ARCHITECT: Kirby & Mulvin, San Francisco. 6,000 sq. ft., frame & stucco construction, some structural steel, concrete basement, radian heating. GENERAL CONTRACTOR: Geo. W. Bates, Oakland.

**CRAWFORD VILLAGE SCHOOL.** Concord, Contra Costa County. Mt. Diablo Unified School District, owner. 11 classrooms, administration, kindergarten, multi-purpose room, library, toilet rooms, \$318,780. ARCHITECT: Reynolds & Chamberlain, Anderson & Simonds, Confer & Willis, & John Lyon Reid, Oakland. Frame & stucco construction. GENERAL CONTRACTOR: Robt. Bardell, Oakland.

**OFFICE BUILDING.** Mt. View, Santa Clara County. Geo. Wagner, owner. \$60,000. ENGINEER: Hall & Pregnoff, San Francisco. 1 story, frame & stucco construction, concrete floor. GENERAL CONTRACTOR: Wagner & Martinez, San Francisco.

**OFFICE & STORE BUILDING ADDITION.** Palo Alto, Santa Clara County. Pedro De Lemos, owner. \$63,000. ARCHITECT: Wm. F. Hempel, Palo Alto. 2½ story, reinforced concrete & frame construction. GENERAL CONTRACTOR: Wells P. Goodenough, Palo Alto.

**STOCK CELLAR BUILDING.** Oakland, Alameda County. Goebel Brewing Company of California, owner. \$150,000. ENGINEER: W. Adrian, San Francisco. 1 story, reinforced concrete construction. GENERAL CONTRACTOR: Cahill Construction Co., San Francisco.

**STORE & OFFICE BUILDING.** Sacramento, Sacramento County. Paul Prom, owner. \$300,000. ARCHITECT: Rickey & Brooks, Sacramento. 2 story, 80 x 160, brick & frame construction, air conditioning, insulation.

**GRAMMAR SCHOOL ADDITION.** Pleasanton, Alameda County. Pleasanton Elementary School District, owner. \$75,365. ARCHITECT: Ralph N. Kerr, San Francisco. Frame & stucco construction. GENERAL CONTRACTOR: Steadman & Powell, Oakland.

**FRANK OTIS PRIMARY SCHOOL.** Alameda County. Alameda Board of Education, owner. 8 classrooms, kindergarten, multi-use room & toilet room. ARCHITECT: Kent & Haas, San Francisco. Frame & stucco construction, concrete piling. GENERAL CONTRACTOR: California Builders Co., Oakland.

**COURTHOUSE REMODEL.** Fairfield, Solano County. County of Solano, owner. \$30,517. ARCHITECT: Harry J. Devine, Sacramento. Interior remodel. GENERAL CONTRACTOR: J. A. Bryant, Vallejo.

**VETERINARY HOSPITAL.** Richmond, Contra Costa County. Dr. S. R. Roberts, owner. \$24,000. ARCHITECT: Paul Hammarberg, Berkeley. 1 story, concrete block & frame construction. GENERAL CONTRACTOR: Carl Overea & Co., Richmond.

**NEW GRAMMAR SCHOOL.** Santa Rosa, Sonoma County. Wright Elementary School District, owner. 8 classrooms, offices, etc. & toilet room, \$171,261. ARCHITECT: J. Clarence Feliciano, Santa Rosa. Frame & stucco construction. GENERAL CONTRACTOR: Francies Construction Co.

**GREGORY GARDEN SCHOOL.** Concord, Contra Costa County. Mt. Diablo Unified School District, owner. 14 classrooms, toilet rooms, 2 kindergartens, library, multi-use room, administration, \$439,400. ARCHITECT: Reynolds & Chamberlain, Anderson & Simonds, Confer & Willis & John Lyon Reid, Oakland. Frame and Stucco construction. GENERAL CONTRACTOR: David Zuckerman, Walnut Creek.

**NEW BANK BUILDING.** Oakland, Alameda County. Crocker First National Bank, owner. \$831,000. ARCHITECT: Milton Fluesser, San Francisco. 2 story & basement, 100 x 100, reinforced concrete & structural steel construction, terra cotta exterior, red granite base. GENERAL CONTRACTOR: Dinwiddie Construction Co., San Francisco.

**CHAPEL.** Palo Alto, Santa Clara County. Roman Catholic Archbishop of San Francisco, owner. \$65,000. ARCHITECT: Vincent G. Raney, San Francisco. Brick & frame & stucco construction. GENERAL CONTRACTOR: Wells P. Goodenough, Palo Alto.

**CHURCH & PARISH HALL.** Berkeley, Alameda County. Roman Catholic Archbishop of S. F., owner. St. Ambrose Parish, \$343,653. ARCHITECT: Vincent Buckley, San Francisco. 1 story & basement, reinforced concrete construction, structural steel roof trusses. GENERAL CONTRACTOR: Carrico & Gautier, San Francisco.

**SOCIAL WELFARE BUILDING.** Modesto, Stanislaus County. County of Stanislaus, owner. \$146,058. ARCHITECT: Russel G. DeLappe, Berkeley. 2 story, concrete block and frame construction. GENERAL CONTRACTOR: Stille, Inc., Monterey.

**MARKET BUILDING COMPLETION.** Kentfield, Marin County. Gelice Guasco, owner. Interior completion of 4,800 sq. ft. Frame and stucco construction building, \$25,000.

**CHURCH.** Santa Rosa, Sonoma County. Roman Catholic Archbishop of S. F., owner. 600 seats. St. Eugene's Parish, \$178,429. ARCHITECT: J. Clarence Felciano, Santa Rosa. Reinforced concrete construction, wood roof trusses, tile roof. GENERAL CONTRACTOR: D. L. Fauli, Santa Rosa.

**OFFICE BUILDING REMODEL.** San Francisco, California Teachers Association, owner. \$100,000. ARCHITECT: Donald Beach Kirby & Thos. B. Mulvin, San Francisco. General interior remodel. GENERAL CONTRACTOR: Swinerton & Walberg, San Francisco.

**NEW GRAMMAR SCHOOL.** Stockton, San Joaquin County. Montezuma Elementary School District, owner. 22 classrooms, offices, kindergarten, multi-purpose and kitchen, home making, shop, toilet rooms, \$436,400. ARCHITECT: Mayo & Johnson, Stockton. Frame and stucco construction, concrete floor, asphalt tile, radiant heating. GENERAL CONTRACTOR: Nomellini Construction Co., Stockton.

**NEW JUNIOR HIGH SCHOOL.** San Luis Obispo, San Luis Obispo County. San Luis Obispo High School District, owner. \$465,861. ARCHITECT AND ENGINEER: Falk & Booth, San Francisco. Junior High. Frame and stucco construction. GENERAL CONTRACTOR: Moino Construction Co., San Luis Obispo.

**GRAMMAR SCHOOL.** Linden, San Joaquin County. Bellotta Elementary School District, owner. 2 classrooms, office and toilet room, \$34,935. STRUCTURAL ENGINEER: Walter A. Buehler, Sacramento. Prefabricated frame construction. GENERAL CONSTRUCTION: Harold DeWitt, Stockton.

**GRAMMAR SCHOOL ADDITION.** Ophir, Placer County. Ophir Elementary School District, owner. 2 classrooms, \$25,704. ARCHITECT: Gordon Stafford, Sacramento. Frame and stucco construction. GENERAL CONTRACTOR: G. S. Herrington, Auburn.

**GRAMMAR SCHOOL ADDITION.** Yuba City, Sutter County. Britton Elementary School District, owner. 1 classroom and toilet rooms, \$27,000. ARCHITECT: Chas. F. Dean, Sacramento. Prefab. frame construction, concrete floor. GENERAL CONTRACTOR: Wm. Shedd, Yuba City.

**GRAMMAR SCHOOL.** Marina, Monterey County. Marina Elementary School District, owner. \$109,215. ARCHITECT: Robert Stanton, Carmel. Frame and stucco construction. GENERAL CONTRACTOR: Fremont Construction Co., Castroville.

**GRAMMAR SCHOOL BUILDING.** Florin, Sacramento County. Florin Elementary School, owner. 10 classrooms, kindergarten, administration, all-purpose room, kitchen, toilet room, \$303,816. ARCHITECT: Koblik & Fisher, Sacramento. Frame and stucco construction. GENERAL CONTRACTOR: United Construction Co., Sacramento.

**HOME FOR AGED.** Fresno, Fresno County. Sisters of Nazareth, owner. \$270,000. ARCHITECT: Vincent Buckley, San Francisco. 1 story, frame and stucco construction, tile roof, wood sash, linoleum and carpet floors. GENERAL CONTRACTOR: Midstate Construction Co., Fresno.

**ADMINISTRATION BUILDING.** Salinas, Monterey County. Salinas High School District, owner. \$47,000. ARCHITECT: Chos. E. Butner, Salinas. Frame construction, wood exterior, shake roof. GENERAL CONTRACTOR: Geo. L. Fisk, Salinas.

**PAROCHIAL SCHOOL AND CONVENT ADDITION.** Napa, Napa County. Roman Catholic Archbishop of San Francisco, owner. 4 classrooms and addition to convent, \$133,722. ARCHITECT: Vincent Buckley, San Francisco. Reinforced concrete and frame construction. GENERAL CONTRACTOR: Carlen Construction Co., San Francisco.

**RESIDENCE.** Hillsborough, San Mateo County. John Sommer, owner. \$44,500. ARCHITECT: F. H. Reimers & Paul C. Overmite, San Francisco. GENERAL CONTRACTOR: R. F. Royden, San Mateo.

**STORE BUILDING.** Oakland, Alameda County. Ben Lam, owner. \$58,977. STRUCTURAL ENGINEER: J. Y. Long Co., Oakland. 1 story, 100x100, reinforced concrete and frame construction. GENERAL CONTRACTOR: Van Bokkelen-Cole Co., Oakland.

**MEDICAL BUILDING ADDITION.** Sacramento, Sacramento County. Sacramento Holding Co., owner. 6 suites of offices, \$70,898. ARCHITECT: Herbert E. Good Pastor, Sacramento. 1 story, frame and stucco construction, brick veneer, composition roofing, concrete floor. GENERAL CONTRACTOR: Holdener Construction Co., Sacramento.

**TAMALPAIS VALLEY SCHOOL.** Mill Valley, Marin County. Mill Valley Elementary School District, owner. 4 classrooms, administration and toilet room, \$111,567.

ARCHITECT: Alfred W. Johnson, San Francisco. Frame and stucco construction. GENERAL CONTRACTOR: S. & Q. Construction Co., San Francisco.

**STORE AND APARTMENT BUILDING.** San Mateo, San Mateo County. Sam J. Curusis, owner. \$76,900. ENGINEER: Chos. Coburn, San Jose. 2 story, 32x100 reinforced concrete and frame construction. GENERAL CONTRACTOR: Howard J. White, Palo Alto.

**GRAMMAR SCHOOL ADDITION.** San Jose, Santa Clara County. Franklin-McKinley Elementary School District, owner. 3 classrooms, 2 kindergartens, administration 7 all-purpose room, \$142,219. ARCHITECT: Kress & Gibson, San Jose. Frame and stucco construction. GENERAL CONTRACTOR: Carl N. Swenson Co., San Jose.

## MONSON BROS.

building  
construction

475 Sixth Street San Francisco 3  
Douglas 2-5357

### Make your new homes more livable with built-in conduit and outlets



You're building extra convenience into your homes when you put concealed telephone wiring and built-in outlets in your plans. You're making it easy for your customers to add new extensions as they're needed . . . without boring holes or having exposed wiring.

Tiny details like these are the signs of a thoughtful builder. For built-in conduit and extra outlets will save your customers time and money later on. For free help, call your local Pacific Telephone office and ask for "Architects and Builders Service."

Put built-in telephone facilities in your plans

The Pacific Telephone and Telegraph Company





## IN THE NEWS

### SCHOOL BIDS REJECTED

The Delhi Elementary School District (Merced County) rejected a bid of \$200,000 for the construction of a 10 classroom, office and toilet building to be of reinforced concrete, structural steel and frame construction.

The firm of Easterly, Ellenwood, Easterly, Architects, Watsonville are the architects.

### BONDS VOTED

Voters of the Pixley Union High School District (Tulare County) recently approved a bond issue of \$131,000 for the construction of additions to the Pixley Union High School.

A State Aid Loan of \$950,000 has also been approved for the project.

### BONDS VOTED

Voters of the San Jose Elementary School District of Ignacio (Marin County) have approved \$90,000 in bonds for the construction of a new Grammar School in Ignacio. The State has approved a State Aid Loan of \$600,000 for the same project.

John Lyon Reid of San Francisco is the architect.

### DETENTION HOME

The County Board of Supervisors of Nevada County (California) are building a 1-story, reinforced concrete Juvenile Detention Home in Nevada City at a cost of \$35,000.

## ACOUSTI CELOTEX

Sound Conditioning  
... combines the  
correct materials and  
25 years experience  
in every type, size  
and technique of  
acoustical installation

Acoustical Contractors

## WESTERN ASBESTOS COMPANY

San Francisco: 675 Townsend, KL 2-3868  
Oakland: 251 Fifth Avenue, GL 1-2345  
Sacramento: 1224 Eye Street, GL 2-8991  
Stockton: 733 So. Van Buren St., 4-1863  
Fresno: 434 "P" Street, 2-1600  
San Jose: 460 Park Avenue, CY 3-1317

Geo. C. Sellon of Sacramento is the architect.

### BRANCH BANK

The Bank of America, San Francisco, has announced the construction of a new Branch Bank building in Oakland at a cost of \$475,000.

The building will be of 1-story and basement construction.

### NEW MANUFACTURING PLANT FOR SOUTH

Ground has been broken for the construction of a \$500,000 factory and office building for M. Jackman & Sons in Los Angeles. The structure will contain 40,000 sq. ft. on two floors; completely air conditioned and modern in every respect.

Albert Schwartz is the Architect. Winter Construction Company the builder.

### SCHOOL BONDS VOTED

Electors of the Belmont Elementary School District (San Mateo County) have approved a bond issue of \$68,000 for the construction of an addition to the Louis Barrett grammar school and for the construction of a new Homewood School. Approved also was a State Aid Loan for \$410,480.

Ponsford & Price of Oakland are the architects.

### COMMUNITY HOSPITAL

The Peninsula Hospital District of Hillsborough (California) recently announced completion of plans calling for a 100-bed Community Hospital.

Cost is estimated at \$2,950,000, according to D. D. Stone and Lou Mulloy, architects.

### NEW RESIDENCES

Kay-Rousseau, Inc. of Mill Valley have started the construction of 42 new residences in the Hesperian Blvd., Teakwood, Cottonwood street district in Hayward.

Oliver Rousseau Company of San Francisco is the general contractor.

### ARCHITECT SELECTED

Architect Peter L. Sala of Stockton has been commissioned by the City of Stockton to draft plans for a new Library Building. Estimated cost of the new building is \$1,250,000.

### CAL-VET NEEDS HOME APPRAISERS

The heavy volume of "Cal-Vet" farm and home financing has made necessary the employment of additional experienced property appraisers by the California Department of Veterans Affairs, it was recently announced by D. J. Callaghan, Jr., State Director of Veterans Affairs.

The State is purchasing more than 800 farms and homes a month for resale to veterans on long term, low interest purchase contracts.

### ACQUIRE LUMBER YARD

Russ Boyd and Charles Darnell have assumed ownership and management of the E. K. Wood lumber yard in Riverside, California, and have changed the name of the firm to Boyd-Darnell Lumber Company.

Darnell and Boyd are well known in southern California where they have spent many years in the retail lumber business.

### MIDWINTER HOUSING CONFERENCE SET

The midwinter housing conference, designed to focus industry attention on the

problems particular to the merchant home-building industry, has been set for February 13-14 in Washington, D. C.

Sponsored by the Southwest Research Institute's Division of Housing and Construction Technology, many men prominent in architecture, building, home finance, real estate, and building materials distribution will be in attendance.

### PENINSULA BUILDERS EXCHANGE MOVES

The Peninsula Builders Exchange recently moved into new quarters in Belmont.

Unique feature of the new offices is a display of original drawings and photographs pertaining to the construction industry.

### APPOINTED SALES REPRESENTATIVE

Ralph Mills and Company of San Francisco have been appointed sales representative in the Bay Area for the J. C. Peterson Company of Alhambra, manufacturers of flush doors and partitions.

### NAMED PRESIDENT OF SOCIETY OF DESIGNERS

Marshall Morrison, Beverly Hills builder and home stylist, has been named President of the American Society of Designers.

As head of the Society, Morrison will participate in awarding of recognition in the field of home design in a program designed to "cite winners for advancements made in contributing to contemporary living through functional design."

### GYM BID REJECTED

The Merced Union High School District recently rejected a bid of \$247,300 for the construction of a new gymnasium building for the Livingston High School. Plans called for the construction of a reinforced concrete, concrete block and frame building.

Frank Wynkoop & Associates of Fresno are the architects.

### INSURANCE BUILDING FOR SACRAMENTO

The California Western States Life Insurance Company announced awarding of a contract to Swinerton & Walberg, general contractors of San Francisco, for the construction of a new three story and basement Home Office Building in Sacramento at a cost of \$1,500,000.

The site at the corner of 21st and L streets has been obtained and the architectural firm of Masten & Hurd of San Francisco have been commissioned to draft plans for the building.

### ARCHITECT SELECTED

Thomas P. Dunlap, architect of Chico (California), has been selected by the County of Butte to draft plans for a new Health Center building to be built in Oroville.

Estimated cost of the building is \$40,000.

### STATE BUILDERS HIT BUILDING CODES

Walter B. Mellott, Newport Harbor contractor and president of the California State Builders Exchange, declared recently the "No. 1 objective of the State group is to eliminate overlapping building codes."

"There are twelve different State agencies that concern themselves with building regulations and setting up laws that overlap each other. There are local building codes as well," and Mellott said "The situation is further confused by the fact

### Thinking of Building?

From our cost records and experience, an advance estimate may be made from decidedly general information. Based on our knowledge of labor and material costs, gained on current jobs, such an estimate may be helpful in determining your construction program.

**SWINERTON & WALBERG CO.**  
ALL TYPES CONSTRUCTION  
SAN FRANCISCO - SACRAMENTO  
OAKLAND - LOS ANGELES - DENVER

### STATIONERY SCHOOL & OFFICE SUPPLIES

•  
Printing Engraving  
Announcements

•  
CENTER STATIONERY  
468 McAllister

San Francisco UN 1-3703

### MULLEN MFG. COMPANY

—  
BANK, STORE AND OFFICE  
FIXTURES—CABINET WORK  
OF GUARANTEED QUALITY  
CHURCH SEATING

—  
Office and Factory  
40-80 RAUSCH ST., Bet. 7th and 8th Sts.  
San Francisco  
Telephone UNderhill 1-5815

*Fine*  
**ENGRAVINGS**



**POOR  
RICHARD**  
PHOTO ENGRAVING CO.  
320-324 COMMERCIAL STREET  
SAN FRANCISCO 11

that some of these agencies have retroactive power, causing added expense to the builder."

The State group is seeking to aid builders to meet current conditions in the construction industry.

Mellott was formerly president of the Orange County Builders Association and is active in building activities throughout southern California.

### ARCHITECT SELECTED HOUSING PROJECT

The Housing Authority of the City of San Pablo (Contra Costa County) have commissioned the architectural firm of Miller & Warnecke of Oakland, to draft plans for the construction of a 100 unit low income housing project in San Pablo.

### HOTEL ADDITION

The Fairmont Hotel, Mason and California streets, San Francisco, recently announced plans for the construction of a 32-story addition to the Hotel at an estimated cost of \$7,000,000.

The addition will contain seven floors of offices and the balance of the structure will contain 400 rooms and baths. There will be a skyroom on the roof.

Lewis P. Hobart and Ralph Kerr, and Hertzka & Knowles of San Francisco are the architects.

### SCHOOL BONDS LOSE

Voters of the Sonoma Valley Union High School District rejected a proposed \$435,000 bond issue recently. Funds were to be used for the construction of a new Junior High School building in the City of Sonoma.

### NEW RESIDENCES FOR SAN JOSE

The McKeon Construction Company of San Jose have started construction on a group of 107 new residences in San Jose.

The homes are of frame and stucco construction and will cost about \$8,000 each.

### LOW INCOME HOUSING PROJECT

The Housing Authority of the City of Fresno approved construction of a 224-unit low income housing project at an estimated cost of \$1,500,000. Units are of frame and stucco construction with a plywood interior.

Walter Wagner of Fresno is the architect.

### SCHOOL GYM BID REJECTED

The Oraville Union High School District recently rejected a bid of \$332,450 for the construction of a new reinforced concrete gymnasium building.

E. Geoffry Bangs, San Francisco, is the architect.

### STORE BUILDING

Bids have been received by Woolworth Company for the construction of their new building at 870 Market Street, San Francisco.

The site is presently occupied by the famed Flood Building, one of the larger office buildings of the city. The Flood Building will be razed to make way for the new three story plus basement store building.

### ARCHITECTS SELECTED

The architectural firm of Barovetto & Thomas of Sacramento have been commissioned to draw plans for the construction of a new City Hall for the City of Napa.

Estimated cost of the project is \$250,000.

## DINWIDDIE CONSTRUCTION COMPANY

•  
**BUILDERS**  
•

CROCKER BUILDING  
SAN FRANCISCO



## HERRICK IRON WORKS

STRUCTURAL STEEL  
REINFORCING STEEL

18TH AND CAMPBELL STS.  
OAKLAND, CALIF.  
Phone GLencourt 1-1747

Phone GARfield 1-1144

## Thomas B. Hunter

DESIGNER OF HEATING

AIR CONDITIONING  
VENTILATING AND WIRING  
SYSTEMS, MECHANICAL  
AND ELECTRICAL EQUIP-  
MENT OF BUILDINGS



41 SUTTER STREET  
ROOM 710

San Francisco California

## Scott Company

HEATING • PLUMBING  
REFRIGERATION



San Francisco  
Oakland  
San Jose  
Los Angeles



## A. F. MATTOCK CO.

Builders



212 CLARA STREET  
SAN FRANCISCO

Subscribe  
Now —

**ARCHITECT  
and  
ENGINEER**

**\$3.00  
Per Year**

## STOLTE INC.

General Contractors



OAKLAND • CALIFORNIA

## PITTSBURGH TESTING LABORATORY

ENGINEERS AND CHEMISTS

Testing and Inspection of Concrete,  
Steel and Other Structural Materials

Design of Concrete Mixes

Offices in all principal cities

651 Howard St., San Francisco 5  
EXbrook 2-1747

## Index to Advertisers

AMERICAN Perlite Corp.,	44
ANGIER Pacific Corp.,	48
ARCHITECTS Reports	43
BAXTER & Company, P. H.	34
CLASSIFIED Advertising	42
CENTER Stationery	47
CLINTON Construction Company	36
COLUMBIA Steel Co.,	*
CONTINENTAL Water Heater Co.,	*
DINWIDDIE Construction Co.,	47
FULLER, W. P. Co.,	*
FORDERER Cornice Works,	43
GLADDING McBean & Company,	*
GREENBERG'S, M. Sons,	*
HANKS, Inc., Abbott A.,	48
HAWS Drinking Faucet Co.,	30 & 31
HERRICK Iron Works,	47
HOGAN Lumber Co.,	36
HUNT, Robert W., Company	48
HUNTER, Thos. B.,	47
JOHNSON, S. T. Co.,	*
JUDSON, Pacific-Murphy Corp.,	36
KRAFTILE Company	28
MARBLE Institute of America	2
MATTOCK, A. F. Co.,	48
MICHEL & Pfeffer Iron Works,	1
MONSON Bros.,	45
MULLEN Mfg. Co.,	47
NORTHERN California Electric Bureau	33
PACIFIC Clay Products Co.,	*
PACIFIC Coast Gas Association	38
PACIFIC Manufacturing Company,	27
PACIFIC Portland Cement Company	Back Cover
PACIFIC Telephone & Telegraph Co.	45
PARKER, Steffens & Pearce	5 & 43
PITTSBURGH Testing Laboratory,	48
POOR Richard Engraving Co.,	47
PORCELAINE Enamel Architectural Division, Publicity Bureau,	*
REMILLARD-Dandini Co.,	48
REPUBLIC Steel Corporation	37
SCOTT Co.,	47
SIMONDS Machinery Company,	37
SISALKRAFT Company	36
SMOOT-Holmen Co.,	34
SOTO, Henry; Landscape	27
STANLEY Works, The	26
STOLTE, Inc.,	48
SWINERTON & Walberg Co.,	47
U. S. Bonds	Inside Back Cover
UNITED STATES Steel Corp.,	*
VERMONT Marble Company	37
WESTERN Asbestos Company,	46

\*Indicates Alternate Months

## ABBOT A. HANKS, INC. Engineers & Chemists

INSPECTING — TESTING — CONSULTING  
CONCRETE • STEEL • MATERIALS  
CHEMICAL AND TESTING  
LABORATORIES  
• RESEARCH AND INVESTIGATION •

TESTS OF STRUCTURAL MATERIALS  
DESIGN OF CONCRETE MIXES  
SHOP AND ERECTION INSPECTION OF  
STRUCTURES AND EQUIPMENT  
INVESTIGATION OF STRUCTURES  
AND MATERIALS  
TESTS AND INVESTIGATION OF  
FOUNDATION SOILS  
FIRE RESISTANCE AND INSULATION  
TESTS

624 Sacramento Street, San Francisco

## ROBERT W. HUNT CO.

ENGINEERS

INSPECTING TESTING

STRUCTURAL MATERIALS  
CONCRETE MIX DESIGN  
CHEMICAL ANALYSIS  
EQUIPMENT

PRINCIPAL CITIES  
UNITED STATES • EUROPE  
SAN FRANCISCO LOS ANGELES  
PORTLAND SEATTLE

## REMILLARD-DANDINI Co.

Brick and  
Masonry Products



400 MONTGOMERY STREET  
SAN FRANCISCO, CALIF.

**Brownskin**  
**VAPORSEAL**

The resilient building paper creped to S-T-R-E-T-C-H

Quality Products Since 1895  
**ANGIER PACIFIC CORPORATION**  
15 NEW MONTGOMERY ST. SAN FRANCISCO 3, CALIF. • 7624 SHENLEY BOULEVARD LOS ANGELES 66, CALIF.  
A complete line of Angier products available from your building material dealer

# ARCHITECT AND ENGINEER

CLARENCE WALKER FLOWER SHOP—Portland, Oregon



WALTER GORDON, Architect

FEBRUARY

1951

# Porcelain ENAMEL VENEER

... offers unlimited expression of architectural design in never-fading colors to match any exact specifications. This lightweight, *modern facing* material provides speed of construction ... fire-safety ... weather resistance and lifetime economies for any building, new or old.



FRANK WERNER



Frank Werner Building, San Francisco  
Hertzka & Knowles, Architects  
Jacks & Irvine, Contractors

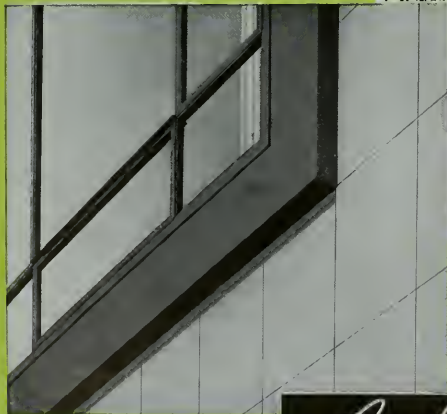

*Architectural Division*

PORCELAIN ENAMEL PUBLICITY BUREAU  
P. O. BOX 176, EAST PASADENA STATION, PASADENA 9, CALIFORNIA  
ROOM 501, FRANKLIN BUILDING, OAKLAND 12, CALIFORNIA

Write today for details and specifications

# ARCHITECT

Vol. 184

No. 2

# AND ENGINEER

ARCHITECTS' REPORTS—Published Daily

## Contents for

# FEBRUARY

EDWIN H. WILDER  
Editor

MARK DANIELS, A.I.A.  
Associate Editor

J. WELLS HASTINGS  
Contributing Editor

PROF. LELAND VAUGHAN  
Landscape Architecture

JOHN A. BLUME  
Structural Engineering

MICHAEL GOODMAN  
Planning

JOHN S. BOLLES, A.I.A.  
Book Reviews



### COVER PICTURE

The Clarence Walker  
Flower Shop  
Portland, Oregon

One of the outstanding new commercial buildings in Portland, is the unique new home of the Clarence Walker Flower Shop.

This building and other work of architect Walter Gordon of Portland, has attracted considerable attention throughout the Pacific Northwest.

Photo by B. J. Allen,  
Architectural Photographer

ARCHITECT & ENGINEER  
is indexed regularly by

ENGINEERING INDEX, INC.

EDITORIAL NOTES	4
JOINT INFORMATION COMMITTEE	6
American Institute of Architects & Producers Council, Inc.	
CONSTRUCTION WORKERS MUST MEET PHYSICAL REQUIREMENTS FOR SKYSCRAPERS AND HIGH BRIDGES	7
By W. SCHWEISHEIMER, M.D.	
THE METALLURGY OF THE BOEING MODEL 502 GAS TURBINE	8
By W. L. SLOSSON, Boeing Airplane Company, Seattle, Wash.	
NOISES IN PLUMBING SYSTEMS	8
NEWS & COMMENT ON ART	9
AIR-RAID SHELTERS A "MUST" TO SAVE MILLIONS OF LIVES IN EVENT OF ATTACK CONTRACTORS TOLD BY A.I.A. PRESIDENT	10
By RALPH T. WALKER, President, American Institute of Architects, Part One.	
UNIQUE OVERFLOW SPILLWAY INSTALLED AT SHASTA DAM	13
By JOHN E. RYCKMAN, Regional Information Officer, Bureau of Reclamation	
DELIGHTFUL SUBURBAN HOME, Woodside, California	14
OSCAR R. THAYER, Architect	
COMMUNITY HOTEL, Williston, North Dakota	16
COMMUNITY RECREATION BUILDING, Burlingame, California	18
OSCAR R. THAYER, Architect	
MODERN HOME FOR INSIDE CITY LOT, Portland, Oregon	20
MORGAN H. HARTFORD, Architect, A.I.A.	
ACALANES UNION HIGH SCHOOL, Lafayette, California	23
ERNEST J. KUMP, Architect	
A.I.A. ACTIVITIES	28
WITH THE ENGINEERS	30
PRODUCERS COUNCIL PAGE	32
Edited by CARL B. FRANK, Detroit Steel Products.	
BOOK REVIEWS, Pamphlets and Catalogues	36
ESTIMATOR'S GUIDE, Building and Construction Materials	39
ESTIMATOR'S DIRECTORY, Building and Construction Materials	41
BUILDING TRADES WAGE SCALES, Northern, Central & Southern California	42
CLASSIFIED ADVERTISING	42
CONSTRUCTION CONTRACTS AWARDED, General Data	44
IN THE NEWS	46
INDEX TO ADVERTISERS	48

ARCHITECT AND ENGINEER (Established 1905) is published on the 15th of the month by The Architect and Engineer, Inc., 68 Post St., San Francisco 4; Telephone EXBrock 2-7182. President, K. P. Kierulff; Vice-President and Manager, L. B. Penhorwood; Treasurer, E. N. Kierulff.

Los Angeles Office: Westworth F. Green, 6605 Hollywood Blvd., Los Angeles 28. Telephone HEmpstead 3171.

Entered as second class matter, November 2, 1905, at the Post Office in San Francisco, California, under the Act of March 3, 1879. Subscriptions United States and Pan America, \$3.00 a year; \$5.00 two years; foreign countries \$5.00 a year; single copy 50c. ARCHITECTS' REPORTS are published daily from this office, Vernon S. Yallop, Manager, Telephone DOuglas 2-8311.





# EDITORIAL NOTES

## WE HAVE A JOB TO FINISH

The whole American people—professional men as well as other groups—have it within their power to exert great influence on the political and economical shape of the world for many years to come. Two great wars have been fought, millions of lives have been sacrificed, billions of dollars have been spent, and for what purpose? For no purpose unless the purpose was and is to create a world where free men can live together in peace, can work together for their own well-being, can enjoy freedom and security, progress and prosperity.

To create such a world is the work we have begun and each of us must strive on to finish it.

IT is estimated there are 42,000,000 homes in the United States, of which 23,000,000 are 30 years old or older — estimates show 54 per cent of these homes need some modernization.

## THE ARCHITECT'S JOB

The architect starts to work with you on planning your house, your factory, or your commercial building, from the time you first call on him. If you have not chosen a site, he will aid you in the selection. If the site is already chosen, or after he helps you select it, the actual work of planning the building to meet your individual needs is begun.

Your architect first studies your special needs, the way you wish to live or work, the size of your family or business employees, the building site. Then he draws a picture of your building, in rough form, showing size and arrangement of the rooms and general characteristics. This first drawing is the product of an intense inter-relationship between his skill and your needs — both related to your budget. This preliminary drawing is examined and re-examined to be sure that you understand what you are getting both in appearance and in function.

After both you and the architect agree on these preliminary drawings, he will prepare working drawings — the blueprints you have heard so much about. In this phase of the work the architect brings into play his specialized training, and his knowledge of materials and construction techniques. The result of this work is the production of instructions for every building detail, as well as specifications that include every item going into the construction of the building, from the concrete for the foundation, to the hardware.

These drawings and specifications are the builder's guide, and if they are correctly followed, your building will be as you and your architect planned it.

The architect then sends copies of these plans and specifications to a number of contractors, to get their bids on the cost of building the house or plant. When these bids are received, the architect will advise you on the selection of a contractor, and will assist in the drawing up of the contracts for you to sign.

Now the architect becomes your liaison with the representative of the contractor. He visits the site to see that the structure is going up according to specifications, that the workmanship is as contracted for, that you are getting what you want. As the contractor sends in his bills, the architect will check them, and will keep a running account of the cost of the project so that you are completely aware at all times of just what the true picture is.

In addition there are many services performed by the architect in your behalf, so when you think of building, or remodeling, be sure and consult an Architect.

"BUSINESS as usual is out the window and it doesn't make a damn bit of difference whose business it is — Our necks are all in the same noose."—Senator Hunt, Chm. Senate Armed Services Subcommittee.

## SOCIAL SECURITY

A nation-wide firm which devotes its activities to analysis of federal and state taxes and business laws points out that the door to social security retirement income is provisionally open to architects, engineers and other professional men and women, despite the fact that they are presently excluded from the new federal Social Security Law.

By the expedient of taking a job in any employment covered by the law for a period of only eighteen months, any professional man or woman at or near the retirement age of 65 may receive a pension of as much as \$80.00 per month when he quits such employment, and may continue to carry on his profession to whatever extent his time and energy permit.

If the temporary employment pays him \$3600 per year, his total tax contribution will be \$81.00, and he will get it back almost the first month of retirement.

Guess there is more than one way to "skin a cat."



# ARCHITECT and ENGINEER POINTS THE WAY

Leadership is the Obligation of

## GOOD BUSINESS PUBLICATIONS



### UNIFORM SPECIFICATION PROCEDURE

Has been termed equal in importance to Modular Design  
Which is a great advancement in the Construction Industry



ARCHITECT AND ENGINEER TAKES THE LEAD AGAIN  
IN RECOGNIZING THE IMPORTANCE OF THIS MOVEMENT



*Manufacturers Can Also Lead With Products  
Advertised in the*

# ARCHITECT and ENGINEER

EXBROOK 2-7182 • 68 POST STREET • SAN FRANCISCO

# JOINT INFORMATION COMMITTEE

AMERICAN INSTITUTE OF ARCHITECTS and THE PRODUCERS COUNCIL, INC.

---

Another milestone can be registered in the direction of UNIFORM SPECIFICATION PROCEDURE. The Northern California Chapter of the A.I.A. under the organizational chart devised by Charles S. Pope and adopted by the membership under Chapter President Ralph Pollock has established a committee to be in charge of the study of technical literature and Construction Specifications.

This committee is headed by Chairman Donald Powers Smith. The committee will be working with the Producers Council, San Francisco Chapter whose Chairman Tait Smith of Ceco Steel Company has been gathering data in the form of a survey questionnaire being completed among the manufacturer membership. One of the toughest problems facing his committee to date has been getting completion of these questionnaires. It is only thru this information that his committee can supply the needed information. Any manufacturer reader who has not completed this questionnaire should do so immediately and forward the results to the Producers Council Joint Information Committee.

Definite progress towards mutual understanding of the specification problem between the Architect and the Building Product Manufacturer can be cited in two instances where the manufacturer has presented proposed specifications for his material to the Construction Specifications Committee of the Northern California Chapter of the A.I.A. for suggestions and help.

Currently the Kraftile Company is using the advice of the A.I.A. committee for assistance in preparing new Technical Literature and Specifications for the Architect in the use of Kraftile. C. W. Kraft is meeting with Bourn Hayne, A.I.A., and Fred Ashley, A.I.A., to confer over the literature being

prepared by Barry Boland of Walther-Boland Co.

The result will undoubtedly be material prepared for the best interest of both the Architect and the Manufacturer. Since almost all manufacturers specifications are incorporated in technical literature the problem of Uniform Specifications must include recognition of that problem also.

Ralph Pollock has pointed out the similarity between the initial stages of Modular Coordination and this effort to effect better Technical Literature and Uniform Specifications. It will take considerable time to develop the best answer, but progress is being made.

Another encouraging development towards the program for Uniform Specifications is the interest shown by the Producers Council national offices. President A. Naughton of the Council, as a result of the editorial support given by Architect and Engineer Magazine, has been interested enough in the ideas presented to return East from a recent visit to San Francisco with complete details for presentation to and study by the Joint Information Committee with the A.I.A. Mr. Naughton is vice president of Monarch Metal Weather-Strip Company and recently met with the San Francisco Chapter of the Producers Council.

One of the important considerations of the coming trip of Ralph Walker, national president of the A.I.A. and Walter Taylor, director of education and research will be further consideration of the Uniform Specifications Procedures being developed in the Joint Information Committee of the A.I.A. and Producers Council of the San Francisco area. The recent series of articles printed by the Architect and Engineer suggesting proposals by Architect F. Bourn Hayne, A.I.A., created this interest.

---

*NOTE: This news space is being contributed by ARCHITECT & ENGINEER Magazine to the JOINT INFORMATION COMMITTEE representing the Northern California Chapter of The American Institute of Architects and the Northern California Chapter of the Producer's Council, Inc., and is available to this Committee for the purpose of bringing to the attention of leaders within the Construction Industry various phases of the Architectural profession and building materials industry procedures for general consideration and comment. Your "ideas" and any suggestions for the better pooling of thoughts along these lines should be sent to "Joint Information Committee, c/o The Architect & Engineer, 68 Post Street, San Francisco," where they will be immediately forwarded to the proper committee members.*

# Construction Workers Must Meet PHYSICAL REQUIREMENTS For Skyscrapers and High Bridges

By W. SCHWEISHEIMER, M.D.

A big and dangerous work was accomplished recently at the George Washington Bridge in New York. Sixteen workmen had to climb a 300-foot cable 400 to 600 feet above the Hudson River. They were busy tightening 3,360 bolts that hold 304 heavy cast steel cable bands in place.

Wearing safety belts, they climbed the cables to two cages that ride the cables on rubber-shod rollers hauled up by winches secured to the 600-foot towers of the bridge. The bridge spans high the Hudson River, the roadway is 260 feet above the river and the towers 602 feet. Each cage is 25 feet long, 20 feet wide and 17 feet high.

They are not the only ones who have to do repairwork on the huge bridge. The bridge, one of the largest bridges in the world, is supposed to be painted every seven years.

## How the Crew is Chosen

Not every painter, not every building worker is able to work in such dizzy heights. Rufus Jarman

Raising of cages on the cables of the George Washington Bridge for cable bank bolt tightening.

(Photo courtesy The Port of New York Authority)



has described, how the crew was chosen from approximately 700 new men who applied for the job. Altogether some 60 painters had to be chosen, they finish the painting job in two years.

Only about 400 of the original 700 passed the medical and psychological tests; and not more than 30 were able to scramble about the framework of the bridge with sufficient nonchalance to qualify. The scaffold is swaying in a stiff breeze. A brick mason who had helped build New York skyscrapers could not stand the work on the bridge. The absence of a solid wall was irritating to him, he said.

The climb is routine to most crew members. It is a little rugged, a 29-year old man said, but the height doesn't bother me. Sometimes he looks down, but it doesn't make any impression.

No George Washington bridge painters have been killed, but a number had narrow escapes. Safety measures, Mr. Jarman pointed out, include nets and belts wherever possible, constant observation by foremen, and a ban on smoking to prevent lead poisoning from entering the body through the painter's lips. A new painter is accompanied by two old hands who observe his reactions and bring him down if he gets in trouble. If he "freezes" on a high ladder, his escorts will fasten a rope about him. Sometimes they have to put their arms around him to steady his nerves.

There are eight men in each cage. "You're on your own up there" said a 50-year-old worker. "When I first started in this business thirty years ago I never thought about the danger while I was working. But at night I used to sit and think about it and tell myself I'd quit. But I'd be back to work next day."

Another worker said: "Sometimes I watch the ships and the traffic and the people going on picnics. On a windy day in the cage it's just like in a rowboat. If you are not a good sailor you get seasick."

## "Seasickness" and Dizziness

This kind of "seasickness" or dizzy spells while working on high bridges or skyscrapers or other high buildings may cause dangerous accidents. A slight attack of dizziness which passes quickly,

(See Page 38)

# THE METALLURGY OF THE BOEING MODEL 502 GAS TURBINE

By **W. L. SLOSSON, Boeing Airplane Company, Seattle**

W. L. Slosson, Metallurgist, Boeing Airplane Company, presented a technical discussion on The Metallurgy of the Boeing Model 502 Gas Turbine. Slosson has been in charge of metallurgical development and control in the Boeing Gas Turbine Project for the past four years. Following his discussion, a motion picture showing manufacturing phases of the Boeing turbine and its applications as a power plant in a heavy duty truck and a USN personnel boat was presented.

Slosson outlined the materials used throughout the engine and discussed the operational factors

*Editor's Note: This is an address delivered by W. L. Slosson of the Boeing Airplane Company of Seattle, Washington, before the regular January meeting of the American Society for Metals, Puget Sound Chapter, Seattle, and is the first time the metallurgical aspects of the Boeing 502 Gas Turbine engine have been written for publication.*

governing material selection, use, and inspection as applied to the main engine components, namely, compressor, burner chambers, nozzle boxes, turbine wheels, shafts, bearings and reduction gears. In conjunction with this discussion, several photographic slides were shown illustrating various material problems and properties associated with gas turbine engine development and research.

A centrifugal compressor is used on the Boeing gas turbine. The impeller is machined from a 14S aluminum alloy die forging and the finished part heat treated to the T-61 condition. 14S aluminum was chosen for this application because of the combination of good corrosion resistance, forgeability, and high mechanical properties at

(See Page 24)

## NOISES IN PLUMBING SYSTEMS

The Plumbing and Heating Industries Bureau, nationwide cooperative organization of the plumbing and heating equipment manufacturing business, recently announced a number of suggestions relative to the care of plumbing and heating equipment which are well worth remembering.

In designing and installing a plumbing system for a new house, a plumbing contractor will endeavor to make it as noiseless as possible.

Manufacturers of plumbing fixtures are making every effort to reduce noise connected with the operation of their equipment, and contractors have been successful in eliminating much of the noise formerly associated with plumbing systems.

Because so much of the noise is due to water traveling at a high velocity, it follows that whatever can be done to reduce the velocity of the water will correspondingly reduce the noise in the system. It is for this reason that it is so important not to skimp on the size of the water supply piping. Larger pipe will not only provide a more adequate supply of water but will reduce noise.

There are three general types of noises found in some of the older plumbing systems. These are water hammer, whistling and chattering.

There is no excuse for water hammer. It is one of the easiest types of noise to correct. In many cases, however, the ordinary type of air chamber will not prevent water hammer. In such cases

special devices known as shock absorbers should be installed on the main line near the meter or as close as possible to the source of the noise.

Sometimes water hammer is due not to the plumbing in the house in which it is heard but to a condition outside of the house, either on the water main or in a neighboring house. In such cases skillful detective work by an experienced master plumber is necessary to ferret out the source of the trouble and to plan corrective methods.

Water hammer should not be permitted to go on indefinitely. The noise is only an audible symptom of what is going on in the piping. The piping is being subjected to the wear and tear of the multitude of shock waves. The result will be leaks in the piping or tanks unless the condition is corrected.

Chattering in the piping may be caused by loose pipes, by pipes rubbing against metal projection, by worn faucet washers, or looseness of other inside parts. Sometimes a noisy water meter may be responsible. A plumber will be able to locate the offending part and repair it.

Whistling is caused by the speed of water flowing through piping which is too small. A pressure-reducing valve will help, as well as a general straightening of the plumbing system. Whistling is most common at bends and tees in the pipe.

# NEWS AND COMMENT ON ART

## MILLS COLLEGE ART GALLERY

The Mills College Art Gallery, Oakland, California, will exhibit a group of Navajo Sand Paintings in Reproduction which has been loaned to the College by the Taylor Museum of Colorado Springs, Colorado.

Also on exhibit will be a number of Block Prints and Designs by the Hopi Indian School children.

Gallery hours are from 2 to 5 p.m. daily except Monday.

## SAN FRANCISCO MUSEUM OF ART

The San Francisco Museum of Art, War Memorial Building, Civic Center, will feature the following exhibits and events for the month of February:

**EXHIBITIONS:** A NEW VISION, an exhibition of paintings, drawings, objects, projects by Lee Mullican, Gordon Onslow-Ford, and Wolfgang Paalen. SECOND DECORATIVE ARTS COMPETITION, comprises a group of the Prize Winners, honorable mentions and selected designs, together with some articles manufactured from the designs. A special showing of numbers from the Museum of Modern Art Lamp Competition, will also be on exhibit during the month.

**EVENTS:** The Museum believes it provides well balanced opportunities for enjoyment and instruc-

tion in art and related fields, and has revised its activities to offer a maximum of public benefit of the Museum's resources. Inaugurating the new program will be a series of Wednesday evening lectures and demonstrations free to the public. Starting at 8 o'clock this series will touch on many aspects of the arts and will feature speakers of recognized authority, national and local. Subjects scheduled for the month include Image and Reality, Art and the Layman, Towards a New Subject in Painting, and Why Painting has Become Subjective.

Modern Art—A Course for Laymen, will be presented by Allon Schoener and Barbara Fitzwilliams.

## CALIFORNIA PALACE OF THE LEGION OF HONOR

Dr. Jermaine MacAgy, Acting Director of the California Palace of the Legion of Honor, Lincoln Park, has announced the following schedule of exhibitions and special events for February:

**EXHIBITIONS:** The Works of Henri de Toulouse-Lautrec, Loan Exhibition from the Collection of the Lautrec Museum, Albi, France; Tempo of the Times, Prints from the Achenbach Foundation for

(See Page 25)

LANDSCAPE WITH POINTED HILLS, 1944, chalk, ink and gouache by Graham Sutherland of Great Britain, Museum Collection, now an exhibition.



SAN FRANCISCO MUSEUM OF ART



# AIR-RAID SHELTERS A "MUST" TO SAVE MILLIONS OF LIVES IN EVENT OF ATTACK CONTRACTORS TOLD BY A.I.A. PRESIDENT

By RALPH T. WALKER, President, American Institute of Architects

## PART I

Pascal once said: "Man never acts in obedience to reason, which is the very essence of his being."

Several years ago, in London, I met two outstanding English civil servants, both distinguished, both knighted, and nearing the age of retirement. At lunch one day, they each said that retirement was very pleasant to contemplate because they "could then talk." Now, I am in that happy position, where not holding any public office, I am free to say what I wish; to make such observations on what I have seen in my travels about the world, as may seem reasonable. I do not claim any special knowledge but I do admit that a long practice in architecture and many travels have given me some clarity of observation. I told my English friends in 1943 that I believed Winston Churchill would lose the next election, if the war were over; and was told that, of course, I had talked to the wrong people.

Several years ago I was traveling by train toward Houston, through a dreary, uninteresting landscape, and had passed through one blot on the countryside after another, when one of the worst of all came in sight. As we slowed down for some unknown reason, it was especially sad; for in evidence, were unpainted shacks, sparse stands of scrub slash pine; the narrow main, state owned ribbon of concrete covered with mud; the business center resembling a frontier town,—in fact, there were more animals than automobiles; worn-out oil derricks; a few mechanical mules slowly draining out the dregs of an exhausted oil field. I said to my companion: "By what euphony do you suppose this ungodly post office address is called?" And at that moment—believe it or not—a freshly painted sign on the Victorian railroad station proudly proclaimed: "Pretty Lady, Texas." Euphony generally means a willingness for self-delusion. At present it seems to me that we are engaged in a "eu-phony" war.

Now we Americans are adept in making the best of things, so much so that we are apt to help

others kid us to our own disadvantage; and it has been interesting to see how we strive to make friends and influence people, especially when they themselves are not interested in us except to surround us with hatred and enmity. I suppose we now acknowledge that we are at war with Communism; but euphously we still hesitate to say it is with Russia and her satellites.

We have permitted ourselves to be placed in a position of low morality—one in which we gave away at Teheran the rights of peoples we should have fought to see free: a very low point indeed of our historic foreign policy and one which will plague us for years to come.

We have permitted ourselves to be completely outmaneuvered by the Russians in propaganda—an effort in which we have prided ourselves on being leaders. The whole peace congress move, under the guidance of Russia, was permitted to take hold of world imagination—and, **on one count only. You may not laugh off millions of signatures, no matter how misguided you may think them to be: for the A Bomb and nothing else has come to mean aggression.**

### International Architects

I am a vice-president of an international architectural organization, (Union Internationale des Architects), one built along the lines of the United Nations, and incorporating now in its membership thirty or more national architectural societies, including those from behind the iron curtain. The "iron curtainers" have been constant in insisting that the architectural organization (alphabetically known as the U.I.A.) send formal delegates to these congresses; and after the Stockholm declaration in favor of abolishing the atom bomb, that we sign this with other international organizations. No patient arguments as to the fact that we, professional society, should not get involved in what were evidently political matters had any effect. I admit I finally became impatient and said The American Institute of Architects would have none of it; that the American representatives at these congresses were deemed to be little better than crackpots; **but, that we too were interested in peace;** that if the U.I.A. wanted to make a proclamation of its own, we would go along—except that

*EDITOR'S NOTE: Part One of text of speech by Ralph T. Walker, president of the A.I.A. and member architectural-engineering firm of Voorbees, Walker, Foley & Smith, New York City, delivered before recent annual meeting New York Building Trades Employers' Association. Balance of speech will appear in March issue of Architect & Engineer.*

we would want to include the abolition of **all the weapons of war**, such as bows and arrows, Bren guns, heavy artillery, tanks, but more especially all sorts of genocide—and not least—forced labor camps because these had in the past few years caused more deaths than all other means combined. This was met by a stunned silence on the part of the "iron curtainers", to become more so when they were asked straight from the shoulder, **if they were eager to go along**. Again, of course, everybody else except the "Commies" agreed.

This USSR group did not come to our latest meeting in Paris in late September; but there arrived a long scurrilous telegram—which took almost twenty minutes to translate—repeating all the "Maliking" which we now know so well, reiterating again and again the fact that the U. S. was an aggressor and their insistence upon the signing of the so-called Stockholm Declaration of Peace: so it was Peace—Peace—Peace.

One of the American delegates got madder and madder at the abuse and finally came over and said to me: "Are we replying to this dirt?"—and I said "No", but he thought there should be a very short reply sent immediately and suggested these words: "Dear Poles, Czechs, Hungarians and Russians—**Peace on you too.**" Unfortunately, this is not readily translated into Russian.

The war is now on—of that there can be no doubt. If we believe that we can make a lasting peace with the present rulers of the U.S.S.R., we are fooling ourselves. **I think we face a supreme danger in being led, hopefully into believing in a premature peace.** There are several things which are obvious, at least so to me. I have no wish to get into what is known as the "great debate", but I think it extremely important that we in the construction industry do not get into this "eu-phony" attitude.

### One World

To begin with, the Russian leaders believe in one world—one which, however, they will dominate. They foster, through hate, treason and despair, a world revolution; and in which they have been so far greatly successful. They carry on the ideals of Lenin in even a more ruthless manner, utterly disregarding individual suffering—in a wanton lunge to what seems to use to be nihilistic destruction. I think we should hear repeated often these words of Lenin: "We are living", Lenin wrote according to Joseph Stalin, "not merely in a state, but in a system of states; and it is inconceivable that the Soviet Republic should continue to exist for a long period side by side with imperialistic states. **Ultimately, one or the other must conquer. Meanwhile, a number of terrible clashes between the Soviet Republic and the bourgeois states**

**is inevitable.**" ("Problems of Lennism" by Joseph Stalin).

Is this peace? Can anyone in his right mind see other than a recognized—and a desired—long series of wars in this statement? **And remember these are "holy" words.** We may say that war is not inevitable—but does Stalin believe it to be so?

There is another factor and that is the age of Stalin himself. Stalin the dictator, no pleasant "Uncle Joe" but a hard, shrewd man, knows well his place in Russian history and fully intends, in my opinion, before he dies, to extend to the farthest possible limits the boundaries not of Communism, which is but a tool, but of Holy Russia. He will leave wave marks on world shores undreamed of by Peter and Ivan—one deemed the Great—and the other "The Terrible". It now takes a whole page of the "Pravda" to enumerate, a hundred times, the qualities of the greatest influence for evil, without doubt, which has existed in the world since another mustached Asian sent his hordes east and west looting superior cultures. **We all admit the next move is his.**

One of the most interesting minds developed in America at the beginning of the century was that of Homer Lea whose plan of attack on Manila was used by the Japanese. Of Russia he said: "In the development of the Russian Empire man has more nearly approached those characteristics that mark the measured, unhurried growth of nature. In its extension, it has moved on with elemental propulsion. Like a glacier, its movement is only apparent by periods of time, so imperceptible is the terrible, imperturbable grind of its way that we do not perceive its progress until it has passed a given point." We have lived, however, in a time when the glacier has expanded with world-wide concussion. He further said: "Russia in her progress is no more concerned with the devastation of her wars (and her appalling losses on the battlefields) than is Russian nature, with the havoc of her winters." ("The Way of the Saxon," by Homer Lea.)

Again the world, as a whole, is favorable in time to the ideas of a world revolution. World-wide communications, world-wide transportations, have made the **many hungry millions** aware that there are greener pastures; and the over-populated nations of the world—held down by small corks of irresponsible plutocracy—are alive to the voice of Communism. Ears are raised high in Europe; Asia; in South America.

### Europe Reactions

I have been commuting to Europe since the last war. My opinion is that the average European would rather face the possible purge of revolution than the destruction sure to be brought upon him if Europe were a battle field in a war between the

USSR and ourselves. I am not sure that I blame him. War is not a pleasant experience; every man and woman I know in Europe has had the terror of war thoroughly imbedded in their lives. In the first World War I once rode up to the front with a poilu who was returning, somewhat reluctantly, for the fourteenth time; wounds, reliefs and even at his age, babies; each time the need of further replacement sent him back. Yet he could imagine a Boche on the opposite side doing much the same thing. He might be "sale" (dirty) but **he was** at least human. My opinion is that the average European would rather roll with the punch; be brave, as indeed he has been, underground. Unfortunately, he cannot appreciate, that mole-like when he finally stirs into creating again his own liberty, the destruction will be even more sure, even more violent.

My friends the French have saved physical Paris twice in my lifetime and hope to do it again. This fear of destruction and the strong feeling concerning the inevitability of the revolution is making the United Nations the ineffectuality it now appears to be. Europe will, in my opinion, remain too slowly to be really effective, for Europe fears most the fact that it will again be a battle field between outside empires of which unfortunately, we are one. Whenever I hear thirty wise men stating our frontier is the Rhine, I feel immediately the strong European reaction against being behind the eight ball.

I have been to Latin America and to the Islands of our Indies and I know that over-population, exhausted soils in the latter especially, make conditions quite ripe for revolt. I know the extreme poverty, the hopelessness of the ninety per cent of South American peoples make them ripe, busting ripe for trouble. Everywhere, chains of near starvation strangle hope; the discontent are enormous in extent; their life expectation is short. Get them **hopped** up with hopes of loot and rape and a gamble for an immediately larger bowl of rice, beans, millet, whatever the sustaining grain, then death has no sting. This is one thing we can be sure of in expectation.

When in Greek times Sparta and Athens fought their long wars to exhaustion and final eclipse, it was to them a big world, although even in that time communications could span it in a day. The history of that war by Thucydides (a name not readily pronounced after two cocktails) while telling of a few relatively small battles still applies generally to us, for he says: "The Athenians and the Spartans fought for one reason only—because they were powerful, and therefore were compelled to seek more power. They fought not because they were different—democratic Athens and oligarchi-

cal Sparta—but because they were alike. The war had nothing to do with differences in ideas or with considerations of right or wrong." (The Great Age of Literature, by Edith Hamilton, page 187). And that, frankly, is the situation we face, i.e., a grasping nation wishes to extend its power over us and we are powerful enough to resist; and, if we are as able as we think we are, and use well the resources within us, we will survive when its power—built upon unwilling, even though now coerced people—cracks.

I believe we are now engaged in a war which no "eu-phony," called a United Nations police action, in any way disguises; and it also means to me that Korea is the first Joe Louis-like left jab to soften us up. If war is not inevitable then at least it is not improbable and we must govern our future accordingly, and I agree with General Eisenhower in believing we are going to live, for a long time to come, in sacrifice, in preparedness for the terrific clashes which Lenin foresaw and to which Stalin subscribed. I would propose that we do not let General Eisenhower down in his new mission.

I personally, believe in having as many allies as possible. I further believe that in the long run the American way of life is the only way the resources of the world can be best used to create benefits for the largest number—just as it has here in America.

### Great Problem

Our greatest problem and one most difficult to sell even to the most intelligent of Europeans and Asiatics is that **we Americans do not want war**; that we have more to lose than any other people; that—while not perfectly so—we have been able to achieve a wider distribution of wealth than any other people; that a war means the loss of things we hold dear—freedom of movement, freedom of thinking and action—as well as the loss of material things. To say these things, however, to people who have never had them makes no impression at all. The battle the Russians would have us engage in is not to make the world richer but to make us all poorer. Our greatest job, therefore, is to persuade the people of the world we need peace as much as they do—and this will never be accomplished by scorched earth policies. We must, in my opinion, establish ourselves in world obscurity as a moral agent interested, once again, in freeing men from true aggression and in helping them develop the same will to private initiative that we have here; but first, we must help fill the rice bowls of the world.

(To be concluded next month)

LIFTING THE TIP  
OF "A" FRAME HEAD  
TOWER INTO PLACE



## UNIQUE OVERFLOW SPILLWAY INSTALLED at SHASTA DAM

By **JOHN E. RYCKMAN**

**Regional Information Office, Bureau of Reclamation**

A unique feature in overflow spillway design at Shasta Dam, California, recently completed at a cost of \$350,000, will save hundreds of thousands of dollars if major repairs to the spillway apron ever become necessary, according to R. S. Calland, acting regional director for the Bureau of Reclamation, constructors of California's Central Valley Project.

This device consists of a cableway spanning the downstream end of the Shasta spillway apron, for the purpose of installing and removing a large steel cofferdam between the spillway training walls.

Use of a cofferdam provides relatively easy inspection and repair of the spillway apron. At some large overflow spillway dams, cofferdam installation and spillway apron repair have proved to be expensive and time-consuming affairs. At Grand

Coulee, for instance, it was necessary to lower huge caissons into the stilling basin to correct erosion damage from the tremendous force of falling Columbia River water.

Shasta is the only large Reclamation dam in the west having provision for easy installation of a temporary and removable cofferdam. Although to date there has been only one spillway overflow, and that of a test nature, it is probable that a considerable amount of water will spill during extremely wet years. Hence, provision was made for easy inspection and repair of the spillway apron against erosion action.

Under the cableway and cofferdam system, the cofferdam sections are lowered into place from the 1,380-foot cableway, and then the stilling basin can be pumped dry. Inspection and repairs are then made.

(See Page 25)





Delightful

# SUBURBAN HOME

WOODSIDE, CALIFORNIA

ARCHITECT:

Oscar R. Thayer

Here is an attractive, typical California suburban home which was designed by Architect Oscar R. Thayer, of Burlingame and San Francisco. It embodies a number of the "unusual" facilities that contribute so much to the pleasures of "spacious, out-door living", and the architect has created the home in such a manner as to take advantage of the mild climatic conditions to be enjoyed in the San Mateo Peninsula area during most of the year.

The new home has been constructed on a level, one acre plot of land with the building itself being set back on the lot, about one hundred feet from the main street. This location of the house gives the owner greater privacy from his neighbors and from those passing along on the street and at the

same time street noises are considerably lessened.

The concrete wall foundations have been tied together with a five inch thick concrete slab floor which serves as the base for a number of regularly spaced copper tubing that has been installed as a part of a radiant heating plant. Hot water for the heating is provided by a heating unit placed in an obscure, out-of-the-way part of the house.

As will be seen in the photograph of the home, the front elevation contains some stone facing, however, the construction is mostly of choice, selected, used brick. The use of this material gives the house a unique and distinctive look that is more of a non-city, and more of a rural, appearance. The balance of the construction is of frame. The entire combination of stone, used brick, and wood gives the structure a very attractive and individualistic appearance as well as keeping well within the characteristics of the adjacent residences and surrounding area.

The windows situated for a maximum of visibility and light are all equipped with a modern stainless steel sash.

The main entrance into the home is through a small court which opens off the front street side. This entry into the home opens directly into the main living room area, with convenient facilities provided for dispersal of traffic into all parts of the house.

The garage and service entrance is served from the court on the street side.

Another feature of the home which puts it definitely in the class of a home "for out-door living" is the construction of a flagstone terrace that serves as a utility living area. In close conjunction to this portion of the home is a brick barbecue pit and other facilities for use during much of the year when the mild climate of "the Peninsula" lends itself to out-of-doors activities.

#### HOUSE PLAN

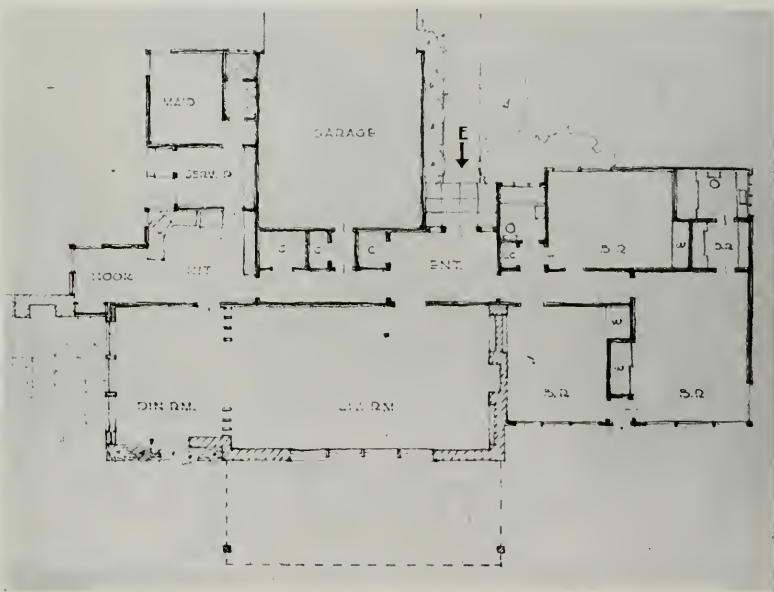



# COMMUNITY HOTEL

WILLISTON, NORTH DAKOTA

Construction of a new five-story, eighty-room hotel with complete modern facilities is under way in Williston, North Dakota, under the direction of W. S. Davidson, Jr., president of the Williston Community Hotel Company, a local organization of business and professional interests organized for the purpose of building a great new hotel to attract visitors to the community.

The new hostelry was designed and will be built and completely equipped and furnished at an average room cost of \$7,000 by Design Incorporated of St. Louis, nationally known firm specializing in hotel designing, building and rehabilitation.

The \$7,000 average room cost figure covers furnishing and decoration of all guest rooms and public room areas, including a large coffee shop, cocktail lounge, bar, banquet and private dining rooms, in addition to complete kitchen equipment.

The hotel's coffee shop will accommodate 200 customers and will be located on the ground floor level. Cocktail lounge and bar lounge will be separated by planting boxes, with the cocktail lounge having direct access to the lobby. A street entrance will lead directly to the bar, giving a high degree of accessibility to both areas.

In the full basement area, a ballroom and two private dining rooms will be available to the citizens of Williston, enhancing the hotels services for accommodating large conventions and group meetings. These areas may be combined or separated by acoustical folding doors, lending versatility to all three rooms. Ballroom and private

dining rooms will be serviced by a special banquet kitchen, separate from the hotel's main food preparation facilities.

Men and women's lounges, barber shop, checking facilities and a public foyer also will be situated in the basement.

Four floors of guest rooms will be laid out according to standard carpet sizes. Baths in guest rooms will be finished with rubber and special decorative tile. This type material, according to Design Incorporated, does not rust or break loose from its foundation. The hotel will have a fireproof interior and enclosed fire escape. One through elevator which may be operated either by hotel employees or guests, will service both passengers and freight.

The hotel's exterior will consist of brick with stone trim, a concrete canopy, steel windows and doors throughout. Construction above the first floor will be steel frame with concrete floors. An enameled metal pylon or fin will add a decorative touch to the exterior.

To help solve the parking problems in a metropolitan area, a parking lot with ample space for 50 automobiles will be located to the rear of the hotel, with a special guest entrance leading to the main lobby. A commercial garage with 150 car capacity is available directly across the street from the hotel location.

The new hotel, with its complete and diversified facilities, is expected to be a tremendous asset and community betterment to the citizens of Williston, North Dakota.



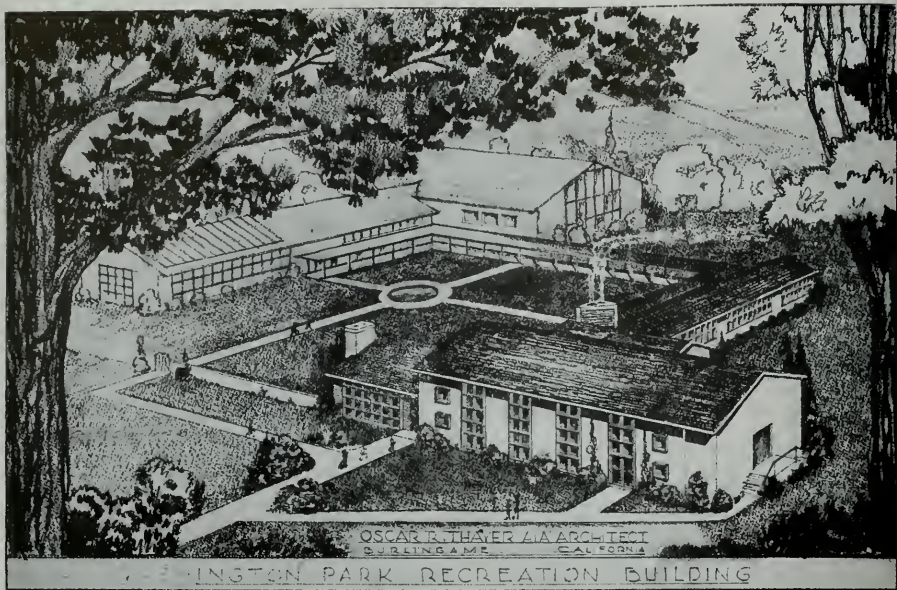

Community

# RECREATION BUILDING

Burlingame, California

ARCHITECT:

Oscar R. Thayer

Development of the Community Recreation Building in Burlingame, California, represents the completion of the first stages of a community-wide program designed to modernize the recreational facilities of the entire city of 20,000 population.

When the Burl Club, comprising an active group of men with families, decided something should be done to improve supervised recreational facilities throughout the city for their children, they enlisted the support of the Chamber of Commerce, various

Improvement Clubs, and submitted the program to the City Council. The Council passed the program along to the city's Recreational Commission who authorized a study of all phases of the project including a proposal that construction funds become available through issuance of a Recreational Bond issue of some \$155,000.

The Recreation Commission commissioned architect Oscar R. Thayer to draft plans, which were subsequently submitted to the fire department and building inspector for approval, calling

## . . . RECREATION BUILDING

for the construction of the Recreation Building on a site selected near the High School and in one of the city's park areas. The site provides ample room for additional construction to the present building and for the ultimate construction of a modern, covered swimming pool with all necessary facilities, which is part of the overall recreational program.

So enthusiastic were the teen-agers of the community with the plan that students of the high school took an active part in the campaign to secure approval of the bond issue and on election day made a direct appeal to voters to approve the bonds. The election also included a bond issue for the construction of a new fire department building, and both issues were approved by a large majority of the voters.

When it became apparent that construction would use all of the funds available and leave very little for equipping the new building, the teen-agers again went to work and offered their services after school and on Saturdays, doing odd jobs such as washing windows, mowing lawns, and other types of work with compensation for the work done going into a special fund for the purchase of

building equipment. Through this method some \$4,000 was raised and the funds spent for projection equipment for the auditorium, decorations and other furnishings.

The building has a general community use. It is the focal point for teen-ager activities through the Canteen which is open afternoon and evenings; it is used by the Boy Scouts for their annual meeting; the Library is used for small gatherings, and the Assembly Hall for larger groups. It is the center of the Over-50 Club, men and women of the community over fifty years of age who meet regularly for card parties and folk dancing, and one of the more popular programs is the Tiny-Tot Pre School Program which includes story telling and the playing of small children's games. Other activities include classes in art and ceramics, both afternoon and evenings.

The building is under the supervision of a Director who is employed by the Recreation Commission to direct the entire recreational program of the city. He is assisted by full and part time help, and from all indications the new building has proven all it was intended as its facilities are used to almost capacity.

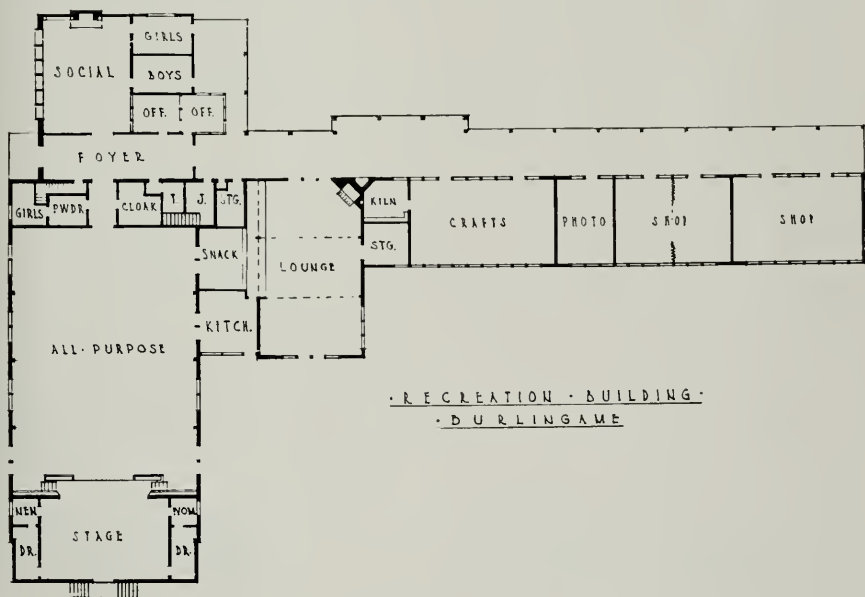

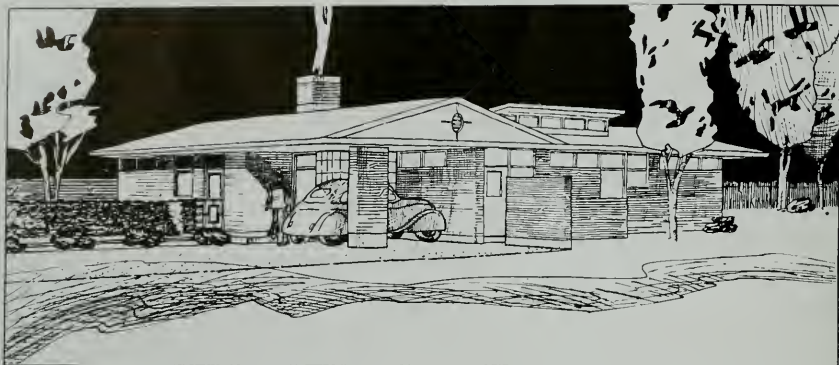

# MODERN HOME FOR INSIDE CITY LOT

AREA ABOUT 1400 SQUARE FEET

MORGAN H. HARTFORD,  
Architect, A.I.A.  
Portland, Oregon

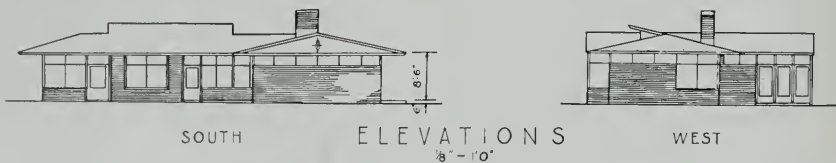

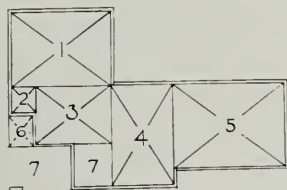

AREAS  
1/16" = 1'-0"

- 1. 12'-0" x 21'-4" = 340
- 2. 5'-6" x 6'-9" = 37,125
- 3. 13'-0" x 16'-0" = 208
- 4. 14'-0" x 22'-0" = 308
- 5. 18'-0" x 24'-6" = 441
- 6. 5'-6" x 5'-9" ÷ 2 = 15,812
- 7. EXCLUDED =  $\frac{x \times x}{2}$
- TOTAL 1349.9<sup>sq</sup>

Here is a plan that proposes to reduce household cares to the minimum with its fine relationship of living, service, utility and sleeping areas. It can be built on a narrow inside lot. The L shaped plan provides a splendid sheltered terrace area with fountain and landscape features at the same time providing direct access and pleasant vistas to garden areas from all major rooms.

Living room has fireplace and Dining Alcove which can be separated by draw curtains. Kitchen is completely efficient and features an entirely automatic laundry at one end of Kitchen including washer, dryer and ironer with ample cabinet space for supplies.

A combination Den and Guest Room with fireplace is so situated as to make a quiet retreat from Room activities when used as a Den or Study and to have full seclusion even though centrally located when used as a Guest Room. For a professional man the Den-Guest Room could serve appropriately as Office, Study or Library. It is also adaptable to use as a Hobby or Sewing Room as desired by occupants of the home.

Master Bed Room for Parents has individual closets for Mr. & Mrs. plus a connecting door to Child's Room and a private exit to garden. Built in vanity and chests of drawers are located under large corner window overlooking gardens. There

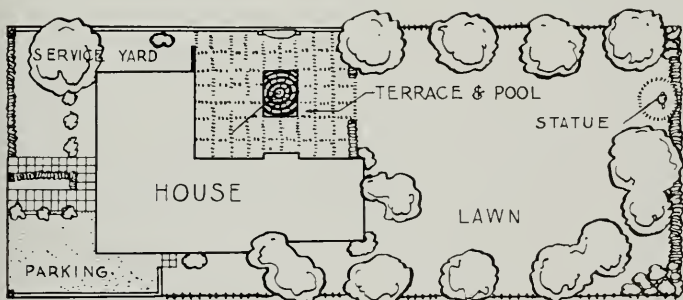

PLOT PLAN  
1/16" = 1'-0"



# MODERN HOME . . .

are private Bed Rooms for Son and Daughter, each equipped with closets. Boy's Room opens directly to terrace and Girl's Room faces terrace fountain and features a handsome bay window.

Both Linen Closet and all purpose closets are located in Hallway. Good size separate Furnace and Storage Rooms are provided. A carport shelters the family car and is strategically located for direct convenient access to Utility Rooms, Kitchen or Entrance Hall. Entrance Hall is illuminated with glass blocks. Corridor is lighted and ventilated by Clerestory Windows. Clerestory corridor windows can be seen on rear roof of house in sketch. By opening these windows and Bed Room windows, warm air will be drawn out of corridor and from Bed Room, through slotted opening in Bed Room walls. Multiple Bath Room units are arranged for triple occupancy simultaneously.

House can be heated equally well by radiant

heat, panel heat, forced warm air, steam or hot water, either oil or gas fired. If adequate power is available, electrical heat would be possible.

Construction materials should be selected as available from the region in which the house is constructed. Concrete foundations supporting either solid, hollow or veneer masonry walls should be used. Floor may be concrete slab or wood joist construction. Plaster or wood panels would be very suitable for interior walls and ceilings. Roof may be of wood, composition, or aluminum shingles. Built up roofing could also be used. Slate or tile could be installed for those not concerned with limited budgets.

The exterior is of modified modern architectural styling, and although having Modern Eye Appeal, it will fit harmoniously among houses of conventional or period architectural styling.

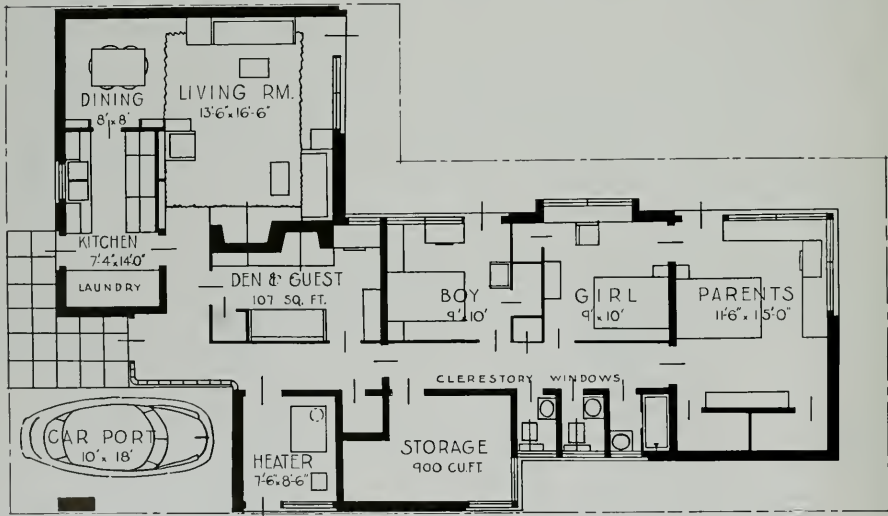

PLAN  
1/4" = 1'-0"

AWARDED FIRST PRIZE \$100.00 AS WINNER OF "PRACTICAL MIRACLE HOME NATIONAL CONTEST OCT. 1949."  
 SPONSORED BY PRACTICAL BUILDER MAGAZINE  
 5 S. WABASH AVE., CHICAGO 3, ILLINOIS



*Skelton Studios—Photo*

# ACALANES UNION HIGH SCHOOL

## LAFAYETTE, CALIFORNIA

**ERNEST J. KUMP, Architect**

The Acalanes Union High School at Lafayette, California, represents one of the best examples of the architecture of California's postwar school buildings and plant lay-out planning. When the first unit of the school was built in 1940, it marked a significant point of departure from the established precedents in school design.

Boys studying such crafts as auto repair, wood-working, sheet metal fabrication, and building maintenance work in shop classrooms kept comfortable by floor panel radiant heating. More than five thousand feet of one-inch and seven hundred feet of two-inch special steel pipe are buried in sinuous coils in the floor slab in the crafts shops. Hot water for the heating is supplied by a centrally located gas fired boiler of 864,000 BTU capacity and is circulated under 10 psi pressure by a single pump. An indoor-outdoor control regulates the temperature.

Acalanes Union High School for the first time

in school construction establishes a pattern for future growth. A definite plan was laid out and planned with an objective of open space and community use, and the building construction embodies many unusual features such as non-load bearing walls and partitions, and the use of lighting without glare.

As use of the school increases and the student body grows additional classrooms and wings are added. The latest classroom wing additions and the new library building may be seen just slightly to the right and just above the tip of the flagpole in the above photograph.

The baseball field in the far distance, a little left of center, and the tennis courts at the extreme left, are on land acquired as an addition to the original site. The final steps in the school's expansion include a girl's gymnasium, an auditorium, a cafeteria building, and an extension to the shop building.

## METALLURGY OF BOEING

(From Page 8)

room and elevated temperatures offered by that alloy.

Burner liners are subjected to very stringent operation conditions because of the extremely high temperatures and thermal gradients imposed on these parts during the combustion process. Such thermal conditions promote rapid warping, cracking and oxidation of the liner material unless liner design is carefully controlled so that maximum cooling is provided by compressor air. Several liner designs and sheet alloys including AISI 321 bare, stainless-clad-copper, ceramic coated AISI 321, and AISI 310 bare, are under test by Boeing in a program aimed at developing long life liners from lower alloy materials. Current burner liners are fabricated from .050" Inconel sheet.

Nozzle boxes are similarly exposed to high temperatures and thermal gradients promoting warping, cracking and oxidation, although not to the degree experienced with burner liners. Proper combustion chamber design has great influence on nozzle box material selection since control of nozzle box inlet gas temperatures and distribution is performed by the combustion chambers. The first stage nozzle box is fabricated from AISI 310 sheet and precision cast H.S. 30 alloy blades. The second stage nozzle box is fabricated from AISI 321 sheet and precision cast AISI 310 alloy blades. Here again, several materials are under test or scheduled to be tested in a search for satisfactory use of lower alloys.

Both the first and second stage turbine wheels are fabricated by welding H.S. 30 alloy precision cast blades to a Timken 16-25-6 alloy forged hub. Welding is done by the manual metal arc method using a 19-9 WMo alloy electrode. The small size of the Boeing turbine wheels in conjunction with the quantity of blades on each wheel dictates welding the most practical method of blade attachment, and operation of many wheels on test engines and in spin pit operations has shown the weld very reliable under normal operating conditions. In an effort to obtain a lower cost wheel concomitant with higher production, Boeing is currently conducting tests on both a bi-metallic cast turbine wheel and an integral cast blade ring assembly. On the former wheel type, the hub is cast around the bases of individually cast blades, while on the latter type, the blades are cast in an integral ring and the blade ring welded to a forged or cast hub. The bi-metallic cast wheel shows considerable promise in tests conducted thus far.

The major difficulty with turbine wheels in engine operation is blade failures. Failure of the

blades can be caused by impact with foreign particles going through the wheel, fatigue or thermal shock. Fatigue and thermal shock, or combination of both, are of greatest concern to the metallurgist with respect to turbine blade operation life. Pursuit of materials showing maximum resistance to these conditions of stress is constantly under way through research and testing in all turbine applications throughout the country.

The main turbine shafts on the Boeing engine are fabricated from SAE 4140 Steel, heat treated to 150,000-170,000 PSI. All the gears in the reduction unit are case hardened for maximum service life, with SAE 3310, 4620 and Nitralloy utilized. Extensive use of sleeve bearings has been promoted throughout the engine with considerable success. Continuous cast leaded bronze, steel backed copper-lead and babbitt coated aluminum bearings are currently being utilized.

Many methods of material inspection are utilized on gas turbine components. Extensive X-ray and Zyglo inspection is performed on all turbine blades and turbine wheel assemblies throughout fabrication. All turbine wheel hub forgings are both ultrasonic and Zyglo inspected for external and internal flaws. The shape and nature of the impeller forging does not permit reliable ultrasonic inspection under current known procedures, however thorough Zyglo inspection of the impeller is accomplished at various stages during machining operations. A final quality check on each impeller and turbine wheel assembly is afforded by a 25% overspeed room temperature proof spin in a spin pit, followed by Zyglo and X-ray inspection of each component. All highly stressed magnetic parts are subjected to complete magnaflox inspection, and X-ray and Zyglo inspection control exercised over all light alloy castings.

A measure of reliability of the Model 502 gas turbine was recently demonstrated by successful completion of 550 hours cycle test and continuous endurance operation of a current design engine on a test stand. This time included 400 hours operation at rated speed and power output (36,000 RPM on first stage and 175 H.P. delivered at output shaft). All major components, except the burner liners, completed this test without replacement or overhaul. The original burner liners were removed after 300 hours operation because of excessive warpage that could not be satisfactorily repaired. The replacement liners completed the balance of the test.

---

MEMBERSHIP gains of over 3,000 for the year of 1950 have been announced by the National Association of Home Builders. Membership is now 19,034 and 165 chapters.

## NEWS & COMMENT ON ART

(From Page 9)

Graphic Arts: Exhibition of Pre-Columbia Peruvian Art; Christian Berard; and Paintings on Glass by Rebecca Salsbury James.

**EDUCATIONAL ACTIVITIES:** Classes for children, ages 8 through 15, each Saturday at 10:00 a.m.; Instruction by Colin Graham and Howard Ross Smith. Painting class for adults, each Saturday at 2:00 p.m. Instruction by Colin Graham and Howard Ross Smith. Lecture on contemporary prints in the Achenbach Foundation, "Matisse to Miro," by Irene Lagorio. February 21 at 10:30 a.m. Two lectures on the Toulouse-Lautrec exhibition, "Montmartre in Calligraphy," by Colin Graham, February 28 at 10:30 a.m. "Print and Poster: Essays in Suggestion," Colin Graham. March 7 at 10:30 a.m.

**ORGAN PROGRAMS:** Organ recital by Uda Waldrop every Saturday and Sunday 3 p.m.

**FREE MOTION PICTURES:** 2:30 p.m. Saturday, admission free. February 3: "Foreign Correspondent," with Joel McCrea and Herbert Marshall. February 10: "Dark Mirror," with Olivia de Havilland. February 17: "Naked City," semi-documentary film by Mark Hellinger. February 24: "Wicked Lady," with James Mason and Margaret Lockwood.

### RULES OUTLINED FOR YOUNG ARTIST CONTEST

Dr. Gustave O. Arlt, Chairman of the Committee on Drama, Lectures and Music on the Los Angeles campus of the University of California, announces that application blanks for the annual Young Artists Contest at UCLA are available and should be filed before March 15.

Qualifications include 1) adequate training as attested by teachers, 2) record of previous public appearances, and 3) not have reached their 28th birthday.

### CALIFORNIA SCHOOL OF FINE ARTS

The California School of Fine Arts, 800 Chestnut Street, San Francisco, announced a Print Criticism course would be offered for photographers in the spring term. The course covers eight weeks with Minor White instructor.

Continuing the broad scope of its activities, the spring term opened early this month. Day and night courses include Painting, Sculpture, Graphic Arts; Design for Commerce and Industry; Photography. Oil and watercolor classes will be taught by David Park, William Gaw, Elmer Bischoff and Hassel Smith. Robert Howard, Zygmund Sazevich and Ramsey Wolbert will instruct the Sculpture

and Workshop courses. Illustration, Commercial Art, Interior Design, Design for Textiles and Papers, Jewelry Design, Lithography, Etching and Silk Screen techniques, and a variety of drawing courses will also be offered during the eighteen-week semester.

### PORTLAND ART MUSEUM

Thomas C. Colt, Jr., Director of the Portland Art Museum, West Park and Madison, has announced the following exhibitions for the month of February:

Japanese Folk Art; Oregon Photography for 1951; Japanese Print Series, No. III, and a special group showing of Oregon Coast Paintings.

### CITY OF PARIS

The Rotunda Art Gallery of the City of Paris, San Francisco, will feature the 9th Annual Pacific Coast Textile Exhibition comprising Print and Woven Textiles by thirty-seven designers.

Pictures of the Month will be a group of Paintings of the Southwest by Edith Hamlin Dixon.

### SHASTA DAM SPILLWAY

(From Page 13)

Shasta's cableway, the main track cable of which is three inches in diameter, was erected by John C. Gist, of Sacramento, California, at a cost of \$48,220. The cofferdam consists of 1,000 tons of structural steel, to be assembled into large trestle bents and bulkhead panels, and then placed in the lower end of the spillway. There is a distance of 225 feet from the loading dock at the head tower, from which the cofferdam parts are lifted from trucks, to the bottom of the spillway. From the center line of the 80-foot loading dock to the west side of the spillway is 800 feet. This is approximately the longest haul necessary on the 30-ton capacity spillway.

The three-inch, main track cable is 1,665 feet long and weighs approximately 24 tons. It is of locked coil construction. The hauling cable is one and one-eighth inches in diameter. Maximum deflection of the main track is 55 feet, or 6.37 per cent of the span.

Erection of the head "A" frame tower, which is 130 feet, 2 inches in height, was accomplished by use of a 2½ yard Lime dragline with a 90-foot boom and a 20-foot attached jib. The tail tower height is 60-feet, 2 inches, and is located on the west bank of the river, its footing 126 feet below the head tower footing.

Installation of the cable was done by a step-up method, beginning with a one-half inch manila pilot rope, attached to a one-half inch wire rope,



and then the one and one-fourth inch wire rope messenger line over which the three-inch main track cable was hauled. It is anchored securely at each end to concrete anchors weighing 330 tons each, extending through the main "A" frame tower for 200 feet, and through the tail tower for 92 feet.

The hoist house is located directly behind the head tower, with 150-horsepower motor-powered hoisting machinery. Regenerative braking is employed, the current produced in braking being fed to a series of resistors instead of returned to the lines. The load line drums are gear-connected through friction clutches to the in-haul, out-haul drum for synchronizing purposes.

When using regenerative braking only, the maximum lowering speed is 48 feet per minute, and lesser speeds using both friction brakes and regenerative braking.

---

#### **AMERICAN CONCRETE INSTITUTE CONVENES IN SAN FRANCISCO**

The 47th Annual Convention of the American Concrete Institute was held in San Francisco, February 21-22.

Among the speakers were John J. Gould, consulting engineer of San Francisco, who described the design and construction of the 13-story, reinforced concrete apartment building built for the Metropolitan Life Insurance Company at Parkmerced, Prof. R. R. Martel, California Institute of Technology, Pasadena, was scheduled to discuss earthquake resistant design theory, and Charles S. Whitney, of Ammann & Whitney, Consulting Engineers of New York and Milwaukee was to describe the design of structure under dynamic loading applicable to earthquake design.

The conference was also scheduled to take up several Standard considerations.

---

#### **PCBOC CENTRAL DISTRICT MEETS IN SAN JOSE**

A meeting of the Central District of the Pacific Coast Building Officials Conference was held in San Jose early this month.

Consideration was given various phases of the building code problem, with President A. W. Russell presiding at the meeting.

---

#### **SIMPLIFIED PRACTICE RECOMMENDATION UNORIFICED RADIATOR SUPPLY VALVES**

A proposed Simplified Practice Recommendation for Unorificed Radiator Supply Valves has been submitted to producers, distributors, users, and others for acceptance or comment.

The recommendation was proposed by the Steam Heating Equipment Manufacturers, Associa-

tion, and covers unorificed radiator supply valves for use in two-pipe, low pressure steam heating systems. Its purpose is to direct attention to the size, pattern and capacities of these valves that currently are in use and demand.

---

#### **SISALKRAFT APPOINTS NEW SAN FRANCISCO MANAGER**

Robert S. Youngberg, formerly in charge of the Sisalkraft road sales department, has been appointed manager of the San Francisco office of the Sisalkraft Company.

Youngberg, who formerly lived in Evanston, Illinois, succeeds P. M. (Pat) Olsen who recently retired after being with the company for many years.

The Sisalkraft Company manufactures Sisalkraft waterproof, Sisal-reinforced protective papers and Sisalation reflective insulation.

---

#### **MARBLE INSTITUTE ELECTS**

A. A. Landi of the Landi Marble Corporation in New York was recently elected president of the Marble Institute of America, succeeding Roy E. Mays of the Carthage Marble Company of Carthage, Missouri.

Other officers elected include: J. W. Fisher, president of the South West Onyx & Marble Company, San Diego, California, vice president; A. H. Coerver, Shaw Marble Company, St. Louis, Mo., secretary; and F. J. Plimpton, Vermont Marble Company, Proctor, Vermont, treasurer.

---

#### **NEW PASSENGER TERMINAL SAN FRANCISCO AIRPORT**

The new passenger terminal at the San Francisco Airport is being designed to handle three million passengers per year. In 1950 more than one and a one-half million passengers used the airport, according to a report by the Public Utilities Commission of San Francisco, owners and operators of the airport.

Seventy-nine sheets of architectural plans on the structure have been submitted to the Art Commission for approval after which the plans must have the approval of the Civil Aeronautics Administration in order to qualify for Federal airport aid funds.

The building measuring 200 ft. by 400 ft. at the ground floor, excluding ramps, is being designed by architect William P. Day.

---

#### **ARCHITECT OPENS OFFICE**

William Corlett, A.I.A., Architect has opened offices for the general practice of architecture at 507 Howard Street, San Francisco.

## FLOOR MAINTENANCE ON WHEELS FOR PUBLIC SERVICE BUILDINGS

A successful new fleet plan of "service to customers" was recently inaugurated by the Hillyard Chemical Company of St. Joseph, Missouri, in the states of Colorado, Iowa, Illinois, Ohio and New Jersey. And plans are under way to repeat this program in other states.

Vanguard of this new fleet was worked out in cooperation with Chevrolet and Hillyard representatives in each sales territory. Its streamlined design is particularly adapted to the needs of bringing "on spot" floor maintenance help to thousands of schools, hospitals, stores, institutions, gymnasiums, industries of the nation.

The fleet is composed of ½ ton paneled Chevrolet trucks, and the neat clean lines of the model chosen, give it the appearance of a smart town car, yet, through master designing a usable loading space of 150 cubic feet is allowed. Says a spokesman for the Hillyard Company, "I can now carry heavy floor scrubbing and polishing machines, give practical demonstrations that were impossible before the purchase of my new service truck."

(See Page 43)

## VOTERS REJECT PUBLIC HOUSING IN VIRGINIA

Citizens of Roanoke, Virginia, recently defeated by 3 to 1 a proposal for the construction of 900 public housing units by the Roanoke Public Housing Authority.

The plan called for the eventual construction of 2,400 units.

## GOVERNMENT ORDERS TRANSMISSION LINE BETWEEN OREGON-CALIFORNIA

An order by the Secretary of the Interior, to initiate immediate steps for construction of a 230,000 volt transmission line between Klamath Falls, Oregon, and Shasta Dam in northern California, has been received by Richard L. Boke, regional director of the Bureau of Reclamation.

The line would inter-connect the power facilities of three great regions of the west, and would provide a link between the great generating capacity of the Pacific Northwest, the many hydroelectric and steam plants of California, and those of the lower Colorado River Basin.

Boke listed the mutual benefits of the inter-connection, as outlined by Defense Power Administration:

(See Page 43)



# BRONZE PRODUCTS

by GREENBERG

Your best and nearest source for standard and special Bronze products



STABILITY since 1854

M. GREENBERG'S SONS

765 Folsom St • San Francisco • Calif • EXbrook 2-3143

Manufacturers of Fire Hydrants and Fire Protection  
Brass Goods • Industrial, Navy and Maritime  
Bronze Valves and Fittings • Plumbing and  
Hardware Brass Specialties • Bronze Plaques,  
Letters and Name Plates.

LOS ANGELES • SEATTLE • PORTLAND • SPOKANE • SALT LAKE CITY • DENVER • EL PASO • NEW YORK • HARTFORD • WASHINGTON, D. C.

# American Institute



# of Architects

Ralph Walker, president  
Glenn Stanton, 1st vice president  
Kenneth E. Wischmeyer, 2nd vice president  
Clair W. Dilch, secretary  
Charles F. Cellorius, treasurer

#### Arizona Chapter:

Edward L. Varney, President; Ralph B. Haver, Secretary,  
35 W. Oregon Street, Phoenix, Arizona.

#### Central Valley of California:

William Koblik, President; Gordon Stafford, Vice-President;  
John W. Bomberger, Secretary; Albert B. Thomas, Treasurer,  
Secretary's Offices P. O. Box 1943, Modesto.

#### Coast Valleys Chapter:

Wm. Hempel, President; Lawrence Gentry, Vice-President;  
Walter Stromquist, Sec.-Treas.; Directors: Chas. Butler and  
Thos. S. Elston. Office, 257 State Street, Los Altos.

#### Colorado Chapter:

Henry I. Von Wyl, President; Charles H. Overholt, Secretary,  
2509 W. 36th Avenue, Denver, Colorado.

National Headquarters —  
1741 New York Avenue, N. W.  
Washington 6, D. C.

Edmund R. Purves  
Executive Secretary

#### Northern California Chapter:

Ralph N. Pollack, President; Francis J. McCarthy, Vice-  
President; William B. McCormick, Secretary; George A.  
Downs, Treasurer. Offices 369 Pine St. San Francisco.

#### Oregon Chapter:

Herman Brookman, President; Donald J. Stewart, Vice-  
President; Raymond Kermit Thompson, Secretary; Millard  
H. Schmeer, Jr., Treasurer. Secretary's office 429 S. W. 4th  
Avenue, Portland.

#### Pasadena Chapter (California):

Burton Romberger, President; Georgius Y. Cannon, Vice-  
President; Donald E. Neptune, Treasurer; William H. Tay-  
lor, Secretary. Directors: Boyd E. Georqi, Roland E. Coate,  
Edwin Westberg and Robert H. Ainsworth. Office 1041 E.  
Green St., Pasadena.

## WASHINGTON STATE CHAPTER

The Public Information Committee under the chairmanship of Bob Dietz report arrangements for the School Conference scheduled for March 30-31, an event which is jointly sponsored by the Department of Education and the School of Architecture at the University of Washington and the A.I.A. promises to develop into one of the outstanding events of the year.

Waldo Christenson, Chairman of the Legislative Committee, reports a concentrated effort will be

made to have the current State Legislature pass a modern and progressive Architects' Licensing Law to replace the present law in effect which was adopted in 1919. Considerable work has been done in preparing the measure and acquainting members of the Legislature with the provisions of the Act.

Bruce Blackstock has been admitted as a Student Associate member.

## ARCHITECT IS HONORED

Architect William G. Merchant has been elected a director of the San Francisco Chamber of Commerce for the year 1951, according to a recent announcement by Alan J. Lowrey, President.

## NORTHERN CALIFORNIA CHAPTER

The January 23rd meeting was devoted to a panel discussion called "The Alliance of the Arts" with seven artists telling how his particular field of art contributed to the enrichment of architecture.

Taking part in the program were: Robert Hagen, Art Critic of the San Francisco Chronicle; Ruth Cravath, Sculptor; Mary Erchenbrach, Ceramist; Larry Halprin, Landscape Architect; Maurice Sands, Interior Decorator; Steven Dimitroff, Muralist; Jerry Rubin, Weaver; Martin Sniper, Painter; and George Rockrise, Architect.

The program, arranged by George T. Rockrise, Chapter Program Chairman, was a continuation of the cooperation exemplified in the Fine Arts Festival which event was just completed, and proved to be one of the outstanding of its kind ever held in San Francisco.

Prior to the meeting a business meeting of the Junior Associates was held in the offices of Ward & Bolles, Architects, with members then attending the regular Chapter meeting.

Ralph Walker, President of the A.I.A. was a Chapter visitor during February, while on the West

**SPEED CONSTRUCTION**  
**WITH FIRESAFE, SAG-PROOF**  
**EASY-TO-USE**

**STRAN-  
STEEL**



**AVAILABLE**  
**STEEL FRAMING**  
**"Metal Lumber"**

**\*PROMPT DELIVERIES ON**  
**STUDS • JOISTS • CHANNELS**  
**IN STANDARD SIZES**

For complete information and prompt service, phone or write

**KRAFTILE COMPANY**

NILES, CALIFORNIA NILES 3611  
SAN FRANCISCO 3: 30 Hawthorne St.—DOuglas 3-3780  
LOS ANGELES 13: 406 South Main Street—MUnual 7241

East Bay Chapter:  
James H. Anderson, President; Loy Chamberlain, Vice-President; William Corlett, Secretary; Chester Treichel, Treasurer. Office c/o Sec., Bank of America Bldg., Oakland.

Montana Chapter:  
Ort Pickering, President; H. C. Cheever, Secretary, Montana State College, Bozeman, Montana.

Nevada Chapter:  
George L. F. O'Brien, President; Aloysius MacDonald, Vice-President; Graham Erskine, Secretary; Edward S. Parsons, Treasurer. Offices 160 Chestnut St., Reno.

Nevada State Board of Architects:  
L. A. Ferris, President, Reno; Walter Zick, Secretary, Las Vegas; Directors, Aloysius MacDonald, Las Vegas; Russell Mills and Edward Carsons, Reno. Office, P. O. Box 2107, Las Vegas, Nevada.

San Diego Chapter:  
George C. Hatch, President; Jack R. Lewis, Vice-President; Louis A. Dean, Secretary; Donald Campbell, Treasurer; Directors, C. J. Fadzewski, Walter C. See, Louis H. Bodmer, and Wm. Templeton Johnson. Offices Suite 206 Fifth Avenue Building.

San Joaquin Chapter: (California)  
Fred L. Swartz, President; Fresno; Lloyd J. Fletcher, Vice President; Visalia; Walter Wazner, Secretary; Fresno; Robert W. Stevens, Treasurer, Fresno. Directors: Alastair Simpson, William D. Coats, William F. Baxter, Maurice J. Metz, Delegate California Council of Architects. Office, Sec. Fulton-Fresno Bldg.

Santa Barbara Chapter (California):  
Robert I. Hoyt, President; Harold E. Burket, Vice-President; Roy W. Cheesman, Secretary; Lutah M. Riggs, Treasurer. Address, 242 San Marcos Bldg.

CALIFORNIA COUNCIL OF ARCHITECTS  
Frank V. Mayo, President; Frederick A. Chaze, Executive Secretary. Office, 3757 Wilshire Blvd., Los Angeles 5.  
Southern California Chapter:  
John J. Landon, President; Chas. Frey, Vice-President; C. Day Woodford, Secretary; Wm. G. Balch, Treasurer. Directors, Paul O. Davis, Henry Wright, John Rex, and Kemper Nomland. Chapter Headquarters, 3757 Wilshire Blvd., Los Angeles 5.

Spokane Chapter:  
Richard H. Eddy, President; Harry C. Weller, Vice-President; Kenneth D. Stormont, Vice-President; Victor L. Wulff, Secretary, and Carl Johnson, Treasurer. Office 1023 W. Riverside Ave., Spokane, Washington.

Utah Chapter:  
Howell O. Cannon, President; William J. Monroe, Jr., Secretary, 3707 South 32nd West Street, Salt Lake City 7, Utah.

Washington State Chapter:  
Perry B. Johanson, President; Paul Thiry, 1st Vice-President; Thomas F. Harbeson, Jr., 2nd Vice-President; John S. Dethle, Secretary; Lawrence G. Waldron, Treasurer. Office 714 American Bldg., Seattle 4.

Tacoma Society:  
E. H. Dugan, President; P. G. Ball, Vice-President; Lyle Swedberg, Secretary-Treasurer.

Hawaii Chapter:  
James C. Simms, President; Alfred Preis, Secretary, 1507 Kapolei Blvd., Honolulu, T. H.

---

Coast conferring with Architectural leaders and presenting a series of three lectures at Stanford University.

#### A.I.A. PRESIDENT VISITS WEST COAST

Ralph Walker, President of the American Institute of Architects, arrived on the West Coast the latter part of this month to deliver three lectures at Stanford University.

While in the San Francisco Bay Area, Walker attended a joint meeting of the Northern California Chapter, the East Bay Chapter, and the Coast Valleys Chapter of the A.I.A.

Walker also attended a meeting of the Regional Survey Commission of the Federal Government, of which he is a member.

#### LANDSCAPE DIVISION EXPANSION AT DAVIS

Plans for present and future expansion of the landscape gardening division on the Davis campus of the University of California were recently discussed by Robert Deering, Chairman of the division, at the annual banquet of the California Nurserymen's Association.

"This year the staff has been increased from one to three," said Deering. "While the seven courses now being offered are being given only in the two year curriculum, it is possible that a degree major may be added in the future."

Nearly ten acres west of the School of Veterinary Medicine have been allocated to landscape gardening for a new nursery, gardens, and experimental plots. Cold frames, lath houses, laboratory and service buildings will be erected there during the next few years. The division will also have space in the Horticulture-Landscape Gardening building, now in the planning stage. Facilities

will include a herbarium, chemical and physiology research laboratories, controlled temperature and photographic rooms, a conservatory, and a departmental library, as well as classrooms and laboratories.

#### SOCIETY OF ARCHITECTURAL HISTORIANS MEET IN WASHINGTON

Washington's many historic buildings and shrines came under the scrutiny of experts on historical buildings when the Society of Architectural Historians met recently in Washington, D. C.

Among those appearing on the program were: Louis Simon, F.A.I.A., and former Supervising Architect; John F. Harbeson of Philadelphia, consulting architect; Randall Truitt, Albert Peets, Paul F. Norton, and Frederick Gutheim.

Worth Bailey, Milton Grigg, Helen Duprey Bullock, Murray Nelligan, and L. Morris Leisnering and Charles Scarlett, Jr., also appeared on the program.

Subjects covered included detailed accounts of various government buildings and monuments, including the Capitol and The Octagon.

#### NATIONAL A.I.A. OFFICIAL OPTIMISTIC ON BUILDING

Edmund R. Purves, executive director of the American Institute of Architects, has expressed confidence that the architects who design the nation's buildings and specify the materials that go into them will be able to adapt their work to material shortages resulting from the present rearmament program.

"While shortages of certain building materials will tax the ingenuity of building designers to the utmost, they also offer a challenge to architectural ability," said Purves. "We must learn to improvise

(See Page 34)



# WITH THE ENGINEERS

## Structural Engineers Association of Northern California

John E. Rinne, President; John J. Gould, Vice-President; Wm. W. Brewer, Sec.; Franklin P. Ulrich, Treas.; Directors, Walter L. Dickey, Leslie W. Graham, Hyman Rosenhall, and Howard A. Schirmer.

## Structural Engineers Association of Central California

William H. Petersen, President; Walter S. Wassum, Vice President; O. T. Illich, Sec. Treas.; Ernest D. Francis, M. A. Ewing, and Arthur A. Sauer, directors. Office O. T. Illich, c/o Div. of Arch., Sacramento.

## American Society of C. E. San Francisco Section

A. W. Earl, President; G. B. Woodruff, Vice President; C. T. Wiskocil, Vice President; R. D. Dewell, Secretary-Treasurer. Secretary's Office, 604 Mission Street, San Francisco.

## Structural Engineers Association of Southern California

Donald F. Shugart, President; Harold P. King, Vice President; Robert J. Short, sec-Treas.; Directors, William T. Wheeler, William T. Wright, Ernest C. Hillman, Jr., John Case, and John K. Minasian. Office, 202 Architects Bldg., Los Angeles 13.

## Structural Engineers Association of Oregon

R. Evan Kennedy, President; Guy H. Taylor, Vice President; James R. Griffith, Secretary-Treasurer; Directors Jerome A. McDevitt, H. Loren Thompson, and Robert L. Tidball. Offices, Portland.

## Puget Sound Engineering Council (Washington)

R. E. Kister, A. I. E. E., Chairman; E. R. McMillan, A. S. C. E., Vice Chairman; L. B. Cooper, A. S. M. E., Secretary; A. E. Nickerson, I. E. S., Treasurer. Offices, L. B. Cooper, c/o University of Washington, Seattle 5, Washington.

## STRUCTURAL ENGINEERS ASSOCIATION SOUTHERN CALIFORNIA

The Structural Engineers Association of Southern California has recently issued a publication for all its members containing a Code of Ethics, Constitution, By-Laws, and Code of Standard Practice. The booklet represents the results of professional study inaugurated when the Chapter was first formed in 1927.

The Association has also released a group of three Technical Bulletins which is the result of considerable study by various committees.

A Committee headed by Murray Erick, Chair-

man, with S. B. Barnes, H. W. Bolin, R. W. Binder, Ben Benioff, John D. Mendenhall, and Harold P. King, members, have issued Technical Bulletin No. 1, covering the subjects of Horizontal Bracing Systems in Buildings Having Masonry or Concrete Walls. A special committee on Tilt-Up Construction, with S. B. Barnes, Chairman, and F. M. Andrus, O. G. Bowen, R. R. Bradshaw, D. C. Butz, F. T. Collins, E. Magg, A. F. J. Miller, J. T. Stafford, W. M. Taggart, and G. D. Youngclaus as members, have issued Technical Bulletin, No. 2, entitled "Tilt-Up Construction."

A third committee comprising Samuel Hobbs, Chairman, and John E. Mackel, Albyn Mackintosh, Edw. J. Teal, C. D. Wailles, Jr., and H. C. Whittlesey as members, has issued Technical Bulletin, No. 3, entitled, "Good Practice in Engineering Design and Construction with Reinforced Concrete Masonry."

## ENGINEERING AWARD TO BERKELEY MAN

C. F. Dalziel, professor of electrical engineering on the Berkeley campus of the University of California, and T. H. Mansfield, electrical engineer at Tracerlab, Inc. have been given outstanding awards by the American Institute of Electrical Engineers.

Prof. Dalziel and Mansfield, co-authors of a paper, "Effect of Frequency on Perception Currents", were awarded second prize as the best paper of 1950 among papers generally applicable to the field of electrical engineering.

## ENGINEER CHIEF EMPHASIZES MILITARY MAP IMPORTANCE

Stating that the need for military maps during times of conflict can never be fully satisfied, Major General Lewis A. Pick, Chief of Engineers, U. S. Army, has urged the nation's photogrammetrists to exert "every effort of their science to ease the



Always specify

**HAW'S**

for Highest Quality

Sanitary Drinking Fountains

Electric Water Coolers

Drinking Faucets, Equipment, Filters and Accessories

• A reputation for reliability since 1909. Check in Sweets or write for HAW'S catalog.

**HAW'S DRINKING FAUCET CO.**

1441 FOURTH STREET (Since 1909) BERKELEY 10, CALIFORNIA  
Agents and Sales Representatives in All Principal Cities

burden of the military."

Speaking before a recent meeting of the American Society of Photogrammetry, General Pick called the military map a "blueprint of all phases of the military, from planning operations," and pointed out that the key to modern map production is photogrammetry — the science of obtaining basic photographic surveys.

World War II emphasized the importance of maps as military tools, and on the day that South Korea was invaded the Corps of Engineers had in stock, in the United States, 650,000 copies of 382 different sheets, representing a complete coverage of South Korea.

### STRUCTURAL ENGINEERS ASSOCIATION NORTHERN CALIFORNIA

The February meeting combined an address by Col. Jack Singleton, Chief Engineer for the American Institute of Steel Construction, on the subject "Recent Engineering Phases of Construction," and a motion picture showing the construction of the forty-story Secretariat Building of the United Nations Headquarters in New York City. The motion picture, entitled, "Building for the Nations", followed a period of questions and answers on the remarks of Col. Singleton.

### ENGINEER CONVENTION DECLARED BIG SUCCESS

The third annual convention of the California Society of Professional Engineers, recently held in San Francisco, was attended by more than 3000 engineers representing all parts of the West.

According to John L. Trebilcock, Society president, it was the most outstanding conference yet held by the group.

Among the many program speakers was S. L. Stolte of Minneapolis, president of the National Society of Professional Engineers.

### CALIFORNIA STATE POLYTECHNIC COLLEGE INAUGURATES PROGRAM

The Department of Architectural Engineering at the California State Polytechnic College, San Luis Obispo, California, has inaugurated a lecture series on building material and methods to be conducted by members of the Southern California Chapter of the Producers Council.

The lectures will be coordinated with the regular department courses in materials and methods of construction.

Producer Council members participating in the program include: Libbey-Owens Glass Company, Glass; W. P. Fuller Company, Paints and Wall Coverings; Blue Diamond Corp. & Gypsum Association, Plastering and Lathing; The Master Build-

ers Company, Wood Fasteners; Celotex Corporation, Acoustics; American Lumber & Treating Company, Wood Treating and Grading; Ceco Steel Products Corporation, Prefabricated Steel Structural Units; Armstrong Cork Company, Floor and Wall Coverings; The Stanley Works, Tools and Hardware; Truscon Steel Company, Fabricated Steel Products; Natural Gas & Equipment Company, Heating Equipment; and the Southern California Gas Company, Heating Equipment.

### AMERICAN SOCIETY OF HEATING AND VENTILATING ENGINEERS

Lauren E. Seeley, dean of the College of Technology and director of the Engineering Experiment Station, University of New Hampshire, Durham, has been elected 1951 president of the American Society of Heating and Ventilating Engineers at the 57th annual meeting of the Society. He succeeds Lester T. Avery, of Cleveland.

Other officers elected include: 1st vice president Ernest Szekely, president of the Baylor Blower Co., Milwaukee, Wis.; 2nd vice president, Reg. F. Taylor, consulting engineer, Houston, Texas; treasurer, Howard E. Sproull, division sales manager, American Blower Corp'n., Cincinnati.

(See Page 33)

## Always specify *HAWS* for Highest Quality



**HAWS Electric Water Coolers** easily adapt to remote installations of HAWS Drinking Fountains... thus serving several locations.

- A COMPLETE LINE of coolers, fountains, faucets, equipment, filters and accessories. • A reputation for reliability since 1909. • Check in Sweets, or write for complete HAWS catalog.

**HAWS DRINKING FAUCET CO.**  
1441 FOURTH STREET (Since 1909) BERKELEY 10, CALIFORNIA  
Agents and Sales Representatives in All Principal Cities



# A Combined

**Landscape Architecture  
and Contracting Service**

for

**Tract, Industrial and Residential  
Development**

**We can do the Complete Job for you**

- Landscape Architecture
- Finish Grading and Landscaping
- Asphalt Drives and Parking Lots
- Chain Link Fencing

**HENRY C. SOTO CORPORATION**  
*Landscape Contractors*

13000 SO. AYALON BLVD. LOS ANGELES 61, CALIF.

Phone MEnlo 4-6617

## A.I.A. ACTIVITIES

(From Page 29)

with available materials, and work out methods of construction and simplifications of planning that will enable all needed building to proceed under difficult and trying circumstances.

"Cooperation of the profession with governmental regulations and policies must be achieved if the profession is to play its role in the crucial days through which we are passing. Such cooperation may even be a factor in the survival of the profession."

Purves' comment followed a conference between Ralph Walker, president of the A.I.A., and Glenn Stanton, vice-president of the A.I.A., and officials of the National Production Authority including William H. Harrison, chief.

## A.I.A. PAMPHLET ON CIVIL DEFENSE ISSUED

A pamphlet outlining the architect's participation in civil defense activities has been issued by the American Institute of Architects. It is the work of a group of architects headed by Harry M. Prince, former New York building commissioner who served in England as an observer for civil defense chief Fiorello H. LaGuardia when buzz bombs were falling in World War II.

It is pointed out that architects can best fit into the civil defense program by application of government civil defense directives and standards in the structural protection of the public, and the tenants of buildings, in order to provide as much safety as possible against all forms of attack. Architects can also design protective measures in new construction; plan defense structures so that they may be readily converted to peacetime usefulness; recommend measures to strengthen zoning, building, and housing ordinances; and advise city agencies on the civil defense aspects of city planning.

## LACK OF ARCHITECTS SLOWS STATE WORK

Chas. H. Purcell, Director of the Department of Public Works for the State of California, reported to Governor Earl Warren recently that "a shortage of architects is causing California's huge building program of schools, hospitals and prisons, to lag behind schedule."

Even though many State projects are awarded private architects, Purcell declared "the private architects are so overloaded with work", they can not take care of the State's needs.

OSCAR A. TRIPPET, Attorney, and native of Southern California, has been elected president of the Los Angeles Chamber of Commerce.

*The trend is to QUALITY  
in lighting equipment*



**- MEANS  
TOP  
QUALITY  
ALWAYS!**

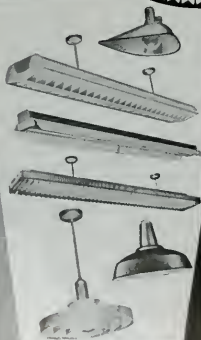

**new**

This is the new, low Price Ceiling-Lite designed for remote wall and recessed installation. Laboratories experimentally effective January 1, 1951. Made in New York.

No. SH-2110 - 12" glass  
No. SH-2112 - 12" glass  
No. SH-2114 - 12" glass  
No. SH-2118 - 12" glass

SMOOTH-HOLMAN COMPANY, Incorporated, Calif. Offices in Principal Western Cities • Branch and Warehouse in San Francisco

#### NEW HOSPITAL FOR PHOENIX

Foundation Day on December 12th saw ground broken for construction of the new St. Joseph's Hospital at Thomas Road and 3rd Avenue in Phoenix.

Two years will be required to complete the construction program which calls for an addition of 370 beds to the present facilities.

Lescher & Mahoney of Phoenix are the architects.

#### NEW OFFICE BUILDING

A new type office building is being built in Phoenix for the architectural firm of Frederick K. Griffin and Edgar E. Clepper. It will contain eight secretarial and drafting room offices plus storage facilities.

#### NEW GRAMMAR SCHOOL

Bonds have been voted for the construction of an 8-classroom, administration, kindergarten, multi-purpose, kitchen and toilet grammar school building for the Oak Grove Elementary School District at Oak Grove (Sonoma County). Estimated cost is \$200,000.

J. Clarence Felciano of Santa Rosa is the architect.

#### SCHOOL CAFETERIA

Drawings have been completed for the construction of a cafeteria building for the Hollister High School at a cost of \$125,000. The building will be of structural steel frame and stucco construction.

Falk and Booth of San Francisco are the architects and engineers.

#### SCHOOL PROJECT FINANCED

The Redwood City Elementary School District has announced completion of a program calling for the construction of five new grammar schools in Redwood City at an estimated cost of \$2,501,933. A bond issue of \$219,000 was recently approved and a State Aid Loan of \$2,283,933 has been granted.

#### CALIFORNIA PLANS PRINTING PLANT

The State of California has plans under way for the construction of a new state printing plant on West 7th Street in North Sacramento at a cost of \$2,780,000. Of structural steel frame and reinforced concrete construction the building will contain 240,000 sq. ft.

Architects for the project are Wurster, Bernardi & Emmons of San Francisco, and Albert W. Kahl of San Mateo.

#### NEW LIBRARY

The City of Monterey is constructing a new Library Building at a cost of \$350,000, comprising a one story and basement structure of reinforced concrete and frame construction.

Wurster, Bernardi & Emmons of San Francisco are the architects.

#### NEW GARAGE

The Barrett Garages, Inc., of San Francisco have applied to the City of San Francisco for a building permit for the construction of a two story, basement and roof parking, garage on Lick Place between Post and Sutter streets.

Ellison & King of San Francisco are the structural engineers for the project.

#### NEW PHONE BUILDING

A new office building to serve the revenue accounting department of the Pa-

cific Telephone & Telegraph Company is being built on the corner of Lexington and Orange streets in Glendale, at an approximate cost of \$500,000.

Cejay Parson, Los Angeles, is the architect.

#### YMCA BUILDING

Work has started on a new building for the YMCA in Tucson, Arizona, which will include a swimming pool. Cost of the project is \$326,000.

Emerson Scholer of Tucson is the architect.

#### NEW APARTMENT

A new two story apartment building is being built in Phoenix, Arizona, by contractor D. H. Murdock at a cost of \$80,000.

It will provide eight one-bedroom and

four two-bedroom units.

Jake Knapp of Phoenix is the architect.

#### NEW PHONE BUILDING

A new dial exchange building is being built in Phoenix, Arizona, for the Mountain States Telephone and Telegraph Company at a cost of \$96,997.

Lescher & Mahoney, Phoenix, are the architects.

#### ARCHITECT CHOSEN

Architect Ned Abrams of Sunnyvale (California) has been selected as the architect for a U. S. Navy Housing Project of seventy-two units to be constructed at Moffett Field in Santa Clara county.

The houses are to be constructed under terms of the Wherry Act.

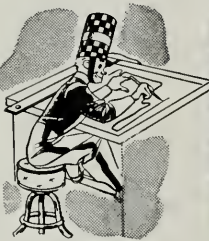

Above: Terrazzo showroom floor, Lustine Nicholson Motor Co., Hyattsville, Maryland. Architect—Dane Jockley, Baltimore, Md.

## WHY THIS BEAUTIFUL FLOOR WILL STAY BEAUTIFUL YEAR AFTER YEAR . . .

The original beauty and color of this floor is permanently protected by Hillyard Care against surface wear. No danger of damage from dirt, daily traffic—no soiling from spilled foods, liquids—no fear of slipping accidents. Hillyard's exclusive penetrating ONEX-SEAL seals out dirt—provides the hard, glossy, slip-resistant surface you see above — to resist scuffs, scratches, spots. It's waterproof . . . is easily maintained with Hillyard's SUPER SHINE-ALL neutral chemical no-rinse cleaner.

Hillyard's specialized floor treatments, sanitation, maintenance products and efficient machines, are particularly adapted to commercial, institutional, schools, hospital building needs. Quick-acting, work-saving, they get the job done "on schedule" without fuss or muss—and with a minimum of employed labor.

#### At Your Service

Hillyard maintains a nation-wide staff of trained Maintainers to give help and "on job" supervision on any type of floor problem. This service, for architects and colleagues, is extended without cost or obligation.

#### FREE FOLDER

Send coupon below for free folder on care of terrazzo floors.

"... on your staff but not your payroll."



St. Joseph, Missouri

Branches in Principal Cities

Hillyard Chemical Co.  
Dept. NI-2, St. Joseph, Missouri

Dear Sirs: Please send me FREE folder on "The Proper Treatment of Terrazzo and Cement Floors."

Name  Title

Institution

Address

City  State



## PHYSICAL REQUIREMENTS

(From Page 7)

means danger in those heights. If the dizziness is severe the worker may lose balance and fall to the ground, at least he has to lean on the next wall—if there is a wall.

Often dizziness is caused by severe physical or mental strain, long hours of work or insufficient sleep. Other causes are an abundance of smoking or another excess, general weakness after sickness, or anemia, thin blood. Dizzy spells after an attack of flu are nothing unusual. Many cases of dizziness are produced by lazy bowels; chronic constipation may poison the blood and the brain.

There is also a kind of nervous dizziness. Most troubles of that kind disappear quickly under proper treatment, but they need examination and care. As long as he is troubled by repeated dizzy spells, no painter or building worker should work alone on a ladder or scaffold. Ear troubles are frequently connected with vertigo (dizziness).

Sometimes building workers who are nearsighted or farsighted, find themselves without their glasses to which they are accustomed and on which they depend. They estimate incorrectly the distance they have to cope with on their scaffold, they have a blurring of vision. Proper glasses, well adjusted, are an indispensable factor of safety in those dizzy heights.

Difficulties arise particularly in cases when a man needs two kinds of glasses, one for seeing in distance and another at close range. He should not avoid the slight trouble of changing his glasses according to his present needs.

### Loss of Balance

The careless use of scaffolds, ladders, stepstools etc. or the use of defective ones may result in disastrous falls. Loss of balance while standing and working on the ladder etc. is the most frequent cause of falls. Most of the victims who lost their balance and fell were overreaching with arms stretched over their heads and far to one side.

Accidents of this type often occur because ladders are placed too far away from the point to be reached, or too close to it. Or the ladders may be too short for the purpose. The high figures for accidents in the building trades (171% of the average for builders and building contractors; 137% for brick and stone masons; 217% for roofers) are in part connected with such procedures.

The members of the building trades, including painters and roofers, are bound to work on exposed scaffolds, ladders and horses. Better care for life and safety can be procured from two directions: from the equipment and from the working man himself.

In New York the causes of accidents of painters were examined. It turned out that ladders and scaffolds together caused 51.3 per cent, more than half of the accidents. Either the equipment was defective or the men were working so rapidly that accidents were due to this hurried working. The taller the building, the greater the care used on the equipment on the average. There is more negligence on low-ceiling buildings. The difference comes from the natural knowledge that a slight stumbling on a skyscraper is fatal while a fall from a three-story house may mean only a sprained ankle.

Comparative statistical figures of the building trades compared with other industrial activities have shown that accidents caused by ladders and scaffolds in the building trades are about 2½ times as frequent as in the average of all occupations. Statistical experience has shown that scaffold accidents are particularly dangerous and costly for both worker and employer.

Speedy work, in this connection, may well attribute its share to the high number of scaffold and ladder accidents. Today, according to a report by A. B. Gersh, a painter is expected to cover at least 3,500 square feet of wall space per day, and frequently as much as 5,000 square feet. Some twenty years ago 1,500 to 2,000 square feet were regarded as adequate for a longer day's work. However, safety measures on the average, are decidedly more reliable today than they used to be in former times.

*Looked into  
all these lately?*

It's growing all the time—the list of uses for which gas is superior:

Cooking	House heating
Refrigeration	Clothes drying
Water heating	Garbage disposal
All-year air conditioning	

If your technical data files are low on any of these, why not get in touch with your Gas Company for details?

*The West  
prefers*

**GAS**



**BETTER • QUICKER • CHEAPER**

# ESTIMATOR'S GUIDE

## BUILDING AND CONSTRUCTION MATERIALS

PRICES GIVEN ARE FIGURING PRICES AND ARE MADE UP FROM AVERAGE QUOTATIONS FURNISHED BY MATERIAL HOUSES TO SAN FRANCISCO CONTRACTORS. 3% SALES TAX ON ALL MATERIALS BUT NOT LABOR

All prices and wages quoted are for San Francisco and the Bay District. There may be slight fluctuation of prices in the interior and southern part of the state. Freight charge, at least, must be added in figuring country work.

**BONDS—Performance or Performance plus Labor and Material Bond(s).** \$10 per \$1000 on contract price. **Labor & Material Bond(s)** only, \$5.00 per \$1000 on contract price.

**BRICKWORK—MASONRY—**

Common Brick—Per 1 M laid—\$100.00 up (according to class of work).  
Face Brick—Per 1 M laid—\$200.00 and up (according to class of work).  
Brick Steps—\$3.00 and up.  
Common Brick Veneer on Frame Blids.—Approx. \$1.20 and up—(according to class of work).  
Face Brick Veneer on Frame Blids.—Approx. \$2.00 and up (according to class of work).  
Common Brick—\$36.00 per M—truckload lots, delivered.  
Face Brick—\$61.00 to \$106.00 per M, truckload lots, delivered.

**Glazed Structural Units—**  
Clear Glazed—  
2 x 6 x 12 Furring ..... \$1.60 per sq. ft.  
4 x 6 x 12 Partition ..... 1.90 per sq. ft.  
4 x 6 x 12 Double Faced  
Partition ..... 2.25 per sq. ft.  
For colored glaze add .30 per sq. ft.  
Mantel, Fire Brick—\$105.00 per M—F.O.B. Pittsburgh.

Fire Brick—Per M—\$111.00 to \$147.00.  
Paving—Approx. \$10.00 per M.  
Paving—\$75.00.

**Building Tile—**  
6 5/8 x 12-inches, per M ..... \$139.50  
6 5/8 x 12-inches, per M ..... 195.00  
4 5/8 x 12-inches, per M ..... 84.00

**Hollow Tile—**  
12x12x4-inches, per M ..... \$146.75  
12x12x3-inches, per M ..... 156.95  
12x12x4-inches, per M ..... 177.10  
12x12x4-inches, per M ..... 235.30  
F.O.B., Plant

**BUILDING PAPER & FELTS**

1 ply per 1000 ft. roll ..... \$5.30  
2 ply per 1000 ft. roll ..... 7.80  
3 ply per 1000 ft. roll ..... 9.70  
Brownlin, Standard 500 ft. roll ..... 6.85  
Sisalraft, reinforced, 36 in. by 500 ft. roll ..... 7.00

**Sheathing Papers—**  
Asphalt sheathing, 15-lb. roll ..... \$2.00  
30-lb. roll ..... 2.79  
Dampcourse, 24-lb. roll ..... 2.95  
Blue Plasterboard, 40-lb. roll ..... 5.10

**Felt Papers—**  
Deadening felt, 3/4-lb., 50-ft. roll ..... \$3.23  
Deadening felt, 1-lb. .... 3.79  
Asphalt roofing, 15-lbs. .... 1.00  
Asphalt roofing, 30-lbs. .... 2.79

**Roofing Papers—**  
Asphalt Ktg., 15 lb. .... \$2.99  
Standard Grade, 108-ft. roll, Light ..... 1.87  
Smooth Surface, Medium ..... 2.18  
Heavy ..... 2.56  
M. S. Extra Heavy ..... 2.96

**BUILDING HARDWARE—**

Sash cord com. No. 7 ..... \$2.65 per 100 ft.  
Sash cord com. No. 8 ..... 3.80 per 100 ft.  
Sash cord spot No. 7 ..... 3.65 per 100 ft.  
Sash cord spot No. 8 ..... 3.35 per 100 ft.  
Sash weights, cast iron \$100.00 ton ..... \$3.75  
1-Ton lots, per 100 lbs. .... \$3.75  
Less than 1-Ton lots, per 100 lbs. .... \$4.75  
Nails, per keg, base ..... \$1.63  
Bin. spikes ..... 11.80  
Rim Knob lock sets ..... 1.80  
Burrts, dull brass plated on steel, 3/2x3/2 ..... .76

**CONCRETE AGGREGATES—**

The following prices net to Contractors unless otherwise shown. Carload lots only.

	Bunker per ton	Del'd per ton
Gravel, all sizes	\$2.44	\$2.90
Top Sand	2.38	3.13
Concrete Mix	2.38	3.06
Crushed Rock, 1/4" to 3/4"	2.38	2.90
Crushed Rock, 3/4" to 1 1/2"	2.38	2.90
Roofing Gravel	2.81	2.90
River Sand	2.50	3.00
Sand—		
Lapis (Nos. 2 & 4)	3.56	3.94
Olympia (Nos. 1 & 2)	3.56	3.88

**Cement—**  
Common (all brands, paper sacks), carload lots, \$3.55 per bbl. f.o.b. car; delivered \$3.60.  
Per Sack, small quantity (paper) ..... \$1.05  
Carload lots, in bulk per bbl. .... 2.79  
Cash discount on carload lots, 10c a bbl, 10th Prox., less than carload lots \$4.00 per bbl. f.o.b. warehouse or delivered.  
Cash discount 2% on L.C.L.

Trinity White { 1 to 100 sacks, \$3.13 sack  
warehouse or del.; \$7.56  
Medusa White { bbl. carload lots.

**CONCRETE READY-MIX—**

1-2-4 mix, to 10 yards ..... \$12.00  
10 to 100' yards ..... 11.00  
100 to 500' yards ..... 10.50  
Over 500' yards ..... 10.30

\* Delivered to site.

**CONCRETE BLOCKS—**

	Hay-dite	Basalt
48x8x6-inches each	\$.17	\$.18
68x8x6-inches, each	..22	..25
8x8x6-inches, each	..26	..26
12x8x6-inches, each	..34	..39
12x8x2 1/2-inches, each	.....	..60

**Haydite Aggregates—**  
3/4-inch to 1 1/2-inch, per cu. yd. .... \$7.25  
3/4-inch to 3/8-inch, per cu. yd. .... 7.25  
No. 6 to 0-inch, per cu. yd. .... 7.25

**DAMP-PROOFING and Waterproofing—**

Two-coat work, \$9.00 per square.  
Membrane waterproofing—4 layers of saturated felt, \$10.00 per square.  
Hot coating work, \$5.00 per square.  
Medusa Waterproofing, \$3.50 per lb. San Francisco Warehouse.  
Tricosal concrete waterproofing, 60c a cubic yd. and up.

**ELECTRIC WIRING—\$15 to \$20 per outlet for conduit work (including switches).**

Knob and tube average \$6.00 per outlet.

**ELEVATORS—**

Prices vary according to capacity, speed and type. Consult elevator companies. Average cost of installing a slow speed automatic passenger elevator in small four story apartment building, including entrance doors, about \$9,500.00.

**EXCAVATION—**

Sand, \$1.00; clay or shale, \$1.50 per yard. Trucks, \$30 to \$45 per day.  
Above figures are an average without water. Steam shovel work in large quantities, less hard material, such as rock, will run considerably more.

**FIRE ESCAPES—**

Ten-foot galvanized iron balcony, with stairs, \$250 installed on new buildings; \$300 on old buildings.

**FLOORS—**

Asphalt Tile, 1/8 in. gauge 18c to 35c per sq. ft.  
Composition Floors, such as Magnesite, 50c per square foot.  
Linoleum, standard gauge sq. yd. .... \$2.75  
Mastic Pavement—\$1.50 per sq. yd.  
BattleShip Linoleum—1/8"—\$3.00 sq. yd.  
Terazzo Floors—\$1.50 per sq. ft.  
Terazzo Steps—\$2.50 per lin. ft.  
Mastic Wear Coat—according to type—20c to 35c.

**Hardwood Flooring—**

Oak Flooring—T & G—Unfin.  
Clear Old, White, 1 1/2x2 1/4, 1 1/2x2 3/4, 2x2 1/4, 2x2 3/4  
Clear Old, Red, 405 380 \$ \$  
Select Old, Red or White, 355 340  
Clear Pine, Red or White, 355 340 335 315  
Select Pine, Red or White, 340 330 325 300  
#1 Common, Red or White 315 310 305 280  
#2 Common, Red or White 305

**Finished Oak Flooring—**

	Prime	Standard
1/2 x 2	\$369.00	\$359.00
3/4 x 2	380.00	370.00
1 1/4 x 2 1/4	390.00	381.00
1 1/4 x 2 3/4	375.00	355.00
1 1/4 x 3	375.00	375.00
3 1/4 x 2 1/4	415.00	415.00

**Unfinished Maple Flooring—**

1 1/4 x 2 1/4 First Grade	\$390.00
1 1/4 x 2 1/4 2nd Grade	365.00
1 1/4 x 2 1/4 3rd Grade	375.00
1 1/4 x 2 1/4 2nd & 3rd Grade	240.00
1 1/4 x 3/4 3rd & Btr. Jrd. EM	380.00
1 1/4 x 3/4 2nd & Btr. Jrd. EM	390.00
3 1/2 x 2 1/4 First Grade	400.00
3 1/2 x 2 1/4 2nd Grade	360.00
3 1/2 x 2 1/4 3rd Grade	320.00

Floor Layer' Wage \$2.50 hr.

**GLASS—**

Single Strength Window Glass, .30 per sq. ft.  
Double Strength Window Glass, .45 per sq. ft.  
Plate Glass, 1/4 polished to 75, 1.60 per sq. ft.  
75 to 100, 1.74 per sq. ft.  
1/4 in. Polished Wire Plate Glass, 2.35 per sq. ft.  
1/4 in. Rgh. Wire Glass, .71 per sq. ft.  
1/4 in. Polished Wire Plate Glass, 2.00 per sq. ft.  
1/4 in. Rgh. Wire Glass, .84 per sq. ft.  
1/2 in. Obscure Glass, .40 per sq. ft.  
3/8 in. Obscure Glass, .64 per sq. ft.  
1/2 in. Heat Absorbing Obscure, .58 per sq. ft.  
1/4 in. Heat Absorbing Wire, .86 per sq. ft.  
Glazing of above additional \$1.15 to .30 per sq. ft.  
Glass Blocks, set in place, 3.50 per sq. ft.

**HEATING—**

Average, \$3.50 to \$4.00 per sq. ft. of radiation, according to conditions.  
Warm air (gravity) average \$64 per register.  
Forced air average \$91 per register.

## INSULATION AND WALLBOARD—

Rocwool Insulation—	
(2") Less than 1,000 sq. ft.	\$64.00
(2") Over 1,000 sq. ft.	\$70.00
Cotton Insulation—Full-thickness	
(3½")	\$75.50 per M sq. ft.
Silicalation Aluminum Insulation—Aluminum coated on both sides	\$73.50 per M sq. ft.
TiIeboard—4½" panel	\$9.00 per panel
Wallboard—½" thickness	\$55.00 per M sq. ft.
Finished Plant	\$49.00 per M sq. ft.
Ceiling TiIeboard	\$49.00 per M sq. ft.

**IRON—**Cost of ornamental iron, cast iron, etc., depends on designs.

## LUMBER—

S4S No. 2 and better common	
O.P. or D.F., per M. f.b.m.	\$100.00
Rough, No. 2, common O.P. or D.F., per M. f.b.m.	100.00

## Flooring—

	Per M Delvd.
V.G.—D.F. 8 & Btr. 1 x 4 T & G Flooring	\$225.00
"C" and better—all	225.00
"D" and better—all	225.00
Rwd. Rustic—"A" grade, medium dry	185.00
	to 24 ft.
Plywood, per M sq. ft.	
¼-inch, 4.0x8.0-S15	\$170.00
½-inch, 4.0x8.0-S15	250.00
¾-inch, per M sq. ft.	315.00
Plywood	11½¢ per ft.
Phylform	25¢ per ft.

Shingles (Rwd. not available)—

Red Cedar No. 1—\$9.50 per square; No. 2, \$7.00, No. 3, \$5.00.	
Average cost to lay shingles, \$6.00 per square.	
Cedar Shakes—½" to ¾" x 24/26 in handsplit tapered or split resaw, per square	\$15.25
¾" to 1½" x 24/26 in split resaw, per square	17.00
Average cost to lay shakes, 8.00 per square	
Pressure Treated Lumber—	
Wolmanized	Add 33¢ per M to above
Cresoted	
8-lb. treatment	Add 45¢ per M to above

**MARBLE—**(See Dealers)

## METAL LATH EXPANDED—

Standard Diamond, 3/40, Copper Bearing, L.C.L., per 100 sq. yds.	\$43.50
Standard Ribbed, ditto.	\$47.50

## MILLWORK—Standard.

D. F. \$150 per 1,000. R. W. Rustic \$175 per 1,000 (delivered).	
Double hung box window frames average with trim, \$12.50 and up, each.	
Complete door unit, \$15 to \$25.	
Screen doors, \$8.00 to \$12.00 each.	
Patent screen windows, \$1.25 a sq. ft.	
Cases for kitchen pantries seven ft. high, per lineal ft., upper \$9.00 to \$11.00; lower \$12.00 to \$13.00.	
Dining room cases, \$20.00 per lineal foot. Rough and finish about \$1.00 per sq. ft.	
Labor—Rough carpentry, warehouse heavy framing (average), \$75.00 per M.	
For smaller work average, \$85.00 to \$100. per 1,000.	

## PAINTING—

Two-coat work	per yard	85¢	
Three-coat work	per yard	\$1.10	
Cold water painting	per yard	25¢	
Whitewash	per yard	15¢	
Linseed Oil, Strictly Pure	Wholesale		
(Basis 7½ lbs. per gal.)	Raw	Bolled	
Light iron drums	per gal.	\$2.28	\$2.34
5-gallon cans	per gal.	2.40	2.46
1-gallon cans	each	2.52	2.58
Quart cans	each	.71	.72
Pint cans	each	.38	.39
½-pint cans	each	.24	.24
Turpentine	Pure Gum		
(Basis, 7.2 lbs. per gal.)	Spirits		
Light iron drums	per gal.	\$1.65	
5-gallon cans	per gal.	1.76	
1-gallon cans	each	1.88	
Quart cans	each	.54	
Pint cans	each	.31	
½-pint cans	each	.20	

## Pioneer White Lead in Oil Heavy Paste and All-Purpose (Soft-Paste)

	List Price	Price to Painters
Net Weight	per 100 lbs.	Pr. per 100 lbs.
Packages	pkgs.	pkgs.
100-lb. kegs	\$23.35	\$29.25
50-lb. kegs	30.05	15.03
25-lb. kegs	30.35	7.59
5-lb. cans	33.35	1.34
1-lb. cans	34.00	.36
500 lbs. (one delivery)		¾¢ per pound less than above.

\*Heavy Paste only.

## Pioneer Dry White Lead—Litharge—Dry Red Lead

	Price to Painters—Price Per 100 Pounds		
	100	50	25
Products	lbs.	lbs.	lbs.
Dry White Lead	\$26.30	\$4.00	\$2.00
Litharge	25.95	26.60	26.90
Dry Red Lead	27.20	27.85	28.15
Red Lead in Oil	30.65	31.30	31.60
Found cans, \$37 per lb.			

## PATENT CHIMNEYS—

6-inch	\$2.50 lineal foot
8-inch	\$3.00 lineal foot
10-inch	4.00 lineal foot
12-inch	5.00 lineal foot

## PLASTER—

Neat wall, per ton delivered in S. F. in paper bags, \$17.60.

## PLASTERING (Interior)—

3 Coats, metal lath and plaster	Yard	\$3.00
Keene cement on metal lath		3.50
Ceilings with ¾ hot roll channels metal lath (lathed only)		3.00
Seilings with ¾ hot roll channels metal lath plastered		4.50
Single partition ¾ channel lath 1 side (lath only)		3.00
Single partition ¾ channel lath 2 inches thick plastered		8.00
4-inch double partition ¾ channel lath 2 sides (lath only)		5.75
4-inch double partition ¾ channel lath 2 sides plastered		8.75
Thermax single partition; 1" channels; 2¼" overall partition width. Plastered both sides		7.50
Thermax double partition; 1" channels; 4¾" overall partition width. Plastered both sides		11.00
3 Coats over 1" Thermax nailed to one side wood studs or joists		4.50
3 Coats over 1" Thermax suspended to one side wood studs with spring sound insulation clip		5.00
Note—Channel lath controlled by limitation orders.		

## PLASTERING (Exterior)—

2 coats cement finish, brick or concrete	Yard	\$2.50
3 coats cement finish, No. 18 gauge wire mesh		3.50
Line—\$4.00 per bbl. at yard.		
Processed LLlime—\$4.15 per bbl. at yard.		
Rock or Grip Lath—¾"–30¢ per sq. yd.		
		¾"–29¢ per sq. yd.
Composition Stucco—\$4.00 sq. yard (applied).		

## PLUMBING—

From \$200.00 per fixture up, according to grade, quality and runs.

## ROOFING—

"Standard" tar and gravel, 4 ply—\$11.00 per sq. for 30 sq. or over.	
Less than 30 sqs, \$14.00 per sq.	
Tile \$40.00 to \$50.00 per square.	
No. 1 Redwood Shingles in place, 4½ in. exposure, per square	\$18.25
5/2 No. 1 Cedar Shingles, 5 in. exposure, per square	14.50
5/8 x 16"—No. 1 Little Giant Cedar Shingles, 5" exposure, per square.	18.25

4/2 No. 1-24" Royal Cedar Shingles	23.00
7½" exposure, per square	
Re-coat with Gravel \$5.50 per sq.	
Asbestos Shingles, \$27 to \$35 per sq. laid.	
½ to ¾ x 25" Resawn Cedar Shakes,	
10" Exposure	\$30.00
¾ to 1½ x 25" Resawn Cedar Shakes,	
10" Exposure	\$35.00
1 x 25" Resawn Cedar Shakes,	
10" Exposure	27.00

Above prices are for shakes in place

## SEWER PIPE—

C.I., 6-in. to 24-in. B. & S. Class B and heavier, per ton	\$99.50
Vitrified, per foot: L.C.L. F.O.B. Warehouse, San Francisco,	
Standard, 8-in.	.66
Standard, 12-in.	1.30
Standard, 24-in.	5.41
Clay Drain Pipe, per 1,000 L.F.	
L.C.L. F.O.B. Warehouse, San Francisco:	
Standard, 6-in. per M.	\$240.00
Standard, 8-in. per M.	400.00

## SHEET METAL—

Windows—Metal, \$2.50 a sq. ft. Fire doors (average), including hardware \$2.80 per sq. ft., size 12'x12'. \$3.75 per sq. ft., size 3'x6'.

## SKYLIGHTS—(not glazed)

Copper, \$1.25 sq. ft. (flat).	
Galvanized iron, 65c sq. ft. (flat).	
Vented high skylight, \$1.50 sq. ft.	

## STEEL—STRUCTURAL—

\$220 per ton erected, when out of mill. \$270 per ton erected, when out of stock.

## STEEL REINFORCING—

\$200.00 per ton, in place.	
¼-in. Rd. (Less than 1 ton)	\$8.40
⅜-in. Rd. (Less than 1 ton)	7.30
½-in. Rd. (Less than 1 ton)	7.00
⅝-in. Rd. (Less than 1 ton)	6.75
¾-in. & 7/8-in. Rd. (Less than 1 ton).	6.65
1-in & up (Less than 1 ton)	6.60
1 ton to 5 tons, deduct 25c.	

## STORE FRONTS (None available).

## TILE—

Ceramic Tile Floors—Commercial \$1.20 to \$1.60 per sq. ft.	
Cove Base—\$1.40 per lin. ft.	
Quarry Tile Floors, 6½" with 6" base @ \$1.35 per sq. ft.	
Tile Wainscots & Floors, Residential, 4¼x4¼", @ \$1.65 to \$2.00 per sq. ft.	
Tile Wainscots, Commercial Jobs, 4¼x4¼" Tile, @ \$1.50 to \$1.65 per sq. ft.	
Asphalt Tile Floor 16" x 16" x ½" \$ .18 - \$ .35 sq. yd.	
Light shades slightly higher.	
Cork Tile—\$ .70 per sq. ft.	
Mosaic Floors—See dealers.	
Lino-Tile—\$1.00 per sq. ft.	
Rubber Tile—\$ .55 to \$ .75 per sq. ft.	
Building Tile—	
8½x12-inches, per M.	\$139.50
6½x12-inches, per M.	105.00
4½x12-inches, per M.	84.00
Hollow Tile—	
12x12-inches, per M	\$146.75
12x12-inches, per M	156.85
12x12-inches, per M	177.10
12x12-inches, per M	235.30
F.O.B., Plant	

## VENETIAN BLINDS—

75c per square foot and up. Installation extra.

## WINDOWS—STEEL—INDUSTRIAL

Cost depends on design and quality required.

# ARCHITECT AND ENGINEER

# ESTIMATOR'S DIRECTORY

## Building And Construction Materials

EXPLANATION—Building and construction materials are shown in major classified groups for general identification purposes with names and addresses of suppliers of materials listed in detail under group classification where name first appears—main offices are shown first, with branch or district offices following. The numeral appearing in listings refers to the major group classification where complete data on the dealer, or representative, may be found.

### ARCHITECTURAL VENEER (a)

Ceramic Veneer  
**PACIFIC CLAY PRODUCTS**  
 San Francisco: 605 Market St., GA 1-3970  
 Los Angeles, Portland, Salt Lake City  
 GLADDING, McBEAN & CO. \*(1)  
 Porcelain Veneer  
**PORCELAIN ENAMEL PUBLICITY BUREAU**  
 [Dept. AE-450]  
 Room 601, Franklin Building, Oakland 12, California  
 P. O. Box 186, East Pasadena Station, Pasadena 8, California  
 Granite Veneer  
**VERMONT MARBLE COMPANY**  
 San Francisco 5: 525 Market Street, SU 1-6747  
 Los Angeles 4: DU 2-7834  
 Marble Veneer  
**VERMONT MARBLE COMPANY**  
 San Francisco 5: 525 Market Street, SU 1-6747  
 Los Angeles 4: DU 2-7834

### BRASS PRODUCTS (1a)

**GREENBERG'S, M. & SONS**  
 San Francisco, Calif.: 765 Folsom, EXbrook 2-3143

### BRICKWORK (1)

Face Brick  
**GLADDING, McBEAN & CO.**  
 San Francisco: Harrison at 9th Sts., UN 1-7400  
 Los Angeles: 2901 Los Feliz Blvd., OL 2121  
 Offices at Portland, Seattle, Spokane  
**KRAFTILE**  
 Niles, California, Niles 3611  
 San Francisco 5: 50 Hawthorne St., DO 2-3780  
 Los Angeles 13: 406 South Main St., MU 7241  
**REMILLARD-DANDINI CO.**  
 San Francisco: 400 Montgomery St., EX 2-4988

### BRONZE PRODUCTS (1b)

**GREENBERG'S M. & SONS**  
 San Francisco, Calif.: 765 Folsom, EXbrook 2-3143

### BUILDING PAPER & FELTS (2)

**SISALKRAFT COMPANY**  
 San Francisco: 55 New Montgomery St., EX 2-3066  
 Chicago, Ill.: 205 West Wacker Drive  
**ANGIER PACIFIC CORP.**  
 San Francisco 5: 55 New Montgomery St., DO 2-4416  
 Los Angeles: 7424 Sunset Boulevard

### BUILDING HARDWARE (3)

**THE STANLEY WORKS**  
 San Francisco: Monadnock Bldg., YU 6-5914  
 New Britain, Conn.

### CEMENT (c)

**PACIFIC PORTLAND CEMENT**  
 San Francisco: 417 Montgomery St., GA 1-4100

### CONCRETE AGGREGATES (4)

Lightweight Aggregates  
**AMERICAN PERLITE CORP.**  
 Richmond, Calif.: 26th & B Sts.—Yard 2, RI 4307

### FIRE ESCAPES (5)

**SOULE STEEL**  
 San Francisco: 1750 Army St., VA 4-4141  
 Los Angeles, Calif.—LA 0911  
 Portland, Ore.—BE 5155  
 Seattle, Wash.—SE 3010

### MICHAEL & PFEFFER IRON WORKS, INC. Shingles

San Francisco 3: Tenth & Harrison Sts., MA 1-5966  
**SIDEWALL LUMBER COMPANY**  
 San Francisco 24: 1995 Oakdale Ave., AT 2-8112

### FLOORS (6)

Hardwood Flooring  
**HOGAN LUMBER COMPANY**  
 Oakland: Second and Alice Sts., GL 1-6861  
**E. K. WOOD LUMBER CO.**  
 Los Angeles: 4710 S. Alameda St., JE 3111  
 Oakland: 727 Kennedy St., KE 4-8466  
 Portland: 827 Terminal Sales Building

### GLASS (7)

**W. P. FULLER COMPANY**  
 San Francisco: 301 Mission St., EX 2-7151  
 Los Angeles, Calif.  
 Portland, Oregon

### HEATING (8)

**HENDERSON FURNACE & MFG. CO.**  
 Sebastopol, Calif.  
**S. T. JOHNSON CO.**  
 Oakland 8: 940 Arlington Ave., OL 2-6000  
 San Francisco: 585 Potrero Ave., MA 1-2757  
 Philadelphia 8, Pa.: 401 No. Broad St.  
**SCOTT COMPANY**  
 San Francisco: 243 Minna St., YU 2-0400  
 Oakland: 113 - 10th St., GL 1-1937  
 San Jose, Calif.  
 Los Angeles, Calif.  
**THOMAS B. HUNTER (Designer)**  
 San Francisco: 41 Sutter St., GA 1-1164

### INSULATION AND WALLBOARD (9)

**LUMBER MANUFACTURING CO.**  
 San Francisco: 225 Industrial Ave., JU 7-1760  
**SISALKRAFT COMPANY \*(2)**  
**WESTERN ASBESTOS COMPANY**  
 San Francisco: 675 Townsend St., KL 2-3868  
 Oakland: 251 Fifth Avenue, GL 1-2345  
 Sacramento: 1224 J Street, 2-8993  
 Stockton: 1120 E. Weber Ave., 4-1863  
 Fresno: 1837 Merced Street, 3-3277  
 San Jose: 201 So. Market St., BA 4359-J

### IRON—Ornamental (10)

**MICHEL & PFEFFER IRON WORKS, INC. \***  
 (5)

### LIGHTING FIXTURES (11)

**SMOOT-HOLMAN COMPANY**  
 Inglewood, Calif., OR 8-1217  
 San Francisco: 55 Mississippi St., MA 1-8474

### LUMBER (12)

**HOGAN LUMBER COMPANY \*(6)**  
**LUMBER MANUFACTURING CO. \*(9)**  
**E. K. WOOD LUMBER CO \*(6)**

### MARBLE (13)

**VERMONT MARBLE COMPANY**  
 San Francisco: 525 Market St., SU 1-6747  
 Los Angeles 4: 3522 Council St., DU 2-7834

### METAL LATH EXPANDED (14)

**FORDERER CORNICE WORKS**  
 San Francisco: 269 Potrero Ave., HE 1-4100  
**SOULE STEEL \*(5)**

### MILLWORK (15)

**PACIFIC MANUFACTURING COMPANY**  
 San Francisco: 16 Beale St., GA 1-7755  
 Santa Clara: 2610 The Alameda, SC 607  
 Los Angeles: 6820 McKinley Ave., TH 4196  
**MULLEN MANUFACTURING COMPANY**  
 San Francisco: 60-80 Rausch St., UN 1-5815  
**LUMBER MANUFACTURING COMPANY \*(9)**

### PAINTING (16)

Paint  
**W. P. FULLER COMPANY \*(7)**

### PLASTER (17)

Exteriors  
**PACIFIC PORTLAND CEMENT COMPANY \*(4)**  
 Interiors—Metal Lath & Trim  
**FORDERER CORNICE WORKS \*(14)**

### PLASTIC CEMENT (f)

**PACIFIC PORTLAND CEMENT CO.**  
 San Francisco: 417 Montgomery St., GA 1-4100

### PLUMBING (18)

**THE SCOTT COMPANY \*(8)**  
**THE HALSEY TAYLOR COMPANY**  
 Redlands, Calif.  
 Warren, Ohio  
**HAWS DRINKING FAUCET COMPANY**  
 Berkeley 10: 1435 Fourth St., LA 5-3341  
**CONTINENTAL WATER HEATER COMPANY**  
 Los Angeles 31: 1801 Pasadena Ave., CA 6178  
**SIMONDS MACHINERY COMPANY**  
 San Francisco: 816 Folsom St., DO 2-6794  
 Los Angeles: 455 East 4th St., MU 8322  
**SECURITY VALVE COMPANY**  
 Los Angeles 31: 410 San Fernando Rd., CA 6191

### SEWER PIPE (19)

**GLADDING, McBEAN & CO. \*(1)**



PACIFIC CLAY PRODUCTS  
San Francisco: 605 Market St., GA 1-3970  
Los Angeles, Portland, Salt Lake City

SAN JOSE STEEL COMPANY  
San Jose: 195 North Thirtieth St., CO 4184

MICHEL & PFEFFER IRON WORKS, INC. \* (1)  
SOULE STEEL COMPANY \* (5)

**SHEET METAL (20)**

Windows  
DETROIT STEEL PRODUCTS COMPANY  
Oakland 8: 1310 - 63rd St., OL 2-8826  
San Francisco: Russ Building, DO 2-0890  
MICHEL & PFEFFER IRON WORKS, INC. \* (5)  
SOULE STEEL COMPANY \* (5)

Fire Doors  
DETROIT STEEL PRODUCTS COMPANY  
Skylights  
DETROIT STEEL PRODUCTS COMPANY

**STEEL—STRUCTURAL (21)**

COLUMBIA STEEL CO.  
San Francisco: Russ Bldg., SU 1-2500  
Los Angeles: 2087 E. Slauson, LA 1171  
Portland: 2345 N. W. Nicolai, BE 7261  
Seattle: 1331 3rd Ave. Bldg., MA 1972  
Salt Lake City: Walker Bank Bldg., SL 3-6733  
HERRICK IRON WORKS  
Oakland: 18th & Campbell Sts., GL 1-1747  
JUDSON PACIFIC-MURPHY CORP.  
Emeryville: 4300 Eastshore Highway, OL 3-1717  
REPUBLIC STEEL CORP.  
San Francisco: 116 N. Montgomery St., GA 1-0977  
Los Angeles: Edison Building  
Seattle: White-Henry-Stuart Building  
Salt Lake City: Walker Bank Building  
Denver: Continental Oil Building  
KRAFTLIE COMPANY \* (1)

**STEEL—REINFORCING (22)**  
REPUBLIC STEEL CORP. \* (21)  
HERRICK IRON WORKS \* (21)  
SAN JOSE STEEL CO. \* (21)  
COLUMBIA STEEL CO. \* (21)

**TILE (23)**

GLADDING, McBEAN & CO. \* (11)  
KRAFTLIE COMPANY \* (1)  
PACIFIC CLAY PRODUCTS  
San Francisco: 605 Market St., GA 1-3970  
Los Angeles, Portland, Salt Lake City

**TIMBER—REINFORCING (b)**

Trusses  
WEYERHAEUSER SALES CO.  
Tacoma, Wash.  
St. Paul, Minn.  
Newark, N. J.  
Treated Timber  
J. H. BAXTER CO.  
San Francisco 4: 333 Montgomery St., DO 2-3883  
Los Angeles 13: 601 West Fifth St., MI 6294

**WALL TILE (24)**

GLADDING, McBEAN & CO. \* (1)  
KRAFTLIE COMPANY \* (1)

**WINDOWS STEEL (25)**

DETROIT STEEL PRODUCTS CO. \* (20)

**GENERAL CONTRACTORS (26)**  
DINWIDDIE CONSTRUCTION COMPANY  
San Francisco: Crocker Building, YU 6-2718  
CLINTON CONSTRUCTION COMPANY  
San Francisco: 923 Folsom St., SU 1-3440  
MATCOX CONSTRUCTION COMPANY  
San Francisco: 604 Mission St., GA 1-5516  
PARKER, STEFFENS & PEARCE  
San Francisco: 135 So. Park, EX 2-4639  
STOLTE, INC.  
Oakland: 8451 San Leandro Blvd., TR 2-1064  
SWINERTON & WALBERG COMPANY  
San Francisco: 225 Bush St., GA 1-2980  
Oakland: 1723 Webster St., HI 4-4322  
Los Angeles, Sacramento, Denver  
P. J. WALKER COMPANY  
San Francisco: 391 Sutter St., YU 6-5916  
Los Angeles: 3920 Whiteside St., AN 9-8567

**TESTING LABORATORIES**

(ENGINEERS & CHEMISTS) (27)  
ABOT A. HANKS, INC.  
San Francisco: 624 Sacramento St., GA 1-169  
ROBERT W. HUNT COMPANY  
San Francisco: 251 Kearny St., EX 2-4634  
Los Angeles: 3050 E. Slauson, JE 9131  
Chicago, New York, Pittsburgh  
PITTSBURGH TESTING LABORATORY  
San Francisco: 651 Howard St., EX 2-1747

**BUILDING TRADES WAGE (JOB SITES) NORTHERN, CENTRAL AND SOUTHERN CALIFORNIA**

ATTENTION: The following are the PREVAILING hourly rates of compensation being paid and in effect by employers by agreement between employees and their union; or as recognized and determined by the U. S. Department of Labor. [Revised to Sept. 1, 1949.]

CRAFT	Centre										Los Angeles					San Bernardino					San Francisco				
	San Francisco	Alameda	Costa	Fresno	Sacramento	Clare	Solano	Stockton	Los Angeles	San Bernardino	San Bernardino	San Bernardino	San Bernardino	San Bernardino	San Bernardino	San Bernardino	San Bernardino	San Bernardino	San Bernardino	San Bernardino					
ASBESTOS WORKERS	\$2.16	\$2.16	\$2.16	\$2.16	\$2.16	\$2.16	\$2.16	\$2.16	\$2.25	\$2.25	\$2.25	\$2.25	\$2.25	\$2.25	\$2.25	\$2.25	\$2.25	\$2.25	\$2.25	\$2.25					
BRICKLAYERS	3.00*	3.00	3.00	3.00	3.00	3.00	3.00	3.00	2.95*	2.95	2.95	2.95	2.95	2.95	2.95	2.95	2.95	2.95	2.95	2.95					
BRICKLAYERS, HODCARRIERS	2.75	2.75	2.75	2.75	2.75	2.75	2.75	2.75	2.70*	2.70	2.70	2.70	2.70	2.70	2.70	2.70	2.70	2.70	2.70	2.70					
CARPENTERS	2.16	2.16	2.175	2.175	2.175	2.175	2.175	2.175	2.15*	2.15	2.15	2.15	2.15	2.15	2.15	2.15	2.15	2.15	2.15	2.15					
CEMENT FINISHERS	2.20	2.20	2.20	2.20	2.20	2.20	2.20	2.20	2.20	2.20	2.20	2.20	2.20	2.20	2.20	2.20	2.20	2.20	2.20	2.20					
ELECTRICIANS	2.50	2.50	2.50	2.50	2.50	2.50	2.50	2.50	2.50	2.50	2.50	2.50	2.50	2.50	2.50	2.50	2.50	2.50	2.50	2.50					
ELEVATOR CONSTRUCTORS	2.45	2.45	2.45	2.45	2.45	2.45	2.45	2.45	2.45	2.45	2.45	2.45	2.45	2.45	2.45	2.45	2.45	2.45	2.45	2.45					
ENGINEERS: MATERIAL HOIST	2.19	2.19	2.19	2.19	2.19	2.19	2.19	2.19	2.19	2.19	2.19	2.19	2.19	2.19	2.19	2.19	2.19	2.19	2.19	2.19					
FILE DRIVER	1.44	1.44	1.44	1.44	1.44	1.44	1.44	1.44	1.44	1.44	1.44	1.44	1.44	1.44	1.44	1.44	1.44	1.44	1.44	1.44					
STRUCTURAL STEEL	2.46	2.46	2.46	2.46	2.46	2.46	2.46	2.46	2.46	2.46	2.46	2.46	2.46	2.46	2.46	2.46	2.46	2.46	2.46	2.46					
GLAZIERS	2.00	2.00	2.00	2.00	2.00	2.00	2.00	2.00	2.00	2.00	2.00	2.00	2.00	2.00	2.00	2.00	2.00	2.00	2.00	2.00					
IRONWORKERS: ORNAMENTAL	2.35	2.35	2.35	2.35	2.35	2.35	2.35	2.35	2.35	2.35	2.35	2.35	2.35	2.35	2.35	2.35	2.35	2.35	2.35	2.35					
REINF. RODMEN	2.25	2.25	2.25	2.25	2.25	2.25	2.25	2.25	2.25	2.25	2.25	2.25	2.25	2.25	2.25	2.25	2.25	2.25	2.25	2.25					
STRUCTURAL	2.50	2.50	2.50	2.50	2.50	2.50	2.50	2.50	2.50	2.50	2.50	2.50	2.50	2.50	2.50	2.50	2.50	2.50	2.50	2.50					
LABORERS: BUILDING	1.55	1.55	1.55	1.45	1.55	1.45	1.55	1.45	1.55	1.45	1.55	1.45	1.55	1.45	1.55	1.45	1.55	1.45	1.55	1.45					
CONCRETE	1.55	1.55	1.55	1.45	1.55	1.45	1.55	1.45	1.55	1.45	1.55	1.45	1.55	1.45	1.55	1.45	1.55	1.45	1.55	1.45					
LATHERS	2.8125	2.8125	2.8125	2.8125	2.8125	2.8125	2.8125	2.8125	2.8125	2.8125	2.8125	2.8125	2.8125	2.8125	2.8125	2.8125	2.8125	2.8125	2.8125	2.8125					
MARBLE SETTERS	2.375	2.375	2.375	2.375	2.375	2.375	2.375	2.375	2.375	2.375	2.375	2.375	2.375	2.375	2.375	2.375	2.375	2.375	2.375	2.375					
MOZAIC & TERRAZZO	2.00	2.00	2.00	2.00	2.00	2.00	2.00	2.00	2.00	2.00	2.00	2.00	2.00	2.00	2.00	2.00	2.00	2.00	2.00	2.00					
PAINTERS	2.15**	2.15**	2.15**	2.15**	2.15**	2.15**	2.15**	2.15**	2.15**	2.15**	2.15**	2.15**	2.15**	2.15**	2.15**	2.15**	2.15**	2.15**	2.15**	2.15**					
PILEDRIERS	2.25	2.25	2.25	2.25	2.25	2.25	2.25	2.25	2.25	2.25	2.25	2.25	2.25	2.25	2.25	2.25	2.25	2.25	2.25	2.25					
PLASTERERS	2.6125	2.50*	2.50*	2.25*	2.25*	2.50*	2.50*	2.50*	2.50*	2.50*	2.50*	2.50*	2.50*	2.50*	2.50*	2.50*	2.50*	2.50*	2.50*	2.50*					
PLASTERERS, HODCARRIERS	2.50	2.25*	2.25*	1.775*	2.00*	2.00*	2.00*	2.00*	2.25*	2.16	2.13	2.13	2.13	2.13	2.13	2.13	2.13	2.13	2.13	2.13					
PLUMBERS	2.50	2.50	2.50	2.50	2.50	2.50	2.50	2.50	2.50	2.50	2.50	2.50	2.50	2.50	2.50	2.50	2.50	2.50	2.50	2.50					
ROOFERS	2.25	2.25	2.25	1.875	2.00	2.00	2.16	2.25	2.25	2.00	2.16	2.25	2.25	2.00	2.16	2.25	2.25	2.00	2.16	2.25					
SHEET METAL WORKERS	2.25	2.25	2.25	2.125	2.30	2.40	2.125	2.125	2.125	2.125	2.125	2.125	2.125	2.125	2.125	2.125	2.125	2.125	2.125	2.125					
SPRINKLER FITTERS	2.50	2.50	2.50	2.50	2.50	2.50	2.50	2.50	2.50	2.50	2.50	2.50	2.50	2.50	2.50	2.50	2.50	2.50	2.50	2.50					
STEAM FITTERS	2.50	2.50	2.50	2.50	2.50	2.50	2.50	2.50	2.50	2.50	2.50	2.50	2.50	2.50	2.50	2.50	2.50	2.50	2.50	2.50					
STONESETTERS (MASON'S)	3.00	2.8125	2.8125	2.25*	2.8125	2.8125	2.8125	2.8125	2.8125	2.8125	2.8125	2.8125	2.8125	2.8125	2.8125	2.8125	2.8125	2.8125	2.8125	2.8125					
TILESETTERS	2.675	2.675	2.675	2.15	2.00	2.675	2.675	2.675	2.675	2.675	2.675	2.675	2.675	2.675	2.675	2.675	2.675	2.675	2.675	2.675					

\* 6 Hour Day. \*\* 7 Hour Day.

Prepared and compiled by:

CENTRAL CALIFORNIA CHAPTER, ASSOCIATED GENERAL CONTRACTORS OF AMERICA, with the assistance and cooperation of secretaries of General Contractors Associations and Builders Exchanges of Northern California; and the above information for southern California is furnished by the Labor Relations Department of the Southern California Chapter, ASSOCIATED GENERAL CONTRACTORS OF AMERICA.

**CLASSIFIED ADVERTISING**

RATE: 20c PER WORD ... CASH WITH ORDER

MINIMUM \$5.00

**PLANNING CHURCH BUILDINGS.** Portfolio — 64 oversized pages 144 cuts; floor plans, exterior and interior views; recently planned buildings costing \$30,000 upward. Largest collection of plans of Protestant churches assembled. Price \$2.00 p.p. WRITE Bureau of Architecture, 300 Fourth Ave., New York 10, N. Y.

GET THE BEST, don't be satisfied with anything but the best. Window sash, Doors, Cabinets, etc. Town Talk Sash & Door Mill, 524 9th St., Sacramento.

**BUILDERS!** You can make more money; get information you need before it is published elsewhere; Subscribe to the daily ARCHITECTS REPORTS, only \$10.00 per month. Complete information from ARCHITECTS REPORTS, 68 Post Street, San Francisco. Phone Douglas 2-8311.

**PHOTOGRAPHY.** For the best in construction photography, including exterior and interior, aerial, and progress views . . . you will find as many others have that it's the SKELTON STUDIOS, 137 Harlan Place, San Francisco. Telephone YUkon 6-6321.

**ADVERTISERS** wishing to sell building materials and products, GET THE BEST RESULTS from regular advertising schedules in ARCHITECT & ENGINEER magazine. Write for complete information, including rates, circulation, etc., 68 Post Street, San Francisco.

**FLOOR COVERINGS** for industrial, commercial, and residential construction. Complete lines, one of the oldest, best established organizations in the Sacramento Valley. LATTIN'S, INC., 1519 Alhambra Blvd., Sacramento.

## FLOOR MAINTENANCE

(From Page 27)

In conjunction with Hillyard's merchandising plans, the color of the new trucks is white over-all, with a distinctive blue checkboard trim. The trademarked slogan "Handle with Hillyard Care" is prominently displayed in blue and orange on the doors at side and rear. On the body of the truck, in the same color combination, is the trademarked design of Super Shine-All Cleaner.

### Each Hillyard truck constitutes a complete Floor Clinic

In a compact, convenient, easily accessible space, this Chevrolet truck carries needed samples and supplies direct to the user.

It carries a Hillyard Maintainer in attendance, who is expertly trained in all phases of modern floor care. The Maintainer, with full equipment, can drive right up to a customer's doorstep . . . take a look at problem floors, listen to troubles about "wear-out," "traffic-dirt" and "slipping hazards." Then graphically show customers how to remedy the trouble with cost-saving Hillyard products.

The Hillyard expert doesn't have to show an inch-sized sample from his brief case. With products from his truck, he can actually demonstrate on a customer's own floor how Super Shine-All, for instance, safely and thoroughly cleans linoleum, wood, cement, asphalt tile, terrazzo, or rubber tile without rinsing; how Kurl-Off, Hillyard's new paint-varnish remover eliminates expensive sanding; or how the electric Hiltonian does a 3-purpose job of scrubbing, waxing and polishing.

Hillyard Chemical Company is planning with its sales representatives in other states for more "Floor Clinics on Wheels"—to bring better maintenance to other states this coming year.

## GOVERNMENT ORDERS TRANSMISSION

(From Page 27)

1. To the California power pool—an average of 440 million kilowatt-hours annually, 120,000 kilowatt available for defense or savings on fuel, and a saving of 730,000 barrels of oil if the energy is used in lieu of additional steam plant energy for defense.

2. To the Northwest power pool—200 million to 400 million kilowatt-hours for a six-months low-water period, 130,000 kilowatt capacity available throughout the year, and 100,000 kilowatt increase in firm power capacity for defense loads.

In addition to its defense benefits, the interconnection would bring an estimated annual net revenue of \$965,000 to the federal treasury, against a total cost of \$6,269,000. Engineers state that the project could be completed in two years. Surveys of the route already are underway.

## FORDERER CORNICE WORKS

Manufacturers of

Hollow Metal Products • Interior Metal Trim  
Elevator Fronts and Cabs  
Metal Plaster Accessories • Sanitary Metal Base  
Flat and Roll Metal Screens  
Metal Cabinets • Commercial Refrigerators

269 POTRERO AVE.

SAN FRANCISCO, CALIF.

HEMLOCK 1-4100

## Parker, Steffens & Pearce

BUILDERS

135 South Park, San Francisco

Phone: EXbrook 2-6639

## VALUABLE NEWS SERVICE

- BUILDING MATERIAL DEALERS
- CONTRACTORS
- ENGINEERS
- FINANCIAL INSTITUTIONS

**ARCHITECTS REPORTS** gives advance news on construction projects in Northern California, lists: name of projects, location, architect, proposed cost and other pertinent information.

**HANDY** individual slip-reports, issued daily at a total cost of only

\$10 a month

## ARCHITECT'S REPORTS

Published Daily

The ARCHITECT and ENGINEER, Inc.

68 Post Street, San Francisco - DO 8311

## CONSTRUCTION CONTRACTS AWARDED AND MISCELLANEOUS PERSONNEL DATA

**HOME ECONOMICS BUILDING**, Davis, Yolo County, University of California, owner. \$840,312. ARCHITECT: Hervey P. Clark & John F. Beutler, San Francisco. STRUCTURAL ENGINEER: H. J. Brunner, San Francisco. MECHANICAL ENGINEER: Geo. R. Keller & Phillip E. Gannon, San Francisco. 2 story, L-shaped, reinforced concrete construction with attached auditorium, offices, classrooms and laboratories, approximately 45,000 sq. ft. GENERAL CONTRACTOR: Erbenhaut & Summers, San Francisco.

**STUDENTS HEALTH CENTER BUILDING**, Davis, Yolo County, University of California, owner. \$623,700. ARCHITECT: John Funk, San Francisco. STRUCTURAL ENGINEER: I. Thompson, San Francisco. MECHANICAL ENGINEER: Geo. Brokaw, San Francisco. 1 story, approximately 25,000 sq. ft., reinforced concrete construction, reinforced brick walls, aluminum sash, linoleum floors, acoustical tile ceilings, air conditioning, nurses' home, 1500 sq. ft., frame and stucco construction. GENERAL CONTRACTOR: B & B Construction Co., San Francisco.

**OLYMPIC CLUB REMODEL**, San Francisco, Olympic Club, owner. \$385,000. ARCHITECT: Milton Pfueger, San Francisco. Interior and exterior remodel. GENERAL CONTRACTOR: Swinerton & Walberg, San Francisco.

**PAROCHIAL SCHOOL AND CONVENT, ST. GREGORY'S PARISH**, San Mateo, San Mateo County, Roman Catholic Archbishop of S. F., owner. 8 classrooms, administration and toilet rooms. \$223,990. ARCHITECT: Vincent G. Raney, San Francisco. Frame and stucco construction. GENERAL CONTRACTOR: Moore & Roberts, San Francisco.

**DEL PASO MANOR GRAMMAR SCHOOL**, Sacramento, Sacramento County, Aracade Elementary School District, owner. 200 classrooms, kindergarten, administration, multi-purpose room and toilet room, \$546,749. ARCHITECT: Gordon Stafford, Sacramento. Frame and stucco construction. GENERAL CONTRACTOR: Lawrence Construction Co., Sacramento.

**COUNTY OFFICE BUILDING**, Centerville, Alameda County, County of Alameda, owner. \$169,646. ARCHITECT: Edward D. Cerruti, Oakland. Will contain courtroom, sheriff's office, sub-station, 2 jail cells, kitchen and library. 1 story frame and stucco construction, 15,000 sq. ft. GEN-

ERAL CONTRACTOR: N. T. Lewis, Hayward.

**GRAMMAR SCHOOL ADDITION**, Del Rey, Fresno County, Del Rey Union Elementary School District, owner. \$94,200. ARCHITECT: Wm. Hastrup, Fresno. Frame and stucco construction. GENERAL CONTRACTOR: Contracts Awarded for January Issue.

**MIRA LOMA ELEMENTARY SCHOOL**, San Francisco, City and County of S. F., owner. 15 classrooms, kindergarten, administration, library, cafeteria, gymnasium and toilet room, \$1,037,836. ARCHITECT: Masten & Hurd, San Francisco. 2 story, reinforced concrete and structural steel construction. GENERAL CONTRACTOR: Manson Bros., San Francisco.

**MACHINE SHOP ADDITION**, San Francisco, Bippis Machine & Tool Works, owner. \$21,700. ENGINEER: H. L. Marchand & A. M. Nishkian, San Francisco. 1 story, 48x90, reinforced concrete construction wood roof. GENERAL CONTRACTOR: G. F. W. Jensen & Son, San Francisco.

**GYMNASIUM BUILDING**, Sallinas, Monterey County, Diocese of Monterey-Fresno, owner. Sacred Heart Parish, \$148,823. STRUCTURAL ENGINEER: Laurence D. Viole, North Hollywood. 7th-up construction, 19,000 sq. ft., laminated arches, hardwood and concrete floors, steel sash, rest rooms, fixed wood and concrete bleachers. GENERAL CONTRACTOR: Vern R. Huck, Sallinas.

**GYMNASIUM BUILDING**, Bakersfield, Kern County, Roman Catholic Diocese of Monterey-Fresno, owner. Garces High School, \$159,149. STRUCTURAL ENGINEER: Laurence D. Viole, North Hollywood. 1 story, 115 x 158, granite construction, wood roof

**SOCIAL WELFARE BUILDING**, Modesto, Stanislaus County, County of Stanislaus, owner. \$112,900. ARCHITECT: Russell G. Delappe, Berkeley. 2 story, concrete block and frame construction. GENERAL CONTRACTOR: Stolle, Inc., Monterey.

**SHOPPING CENTER ADDITION**, Sacramento, Sacramento County, Jacinto Development Co., owner. Drugstore, ice cream, hardware, variety and liquor store, \$40,000. ARCHITECT: Albert W. Kohl, San Mateo. Frame and stucco construction.

**SOCIAL HALL**, Sacramento, Sacramento County, Greek Orthodox Church, owner. \$40,000. ARCHITECT: C. C. Cull, Sacramento. 1 story, 54x105, frame and stucco construction. GENERAL CONTRACTOR: Erickson Construction Co., North Sacramento.

**OFFICE AND TELEVISION BROADCASTING BUILDING**, San Francisco, Land Development Co., owner. \$200,000. ARCHITECT: J. Lloyd Conrich, San Francisco. 3 story, reinforced concrete and frame construction. GENERAL CONTRACTOR: Mills Construction Co., San Francisco.

**NEW GRAMMAR SCHOOL**, Yuba City, Sutter County, Yuba City Elementary School District, owner. 16 classrooms, offices and toilet room, \$268,674. ARCHITECT: Chas. F. Dean, Sacramento. Frame and stucco construction. GENERAL CONTRACTOR: Wm. S. Shedd, Yuba City.

**NEW HIGH SCHOOL BUILDING**, Arvin, Kern County, Kern County Union High School District, owner. 15 classrooms, administration, toilet rooms, \$269,196. ARCHITECT: Ernest L. McCoy, Bakersfield. 14,250

sq. ft., brick construction, concrete floors, asphalt tile, steel sash, steel roof trusses. GENERAL CONTRACTOR: Guy E. Holl, Bakersfield.

**OFFICE BUILDING**, Menlo Park, San Mateo County, Sunset Magazine, owner. \$250,000. ARCHITECT: Higgins & Root, San Jose. 1 story, reinforced concrete, frame and stucco construction. Shake roof, steel sash, 32,000 sq. ft. GENERAL CONTRACTOR: Howard J. White, Inc., Palo Alto.

**TECHNICAL HIGH SCHOOL BUILDINGS**, San Jose, Santa Clara County, San Jose Board of Education, owner. \$1,386,029. ARCHITECT: Kump Assoc., San Francisco. Reinforced concrete, structural steel frame, corrugated metal roof. GENERAL CONTRACTOR: O. E. Anderson, San Jose.

**HOUSING PROJECT**, Arvin, Kern County, Housing Authority of the County of Kern, owner. 50 duplex dwellings, \$352,000. ARCHITECT: Ernest L. McCoy, Bakersfield. Frame and stucco construction, insulation, asphalt tile floors, aluminum sash. GENERAL CONTRACTOR: Fred S. Macomber, Los Angeles.

**NEW GRAMMAR SCHOOL ADDITION**, San Mateo, San Mateo County, San Mateo Elementary School District, owner. 3 classrooms, kindergarten, corridor and toilet room, \$85,385. STRUCTURAL ENGINEER: Mark Falk, San Francisco. Structural steel frame, concrete block and frame and stucco construction. GENERAL CONTRACTOR: Vanne M. Brown, Palo Alto.

**NEW FORD CITY GRAMMAR SCHOOL**, Taft, Kern County, Taft Elementary School District, owner. 16 classrooms, offices, kitchens, and coterminum unit and toilet room, \$423,567. ARCHITECT: Ernest L. McCoy, Bakersfield. Frame and stucco construction, steel sash, 26,000 sq. ft. GENERAL CONTRACTOR: Ashby & Opperman, Bakersfield.

**MEDICAL SCIENCES BUILDING**, San Francisco, University of California, owner. College of dentistry, college of pharmacy and school of nursing and school of medicine, \$5,650,246. ARCHITECT: Blanchard & Moher, San Francisco. STRUCTURAL ENGINEER: Huber & Knopik, San Francisco. MECHANICAL ENGINEER: Keller & Gannon, San Francisco. 13 story, and partial 14th floor, reinforced concrete and structural steel construction, 202,560 sq. ft., floor area 180 ft. wide between clinic building and Moffitt Hospital.

**FRUITRIDGE GRAMMAR SCHOOL**, Sacramento, Sacramento County, Fruitridge Elementary School District, owner. 20 class room, administrative, multi-purpose room, kitchen and toilet rooms, \$564,000. ARCHITECT: Chas. F. Dean, Sacramento. Frame and stucco construction. GENERAL CONTRACTOR: Continental Construction Co., Sacramento.

**CENTRAL FIRE STATION**, Merced, Merced County, City of Merced, owner. \$103,565. ARCHITECT: Robt. R. Jones, Merced. Concrete block and frame construction. GENERAL CONTRACTOR: Ace Builders, Merced.

**CANNERY ADDITION REMODEL**, San Jose, Santa Clara County, Barron Gray Packing Co., San Jose, \$120,000. STRUCTURAL ENGINEER: Wm. D. Lotz, San Jose. addition and remodel, reinforced concrete construction, structural steel roof trusses, wood roof. GENERAL CONTRACTOR: Lew Jones Construction Co., San Jose.

**CLIFFORD AVE. GRAMMAR SCHOOL**, Redwood City, San Mateo County, Redwood City Elementary School District, owner. 10 classrooms, kindergarten, administration and toilet room, \$258,216. ARCHITECT: Arthur D. Janssen, Menlo Park. Concrete

## PANACALITE

The Standard for Perlite Aggregates  
An Engineered Product—Engineering  
Service

Air Classified—Sized & Graded for  
Plaster, Concrete & Stucco  
Aggregates

Listed Underwriters' Laboratories  
Re-examination Service

Fire Ratings:  
Non-Bearing Walls— 2 hours  
Floor and Beam— 4 hours  
Columns— 2 & 3 hours  
Suspended Ceiling— 4 hours  
Others

Manufactured by  
American Perlite Corporation  
26th & B Sts.—Yard 2—Richmond  
BEacon 5-1285



block and frame construction. GENERAL CONTRACTOR: Peter Sartorio, San Francisco.

**SEED PROCESSING PLANT**, Maricopa, Kern County, Maricopa Farms, Owner, \$141,000. ENGINEER: Myron C. Gould & Assoc., San Francisco, 1 story, 80x160 and 40x80 structural steel frame, corrugated steel exterior, concrete floor, 150,000 gal. steel water tank and tower. GENERAL CONTRACTOR: Forrest Frazier, Bakersfield.

**LOS GUILICOS SCHOOL FOR GIRLS**, Santa Rosa, Sonoma County, State of California, owner, \$1,000,834. ARCHITECT: Thomsen & Wilson, San Francisco. Approximately 52,000 sq. ft., reinforced concrete construction, consists of: administration building, hospital and receiving building, detention and restricted building, kitchen and service building, 2 girls' cottages and fire house building. GENERAL CONTRACTOR: Pacific Coast Builders, San Francisco.

**BAKERY BUILDING**, Sacramento, Sacramento county, John W. Galbreath & Co., owner, \$500,000. CONSULTING & SUPERVISING ARCHITECT: Leonard F. Starks, Sacramento, 1 story and basement, 80,000 sq. ft., reinforced concrete and structural steel construction. GENERAL CONTRACTOR: Lawrence Construction Co., Sacramento.

**GRAMMAR SCHOOL ADDITION**, Gustine, Merced County, Gustine Union Elementary School District, owner. Classrooms and toilet rooms, \$53,068. ARCHITECT: Robt. C. Kaestner, Visalia. Frame and stucco construction. GENERAL CONTRACTOR: Spears Construction Co., Modesto.

**DRIVE-IN BRANCH BANK BUILDING**, San Jose, Santa Clara County, First National Bank Building, owner, \$41,710. ARCHITECT: Higgins & Root, San Jose, 1 story, 2500 sq. ft., reinforced concrete and calc-stone block and frame construction. GENERAL CONTRACTOR: Geo. Bianchi, San Jose.

**FACTORY AND OFFICE BUILDING**, San Jose, Santa Clara County, Jennings Radio Mfg. Co., owner, \$50,000. ARCHITECT: Kingford Jones, Menlo Park, 1 story, 9,600 sq. ft., stucco and frame construction. GENERAL CONTRACTOR: Lew Jones Construction Co., San Jose.

**HIGH SCHOOL ADDITION**, Escalon, San Joaquin County, Escalon Union High School District, owner. Classrooms, \$112,900. ARCHITECT: Koblik & Fisher, Sacramento. Frame and stucco construction. GENERAL CONTRACTOR: Elmer H. Dolan Co., Stockton.

**POST OFFICE AND STORE BUILDING**, Kentfield, Marin County, Kentwoodlands Co., owner, \$45,000. ARCHITECT: J. S. Gould, San Francisco, 1 story, frame and stucco construction. GENERAL CONTRACTOR: Wagner & Martinez, San Francisco.

**MERCY HIGH SCHOOL**, San Francisco, Sisters of Mercy, owner. Classrooms, administration, library, cafeteria, enclosed play area, home making unit, \$750,000. ARCHITECT: Martin J. Rist, San Francisco, 4 story, reinforced concrete construction, aluminum sash, asphalt tile floors. GENERAL CONTRACTOR: Barrett & Hlip, San Francisco.

**SAUSAGE FACTORY ADDITION**, Sacramento, Sacramento County, Pureita Sausage Co., owner, \$128,851. STRUCTURAL ENGINEER: James M. Smith, San Francisco, 1 story and basement, 80x83 reinforced concrete, brick, concrete block, structural steel, wood roof cork insulation. GENERAL CONTRACTOR: Holdener Construction Co., Sacramento.

**CORONER'S OFFICE BUILDING**, Sacramento, Sacramento County, County of Sac-

ramento, owner, \$54,386. ARCHITECT: Frederick S. Harrison, Sacramento. Concrete block and frame construction. GENERAL CONTRACTOR: Guth & Schmidt, Sacramento.

**CAFETERIA BUILDING**, Hollister, San Benito County, San Benito High School and Junior College, owner, \$103,974. ARCHITECT AND ENGINEER: Falk & Booth, San Francisco. Structural steel frame and frame and stucco construction. GENERAL CONTRACTOR: E. A. Hathaway & Co., San Jose.

**NEW INTERMEDIATE SCHOOL**, Sunnyvale, Santa Clara County, Sunnyvale Elementary School District, owner, 13 classrooms, administration, auditorium, music, homemaking and art room, toilet rooms. ARCHITECT: Donald Powers Smith, San Francisco. Reinforced concrete 7 frame construction. GENERAL CONTRACTOR: Carl N. Swenson Co., San Jose.

**STORE BUILDING**, Millbrae, San Mateo County, E. Massolo, owner, 5 stores, \$52,661. ARCHITECT: Albert W. Kahl, San Mateo, 1 story, 100x100, frame and stucco construction, plate glass front. GENERAL CONTRACTOR: Wellnitz & DeNarde, San Francisco.

**RESIDENCE**, Salinas, Monterey County, Lewsi Terven, owner, 8 rooms and 3 baths, \$41,000. ARCHITECT: Chas. E. Bumer, Salinas, 1 story, frame and brick veneer, shake roof. GENERAL CONTRACTOR: V. H. Moore, Salinas.

**WEST LAKE GRAMMAR SCHOOL**, Daly City, San Mateo County, Jefferson Elementary School District, owner, \$262,497. ARCHITECT: Mario J. Campi, San Francisco. Frame and stucco construction. GENERAL CONTRACTOR: J. C. Peterson Co., San Carlos.

**SANTA VENETIA GRAMMAR SCHOOL**, San Rafael, Marin County, San Rafael Board of Education, owner, 9 classrooms, kindergarten, administration, multi purpose, \$278,377. ARCHITECT: Kirby & Mulvin, San Francisco. GENERAL CONTRACTOR: B & R Construction Co., San Francisco.

**GYMNASIUM, SHOWER AND LOCKER BUILDING**, Orosi, Tulare County, Orosi Union High School District, owner, \$208,901. ARCHITECT: Robert Kaestner, Visalia. GENERAL CONTRACTOR: Clarence Ward, Fresno.

**CHURCH**, Watsonville, Santa Cruz County, First Baptist Church, owner, \$60,000. DRAFTSMAN: John Peterson, Salinas. Frame and stucco construction. GENERAL CONTRACTOR: Don C. Crabtree, Watsonville.

## MONSON BROS.

building construction

475 Sixth Street San Francisco 3  
DOUGLAS 2-5357

## Blueprint for modern homes— Extra outlets, concealed wiring

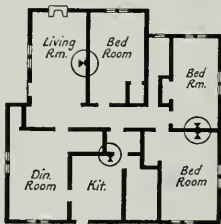

Signs of a thoughtful builder are the convenient telephone outlets included in his blueprint. Here the customer may add new extensions in the kitchen and bedrooms later on as they are needed...inexpensively. These outlets also may be used for portable telephones.

Beautiful walls won't be marred by exposed wiring if built-in conduit is planned in advance. Low-cost, concealed wiring is easy to install, means extra customer appreciation. For free help in planning, call your local Pacific Telephone office and ask for "Architects and Builders Service."

Put built-in telephone facilities in your plans

The Pacific Telephone and Telegraph Company



# IN THE NEWS

## NEW FUEL PLANT

The Aerojet Engineering Corp'n of Azusa (California) has announced plans for the construction of a new Rocket Propellant Fuel Plant near Sacramento.

The firm, a subsidiary of the General Tire and Rubber Company, will spend between \$5,000,000 and \$7,000,000 in the construction of the plant, which according to Donald R. Warren Company, Engineers, will be built on Highway 50, east of the City of Sacramento.

## ARCHITECT CHOSEN FOR GRAMMAR SCHOOL

The architectural firm of Coates & Metz of Fresno has been selected by the Fowler (California) Elementary School District to draft plans for an addition to the Marshall Grammar School in Fowler.

The addition will contain 4 classrooms, multi-purpose rooms and a kitchen. Cost is not stated.

## NEW JUVENILE HALL BUILDINGS READIED

Plans for the construction of a new \$2,236,967 Juvenile Hall Building on the Fairmont Hospital grounds in Alameda county have been completed by the Alameda County Board of Supervisors.

The project calls for a number of one and two story buildings to house boys and girls and dependent children, and certain recreational facilities.

Kent & Haas, San Francisco, are the architects.

## NAMED MANAGER

Robert W. Harrington has been named manager of the Clay Brick & Tile Association of Northern California by the Board of Directors.

Harrington has been serving as acting manager since the death of Geo. Solner, Jr., last August, and prior to that time was assistant manager in charge of the brick-mason's apprentice training program and other educational activities.

## ARCHITECT CHOSEN FOR SCHOOL JOB

Walter Wagner, Architect of Fresno, has been selected by the Fresno Board of Education to draft plans for a new Grammar School in Fresno.

The project to include 12 classrooms, 2 kindergartens, administration and all purpose facilities. Kitchen, stage and toilet rooms will cost \$335,000. The building will be of frame and stucco construction.

## BECOMES PARTNER OF CONTRACTING FIRM

Noyes H. Roach, construction engineer, has become a partner and executive vice-president in the general contracting firm of MacMen, Inc., which has been renamed MacMen, Menke & Roach, Inc.

Offices of the firm are located in Los Angeles.

## NEW AIRPORT BUILDINGS

Construction of a new \$5,000,000 Airport Administration Building at the San Francisco Municipal Airport has been approved by the San Francisco Public Utilities Commission.

The project includes a seven-story building of 241,560 sq. ft. and a 125 ft. high con-

trol tower. Facilities will be provided for ticket offices, waiting rooms, baggage rooms, restaurant, coffee shop and a cocktail lounge.

W. P. Day & Associates of San Francisco are the architects.

## ARCHITECT SELECTED

Fred L. Swartz and Wm. G. Hyberg, Architects of Fresno (California) have been commissioned by the State of California, Division of Architecture, to design new shop and science buildings for Fresno State College.

The building, which will be of reinforced concrete construction, will cost an approximate \$1,400,000.

## NAMED DIVISION SALES MANAGER

Don Hall, active in the American Petroleum Institute, Division of Production Affairs, has been appointed Division Sales Manager for the Strata-Crete and Strata-Seal, according to an announcement by R. M. Cook, manager of Strata-Crete Sales Division of the Great Lakes Carbon Corp'n. Hall is assistant secretary of the Los Angeles Basin Chapter of the A.P.I., and a member of the Petroleum Club of Los Angeles.

## ARCHITECTS CHOSEN

The Arcadia High School District Board of Trustees has announced selection of the Los Angeles architectural firm of Austin, Field & Fry to draft plans for a new Arcadia High School.

## BCA BOARD MEETS

Directors of the Building Contractors Association of California met in Los Angeles recently and heard reports of a building survey being conducted in 14 southern California counties relating to materials and possible building volume.

William Baines, newly elected president, presided.

## HOUSING BIDS ARE REJECTED

Bids of \$1,849,000 for the construction of a 208-unit Housing Project in Bernal Heights, San Francisco, were rejected by the Housing Authority of the City and County of San Francisco.

The project includes twenty-two 3 and 4-story, reinforced concrete buildings, steel sash, and a central hot water heating system. Some 200,000 sq. ft. of space is proposed.

Wm. G. Merchant, San Francisco, is the architect.

## ARCHITECT NAMED

The architectural firm of Hertzka & Knowles, San Francisco, has been appointed to draft plans for a new 18-room Grammar School at Burlingame for the Burlingame Elementary School District.

Of frame and stucco construction, the new school is to be built on the Mills Estate and will comprise classrooms, administration, shop, home economics, cafeteria and auditorium.

## HOSPITAL

State and Federal funds have been made available for the construction of a 100 bed Hospital near San Pablo, Contra Costa county.

Cost of the project, according to the West Contra Costa Hospital District, is \$2,535,000.

D. D. Stone & Lou Mulloy, San Francisco, are the architects.

The building will consist of a four-story and basement, reinforced concrete structure containing three elevators and some 85,000 sq. ft.

## ARCHITECTS SELECTED

John C. Warnecke, San Francisco, has been selected as the architect for a new occupational education building and junior college near Pacheco, in Contra Costa County.

Cost of the project is estimated at \$1,200,000.

## NAMED MANAGER

Charles F. Alexander has been named manager of the Industrial Department of the National Safety Council, according to an announcement by Ned H. Dearborn, Council president.

Alexander, experienced in the field of production, engineering, foreman training and sales, has been with the Council for five years recently serving as assistant general manager of manufacturing.

## ARCHITECT OPENS NEW OFFICES

Announcement has been made of the opening of architectural offices by Wallace A. Stephen at 205 Park Road, Burlingame, California.

Architect Stephen will engage in the general practice of architecture.

## BUS GARAGE

Pacific Greyhound Lines has started construction of a new bus service garage between Seventh and Eighth Streets in San Francisco, consisting of a one-story and part two-story 240 x 400 ft. reinforced concrete building.

Cost of the project will exceed \$2,000,000 according to Skidmore, Owings & Merrill, Architects, Barrett & Hill, San Francisco, is the contractor.

## AIR FORCE BASE REJECTS LOW BID

The purchasing and contracting office of the Hamilton Air Force Base, Marin county, California, recently rejected a bid of \$34,642 for the modification of a hangar building and converting the space into office facilities.

## SAN JOSE PERMITS ISSUED FOR HOMES

The Coastwise Construction Company of San Jose was recently granted a building permit by the City of San Jose for the construction of 43 residences on Marcis Ave. Cost of each residence is \$7,000.

## HOME CONSTRUCTION IN PALO ALTO

The Brentwood Company of San Francisco has started construction of 291 new residences on Bayshore Blvd., in Palo Alto.

Of frame and stucco construction, each unit will cost \$7,000.

## ARCHITECT PARTNERSHIP IS ANNOUNCED

Announcement has been made of the formation of the partnership of Gifford E. Sobey, A.I.A., and W. Newlon Green, A.I.A., for the general practice of architecture under the firm name of Sobey and Green, Architects.

Offices are located at 125 West Main Street, Los Gatos, California.

The firm will specialize in residential and commercial architecture, site planning and landscape architecture.

**STATIONERY  
SCHOOL & OFFICE  
SUPPLIES**

•  
Printing Engraving  
Announcements

•  
**CENTER STATIONERY**

468 McAllister  
San Francisco UN 1-3703

**MULLEN MFG.  
COMPANY**

—  
BANK, STORE AND OFFICE  
FIXTURES—CABINET WORK  
OF GUARANTEED QUALITY  
CHURCH SEATING

—  
Office and Factory  
40-80 RAUSCH ST., Bet. 7th and 8th Sts.  
San Francisco  
Telephone UNderhill 1-5815

**Thinking of Building?**

From our cost records and experience, an advance estimate may be made from decidedly general information. Based on our knowledge of labor and material costs, gained on current jobs, such an estimate may be determining your construction program.

**SWINERTON & WALBERG CO.**

ALL TYPES CONSTRUCTION  
SAN FRANCISCO • SACRAMENTO  
OAKLAND • LOS ANGELES • DENVER

**ARCHITECT SELECTED**

The San Francisco World Trade Authority recently selected Wm. G. Merchant as the architect to draw plans and specifications for the first unit of the World Trade Center Building which is to be built in San Francisco at an estimated cost of \$5,000,000.

**SHOPPING CENTER  
PERMIT APPLIED FOR**

A building permit has been applied for by the Steneson Development Company of San Francisco for the construction of a Shopping Center on 10th Avenue in San Francisco.

The project will cost \$1,250,000 and will provide facilities for stores, bank, post office and medical offices in a five story, reinforced concrete and structural steel building.

Weilton Becket, Los Angeles, is the architect.

**STATE AID GRANTED  
SCHOOL BUILDING**

A California State Aid Loan of \$900,000 has been granted the San Lorenzo Valley Unified School District for construction of a new Grammar School at Boulder Creek (Santa Cruz county).

A recent local school bond issue of \$182,000 in conjunction with the project was approved.

**STEEL MILL EXPANDS  
AT PITTSBURG**

Columbia Steel Company has excavation preparatory to constructing an \$8,000,000 addition to the cold rolled steel and tin plate mill plant at Pittsburg, California.

Plans call for a structural steel and corrugated steel building.

**REMODEL OAKLAND  
NEWSPAPER PLANT**

The Oakland Tribune Publishing Company recently completed extensive remodeling of its newspaper publishing plant on 12th street. Both interior and exterior work was involved.

Edward T. Foulkes, Oakland, was the architect.

**BUILDS WAREHOUSE**

Garlinghouse Bro's of Los Angeles have announced plans for the construction of a new warehouse and salesroom at 2415 E. Washington Blvd. in Los Angeles at a cost of \$60,000.

Frederick N. Clark is the Architect and MacIsaac, Menke and Roach, Inc., are the contractors.

**SCHOOL BONDS VOTED**

Bonds in the amount of \$108,000 have been voted for the construction of a new Grammar School at Potter Valley (Sonoma county).

Architect C. A. Caulkins, Jr. of Santa Rosa has been selected by the Potter Elementary School District to draft plans for the building.

**MAGAZINE BUILDS  
NEW BUILDING**

Sunset Magazine is building a new office building in Menlo Park, California, containing 32,000 sq. ft.

Higgins & Root of San Jose are the architects.

**ARCHITECT MOVES**

The architectural firm of Higgins & Root has moved into its new building at 220 Meridian Street, at Park Avenue, in San Jose.



**HERRICK  
IRON WORKS  
STRUCTURAL STEEL  
REINFORCING STEEL**

18TH AND CAMPBELL STS.  
OAKLAND, CALIF.  
Phone Glencourt 1-1747

Phone Garfield 1-1144

**Thomas B. Hunter**  
DESIGNER OF HEATING

AIR CONDITIONING  
VENTILATING AND WIRING  
SYSTEMS, MECHANICAL  
AND ELECTRICAL EQUIP-  
MENT OF BUILDINGS



41 SUTTER STREET  
ROOM 710  
San Francisco California

**Scott Company**

HEATING • PLUMBING  
REFRIGERATION



San Francisco  
Oakland  
San Jose  
Los Angeles

**DINWIDDIE  
CONSTRUCTION  
COMPANY**

•  
**BUILDERS**  
•

CROCKER BUILDING  
SAN FRANCISCO

*Fine*  
**ENGRAVINGS**

**POOR  
RICHARD**  
PHOTO ENGRAVING CO.  
320-324 COMMERCIAL STREET  
SAN FRANCISCO, CA

Subscribe  
Now —

**ARCHITECT  
and  
ENGINEER**

\$3.00  
Per Year

**STOLTE INC.**

*General Contractors*



**OAKLAND • CALIFORNIA**

**PITTSBURGH  
TESTING LABORATORY**

**ENGINEERS AND CHEMISTS**

Tasting and Inspection of Concrete,  
Steel and Other Structural Materials

Design of Concrete Mixes

Offices in all principal cities

651 Howard St., San Francisco 5  
EXbrook 2-1747

**A. F. MATTOCK CO.**

*Builders*



212 CLARA STREET  
SAN FRANCISCO

**Index to Advertisers**

AMERICAN Perlite Corp.....	44
ANGIER Pacific Corp.....	48
ARCHITECTS Reports .....	43
CLASSIFIED Advertising .....	42
CENTER Stationery .....	47
CLINTON Construction Company ..	36
COLUMBIA Steel Co.....*	
CONTINENTAL Water Heater Co.....	*
DINWIDDIE Construction Co.....	47
FULLER, W. P. Co.....*	
FORDERER Cornice Works.....	43
GLADDING McBean & Company ..	*
GREENBERG'S, M. Sons.....	27
HANKS, Inc., Abbott A.....	48
HAW'S Drinking Faucet Co.....	30 & 31
HERRICK Iron Works.....	47
HILLYARD Chemical Co.....	35
HOGAN Lumber Co.....	36
HUNT, Robert W., Company.....	48
HUNTER, Thos. B.....	47
JOHNSON, S. T. Co.....*	
JUDSON, Pacific-Murphy Corp.....	36
KRAFTILE Company .....	28
MATTOCK, A. F. Co.....	48
MICHEL & Pfeffer Iron Works.....	1
MONSON Bros.....	45
MULLEN Mfg. Co.....	47
NORTHERN California Electric Bureau .....	33
PACIFIC Clay Products Co.....*	
PACIFIC Coast Gas Association..	38
PACIFIC Manufacturing Company...*	37
PACIFIC Portland Cement Company Back Cover	
PACIFIC Telephone & Telegraph Co.	45
PARKER, Stoffens & Pearce.....	43
PITTSBURGH Testing Laboratory.....	48
POOR Richard Engraving Co.....	47
PORCELAIN Enamel Architectural Division, Publicity Bureau Inside Front Cover	
REMILLARD-Dandini Co.....	48
REPUBLIC Steel Corporation.....	37
SCOTT Co.....	47
SIMONDS Machinery Company.....	37
SISALKRAFT Company .....	36
SMOOT-Holman Co.....	34
SOTO, Henry; Landscape.....	34
STANLEY Works, The.....	26
STOLTE, Inc.....	48
SWINERTON & Walberg Co.....	47
U. S. Bonds..... Inside Back Cover	
UNITED STATES Steel Corp'n .....	*
VERMONT Marble Company.....*	
WESTERN Asbestos Company.....	46

\*Indicates Alternate Months

**ROBERT W. HUNT CO.**

**ENGINEERS  
INSPECTING TESTING**

**STRUCTURAL MATERIALS  
CONCRETE MIX DESIGN  
CHEMICAL ANALYSIS  
EQUIPMENT**

PRINCIPAL CITIES  
UNITED STATES • EUROPE  
SAN FRANCISCO LOS ANGELES  
PORTLAND SEATTLE

**REMILLARD-DANDINI Co.**

**Brick and  
Masonry Products**



400 MONTGOMERY STREET  
SAN FRANCISCO, CALIF.



Quality Products Since 1895  
**ANGIER PACIFIC CORPORATION**  
55 NEW MONTGOMERY ST. SAN FRANCISCO 4, CALIF. 742 SUMMIT BOULEVARD LOS ANGELES 46, CALIF.  
A complete line of Angier products available from your building material dealer.

**ABBOT A. HANKS, INC.  
Engineers & Chemists**

**INSPECTING — TESTING — CONSULTING  
CONCRETE • STEEL • MATERIALS  
CHEMICAL AND TESTING  
LABORATORIES**

• RESEARCH AND INVESTIGATION •

—  
TESTS OF STRUCTURAL MATERIALS  
DESIGN OF CONCRETE MIXES  
SHOP AND ERECTION INSPECTION OF  
STRUCTURES AND EQUIPMENT  
INVESTIGATION OF STRUCTURES  
AND MATERIALS  
TESTS AND INVESTIGATION OF  
FOUNDATION SOILS  
FIRE RESISTANCE AND INSULATION  
TESTS

624 Sacramento Street, San Francisco

# ARCHITECT AND ENGINEER

BEACH RESIDENCE—Del Mar, Santa Cruz, California



ROBERT S. KITCHEN & FRANK B. HUNT, Architects

MARCH

1951



# "The bonds we bought for our country's defense are helping our boy become a doctor!"

HOW U. S. SAVINGS BONDS  
ARE PAYING OFF FOR  
JOHN AND HELEN DALY  
OF STOCKTON, CALIFORNIA

*John and Helen Daly are proud of their son, James. "Jim always wanted to be a doctor," says Helen, "and now he's getting his chance to study medicine, thanks to our U. S. Savings Bonds and the wonderful Payroll Savings Plan!"*



"Jimmy was only 13 when John and I decided to make U. S. Savings Bonds a part of our plan for his future. I signed up then for the Payroll Savings Plan in the Stockton Naval Supply Annex where I work."



"We've saved \$3,550, now, John has his phonograph business so I'm able to put more than 25% of my salary into Payroll Savings. I buy a \$100 bond each month which goes toward paying for Jim's education."



"Jim's at the University of Santa Clara now, taking pre-medical work. Bonds are paying his tuition, and we're still buying them toward that M.D. for him. The Savings Bond method is wonderful for parents!"

## The Dalys' story can be your story, too!

Whatever your dream, you can make it come true just as the Dalys did. But you've got to start *right now!* That's easier than you think if you take these simple steps:

1. Make the big decision—to put saving *first* before you even draw your pay.
2. Decide to save a regular amount systematically, week after week or month after month. Even small sums saved on a systematic basis become a large sum in an amazingly short time!
3. Start saving automatically by signing up

*today* in the Payroll Savings Plan where you work or the Bond-A-Month Plan where you bank. You may save as little as \$1.25 a week or as much as \$375 a month. If you can set aside just \$7.50 weekly, in 10 years you'll have bonds and interest worth \$4,329.02 cash!

You'll be providing security not only for yourself and your family but for the blessed free way of life that's so important to us all. And in far less time than you think, you'll discover that you have turned your dreams into reality, just as the Daly family did.



FOR YOUR SECURITY, AND YOUR COUNTRY'S TOO,  
SAVE NOW—THROUGH REGULAR PURCHASE OF U. S. SAVINGS BONDS!

*Your government does not pay for this advertisement. It is donated by this publication in cooperation with the Advertising Council and the Magazine Publishers of America as a public service.*

# ARCHITECT

VOL. 184

No. 3

AND

# ENGINEER

ARCHITECTS' REPORTS—Published Daily

## Contents for

# MARCH

EDWIN H. WILDER  
Editor

MARK DANIELS, A.I.A.  
Associate Editor

J. WELLS HASTINGS  
Contributing Editor

PROF. LELAND VAUGHAN  
Landscape Architecture

JOHN A. BLUME  
Structural Engineering

MICHAEL GOODMAN  
Planning

JOHN S. BOLLES, A.I.A.  
Book Reviews



### COVER PICTURE

Living room of the beach residence designed by Architects Robert S. Kitchen and Frank B. Hunt of San Francisco for Dr. and Mrs. R. D. Husband, and family of three children.

The site overlooks the blue Pacific Ocean at Del Mar, Santa Cruz, California. [For complete details see Page 16.]

*Philip Fein, Photo*

EDITORIAL NOTES	4
CONSTRUCTION INDUSTRY CAN HANDLE DEFENSE AND CIVILIAN CONSTRUCTION, Report of AGC Shows	5
JOINT INFORMATION COMMITTEE American Institute of Architects & Producers Council, Inc.	6
FIXING RESPONSIBILITY FOR SAFETY ON JOB By G. W. MAXON, President, Maxon Construction Company	7
NEWS & COMMENT ON ART	9
AIR-RAID SHELTERS A "MUST" TO SAVE MILLIONS OF LIVES IN EVENT OF ATTACK CONTRACTORS TOLD BY A.I.A. PRESIDENT By RALPH T. WALKER, President, American Institute of Architects	10
WORK STARTS ON UNDERGROUND PERSHING SQUARE GARAGE, Los Angeles Architect: STILES CLEMENTS, Associated Architects and Engineers Contractors: FORD J. TWAITS CO., T. S. CONSTRUCTION ENGINEERS, INC., and MORRISON-KNUDSON, INC.	12
CALIFORNIA STYLE OCEANSIDE RESIDENCE, Del Mar, Santa Cruz; Dr. and Mrs. R. D. Husband Architects: ROBERT S. KITCHEN & FRANK B. HUNT Contractor: E. A. HATHAWAY & COMPANY By MARCIA LEE	16
A FACTORY BUILDING DOESN'T HAVE TO BE A BARN, Kaiser-Frazer Automobile Agency, Portland, Oregon Architects: WOLFF & PHILLIPS; Contractor: PETER STUART CONSTRUCTION COMPANY By ARTHUR W. PRAULX	20
ULTRA MODERN W. & J. SLOANE BUILDING, Beverly Hills, California Architect: PAUL WILLIAMS Contractor: DEL E. WEBB CONSTRUCTION COMPANY	24
A.I.A. ACTIVITIES	28
WITH THE ENGINEERS	30
PRODUCERS COUNCIL PAGE Edited by CARL B. FRANK, Detroit Steel Products.	32
BOOK REVIEWS, Pamphlets and Catalogues	36
ESTIMATOR'S GUIDE, Building and Construction Materials	39
ESTIMATOR'S DIRECTORY, Building and Construction Materials	41
BUILDING TRADES WAGE SCALES, Northern, Central & Southern California	42
CLASSIFIED ADVERTISING	42
CONSTRUCTION CONTRACTS AWARDED, General Data	44
IN THE NEWS	46
INDEX TO ADVERTISERS	48

ARCHITECT & ENGINEER  
is indexed regularly by  
ENGINEERING INDEX, INC.

ARCHITECT AND ENGINEER (Established 1905) is published on the 15th of the month by The Architect and Engineer, Inc., 68 Post St., San Francisco 4; Telephone EXbrook 2-7182. President, K. P. Kierulff; Vice-President and Manager, L. B. Penhorwood; Treasurer, E. N. Kierulff.

Los Angeles Office: Wentworth F. Green, 6605 Hollywood Blvd., Los Angeles 28. Telephone HEMPstead 3171.

Entered as second class matter, November 2, 1905, at the Post Office in San Francisco, California, under the Act of March 3, 1879. Subscriptions United States and Pan America, \$3.00 a year; \$5.00 two years; foreign countries \$5.00 a year; single copy 50c. ARCHITECTS' REPORTS are published daily from this office, Vernon S. Yallop, Manager. Telephone DOuglas 2-8311.



# EDITORIAL NOTES

## HOW YOU SELECT AN ARCHITECT

It is comparatively easy to select an architect. You proceed as in finding other professionals — by asking the opinion of friends who have employed architects to build a home, a factory, a commercial building for them; or by looking in architectural books and magazines devoted to home building, or the type of construction you have in mind; or by asking the professional organization of architects in your community which in the majority of communities throughout the nation is now listed and known as "The American Institute of Architects".

There is a Chapter of the A.I.A. in almost all larger cities today — and the service of an architect is available in every community, rural or metropolitan.

Yes indeed! It's easy to get the best in architectural knowledge today.

• • •

COLLEGES must be assured of enrolling the most talented and intelligent . . . and not merely those with personal financial backing.—Dr. Edwin S. Burdell, Director The Cooper Union.

• • •

## THE COST OF DEFENSE

No one likes higher taxes, tighter credit or curtailment of government services. But we are determined that America shall be strong. This means that we are prepared to pay the cost of defense. We can pay the price by open inflation, we can pay the price by suppressed inflation and total controls, we can pay in high taxes, tight credit and government economy.

This third way . . . is in some respects the most difficult. It makes the costs of the program clear and open. Therefore it depends for its success upon the support of the public; it cannot be imposed or "slipped over." This approach requires that the government take the responsibility for developing a program that distributes the costs of military strength fairly. It requires that the government set a standard for the behavior of the private citizen by practicing economy in its own expenditure. It requires that the public accept the costs, not only as they are meted out by tax laws and credit regulations, but also by voluntary individual and group action. Success will be the result not of a handful of decisions made in Washington but of millions of private decisions to save, to work, to exercise restraint in pressing for higher prices and higher wage rates.

This is, nevertheless, the only acceptable course of action. It is fair and efficient. It would permit our growing military strength to be erected upon a solid base of growing economic strength. Beyond this, it is best for the very reason that makes it difficult, because it calls upon the responsible action of free citizens.

• • •

"A bankrupt nation never licked anyone, and it never will."—Rep. Dewey Short, (R., Mo.)

• • •

## NO SUBSIDIES NEEDED FOR DEFENSE HOUSING

An entirely new approach to solving the nation's defense housing problem, if it is a problem other than governmental restrictions which have been placed upon the building industry, has been suggested by Alexander Summer, president of the National Association of Real Estate Boards.

As a witness before the House Banking and Currency Committee, Summer declared "No subsidies are needed for defense housing. Private industry is ready and able to do the job better, quicker, and at less cost than government building. Government restrictions will hurt, not help, needed production."

As evidence of his statements, Summer pointed out that "Government house building got the green light in June 1949, to go ahead with a \$13 billion program and after a year and a half, as far as we can determine, hasn't finished a single housing unit under that program."

It is a well known fact that during this same period of time, private industry, with all of its problems of material and sometimes labor shortages, has completed 1,800,000 homes.

Numerous other lines of commercial and industrial activities have proven that a free economy can outproduce and lick a regimented economy anytime. Individual enterprise in America does not have to adopt the restrictions of bureaucratic bungling and of regimented government in order to get the job done in the best way possible.

Defense expenditures will be tremendous for items which are unquestionably of national defense character, however, it is extremely difficult to believe that home building should be included in such a category.

# CONSTRUCTION INDUSTRY CAN HANDLE DEFENSE AND CIVILIAN CONSTRUCTION REPORT OF AGC SHOWS

The nation's construction industry, while feeling the impact of the partial mobilization program, will have the capacity to carry out all defense and essential civilian construction with speed and efficiency.

This was revealed in a survey of current conditions and prospects for the next 90 days conducted by The Associated General Contractors of America for study at its 32nd annual convention recently held in Boston.

Conditions vary widely between communities throughout the country, and closer coordination of the various parts of the mobilization program will be necessary if the industry is to operate most effectively, the survey shows.

Salient features are:

1. Most general contractors are busy now, largely in completing projects which were started last year.

2. In many parts of the country in the near future general contractors may have much unused capacity, and unemployment may develop, because defense or industrial construction is not expected to take up the slack in those areas as current projects are completed.

3. In the highway construction field there is the greatest unused capacity for work, and contractors do not appear optimistic about prospects for an immediate increase in this type of vitally needed construction.

4. Materials containing metals were reported becoming scarcer with deliveries slower, although fewer general shortages were reported than previously.

5. New construction machinery, and particularly repair parts for existing machines, are becoming more acutely short, suggesting the need for government action to prevent the industry from being stripped of its essential tools.

6. An adequate supply of skilled craftsmen generally is available, with the exception of the trowel trades in some localities.

7. Uncertainties of what will happen in the mobilization program are making it more difficult for contractors to plan their operation in advance.

The survey was conducted among the A.G.C.'s 112 affiliated chapters and branches, and among its directors, located throughout the United States and Alaska. These sources represent more than 5,700 leading firms who annually perform the bulk

of the nation's contract construction.

The association will further study the problems faced by the industry in meeting both the construction requirements of the defense programs and all other essential needs of the nation during the emergency period.

## Compared to Previous Surveys

Compared with the association's survey of industry conditions conducted last August, the current survey shows a general decline in reported shortages of labor and materials. Part of this is a result of the fact that during August the construction industry was at the peak of its operation in the greatest annual volume in its history.

However, despite the seasonal slack, the present report shows an increase in shortages of equipment. Contractors showed concern about the situation, fearing more acute shortages in the spring when many types of construction operations will be undertaken. Shortages were more predominant in highway and heavy construction. Slightly less than half of the building contractors reported a shortage of equipment, but all stated that the shortage of parts was more critical than shortage of new equipment.

A survey conducted a year ago revealed that the predominant characteristic of the industry at the time was the intense competition which was prevailing among general contractors for the new work coming on the market.

While the question of competition was not asked this year, there was evidence that there is keen competition among contractors for the fewer projects which are being awarded at this time.

Replies to the survey this year indicated wide variations in the conditions found in various areas in the country, and between different types of general contractors.

Members of the association engage in industrial, commercial, and institutional building; highway, street and airport construction and other types of earth moving and paving operations; and heavy engineering types of projects such as dams, waterworks and sewers, pipelines, dredging, canals and bridges and docks.

## The National Picture

The general contracting industry, like other industries, is feeling the pinch of controls and is pervaded by confusion about the present and by

(See Page 8)



# JOINT INFORMATION COMMITTEE

AMERICAN INSTITUTE OF ARCHITECTS and THE PRODUCERS COUNCIL, INC.

---

As a result of the interest shown in the efforts of the San Francisco A. I. A. and Producers Council Joint Information Committee the national offices of these groups are now proceeding with plans for action on the problems surrounding Uniform Specification Procedures and manufacturers Technical Literature. The action thus taken is definite recognition of the individual efforts of every member of the S. F. Producers Council and the Northern California Chapter of the A. I. A. who has been active in these groups.

Now that the initial moves have been made to get action on these fundamental needs of the industry the Joint Information Committee in this area is in a position of responsibility to maintain the activity which has lead to this result. The Producers Council Joint Information Chairman Tait Smith of Ceco Steel Company reports that his full committee is not organized for the coming year. Currently the work of establishing the needed sub-committees is under way.

Tait Smith will welcome anyone interested in working on the problem and asks that they contact him at the San Francisco office of the Ceco Steel Company. It is the purpose of the Joint Information Committee of the Producers Council to take additional steps this year which will continue the excellent results obtained thus far in the

consideration of the problems of Uniform Specification Procedures and Technical Literature.

More comment from members of both the A. I. A. and the Producers Council in Northern California can stimulate additional action towards the eventual solving of the problems being considered. Any other areas in the West who can contribute to this study should also advance the information they find or have at hand.

The cumulative development of Uniform Specifications and Technical Literature from all sources and areas of the far West will again place the emphasis on the forward looking thinking which exists in these states.

Correspondence and exchange of ideas will at this point lend considerable weight to the final solution of the problem. It will also produce a unanimity of purpose which will be most satisfactory to all concerned with the responsibility of study.

Only by the development of such an exchange of information can a sufficiently large cross section of opinion be secured to assure the members of the Joint Information Committee that every constructive move has been made toward the end desired.

---

*NOTE: This news space is being contributed by ARCHITECT & ENGINEER Magazine to the JOINT INFORMATION COMMITTEE representing the Northern California Chapter of The American Institute of Architects and the Northern California Chapter of the Producer's Council, Inc., and is available to this Committee for the purpose of bringing to the attention of leaders within the Construction Industry various phases of the Architectural profession and building materials industry procedures for general consideration and comment. Your "ideas" and any suggestions for the better pooling of thoughts along these lines should be sent to "Joint Information Committee, c/o The Architect & Engineer, 68 Post Street, San Francisco," where they will be immediately forwarded to the proper committee members.*

# FIXING OF RESPONSIBILITY FOR SAFETY ON THE JOB

By G. W. MAXON

President, Maxon Construction Co., Dayton, Ohio

Safety is big business and, like all big business in the United States, can expect to be subject to increasing regulation. Construction is one of the largest businesses in the United States and since the safety of construction employees lies in a competent accident prevention program, that program becomes an element in the management of big business and can expect regulatory rules of procedure.

As safety engineers, all of you give a great percentage of your time to the study of accident prevention and can be considered experts on that subject. Since accident prevention on the construction job is a phase of management and since any phase of construction is big business, safety engineers are most assuredly to be classed as experts in one phase of the management of that portion of big business.

It would be presumptuous for me to try to tell you how to handle your job, and I do not intend to do so. On the other hand, I wish to bring forcefully to your attention a tendency which is creeping into accident prevention and which is bringing into construction a cost element not justified nor necessary.

The production end of construction, being an element of big business, is and will always be subject to certain regulatory rules of procedure. These rules set up standards which become the measure of how well you have discharged your responsibilities. One of your duties as safety engineers is, therefore, the interpretation and application of those rules of procedure which competent authority has determined as sufficient to govern your work.

Let us examine these rules to see what brought them into being and by whom they are made.

All industrial regulation is brought about by the inability of industrial management to function in the civil life of the people as efficiently as it can in its own particular industry. The government of states or subdivisions thereof has, therefore, required that employers provide for the employee insurance which will guarantee him income during a period of idleness enforced by an industrial accident. In order to comply with that type of regulation, it has been necessary for man-

agement to employ some type of insurance organization to carry forward on a broad scale the obligation which individual management is unable to administer.

These insurance carriers are companies in a strong financial position and of national reputation for integrity. For a certain percentage of a construction payroll, they will guarantee to the state, and to the employer, that the regulatory rules in this respect will be carried out.

As construction has grown to be big business, so also these firms that provide compensation protection have grown to be big business and are managed by capable hands willing to discharge an obligation. In order that they may properly discharge these obligations they must remain strong financially which means that they must take in as much money as they pay out.

Here again the safety engineer comes in as a manager in an element of big business and each insurance carrier worth the name has in its employ competent safety engineers whose duty it is to inspect periodically each construction job in which it is interested and to cooperate with the management of that job to the end of preventing accidents.

Consider for a moment the fact that regulatory law has enforced a partnership between management of the construction operation and the insurance company which carries the compensation coverage thereon. This is a partnership which has grown stronger year by year and has done an outstanding job in decreasing the number of accidents in construction. Accidents of any type fall within the realm of safety, and safety itself has become big business in our nation and as big business has secured much publicity. Great effort is being put forth by individuals and organizations not a part of that legally constituted partnership, which I have mentioned, to take upon themselves because of the fact that they are in one way or another connected with construction, the task of promulgating and enforcing certain regulatory rules which each has developed.

We must admit that much good has come of these efforts, which have often been found neces-

(See Page 38)

## CONSTRUCTION INDUSTRY—AGC

(From Page 5)

uncertainties as to the future.

Specific results of the tabulation of replies from the association's building, highway and heavy construction chapters and branches show the following for the next 90 days.

Construction activity: 76 per cent report that members are generally busy. Many of these state that contractors are finishing work started last year. 24 per cent report that members are not busy, including the majority of highway contractors surveyed.

Defense construction: 50 per cent of the replies state that defense construction will not fill the gap being made by recent controls of construction and materials, and 22 per cent were uncertain. 28 per cent report that new defense construction would keep members busy.

Local changes in contract procedures: 42 per cent report no changes being made at present. 58 per cent report one or more changes in contract procedures. Of the total number of replies, 18 per cent state termination clauses are appearing in local contracts; 11 per cent report escalator clauses; 9 per cent mention emergency war clauses; 12 per cent report contracts being negotiated; and 12 per cent say cost-plus-a-fixed-fee contracts are being used.

Labor supply: 19 per cent report a shortage of labor; 9 per cent report specifically a shortage in one of the trowel trades; and 81 per cent report no shortage existing at this time.

Materials: 66 per cent report a shortage of materials; 29 per cent report a shortage of steel; 18 per cent report a shortage of metals; and 8 per cent report a shortage of cement. 34 per cent report no shortages.

Equipment: 58 per cent report a shortage of equipment. 34 per cent report no shortage.

Repair parts: 60 per cent report a shortage of repair parts. 40 per cent report no shortage.

Regulations of construction and materials: 92 per cent report that regulations are generally being observed by members. 8 per cent are uncertain.

### Building Construction

For building construction, the replies are as follows:

Construction activity: 87 per cent report that members are generally busy. 13 per cent say members are not busy.

Defense construction: 52 per cent state that defense construction will not fill the gap when present work is completed, and 17 per cent are uncertain. 31 per cent state that defense construction will fill the gap.

Local changes in contract procedures: 36 per

cent report no changes being made at present. 60 per cent report one or more changes. Of the total number of replies in this division, 15 per cent report termination clauses appearing in local contracts; 14 per cent report escalator clauses; 15 per cent report emergency war clauses; 18 per cent report cost-plus-a-fixed-fee contracts being used; and 8 per cent report contracts being negotiated.

Labor supply: 41 per cent report a shortage of labor. 59 per cent report no shortage.

Materials: 67 per cent report a shortage. 30 per cent report a shortage of steel; 31 per cent report a shortage of metals; and 9 per cent report a shortage of cement. 33 per cent report no shortages.

Equipment and repair parts: 43 per cent report a shortage of equipment. 57 per cent report no shortage of equipment. 46 per cent report shortages of repair parts. 54 per cent report no shortages.

Regulations of construction and materials: 96 per cent report that members are observing regulations. 4 per cent are uncertain.

### Highway Construction

For highway construction, the replies are as follows:

Construction activity: Only 30 per cent of the replies stated that members are busy. 70 per cent reported members are not busy.

Defense construction: 4 per cent report that defense construction will fill the gap resulting from curtailment of highway programs. 64 per cent report defense construction will not fill the gap and 32 per cent are uncertain.

Local changes in contract procedures: 57 per cent report no changes being made at present. 43 per cent report one or more changes. Of the total number of replies for this division, 26 per cent report termination clauses appearing; 4 per cent report escalator clauses; and 17 per cent report contracts being negotiated.

Labor supply: 33 per cent report a shortage of labor. 66 per cent report no shortage.

Materials: 70 per cent report a shortage. 35 per cent report a shortage of steel; 9 per cent report a shortage of cement. 30 per cent report no shortage.

Equipment and repair parts: 74 per cent report a shortage of equipment. 26 per cent report no shortage. 91 per cent report a shortage of repair parts. 9 per cent report no shortage.

Regulations of construction and materials: 90 per cent report that members are observing regulations. 10 per cent are uncertain.

### Heavy Construction

For heavy construction the replies are as follows:

Construction activity: 77 per cent report that members are generally busy. 23 per cent report members are not busy.

(See Page 34)

# NEWS AND COMMENT ON ART

## TUCSON FESTIVAL OF ARTS

The Tucson Festival of Arts, sponsored by the Tucson Festival Society, Inc., began a two week celebration on March 25 with a Yaqui Indian Pascua Ritual, and will close April 8 with an Epic Play by Oliver LaFarge and Letitia Evans featuring the heroic spectacle of the Southwest's historic conflicts between Indians and white settlers.

Other featured attractions include a fiesta and open house on April 5, with an Indian fashion show, outdoor concerts, Tucson Boys Choir, and singing and dancing; a folk-lore festival on April 6; symphony concert, April 8.

Whole streets of the downtown section of the city, all of the galleries, and many institutions will be given to the display of the best of Tucson's art, past and present, during the festival period.

## CITY OF PARIS

The Rotunda Art Gallery of the City of Paris, San Francisco, will feature an exhibition of painting by four young artists during the month of March. Taking part in the special event will be Joseph Bradley, D. Faralla, Lundy Siegriest, and Frann Spencer.

Screen prints and lithographs by Cain, Macey, Olds, Opper, Petit, Pylak, Rathbone, and Surendorf will be featured in the pictures of the month exhibit.

## PORTLAND ART MUSEUM

Thomas C. Colt, Jr., director of the Portland Art Museum, West Park and Madison, announces that the calendar of exhibitions for March will feature the C. S. Price Memorial Exhibition.

Dr. R. F. Arragon, professor of history at Reed College, has been selected to fill the unexpired term of architect Pietro Belluschi on the Board of Trustees. Belluschi, who served on the Board of Trustees from 1946 to 1948, has accepted the position of dean of the school of architecture and Planning at the Massachusetts Institute of Technology.

## KATE NEAL KINLEY MEMORIAL FELLOWSHIP

The Board of Trustees of the University of Illinois has announced the twentieth annual consideration of candidates for the Kate Neal Kinley Memorial Fellowships.

The fellowship yields the sum of \$1000 which is to be used by the recipient toward defraying the expenses of advanced study of the fine arts in America and abroad.

Graduates in the fine and applied arts of music, art, and architecture are eligible. They should not be over 24 years of age (veterans may deduct amount of time spent in service).

Applications should reach the committee not later than May 15, 1951, and should be addressed to Dean Rexford Newcomb, College of Fine and Applied Arts, Architecture Building, University of Illinois, Urbana, Illinois.

## CALIFORNIA SCHOOL OF FINE ARTS

Applications for the Bender Grants-in-Aid were received with five awards of \$1200 each being offered this year in the fields of art and literature, two each, and one in photography. The Grants in Art are limited to paintings and sculpture. In literature the awards will be made on creative writing.

The jury in art is composed of William A. Gaw, chairman of the art department of Mills College; Henry Hill, architect; Jermyne MacAgy, curator of the Legion of Honor; Daniel M. Mendelowitz, Stanford University; and James McCrary, University of California. The literature jury is composed of Mark Schorer, University of California; Franklin Walker, Mills College; Edith R. Mirrielees, Stanford University; and Joseph H. Jackson. The photography jury comprises Ansel Adams, Edward Weston, Imogen Cunningham, and Minor White.

## M. H. de YOUNG MEMORIAL MUSEUM

The M. H. de Young Memorial Museum in Golden Gate Park, San Francisco has scheduled the following exhibits for the month of March, according to Walter Heil, director:

EXHIBITIONS: The Edvard Munch, Retrospective Exhibition of Paintings and Prints; Ballet Design, Lincoln Kirstein and Pavel Tchelitchew Collections lent by the Museum of Modern Art, New York, and the George Balanchine Collection; 6th Annual Faculty Show of the California School of Fine Arts comprising a collection of Paintings, Sculpture, Jewelry, Photography, and Advertising Design; the Anna Sosenko-Hildegard Collection of Paintings and Prints; Zoltan Sepseshy, Paintings; the San Francisco Women Artists, Prints.

EVENTS: Exercises in Perception, a study of seeing habits and modes of representation for a more conscious appreciation of art; Workshop, painting for the practice of observation and appreciation; Classes for children, Saturday mornings; and Picture Making, a class for students 10 to 15 years old.

The Museum is open daily from 10 a.m. to 5 p.m.



# AIR-RAID SHELTERS A "MUST" TO SAVE MILLIONS OF LIVES IN EVENT OF ATTACK CONTRACTORS TOLD BY A.I.A. PRESIDENT

By RALPH T. WALKER, President, American Institute of Architects

## PART II (Conclusion)

The immediate impact upon the construction industry will be the series of restrictive orders from the Federal Government concerning the use of building credit, the kind of buildings permitted, and the materials which we will be able to use when left over from the military effort—and that effort interpreted in its widest and most generous way. They have already begun to descend upon us with all the force of a hurricane and all of us, like the shorn lambs, will have to bend our heads into the tempering blast—hoping to weather the immediate fury and trusting that our friend, General Harrison, is right, that finally the immense war effort will bring a larger demand for our skills. We are being invited by law this time, to say at least what we think before the ax falls. Last week I attended the meeting, in Washington, when the new order amending M-4 was presented to representatives of the construction industry. Fortunately the usual rumors were rife, and in this case accurate, so that we who were present were prepared for the proposal, i.e., to stop all commercial building until February 15th and then thereafter to require a license of necessity to build. We were presented with a picture of the entire construction industry in relation to the national economy and to the war effort, and I think I may say that the industry representatives there felt the reasonableness of the presentation. No one wants regulation, but it is equally foolish to expect a large proportion of our economy to be on a priority basis and then leave the rest to be participated in as a wild scramble.

And it is easy enough to say: "Why does not the 'military' determine what it needs and then leave the rest to the normal processes of our economy;" but how many of you believed early in November that Korea would result in a defeat? We all hoped to get the boys "out of the trenches by Christmas." **At least one thing is certain: that**

**phrase is forever buried.** The trouble is that too many things are in short supply actually, and also because there is a scrambled demand for others. You can blame, and should, the administration for its bad judgment and past mistakes, but that does not relieve the immediate necessity.

This new order, of course, hits the major cities and those along the Atlantic coastline especially. It hits architects and builders alike. It may not be too easy to make out a case for necessity where there is no accompanying war work, and I think there will be little of that here (New York City).

### Work To Be Done

There is, however, a great deal of work to be done. In New York, Boston, Philadelphia, Washington, to shelter workers in the places where they work—and this should be done immediately. Therefore, every building owner, within his building, should make—I might even say be forced to make—the relatively safe economical shelters which are possible, and if built now may save the lives of millions. I believe that the money necessary to achieve this, is an absolute must. It is a small price to pay for reasonable security.

Besides, these cities are some of the greatest ports in the United States and special consideration should be given to making them a continuing possibility. I have no means of knowing what planning is contemplated but it would seem extremely desirable that some war supplies, i.e., ammunition, should not be sent from them; and that warehousing and docking for all export goods be scattered as widely as possible. A considered play may well change the appearance of our water fronts. Certainly there are but few such concentrations of facilities on which even student bombers might so easily lay a stick of explosives. All are juicy targets. Every day the downtown areas of these cities are flooded with workers, over three million in lower Manhattan alone. The safety of these millions should engage our serious attention. While we appreciate that it is impossible to decentralize these groups of workers to less obvious targets, and while we may not even believe

EDITOR'S NOTE: Part Two of text of speech by Ralph T. Walker, president A.I.A. and member architectural-engineering firm Voorhees, Walker, Foley & Smith, New York City, delivered before recent annual meeting New York Building Trades Employers' Association.

that a bombing raid is possible, and we may believe that we have an adequate defense (as did the French in 1939), I earnestly suggest that we create in every working and dwelling area on adequate place which gives a sense of security.

Those of us who have given study to blast effects do not believe that defense is impossible. In fact, we believe that panic, a panic caused by the lack of protection, is the most serious thing we face. To be at the center of any blast area is one chance in a thousand, but the fringe areas are as important for block-buster attacks as for A-bombs.

A taxi driver said to me when I designed the United Nations meeting room at Hunter College: "Jees"—I hopes you makes it stick." Just the other day, another said, regarding an attack on New York: "Let's cross that bridge when we come to it." I replied that I supposed he had chosen his panic-way out of New York, and was prepared to walk, not run; and I think his answer is noteworthy: "Gee, can you imagine it? It's moider."

### May Not Be Time

In twelve months we may be far enough out of the immediate difficulty to build some more steel and glass crystal cakes for humans, and no doubt we will. But it comes to this: What is necessary to keep the ports working; and what is necessary to keep American civilization operating?

We seem to be following in the footsteps of the Russians in having one five year plan after another. Remember we were going to have the A-bomb all for our own for at least five years; and now we are so far ahead, that we still have five years—at least Mr. William Lawrence of the New York Times would have us believe—and then, no war. He is an expert and no doubt he is right; but as for me, I am finding a "better 'ole" so that I can duck the **unexpected expected** and live to fight. Some one told me recently that our greatest resource, one that we should do everything to conserve, took the longest to manufacture (not even Charles Wilson can hurry it), i.e., a G. I.—nine months of gestation, eighteen years of growing up, and another nine months of training. The famous "Heart Island" of the world has lots of this kind of resource, and they need only bugles, rockets and firecrackers to start driving our own limited resources down "heartbreak highways".

If you read recent history you will note that the **means** of mass death have greatly increased—bathubs, autos, airplanes, Long Island railroads and, of course, those more scientific. Yet strangely enough, the damned population of the world keeps on increasing and even you and I, for this moment, are still alive.

The construction industry in the last war did a very marvelous job. We do have skills which are needed. However, the immediate future is going

to require of us conservation of materials. We need to find substitutions in all of the building trades; we must all do economical planning; we are being asked to cooperate and not to hoard. Do not ask for unnecessary licenses or priorities. It is not only the time for sacrifice but still more a time for invention; and from my knowledge of the brains and powers in Washington, if you do not do this willingly and with grace, you will find life very difficult indeed. I have been told several times that **no one individual** need think his little interest is going to stop the great need of the country to get itself not only in a defensive position, but one which makes any aggressor, i.e., Russia, slow to tread on the tails of our coat.

### The Future

The future of this country to an architect planner, probably termed long-haired by that good highway man Robert Moses, is going to have fewer cities like New York, fewer congestions of population as now seen along the Atlantic coast line. There has been through the last thirty years a great deal of decentralization of cities. It is well known that the centers have grown at a diminishing rate, while the adjoining regions have increased much more rapidly. As one flies across the country from city to city one is aware that this is not only a movement of wide populations to better and more open living conditions but also a movement of industry. I believe it is becoming recognized that industry is more efficient when it is broken down into smaller units. Smaller units permit more personal management and less danger of having **one industry towns**. It is questionable whether there ever again will be great plants such as that at River Rouge. Certainly the recent policy of most industry is to decentralize assembly work much nearer the consumer point.

This decentralization of cities is a phenomenon apparent in Europe as well as here. The traffic congestion due to the modern means of transportation would alone force another type of city. For example, it now takes me eight minutes longer to commute each way than it did twenty-five years ago.

Gentlemen, I believe we should scatter. I repeat it is impossible to redistribute the population of our several large cities economically or fast enough to increase their safety through dispersal, but certainly we should not be adding to the problem.

The decentralization of major cities will be further hastened now by well planned disposition of industry and the necessary housing and facilities accompanying is especially to meet the threat of the A-bomb. This is not a matter of hysteria but one of common sense. It belongs in the same cate-

(See Page 43)



Architect Stiles Clements' drawing of reconstructed Park surface, as it will appear after Pershing Square underground garage is completed.

*Photo by Stiles Clements*

# WORK STARTS ON UNDERGROUND PERSHING SQUARE GARAGE

LOS ANGELES, CALIFORNIA

ARCHITECT: Stiles Clements, Associated  
Architects and Engineers

CONTRACTORS: Ford J. Twaits Company  
T. S. Construction Engineers, Inc.  
Morrison-Knudsen, Inc.

Ground was broken for one of the world's biggest underground garage projects when special ceremonies the first of February, sponsored by the Downtown Business Men's Association, marked the start of construction of the City Park Garage located beneath famed Pershing Square in downtown Los Angeles. An emergency permit issued by the National Production Authority will assure

a plentiful supply of materials, according to Ford J. Twaits Company, T. S. Construction Engineers, Inc., and Morrison-Knudsen, Inc., joint venturers in the garage's erection.

#### HISTORICAL SPOT

The property known as Pershing Square with its surrounding street areas belongs to the City of Los Angeles and with the exception of the California

## ... PERSHING SQUARE GARAGE

View of restored park surface, as it will appear after underground garage is completed. Note that all drives in and out pass under sidewalks, speeds up movement of cars in and out of garage with maximum safety to pedestrians and automobiles.

*Rotzbild, Photo*

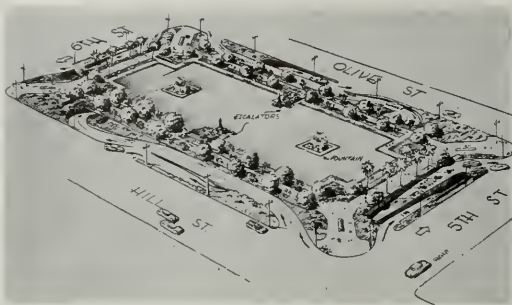

Indians and the King of Spain has never belonged to anyone else. Hence, there is no truth in stories sometimes circulated to the effect that the person or persons who "gave Pershing Square to the City" had "died in poverty" or that any heirs of such persons exist who might have claims upon the property if it were used for other than park purposes.

Legends with reference to this property tell us that because it was somewhat swampy in nature in the early days and with a considerable natural growth of trees and grass, it was used regularly as a camping spot for traveling groups going through from San Diego to San Francisco, or return, and between closer points surrounding the Los Angeles Pueblo. It was this general condition

undoubtedly which caused the government of the Pueblo to refrain from selling this particular block of the Pueblo lands and made it possible to keep it in the possession of the present government as a "public place".

It should be noted that this is not a park in the technical sense and has never been dedicated for park purposes. On the contrary, its dedication has been for the enjoyment of the citizens of the city, much like the old "Commons" of Massachusetts and other states.

While most attorneys agreed that the city, through the Park Department, probably had full authority to lease the underground rights in the park for garage purposes, it was felt that financing concerns would not be willing to loan large sums

**Architect's drawing of building housing escalators, as they will appear when underground garage is completed. Location is middle of block on Hill and Olive Streets.**

*Photo by Stiles Clements, Associated Architects and Engineers.*





## PERSHING SQUARE GARAGE . . .



Closeup of one of drives, showing start of one of 2-lane spiral ramps. Drives will be approximately 600 feet on a Hill and Olive streets, 300 ft. on Fifth and Sixth streets. About 17 cars may be held on longer drives (ingress) in each of lanes.

of money on the garage without more specific authority being given by the people of the city. Consequently, a charter amendment was offered to the voters in the April election of 1947 which covered the situation satisfactorily.

This amendment was carried by two to one vote and all publicity with reference to the election carried the inference or direct statement that it was the intention to lease Pershing Square for a garage if the amendment carried.

### EARLY PLANS FAIL

Repeated efforts were made in early days to bring about the construction of a garage under Pershing Square. The earliest on record was in 1928 when a group of local property owners and business men attempted to promote it.

In 1931 and 1932 three different groups worked on plans for such a garage. None of these proposals, however, seemed to get to the core of the matter which was working out a definite plan

under which the city would either build and operate such a garage itself or would lease the property to private parties for such construction and operation.

Activities which culminated in the present lease were started in the early months of 1945.

The location was established in a survey and report known as "Downtown Los Angeles Parking Study," which the Downtown Business Men's Association prepared, by showing that Pershing Square was in exactly the right location to serve a great number of people and institutions with convenient parking who were not served at that time, or now, by reason generally of the encroachment of Bunker Hill into the more level area of the downtown district.

This study was followed by an intensive investigation and study, carried on jointly by the Ramp Buildings Corporation and the Association, to determine both the economic and engineering facts

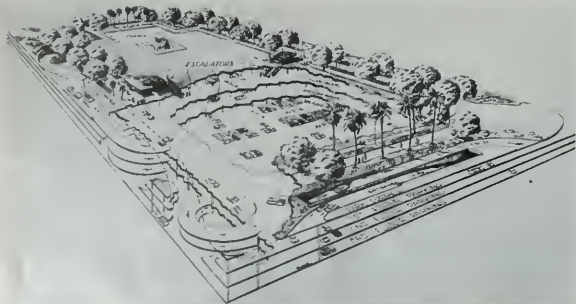

Cutaway showing both restored park surface and interior detail.

Rendering showing detail of spiral ramps, 27 feet wide. There will be six such ramps, 4 on Hill and 2 on Olive. They have a grade variation of 8 to 10 per cent.

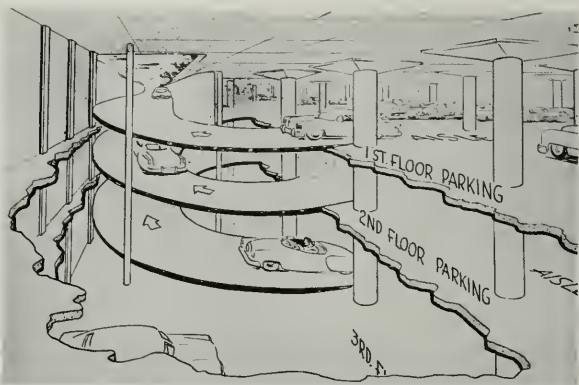

concerning this and other possible parking projects. A complete report was written showing the desirability of the project, giving a close estimate of its cost, and an estimate of business that might be done if it was built.

All studies have been kept up-to-date through the assistance particularly of Ralph Dorsey, street traffic engineer of Los Angeles, and many other city, county and state engineers.

During the second half of 1946 the Downtown Parking Association, which had been organized by the Downtown Business Men's Association to carry on parking activities, determined that the Pershing Square project was the most important and most feasible of all parking projects studied, and gave the staff of the two organizations full authority to proceed toward carrying out the proposals.

The 1947 Charter Amendment was the first concrete step taken, followed by approximately a

year of study and preparation of a lease form which would be satisfactory to the city and upon which persons interested in building and operating the garage might reasonably be expected to bid.

During the same period, many weeks were spent on tentative plans for the new park surface culminating in the adoption of the official plan by the Park Commission during 1949. These plans were submitted to the general public by advertisement and requests made for proposed changes which prospective bidders thought might be better than the official plans.

This request resulted in a number of proposed changes which were studied by the Park Commission intensively over a period of three months. The principal request for a change in plans was one asking that the successful lessee be permitted to materially raise the surface above its present elevation. Some plans called for as much as an eleven foot raise along the Hill Street side to make

(See Page 26)

Cutaway showing detail of interior construction.

After parking cars, drivers will ascend and descend by escalators.

Rothschild,  
Photo

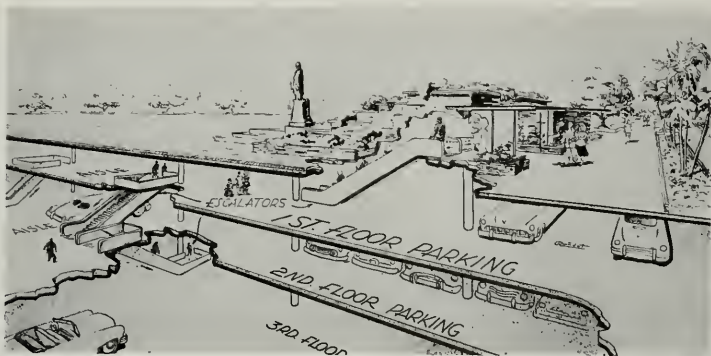



CALIFORNIA STYLE  
OCEAN SIDE RESIDENCE

DEL MAR, SANTA CRUZ

OWNERS: Dr. and Mrs. R. D. Husband  
ARCHITECTS: Robert S. Kitchen & Frank B. Hunt  
CONTRACTOR: E. A. Hathaway & Co.

COST—\$12.15 per sq. ft., House proper  
AREA—1890 sq. ft. in House; 625 sq. ft. Car Port;  
1320 sq. ft. Paved Terrace

**PLOT  
PLAN**



**By MARCIA LEE**

For the oceanside . . . a hill top . . . a lake, wherever outdoor living is a must and the wind a menace, here is a clever plan that traps the sun, sweeps in the view and snubs the discomforting gusts.

**Design**

The U-shaped house is planned around an outdoor living court made completely private and windproof by the addition of a grapeslake fence on the fourth side. (This fence, in turn, forms one wall of the carport set in a parking area large enough for seven cars.)

Glass sliding doors and large windows of fixed glass bring the view right **through the house** into the completely protected outdoor court.

The wing to the right of the court contains three of the four bedrooms and two baths, all opening off of a hallway lined on the outer side with enclosed built-in cupboards and storage space.

The kitchen and breakfast nook wing to the left is a functional masterpiece. The brick backing of the barbecue at one end doubles as a section of the inside kitchen wall, adding interesting contrast with the white porcelain appliances and pine plywood cupboards. It is a simple matter to supply the barbecue with food, equipment, etc., through

*Photographs by Philip Fein*





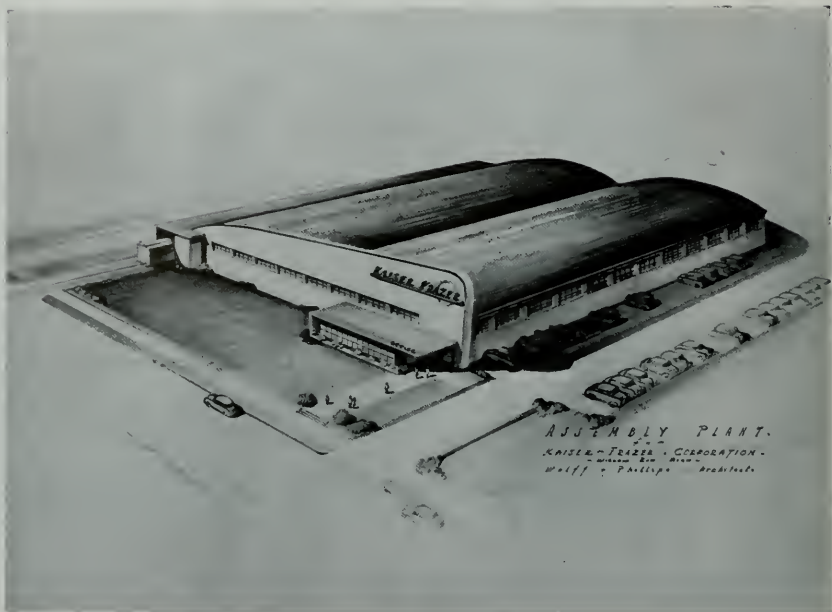

Artist's sketch . . . Architecture departs from "barn like" factories

Photo, Art Commercial Studio

# A FACTORY BUILDING DOESN'T HAVE TO BE A BARN

## KAISER-FRAZER AUTOMOBILE FACTORY PORTLAND, OREGON

By **ARTHUR W. PRIAULX**

**ARCHITECTS:**

Wolff and Phillips

**CONTRACTOR:**

Peter Stuart Construction Co.

**AREA:**

58,000 sq. ft.

In Kaiser-Frazer's new \$350,000 automobile assembly plant at Portland, Oregon, Architects Wolff and Phillips have come up with one of the more unique factory structures designed in the Northwest this year.

The problem was to get the maximum covered floor space free of annoying posts and obstructions. The architects, who have done all of Henry J. Kaiser's designing from the early shipyards in World War II to Willow Run and the modern industrial plants being built by the industrialist, decided to use a glued-laminated bowstring truss

One of the features of the structure is the 100-foot bowstring Arch-Teco type wooden trusses. Of glued laminated design, they are flexible and economical.



technique to get the wide expanse of unobstructed factory working space.

The building is 200 by 250 feet and with adjoining office space contains 58,000 square feet of factory and office working area. It has been built on five and a half acres of land in Portland's northeast industrial district between 77th and 79th and Killingsworth and Columbia Boulevards.

Wolff and Phillips decided to use two parallel roof bays 100 feet wide the full length of the 250-foot structure with the roof sections supported by 100-foot long bowstring trusses. In this way they acquired 50,000 feet of factory working area free of all obstruction excepting for eleven steel posts down the center of the structure which support the trusses.

While the bowstring truss is typical of those used for the past several years, these particular trusses embody relatively new improvements added to the already recognized principles of the bowstring. The top and bottom chords in each truss are glued laminated and are made up of one and five-eighths inch Douglas fir lumber, and were designed and fabricated in a Portland factory.

While 100 feet is a sizable truss member of the Arch-Teco bowstring type it is only average length today, as some have been successfully designed as long as 230 feet.

These trusses, with the glued laminated top and bottom chords, mark a relatively new trend in industrial use and development of the wooden fabricated structures. The trusses weigh approximately 8,000 pounds each and contain something over 3400 board feet of top quality structural Douglas fir lumber. The finished top chord is 5¼ by 13 inches and the bottom chord is 5¼ by 11¾ inches. The architect advises that the 5¼-inch width of the chords has been adopted as standard after



◀  
Corner detail of the glued laminated bowstring truss. Note simplicity of detail of these trusses used in another structure. Top and bottom chords are glued, made up from 1½ inch material.

Photo by Timber Structures, Inc.

## A FACTORY BUILDING . . .

exhaustive tests which have shown this size best meets the National Fire Underwriters requirements for slow burning.

One feature of the glued laminated truss liked especially by Peter Stuart Construction Company is the ease with which the truss members can be placed in position. A portable crane picks them off a truck or railroad car and walks them into position and sets the ends on the posts or wall sections without delaying the crews.

There were twenty-two, 100-foot-long trusses used in the two bays and the spacing was conventional for span of truss at twenty-one feet. The designers have been able to get a very attractive structure from this factory by streamlining the roof bays and the exposed fire walls to break down square corners.

All struts used are solid, six by six inches in dimension. Perlins are also solid six by twelve inches. There are twenty-four perlins in each bay spaced at eight foot centers. The struts have been

installed as vertical cross sway bracing.

Roof of the structure is a built up asphalt type laid on wooden decking. The floor of the factory is a solid concrete slab. A spur track has been laid along the 250-foot side of the building from the Union Pacific tracks. The building has been built for the Kaiser-Frazer interests by the Union Pacific Railroad Company and provided on a long-term 25-year lease.

Decision of the Kaiser-Frazer people to build this automobile assembly plant in the Pacific Northwest is prompted by a program of decentralization of plants recently adopted by the automobile firm. The Portland assembly plant is one of 100 similar factories which will be built throughout the United States.

Office space will occupy an area 16 by 176 feet in a separate addition adjoining the main factory structure. Outside factory walls are of reinforced concrete.

Wolf and Phillips use the glued laminated Arch-

**Illustration of the 95-ft. long bowstring trusses of the Linga Warehouse at Dallas, Texas, being set into position with tall crane. No delay in installation is feature liked by Architects Wolff and Phillips.**

*Photo, Timber Structures, Inc.*



Handled like a baby are these finely designed trusses being wrapped for shipment at manufacturing plant in Portland, Oregon. Moisture is kept out by special moisture proof paper until truss is safely installed.



Teco type truss in many of their industrial structures in the Pacific Northwest. They say it is more economical, more flexible to handle and design and is a time-saver for erecting crews. They point out that the arches of glued timbers can be built up into most excellent structural units for a variety of uses. They serve well on short or long spans and under high or low rise roofs. They can be made to combine not only all the needed structural strength, but ornamental appearance.

Improved gluing and fabricating techniques developed by leading timber engineering firms, Wolff and Phillips point out, now make it possible to build trusses and solid timbers into almost any size, shape or length. Bowstring trusses are generally specified by these architects for they believe they are best suited to timber; the web members

are light and chords are stressed uniformly throughout their length.

The new Kaiser-Frazer Portland assembly plant, just put in operation, has a capacity of twenty automobiles a day. Area around the factory is being paved for temporary storage of cars before they are driven or hauled to distributors in this area.

The principle of the assembly line method has been well used in this new building. All fabricated sections and parts are moved directly under shelter from freight cars to assembly line positions.

The new Kaiser-Frazer factory at Portland is in the modern mood. Streamlined and functional it proves that large areas of floor space can be enclosed under roof without getting the cold, ugly effect of the "barn" or loft building.

Science and skill go into glueing laminated arches and trusses at manufacturing plant in Portland. Here arches are being laminated. Trusses are made up the same way.

*Photos on this page by  
Art Commercial Studios*





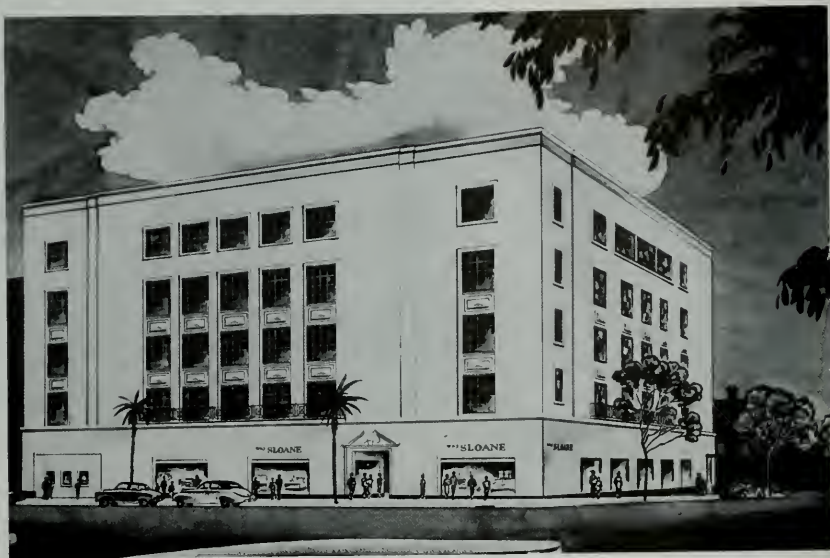

ULTRA MODERN

## W. & J. SLOANE BUILDING

BEVERLY HILLS, CALIFORNIA

PAUL WILLIAMS, Architect

DEL E. WEBB CONSTRUCTION COMPANY, Contractor

The new Beverly Hills branch of the W. J. Sloane organization is one of Southern California's "show places," as the ultra modern five story building on Wilshire Blvd., contains some 100,000 sq. ft. of floor space and some of the newest developments in home furnishing merchandising.

Designed by architect Paul Williams, A.I.A. of Los Angeles, in conjunction with William Tode, New York interior decorator, the new building offers many merchandising and display facilities that are unique in the home furnishing field.

Outstanding features of the new building include such innovations as window displays that are prepared in the basement and then raised into display position by elevators. A motor "promenade" to the rear of the store through which it is

estimated 90 per cent of the store's traffic will flow; an underground parking area for 150 cars; and a model home on the fifth floor that will feature the latest in correlated groupings of all types of home furnishings, are other special features of the building.

Arrangement of the interior includes special decorator rooms for private consultants; scientific "cove" lighting to provide the best possible artificial lighting, combined with ample daylight, for true color, texture and pattern selection; and a sub basement under the basement parking area is large enough for trucks to make and pick up deliveries.

Employee facilities are also of the finest. A restaurant, lounge, medical room, roof garden and sun deck, and dressing rooms and showers.

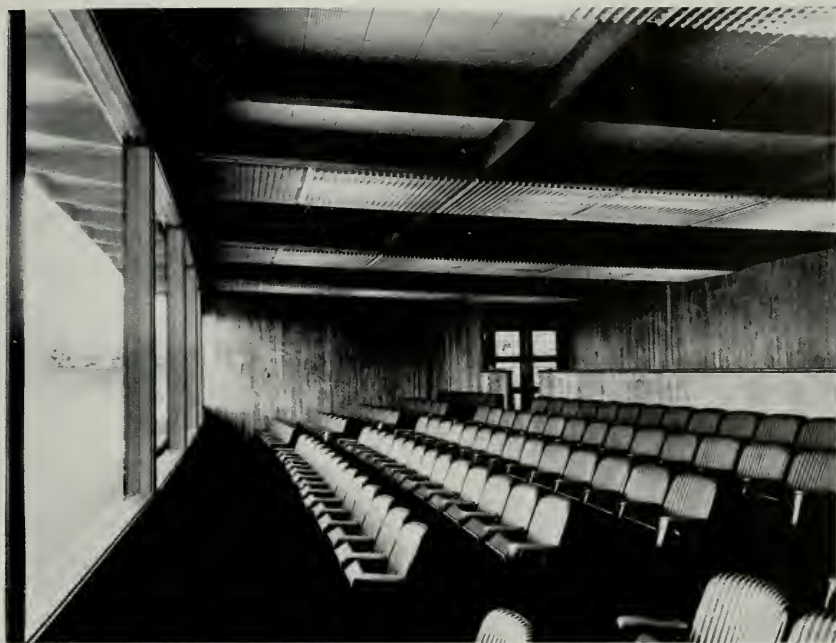

*Lumite Photo*

## NEW DRIVE-IN THEATRE

### SAN JOSE, CALIFORNIA

Something new has been added to the drive-in theater.

An innovation in the patron facilities of the popular drive-in theater has been introduced into the attractive design of the newly completed El Rancho Drive-in movie theater near San Jose, California.

One of the newest open air type theaters to be built on the West Coast, owners of the El Rancho decided to deviate somewhat in the "extra" attractions to be offered to the drive-in patron. Instead of following the "fashion" introduced at various drive-in theaters, such as "bottle warmers" for the baby's milk, or a laundramat where the washing could be done at the same time the "family" enjoyed the movies, developers of the El Rancho offer what they have designated as a "walk-in" seating section.

The "walk-in" consists of a spacious covered area in front of the regular large projection

screen that is equipped with 163 comfortable chairs. The well constructed chairs are separated sufficiently to allow ample space for the seated persons comfort and they feature a tweed weave saran as the upholstered fabric. This type material was chosen because it offered a colorful appearance which harmonizes with the balance of the theater, and it has proven to be a very durable material that will withstand hard wear. Another factor in the selection of this material was the ease with which it may be cleaned and the low maintenance costs.

The usual automobile parking spaces, with individual car speakers, are available, but, for those who desire the comfort of spacious seating they have the new "walk-in" section. Thus patrons of the new El Rancho outdoor theater have the option of seeing the show from their automobile or from the newly provided seating section.

## PERSHING SQUARE GARAGE

(From Page 15)

it possible for cars to drive directly off the street into the garage rather than to go underneath the present park level.

### NEW PLAN ADOPTED

This request was finally denied by the Commission and the original plans, with minor modifications and some additional alternatives, were re-adopted and presented to the City Council for approval.

In October 1949 bids were first called for on the lease and surface plans, and a period of about 60 days was given prospective bidders in which to file bids and post a \$50,000.00 cashiers check to guarantee carrying out the project if their bid was accepted. At the end of this period no bids had been received and an extension was given at the request of several persons who had indicated a desire to bid. No bids were received at the end of the extended period and for a time it appeared that the Department of Recreation and Parks would drop the whole matter on the ground there was not sufficient interest to warrant re-advertising the project.

However, at the Downtown Business Men's Association urgent request and written statements from several concerns, including the Morrison-Knudsen Company, that they would bid if given another opportunity, bids were again called for, but again none were received due to prospective bidders having considerable difficulty making final arrangements for financing. However, after a further extension of about six weeks, a single bid was received from the corporation known as City Park Garage, Inc., organized by the syndicate of Morrison-Knudsen Company, Ford J. Twaits Contractors and Stiles O. Clements, architect.

After long negotiations concerning possible income to the city and the probable tax rate on the leasehold, a guarantee to the city was made by a group of parking operators, who will become the operators of the Pershing Square Garage, providing that the city will receive in the aggregate at least \$12,000 per year for the first twenty years of the lease period as rental plus, in addition, the taxes which the city will receive where none have been received before.

It is estimated that the taxes will bring in \$25,000 per year to the city, plus \$75,000 divided between the county and the School District. After the twenty year period the profits of the garage, in which the city will share, will bring in a much larger sum than the \$12,000 yearly guarantee.

### GARAGE PLANS

Plans for the garage structure are being made by Stiles Clements Associated Architects & Engi-

neers. In general, the plans call for three floors, approximately 2000 car capacity at one time, which will make it one of the largest underground garages in the world.

From a traffic standpoint, the garage will provide a much better traffic design than any other now in use in that all automobile ramps in and out of the garage will pass under the sidewalks, thus avoiding any possibility of collision between pedestrians and automobiles, and at the same time speeding up the movement of automobile traffic.

All exterior ramps leading into the garage are nearly one block in length providing an enormous storage capacity for automobiles waiting to go into the garage, and taking them off the streets.

Interior ramps are circular in design and permit driving automobiles from any incoming ramp down to all floors of the garage.

All car movements in and out of the garage are parallel to the curbs and must move in line with existing street traffic. This provides for moving the greatest amount of traffic in and out of the garage with the least possible interference with other traffic.

Persons using the garage are provided with escalators, both up and down, from all floors to the park surface adjacent to the main sidewalk surrounding the park area.

Ample rest rooms are provided in the garage for those parking and, in addition, restrooms segregated from the garage property will be provided with easy stair connections from the main sidewalks, for the general public, as a park convenience.

Services for automobiles will be provided consisting of gasoline, lubrication, tires and other accessories, washing and other services found in first class garages.

A beautiful new park surface design has been developed by the architects through consultation with prominent landscape architects and the staff of the Recreation and Parks Department so that the new park when finished will be far more beautiful than the existing one and probably more usable for the great majority of persons than the present design.

### STATISTICS

Estimated cost of the garage structure including the new park is \$5,000,000. This amount is all private capital, no portion being provided by the city or any other governmental agency.

Financing was accomplished by a first mortgage loan from The Equitable Life Assurance Society, a second debenture mortgage bond sale to local business interests and the purchase of common stock by the syndicate, City Park Garage,

Inc. A total of \$250,000 of second debenture bonds were purchased by downtown business and property owners through the activities of the Downtown Business Men's Association, who obtained the agreement to purchase these in a whirlwind ten-day campaign.

Approximately 200,000 cubic yards of material, which is equivalent to 270,000 tons, will be excavated. About 23,000 cubic yards, which is equivalent to 31,000 tons, of good soil will be brought back and placed on top of the garage roof to provide a satisfactory park surface.

Approximately 50,000 cubic yards, or 105,000 tons, of reinforced concrete will be used.

Construction will take from 12 to 18 months with every effort being made to complete the project as quickly as possible.

With the 2000 car capacity it is anticipated that from four to five thousand cars will be parked daily when the garage is in full operation.

Ventilation will provide a complete change of air at least once every six minutes.

The lease is for 50 years at the end of which time the structure must be returned to the city park department who, thereafter, will be able to operate it or lease it for operation on behalf of the city.

The approximate depth of the garage structure between the third floor and roof is 29 feet. Each floor represents 210,000 square feet of floor area or a total of 630,000 square feet.

The park location is surrounded by four excellent thoroughfares of which Fifth and Sixth are one-way, facilitating traffic to and from the west particularly; while Hill and Olive give excellent access from the north and south. All four streets connect directly, or nearly so, to important freeways now being constructed on the north and west sides of the downtown district.

Additional freeways to be constructed eventually on the east and south sides of the district will, undoubtedly, provide similar connections for the four streets mentioned.

Local and national studies indicate the maximum number of cars leaving the garage at any time would be during the evening peak hour, from 4:45 to 5:45 p.m., when approximately 720 cars would leave. This amount of traffic distributed on four streets is less than that of a 500 car garage with an exit on a single street only.

#### **GLADDING, McBEAN CO. SETS NEW WORLD SAFETY RECORD**

Employees and management of Gladding, McBean & Co. Southern Division established a new world's safety record for the heavy clay products industry recently, as production at the company's four Southern Division heavy clay products manufacturing plants rolled up more than 2.6 million

man hours worked without a single lost-time accident.

Participating in the record were the sewer pipe, refractories, and other heavy clay products departments. The sewer pipe departments at the company's Glendale and Santa Monica plants have bettered the perfect two-year record of the other departments by adding up a total of 773 days without a lost-time accident, despite the handling of clay pipe weighing as much as 3500 pounds per piece. This perfect record must be compared with the national average for the clay products industry of 22 lost-time accidents per million man hours worked.

"Credit for the outstanding record that has been achieved must be divided equally between the workers and management," says Gene Gilmore, Gladding, McBean & Co. safety engineer. "Team work makes it possible. No one can break a safety record alone."

To better appreciate the importance of the record established, comparison must be made with the company's safety record of six years ago. At that time 96 lost-time accidents occurred per million man hours worked, with a severity rate of 5.15 days lost per thousand hours worked and an average of 173 days lost per injury.

During the period in which the record was established, more than 280 thousand tons of finished products passed through the company's four record-breaking Southern Division plants. Superintendents Homer Dye at the Glendale plant, Jack Fletcher at the Los Angeles plant, Ben Taylor at the South Gate plant and Malcolm Post at the Santa Monica plant have worked closely with their crews to incorporate every precautionary measure in their operation to insure the safety of everyone concerned.

During the last five years Gladding, McBean & Co. has made an all-out effort to better its safety record and to make every person in the company conscious of the need for safe work habits. Realization of the success of the joint efforts of employees and management came in 1946 and 1947, when the company won the National Safety Council First Place Safety Award for the entire ceramic industry. In the Southern California Industrial Safety Contest in 1949, the Santa Monica and South Gate plants won First Place with perfect records in each plant, and the Glendale plant won Second Place in their classification. In the same contest the Los Angeles plant earned an over all contest award for making the greatest improvement in its safety record. Because of their fine record, the four plants entered the 1950 contest with a handicap, and still won an award.



# American Institute



# of Architects

Ralph Walker, president  
Glenn Stanton, 1st vice president  
Kenneth E. Wischmeyer, 2nd vice president  
Clair W. Ditchy, secretary  
Charles F. Cellarius, treasurer

#### Arizona Chapter:

Edward L. Varney, President; Ralph B. Haver, Secretary,  
35 W. Oregon Street, Phoenix, Arizona.

#### Central Valley of California:

William Koblik, President; Gordon Stafford, Vice-President;  
John W. Bomberger, Secretary; Albert B. Thomas, Treasurer,  
Secretary's Offices P. O. Box 1943, Modesto.

#### Coast Valleys Chapter:

Wm. Hempel, President; Lawrence Gentry, Vice-President;  
Walter Stromquist, Sec.-Treas. Directors, Chas. Butler and  
Thos. S. Elston, Office, 267 State Street, Los Altos.

#### Colorado Chapter:

Henry J. Van Wyl, President; Charles H. Overholt, Secretary,  
2509 W. 36th Avenue, Denver, Colorado.

#### National Headquarters —

1741 New York Avenue, N. W.  
Washington 6, D. C.

Edmund R. Purves

Executive Secretary

#### Northern California Chapter:

Ralph N. Fallack, President; Francis J. McCarthy, Vice-  
President; William B. McCormick, Secretary; George A.  
Downs, Treasurer, Offices 363 Pine St. San Francisco.

#### Oregon Chapter:

Heriman Brookman, President; Donald J. Stewart, Vice-  
President; Raymond Kermit Thompson, Secretary; Millard  
H. Schmeer, Jr., Treasurer, Secretary's office 423 S. W. 4th  
Avenue, Portland.

#### Pasadena Chapter (California):

Burton Bomberger, President; Georgius Y. Cannon, Vice-  
President; Donald E. Neptune, Treasurer; William H. Taylor,  
Secretary, Directors: Boyd E. Georaj, Roland E. Coate,  
Edwin Westberg and Robert H. Ainsworth, Office 1041 E.  
Green St., Pasadena.

## SMALL HOUSING SEMINAR BY THE SOUTHERN CALIFORNIA CHAPTER A.I.A.

Under the direction of Robert H. Thomas, Chairman of the Chapter's Education Committee and George D. Riddle, Chairman of the Committee for Collaboration with the N.A.H.B., a SEMINAR is being held the third Tuesday of each month on a subject directly connected with the broad subject of "Housing".

The first program, held in February, was devoted to The Builder Viewpoint; the second, March 20 was devoted to a consideration of The Superin-

tendents Problems; April 17 the subject will be "Land Planning for Small Homes Projects"; May 15, "Mortgage Lending Practice" will be discussed and on June 19, the final Seminar meeting will be devoted to the subject of "Economics of Office Practice".

## WASHINGTON STATE CHAPTER

Senate Bill 18, more specifically known as the Architects' Registration Law, has been approved by the Senate Judiciary Committee and is in the hands of the Senate Rules Committee awaiting further action.

The Joint Conference on School Architecture, scheduled for March 30-31 at the University of Washington, will bring together top notch educators and school superintendents and results of the conference should be extremely valuable in future school architecture relations.

The Ordinance Committee is seeking proposed changes in the City of Seattle Building Code. Revisions of the present Code provisions and member suggestions for additions are being considered by the Committee.

NEW MEMBER: James W. Wilson, Junior Associate; and Howard F. Overman, Student Associate.

## NORTHERN CALIFORNIA CHAPTER

The regular February meeting was a joint meeting of the membership of the East Bay Chapter, Central Valley of California Chapter, San Joaquin Chapter and the Coast Counties Chapter at which President Ralph Walker of the A.I.A. was the principal speaker.

Held in the Palace Hotel, San Francisco, it was one of the largest gatherings of architects and allied interests outside of an annual architectural meeting.

The San Francisco Art Commission recently presented "Awards of Honor" to architects Wil-

Remember it's

**KRAFTILE**

for **GLAZED STRUCTURAL WALL UNITS**

**PATIO TILE**

**SWIMMING POOL OVERFLOW**

**GUTTER**

**QUARRY TILE**

**FACE AND ROMAN BRICK**

**ACID BRICK**

**BRICKETTES**

**MINWAX TILE & CONCRETE**

**FLOOR FINISH**

**STRAN-STEEL FRAMING**

**QUONSET BUILDINGS**

For complete information and prompt service, phone or write

**KRAFTILE COMPANY**

NILES, CALIFORNIA

NILES 3611

SAN FRANCISCO 5: 50 Hawthorne St. — DOugles 2-3780

LOS ANGELES 13: 406 South Main Street — MUJival 7241

**East Bay Chapter:**

James H. Anderson, President; Loy Chamberlain, Vice-President; William Corlett, Secretary; Chester Treichel, Treasurer. Office c/o Sec., Bank of America Bldg., Oakland.

**Montana Chapter:**

Orr Pickering, President; H. C. Cheever, Secretary, Montana State College, Bozeman, Montana.

**Nevada Chapter:**

George L. F. O'Brian, President; Aloysius McDonald, Vice-President; Graham Erskine, Secretary; Edward S. Parsons, Treasurer. Offices 180 Chestnut St., Reno.

**Nevada State Board of Architects:**

L. A. Ferris, President, Reno; Walter Zick, Secretary, Las Vegas; Directors, Aloysius MacDonald, Las Vegas; Russell Mills and Edward Corsons, Reno. Office, P. O. Box 2107, Las Vegas, Nevada.

**San Diego Chapter:**

George C. Hotal, President; Jack R. Lewis, Vice-President; Louis A. Dean, Secretary; Donald Campbell, Treasurer; Directors, C. J. Paderewski, Walter C. See, Louis H. Badmer, and Wm. Templeton Johnson. Offices Suite 206 Fifth Avenue Building.

**San Joaquin Chapter (California)**

Fred L. Swartz, President, Fresno; Lloyd J. Fletcher, Vice President, Visalia; Walter Wagner, Secretary, Fresno; Robert W. Stevens, Treasurer, Fresno. Directors: Aicstain Simpson, William D. Coats, William F. Baxter, Maurice J. Metz, Delegate California Council of Architects. Office, Sec. Fulton-Fresno Bldg.

**Santa Barbara Chapter (California):**

Robert I. Hoyt, President; Harold E. Burket, Vice-President; Roy W. Chasman, Secretary; Lutah M. Riggs, Treasurer. Address, 242 San Marcos Bldg.

**Southern California Chapter:**

John J. Landon, President; Chas. Frey, Vice-President; C. Day Woodford, Secretary; Wm. G. Boich, Treasurer, Directors, Paul C. Davis, Henry Wrisht, John Rex, and Kemper Nomiand. Chapter Headquarters, 3757 Wilshire Blvd., Los Angeles 5.

**Spokane Chapter:**

Richard H. Eddy, President; Harry C. Weller, Vice-President 1; Kenneth D. Sturmont, Vice-President 2; Victor L. Wulff, Secretary, and Carl Johnson, Treasurer. Office 1023 W. Riverside Ave., Spokane, Washington.

**Utah Chapter:**

Howell G. Cannon, President; William J. Monroe, Jr., Secretary, 3707 South 32nd West Street, Salt Lake City 7, Utah.

**Washington State Chapter:**

Perry B. Johnson, President; Paul Thiry, 1st Vice-President; Thomas F. Harris, Jr., 2nd Vice-President; John S. Deltie, Secretary; Lawrence G. Waldron, Treasurer. Office 714 American Bldg., Seattle 4.

**Tacoma Society:**

E. N. Dugan, President; P. G. Ball, Vice-President; Lyle Swedberg, Secretary-Treasurer.

**Hawaii Chapter:**

James C. Simms, President; Alfred Preis, Secretary, 1507 Kapiolani Blvd., Honolulu, T. H.

**CALIFORNIA COUNCIL OF ARCHITECTS**

Frank W. Mayo, President; Frederick A. Chase, Executive Secretary, Office, 3757 Wilshire Blvd., Los Angeles 5.

**OTHER ARCHITECTURAL ORGANIZATIONS****San Francisco Architectural Club:**

Alfred T. Kirkeveid, President; Charles Dennis, Vice President; William C. Theleman, Treasurer; Milton Bromberg, Secretary. Office 507 Howard Street.

liam W. Wurster and Gardner A. Daily and (post-humously) to architect Timothy Plueger for "long and distinguished service to the Community".

Architect John P. Rodgers, partner in the architectural firm of Skidmore, Owings and Merrill, has been appointed to the San Francisco Art Commission to fill the unexpired five-year term of Ernest Born, resigned.

## REX IS ELECTED PRESIDENT OF THE CALIFORNIA COUNCIL OF ARCHITECTS

John L. Rex, well known member of the southern California architectural firm of Summer Spaulding-John Rex in Los Angeles, was unanimously elected President of the California Council of Architects at the recent annual meeting of the Council in San Francisco.

Rex has long been identified with the architectural profession, engineering and construction industry, and civic activities throughout southern California. He has been particularly active in the work of the Southern California Chapter of the American Institute of Architects and has been prominent in developing a better public understanding of the architect in public and private construction.

Other officers elected for the ensuing year included: William Koblik, Vice-president, and Maurice J. Metz, Secretary-Treasurer.

## SAN FRANCISCO ARCHITECTURE CLUB ANNOUNCES SPRING SEMINAR

The San Francisco Architectural Club is again offering an architectural seminar, or review course,

for those who plan to take the examination of the California State Board of Architectural Examiners this year. The Seminar will consist of two lectures given by well qualified men of the architectural and engineering profession and will cover all the divisions of the examination. Each lecture will last about two hours and will be held once each week.

Subjects to be covered include: Design and Supervision on Mechanical Equipment I, II, III, and IV; Architectural History, I, II, III, and IV; Materials and Specifications; Architectural Engineering, I, II, III, IV, V, VI, and VII; Architectural Practice and Supervision, I and II; Architectural Planning; and Architectural Design.

Included in the special group of instructors are: Clyde E. Bentley, Consulting Engineer; Leo E. Dwyer, Mechanical Engineer; Felix Rosenthan, M. A. (arch); Michael J. Sweeney, Architect; George A. Sedgwick, Civil and Structural Engineer; Clyde F. Trudell, Architect; George A. Downs, Architect; and Michael Goodman, Architect.

The San Francisco Architectural Club, founded in 1901 is celebrating its Golden Anniversary this year.

## SOUTHERN CALIFORNIA CHAPTER

The second of a series of Seminars, sponsored by the Education Committee, was held March 29th on the subject THE SUPERINTENDENTS' PROBLEMS. Taking part in the program were Andy Marland, Construction Superintendent at Panorama Community Homes; David C. Slipper, Technical Director of Kaiser Homes; and John Stewart, Superintendent of Construction of Aetna Construction Company, Lakewood Homes. The Seminar has been designed around the theme "SUBDIVISION HOUSING".

The regular March meeting was devoted to a

(See Page 35)



**JOHN REX**  
President

# WITH THE ENGINEERS

## Structural Engineers Association of Northern California

John E. Rinne, President; John J. Gould, Vice-President; Wm. W. Brewer, Sec.; Franklin P. Ulrich, Treas.; Directors, Walter L. Dickey, Leslie W. Graham, Hyman Rosenthal, and Howard A. Schirmer.

## Structural Engineers Association of Central California

William H. Petersen, President; Walter S. Wasum, Vice President; O. T. Illerich, Sec. Treas.; Ernest D. Francis, M. A. Ewing, and Arthur A. Sauer, directors. Office O. T. Illerich, c/o Div. of Arch., Sacramento.

## American Society of C. E. San Francisco Section

A. W. Earl, President; G. B. Woodruff, Vice President; C. T. Wiskocil, Vice President; R. D. Dewell, Secretary-Treasurer. Secretary's Office, 604 Mission Street, San Francisco.

## Structural Engineers Association of Southern California

Donald F. Skugart, President; Harold P. King, Vice President; Robert J. Short, sec. Treas.; Directors, William T. Wheeler, William T. Wright, Ernest C. Hillman, Jr., John Case, and John K. Minasian. Office, 202 Architects Bldg., Los Angeles 13.

## Structural Engineers Association of Oregon

R. Evan Kennedy, President; Guy H. Taylor, Vice President; James R. Griffith, Secretary-Treasurer; Directors, Jerome A. McDewitt, H. Loren Thompson, and Robert L. Tidboll. Offices, Portland.

## Puget Sound Engineering Council (Washington)

R. E. Kister, A. I. E. E., Chairman; E. R. McMillan, A. S. C. E., Vice Chairman; L. B. Cooper, A. S. M. E., Secretary; A. E. Nickerson, I. E. S., Treasurer. Offices, L. B. Cooper, c/a University of Washington, Seattle 5, Washington.

## STRUCTURAL ENGINEERS ASSOCIATION NORTHERN CALIFORNIA

"Timber as a Material of Construction" was the subject of a talk by L. J. Markwardt of the U. S. Forestry Products Laboratory and president of the A.S.T.M., at the regular March meeting.

Attendance at the gathering included Bay Area members of the American Society for Testing Materials.

Committee appointments for 1951 include: John J. Gould, Advisory; Charles C. Scurich, Attendance and Reception; Kai Theill, Consulting Practice;

Byron L. Nishkian, Emergency; Frank E. McClure, Junior Activities; Jesse Rosenthal, Legislative; Charles DeMaria, Professional Guidance; Allan M. Chambliss, Professional Welfare; Harry B. Corlett, Program; George A. Sedgewick, Publications; Edward F. McKeon, Public Relations; and Wesley T. Hayes, Research.

NEW MEMBERS: Robert G. Todd has become a Junior Member, and T. W. Pickthall an Affiliate.

## SACRAMENTO SECTION ELECTRICAL ENGINEERS INSPECT POWER PLANTS

Members of the Sacramento section of the American Institute of Electrical Engineers inspected Central Valley Project irrigation and power features at Walnut Grove and Tracy recently.

Oscar G. Boden of the U. S. Bureau of Reclamation, gave an on-site explanation of the projects at the headworks of the Delta Cross Channel, the link between the Sacramento River and the Tracy Pumping Plant, and at the Tracy switchyard, which is the focal point of the three Shasta-Tracy transmission lines, and the six giant pump installations.

Reclamation officials making the tour included Boden, B. P. Bellport, Assistant Construction Engineer; J. R. Granger, resident engineer for the pumping plant, and Carl H. Kadie, Jr., of Stockton, district manager of Reclamation's Delta District.

The Sacramento group was headed by George A. Fleming, Chairman of the Section.

## STRUCTURAL ENGINEERS ASSOCIATION SOUTHERN CALIFORNIA

The March meeting was devoted to a technical discussion on the subject "Tilt-up Construction" and included an analysis by Tom Collins of the report given to the American Concrete Institute. Another feature was the showing of a motion picture entitled "Trees and Homes" which was prepared and presented by the Weyerhaeuser Lumber Company.



Always  
Specify  
**HAWS**  
for Highest Quality

A complete line of fountains, electric water coolers, faucets, filters and accessories. • Individual or multiple installations. • A reputation for reliability since 1909. • Check in Sweet's or write for complete HAWS catalog.

**HAWS DRINKING FAUCET CO.**

1441 FOURTH STREET (Since 1909) BERKELEY 10, CALIFORNIA  
Agents and Sales Representatives in All Principal Cities

L. K. Osborn, Chairman of the Publications Committee reported material for the 1951 Yearbook was being compiled and the book would soon be in the hands of the printer.

An unusually large number of applications for membership were received since the first of the new year.

#### UNIVERSITY OF COLORADO SCHEDULES NEW COURSES

The College of Engineering at the University of Colorado at Boulder, will conduct an intensive training course in Statistical Quality Control from June 19-29.

The course will include acceptance sampling and other industrial statistical methods used in industry.

John F. Wagner, Assistant Professor of Applied Mathematics, will be in charge of the course. Instructors will be men who have had experience both in the teaching of this technique and its application in industry and business.

#### AMERICAN SOCIETY OF C. E. MEET IN HOUSTON TEXAS

Air transport, construction, highways, irrigation, and other subjects affecting the southwest were discussed at a recent meeting of the American Society of Civil Engineers in Houston, Texas, at which more than 1500 experts in these fields of civil engineering attended.

In addition to 19 technical division meetings, at which projects and problems of primary interest to the southwest were discussed, there were a number of general sessions, social functions and excursions of engineering and historic interest.

Preceding the Convention, members of the Board of Directors and members of the Society's national headquarters in New York, met in a pre-convention conference.

Sections of the organization represented at the convention included Alabama, Florida, Georgia, Louisiana, Mexico, Mid-South, Miami, New Mexico, Oklahoma, South Carolina, and Texas.

#### APPOINTED DISTRICT MANAGER BUREAU OF RECLAMATION

Marshall Jones, Bureau of Reclamation engineer with wide experience in the field of water conservation, most of which was spent in the Central Valley Basin of California, has been appointed district manager of the Bureau's Sacramento Valley District, succeeding James K. Carr, who has been transferred to the Washington, D. C. office.

Jones will supervise operation of existing Reclamation features in the area, including Shasta and Keswick dams and power plants, and the Orland irrigation project. He will also have charge

of the recently authorized Sacramento River canal projects and will direct a study of proposed Trinity and Feather River units of the Central Valley Project.

The Sacramento Valley District includes all of the valley floor north of Woodland, and the drainage area of the Trinity, Sacramento, Feather, Yuba and Bear Rivers.

#### ELECTRICAL ENGINEERS OF SAN FRANCISCO VISIT TRACY

Members of the San Francisco Section of the American Institute of Electrical Engineers, recently inspected the Tracy Pumping Plant of the Central Valley Project and world's second largest irrigation lift.

The trip was made in conjunction with a tour of the project by members of the Sacramento Section of the Institute, and was in charge of officials of the Bureau of Reclamation.

#### BAY AREA FEMINEERS

The FEMINEERS, representing the wives of Bay Area engineers, staged a most successful Valentine Dinner Party on Saturday, February 17th.

Arrangements were in charge of Mrs. Ed McKeon of San Francisco.

**Always specify**  
**HAWS**  
**for Highest Quality**



**HAWS Electric Water Coolers** easily adapt to remote installations of HAWS Drinking Fountains... thus serving several locations.

• A COMPLETE LINE of coolers, fountains, faucets, equipment, filters and accessories. • A reputation for reliability since 1909. • Check in Sweets, or write for complete HAWS catalog.

**HAWS DRINKING FAUCET CO.**  
1441 FOURTH STREET (Since 1909) BERKELEY 10, CALIFORNIA  
Agents and Sales Representatives in All Principal Cities



# PRODUCER'S COUNCIL PAGE

The National Organization of Manufacturers of Quality Building Materials and Equipment  
affiliated with THE AMERICAN INSTITUTE OF ARCHITECTS

President, Arthur C. Staat  
Natural Gas Equipment, Inc.  
1150 Folsom Street

Vice-President, Fred A. Figone  
Otis Elevator Company  
1 Beach Street

Secretary, Howard Noleen  
E. F. Heuserman Company  
509 Second Street

Treasurer, A. L. West, Jr.  
Aluminum Company of America  
Russ Bldg.

Edited by Carl E. Frank, DETROIT STEEL PRODUCTS CO.

## INTRODUCTION

We have decided to use the Architect and Engineer as a medium for introduction of some of our newer members of the profession. We take pleasure this month in introducing M. A. L. West, Jr., of the Aluminum Company of America. Al studied business administration at Johns-Hopkins University in Baltimore, Maryland, moving on to aeronautical engineering at Curtis-Wright Tech in Glendale, California. He was employed at both Douglas and Lockheed Aircraft Companies prior to 1942 and left to serve in the Navy Aviation Supply Office in Philadelphia from 1942 to 1946. After his discharge from the Navy, he joined the Aluminum Company of America in 1946 and was located in



A. L. WEST, JR.  
Aluminum Co. of America

the Baltimore, Maryland, sales office prior to his transfer to the San Francisco sales office as an architectural sales representative in 1950. In this capacity, he promotes raw materials as well as working in conjunction with the various aluminum fabricators to promote their particular products. You might possibly wonder why a fellow who started in the aviation design section of a large company such as Douglas or Lockheed, would wind up in this particular business, however, I have been told that the structural application of aluminum in the construction industry is very similar in principal to that of the aircraft industry.

Al has been very active in The Producers' Council chapter since joining in 1950 and makes a fine stable-mate for Art Staat as treasurer of the Council for 1951. Knowing what a hard worker Al is,

you might know that he would be the one to come up with the only decent paying job in the program.

## MARCH MEETING

The E. L. Bruce Company, Inc., is handling our March program which promises to be an interesting one as they are sponsoring a film entitled "Southern Hardwood—Yours Forever." This film is in Technicolor and is a sound production put out by the Southern Hardwood Lumber Producers Association. The program will be conducted by Bob Mathis of the Bruce Company.

## EDUCATIONAL COMMITTEE

A couple of issues back, we told you about our new educational committee which is being chaired by Herb Duncan of Natural Gas Equipment Company, and we are pleased to announce that three very successful meetings have been held with a student attendance of somewhere between 50 and 60. The latest film "White Magic" was put out by the U. S. Gypsum Company. This film was secured for Herb by Ken Pinney of F. K. Pinney, Inc.

## COUNCIL SPONSORS AWARD

In line with our program at the University of California, we decided at the last meeting to sponsor a fifty dollar (\$50.00) book award to a qualifying member of the senior class each year. This award will be presented during the June graduation ceremonies, and the student recipient will be one selected by a committee from the School of Architecture at the University, which will be headed up by Professor Jory. Although definite plans have not been made at this writing, it appears that this award will go to the outstanding architectural student in the senior class. We feel that the whole program, both educational films and the award, will be a big step forward in acquainting the fledgling architects with the practical side of the profession.

USE QUALITY PRODUCTS



CONSULT AN ARCHITECT

## NATIONAL ASSOCIATION OF HOME BUILDERS ELECT

W. P. Atkinson of Midwest City, was elected president of the National Association of Home Builders of the United States at the organization's recent annual meeting in Chicago. Alan E. Brockbank of Salt Lake City was named 1st vice-president; Emanuel M. Spiegel of New Brunswick was named 2nd vice-president; Nathan Manilow of Chicago was re-elected treasurer, and R. G. Hughes of Pampa was named secretary.

Among the Regional vice presidents named to serve the organization for 1951 were: C. Taylor Burton, Salt Lake City; Marcus C. Bogue, Denver; Samuel Anderson, Seattle; Nels Severin, San Diego; Dale Bellamah, Albuquerque; and Niels Schultz of San Rafael.

Milton Morris of San Francisco was named to the Executive Officers' Council.

More than 16,000 of the nation's home builders attended the convention.

## LARGE SHIPMENT OF MARBLE ARRIVES AT SAN FRANCISCO

One of the largest single shipments of imported marble from Europe to reach San Francisco in over twenty-five years, was recently unloaded from the SS. President Johnson for the Vermont Marble Company, pioneer marble dealer of the West Coast.

The shipment consisted of Roman Travertine quarry blocks and required ten freight cars to transport from the dock to the Company's plant.

Roman Travertine is the type of marble that has been used extensively in the new Standard Oil Building in San Francisco, the new Pacific Telephone & Telegraph Company building in Oakland, and the Holy Cross Mausoleum at Colma.

## ATTEND CLAY PIPE CONFERENCE

More than 100 manufacturers of vitrified clay pipe from all sections of the nation met in Chicago early in March for the annual meeting of the National Clay Pipe Manufacturers, Inc.

Among those in attendance was John D. Fredericks, president of Pacific Clay Products, Los Angeles, and president of Pacific Coast Clay Products Institute; and E. M. Davids, vice president of Gladding, McBean & Co., Los Angeles, and chairman of the research committee of the national association. J. J. Stein, secretary-manager of the Pacific Coast Clay Products Institute also attended.

## OPENS SAN FRANCISCO OFFICE

The American Air Filter Company, Inc., has opened offices at 225 Bush Street, San Francisco, in charge of E. C. Sanford.



The Pioneers  
Have Long Since Gone

When it comes to electrical home wiring, well-blazed is the trail to Better Living. Many contractors, builders and architects have travelled here.

And now they are basking in the warm sunshine of happy, proud clients and great prestige.

Everyone knows that CERTIFIED ADEQUATE WIRING—assuring, as it does, plenty of outlets, switches, lights, circuits, heavy enough wire and a large enough service entrance—is the sort of wiring today's home demands. Modern electrical living with its dozens of busy electrical servants is hardly possible at all without modern wiring.

Are you following the well-blazed trail to Better Living for yourself and your clients? Do you always specify CERTIFIED ADEQUATE WIRING for new and remodelling home plans. The smart pioneers went . . . thataway!

*Northern California Electrical Bureau*  
1355 MARKET STREET - SAN FRANCISCO - 3

The trend is to **QUALITY**  
in lighting equipment

ILLUMINATION EQUIPMENT  
**SMOOT-HOLMAN**  
INGLEDWOOD, CALIFORNIA  
EST. 1931

—MEANS  
TOP  
QUALITY  
ALWAYS!

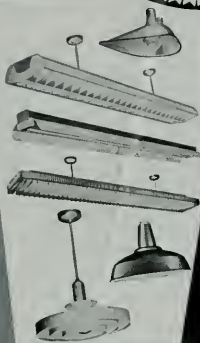

**new**

This is the new new best Ceiling-Lite designed to comply with latest Underwriters Laboratories requirements effective January 3, 1951. Made in these sizes—  
No. LH-1101—10" glass  
No. LH-1112—12" glass  
No. LH-1113—14" glass  
No. LH-1114—16" glass  
No. LH-1115—18" glass

**SMOOT-HOLMAN COMPANY** Inglewood, Calif. Offices in Principal Western Cities • Branch and Warehouse in San Francisco

## CONSTRUCTION INDUSTRY—AGC

(From Page 8)

Defense construction: 44 per cent report that defense construction will fill the gap made by emergency controls. 44 per cent report that defense construction will not fill the gap, and 16 per cent are uncertain.

Local changes in contract procedures: 54 per cent report no changes being made at present. 46 per cent report one or more changes. Of the total number of replies for this division, 13 per cent report termination clauses appearing; 8 per cent report escalator clauses; 4 per cent report cost-plus-a-fixed-fee contracts being used; and 8 per cent report contracts being negotiated.

Labor supply: 31 per cent report a shortage of labor. 69 per cent report no shortage.

Materials: 27 per cent report shortages of materials. 19 per cent report a shortage of steel; 19 per cent report a shortage of metals; and 8 per cent report a shortage of cement. 73 per cent report no shortage.

Equipment and repair parts: 65 per cent report shortages of equipment. 35 per cent report no shortages of equipment. 73 per cent report shortages of repair parts. 27 per cent report no shortages of repair parts.

Regulations of construction and materials: 86 per cent report members are observing regulations. 14 per cent are uncertain.

### Divisions Compared

Construction activity is least among highway contractors who also report present indications are that defense construction will make no substantial increase in highway work. These facts are most noteworthy in the light of recent statements by public officials that good roads are essential to a good defense program. Many highway contractors indicate that present and future projects do not even encompass a reasonable amount of repair and maintenance work.

The three divisions have similar, slight shortages of labor. Materials are reasonably adequate in only the heavy division. Building contractors who are most active at this time are feeling a pronounced shortage of metals. Highway contractors, despite their relative inactivity, have the most shortages of materials, principally steel items.

Building contractors, though the busiest, have the least shortage of equipment and repair parts. This is not unusual, however, as their equipment requirements are relatively less. Highway and heavy contractors have rather serious shortages of equipment and repair parts with the shortage of parts for highway machinery becoming acute.

One constant factor which must be included in a proper analysis of this survey is the fact that the construction industry is now in its slack season.



## A Combined

Landscape Architecture  
and Contracting Service

for

Tract, Industrial and Residential  
Development

We can do the Complete Job for you

- Landscape Architecture
- Finish Grading and Landscaping
- Asphalt Drives and Parking Lots
- Chain Link Fencing

**HENRY C. SOTO CORPORATION**

*Landscape Contractors*

13000 SO. AVALON BLVD. LOS ANGELES 61, CALIF.

Phone MElo 4-6617

## A.I.A. ACTIVITIES

(From Page 29)

consideration of "Lighting for Better Living" and was a joint meeting with the Illuminating Engineers Association. Speaker was Walter Sturrock, National President of the Illuminating Engineers Association and Director of Technical Publication on lighting for General Electric Company. Also speaking on the subject of "light sources" point, line, area, was J. S. Hamel, consulting engineer, and Maynard Lyndon, architect.

## SAN FERNANDO VALLEY ARCHITECTS SCHEDULE PUBLIC FORUMS

Stanley A. Moe, president of the Architects of San Fernando Valley, has announced plans for the Valley Planning Institute, a non profit, public service organization dedicated to the future growth and development of the San Fernando Valley.

A series of public forums on various problems of development, planning and construction as related to the model community, will be held.

Moderator for the panels will be James H. Raport, former professor of community organization and recreation at Alabama Polytechnic Institute.

## CALIFORNIA COUNCIL OF ARCHITECTS

The regular February meeting of the Council was held in San Francisco on February 23-24, in conjunction with the visit of Ralph Walker, President of the A.I.A. to the Pacific Coast. Meetings of the Education and Research Committees and Governmental Relations Committee were held at the same time.

Presided over by Frank Mayo, Stockton, consideration was given to a number of Council activities, committee reports and the adoption of a set of by-laws.

## WOMENS ARCHITECTURAL LEAGUE OF SAN FRANCISCO

Mrs. Wendell Spackman has been appointed to head a special committee to work with the Northern California Chapter, A.I.A. on Bay Area Architecture of Note.

The joint committee will compile a list of noteworthy and historical examples of architecture in the Bay Area.

## WASHINGTON ARCHITECT HONORED

Joseph Greer, Jr., Junior Associate member of the Washington State Chapter of the A.I.A., has been named Chief Design Engineer of the American Command in Paris, France.

Greer, graduated from the University of Washington, class of 1950.

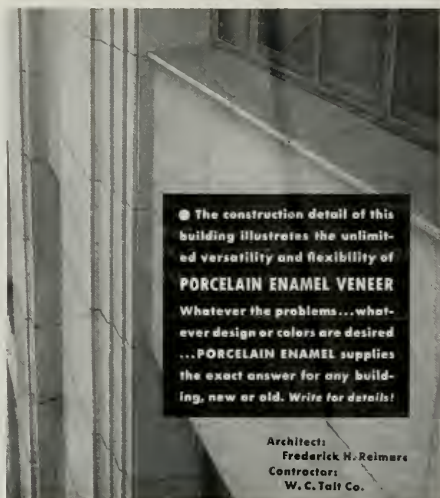

● The construction detail of this building illustrates the unlimited versatility and flexibility of **PORCELAIN ENAMEL VENEER**. Whatever the problems... whatever design or colors are desired... **PORCELAIN ENAMEL** supplies the exact answer for any building, new or old. Write for details!

Architect: Frederick H. Reimann  
Contractor: W. C. Tait Co.

## Architectural Division

**PORCELAIN ENAMEL PUBLICITY BUREAU**  
P. O. BOX 186, EAST PASADENA STATION, PASADENA 8, CALIFORNIA;  
ROOM 601, FRANKLIN BUILDING, OAKLAND 12, CALIFORNIA

**WILL OUTLAST YOUR BUILDINGS**



**NEW STANLEY "Full-Jeweled" ball bearing butt hinge**

takes both lateral and vertical thrust

The Stanley Works  
New Britain, Connecticut

**STANLEY**

Reg. U. S. Pat. Off.

**HARDWARE • TOOLS • ELECTRIC TOOLS  
STEEL STRAPPING • STEEL**



# HOGAN LUMBER CO.

Wholesale and Retail

## LUMBER

MILL WORK • SASH & DOORS

Office, Mill, Yard and Docks  
SECOND AND ALICE STREETS • OAKLAND, CALIF.

Telephone GLencourt 1-6861



**PROTECTIVE BUILDING PAPER...**  
**WATERPROOF, REINFORCED... USED AS SHEATHING PAPER, PROVIDES LIFE-LONG PROTECTION FROM ENTRY OF WIND, DUST AND MOISTURE. IDEAL FOR STUCCO-BACK, OVER SUBFILL, CONCRETE CURING, UNDER FLOORING, etc. Write for samples and complete data.**

**The SISALKRAFT CO.**

55 New Montgomery St. San Francisco 5, California

## JUDSON PACIFIC-MURPHY CORP.

Steel Fabricators  
and  
Erectors

REINFORCING STEEL  
STRUCTURAL STEEL  
BRIDGE CRANES

4300 EASTSHORE HWY.  
EMERYVILLE, CALIF.

Phone:  
OL 3-1717

## CLINTON CONSTRUCTION CO. OF CALIFORNIA

**General Contractors**

923 FOLSOM STREET • SAN FRANCISCO

SUtter 1-3440

## BOOK REVIEWS PAMPHLETS AND CATALOGUES

### EARTHQUAKE RESISTANT DESIGN OF BUILDINGS, STRUCTURES, AND TANK TOWERS. By H. M. Engle & John E. Shield. Pacific Fire Rating Bureau. San Francisco.

The pamphlet, prepared by H. M. Engle and John E. Shield, Consulting Civil and Structural Engineers for the Pacific Fire Rating Bureau, is intended as a supplement to, and explanation of the Earthquake Tariff of the Pacific Fire Rating Bureau, and is for the use of those who, in designing new buildings and structures, wish to take advantage of the Special Rate provisions in the Bureau's Earthquake Tariff.

Many illustrations and drawings are used showing effect of earthquakes on the Pacific Slope. Distribution of the booklet is limited to those directly engaged in the design of structures.

### COFFER DAMS. Second Edition Revised and Enlarged. By Lazarus White & Edmund Astley Prentis. Columbia University Press, New York City, N. Y. Price \$10.00.

The authors, eminent engineers and contractors whose entire professional careers have been spent in the design and execution of difficult engineering works, make readily accessible the essentials of scientific cofferdam design and construction—in concise and practical form.

Presentation is made of theoretical consideration of hydrodynamics of seepage forces, stream erosion, and lateral earth pressures for cofferdams on land and in water. Actual design and construction features are presented by detailed case studies of cofferdams which have come under the authors' supervision. Construction equipment, pumping stations, sheet-piling of wood and steel, bracing systems, excavation methods are among the features described.

Many photographs and drawings are included together with a glossary of terms and bibliography.

### FUNDAMENTALS OF ACOUSTICS. By Lawrence E. Kinsler & Austin R. Frey. John Wiley & Sons, Inc., New York City, N. Y. Price \$6.00.

This book presents in clear and concise form the basic facts about the generation, transmission and reception of acoustic waves. The first nine chapters provide an analysis of the various types of vibration of sound waves through fluid media. The other seven chapters are concerned with a number of applications of acoustics. Topics included are direct radiator loudspeakers, horn-type loudspeakers, microphones, psycho-acoustics, architectural acoustics, underwater acoustics, and ultrasonics.

The authors are recognized authorities in their field and at present are on the staff of the Naval Postgraduate School.

### NEW CATALOGUES AVAILABLE

Any of the catalogues or folders described here may be obtained by forwarding your request as indicated in the coupon below to the office of the ARCHITECT & ENGINEER. Merely mark the items you want and clip or paste the coupon to your letterhead.

**258. MILLS MOVABLE METAL WALLS.** Catalog No. 51. A 48-page book of practical facts for architects, builders, contractors, building owners, and managers . . . in fact everyone interested with the problem of meeting consistently changing space requirements in offices, factories, schools, hospitals, laboratories, commercial, industrial and institutional buildings of every type will find this catalog very informative. The content is based upon more than 30 years experience in the design and manufacture of flexible interiors. Construction details are covered with clear, easily interpreted drawings. 3/51.

**259. MEET TRUCKS ON THE LEVEL.** Full information on adjustable loading docks, which speed up freight handling and mechanize loading operations is given in a new two-color folder. The bulletin shows present models of specialized equipment with photographs of typical installations. A complete discussion of the advantages of adjustable loading docks, including savings in dock space, handling time, labor and breakage. Design and construction features are included. 3/51.

**260. OIL BURNER PRODUCTS.** A new condensed 16-page catalog in color, has been made available to architects, engineers, and contractors by a West Coast manufacturer. The catalog gives a complete listing with illustrations of fully automatic horizontal rotary type; steam turbine driven type;

combination gas-oil type; semi-automatic type, and pressure atomizing type. Booklet also features a unique selector chart, plus listing of specifications and capacities, and will prove particularly helpful where additional installation knowledge is required before ordering oil burner equipment. Operation and control of each unit is described in detail. 3/51.

**261. BLOWER TYPE COOLING TOWERS.** Mid-western manufacturer has issued two pamphlets on their new and improved dry-lan type cooling tower. One model is a single fan type available in 9 sizes, with capacities ranging from 3 to 30 tons of refrigeration. The smallest tower in this series is 2x2x6 ft. and the largest is 6x6x6'6" ft., and all are compact highly efficient, and exceptionally quiet. Air enters towers through a squirrel cage type fan at bottom of tower and is exhausted through redwood drift eliminators at top. Smaller models are shipped completely assembled, larger towers are knocked down with complete instructions for easy and quick assembly. Another model in 4 sizes with capacity from 32 to 60 tons of refrigeration, in sizes from 4'6" x 9' x 7'6" to 6'6" x 11 x 7'6". Both towers are equipped with renewal panels for inspection of clog-proof nozzles. 3/51.

**262. HOW TO DO IT.** A new 12-page illustrated booklet explaining the proper application of all forms of Zonolite vermiculite, for architects, engineers, contractors and building supply dealers. Design data, methods and specifications outlined in this publication are the result of laboratory research and field tests made under service conditions. The booklet describes installation methods for plastic, concrete aggregate, and insulating plastic. 3/51.

**263. PENMETAL METAL LATH AND PLASTERING ACCESSORIES.** Published, a new catalog divided into two sections; 1) full descriptions and illustrations of product and uses, 2) general data and specifications for metal lathing and plastering. Pamphlet fills a long-felt need for a metal lath catalog which includes detailed instructions and specifications for the erection of metal lath and accessories. The specifications are sufficiently detailed and complete to enable the architect to draw up from them, his final specifications on all standard type of construction where metal lath and accessories are involved. Of practical use to architects, engineers and contractors.

**264. SHELLAC—HOW TO USE IT.** An illustrated booklet full of helpful material on how to obtain the best possible finishes to wood furnishings, floors and other items requiring protective coats. Also included are the many other uses of this natural substance which has never been synthesized. The informative handbook covers furniture finishing, walls and woodwork, new and old floors among other things. It contains valuable tips in getting the best results as discovered by experts after long experience. Content of the booklet is presented in a very simple and understandable manner, no special skill is necessary to follow directions for better results. 3/51.

**265. THEATER AIR CONDITIONING.** Material written by G. E. Priester and O. W. Armspach tells the why's and wherefore's of theater air conditioning as contrasted to the store, office, or factory. Contains detailed information on inside design conditions, cooling load, outside air quantity, air circulation, required air, equipment size, location and arrangement of apparatus, selecting the type of refrigeration system, exhaust air systems, and automatic control. 3/51.

**266. SELF CLEANING WATER FILTERS.** A new six-page bulletin describes in detail a new line of filters, compactly built, self cleaning, that have been designed to filter large volumes of water and other liquids rapidly and at low cost. Using diatomaceous earth as a filter aid, the units easily meet and surpass all health requirements for purification of water for drinking purposes. The self-cleaning feature, which is completely new in its concept of design, eliminates the need for breaking the filter down for cleaning or inspection. Actual cleaning time requires only 40 to 7 minutes. Printed in color, shows several typical installations, and includes prints showing arrangements of necessary piping, and gives full specifications. 3/51.

**ARCHITECT AND ENGINEER**  
68 Post Street, San Francisco, Calif.

I would like to have a copy of each of the New Catalogues I have circled.

258      259      260      261      262  
263      264      265      266

Please send to the address on my letterhead, or as I have indicated, and to my attention. (Please print your name—no literature will be sent on this coupon after April, 1951.—A. & E.)

**The Most Complete Line of  
STEELS and STEEL BUILDING MATERIALS**  
Made by a Single Producer



See Sweet's Catalog File or write us for full information.

**REPUBLIC STEEL CORPORATION**

GENERAL OFFICES: CLEVELAND, OHIO

DENVER, COLORADO . . . . . CONTINENTAL OIL BUILDING  
LOS ANGELES, CALIF. . . . . GENERAL PETROLEUM BUILDING  
SAN FRANCISCO, CALIFORNIA . . . . . RIALTO BUILDING  
SEATTLE, WASH. . . . . WHITE-HENRY-STUART BUILDING

**PACIFIC  
MANUFACTURING CO.**

High Class Interior Finish Quality  
Millwork

16 Beale St., San Francisco  
GARfield 1-7755

2215 El Camino Real, San Mateo  
S. M. 5-0687

304 Bryant Street, Palo Alto  
P. A. 3373

2610 The Alameda, Santa Clara  
S. C. 607 (Factory)

6820 McKinley Avenue, Los Angeles  
THornwall 4196

MAIN OFFICE — SANTA CLARA

**"AMERICAN - MARSH"**  
CONDENSATION UNIT

Pumping  
Machinery  
for  
Every  
Purpose

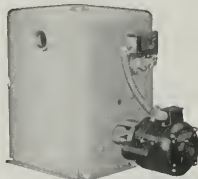

For Service  
Call  
DOuglas  
2-6794  
or  
MUtual 8322

**SIMONDS MACHINERY CO.**

SAN FRANCISCO  
816 FOLSOM

LOS ANGELES  
455 EAST 4TH

**VERMONT  
MARBLE COMPANY**

DOMESTIC AND IMPORTED MARBLES  
GRANITE VENEER

525 MARKET STREET • SAN FRANCISCO

Phone: SUtter 1-6747

3522 COUNCIL STREET • LOS ANGELES

Phone: DUUnkirk 2-7831

## FIXING OF RESPONSIBILITY

(From Page 7)

sary, to prod the construction company-insurance company partnership into necessary action. However, no matter how sincere and how well intended any such effort may be, it must be administered in the field by individuals who are engaged primarily neither in the management of the construction operation nor in the insurance protection afforded to its personnel. Having none of this primary interest, much confusion and unnecessary expense are injected into the conduct of any accident prevention program. This confusion results not only from a difference of opinion as to the interpretation of regulatory rules, but also from the different sets of rules and codes, often conflicting, which have been promulgated and injected into the area of management.

Because it means money in their pockets and because it is required by law, the partnership of management and insurance carrier is more interested in accident prevention than in other aspects of construction. Since this partnership has the greatest interest in the matter, they obtain the best experts available in the field. Accident prevention on the construction job will attain its greatest success under this partnership if properly operated and required to function to its full ability.

A construction job that has been safely managed and has produced a record of a minimum of injuries to personnel is given much publicity and those connected with the management of its accident prevention program gain thereby. That is as it should be, but remember that not all jobs can be the best job in this respect. On the contrary, the average record of a group of jobs in similar categories can and should be accepted as a criteria of a degree of excellence which an accident prevention team may attain for any particular job. Better than the average is to be commended; one below the average to be criticized and helped until its management has corrected apparent inefficiencies in this respect.

If the resident engineer on this type of construction job starts out to show the employer how to do it; if labor leaders also inject themselves into the program and instead of sitting down with management to better the situation, attempt to set up their own regulations and enforce them; if state industrial commissions, and departments and bureaus of the federal government also inject themselves into the functions of management, the result will be a failure to produce the new construction which our nation needs. Therefore, I urge all of you to give serious thought to accepting and discharging, through the management-insurance carrier partnership, the responsibilities which the industry places upon you and for which regulatory codes provide the measure of your excellence.

To those of you who may be connected with governmental agencies, with industrial commissions and with other agencies which promulgate safety but which lie outside, and perhaps above, the partnership team I suggest that you be the umpire, not the player. Sit down with the player and talk it over, to the end that he may understand which set of rules are to be followed and what those particular rules mean. Write the rules of the game, establish the scoring method, place the scoreboard in the public eye, toss the ball from the stands, get down on the field to umpire the results but let the team play the game.

## Looked into all these lately?

It's growing all the time—the list of uses for which gas is superior:

Cooking	House heating
Refrigeration	Clothes drying
Water heating	Garbage disposal
All-year air conditioning	

If your technical data files are low on any of these, why not get in touch with your Gas Company for details?

The West  
prefers

**GAS**

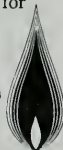

BETTER • QUICKER • CHEAPER

### SETS BUILDING RECORD

Levitt & Sons, Inc., of Long Island, set a record when they constructed 5,333 homes during the past year. More than 57,600,000 bd. ft. of lumber; 5,321,000 ft. of copper tubing for radiant heating, enough concrete to pave a sidewalk one foot wide and four inches thick from New York to Los Angeles was used in maintaining the schedule of one house every 16 minutes.

The price range of the homes was \$7,990 to \$20,000.

# ESTIMATOR'S GUIDE

## BUILDING AND CONSTRUCTION MATERIALS

PRICES GIVEN ARE FIGURING PRICES AND ARE MADE UP FROM AVERAGE QUOTATIONS FURNISHED BY MATERIAL HOUSES TO SAN FRANCISCO CONTRACTORS. 3% SALES TAX ON ALL MATERIALS BUT NOT LABOR

All prices and wages quoted are for San Francisco and the Bay District. There may be slight fluctuation of prices in the interior and southern part of the state. Freight cartage, at least, must be added in figuring country work.

**BONDS—Performance or Performance plus Labor and Material Bond(s).** \$10 per \$1000 on contract price. Labor & Material Bond(s) only, \$5.00 per \$1000 on contract price.

### BRICKWORK—MASONRY—

Common Brick—Per 1 M laid—\$100.00 up (according to class of work).  
Face Brick—Per 1 M laid—\$200.00 and up (according to class of work).  
Brick Steps—\$3.00 and up.  
Common Brick Veneer on Frame Bldgs.—Approx. \$1.20 and up (according to class of work).  
Face Brick Veneer on Frame Bldgs.—Approx. \$2.00 and up (according to class of work).  
Common Brick—\$36.00 per M—truckload lots, delivered.  
Face Brick—\$81.00 to \$106.00 per M, truckload lots, delivered.

### Glazed Structural Units—

Clear Glazed—  
2 x 4 x 12 Furring ..... \$1.60 per sq. ft.  
4 x 6 x 12 Partition ..... 1.90 per sq. ft.  
4 x 6 x 12 Double Faced ..... 2.25 per sq. ft.  
Partition ..... 30 per sq. ft.  
For colored glaze add .....

Mantel Fire Brick—\$105.00 per M—F.O.B. Pittsburg.  
Fire Brick—Per M—\$110.00 to \$147.00.  
Carriage—Approx. \$10.00 per M.  
Paving—\$75.00.

**Building Tile—**  
6 5/8" x 12-inches, per M. .... \$139.50  
6 5/8" x 12-inches, per M. .... 105.00  
4 5/8" x 12-inches, per M. .... 84.00

**Hollow Tile—**  
12x12 1/2-inches, per M. .... \$146.75  
12x12 3/4-inches, per M. .... 156.85  
12x12 3/4-inches, per M. .... 177.10  
12x12 3/4-inches, per M. .... 235.30  
F.O.B. Plant

### BUILDING PAPER & FELTS

1 ply per 1000 ft. roll ..... \$5.30  
2 ply per 1000 ft. roll ..... 7.90  
3 ply per 1000 ft. roll ..... 9.70  
Brownskin, Standard 500 ft. roll. .... 6.85  
Sisalcraft, reinforced, 36 in. by 500 ft. roll. .... 7.00

### Sheathing Papers—

Asphalt sheathing, 15-lb. roll. .... \$2.00  
30-lb. roll. .... 2.79  
Dampcourse, 21-lb. ft. roll. .... 2.95  
Blue Plyboard, 40-lb. roll. .... 5.10

### Felt Papers—

Deadening felt, 3/4-lb., 50-ft. roll. .... \$3.23  
Deadening felt, 1-lb. .... 3.79  
Asphalt roofing, 15-lb. .... 2.00  
Asphalt roofing, 30-lb. .... 2.79

### Roofing Papers—

Asphalt Rfg., 15-lb. roll, Light ..... \$2.09  
Standard Grade, 108-ft. roll, Light ..... 1.87  
Smooth Surface, Medium ..... 2.18  
Heavy ..... 2.58  
M. S. Extra Heavy ..... 2.96

### BUILDING HARDWARE—

5/8-in. cord com. No. 7 ..... \$2.65 per 100 ft.  
5/8-in. cord com. No. 8 ..... 3.00 per 100 ft.  
5/8-in. cord spot No. 7 ..... 3.45 per 100 ft.  
5/8-in. cord spot No. 8 ..... 3.35 per 100 ft.  
Sash weights, net ..... \$100.00 ton. .... \$3.75  
1-Ton lots, per 100 lbs. .... \$4.75  
Nails, per keg, base ..... \$11.80  
8-in. spikes ..... 11.80  
Rim Knob lock sets ..... 1.80  
Butts, dull brass plated on steel, 3/8x3/8 ..... .76

### CONCRETE AGGREGATES—

The following prices net to Contractors unless otherwise shown. Carload lots only.

	Bunker per ton	Del'd per ton
Gravel, all sizes	\$2.44	\$2.90
Top Sand	2.38	3.13
Concrete Mix	2.38	3.06
Crushed Rock, 1/2" to 3/4"	2.38	2.90
Crushed Rock, 3/4" to 1 1/2"	2.38	2.90
Roofing Gravel	2.81	2.90
River Sand	2.50	3.00
Sand—		
Lapis (Nos. 2 & 4)	3.56	3.94
Olympic (Nos. 1 & 2)	3.56	3.88

### Cement—

Common (all brands, paper sacks), carload lots, \$3.55 per bbl. f.o.b. car; delivered \$3.05  
Per Sack, small quantity (paper).....\$1.05  
Carload lots, in bulk per bbl. .... 2.79  
Cash discount on carload lots, 10c a bbl., 10th Prox., less than carload lots \$4.00 per bbl. f.o.b. warehouse or delivered.  
Cash discount 2% on L.C.L.

Trinity White } 1 to 100 sacks, \$3.13 sack  
Madusa White } warehouse or del.; \$9.56  
bbl. carload lots.

### CONCRETE READY-MIX—

1-2-4 mix, to 10 yards\* ..... \$12.00  
10 to 100\* yards ..... 11.00  
100 to 500 yards ..... 10.50  
Over 500 yards ..... 10.30  
\* Delivered to site.

### CONCRETE BLOCKS—

	Hay-dite	Ba-salt
4x8x16-inches each	17	18
8x8x16-inches, each	22	22.25
8x8x16-inches, each	26	26
12x8x16-inches, each	34	39
12x8x24-inches, each		60
Haydite Aggregates—		
3/4-inch to 1/2-inch, per cu. yd. ....	\$7.25	
1/2-inch to 3/8-inch, per cu. yd. ....	7.25	
No. 6 to 8-inch, per cu. yd. ....	7.25	

### DAMP-PROOFING and Waterproofing—

Two-coat work, \$9.00 per square.  
Membrane waterproofing—4 layers of saturated felt, \$10.00 per square.  
Hot coating work, \$5.00 per square.  
Medusa Waterproofing, \$3.50 per lb. San Francisco Warehouse.

Tricoat concrete waterproofing, 60c a cubic yd. and up.

### ELECTRIC WIRING—\$15 to \$20 per outlet for conduit work (including switches).

Knob and tube average \$6.00 per outlet.

### ELEVATORS—

Prices vary according to capacity, speed and type. Consult elevator companies. Average cost of installing a slow speed automatic passenger elevator in small four story apartment building, including entrance doors, about \$9,500.00.

### EXCAVATION—

Send, \$1.00; clay or shale, \$1.50 per yard. Trucks, \$30 to \$45 per day.  
Above figures are an average without water. Steam shovel work in large quantities, less; hard material, such as rock, will run considerably more.

### FIRE ESCAPES—

Stair-fan galvanized iron balcony, with steps, \$250 installed on new buildings; \$300 on old buildings.

### FLOORS—

Asphalt Tile, 1/8 in. gauge 18c to 35c per sq. ft.  
Composition Floors, such as Magnesite 50c per square foot.  
Linoleum, standard gauge, sq. yd. .... \$2.75  
Mastipave—\$1.50 per sq. yd.  
Bethleship Linoleum—1/8"—\$3.00 sq. yd.  
Terrazo Floors—\$1.50 per sq. ft.  
Terrazo Steps—\$2.50 per lin. ft.  
Mastic Wear Coat—according to type—20c to 35c.

### Hardwood Flooring—

Oak Flooring—T & G—Unfin.—  
Clear Old, White, 1 1/2" x 2 1/2" x 2 ..... \$425  
Clear Old, Red, 1 1/2" x 2 1/2" x 2 ..... 405  
Select Old, Red or White, 3/4" x 2 1/2" x 2 ..... 355  
Clear Plan., Red or White, 3/4" x 2 1/2" x 2 ..... 355  
Select Plan., Red or White, 3/4" x 2 1/2" x 2 ..... 355  
#1 Common, Red or White, 3/4" x 2 1/2" x 2 ..... 310  
#2 Common, Red or White, 3/4" x 2 1/2" x 2 ..... 305

### Prefinished Oak Flooring—

	Prime	Standard
1/2" x 2 1/2" x 2	\$369.00	\$359.00
3/4" x 2 1/2" x 2	380.00	370.00
1" x 2 1/2" x 2	390.00	381.00
1 1/4" x 2 1/2" x 2	375.00	355.00
1 1/2" x 3/4" x 3/4" Ranch Plank	395.00	375.00
		415.00

### Unfinished Maple Flooring—

1 1/4" x 2 1/4" First Grade	\$390.00
1 1/4" x 2 1/4" 2nd Grade	365.00
1 1/4" x 2 1/4" 2nd & 8tr. Grade	375.00
1 1/4" x 2 1/4" 3rd Grade	240.00
1 1/4" x 3/4" 3rd & 8tr. Jhd. EM	380.00
1 1/4" x 3/4" 2nd & 8tr. Jhd. EM	390.00
3/8" x 2 1/4" 1st Grade	400.00
3/8" x 2 1/4" 2nd Grade	360.00
3/8" x 2 1/4" 3rd Grade	320.00

Floor Layer's Wage \$2.50 hr.

### GLASS—

Single Strength Window Glass, \$ .30 per sq. ft.  
Double Strength Window Glass, .45 per sq. ft.  
Plate Glass, 1/4 polished to 75, 1.60 per sq. ft.  
75 to 100 ..... 1.74 per sq. ft.  
1/4 in. Polished Wire Plate Glass, 2.35 per sq. ft.  
1/4 in. Rgh. Wire Glass, .71 per sq. ft.  
1/4 in. Polished Wire Plate Glass, 2.00 per sq. ft.  
1/4 in. Rgh. Wire Glass, .64 per sq. ft.  
1/2 in. Obscure Glass, .40 per sq. ft.  
3/8 in. Obscure Glass, .64 per sq. ft.  
1/2 in. Heat Absorbing Obscure, .58 per sq. ft.  
1/4 in. Heat Absorbing Wire, .86 per sq. ft.  
Glazing of above additional \$1.5 to 3.0 per sq. ft.  
Glass Blocks, set in place, 3.50 per sq. ft.

### HEATING—

Average, \$3.50 to \$4.00 per sq. ft. of radiation, according to conditions.  
Warm air (gravity) average \$64 per register.  
Forced air average \$91 per register.



### INSULATION AND WALLBOARD—

<b>Rockwool Insulation—</b>	
(2") Less than 1,000 sq. ft.	\$64.00
(2") Over 1,000 sq. ft.	59.00
<b>Cotton Insulation—Full thickness</b>	
(3 1/2")	\$95.50 per M sq. ft.
<b>Sisalation Aluminum Insulation—Aluminum coated on both sides.</b>	\$25.00 per M sq. ft.
<b>Insulation—4 1/2" panel</b>	59.00 per panel
<b>Wallboard—1/2" thickness</b>	\$55.00 per M sq. ft.
<b>Finished Panel</b>	\$69.00 per M sq. ft.
<b>Ceiling Tileboard</b>	\$69.00 per M sq. ft.

**IRON—**Cost of ornamental iron, cast iron, etc., depends on designs.

### LUMBER—

<b>S4S No. 2 end better common</b>	
O.P. or D.F., per M. f.b.m.	\$100.00
<b>Rough, No. 2 common O.P. or D.F., per M. f.b.m.</b>	100.00

### Flooring—

	Per M Delvd.
<b>V.G.—D.F. 8 &amp; Str. 1 x 4 T &amp; G Flooring</b>	\$225.00
"C" and better—all	225.00
"D", and better—all	225.00
<b>Rwd. Rustic—"A" grade, medium dry</b>	185.00
8 to 24 ft.	

<b>Plywood, per M sq. ft.</b>	
1/4-inch, 40x80-515	\$170.00
1/2-inch, 40x80-515	250.00
3/4-inch, per M sq. ft.	315.00
<b>Plywood</b>	11 1/2¢ per ft.
<b>Plyform</b>	25¢ per ft.

**Shingles (Rwd. not available)—**  
**Red Cedar, No. 1—\$9.50 per square; No. 2, \$7.00; No. 3, \$5.00.**

**Average cost to lay shingles, \$6.00 per square.**  
**Cedar Shakes—1/2" to 3/4" x 24/26 in handsplit tapered or split resaw, per square—\$15.25**  
 per square  
**3/4" to 1 1/4" x 24/26 in split resaw, 17.00**  
**Average cost to lay shakes, 8.00 per square**  
**Pressure Treated Lumber—**  
 Wolmanized—Add \$35 per M to above  
 Creosoted,  
 8-lb. treatment—Add \$45 per M to above

### MARBLE—(See Dealers)

### METAL LATH EXPANDED—

Standard Diamond, 3/40, Copper Bearing, L.C.L., per 100 sq. yds.	\$43.50
Standard Ribbed, ditto.	\$47.50

### MILLWORK—Standard.

<b>D. F. \$150 per 1000. R. W. Rustic \$175 per 1000 (delivered).</b>	
<b>Double hung box window frames, average with trim, \$12.50 and up, each.</b>	
<b>Complete door unit, \$15 to \$25.</b>	
<b>Screen doors, \$8.00 to \$12.00 each.</b>	
<b>Patent screen windows, \$1.25 a sq. ft.</b>	
<b>Cases for kitchen pantries seven ft. high, per lineal ft., upper \$9.00 to \$11.00; lower \$12.00 to \$13.00.</b>	
<b>Dining room cases, \$20.00 per lineal foot. Rough and finish about \$1.00 per sq. ft.</b>	
<b>Labor—Rough carpentry, warehouse heavy framing (average), \$75.00 per M.</b>	
<b>For smaller work average, \$85.00 to \$100. or 1000.</b>	

### PAINTING—

<b>Two-coat work</b>	per yard 85c
<b>Three-coat work</b>	per yard \$1.10
<b>Cold water painting</b>	per yard 25c
<b>Whitewashing</b>	per yard 15c
<b>Linseed Oil, Strictly Pure</b>	Wholesale
(Basis 7 1/2 lbs. per gal.)	Raw Boiled
<b>Light iron drums</b>	per gal. \$2.28 \$2.34
<b>5-gallon cans</b>	per gal. 2.40 2.46
<b>1-gallon cans</b>	each 252 258
<b>Quart cans</b>	each 71 72
<b>Pint cans</b>	each 38 39
<b>1/2-pint cans</b>	each 24 24
<b>Turpentine</b>	Pure Gum
(Basis, 7.2 lbs. per gal.)	Spirits
<b>Light iron drums</b>	per gal. \$1.85
<b>5-gallon cans</b>	per gal. 1.76
<b>1-gallon cans</b>	each 1.88
<b>Quart cans</b>	each 54
<b>Pint cans</b>	each 31
<b>1/2-pint cans</b>	each 20

### Pioneer White Lead in Oil Heavy Paste and All-Purpose (Soft-Paste)

<b>Net Weight</b>	per 100	Pr. per	Price to	Pr. per
<b>Packages</b>	lbs.	pkts.	lbs.	pkgs.
100-lb. kegs	\$28.35	\$29.35	\$27.50	\$27.50
50-lb. kegs	30.05	15.03	28.15	14.08
25-lb. kegs	30.35	7.59	28.45	7.12
5-lb. cans	33.35	1.34	31.25	1.25
1-lb. cans*	36.00	.36	33.75	.34
500 lbs. (one delivery)	1/4¢	per pound less than above.		

\*Heavy Paste only.

### Pioneer Dry White Lead—Litharge—Dry Red Lead—Red Lead in Oil

	Price to Painters—Price Per 100 Pounds
	100 lbs. 50 lbs. 25 lbs.
<b>Products</b>	lbs. lbs. lbs.
Dry White Lead	\$28.30 \$ 28.30
Litharge	25.95 26.60 26.90
Dry Red Lead	27.20 27.85 28.15
Red Lead in Oil	30.65 31.30 31.60
Found cans, \$37 per lb.	

### PATENT CHIMNEYS—

<b>6-inch</b>	\$2.50 lineal foot
<b>8-inch</b>	3.00 lineal foot
<b>10-inch</b>	4.00 lineal foot
<b>12-inch</b>	5.00 lineal foot

### PLASTER—

**Neat wall, per ton delivered in S. F. in paper bags, \$17.60.**

### PLASTERING (Interior)—

	3 Coats	2 Coats	1 Coat	Yard
<b>Keene cement on metal lath</b>	\$3.00	3.50		
<b>Ceilings with 3/4 hot roll channels metal lath (lathed only)</b>	3.00			
<b>Sealings with 3/4 hot roll channels metal lath plastered</b>	4.50			
<b>Single partition 3/4 channel lath 1 side (lath only)</b>	3.00			
<b>Single partition 3/4 channel lath 2 inches thick plastered</b>	8.00			
<b>4-inch double partition 3/4 channel lath 2 sides (lath only)</b>	5.75			
<b>4-inch double partition 3/4 channel lath 2 sides plastered</b>	8.75			
<b>Thermax single partition; 1" channels; 2 1/4" overall partition width. Plastered both sides</b>	7.50			
<b>Thermax double partition; 1" channels; 4 1/4" overall partition width. Plastered both sides</b>	11.00			
<b>3 Coats over 1" Thermax nailed to one side wood studs or joists</b>	4.50			
<b>3 Coats over 1" Thermax suspended to one side wood studs with spring sound isolation clip</b>	5.00			
<b>Note—Channel lath controlled by limitation orders.</b>				

### PLASTERING (Exterior)—

<b>2 coats cement finish, brick or concrete wall</b>	\$2.50
<b>3 coats cement finish, No. 18 gauge wire mesh</b>	3.50
<b>Price—\$4.00 per bbl. at yard.</b>	
<b>Lime—L1Lime—\$4.15 per bbl. at yard.</b>	
<b>Rock or Grip Lath—3/8"—30¢ per sq. yd</b>	
<b>1/2"—29¢ per sq. yd</b>	
<b>Composition Stucco—\$4.00 sq. yd (applied).</b>	

### PLUMBING—

**From \$200.00 per fixture up, according to grade, quality and runs.**

### ROOFING—

<b>"Standard" tar and gravel, 4 ply—\$11.00 per sq. for 30 sqs. or over.</b>	
<b>Less than 30 sqs. \$14.00 per sq.</b>	
<b>Title \$40.00 to \$50.00 per square.</b>	
<b>No. 1 Redwood Shingles in place, 4 1/2 in. exposure, per square—\$18.25</b>	
<b>5/2 No. 1 Cedar Shingles, 5 in. exposure, per square—14.50</b>	
<b>5/8 x 16"—No. 1 Little Giant Cedar Shingles, 5" exposure, per square.. 18.25</b>	

<b>4/2 No. 1-24" Royal Cedar Shingles</b>	23.00
<b>7 1/2" exposure, per square—</b>	
<b>Re-coat with Gravel \$5.50 per sq.</b>	
<b>Asbestos Shingles, \$27 to \$35 per sq. laid.</b>	
<b>1/2 to 3/4 x 25" Resawn Cedar Shakes, 10" Exposure</b>	\$30.00
<b>3/4 to 1 1/4 x 25" Resawn Cedar Shakes, 10" Exposure</b>	\$35.00
<b>1 x 25" Resawn Cedar Shakes, 10" Exposure</b>	22.00
<b>Above prices are for shakes in place.</b>	

### SEWER PIPE—

<b>C.I. 6-in. to 24-in. B. &amp; S. Class B and heavier, per ton—</b>	\$99.50
<b>Vitrified, per foot: L.C.L. F.O.B. Warehouse, San Francisco.</b>	
Standard, 8-in.	\$.66
Standard, 12-in.	1.30
Standard, 24-in.	5.41
<b>Clay Drain Pipe, per 1,000 L.F. L.C.L. F.O.B. Warehouse, San Francisco:</b>	
Standard, 6-in. per M.	\$240.00
Standard, 8-in. per M.	400.00

### SHEET METAL—

**Windows—Metal, \$2.50 a sq. ft.**  
**Fire doors (average), including hardware \$2.80 per sq. ft., size 12'x12'. \$3.75 per sq. ft., size 3'x6'.**

### SKYLIGHTS—(not glazed)

<b>Copper, \$1.25 sq. ft. (flat).</b>	
<b>Galvanized iron, 65c sq. ft. (flat).</b>	
<b>Vented light skylights, \$1.50 sq. ft.</b>	

### STEEL—STRUCTURAL—

**\$220 per ton erected, when out of mill. \$270 per ton erected, when out of stock.**

### STEEL REINFORCING—

<b>\$700.00 per ton. in place.</b>	
<b>1/4-in. Rd. (Less than 1 ton)</b>	\$8.40
<b>3/8-in. Rd. (Less than 1 ton)</b>	7.30
<b>1/2-in. Rd. (Less than 1 ton)</b>	7.00
<b>5/8-in. Rd. (Less than 1 ton)</b>	6.75
<b>3/4-in. &amp; 7/8-in. Rd. (Less than 1 ton).</b>	6.65
<b>1-in. &amp; up (Less than 1 ton)</b>	6.60
<b>1 ton to 5 tons, deduct 25c.</b>	

### STORE FRONTS (None available)

### TILE—

<b>Ceramic Tile Floors—Commercial \$1.20 to \$1.60 per sq. ft.</b>	
<b>Cove Base—\$1.40 per lin. ft.</b>	
<b>Heavy Tile Floors, 6x6" with 6" base @ \$1.35 per sq. ft.</b>	
<b>Tile Wainscots &amp; Floors, Residential, 4 1/4x4 1/4", @ \$1.65 to \$2.00 per sq. ft.</b>	
<b>Tile Wainscots, Commercial Jobs, 4 1/4x4 1/4" Tile, @ \$1.50 to \$1.65 per sq. ft.</b>	
<b>Asphalt Tile Floor 16" x 16" @ \$.18 - .35 sq. yd.</b>	
<b>Light shades slightly higher.</b>	
<b>Cork Tile—.70 per sq. ft.</b>	
<b>Mosaic Floors—See dealers.</b>	
<b>Linoleum—\$1.00 per sq. ft.</b>	
<b>Rubber Tile—\$.55 to \$.75 per sq. ft.</b>	

### Building Tile—

<b>8 1/2"x12-inches, per M</b>	\$139.50
<b>6 1/2"x12-inches, per M</b>	105.00
<b>4 1/2"x12-inches, per M</b>	84.00

### Hollow Tile—

<b>12"x12-inches, per M</b>	\$146.75
<b>12"x13-inches, per M</b>	177.10
<b>12"x14-inches, per M</b>	235.30
	F.O.S. Plant

### VENETIAN BLINDS—

**75c per square foot and up. Installation extra.**

### WINDOWS—STEEL—INDUSTRIAL

**Cost depends on design and quality required.**

# ARCHITECT AND ENGINEER

# ESTIMATOR'S DIRECTORY

## Building And Construction Materials

EXPLANATION—Building and construction materials are shown in major classified groups for general identification purposes with names and addresses of suppliers of materials listed in detail under group classification where name first appears—main offices are shown first, with branch or district offices following. The numeral appearing in listings refers to the major group classification where complete data on the dealer, or representative, may be found.

### ARCHITECTURAL VENEER (a)

#### Ceramic Veneer

##### PACIFIC CLAY PRODUCTS

San Francisco: 605 Market St., GA 1-3970

Los Angeles, Portland, Salt Lake City

GLADDING, McBEAN & CO. \*(1)

#### Porcelain Veneer

##### PORCELAIN ENAMEL PUBLICITY BUREAU

(Dept. AE-450)

Room 601, Franklin Building, Oakland 12, California

P. O. Box 186, East Pasadena Station, Pasadena 8, California

#### Granite Veneer

##### VERMONT MARBLE COMPANY

San Francisco 5: 525 Market Street, SU 1-6747

Los Angeles 4: DU 2-7834

#### Marble Veneer

##### VERMONT MARBLE COMPANY

San Francisco 5: 525 Market Street, SU 1-6747

Los Angeles 4: DU 2-7834

### BRASS PRODUCTS (1a)

#### GREENBERG'S, M. & SONS

San Francisco, Calif.: 765 Folsom, EXbrook 2-3143

### BRICKWORK (1)

#### Face Brick

##### GLADDING, McBEAN & CO.

San Francisco: Harrison at 9th Sts., UN 1-7400

Los Angeles: 2901 Los Feliz Blvd., OL 2121

Offices at Portland, Seattle, Spokane

##### KRAFTILE

Niles, California, Niles 3611

San Francisco 5: 50 Hawthorne St., DO 2-3080

Los Angeles 13: 406 South Main St., MU 7241

##### REMILLARD-DANDINI CO.

San Francisco: 400 Montgomery St., EX 2-4988

### BRONZE PRODUCTS (1b)

#### GREENBERG'S, M. & SONS

San Francisco, Calif.: 765 Folsom, EXbrook 2-3143

### BUILDING PAPER & FELTS (2)

#### SISALKRAFT COMPANY

San Francisco: 55 New Montgomery St., EX 2-3066

Chicago, Ill.: 205 West Wacker Drive

#### ANGIER PAPER CORP.

San Francisco 5: 55 New Montgomery St., DO 2-4416

Los Angeles: 7424 Sunset Boulevard

### BUILDING HARDWARE (3)

#### THE STANLEY WORKS

San Francisco: Monadnock Bldg., YU 6-5914

New Britain, Conn.

### CEMENT (c)

#### PACIFIC PORTLAND CEMENT

San Francisco: 417 Montgomery St., GA 1-4100

### CONCRETE AGGREGATES (4)

#### Lightweight Aggregates

#### AMERICAN PERLITE CORP.

Richmond, Calif.: 26th & B Sts.—Yard 2, RI 4307

### FIRE ESCAPES (5)

#### SOULE STEEL

San Francisco: 1750 Army St., VA 4-4141

Los Angeles, Calif.—LA 0911

Portland, Ore.—BE 5155

Seattle, Wash.—SE 3010

#### MICHAEL & PFEFFER IRON WORKS, INC. Shingles

San Francisco 3: Tenth & Harrison Sts.,

MA 1-5966

### FLOORS (6)

#### Hardwood Flooring

##### HOGAN LUMBER COMPANY

Oakland: Second and Alice Sts., GL 1-6861

##### E. K. WOOD LUMBER CO.

Los Angeles: 4710 S. Alameda St., JE 3111

Oakland: 727 Kennedy St., KE 4-8466

Portland: 827 Terminal Sales Building

#### Floor Maintenance

##### HILLYARD SALES CO. (Western)

470 Alabama St., San Francisco, MA 1-7766

Los Angeles, 923 E. 3rd, TRinity 8282

Seattle, 3440 E. Marginal Way

### GLASS (7)

#### W. P. FULLER COMPANY

San Francisco: 301 Mission St., EX 2-7151

Los Angeles, Calif.

Portland, Oregon

### HEATING (8)

#### HENDERSON FURNACE & MFG. CO.

Sebastopol, Calif.

#### S. T. JOHNSON CO.

Oakland 8: 940 Arlington Ave., OL 2-6000

Los Angeles: 585 Potrero Ave., MA 1-2757

Philadelphia 8, Pa.: 401 No. Broad St.

#### SCOTT COMPANY

San Francisco: 243 Minna St., YU 2-0400

Oakland: 113 - 10th St., GL 1-1937

San Jose, Calif.

Los Angeles, Calif.

THOMAS B. HUNTER (Designer)

San Francisco: 41 Sutter St., GA 1-1164

### INSULATION AND WALLBOARD (9)

#### LUMBER MANUFACTURING CO.

San Francisco: 225 Industrial Ave., JU 7-1760

#### SISALKRAFT COMPANY \*(2)

#### WESTERN ASBESTOS COMPANY

San Francisco: 675 Townsend St., L2-3868

Oakland: 251 Fifth Avenue, GL 1-2345

Sacramento: 1224 I Street, 2-8993

Stockton: 1120 E. Weber Ave., 4-1863

Fresno: 1837 Merced Street, 3-3277

San Jose: 201 So. Market St., BA 4359-J

### IRON—Ornamental (10)

#### MICHEL & PFEFFER IRON WORKS, INC. \*

(5)

### LIGHTING FIXTURES (11)

#### SMOOT-HOLMAN COMPANY

Ingwood, Calif., OR 8-1217

San Francisco: 55 Mississippi St., MA 1-8474

### LUMBER (12)

#### HOGAN LUMBER COMPANY \*(6)

LUMBER MANUFACTURING CO. \*(9)

E. K. WOOD LUMBER CO \*(6)

#### SEWALL LUMBER COMPANY

San Francisco 24: 1995 Oakdale Ave., AT 2-8112

### MARBLE (13)

#### VERMONT MARBLE COMPANY

San Francisco: 525 Market St., SU 1-6747

Los Angeles 4: 3522 Council St., DU 2-7834

### METAL LATH EXPANDED (14)

#### FORDEER CORNICE WORKS

San Francisco: 269 Potrero Ave., HE 1-4100

SOULE STEEL \*(5)

### MILLWORK (15)

#### PACIFIC MANUFACTURING COMPANY

San Francisco: 16 Beale St., GA 1-7755

Santa Clara: 2610 The Alameda, SC 607

Los Angeles: 6820 McKinley Ave., TH 4196

#### MULLEN MANUFACTURING COMPANY

San Francisco: 60-80 Rausch St., UN 1-5815

LUMBER MANUFACTURING COMPANY \*(9)

### PAINTING (16)

#### Paint

W. P. FULLER COMPANY \*(7)

### PLASTER (17)

#### Exteriors

PACIFIC PORTLAND CEMENT COMPANY\*(4)

#### Interiors—Metal Lath & Trim

FORDEER CORNICE WORKS \*(14)

### PLASTIC CEMENT (8)

#### PACIFIC PORTLAND CEMENT CO.

San Francisco: 417 Montgomery St., GA 1-4100

### PLUMBING (18)

#### THE SCOTT COMPANY \*(8)

#### THE HALSEY TAYLOR COMPANY

Redlands, Calif.

Warren, Ohio

#### HAWS DRINKING FAUCET COMPANY

Berkeley 10: 1435 Fourth St., LA 5-3341

#### CONTINENTAL WATER HEATER COMPANY

Los Angeles 31: 1801 Pasadena Ave., CA 6178

#### SIMONDS MACHINERY COMPANY

San Francisco: 816 Folsom St., DO 2-6794

Los Angeles: 455 East 4th St., MU 8322

#### SECURITY VALVE COMPANY

Los Angeles 31: 410 San Fernando Rd., CA 6191

### SEWER PIPE (19)

GLADDING, McBEAN & CO. \*(1)



## AIR RAID SHELTERS

(From Page 11)

gory of not having all your eggs in the same basket. American industry is the greatest part of our war effort. Its commanding position must be maintained and not only the physical plant dispersed but the communities must be well-built and adequately supplied with the amenities of life. There were plenty of examples in evidence during the last war effort as to the large turnover in industrial labor due to bad living conditions, with a resulting loss in output, to make it essential to do a better job this time. We must learn how to build permanently in times of crisis; for the so-called temporary is generally a waste of resources.

It is my opinion then that throughout the war effort and for years to come the Federal Government will use its powers to insist upon the further spread of our cities into smaller individual areas—tied together no doubt into regional patterns. The plan for the dispersal of Washington, now up for the approval of Congress, is acknowledged to be an attempt to illustrate what should be done in other cities. The Government will, I believe, more willingly issue its licenses to industry and housing which meet the criteria of reducing heavy concentration of population—so as to reduce the target areas and the possibility of large catastrophes in losses of production as well as lives.

I believe this will mean that large cities like New York will probably have less major building than other and smaller communities. I do not know whether my remarks are too gloomy or not. The extent of Stalin's plans and his timetable are well kept secrets. And of course people still live on the side of Vesuvius.

Moreover, I firmly believe for a long time to come we will be seeking to build with less metals, more masonry and more wood, and lower building on more open land.

I have one final remark, and that is, there are many indications that the day of the skyscraper city is over; that the region with open planning of communities is going to become the city form of the future. It is a well known fact that city forms follow defense patterns, and what we are now considering is a defense against an expanding and aggressive power.

(Conclusion)

### ARCHITECT SELECTED

The architectural firm of Bliss & Hurt, Trudell & Berger of San Francisco has been chosen by the U. S. Navy Bureau of Yards and Docks to draft plans for additional aviation facilities at the Auxcl Naval Station near Crows Landing in San Joaquin county.

## Parker, Steffens & Pearce

BUILDERS

135 South Park, San Francisco

Phone: EXbrook 2-6639

## FORDERER CORNICE WORKS

Manufacturers of

Hollow Metal Products • Interior Metal Trim  
Elevator Fronts and Cabs  
Metal Plaster Accessories • Sanitary Metal Base  
Flat and Roll Metal Screens  
Metal Cabinets • Commercial Refrigerators

269 POTRERO AVE.

SAN FRANCISCO, CALIF.

HEMLOCK 1-4100

## VALUABLE NEWS SERVICE

- BUILDING MATERIAL DEALERS
- CONTRACTORS
- ENGINEERS
- FINANCIAL INSTITUTIONS

**ARCHITECTS REPORTS** gives advance news on construction projects in Northern California, lists: name of projects, location, architect, proposed cost and other pertinent information.

**HANDY** individual slip-reports, issued daily at a total cost of only \$10 a month

## ARCHITECT'S REPORTS

Published Daily

The ARCHITECT and ENGINEER, Inc.

68 Post Street, San Francisco • DO 8311



## CONSTRUCTION CONTRACTS AWARDED AND MISCELLANEOUS PERSONNEL DATA

**EAST BAKERSFIELD HIGH SCHOOL ADDITION.** Bakersfield, Kern County. Kern County Union High School District, owner. Shop and classroom building. \$467,459. ARCHITECT: C. E. Alford & W. I. Thomas, Bakersfield. 1 story and part mezzanine, 49,000 sq. ft., reinforced concrete construction, steel roof trusses, steel roof deck, steel sash, radiant heating. GENERAL CONTRACTOR: Guy E. Hall, Bakersfield.

**NURSES' HOME REMODEL AND MOVING.** San Jose, Santa Clara County. San Jose Hospital, owner. \$90,000. ARCHITECT: D. D. Stone and Lou Mulloy, San Francisco. Interior and exterior remodel. GENERAL CONTRACTOR: E. A. Hathaway & Co., San Jose.

**NEW GRAMMAR SCHOOL.** Corralitos, Santa Cruz County. Corralitos Elementary School District, owner. \$166,784. ARCHITECT: Robert Stanton, Carmel. Frame and stucco construction. GENERAL CONTRACTOR: T. H. Rosewall, Watsonville.

**HUMPER MARKET.** Oakland, Alameda County. Paul Hammarberg, owner. \$100,000. ARCHITECT: Paul Hammarberg, Berkeley. 1 story, 40,000 sq. ft., reinforced concrete and concrete block, some structural steel, plate glass front, frame construction. GENERAL CONTRACTOR: A. Hammarberg, Berkeley.

**NEW GYMNASIUM BUILDING.** Oroville, Butte County. Oroville Union High School, owner. \$344,918. ARCHITECT: E. Geoffrey Bangs, San Francisco. Reinforced concrete construction. GENERAL CONTRACTOR: Geo. E. McDaniel, Marysville.

**FACTORY BUILDING.** San Francisco. West Electric Heater Co., owner. \$150,000. STRUCTURAL ENGINEER: Geo. Washington, San Francisco. 3 story, 18,000 sq. ft., reinforced concrete, structural steel, wood joists and roof, steel sash. GENERAL CONTRACTOR: D. L. Bienfield, San Francisco.

**AUTO SHOP BUILDING.** San Jose, Santa Clara County. St. Claire Motor Co., owner. \$45,000. ARCHITECT: Kurt Gross, San Jose. 1 story, 7,500 sq. ft., reinforced concrete, structural steel and frame construction. GENERAL CONTRACTOR: Coppel Construction Co., San Jose.

**EATING CLUBS BUILDING.** Palo Alto, Santa Clara County. Stanford University, owner. 7 dining rooms, 7 kitchens and 1 lounge, 7 cooks rooms and baths. \$134,293. ARCHITECT: Weihe, Frick & Kruse, San Francisco. 1 story, frame construction, redwood exterior. GENERAL CONTRACTOR: Vance M. Brown, Palo Alto.

## PANACALITE

The Standard for Perlite Aggregates  
An Engineered Product—Engineering Service  
Air Classified—Sized & Graded for  
Plaster, Concrete & Stucco  
Aggregates

Listed Underwriters' Laboratories  
Re-examination Service

Fire Ratings  
Non-Bearing Walls—2 hours  
Floor and Beam—4 hours  
Column—2 & 3 hours  
Suspended Ceiling—4 hours  
Others

Manufactured by  
American Perlite Corporation  
26th & 8 Sts.—Yard 2—Richmond  
Eacon 5-1285

**LINDA VISTA GRAMMAR SCHOOL ADDITION.** Alum Rock, Santa Clara County. Alum Rock Union School District, owner. 7 classrooms and toilet rooms. \$99,478. ARCHITECT: Kress & Gibson, San Jose. Frame and stucco construction. GENERAL CONTRACTOR: Nielsen & Nielsen, San Jose.

**BANK AND OFFICE BUILDING.** Reno, Nevada. Security National Bank, owner. \$350,000. ARCHITECT: Ferris & Erskine, Reno. 2 story and basement, brick and structural steel frame construction. GENERAL CONTRACTOR: O & O Novelty Co., Inc., Reno.

**CHURCH ADDITION.** Burlingame, San Mateo County. First Methodist Church, owner. Youth center and Sunday school. \$135,000. ARCHITECT: Alfred W. Johnson, San Francisco. Frame and stucco construction. GENERAL CONTRACTOR: Wilfred H. May, Belmont.

**MUDDOX GRAMMAR SCHOOL ADDITION.** Sacramento, Sacramento County. Junction Elementary School District, owner. Classrooms, assembly room addition, \$140,986. ARCHITECT: Chas. F. Dean, Sacramento. Frame and stucco construction. GENERAL CONTRACTOR: Guth & Schmidt, Sacramento.

**INDUSTRIAL ARTS BUILDING.** Pacific Grove, Monterey County. Pacific Grove High School District, owner. \$66,400. ARCHITECT: Frank Wynkoop & Assoc., San Francisco. 1 story, 53x131 concrete block and structural steel frame, wood roof. GENERAL CONTRACTOR: Lembe Construction Co., Salinas.

**NEW WASHINGTON GRAMMAR SCHOOL.** Berkeley, Alameda County. Berkeley Board of Education, owner. 14 classrooms, 2 kindergarten, administration, toilet room, auditorium and cafeteria. \$737,944. ARCHITECT: Dragon, Schmidts & Hardman, Berkeley. 2 story, reinforced concrete and frame construction. GENERAL CONTRACTOR: Elmer J. Freethy, El Cerrito.

**FEDERAL RESERVE BANK REMODEL.** San Francisco. Federal Reserve Bank, owner. \$350,000. ARCHITECT: Thomsen & Wilson, San Francisco. Interior and exterior remodel. GENERAL CONTRACTOR: Dinwiddie Construction Co., San Francisco.

**CABINET WORK AND CERTAIN SPECIAL EQUIPMENT FOR NEW H'GH SCHOOL BUILDING.** San Jose, Santa Clara County. San Jose Board of Education, owner. \$109,800. ARCHITECT: Kump Associates, San Francisco. GENERAL CONTRACTOR: Carl N. Swenson Co., San Jose.

**GRAMMAR SCHOOL.** Dehli, Merced County. Dehli Elementary School District, owner. 10 classrooms, offices and toilet rooms, \$240,849. ARCHITECT: Easterly, Ellenwood, Easterly, Watsonville. Reinforced concrete, structural steel and frame construction. GENERAL CONTRACTOR: Graham & Jensen, Merced.

**HOUSING PROJECTS, LOW INCOME.** Turlock, Okdale, Ceres, Stanislaus County. Housing Authority of County of Stanislaus. 37 duplexes, \$620,000. ARCHITECT: Donald Powers Smith, San Francisco. Concrete block and frame construction, cement tile roof. GENERAL CONTRACTOR: Harvey & Rose, Arcata.

**DEPARTMENT STORE REMODEL.** San Francisco. The White House, owner. \$400,000. ARCHITECT: W. P. Day, San Francisco. Interior remodel. GENERAL CON-

TRACTOR: Cahill Bros., San Francisco.

**PAROCHIAL SCHOOL.** San Francisco. Roman Catholic Archbishop, owner. 8 classrooms, office, assembly and cafeteria building. \$354,125. ARCHITECT: Vincent Buckley, San Francisco. School, reinforced concrete and frame construction. Convent, frame and stucco construction. GENERAL CONTRACTOR: Pacific Coast Builders, San Francisco.

**FAIRVIEW GRAMMAR SCHOOL.** Modesto, Stanislaus County. Modesto Board of Education, owner. 4 classrooms, office, toilet room, \$137,700. ARCHITECT: Swartz & Hyberg, Fresno; John W. Bomberger, Modesto. Frame and stucco construction. GENERAL CONTRACTOR: Sauerwein & Thompson, Modesto.

**OFFICE BUILDING.** Oakland, Alameda County. Wm. Stawell Co., owner. \$200,000. STRUCTURAL ENGINEER: R. H. Cooley, Oakland. 3 story, 15,000 sq. ft. concrete block, structural steel frame, wood floors and roof, steel sash, 1 elevator, plate glass front. GENERAL CONTRACTOR: John J. Moore Co., Oakland.

**CHURCH ADDITION.** San Jose, Santa Clara County. First Methodist Church, owner. \$158,000. ARCHITECT: Binder & Curtis, San Jose. Will contain Sunday school, chapel, social hall, offices, etc., 2 story, 12,000 sq. ft. GENERAL CONTRACTOR: N. A. Lomb, Campbell.

**BUS SERVICE GARAGE.** San Francisco. Pacific Greyhound lines, owner. \$2,000,000. ARCHITECT: Skidmore, Owings & Merrill, San Francisco. 1 story and part 2 story, 240x400 reinforced concrete construction. GENERAL CONTRACTOR: Barrett & Hilp, San Francisco.

**HIGH SCHOOL ADDITION.** Pittsburg, Contra Costa County. Pittsburg Unified School District, owner. Science wing and music wing, \$121,576. ARCHITECT: Philip D. Tomassello, San Francisco. Frame and stucco construction. GENERAL CONTRACTOR: A. F. Stewart, Berkeley.

**OFFICE AND WAREHOUSE BUILDING.** San Leandro, Alameda County. Republic Supply Co., owner. \$400,000. ARCHITECT: Geo. Vernon Russell, Los Angeles. 1-story, 55,000 sq. ft., reinforced concrete structural steel, steel sash, concrete floors, radiant heating, in office. GENERAL CONTRACTOR: Swinerton & Walberg, Oakland.

**NEW FIRE HOUSE.** Martinez, Contra Costa County. County of Contra Costa, owner. \$58,851. ARCHITECT: Fred L. R. Conter and R. G. Willis, Oakland. 1-story, concrete block and frame construction, 88x57, some structural steel. GENERAL CONTRACTOR: Vezy Construction Co., Oakland.

**WASHINGTON JUNIOR HIGH SCHOOL ADDITION.** Salinas, Monterey County. Salinas Board of Education, owner. 18 classrooms, offices, 2 gyms, cafeteria and shop building, \$645,153. ARCHITECT: Chas. E. Butner, Salinas. STRUCTURAL ENGINEER: F. W. Kellberg, San Francisco. MECHANICAL ENGINEER: Clyde E. Bentley, San Francisco. Frame and stucco construction. GENERAL CONTRACTOR: Stolte Inc., Monterey.

**SUNDAY SCHOOL BUILDING.** Santa Cruz County. Trinity Presbyterian Church, owner. \$35,000. ARCHITECT: Francis A. Lockwood, Santa Cruz. Frame and stucco construction.

**CHRISTINA B. CAMERON SCHOOL.** El Cerrito, Contra Costa County. Richmond Board of Education, owner. 4 classrooms, administration, rest rooms, physical and occupational therapy rooms, kitchen and dining room. \$193,153. ARCHITECT: Schmidts & Hardman, Berkeley. Frame and

structural steel, stucco and brick veneer exterior. GENERAL CONTRACTOR: Marvin E. Collins, Richmond Annex.

**JUVENILE HALL**, San Leandro, Alameda County, County of Alameda, owner. \$2,101,900. ARCHITECT: Kent & Hoss, San Francisco. One and two story, reinforced concrete construction, main building, 2 story, will contain administration, courtrooms, infirmary, 4 buildings for 20 boys each, 1 building for 29 girls and 1 building for dependent children, gym, baseball diamond. GENERAL CONTRACTOR; Engineers Ltd., Oakland.

**SHOPPING CENTER**, San Leandro, Alameda County, Eden Development Co., owner. Super market and group of stores, \$300,000. ENGINEER: J. Y. Long, Oakland. One story concrete block and frame and stucco construction, plate glass front. GENERAL CONTRACTOR: Beckett & Federighi, Oakland.

**PERALTA HOSPITAL ADDITION**, Oakland, Alameda County. Peralta Hospital, owner. \$100,000. ARCHITECT: D. D. Stone & Lou Mulloy, San Francisco. Adds 2 stories to new 3 story wing, reinforced concrete and structural steel construction. GENERAL CONTRACTOR: Beckett & Federighi, Oakland.

**MARKET BUILDING**, Salinas, Monterey County. Purity Stores, owner. \$100,000. STRUCTURAL ENGINEER: H. M. Engle, San Francisco. 1 story, 70x160 ft., reinforced concrete, structural steel roof trusses, wood roof. GENERAL CONTRACTOR: Don A. Younger, San Francisco.

**MARKET BUILDING**, Monterey, Monterey County. Purity Stores, owner. \$50,000. STRUCTURAL ENGINEER: H. M. Engle, San Francisco. 1 story 50x135 ft., reinforced concrete construction with wood roof. GENERAL CONTRACTOR, Don A. Younger, San Francisco.

**AUTOMOBILE BODY PLANT**, San Leandro, Alameda County, Chrysler Corp., owner. \$2,000,000. STRUCTURAL ENGINEER, Geo. H. Miehs, Detroit, Mich. ARCHITECT, Albert Kahn & Associates, Detroit, Mich. 2 story 322x1080 ft., structural steel frame, reinforced concrete and granite construction. Steel sash. GENERAL CONTRACTOR: Swinerton & Walberg, Oakland.

**CAN FACTORY**, Stockton, San Joaquin County. American Can Co., owner. \$1,289,000. STRUCTURAL ENGINEER: Donald R. Warren Co., Los Angeles. Factory and warehouse, 274,000 sq ft., structural steel frame with reinforced concrete and transite walls, steel sash. Office 50x60 ft. of brick and frame construction. GENERAL CONTRACTOR: Larsen & Larsen, San Francisco.

**SEWAGE TREATMENT PLANT**, Bakersfield, Kern County. City of Bakersfield, owner. \$938,102. Reinforced concrete construction. ENGINEER: Currie Engineering Co., San Bernardino. GENERAL CONTRACTOR: Wonderly Construction Co., Long Beach.

**CHURCH—RECREATION BUILDING**, Millbrae, San Mateo County. Church of Jesus Christ of Latter Day Saints, owner. \$145,000. ARCHITECT, Wm. F. Thomas, Salt Lake City, Utah. Frame and stucco construction. Owner awards separate contracts.

**INDUSTRIAL BUILDING**, San Francisco. Barrett & Hilp, owner. \$71,000. ARCHITECT: Ward & Bolles, San Francisco. 1 story reinforced concrete construction. GENERAL CONTRACTOR: Barrett & Hilp, San Francisco.

**OFFICE BUILDING**, Chico, Butte County, Calif. State Dept. of Employment, owners. \$88,642. ARCHITECT: Herbert E. Goodpaster, Sacramento. 1 story frame and stucco construction. GENERAL CONTRACTOR: O'Connor Bros., Red Bluff. ELECTRICAL: Cox

Electric Co., Red Bluff. MECH: J. H. Blair & Co., Sacramento.

**ANIMAL HOUSE** at Radiation Laboratory, Berkeley, Alameda County. University of California, owner. DOP \$101,680. ARCHITECT: Hertzka & Knowles, San Francisco. 1 story of 5,750 sq. ft., reinforced concrete and frame with concrete block walls, hollow tile interior walls. GENERAL CONTRACTOR: A. J. Hopper Co., San Francisco.

**RESIDENCE**, Atherton, San Mateo County. Mrs. W. P. Baker, owner. 32 rooms, \$83,537. ARCHITECT: Angus McSweeney, San Francisco. Frame and stucco construction. GENERAL CONTRACTOR: A. F. Mattock, San Francisco.

**SANTA LUCIA GRAMMAR SCHOOL**, Salinas, Monterey County, Salinas Elementary School District, owner. 6-classroom addition, \$91,576. ARCHITECT: Chas. E. Bulner, Salinas. Frame and stucco construction. GENERAL CONTRACTOR: Geo. L. Fisk, Salinas.

**STORE AND OFFICE**, Reno (Nevada), Washoe County. Omslow S. Dodd, owner. \$379,875. ARCHITECT: Paul C. Overmir, San Francisco. STRUCTURAL ENGINEER: Hyman Rosenthal, San Francisco. 4 story & basement, 95x100. Class A, structural steel frame, reinforced concrete, porcelain enameled exterior, 2 elevators, steel windows and doors. GENERAL CONTRACTOR: A. J. Hopper Co., San Francisco.

**HIGH SCHOOL**, Ferndale, Humboldt County. Ferndale Union High School District, owner. 8-classroom, administration, science, home economics, agriculture, shop, cafeteria, library and toilet rooms, \$240,979. ARCHITECT: Frank T. Georgeson, Eureka. Frame and stucco construction concrete floor with radiant heating, asphalt tile. GENERAL CONTRACTOR: A. C. Johnson & Sons, Eureka.

**MADISON GRAMMAR SCHOOL**, Stockton, San Joaquin County. Stockton Board of Education, owner. 8-classroom, 2-kindergartens and toilet rooms, \$187,130. ARCHITECT: Victor Golbraith, Stockton. Frame and stucco construction. GENERAL CONTRACTOR: Geo. Roek, Stockton.

**CUTTEN GRAMMAR SCHOOL**, Eureka, Humboldt County. Cutten Elementary School District, owner. 4-classrooms, administration and toilet rooms, \$106,968. ARCHITECT: Frank T. Georgeson, Eureka. Frame and Stucco construction with concrete radiant heating floors, asphalt tile. GENERAL CONTRACTOR: Glen Nash, Eureka.

**THREE SWIMMING POOLS**, Fresno, Fresno County. Fresno Board of Education, owner. Roosevelt, Edison, Fresno high schools, \$224,958. ARCHITECT: Franklin & Simpson, Fresno. Reinforced concrete construction. GENERAL CONTRACTOR: Paddock Engineering Co., Fresno.

## MONSON BROS.

building  
construction

475 Sixth Street San Francisco 3

DOuglas 2-5357

## Where to place telephones for convenience, quiet, comfort



Plan for telephone service where the users will spend most of their time. It's wise to locate telephones away from busy halls and doorways where noise and distractions are greatest. And be sure to plan a resting place for the telephone...and the user.

Modern home planning calls for extra outlets and built-in conduit. The cost of concealed wiring is small; customer-appreciation, great. For free help in planning, call your local Pacific Telephone office and ask for "Architects and Builders Service."

Put built-in telephone facilities in your plans



Pacific Telephone

## IN THE NEWS

### MUNICIPAL HOSPITAL FOR ROSEVILLE

The City of Roseville (California) has completed plans for the construction of a new 25-bed Municipal Hospital at an estimated cost of \$250,000.

The building will be of one story, reinforced concrete construction with a steel roof.

Clarence C. Cuff of Sacramento is the architect.

### ENGINEER SELECTED DISPOSAL PLANT

The Clyde C. Kennedy engineering firm of San Francisco has been selected by the City of Sacramento to design a sewage disposal plant, which is to be located west of the Sacramento airport.

Of reinforced concrete construction the project is estimated to cost \$4,400,000.

### SHOPPING CENTER

Construction has started on a new shopping center consisting of a super market and eight stores on El Camino Real and Scott Lane, near Santa Clara.

Of one story frame and stucco construction the project will cost \$150,000.

### NEW BANK AND OFFICE BUILDING

The Security National Bank of Reno, Nevada, has started construction on a new bank and office building on West First Street in Reno.

## ACOUSTI CELOTEX

Sound Conditioning

... combines the correct materials and 25 years experience in every type, size and technique of acoustical installation

Acoustical Contractors

# WESTERN ASBESTOS COMPANY

San Francisco: 675 Townsend, KL2-3868  
Oakland: 251 Fifth Avenue, GL 1-2345  
Sacramento: 1224 Eye Street, GI 2-8991  
Stockton: 733 So. Van Buren St., 4-1863  
Fresno: 434 "P" Street, 2-1600  
San Jose: 460 Park Avenue, CY 3-1317

Two-story and basement the building will be of brick and structural steel construction and will cost in excess of \$350,000.

### ARCHITECT SELECTED ON HOUSING PROJECT

The architectural firm of Alford & Thomas of Bakersfield has been chosen by the Housing Authority of Kern County to draft plans for a twenty-five unit low income housing project at Wasco, California.

Cost of the project has not been announced.

Architect Ernest L. McCoy of Bakersfield has been selected by the same authority to design a 150 unit low income housing project to be built in Bakersfield. Cost not announced.

### CALIFORNIA STATE EMPLOYEE BUILDING

State funds have been allocated for the construction of a State Employee Building on 7th and 9th streets and Capitol Avenue in Sacramento.

Estimated cost of the building is \$8,000,000 according to Anson, Boyd, State Architect.

### BIDS FOR ARMORY ARE REJECTED

The State of California, Division of Architecture, has rejected a bid of \$306,575 for the construction of a type-H Armory Building in Richmond, California.

The building is to be 80x140 ft., with a 2-story lean-to along three sides, and of reinforced concrete rigid steel bents, wood roof and concrete floor.

### BUILDS HIGH VOLTAGE TRANSMISSION LINE

Harker & Harker electrical contractors of Reno, Nevada, have been awarded a contract by the U. S. Navy, Bureau of Yards and Docks, San Francisco, for the construction of a high voltage transmission line at the Naval Ammunition Depot near Hawthorns, Nevada.

Certain present equipment will be replaced and new installations made.

### TWO NEW DORMITORIES FOR SAN JOSE STATE COLLEGE

The Division of Architecture, State of California, at Sacramento, has announced plans for the construction of two new dormitory buildings on the campus of the San Jose State College at San Jose.

Each of the new buildings will be three story in height, of reinforced concrete construction, and will house approximately 200 men in one structure and 200 women in the other.

Cost of the project is \$1,450,000.

### STANISLAUS COUNTY HOUSING PROJECTS

The Housing Authority of Stanislaus County has chosen architect Donald Powers of San Francisco to draw plans for low income housing projects in Oakdale, Turlock, and Ceres.

Contract for some seventy-four units has been awarded to Harvey & Rose, contractors of Arcadia at a cost of \$620,000.

### CONVENT

The Roman Catholic Archbishop of San Francisco has announced plans for the construction of a Convent in Vallejo, California.

To be located at Tuolumne and Marilyn Place, the building will be of one and

two story, frame and stucco construction with a tile roof.

Ryan & Lee of San Francisco are the architects. Cost of the project is \$100,000.

### NAVY HOUSING PROJECT

H. C. Baumann, architect of San Francisco, has been chosen by the U. S. Navy to draft plans for a 55 unit Navy Housing Project to be built in Oakland to serve the Naval Hospital in the Oak Knoll District.

### HEALTH CENTER BUILDING PLANNED

Plans for the construction of a new County Health Center Building have been announced by the Kings county Board of Supervisors.

The building will be erected in Hanford, California, at an estimated cost of \$100,000. Horn & Martland of Fresno are the architects.

### FEDERAL FUNDS FOR ARSENAL BUILDING

The Commanding Officer of the Benicia Arsenal at Benicia, California, has announced that Federal funds in the amount of \$5,050,000 have been allotted for the construction of two new warehouse buildings at Benicia.

The warehouses will be of reinforced concrete and structural steel construction.

### LOW INCOME HOUSING

The Yolo County Housing Authority has announced construction of a sixty unit low income housing project in the community of Knights Landing, near Woodland.

The houses will be of one and two story frame and stucco construction and the project will cost about \$540,000.

### APPLIES FOR NEW BUILDING PERMIT

The Leo J. Meyberg Company recently applied to the City of San Francisco for permit to construct a new seven-story and basement office building in San Francisco, at a cost of \$1,000,000.

Ward & Bolles are the architects.

### NEW APARTMENT BUILDING PLANNED

A corporation has been formed in Oakland for the purpose of building a new apartment building on California street, between Taylor and Jones streets, San Francisco, at an estimated construction cost of \$10,000,000.

The new building will be 15 stories high and of reinforced concrete and structural steel construction.

R. H. Cooley, Oakland, is the Structural Engineer.

### S. F. NEWSPAPER REMODELS BUILDING

The San Francisco Call-Bulletin recently completed remodeling of the newspaper's offices.

The work was done by the Cahill Bros. construction company of San Francisco.

### APPLIES FOR NEW BUILDING PERMIT

Woolworth Company recently applied to the City of San Francisco for a building permit to erect a new \$1,600,000 store building at the Northeast corner of Powell and Market streets.

The site is presently occupied by the Flood Building.

John J. Gould, San Francisco, is the Structural Engineer.



## MULLEN MFG. COMPANY

BANK, STORE AND OFFICE  
FIXTURES—CABINET WORK  
OF GUARANTEED QUALITY  
CHURCH SEATING

Office and Factory  
40-80 RAUSCH ST., Bet. 7th and 8th Sts.  
San Francisco  
Telephone UNDERhill 1-5815

### Thinking of Building?

From our cost records and experience, an advance estimate may be made from decidedly general information. Based on our knowledge of labor and material costs, gained on current jobs, such an estimate may be helpful in determining your construction program.

## SWINERTON & WALBERG CO.

ALL TYPES CONSTRUCTION  
SAN FRANCISCO • SACRAMENTO  
OAKLAND • LOS ANGELES • DENVER

### STATIONERY SCHOOL & OFFICE SUPPLIES

Printing Engraving  
Announcements

### CENTER STATIONERY

468 McAllister  
San Francisco UN 1-3703

### SCHOOL BONDS ARE VOTED

Voters of the Antioch-Live Oak Unified School District have approved a bond issue of \$3,000,000 for the construction of a new high school and grammar school building.

### PLAN CHILDREN'S HOSPITAL ADDITION

The Childrens Hospital, San Francisco, has applied for a building permit for the construction of an addition to the hospital property at 3700 California street.

Plans for the addition have been prepared by architects Skidmore, Owings & Merrill and call for a 5-story and basement, reinforced concrete structure, cost approximately \$1,800,000.

### FEAR CONTROLS IN BUILDING

According to a recent survey made by the National Association of Home Builders, the principal factors affecting builders' plans for 1951 operations are: Possibility of further government controls, present credit curbs including Regulation X, and lack of critical building materials.

### BIDS REJECTED

A bid of \$769,000 for the construction of a Sewage Disposal Plant for the city of Menlo Park has been rejected by the Menlo Park Sanitary District.

### SCHOOL BONDS VOTED

\$220,000 School Bonds were voted by the residents of the Fairfield Elementary School District for the construction of a 6-classroom addition to the Fairfield Grammar School.

### SCHOOL GETS STATE AID

The Farmersville Elementary School District of Tulare county has been granted a State Aid in the amount of \$335,000 for the construction of a new Grammar School Building at Farmersville.

### MORRISON ENLARGES

Marshall Morrison, Beverly Hills designer and builder, and partner in the firm of Kurt & Morrison, has become associated with the Tri-Engineering Corp'n of which he is half owner.

He is also president of the American Society of Designers.

The Tri-Engineering Corp'n manufactures precision aircraft hydraulic assemblies.

### NEW HOMES IN LOS ANGELES

Home builders of Los Angeles estimate the 1950 rate of new home construction was 249 units per day.

This is an increase of 42 new homes per day over the record set for the previous year, according to the Home Builders' Institute of Los Angeles.

### HIGH SCHOOL ADDITION

The Coalinga Elementary School District, Coalinga, California, has awarded a contract to the architectural firm of Marsh, Smith & Powell of Los Angeles for the preparation of plans for a 12-room, library, and administration office addition to the Coalinga Junior High School.

The addition will be of frame and stucco construction.

### ARCHITECT SELECTED

Architect Arthur D. Janssen and architect Wm. Daseking of Menlo Park, have been chosen by the Menlo Park Elementary School District to draw plans for an addition to the Hillview Grammar School.

Bonds have been voted for the project.

Phone GARfield 1-1144

## Thomas B. Hunter

DESIGNER OF HEATING

AIR CONDITIONING  
VENTILATING AND WIRING  
SYSTEMS, MECHANICAL  
AND ELECTRICAL EQUIP-  
MENT OF BUILDINGS

★

41 SUTTER STREET  
ROOM 710

San Francisco

California

## Scott Company

HEATING • PLUMBING  
REFRIGERATION

★

San Francisco

Oakland

San Jose

Los Angeles

## DINWIDDIE CONSTRUCTION COMPANY

## BUILDERS

CROCKER BUILDING

SAN FRANCISCO



## HERRICK IRON WORKS

STRUCTURAL STEEL  
REINFORCING STEEL

18TH AND CAMPBELL STS.  
OAKLAND, CALIF.  
Phone GLAncourt 1-1767

Fine  
**ENGRAVINGS**



**POOR  
RICHARD**

PHOTO ENGRAVING CO.  
320-324 COMMERCIAL STREET  
SAN FRANCISCO, CALIF.



# STOLTE INC.

**General Contractors**



**OAKLAND • CALIFORNIA**

## PITTSBURGH TESTING LABORATORY

**ENGINEERS AND CHEMISTS**

Testing and Inspection of Concrete,  
Steel and Other Structural Materials

Design of Concrete Mixes

Offices in all principal cities

651 Howard St., San Francisco 5  
EXbrook 2-1747

## MATTOCK CONSTRUCTION COMPANY



**BUILDERS**



604 MISSION STREET  
SAN FRANCISCO

Subscribe  
Now —

**ARCHITECT  
and  
ENGINEER**

**\$3.00  
Per Year**

## Index to Advertisers

AMERICAN Perlite Corp.....	44
ANGIER Pacific Corp.....	48
ARCHITECTS Reports.....	43
CLASSIFIED Advertising.....	42
CENTER Stationery.....	47
CLINTON Construction Company.....	36
COLUMBIA Steel Co.....	*
CONTINENTAL Water Heater Co.....	*
DINWIDDIE Construction Co.....	47
FULLER, W. P. Co.....	*
FORDERER Cornice Works.....	43
GLADDING McBean & Company.....	*
GREENBERG'S, M. Sons.....	*
HANKS, Inc., Abbott A.....	48
HAWS Drinking Faucet Co.....	30 & 31
HERRICK Iron Works.....	47
HOGAN Lumber Co.....	36
HUNT, Robert W., Company.....	48
HUNTER, Thos. B.....	47
JOHNSON, S. T. Co.....	*
JUDSON, Pacific-Murphy Corp.....	36
KRAFTLE Company.....	28
MARBLE Institute of America.....	2
MATTOCK, A. F. Co.....	48
MICHEL & Pfeifer Iron Works.....	*
MONSON Bros.....	45
MULLEN Mfg. Co.....	47
NORTHERN California Electric Bureau.....	33
PACIFIC Clay Products Co.....	*
PACIFIC Coast Gas Association.....	38
PACIFIC Manufacturing Company.....	37
PACIFIC Portland Cement Company.....	Back Cover
PACIFIC Telephone & Telegraph Co.....	45
PARKER, Steffens & Pearce.....	43
PITTSBURGH Testing Laboratory.....	48
POOR Richard Engraving Co.....	47
PORCELAIN Enamel Architectural Division, Publicity Bureau.....	35
REMILLARD-Dandini Co.....	48
REPUBLIC Steel Corporation.....	37
SCOTT Co.....	47
SIMONDS Machinery Company.....	37
SISALKRAFT Company.....	36
SMOOT-Holman Company.....	34
SOTO, Henry; Landscape.....	34
STANLEY Works, The.....	35
STOLTE, Inc.....	48
SWINERTON & Walberg Co.....	47
U. S. Bonds.....	Inside Front Cover
UNITED STATES Steel Corp'n.....	*
VERMONT Marble Company.....	37
WESTERN Asbestos Company.....	46

\*Indicates Alternate Months

## REMILLARD-DANDINI Co.

**Brick and  
Masonry Products**



400 MONTGOMERY STREET  
SAN FRANCISCO, CALIF.

**Brownskin  
VAPORSEAL**

The resilient  
building paper  
creped to  
S-T-R-E-T-C-H

Quality Products Since 1895

**ANGIER PACIFIC CORPORATION**  
55 NEW MONTGOMERY ST. 7416 SUNSET BOULEVARD  
SAN FRANCISCO 5, CALIF. LOS ANGELES 44, CALIF.

A complete line of Angier products available  
from your building material dealer

## ABBOT A. HANKS, INC. Engineers & Chemists

INSPECTING — TESTING — CONSULTING  
CONCRETE • STEEL • MATERIALS  
CHEMICAL AND TESTING  
LABORATORIES

• RESEARCH AND INVESTIGATION •

TESTS OF STRUCTURAL MATERIALS  
DESIGN OF CONCRETE MIXES  
SHOP AND ERECTION INSPECTION OF  
STRUCTURES AND EQUIPMENT  
INVESTIGATION OF STRUCTURES  
AND MATERIALS  
TESTS AND INVESTIGATION OF  
FOUNDATION SOILS  
FIRE RESISTANCE AND INSULATION  
TESTS

624 Sacramento Street, San Francisco

## ROBERT W. HUNT CO.

**ENGINEERS**

**INSPECTING TESTING**

**STRUCTURAL MATERIALS  
CONCRETE MIX DESIGN  
CHEMICAL ANALYSIS  
EQUIPMENT**

PRINCIPAL CITIES  
UNITED STATES • EUROPE  
SAN FRANCISCO LOS ANGELES  
PORTLAND SEATTLE

# ARCHITECT AND ENGINEER

MODIFIED RANCH HOME OF MR. & MRS. FRANK E. TRIPP—Designed by Frank



FRANK E. TRIPP, ARCHITECT

APRIL

1951

"The bonds William and I bought  
for our country's defense  
helped build a house for us!"

HOW U. S. SAVINGS BONDS PAID OFF FOR  
MRS. ROSE NYSSSE OF BRISTOL, PA.

"There's nothing more wonderful than a house  
and garden of your own," says Mrs. Nyssse.

"And there's no surer way to own one than  
to save for it through U. S. Savings Bonds  
and the Payroll Savings Plan!"



Mrs. Rose Nyssse says, "In 1942 William and I started making U.S. Savings Bonds a part of our plan for financial security. I joined the Payroll Savings Plan at the Sweetheart Soap Co. where I'm a supervisor, and began buying a \$100 bond each month. I knew that my money was safe and working for me all the time. Buying U. S. Savings Bonds is one of the surest, safest savings methods!"



"Savings Bonds alone made a \$5,000 down payment on our house!" says Mrs. Nyssse. "Altogether, we've saved \$8,000 just in bonds bought through Payroll Savings, and we're keeping right on with the plan. And when we retire, our bonds will make the difference between comfort and just getting by. Bond buying is a patriotic and practical way of building a cash reserve!"

You can do what the Nyssses are doing  
—the time to start is now!

Maybe you can't save quite as much as William and Rose Nyssse, maybe you can save more. But the important thing is to start now! It only takes three simple steps.

1. Make the big decision—to put saving first—before you even draw your pay.
2. Decide to save a regular amount *systematically*, week after week, or month after month. Even small sums, saved on a systematic basis, become a large sum in an amazingly short time!
3. Start saving automatically by signing up *today* in the Payroll Savings Plan where you work or the Bond-A-Month Plan where you bank. You may save as little as \$1.25 a week or as much as \$375 a month. If you can set aside just \$7.50 weekly, in 10 years you'll have bonds and interest worth \$4,329.02 cash!

You'll be providing security not only for yourself and your family, but for the blessed free way of life that's so important to us all. And in far less time than you think, the financial independence the Nyssses enjoy will be yours to enjoy as well!

FOR YOUR SECURITY, AND YOUR COUNTRY'S TOO, SAVE NOW—  
THROUGH REGULAR PURCHASE OF U. S. SAVINGS BONDS!



Your government does not pay for this advertisement. It is donated by this publication in cooperation with the Advertising Council and the Magazine Publishers of America as a public service.

# ARCHITECT

Vol. 185 No. 1

# AND ENGINEER

ARCHITECTS' REPORTS—Published Daily

## Contents for

# APRIL

EDITORIAL NOTES . . . . .	4
THE GROWTH OF INDUSTRIAL DISTRICTS . . . . .	5
By ROBERT P. DANIELSON, Industrial Planning Consultant	
STANDARD MODULAR CONFERENCE . . . . .	5
JOINT INFORMATION COMMITTEE . . . . .	6
American Institute of Architects & Producers Council, Inc.	
NEWS & COMMENT ON ART . . . . .	7
THE AMERICAN INSTITUTE OF ARCHITECTS STANDARD CONTRACT FORMS . . . . .	8
By WILLIAM STANLEY PARKER, F.A.I.A.	
RESIDENTIAL "BEL VISTA," Palm Springs, California . . . . .	10
Architects: CLARK AND FREY	
HEALTH CENTER, Palm Springs, California . . . . .	13
Architects: CLARK AND FREY	
MODIFIED RANCH HOME, Mr. & Mrs. Frank A. Tripp, Eugene, Oregon . . . . .	15
Architect: PERCY D. BENTLEY, By ARTHUR W. PRIAULX	
CONSTRUCTION FIRM FINDS EXTRUDED ALUMINUM SCAFFOLDING VERSATILE . . . . .	20
By MARCIA LEE	
A.I.A. ACTIVITIES . . . . .	26
WITH THE ENGINEERS . . . . .	28
PRODUCERS COUNCIL PAGE . . . . .	30
Edited by CARL B. FRANK, Detroit Steel Products	
BOOK REVIEWS, Pamphlets and Catalogues . . . . .	36
ESTIMATOR'S GUIDE, Building and Construction Materials . . . . .	39
ESTIMATOR'S DIRECTORY, Building and Construction Materials . . . . .	41
BUILDING TRADES WAGE SCALES, Northern, Central & Southern California . . . . .	42
CLASSIFIED ADVERTISING . . . . .	42
CONSTRUCTION CONTRACTS AWARDED, General Data . . . . .	44
IN THE NEWS . . . . .	46
INDEX TO ADVERTISERS . . . . .	48

EDWIN H. WILDER  
Editor

MARK DANIELS, A.I.A.  
Associate Editor

J. WELLS HASTINGS  
Contributing Editor

PROF. LELAND VAUGHAN  
Landscape Architecture

JOHN A. BLUME  
Structural Engineering

MICHAEL GOODMAN  
Planning

JOHN S. BOLLES, A.I.A.  
Book Reviews



### COVER PICTURE

MODIFIED RANCH HOME  
Eugene, Oregon

This outstanding rural type home for city living was designed by architect Percy D. Bentley for Mr. and Mrs. Frank A. Tripp.

It is an excellent example of home design and construction adjusted to meet the desires of the owners and site. (See story on Page 17.)

ARCHITECT & ENGINEER  
is indexed regularly by  
ENGINEERING INDEX, INC.

ARCHITECT AND ENGINEER (Established 1905) is published on the 15th of the month by The Architect and Engineer, Inc., 68 Post St., San Francisco 4; Telephone EX3006 2-7182. President, K. P. Kierulff; Vice-President and Manager, L. B. Penhorwood; Treasurer, E. N. Kierulff.

Los Angeles Office: Wentworth F. Green, 439 So. Western Ave., Los Angeles 5; Telephone HEMpstead 3171.

Entered as second class matter, November 2, 1905, at the Post Office in San Francisco, California, under the Act of March 3, 1879. Subscriptions United States and Pan America, \$3.00 a year; \$5.00 two years; foreign countries \$5.00 a year; single copy 50c. ARCHITECTS' REPORTS are published daily from this office, Vernon S. Yallop, Manager, Telephone DOuglas 2-8311.





# EDITORIAL NOTES

## THE ROLE OF THE ARCHITECT

The importance of the first steps of homebuilding cannot be over-emphasized, and the valuable advice of an Architect from the start can help assure you of a long term of complete satisfaction in the final results.

Whether you are contemplating the construction of a new home, industrial plant, or commercial building; or whether you plan on remodeling some present structure; or whether you are merely considering the purchase of a piece of property, the qualified Architect can help to achieve your desires in the way best suited to your needs.

It is easy to obtain an Architect's services and a good investment to take advantage of the step by step part he can play in the selection, design and construction of any building you have in mind.

\* \* \*

AN outbreak of PEACE would find the U. S. economy vulnerable, careful observers believe as there is every evidence of much consumer scare buying.

\* \* \*

## NATIONAL HOME BUILDERS ADOPT "CODE OF ETHICS"

Of more than just passing interest and concern to the general public is the announcement that a CODE OF ETHICS, which is binding upon all members throughout the nation, was approved unanimously by the National Association of Home Builders at their recent seventh annual convention in Chicago.

In the preamble to the new code, under which the vast majority of new homes will be constructed in the future, the Association asserts its intention to place home-ownership within the reach of every American family; to strive for well-designed, constructed and located homes, and to maintain the nation's entire building industry under the free American enterprise system, unhampered by needless governmental regulations, restrictions and competition.

To achieve these objectives, which are of great importance to every prospective home owner-builder, members of the NAHB pledged themselves to the following principles:

1. A paramount responsibility to customers, community, and nation.
2. High standards of health, safety and sanitation will be carefully considered in all home building.

3. The right of a fair return for goods and services shall be upheld in relations with labor and other segments of the building industry.

4. Research for improving materials, techniques, equipment, and home financing methods will be vigorously pursued.

5. Sound legislative proposals affecting the building industry will be supported and widely publicized.

The new CODE OF ETHICS was adopted after revision by the convention of a study that has been revised and formulated for the past several years, and of course its ultimate value in the building industry will be measured in terms of strict observation of its aims and objectives by the vast number of builders throughout the nation who comprise the membership of the National Home Builders Association.

\* \* \*

PRIVATE builders have demonstrated they can build cheaper, faster and much more efficiently than can the government.

\* \* \*

## STATE AND LOCAL SPENDING

The total expenditures of state and local governments are now about as large as the non-military expenditures of the Federal government (excluding interest on debt in both cases). Economy in the operation of state and local governments is not merely a matter of concern to the citizens of the particular states or localities; it is a matter of national concern.

The national concern with state and local economy can be brought to bear effectively only through the assistance of the local citizens. This is one of the most important points at which the voluntary cooperation of the public must be enlisted in an economic stabilization program.

\* \* \*

## THE ARCHITECT'S FEE

It is quite clear that under the title of "Architect" you engage an artist, an engineer, a cost consultant, an advisor, an accountant and a representative who protects your interests with the contractor.

His fee, like that of most other professionals, is not regulated by statutes, it is customarily based upon a percentage of the cost of the house or structure to be built.

You will find it a safe policy to "consult an architect" before you act.

# THE GROWTH OF INDUSTRIAL DISTRICTS

By ROBERT P. DANIELSON

Industrial Planning Consultant\*

## What are "Industrial Districts"?

In recent years a new working environment has been developed which is specialized in design, but versatile in application. Usually termed an Industrial District or Tract, its characteristics have become more or less stabilized, and can be generally described as follows: an "Industrial District" is a tract of land provided with utilities, transportation facilities, and certain other services in accordance with a predetermined integrated, and comprehensive plan, for use by a group of individual concerns.

## What is Their Background

As now conceived, this type of development has a history of at least thirty years' duration. The Bush Terminal in New York, the Central Manufac-

*\*Editor's Note: Robert P. Danielson, associated with the San Francisco architectural firm of Kitchen & Hunt, is the author of "Industrial Locations in the San Francisco Bay Area" and a recognized authority on problems of industrial and public agency location. He is also author of an analysis of "Current Industrial Land Values" published monthly by his office.*

turing Districts of Chicago, to name two early examples, have for many years provided facilities and services for collectively housed industries. In both cases, however, there was a heavy reliance on sources of revenue derived not from rental of land and buildings but from the movement of tonnage, by rail or ship. In this era, investment in industrial real estate was a marginal proposition, generally avoided by conservative capital, and it was upon freight revenues that chief reliance was placed. This condition has been equalized, perhaps reversed in the past ten years.

But the most striking change has taken place in the matter of plant layout. Whereas Bush and Central Manufacturing featured six or eight-storied buildings capable of housing numerous companies under one roof, the more recent practice has been to spread out horizontally so that we now may have several acres of land for just one plant.

During the intervening years interest in "Industrial District" operations spread through the Middle West, South-West, and Far West. The New York-

(See Page 24)

---

## STANDARD MODULAR CONFERENCE—Materials, Equipment

Standard "modular" sizes for materials and equipment can help the building industry keep construction up to a high level despite scarce materials and manpower, Howard Coonley, conservation consultant to the National Security Resources Board, declared at a recent meeting of contractors, architects, producers of building materials, and manufacturers of building equipment at the American Standards Association headquarters in New York. A concerted effort toward coordination in the building industry is urgently needed as one of the most effective means of conserving scarce materials, and conservation in construction will be one of the first problems tackled by the Conservation Coordinating Committee now being organized in Washington.

Representatives at the meeting were members of Committee A62 on Modular Coordination of the American Standards Association. The committee is sponsored by the American Institute of Architects, Producers' Council, and the National Association of Home Builders. The modular coordination system being worked out by this committee provides building equipment and materials in standard size units that fit together without having to be cut and fit during construction.

"Almost all concrete block and glazed tile made in this country are modular; so are most of the stock wood windows and glass block; and metal windows and brick are widely available in modular sizes," reported Theodore Coe, Technical Secretary of the American Institute of Architects.

Subcommittees now working to adapt the modular unit to sizes of materials and equipment in their industries reported on: masonry made of structural clay products; wood doors and windows; masonry made of concrete; metal windows; natural stones; structural wood; building layout; structural steel; miscellaneous metal products; cast-in-place concrete; window accessories; glass block; metal doors; cast stone; kitchen equipment; and toilet partitions and shower stalls.

New standards for coordinated dimensions of kitchen equipment and toilet partitions and stalls have been completed in preliminary form. Industries representing a wide variety of kitchen equipment—ranges, refrigerators, sinks, laundry equipment, wood and metal cupboards, etc. have taken part in this work. It is expected that it will be cleared for final approval very soon.

(See Page 33)

# JOINT INFORMATION COMMITTEE

AMERICAN INSTITUTE OF ARCHITECTS and THE PRODUCERS COUNCIL, INC.

---

A meeting was held late in March which was called by the California Council of Architects in the offices of Al Williams, A. I. A. The meeting was presided over by Al Williams and moderated by F. Bourn Hayne, A. I. A.

The purpose of the meeting which was attended by L. C. Cole, L. C. Cole Co. and Pacific Coast chairman of the Advertising Agencies Association of America; Charles Collier, executive secretary of the Advertising Association of the West; George C. McNutt, George C. McNutt Advertising Agency; Bradford Collins, Brisacher, Wheeler & Staff; Tail Smith, chairman of the Joint Information Committee of the Producers Council; John Cowley, The Brookman Co., and the secretary of the California Council of Architects was to promote a meeting of minds between the advertising profession who prepare technical literature and the architect who uses the result.

After introducing the problem to the meeting, Bourn Hayne illustrated the problems confronting the architect stressing that the profession is eager to use the materials manufactured, but in many cases is handicapped by inaccurate and poorly prepared technical literature. The responsibility of the situation was not placed in any division of construction or design or preparation of descriptive material, but was presented as a mutual error with all concerned.

The A. I. A. resolution covering preparation of technical literature was considered outmoded and in general not distributed to the advertising profession whose responsibility it is to prepare technical literature for the manufacturer. A poll of those representatives of advertising agencies present revealed that none of them were aware that such A. I. A. information existed.

The proposal of the California Council of Architects was for the creation of an editorial Advisory

board for manufacturers technical literature which could be used by the manufacturer on request. This board would function for the sole purpose of assisting in better preparation of technical literature and uniform specifications. The board would have to charge a fee to the individual user of its facilities for time consumed and mailing of information to chapter members.

In the ensuing questions and discussion that developed Al Williams answered a direct question from L. C. Cole concerning what impressed an architect with this explanation. He said he believed there were two kinds of impressions that an architect gained from available promotion. The momentary appeal and recognition obtained through advertising and the factual information through catalogs which if useful can be filed.

Elaborating Mr. Williams said that fully 70 per cent of the time an architect is a salesman of building products and that A. I. A. research has proven when a product is specified by an architect it is used in the structure 93 per cent of the time.

In spite of the fact that the architect is anxious to use material providing information it was revealed that most of the direct mail received is immediately filed in the waste basket because it is valueless.

A suggestion was made that this information be disseminated to advertisers and their advertising agencies through magazine promotion and that the architectural profession be advised in the same manner. It was pointed out that the Architect and Engineer has been pioneering just such a program in this page for 9 months and is continuing this feature.

The meeting was adjourned with a motion to reconvene after the California Council of Architects has formulated a procedure for the manufacturer to produce information that will answer the architects' need.

---

*NOTE: This news space is being contributed by ARCHITECT & ENGINEER Magazine to the JOINT INFORMATION COMMITTEE representing the Northern California Chapter of The American Institute of Architects and the Northern California Chapter of the Producer's Council, Inc., and is available to this Committee for the purpose of bringing to the attention of leaders within the Construction Industry various phases of the Architectural profession and Building materials industry procedures for general consideration and comment. Your "ideas" and any suggestions for the better pooling of thoughts along these lines should be sent to "Joint Information Committee, c/o The Architect & Engineer, 68 Post Street, San Francisco," where they will be immediately forwarded to the proper committee members.*

# NEWS AND COMMENT ON ART

## PORTLAND ART MUSEUM

Thomas C. Colt, Jr., director of the Portland Art Museum, West Park and Madison, announces that the Board of Trustees has purchased from the Jacques Lipchitz Retrospective, organized by the Portland Art Museum and shown last November, the "Sketch for Prometheus" and the "Sketch for Sacrifice," both of which are small bronzes. The board has also accepted a gift of 174 drawings and 19 carvings by C. S. Price, given by the artist's brother, Maurice Price.

At a special meeting of the board, Harold F. Wendel and W. P. Stalnaker were elected trustees.

The Artists of Oregon—1951 exhibit—opened during April. Members of the committee of selection include Alexander Archipenko, special instructor in sculpture at the University of Washington; Sherman Lee, assistant director of the Seattle Art Museum; and David McCosh, artist and associate professor in the School of Architecture and Allied Arts at the University of Oregon.

## MILLS COLLEGE ART GALLERY

The Mills College Art Gallery, Oakland, will feature a special group of exhibitions during April, according to Sidney M. Kaplan, director.

Among the events scheduled is an exhibition of Pottery by Bernard Leach, the Mills College Ceramic Guild, and the Staff.

Gallery hours are from 2 to 5 p. m. daily except Monday.

## SAN FRANCISCO MUSEUM OF ART

The San Francisco Museum of Art, War Memorial Building, Civic Center, will feature the following events and exhibitions during the month of April.

**EXHIBITIONS**—Sculpture by Bernard Rosenthal; Contemporary Sculpture and Drawings; 15th Annual of Drawings and Prints of the San Francisco Art Association; Prize winning Lamps and Designs from the Museum of Modern Art Competition (New York); A Studio Residence by Hillmer—a New Approach; a group of color photographs by Roy Flamm; the Harriet Levy Collection, and the 70th Annual of Painting and Sculpture of the San Francisco Art Association.

**SPECIAL EVENTS**—Philosophy of the New Architecture, by Marcel Breuer, sponsored by the San Francisco Museum of Art, the Northern California Chapter of the American Institute of Architects, and the School of Architecture, University of California. . . **WEDNESDAY EVENING** Lecture Series, by distinguished guest lecturers and out-

standing experts in their fields. **GALLERY TOURS** on Sunday and Tuesday at 2:30 p. m.

**ADVANCE** announcement has been made that the Barati Chamber Orchestra will present a special program on May 3 at 8:30 p. m.

## CITY OF PARIS

Beatrice Judd Ryan, Curator of the Rotunda Art Gallery of the City of Paris, San Francisco, has announced an Exhibition of Watercolors by Ynez Johnston, George Post and James Vance as a feature of the Gallery for the month of April.

In The Little Gallery, fourth floor, the Pictures of the Month exhibit will show a group of Watercolors by Frederick Cole.

## CALIFORNIA SCHOOL OF FINE ARTS

The California School of Fine Arts, 800 Chestnut Street, San Francisco, reports a large number of entries have been received for the Abraham Rosenberg Traveling Fellowship in Art of \$2400. The annual grant is designed to permit mature artists to carry out approved projects in the fields of Painting and Sculpture, and is intended primarily for study abroad. The jury of 1951 Award included Ray Faulkner, chairman, Art Department, Stanford University; Robert B. Howard, sculptor and instructor California School of Fine Arts; Felix Ruvolo, painter, professor of art, University of California; Ninfa Valvo, associate curator of painting, de Young Museum; and Archie Wedemeyer, director of art education, San Francisco public schools.

The Annual Competition for Scholarships, 1951-1952, have been announced. They are awarded to promising students and are open to high school and junior college students who are graduating during the present year.

An Exhibition of America's outstanding collection of photographs, representing more than 100 top prize-winning prints, will be shown during April. The winning photographs represent the selection from more than \$3,558 original entries.

## M. H. de YOUNG MEMORIAL MUSEUM

The M. H. de Young Memorial Museum in Golden Gate Park, San Francisco, has scheduled a number of special exhibits and events for April.

The Museum offers many permanent exhibitions in fine and applied arts, Egyptian, Greek and Roman, European and American, Asiatic, and American Aboriginal, as well as historical collections and many special exhibits.

(See Page 22)



# THE AMERICAN INSTITUTE OF ARCHITECTS STANDARD CONTRACT FORMS

By **WILLIAM STANLEY PARKER, F.A.I.A.\***  
**Chm. A.I.A. Committee on Contract Documents**

Contractors and architects alike are interested in construction projects and they are particularly interested in the terms of the contracts under which the work is done. It is the function of the Committee on Contract Documents of the Institute of which I am Chairman, to maintain constant scrutiny of the provisions of the standard forms issued by the Institute, to receive comments and criticisms concerning clauses that seem to need revision and from time to time to make recommendations for such revisions as seem to the Committee to be desirable.

I will refer here only to the Owner-Contractor Forms. The history of the basic form for use in lump sum contracts is briefly as follows: First Edition 1911, Second Edition 1915, Third Edition 1918, Fourth Edition 1925, Fifth and present Edition 1937. In the Second Edition there was a fundamental re-drafting. In the subsequent editions there were minor amendments only, but some were important.

The Third Edition adjusted a few provisions to make the document useful in New York. The Fourth Edition principally readjusted the order of the articles somewhat. The Fifth Edition was particularly concerned with revising the Fire insurance provision in line with the idea of the Builders-Risk, Completed Value Form of policy which the joint Committee of the AGC and AIA was then advocating with the underwriters and which became the standard form of policy throughout the country by 1941.

During the past few years, since the war, various suggestions have been received and have been given long continued and careful consideration. A good many seem to be on the whole undesirable when judged in the light of the basic requirement of the standard form which is devised to be as broadly useful as possible for all types of work in all sections of the country. Many desirable changes or additions could be devised that would be suitable general provisions for use in California but which would practically never be suitable for New England.

Earthquake conditions in California and Missouri, hurricane conditions in Florida, and other similarly regional conditions, which do not obtain all over the country, must be taken care of in contracts for structures in those areas. There may well be cooperative action in the industry in such regions to develop the additional standard provisions needed there and the Institute, I believe, might well serve as the publisher and distributor of such additional standard provisions but I feel it would be undesirable for the Institute, a national body, to assume responsibility for deciding regional specifications of that sort.

I have briefly indicated why some of the suggestions received are not accepted by the Committee as desirable for inclusion in a document intended for the wide and varied use that is the basic objective of the AIA Owner-Contractor form. Obviously, however, in such a matter there is room for a difference of opinion. The Committee, as the official custodian, as it were, of the documents feels a very keen responsibility for protecting the documents from unwise amendments that might seriously affect their broad usefulness. With this preamble let me discuss with you a few of the suggested amendments that the Committee does not approve and also a few of the suggestions which I believe the Committee may recommend to the Board of Directors of the Institute in its Annual Report this spring.

Article 17, Deductions for Uncorrected Work, provides that "If the Architect and Owner deem it inexpedient to correct work injured or done not in accordance with the Contract, an equitable deduction from the contract price shall be made therefor." It is claimed by some that the term "equitable deduction" is too vague and some precise method of evaluation should be used. The same objection is held to the similar phrase in the Owner Architect Agreement to determine payment for various extra services if they occur.

In both of these situations the conditions are indefinite and variable and no single standard of measurement is applicable. In each case the Architect's decision would be involved and all such decisions would be subject to arbitration if one of the parties felt the decision was unjust. Similar

\*EDITOR'S NOTE—Address by William Stanley Parker, F.A.I.A., Chairman of the American Institute of Architects Committee on Contract Documents, which he delivered at the recent AGC Annual Convention in Boston, Mass.

conditions would surround decisions in several other situations where "reasonable" extension of time, "reasonable" allowance for overhead and profit on extra work, and similar decisions to be based on reasonableness, are involved. The Committee feels that where conditions are variable they can only be appraised on a basis of what is equitable or reasonable in the light of the actual conditions in each case. The present phraseology seems proper.

Suggestions were received for amendments to Article 23 "Contractor's Right to Stop Work or Terminate Contract" in order to take care of emergencies arising as a result of decisions of public authorities in time of war or preparation for possible war. The Committee has a feeling that Article 23 offers a pretty adequate basis for such action as now phrased. It provides that if the work is stopped under an order of any Court or other public authority for a period of three months the Contractor can, on seven days written notice, stop work or terminate the Contract and recover for work done and any loss sustained and reasonable profit and damages.

Any stoppage of a job due to restrictions on use of materials, or other restrictions affecting construction would be due to some "order of a public authority." A three months period is hardly too long for necessary re-studies for use of alternative materials and methods. Any claims and decisions under Article 23 would be subject to arbitration.

The various clauses I have seen elaborating on this emergency action seem to me to be rather verbose and in some cases would permit drastic action by the Contractor in seven days, at the risk of serious hurt to the Owner.

The proportion of private operations to those under some public agency is likely to become less and less important if defense activities continue to increase as seems probable. All governmental agencies will draft their own emergency provisions. Important private projects will be developed with their own legal advice. It seems to me, at present, that there is no need to attempt to prepare standard provisions to take care of such emergencies, either for termination of contracts or escalator clauses, because they would not be used on any public work and probably not on any important private work. It seems best to let Article 23 stand, as a pretty adequate basis for stoppage or termination of a contract, and let individual owners and contractors negotiate any elaborations of the idea that they may feel are needed in each case.

In any event any such emergency clause should be added general conditions and not hasty amendments of carefully devised standard clauses which would require the issuance of a new edition at great expense and wastage of current stocks.

Article 34, Mutual Responsibility of Contractors, provides that in case of a suit against the owner by one contractor due to damage by another separate contractor the contractor, claimed to be the cause of the damage, shall defend the suit at the Owner's expense. About once a year some architect claims that this should be changed to read "at the Contractor's expense." If the case is proved against him then he does pay any judgment and also the costs of the defense. If no claim is proved against him there would be no justice in making him pay the cost of defending the owner in such a suit. The Owner's contingent liability policy, which he should take out, would in such case take care of the cost of defending the suit. The logic of this provision has been explained for many years in Institute publications.

Similarly the logic of including Article 37, Relations of Contractor and Sub-Contractor, which also has been explained in print for many years, is from time to time complained of by someone as surplusage because the Sub-Contractor is not a party to the contract and therefore cannot be bound by such a provision. But of course the Article does bind the Contractor, and any form of sub-contract that includes by reference the general conditions will then bind the sub-contractor.

This article, included first in the Second Edition in 1915, provides an easy method for binding sub-contractors under complete and uniform conditions. It was one of the important provisions in the Second Edition. Equally important was the board arbitration provision, and I like to remember that both of these provisions were initiated here in Boston in a joint Committee of the Boston Society of Architects and the Master Builders Association. I was invited to sit with the Institute Committee to represent the Boston Committee and was able to secure unanimous approval of these two, at that time, novel provisions as part of the Second Edition. They represent a definite contribution from Boston to the General Conditions as published by the Institute.

The Committee has been most actively concerned recently with the articles dealing with liability and fire insurance, due to a case in Spokane where a fire occurred in a Church in connection with an addition and certain related alteration work in the existing church building. The owner was insured and the face of the policy was paid. Then the Owner sued the Contractor at Common Law, without relation to the terms of the contract, charging negligence.

In round figures the original insurance paid was \$46,000. The suit claimed \$78,000 damage, in part for loss of use of the structure and other items.

(See Page 34)



*Photo by Julius Schulman*

# RESIDENTIAL "BEL VISTA"

PALM SPRINGS, CALIFORNIA

ARCHITECT: Clark and Frey

LOT: 100 feet x 112 feet

COST: \$13,500 per Unit  
(plus Furnishings)

**GENERAL VIEW**—from one of the houses located at the end of the street. Roofed outside area may be used as porch or carport.

Each house has its distinct and individual color scheme.



**LIVING ROOM CORNER**

The entrance door is at the left . . . view window in the center looks across Calle de Rolph. Asphalt tile floor.

Furnishings by House of Modern Interiors.

*Gayle's Studio, Photo*

**15 HOUSES "BEL VISTA" TRACT PLOT PLAN**

Identical floor plan for each house. A variation in appearance is obtained by staggering set-backs and by having different sides of houses face the street. The large size of each lot also contributes to the spacious feeling and privacy from adjoining property.

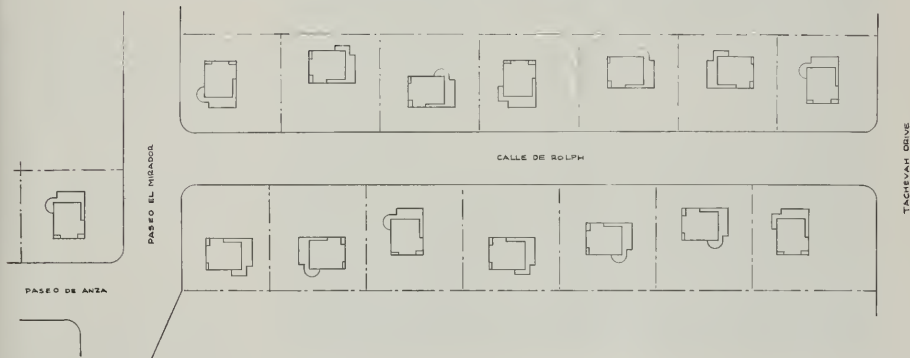



## BEL VISTA . . .

The "Bel Vista" residential development project adjacent to the city of Palm Springs, California, represents the open, spacious, type of home that has become so popular throughout Southern California and the Southwest.

The homes have been designed by the architectural firm of John P. Clark and Albert Frey of Palm Springs, to fulfill the requirements of those who seek casual, comfortable, desert living.

Although the floor plan for each of the fifteen homes in the group is quite similar, individuality in appearance is obtained by a shifting of the placement of the home on the lot, so that various

angles and sides of the structure face from the street.

Unusually well built, each home contains all the little details that make the difference between a house and a home.

Two of the three bedrooms have private entrances. The dining area opens onto the living room, giving additional spaciousness. Ample closet space, liberal use of glass, and functional arrangement of rooms contribute to the popularity of the house. The kitchen is separate, and the service room opens onto a walled service yard. Gas is used for heating.

### FLOOR PLAN—

Compact arrangement of rooms and central location of utilities. Gas hot-air heater for entire house is located between the living room and the hall. Two bedrooms have additional access from outside for convenience. Cement floors, frame and stucco walls, and composition roofing.



DINING ALCOVE located off the living room. Door to kitchen is behind the corner at the right. French doors open to the porch for outdoor meals.

Furnishings were supplied by House of Modern Interiors.

*Gayle's Studio Photo*



*Photo by Julius Schulman*

# HEALTH CENTER

PALM SPRINGS, CALIFORNIA

ARCHITECT:

Clark and Frey

A tax supported, free clinic, sponsored by a local Welfare Society. Periodic examinations of out-patients by resident and county physicians. Also contains a Children's Clinic.

Cement floor, walls are of frame and stucco; built-up roofing with aluminum surfaced capsheet for heat reflection. Evaporative coolers have been installed on the roof.

**FLOOR PLAN**

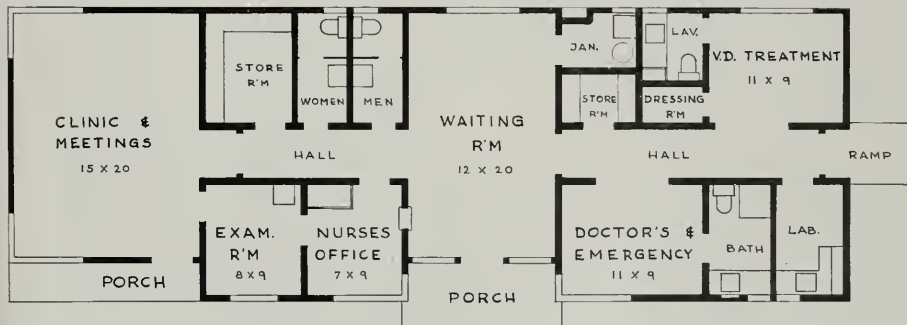

WEST PROPERTY LINE

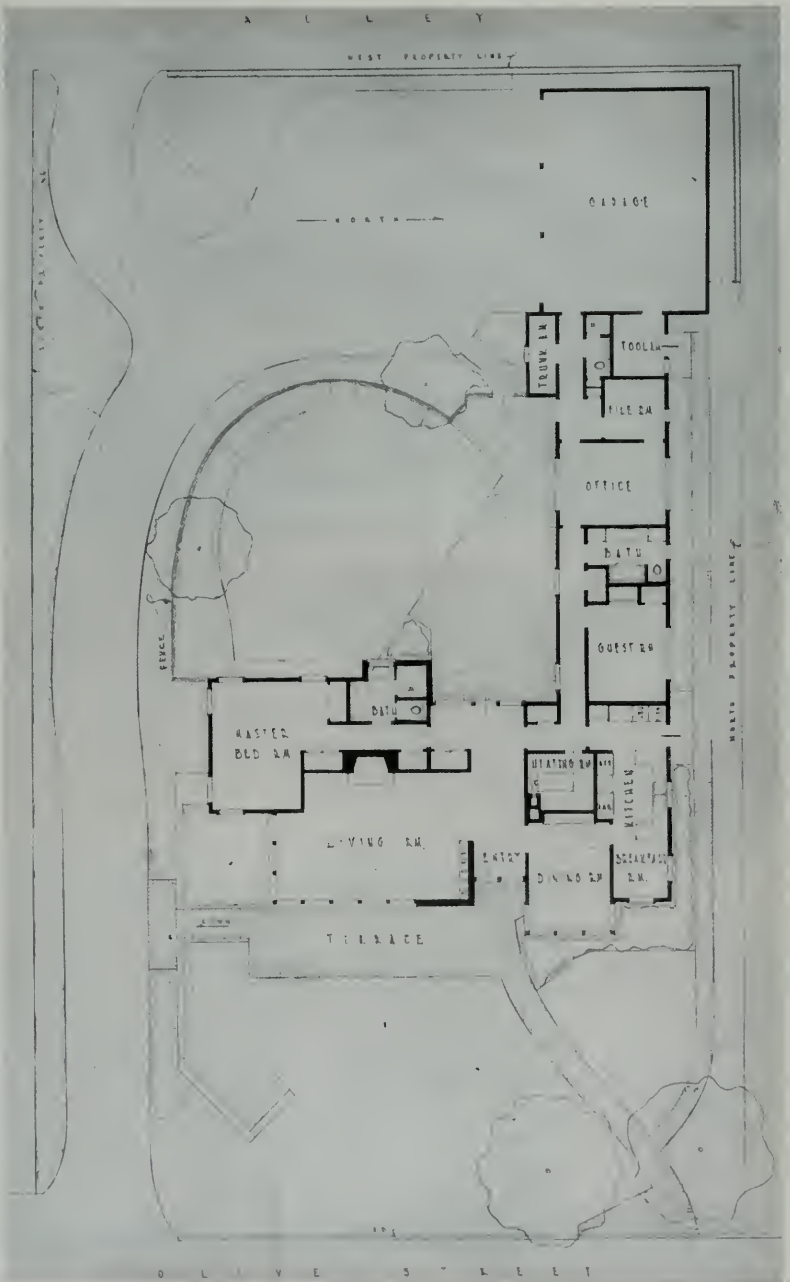

O L I V E S T R E E T

# MODIFIED RANCH HOME

MR. and MRS. FRANK A. TRIPP  
EUGENE, OREGON

ARCHITECT: Percy D. Bentley

By **ARTHUR W. PRIAULX**

Half way up Eugene's rolling South Hills is one of Oregon's newest and most distinctive homes, a modified ranch styled, single-story frame structure of unusual, yet practical design.

Architect Percy D. Bentley, who has designed some of the most talked-about homes in the Willamette Valley, in this home for Mr. and Mrs. Frank A. Tripp, has achieved another spacious, livable and pleasingly different residence.

The Tripp home snuggles against a shell, part way up a hill, and the low lines of the ranch styling make it ideally adapted for its location. Thermo-pane windows along the full east side of the living room and half way across The Amazon with a back-stop of the snow-capped Cascades, visible on clear days.

The exterior of the Tripp residence is finished in ten-inch vertical-grain v-joint machined and

**PRIVACY**  
rules the spacious  
outdoor living  
space of the  
rear yard.

*Photos by*  
**H. D. FEHLY**





## MODIFIED RANCH HOME . . .

dressed white-painted Western red cedar. The ranch effect has been cleverly used in the rear where a six-foot, white-board fence encloses a part grass and part cement patio. The fence, built on a sweeping curve, gives privacy from the driveway, which swings around the main building into a three-car garage.

The building is L-shaped with one side of the L facing the street. This section contains the living room, entrance hall and dining room, with the master bedroom and hall space opening onto the patio occupying the portion facing the west. The other part of the L, which is at right angles to the street, contains the kitchen, utility room, bedroom,

office for Mr. Tripp, furnace room, garage, workshop, filing room and a tiny extra office space. Full baths adjoin both bedrooms in the opposite wings of the home.

Probably the most unique feature of this home is the rather remarkable use of space in the living room, halls and master bedroom. Architect Bentley has departed from the conventional wall in this section of the house to use wing walls. A wing wall breaks the space on the left as you enter the home. On the living room side the wing wall appears as a book case. The wing wall separating the living room and the master bedroom provides space for linen storage and closets along a hall to the bedroom.

**Triple garage space and driveway are separated from the rear yard by attractive curved fence to emphasize "exclusiveness and privacy" of yard.**



. . . MODIFIED RANCH HOME



A Woman's Dream come true is this dining room with indirect lights, and built-in dish cupboards with indirect lights.

Living Room  
viewed from the hall fea-  
tures the picture windows.



The Living Room becomes the entrance hall as floors are merely broken by wing walls. The idea of spaciousness is impressive.

## MODIFIED RANCH HOME . . .

This Private Office space in kitchen and garage wing of home gives idea of door and wall trim.



Utility Room  
is extension of kitchen opposite from breakfast nook. Laundry equipment occupies minimum of wall space.

Breakfast Nook and Kitchen are broken by work-table built-in. Compactness is keynote of this step saving kitchen area.



A fireplace of verd antique marble facing gives distinction to the living room.

The dining room carries out the motif of unusualness. One wall is a built-in china cupboard with plate glass sliding doors. The cupboard is lighted with slim-line tube lighting to give a warm, mellow effect. This room itself is lighted by indirect fluorescent tubes concealed in a cornice which extends around the four walls.

A wing wall divider becomes completely utilitarian in separating the utility room and the kitchen, appearing as a full wall of cupboards on the kitchen side. A low counter divides the compact kitchen from the roomy breakfast nook.

The home has no basement, but there is ample storage space throughout in the wing walls and halls where closet space occupies what would normally be waste space. An oil furnace supplies hot water heat for a strip radiation system in every room.

All outside walls and ceilings have been insulated to insure maximum comfort in every season.

Floors throughout are built of half-inch plywood. Wall-to-wall carpeting has been used in every room except the kitchen, utility room, rear hall and office space. Interior walls are plastered. Roof is built of cedar shingles.

We believe that Architect Bentley has solved the problem of adapting this home to the physical characteristics of the building space. More important, he has developed in the actual design many features which make the home more attractive and which give the owners comfort, beauties of view, privacy and constant pleasure in daily living.

Landscaping has been studiously and excitingly planned. A rock wall cuts away a portion of the hillside to make space for the driveway. Lawns roll up the hill to a ground-flush cement porch, without cover, which fronts along the full length of the living room. The homey patio provides the Tripp family with pleasant outdoor living quarters for the long summer and fall days. Here is a home in the Oregon pattern.

**Patio blends with grass area in this "outdoor living room." Fence gives illusion of defining landscaped space and emphasizes intimacy of home outdoors.**







Aluminum scaffold provides level working platforms and minimum sidewalk obstruction for this sloping San Francisco work site  
*Moulin Studio Photos*

## CONSTRUCTION FIRM FINDS EXTRUDED ALUMINUM SCAFFOLDING VERSATILE

By **MARCIA LEE**

Joseph Barnes of the Joseph L. Barnes Construction Company of San Francisco is one of the pioneers in the use of extruded aluminum pipe and clamp scaffolding, a product introduced to the market by the Beatty Safway Scaffolding Company a year ago and now distributed nationally.

Barnes tried out the product in the re-finishing of a two-story corner store building in downtown San Francisco where the problem of a steeply sloping grade and heavy sidewalk traffic called for an exceptionally flexible scaffolding. (See illustration above.)



Aluminum and steel type scaffold is used in this instance to provide a safety sidewalk canopy as well as a base for the superstructure on the Shattuck Hotel in Berkeley, California.

"For this particular job," Barnes relates, "we needed scaffolding that could easily be adjusted to provide a level plane of operation on a sloping grade. In addition, we needed a scaffolding that would reduce sidewalk obstruction to a minimum and allow unrestricted egress to the half dozen separate stores in the building which were doing business as usual. Appearance of the scaffolding, too, was an important consideration in this central area. The new Aluminum Scaffolding filled all these requirements.

"Adjustments of height and width were simple. The horizontal members of the scaffolding can be attached securely to the vertical members at any desired height by means of a right angle clamp. Diagonal members, to give extra rigidity where necessary, attach to the vertical members with swivel clamps.

"The structure, covering approximately 5000 square feet, was erected 8', 10' and 13' scaffolding lengths, providing three different platform levels to accommodate workmen on the second floor and allowing an 5' span between the sidewalk uprights, and a 6' 6" horizontal span allowing free access to stores.

"We were especially pleased at the rate at

which this aluminum scaffolding could be erected and dismantled. The structure was in place in 4 hours and dismantled in 2 hours. We figure this is just a sixth of the time that would be required for a similar wooden structure, and the metal also offers important advantages in strength and safety factors."

The ribbed aluminum scaffolding was developed by the manufacturing engineers as an accessory line to their regular line of scaffolding, and introduced in 1936 it has been hailed as a product that takes 90% of the hazard out of constructor work.

The aluminum tubing is made of a special alloy by the Reynolds Aluminum Company. It has a diameter of 2 inches, a .156 inch wall, weighs 1.06 pounds per lineal foot and is comparable to steel in strength. In physical working load tests, scaffolding on 7' CTS and 5' width was shown to hold a load of 482 pounds per square foot without failure.

The tubing comes in 6', 8', 10' and 13' lengths, each member fitted at the ends with bayonet-type connectors.

Installation of the new scaffolding begins with the placing of uprights into base plates, A 90°

Aluminum scaffold is adaptable for many uses. Here it is being used in conjunction with work on an oil refinery tower at Avon, California.

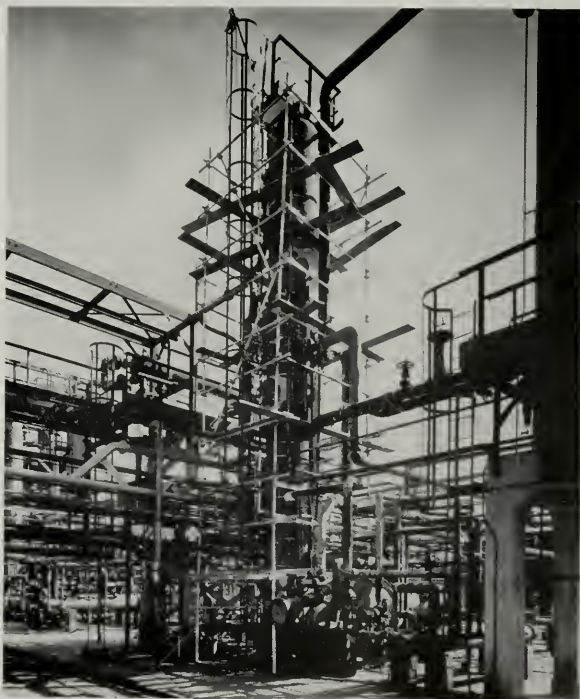



Cast aluminum male and female couplings join tubing ends.

twist locks each vertical member securely into the member below. Right angle clamps for the horizontal members and swivel clamps for the diagonal members complete the equipment. With these four basic parts, the scaffolding can be erected



Forged aluminum right angle clamp used to couple horizontal and vertical members.

to meet any height, width or interior design. The material, of course, is re-usable and being rust-proof, requires no painting. It can be purchased or leased, or, as in the case of the Joseph L. Barnes job described above, can be rented and erected by Beatty construction men on a contract basis.

All parts of the aluminum scaffolding are assembled in the manufacturer's new 2-acre plant in San Francisco, and current distribution of the product is from coast to coast, as the lightweight of the aluminum makes long distance shipping practicable.

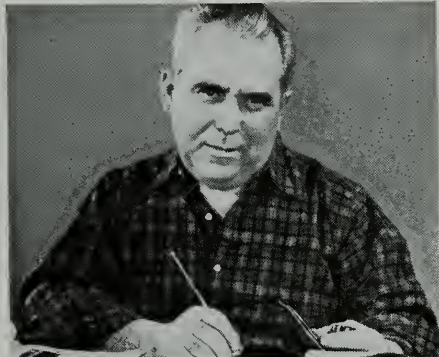

### Puts money on the line...

"I've been in the construction business for a long time—started as a carpenter 20 years ago. Couple of years later I had a chance to buy a partnership with my boss—a real opportunity! But I didn't have the money and someone else bought the job I should have had.

"That made me stop and think. Without funds, I'd be taking orders for the rest of my life. And nobody was going to give me money—I had to save it myself.

"Part of my next paycheck went to open a savings account with a bank I knew was reliable—it was California's Oldest National Bank. The deposit was small, but I was doing a hard thing in an easy way—developing the habit of thrift.

"As time passed, the deposits got bigger and the savings account seemed to leap ahead under its own power. Ten years ago I got my second chance and, believe me, I didn't miff this one! I was ready to put my money on the line.

"Now I'm the boss of a busy company, with fifty men working for me, and have plenty of capital besides that original savings account. But I still make savings deposits regularly—don't even go to the bank, just use the *Mailfroy*. Opportunity knocks often at the door of the man who can take care of it."

**CROCKER FIRST NATIONAL BANK**  
One Montgomery Street - San Francisco 20  
365-14th Street - Oakland 12

MEMBER F. O. C. - INSURED - DEPOSIT UP TO \$10,000

CLIP AND MAIL COUPON FOR COMPLETE INFORMATION

Savings Department, Crocker First National Bank  
One Montgomery Street - San Francisco 20, California - EXbrook 2-7700 or  
360-14th Street - Oakland 12, California - GLencourt 1-3230

I wish to open a Crocker Mailfroy Savings Account. Please send me full information.

Name \_\_\_\_\_ Telephone \_\_\_\_\_  
Address \_\_\_\_\_ City \_\_\_\_\_

## NEWS AND COMMENT ON ART

(From Page 7)

Educational activities include Lectures and Gallery Tours, Study Rooms, Art Classes, and an Art Reference Library.

An exhibition of work by the members of the faculty of the California School of Fine Arts, assembled by Elmer Bischoff, Edmond Gross, Bill Quandt and Ramsey Wieland, is currently being shown. The display represents the work of twenty-two of the school's artist-instructors and includes paintings, sculpture, serigraphs, lithographs, etchings, illustrations, commercial designs, photographs, textiles and jewelry.

### SAN FRANCISCO ART ASSOCIATION

Ernest Born, architect, has been chosen President of the San Francisco Art Association for 1951. Other officers named include George D. Hart, 1st vice-president; Mrs. Clarence Lindner, 2nd vice-president; William W. Crocker, Treasurer; and Ellen Bransten, secretary.

AS a basis of national policy, it should be clearly recognized that private industry, if not hindered by unnecessary and unrealistic restrictions, can provide housing wherever and when needed for defense.—W. P. Atkinson, pres. NAHB.



## THE SEGY GALLERY NEW YORK

An exhibition entitled "Congo Sculptures," sponsored by the Belgian Government Information Center, and featuring antique sculptures representing sixteen art producing tribes of the Belgian Congo, will be shown during April.

It is the first time the exhibit has been shown in the United States.

## THE ART ALLIANCE PHILADELPHIA

Cornelius Hahn, community planner of the Philadelphia Citizen's Council on City Planning, spoke in the Art Alliance Auditorium recently on the subject "Contemporary Landscape Architecture." His discussion was illustrated with color and black and white slides.

A comprehensive exhibit of contemporary architecture representing all sections of the nation was held during April. Among speakers and the jury of award were George Howe, chairman, department of architecture, Yale University; Dr. Jean Labatut, professor in charge of graduate studies in architecture, Princeton University; and Pietro Belluschi, dean of architecture and planning, Massachusetts Institute of Technology.

## HOME DESIGNING CONTEST

The second annual East Los Angeles Junior College house designing contest, conducted to encourage high school architecture students, has been started and will continue until the last week in May.

Participants may submit drawings individually to the college engineering department.

## A.I.A. GOLD MEDAL

The A.I.A. Gold Medal Award will be presented to Bernard Maybeck, Bay Area architect, at the annual convention of the American Institute of Architects in Chicago in May, according to an announcement from the Association's Washington, D. C. Offices.

## LOS ANGELES COUNTY ESTABLISHES INDUSTRIAL PROJECTS RECORD

Building permits for the first month of 1951 set a new monthly record for industrial construction and permits for commercial building rose to a near record level despite inauguration of controls by the National Production Authority.

Totals surged 476 per cent ahead of the same period a year ago and represented some 285 projects with a combined construction value of \$10,772,000.



Specify Utility equipment!—The one sure way to avoid the headaches of an installation that just doesn't measure up to your specifications. You're sure with Utility because it sets the industry standard for quality and performance.

## UTILITY EVAPORATIVE AIR COOLERS AND VENTILATING EQUIPMENT FOR EVERY PURPOSE

Utility's air delivery tables are complete and authentic, derived from tests made in accordance with A.S.H.V.E. test codes. Every Utility cooler is tested in accordance with these same codes. You can meet every requirement with Utility for the line includes evaporative fan coolers, duct coolers, rotary spray washer type coolers, and blowers.



## A FULL RANGE OF UTILITY HEATING EQUIPMENT

**Floor Furnaces**—45,000 BTU/Hr. input, flat and dual; also, 60,000 BTU/Hr. input, flat and dual (both sizes, shallow-type construction). **Wall Heaters**—Single—27,500 BTU/Hr. input; Dual—35,000 BTU/Hr. input and 50,000 BTU/Hr. input. **Forced Air Furnaces**—75,000 BTU/Hr. input; 100,000 BTU/Hr. input; 125,000 BTU/Hr. input and 150,000 BTU/Hr. input. **Unit Heaters**—4 sizes. All Utility Heating Equipment is tested and approved by A.G.A.

## SEND FOR AIA ENGINEERING INFORMATION

For this complete technical data on Utility equipment, plus valuable tables, charts, installation details, write (on your letterhead) to Engineering Dept. Counsel from a Utility Engineer available without charge.

UTILITY APPLIANCE CORP.  
4851 S. Alameda Street, Los Angeles 58, California



EVAPORATIVE AIR COOLERS      GAS-FIRED FURNACES  
VENTILATING EQUIPMENT

Manufacturers of Gaffers & Sattler and Occidental Gas Ranges



## GROWTH INDUSTRIAL DISTRICT

(From Page 5)

New Jersey Area now boasts many. Chicago has several "Central Manufacturing Districts" plus "Clearing Industrial District." Kansas City boasts an important one. Texas has prominent examples at Dallas and Houston. There are several in the Los Angeles Area under various sponsorships, the most recent of which is the Airport Industrial Tract. Santa Clara's Passetta Tract and San Leandro's LeRoy Tract are Bay Area examples.

The growth of the "District" plan has been closely linked to two tendencies in regional and urban development of particular importance to the industrial field. These are (1) the growth of the "Branch Plant" idea, and (2) the interest of industries in the suburban or semi-rural areas outside the central cities. The "Branch Plant" idea, of course, is the belief that efficiency can be increased by the spreading of operations, where possible, into smaller production units, located closer to the market and in a variety of communities. It is exemplified by General Electric's postwar decentralization program, taking their operations into entirely new areas. The second movement, into suburban areas rather than central cities, has accompanied the growth of the trucking industry as a freight moving medium, the widespread use of autos by

working people, the widening network of power availability. To some extent a desire for lower property taxes has fostered the trend. But most important of all is increased use of the one-story plant for general manufacturing operations. This design was fostered particularly by improved material handling machinery and a simultaneous increase in labor costs. Large acreages are now desired, which in turn makes cheaper land essential, and forces industries out of the more highly developed areas.

### Prerequisites of an Industrial District

The "Industrial District" has adopted techniques which, to some extent, have been used for years by residential subdividers, namely, the planning and at least partial development of a neighborhood in advance of occupancy.

The first problem, of course, is the selection of a site suitable to such a development. Unlike the residential subdivision, the Industrial District must be on level ground. It may be within a concentrated area provided land costs are not prohibitive. It is usually found expedient, however, to locate outside where the land supply is plentiful and where the assembly of parcels is not an obstacle.

Possible methods of organization are many. They include financing by private risk capital, by railroads, by municipal government, by port



# BRONZE PRODUCTS

by GREENBERG

Your best and nearest source for standard and special Bronze products



STABILITY since 1854

M. GREENBERG'S SONS

765 Folsom St • San Francisco • Calif • EXbrook 2-3143

Manufacturers of Fire Hydrants and Fire Protection  
Brass Goods • Industrial, Navy and Maritime  
Bronze Valves and Fittings • Plumbing and  
Hardware Brass Specialties • Bronze Plaques,  
Letters and Name Plates.

LOS ANGELES • SEATTLE • PORTLAND • SPOKANE • SALT LAKE CITY • DENVER • EL PASO • NEW YORK • HARTFORD • WASHINGTON, D. C.

agencies, by community industrial foundations, and by various combinations of the above. They may rely for return on sales, rents, freight handling revenues, or tax revenues. In the case of some community sponsored projects, there has been no expectation of direct return at all, on the theory that indirect payroll and other benefits would be more than sufficient.

Districts then acquire land, do necessary grading or filling, lay water, sewer, and gas mains, build roads, gutters, and curbs, and often enter into any one of several phases of construction and/or ownership of buildings. It is in this last that some of the greatest opportunities lie since more and more firms are utilizing assistance in the planning, construction, and financing of their plants. The ever-growing importance of Income Tax considerations has made the tax-deductible rent method preferable in many cases to outright plant ownership.

In layout of a tract, it should be designed not only for manufacturers, but also to accommodate warehousing and distributing operations. It should be remembered that the movement of freight by truck has increased greatly and that attention must be given to strong and wide pavements, turning areas and docks, adequate for modern tractor-trailer units. Also tied into this picture must be adequate, sometimes extensive areas for parking. It should be mentioned also that few Districts can be successful without rail spur provisions.

Some control of plant design is also essential whether or not the plants are financed by the District. To a very large extent the interest of prospective industry in a proposed site will depend on its "neighborhood." Proper attention must have been given to set-backs from streets and roads, to the landscaping of the surroundings, and to the building itself. If the building is owned or financed by the District, the latter will want to insure its suitability not only to the tenant at hand, but to possible future occupants or purchasers.

#### Why Successful

Only the very largest national concerns have their own departments equipped to handle a volume of new plant construction. Many companies, perhaps individually or family owned, are untrained and lack the time or interest required for an exhaustive investigation. They shy away from construction worries and prefer existing buildings. Here is what a District can offer to relieve these mental and financial barriers:

1. The price of land is fixed and does not depend on the prospect's interest or ability to pay;
2. All parcelling, easement, and right-of-way arrangements have been made.
3. Utility service, rather than being merely

promised, is already installed and deliverable at stated quantities and costs.

4. Property taxes and, especially, assessment practices, are established and known.
5. The land use pattern has been established, and zoning provisions are not subject to further examination, revision and litigation.
6. Building restrictions on neighboring sites are on record.
7. Plants are available for occupancy, or if already occupied, can be reproduced on other sites at known costs, or a new design can be executed according to specifications.

The prospective occupant thus has a clear picture of his future. He can see just what he is getting, and how much it will cost, a considerable inducement in these otherwise unpredictable times.

After locating on such a tract, he can, and usually does, assume responsibility for planning and maintaining a property in keeping with exemplary surroundings. The District's foresight has permitted an orderly layout of manufacturing operations, uncongested freight and traffic movement, and above all, superior working conditions—an industrial home of which the employees can be proud and by which the community can benefit. The growth of "Industrial Districts" is a movement which should be encouraged.

## VALUABLE NEWS SERVICE

- BUILDING MATERIAL DEALERS
- CONTRACTORS
- ENGINEERS
- FINANCIAL INSTITUTIONS

**ARCHITECTS REPORTS** gives advance news on construction projects in Northern California, lists: name of projects, location, architect, proposed cost and other pertinent information.

**HANDY** individual slip-reports, issued daily at a total cost of only

\$10 a month

## ARCHITECT'S REPORTS

Published Daily

The ARCHITECT and ENGINEER, Inc.

68 Post Street, San Francisco - DO 8311

# American Institute



# of Architects

Ralph Walker, president  
Glenn Stanton, 1st vice president  
Kenneth E. Wischmeyer, 2nd vice president  
Clair W. Ditchy, secretary  
Charles F. Cellarius, treasurer

Arizona Chapter:  
Edward L. Varney, President; Ralph B. Haver, Secretary,  
35 W. Oregon Street, Phoenix, Arizona.

Central Valley of California:  
William Koblitz, President; Gordon Stafford, Vice-President;  
John W. Bomberger, Secretary; Albert E. Thomas, Treasurer.  
Secretary's Offices P. O. Box 1943, Modesto.

Coast Valleys Chapter:  
Wm. Hempel, President; Lawrence Gentry, Vice-President;  
Walter Stromquist, Sec.-Treas. Directors, Chas. Butler and  
Thos. S. Elston. Office, 257 State Street, Los Altos.

Colorado Chapter:  
Henry J. Von Wyl, President; Charles H. Overholt, Secretary,  
2509 W. 36th Avenue, Denver, Colorado.

National Headquarters —  
1741 New York Avenue, N. W.  
Washington 6, D. C.  
Edmund R. Purves  
Executive Secretary

Northern California Chapter:  
Ralph N. Pollock, President; Francis J. McCarthy, Vice-  
President; William B. McCormick, Secretary; George A.  
Downs, Treasurer. Offices 369 Pine St. San Francisco.

Oregon Chapter:  
Harmon Brookman, President; Donald J. Stewart, Vice-  
President; Raymond Kermit Thompson, Secretary; Millard  
H. Schmeier, Jr., Treasurer. Secretary's office 429 S. W. 4th  
Avenue, Portland.

Pasadena Chapter (California):  
Burton Romberger, President; Georgius Y. Cannon, Vice-  
President; Donald E. Neptune, Treasurer; William H. Taylor,  
Secretary. Directors: Boyd E. Georgi, Roland E. Coate,  
Edwin Westberg and Robert H. Ainsworth. Office 1041 E.  
Green St., Pasadena.

## AMERICAN INSTITUTE OF ARCHITECTS' CONVENTION

Unprecedented advance registration for the 83rd Annual Convention of the A. I. A. has been announced by the Chicago Chapter, who will be hosts to the National Convention when it meets in Chicago, May 8-10. Those who desire to obtain accommodations in the convention hotel will have to hurry their reservations as space is limited. Ample hotel accommodations are available in the immediate area.

Special events being arranged for the convention include parties, tours, luncheons, fashion shows, and tickets to "South Pacific." The Chicago Art Institute will exhibit "Italy at Work—Renaissance in Design," especially for the architects.

Fellowships will be conferred at the annual dinner and presentation of the Gold Medal of the Institute and principal address will complete the evening.

The convention program itself represents one of the most comprehensive technical discussions of architectural matters ever to be presented.

**SPEED CONSTRUCTION  
WITH FIRESAFE, SAG-PROOF  
EASY-TO-USE**

**STRAN-  
STEEL**



AVAILABLE

**STEEL FRAMING**  
"Metal Lumber"

\*PROMPT DELIVERIES ON  
**STUDS · JOISTS · CHANNELS**  
IN STANDARD SIZES

For complete information and prompt service, phone or write

**KRAFTILE COMPANY**

NILES, CALIFORNIA NILES 3611  
SAN FRANCISCO 5: 50 Hawthorne St.—DOUGLAS 2-3780  
LOS ANGELES 13: 405 South Main Street—MUTUAL 7241

## SAN FRANCISCO ARCHITECTURAL CLUB

The San Francisco Architectural Club's annual picnic will be held on Sunday, May 27, at the Maples in the Redwood Regional Park, site of the successful 1950 annual picnic.

Architects and allied interests are urged to "come early" and coffee, milk, and ice cream (as well as gifts for the youngsters) are "on the Club."

## WASHINGTON JOINT CONFERENCE ON SCHOOL ARCHITECTURE

An interesting meeting of educators and architects was recently held in the Health Sciences Auditorium of the University of Washington, Seattle, sponsored by the Washington State Chapter, A. I. A.; College of Education, School of Architecture, and the Division of Adult Education of the University of Washington.

Purpose of the conference was to increase the understanding of mutual problems and to provide a common meeting ground where problems of utility, cost, and technology could be analyzed in order that the schools of the State of Washington might be improved.

Conference sessions were presided over by Robert Dietz, chairman of the program committee; Robert L. Durham, and Waldo B. Christenson.

**East Bay Chapter:**  
Harry A. Bruno, President; Ira D. Beals, Sec., Office 1444 Webster Street, Oakland.

**Montana Chapter:**  
Cyr. Pickering, President; H. C. Choever, Secretary, Montana State College, Bozeman, Montana.

**Nevada Chapter:**  
George L. F. O'Brien, President; Aloysius McDonald, Vice-President; Graham Erskine, Secretary; Edward S. Parsons, Treasurer, Offices 160 Chestnut St., Reno.

**Nevada State Board of Architects:**  
L. A. Ferris, President; Reno; Walter Zick, Secretary, Las Vegas; Directors: Aloysius MacDonald, Las Vegas; Russell Mills and Edward Oarsens, Reno. Office, P. O. Box 2107, Las Vegas, Nevada.

**San Diego Chapter:**  
George C. Hatch, President; Jack R. Lewis, Vice-President; Louis A. Dean, Secretary; Donald Campbell, Treasurer; Directors, C. J. Padarewski, Walter C. See, Louis H. Bodner, and Wm. Templeton Johnson. Offices Suite 206 Fifth Avenue Building.

**San Joaquin Chapter: (California)**  
Fred L. Swartz, President; Fresno; Lloyd J. Fletcher, Vice President, Visalia; Walter Wagner, Secretary, Fresno; Robert W. Stevens, Treasurer, Fresno. Directors: Alcantan Simpson, William D. Coats, William F. Baxter, Maurice J. Metz, Delegate California Council of Architects. Office, Sec. Fulton-Fresno Bldg.

**Santa Barbara Chapter (California):**  
Robert I. Hoyt, President; Harold E. Burket, Vice-President; Roy W. Cheesman, Secretary; Lutah M. Riggs, Treasurer. Address, 242 San Marcos Bldg.

**Southern California Chapter:**  
John J. Landon, President; Chas. Frey, Vice-President; C. Day Woodford, Secretary; Wm. G. Balch, Treasurer, Directors, Paul G. Davis, Henry Wright, John Rex, and Kemper Nomland. Chapter Headquarters, 3757 Wilshire Blvd., Los Angeles 5.

**Spokane Chapter:**  
Richard H. Eddy, President; Harry C. Waller, Vice-President 1; Kenneth D. Stormont, Vice-President 2; Victor L. Wullis, Secretary; and Carl Johnson, Treasurer. Office 1023 W. Riverside Ave., Spokane, Washington.

**Utah Chapter:**  
Howell G. Cannon, President; William J. Monroe, Jr., Secretary, 2707 South 32nd West Street, Salt Lake City 7, Utah.  
**Washington State Chapter:**  
Perry B. Johanson, President; Paul Thiry, 1st Vice-President; Thomas F. Harris, Jr., 2nd Vice-President; John S. DeLise, Secretary; Lawrence G. Waldron, Treasurer, Office 714 American Bldg., Seattle 4.

**Tacoma Society:**  
E. N. Dugan, President; P. G. Ball, Vice-President; Lyle Swadberg, Secretary-Treasurer.

**Hawaii Chapter:**  
James C. Simms, President; Alfred Preis, Secretary, 1507 Kapiolani Blvd., Honolulu, T. H.

**CALIFORNIA COUNCIL OF ARCHITECTS**  
Frank V. Mayo, President; Frederick A. Chase, Executive Secretary, Office, 3757 Wilshire Blvd., Los Angeles 5.

**OTHER ARCHITECTURAL ORGANIZATIONS**  
San Francisco Architectural Club:  
Alfred T. Kirkevoold, President; Charles Dennis, Vice President; William C. Thiesman, Treasurer; Milton Bromberg, Secretary, Office 507 Howard Street.

Ernest J. Kump, architect of San Francisco, was the banquet speaker. Paul Thiry, presiding at the banquet.

Among the speakers were Dr. Raymond B. Allen, Prof. Arthur P. Herman, Mrs. Pearl Wanemaker, Prof. Thomas R. Cole, Perry B. Johanson, Prof. George D. Straymer, Jr., Francis E. Huggard, architect; Byron Smith, educator; J. H. DeHart, architect; Roland Upton, educator; Clive O. Westby; Charles T. Pearson, architect; John S. Villevik, architect; Alden Blankenship, educator; Perry B. Johanson, architect; Mrs. Henry B. Owen, and Governor Arthur B. Langlie.

### SOUTHERN CALIFORNIA CHAPTER

The April meeting was devoted to a consideration of "Public Works" and included a report from Charles O. Metcham, chairman of the Chapter's Public Works Committee.

Featured speaker of the meeting was C. Reid Johnson, Chief Civil Engineer, 11th Naval District, who's subject was "Navy Uses Architects," and during his remarks emphasized the fact that the Navy makes every effort to work with architects on every possible project.

H. Roy Kelley, Professional Advisor of the Fort Moore Memorial Wall Competition, reported on the progress of the project and a model of the winning entry was exhibited at the meeting.

Home Tour—the Women's Architectural League will conduct a Home Tour in the near future.

**NEW MEMBERS:** New members to the Chapter include Reynold J. Bleach, Jr., Carl W. Denney, Walter H. Henning, Robert M. Lindsey, Ralph B. Modjeski, Francis A. Runcy, Wayne R. Williams, Maynard W. Woodard and Ward Inhen.

### LADIES INVITED

Special plans are being completed for entertainment of the ladies who attend the National American Institute of Architects Convention in Chicago, May 8-10. All delegates are being urged by the national institute officials to bring their wives.

### NORTHERN CALIFORNIA CHAPTER

Frank Thomas, superintendent of Berkeley City Schools, spoke before the membership recently on the subject of "Relationship of Maintenance to the Architect," and on the same program which was devoted to a consideration of maintenance subjects, Lester C. Bush, superintendent of the San Francisco Bureau of Building Inspection, spoke on "The Architect and the Bureau of Building Inspection."

Announcement has been made that the A. I. A. Honor Awards for the year 1951 will be presented for distinguished accomplishment in three classes of buildings: (1) residential, (2) industrial, and (3) hospitals. All buildings shall have been completed since January 1, 1946, and awards will be made at the A. I. A. Chicago Convention in May.

### WASHINGTON STATE CHAPTER

The April meeting was held at the Tropics in Tacoma, with Dr. Warren E. Tomlinson of the staff of the College of Puget Sound the principal speaker. An exhibit of work done by Tacoma architects was prepared for the meeting.

Looks like the Architects' Licensing Act will not be passed by the present legislative session—politically put there is a "class prejudice against licensing acts and a feeling that each profession and occupation is trying to obtain a competitive advantage."

(See Page 31)



# WITH THE ENGINEERS

Structural Engineers Association of California  
Arthur W. Anderson, President; Harold P. King, Vice-president; Henry J. Degenkolb, Sec.-Treas.; Office of Sec., 405 Montgomery St., Room 1121, San Francisco.

Structural Engineers Association of Northern California  
John E. Rinne, President; John J. Gould, Vice-President; Wm. W. Brewer, Sec.; Franklin P. Ulrich, Treas.; Directors, Walter L. Dickey, Leslie W. Graham, Hyman Rosenthal, and Howard A. Schirmer.

Structural Engineers Association of Central California  
William H. Petersen, President; Walter S. Wassum, Vice President; O. T. Illich, Sec. Treas.; Ernest D. Francis, M. A. Ewing, and Arthur A. Sauer, directors. Office O. T. Illich, c/o Div. of Arch., Sacramento.

American Society of C. E. San Francisco Section  
Clement T. Wiskacil, President; John S. Longwell, Vice-president; J. G. Wright, Vice-president; H. C. Medbery, Treasurer; R. D. Dewell, Secretary. Secretary's Office, 604 Mission St., San Francisco.

Structural Engineers Association of Southern California  
Donald F. Shugart, President; Harold P. King, Vice President; Robert J. Short, Sec.-Treas.; Directors, William T. Wheeler, William T. Wright, Ernest C. Hillman, Jr., John Case, and John K. Minasian. Office, 202 Architects Bldg., Los Angeles 13.

Structural Engineers Association of Oregon  
R. Evan Kennedy, President; Guy H. Taylor, Vice President; James R. Griffith, Secretary-Treasurer; Directors Jerome A. McDevitt, H. Loren Thompson, and Robert L. Tidball. Offices, Portland.  
Puget Sound Engineering Council (Washington)

R. E. Kister, A. I. E. E., Chairman; E. R. McMillan, A. S. C. E., Vice Chairman; L. B. Cooper, A. S. M. E., Secretary; A. E. Nickerson, I. E. S., Treasurer. Offices, L. B. Cooper, c/o University of Washington, Seattle 5, Washington.

American Society Testing Materials Northern California District  
L. A. O'Leary, Chairman; P. V. Garin, Vice-chairman; H. P. Hoopes, Sec. Office Sec., 1550 Powell St., Emeryville, Calif.

## STRUCTURAL ENGINEERS OF NORTHERN CALIFORNIA

"Wood as an Engineering Material" was the subject of a talk recently by L. J. Markwardt, president of the American Society for Testing Materials, and associated with the U. S. Forest Products Laboratory.

The meeting was a joint session with the Northern California District American Society of Testing Materials, and well attended.

A joint legislative meeting was held in Sacramento during April, sponsored by the State Association, with arrangements in charge of the Central California Association. Jesse Rosenwald, chairman of the Legislative Committee, has been very busy with a number of bills pending before the present Legislature.

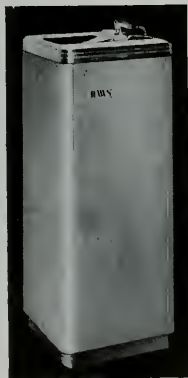

Always  
Specify  
**HAWS**  
for Highest  
Quality

A complete line of coolers, fountains, faucets, equipment, filters and accessories. A reputation for reliability since 1909. Check in Sweet's or write for complete HAWS catalog.

**HAWS DRINKING FAUCET CO.**  
1441 FOURTH STREET (Since 1909) BERKELEY 10, CALIFORNIA  
Agents and Sales Representatives in All Principal Cities

## PLAN ENGINEERING HELP FOR HIGH SCHOOL STUDENTS

A program of "Career Counseling in Engineering for High School Students" has been undertaken by the San Francisco Engineering Counsel in cooperation with the San Francisco School Department.

Leaders in the field of engineering meet with high school student groups and explain the opportunities and requirements of their profession.

## PLANNING EUROPEAN TOUR FOR STUDENTS

Jaro Polivka, currently delivering a special course of lectures for the Department of Art and Architecture at Stanford University, has announced he will conduct a European tour for students in "Agricultural Structures."

The group will sail from New York on July 3, and will motor through Spain, France, England, Holland, Belgium, Germany, Switzerland, and Italy. They will arrive back in New York on August 27.

## ARMY HOUSING PROJECT

Barovetto & Thomas, architects of Sacramento, have been commissioned by the U. S. Army Corps of Engineers to draft plans for the construction of a 133-unit housing project at the Sacramento Signal Depot.

Construction is being done under provisions of the Wherry Act.

## STRUCTURAL ENGINEERS OF SOUTHERN CALIFORNIA

The April meeting was devoted to a talk on "Modern Map Reproduction" with H. F. Peterson of the Shell Oil Company the principal speaker. Modern techniques and materials and varied uses were discussed in detail.

The Legislative Committee has been busy with a number of bills pending before the State Legislature, including measures which will recodify the Civil and Professional Engineers' Act, and others that alter the identification of engineers and the handling of state funds.

**NEW MEMBERS**—Recent new members to the association include Carl Russell, Hugh Barnes, Paul Winters, Lucien Sadecki, George Gray and Stanley Hart, associates; Gordon Kelsen, junior member; and J. W. Kockandorfer, allied member.

## ELECTED PRESIDENT OF PROFESSIONAL ENGINEERS

The National Society of Professional Engineers has announced the new officers who will assume office on July 1, 1951.



L. L. DRESSER  
President

L. L. Dresser, prominent oil engineer and civic leader of Tulsa, Oklahoma, has been named President. He is vice president of the Southwestern Area, NSPE, at the present, and former holder of many State and National Society offices, and has been very active in civic affairs for a number of years.

George J. Nicastro, associated with Combustion Engineering-Superheater, Inc., of New York, and present chairman of the NSPE Publications Committee, has been named vice president.

John F. Reynolds, of the firm of Reynolds, Smith and Hills, Jacksonville, Florida, has been named vice president of the Southeastern Area, and Col. Chester Lichtenberg of Fort Wayne, Indiana, has been named vice president of the Central Area.

Vice president of the Northcentral Area is C. G. Roush, Kansas City manager of Westinghouse

Electric Corporation; vice president of the Southwestern Area is T. C. Forest, Jr., Dallas, Texas; and the Western Area will be represented by DeWitt C. Griffin of Seattle, Washington, member of the firm of DeWitt C. Griffin and Associates, Consulting Engineers.

## CALIFORNIA STATE ASSOCIATION ENGINEERS SET CONVENTION DATE

Directors of the Structural Engineers' Association of California have selected Yosemite Valley as the site for this year's annual convention.

Dates for the conference have been chosen, October 11, 12 and 13.

## U. C. SCIENTIST WINS CHEMISTRY AWARD

Dr. William F. Giauque, Nobel Laureate and professor of chemistry on the Berkeley campus of the University of California, has been awarded the Willard Gibbs Medal for 1951 by the Chicago Section of the American Chemical Society.

The award is one of the highest honors in American science.

DOUGLAS fir sawmills in the Pacific Northwest produced as much lumber in the first eleven months of 1950 as they did in the entire year of 1949.—West Coast Lumberman's Association.

(See Page 31)



*Always specify* **HAWS**

**FOR HIGHEST QUALITY**

- Sanitary Drinking Fountains
- Electric Water Coolers
- Drinking Faucets, Equipment, Filters and Accessories

*A reputation for reliability since 1909.  
Check in Sweet's or write for HAWS catalog.*

**HAWS DRINKING FAUCET CO.**  
1441 FOURTH STREET (Since 1909) BERKELEY 10, CALIFORNIA  
Agents and Sales Representatives in All Principal Cities

# PRODUCER'S COUNCIL PAGE

The National Organization of Manufacturers of Quality Building Materials and Equipment  
affiliated with THE AMERICAN INSTITUTE OF ARCHITECTS

President, Arthur C. Staat  
Natural Gas Equipment, Inc.  
1150 Folsom Street

Vice-President, Fred A. Figone  
Otis Elevator Company  
1 Beach Street

Secretary, Howard Noleen  
E. F. Hauserman Company  
500 Second Street

Treasurer, A. L. West, Jr.  
Aluminum Company of America  
Russ Bldg.

Edited by Carl B. Frank, DETROIT STEEL PRODUCTS CO.

## INTRODUCTION

We take pleasure this month in introducing our recently elected secretary, Mr. Howard W. Noleen of The E. F. Hauserman Company. Howard is a



HOWARD W. NOLEEN  
E. F. Hauserman Co.

native of the good old frigid clime, having been born and raised in Minneapolis, Minnesota. He entered the building construction business in 1935 as a draftsman for the Flower City Ornamental Iron Company of Minneapolis. This company was in the manufacture of various and sundry architectural metals. Howard then joined The E. F. Hauserman Company in 1939 during the construction of the Bankers' Life Building in Des Moines, where he assisted in the successful installation of the first all-steel interiors utilized in a major office building. He was then a member of the engineering staff of Hauserman's Movable Steel Partition Plant in Cleveland, Ohio, and remained with them until 1945 at which time he became chief draftsman at the Lewis Welding and Engineering Corporation of Cleveland. He served in this capacity until 1947 except for the years sailing the bounding main aboard a U. S. Navy destroyer.

native of the good old frigid clime, having been born and raised in Minneapolis, Minnesota. He entered the building construction business in 1935 as a draftsman for the Flower City Ornamental Iron Company of Minneapolis. This company was in the manufacture of various and sundry architectural metals.

Howard then joined

In 1947, Howard returned to the employ of the E. F. Hauserman Company as a member of the sales force. In October 1948, he was sent to San Francisco as assistant manager for the Northern California area.

I might add that Howard is a very skillful actor and has taken part in the last two Christmas Jinx programs for the Council, and in case you don't happen to remember seeing him, he uses the stage name of "G. Howie Smells." In this capacity, he has cavorted with some famous architect-actors, such as "Isa Dope" and numerous others whose names escape me, thank heaven, for the moment.

## APRIL MEETING

The Harbor Plywood Corporation of California represented by Mr. Paul O. Daffer, will present a Technicolor motion picture entitled "Formica," for our April meeting. This film covers the manufacturing, fabrication and use of this very popular plastic, and will contain many items of interest to those in attendance, both members and architect guests.

## COMING ATTRACTIONS

We have in the offing for the very near future, two of our annual affairs, namely, the Table-Top Exhibit, and the Golf Meeting. The Golf Meeting will take place some time in June, date to be announced, while the Table-Top Exhibit will be on May 23 at the Fairmont Hotel. We are looking forward to a good architect-engineer attendance to the Table-Top meeting, as there will be many new and different products displayed.

USE QUALITY PRODUCTS



CONSULT AN ARCHITECT

## A.I.A. ACTIVITIES

(From Page 27)

Honor Awards for 1951 will cover the fields of (1) Single family residential, (2) Commercial structures, (3) Institutional and public buildings, and (4) a Grand Award from all classes. Awards will be made at the annual banquet on June 1. Entries must be in not later than May 2.

\* \* \*

Stuart & Durham bowling team did it again— took the bowling championship, while in the Seattle Construction League the A. I. A. team came within one point of winning the number one position from the Pioneer Sand and Gravel team.

---

## LE BRUN SCHOLARSHIP

The 1951 Le Brun Travel Scholarship of \$2,800, designed to provide for at least six months' travel in Europe, will be awarded this year to the winner in a competition to design a motel.

Applicants must be U. S. citizens, age 23-30, at least two years architectural experience, beneficiary of no other traveling scholarship, and nominated by a member of the A. I. A.

Details are available from J. Bruno Basil, chairman Le Brun Committee, New York Chapter, A. I. A., 115 West 40th street.

---

## MARIN ART AND GARDEN SHOW

An exhibit of work by A. I. A. architects of Marin County was recently displayed to the public at the Marin Art and Garden Club in Ross.

Preparations for the event were under the direction of James Bernard, assisted by Robert Bentley, Andre Rouzier, Walter Costa, George Furness and George Dolim.

---

## SEATTLE ARCHITECTS HONOR MARCEL BREUER

Honoring Marcel Breuer, outstanding national architect, furniture designer and teacher, a luncheon was held in the Seattle College Club on April 19.

Breuer was in Seattle attending the 26th Annual Convention of the Pacific Arts Association, and appeared as one of the principal speakers on the convention program.

He is especially famous for his residences and designed the house in the garden of the Museum of Modern Art in New York, although in the furniture field he was the first to use tubular steel, in the modern sense, for furniture, and has been a teacher of architecture and design at Harvard University.

## WITH THE ENGINEERS

(From Page 29)

### PUGET SOUND CHAPTER AMERICAN SOCIETY FOR METALS

The annual Educational Lecture Series were presented this year in the form of two open panel discussions on Heat Treatment of Ferrous and Non-ferrous Alloys.

A panel consisted of four speakers and a moderator, with each speaker allotted 15 minutes for a general discussion on his assigned subject. This discussion period was followed by an hour of questions from the audience.

The first meeting covered the Heat Treatment of Ferrous Metals, with H. P. Evans, Boeing Airplane Company, as moderator. J. A. Finley, University of Washington, opened the discussion with heat treatment of tool steels. Finley stressed the need for homogenizing tool steel with adequate preheat followed by closely controlled soaking at the required temperature. R. W. Hargis, Isaacson Iron Works, covered the subject of structural steels with respect to the main functions of thermal treatment in structural steels and stress relief of welded assemblies. James Gow, Electric Steel Foundry Co., discussed stainless steels. Stress relief of austenitic stainless steels, hardening of martensitic stainless steels, and the annealing of ferritic stainless steels were considered by Gow. J. C. Youlton, Commercial Steel Treaters, Inc., discussed case hardening, particularly with respect to the economics of carburizing, nitriding and carbonitriding.

The second meeting covered the Heat Treatment of Non-ferrous Metals, with M. E. Parker, Edison Technical School, as moderator. The heat treatment of aluminum alloys was discussed by J. W. Sweet, Boeing Airplane Company. Sweet presented the theory of precipitation hardening as well as the various thermal treatments used in hardening and annealing aluminum and its alloys. J. F. Baisch, Jr., Boeing Airplane Company, spoke on magnesium alloys. Baisch stressed in particular the precautions necessary to prevent voids, burning, and other hazards encountered in the heat treatment of magnesium and its alloys. L. T. Holt, consulting metallurgist, reviewed the heat treatment of copper base alloys. Most of Holt's talk was concerned with Beryllium copper, its properties and heat treatment. W. L. Slosson, Boeing Airplane Company, covered the heat treatment of titanium, Inconel X, and the Haynes Stellite cobalt base high temperature alloys. Because of the increasing interest in titanium, Slosson devoted most of his discussion to this metal.

Both meetings were well attended and, as evidenced by the question period, the subjects covered were of special interest to those attending.



#### ARCHITECT SELECTED FOR MINE PROJECT

The architectural firm of Blanchard & Maher of San Francisco have been chosen by the U. S. Navy, Bureau of Yards and Docks, to design additional units for the main mine assembly unit at Hawthorne, Nevada.

Cost of the work is estimated at \$2,000,000.

#### SCHOOL BID REJECTED

Members of the Arcade Elementary School District Board, Sacramento County, recently rejected a bid of \$300,000 for the construction of the Howe Grammar School. New bids are being taken.

#### LOW INCOME HOUSING PROJECT

The Housing Authority of the City of Fresno has started work on the construction of a 224 unit low income housing project in Fresno, cost of which will exceed \$1,500,000. Buildings are to be of frame and stucco construction with plywood interiors.

Walter Wagner of Fresno is the architect.

#### HOTEL BID REJECTED

Bids for the construction of a 45-studio unit hotel with 40-car shelters, administration buildings and 4 store buildings in Palo Alto were recently rejected. The bids of \$326,833 included building construction, utilities, and paving walks.

#### APARTMENT FOR SAN FRANCISCO

Wm. Zechendorf, Jr. of New York City has acquired property at the corner of Jones and Clay streets in San Francisco, and has announced construction of a 22-story circular shaped apartment building on the site.

Construction will be of structural steel frame and reinforced concrete.

#### UKIAH GRAMMAR SCHOOL STARTS

A State Aid Loan of \$365,000 has been made available to the Ukiah Elementary School District for the construction of a new Northside grammar school. The building will contain 12 classrooms, kindergarten, administration facilities, multi-purpose rooms, kitchen and toilets. Building will be of frame and stucco construction.

Ernest F. Winkler of San Francisco is the architect.

#### N.P.A. PERMIT IS DENIED

The County of Tulare was recently denied a N.P.A. permit for the construction of a Veterans Memorial Building at a cost of \$174,770.

The building was to be of 2-story reinforced concrete and brick construction, with a shingle tile roof, steel sash, and air conditioning.

David Horn and Marshall Mortland of Fresno are the architects.

#### SCHOOL BONDS APPROVED

A school bond issue of \$30,000 and a State Aid Loan of \$525,000 have been approved for the construction of a new grammar school building at Clovis in Fresno County.

The new building will include 10 classrooms and administration facilities.

#### WAREHOUSE BUILDINGS

The Corps of Engineers, U. S. Army, Sacramento, recently announced start of construction of 2 warehouse buildings at the Sharpe General Depot near Tracy.

The new buildings will be of one-story type, 200x300 ft. each and will cost \$2,928,000.

#### AIR FORCE HOUSING

The U. S. Army Air Force, Washington, D. C., has announced the construction of a 500 unit Air Force housing project at the Castley Air Force Base near Merced, Merced County.

The project will be built under provisions of the Wherry Act by Barrett & Hilp, general contractors of San Francisco. The general contractor will own and operate the buildings for the air force.

#### CHICO ADDS TO SCHOOL SYSTEM

The Chico Union High School District and the Chico Elementary School District will construct additions and new buildings under a plan recently approved by voters of the districts.

A bond issue of \$1,170,000 was approved for additions to the high school, and a bond issue of \$590,000 and a State Aid Loan of \$1,850,000 was approved for new grammar schools and additions to the elementary schools of Butte County.

Lawrence G. Thomson of Chico is the architect for the entire project.

## "An Explanation..."

**Porcelain ENAMEL VENEER**

...offers unlimited expression of architectural design in never-fading colors to match any exact specifications. The lightweight, modern facing material provides speed of construction... fire-safety... weather resistance and lifetime economies for any building, new or old.

FRANK WERNER

Frank Werner Building, San Francisco  
Berkeley & University Buildings  
Berkeley Building, Berkeley

**Architectural Division**  
PORCELAIN ENAMEL PUBLICITY BUREAU  
1000 CALIFORNIA BUILDING, OAKLAND 12, CALIFORNIA  
P. O. BOX 186, EAST PASADENA STATION, PASADENA 8, CALIFORNIA

Write today for details and specifications

To clarify any misunderstanding about the facing material on the Frank Werner Building in San Francisco that may have arisen from our advertisement reproduced above, we wish to explain that the exterior walls are faced with CERAMIC VENEER manufactured by Gladding, McBean & Co. PORCELAIN ENAMEL was used on the bands that frame the windows, as shown in the inset photo. MARBLE was used for the first floor facing.

*Architectural Division*

PORCELAIN ENAMEL PUBLICITY BUREAU  
ROOM 601, FRANKLIN BUILDING, OAKLAND 12, CALIFORNIA  
P. O. BOX 186, EAST PASADENA STATION, PASADENA 8, CALIFORNIA

## MODULAR CONFERENCE

(From Page 5)

The standard dimensions for toilet and shower stall partitions, both metal and stone, have been sent out for comment by groups concerned with other related materials and equipment. The standard dimensions have already been coordinated with natural stone, glass, and metal, D. G. Hann, Sanymetal Products Company, chairman of this group declared.

Details showing how modular sizes of wood windows fit together with other products particularly masonry, have been worked out, reported B. J. Triller, Farley and Foetscher Manufacturing Company, chairman of this group. These have been submitted to committees handling other equipment and materials for criticisms and suggestions. Many manufacturers of wood windows are keeping their production entirely to modular sizes, Triller said. A Commercial Standard, adopted by the industry and promulgated by the U. S. Department of Commerce, follows the modular layout with one exception. However, it remains for manufacturers of window frames to provide the modular frame called for by the standard.

The metal window industry also has adopted modular sizes for all types of windows with the exception of residential casements. Before adoption of the system, 30,000 types of windows were cataloged for sale by the industry, W. C. Randall, chief engineer, Detroit Steel Products Company reported. Now there are about 500 or 600. Application details are now being worked out between the window industry and other industries, such as brick, in order that all will fit together in construction.

An American Standard basis for the coordination of masonry sizes is already set up and is being used in cooperation with architects. In Detroit and Chicago nonstandard sizes carry a premium, E. W. Dienhart, executive secretary of the National Concrete Masonry Association, reported. Dienhart is chairman of the Study Committee on Masonry made of Concrete of Committee A62. There are still many details to be worked out in the relationships between masonry products and other products such as brick, he pointed out.

The Study Committee on Natural Stones, including granite, limestone and marble is waiting for the development of standards by other groups before proceeding with its own sizes, F. J. Plimpton, Manager, Vermont Marble Company, and chairman of this study committee declared. This is because natural stone can be cut to any reasonable size. The committee is reviewing other standards, however, and making suggestions for changes when it sees problems developing. A gooseneck design for a sill that would have been difficult and costly to manufacture was eliminated in this way.

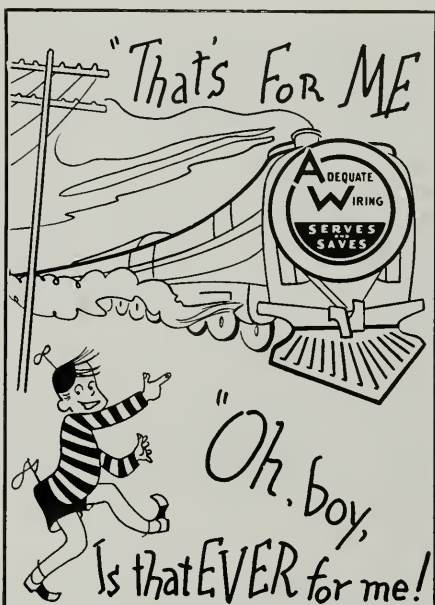

All it takes is his first sight of a snortin', chugin', hiss'n', whistle-blowin', bell-ringin' wonderful engine, and every little boy wants to be an engineer when he grows up.

And usually all it takes for the architect or builder to want to improve the quality of wiring he specifies in home plans is his first sight of a smilin', back-slappin', friend-tellin', money-payin' wonderful client.

No two ways about it—you're on the right track when you switch to CERTIFIED ADEQUATE WIRING for new or remodeling home jobs. Most people own twice as many electric appliances as they did ten, fifteen years ago. And they need plenty of switches, outlets, circuits and the other requirements of modern wiring.

When you give them adequate wiring, you've got a clear track into their affections from then on. A good investment for your client—good business for you. That's CERTIFIED ADEQUATE WIRING.

*Northern California Electrical Bureau*  
1335 MARKET STREET - SAN FRANCISCO - 3

**PLANNED LIGHTING FOR ALL**

**COMMERCIAL, INSTITUTIONAL AND**

**INDUSTRIAL INSTALLATIONS**

**ILLUMINATION EQUIPMENT**  
**SMOOT-HOLMAN**  
 LONGBEACH, CALIFORNIA  
 MADE IN U.S.A.

OFFICES IN PRINCIPAL WESTERN CITIES • BRANCH AND WAREHOUSE IN SAN FRANCISCO

**A Combined**

**Landscape Architecture  
and Contracting Service**

for

**Tract, Industrial and Residential  
Development**

**We can do the Complete Job for you**

- Landscape Architecture
- Finish Grading and Landscaping
- Asphalt Drives and Parking Lots
- Chain Link Fencing

**HENRY C. SOTO CORPORATION**  
*Landscape Contractors*

13000 SO. AVALON BLVD. LOS ANGELES 61, CALIF.  
 Phone MEnlo 4-6617

A subcommittee has been set up to work on standard dimensions for interior marble, slate, granite, and other materials, in addition to one on exterior natural stones.

Because cast-in-place concrete is a completely flexible material, the greatest concern of the Study Committee on this subject is in carrying modular instructions to workmen on the job, J. J. Hogan, Portland Cement Association, reported. This calls for a clear indication on working drawings to show dimensional placement of forms with proper tolerances for placement of various materials. A study Committee on Building Layout has been asked to draw up instructions, trade by trade, that can be passed to the shop drawing level to illustrate the meaning of dimensional indications. This same committee is reviewing standards for products and equipment as they are completed by the Study Committee to be sure the dimensions are coordinated.

## STANDARD CONTRACT FORMS

(From Page 9)

The court allowed \$48,000 which was later compromised by a payment of \$35,000.

A few changes in Article 29 Fire Insurance will probably be suggested that will make sure that the Contractor will be definitely named or described in the policy as one of the insureds. This will free him from claims under subrogation by or on behalf of the Insurance Company. But present legal and insurance opinions indicate that this will be of no avail in such a case as that in Spokane where the suit is at common law without any foundation in the terms of the contract. The only protection for the Contractor in such a case is some type of general liability policy that will protect him against a suit due to negligence. There appears to be no general policy now issued of that sort. Special coverage can be secured by negotiation for a particular job and a particular Contractor and for a definite amount.

Evidence at hand indicates that taking out such insurance by Contractors is not customary. If so contractors would appear to be generally liable to the kind of suit that occurred in Spokane but have very seldom been subjected to it, as the case seems to have very few precedents. If such insurance is desirable in the minds of Contractors it would seem to be a subject for investigation by them. Since it is not affected by the provisions of the contract it seems to be outside the province of the AIA Committee on Contract Documents.

Minor perfecting amendments may be suggested to Articles 27 and 28 Liability Insurance for Contractor and Owner, and possibly in a few other articles which there is not time now to discuss.



The Committee is preparing a Circular of Information on Insurance, that will indicate the limits involved in the Standard provisions and calling attention to the special types of coverage that should be carefully considered and provided for to meet the special needs of each project.

In the Cost Plus Fee form there is one point that I want to touch on. That form was devised originally as a guide for the drafting of special contracts. It was felt that conditions would vary so much in contracts of this sort that a single standard form would not be useful. With this in mind the form was drafted on the basis of the Contractor being a construction manager and involved in financing original payments only for a labor payroll and certain incidentals. All other payments for materials and sub-contracts were to be paid direct by the Owner. Article 5 defines the payments that are to be reimbursed to the Contractor and Article 7 defines the payments to be made direct by the Owner.

As it turned out, a considerable volume of work has been done using the AIA printed forms, known as AIA Document 105. In many cases, perhaps most, all payments were arranged to be made by the Contractor and then reimbursed to him by the Owner. For such a case all that was needed was to change the title of Article 7 to read "Additional Payments to be Reimbursed."

It appears now that this is a more normal procedure and I believe the committee on Contract Documents will recommend a revision of this form accordingly, so that the form will be more generally useful with a minimum need for amendments.

I have had time merely to indicate our general problems and a few of the more important provisions that are at present under consideration. No set of standard General Conditions can meet completely the needs of any project. Some additional general conditions will always be needed. Some of the "standard articles may need amplification or amendment which can best be done in the first of the additional General Conditions. A good way is to begin these with Article 45, so as to continue the numbering following Article 44 the last of the Standard Articles. The Caption might be, for instance, Article 45 Liability Insurance, Amending Article 27, and stating there the special limits for an individual and for an accident, which will vary widely in different jobs. Following the Articles needed to amend the Standard Articles would come such additional articles as might be deemed necessary for the particular job.

Some perfectionists say that a standard form that has to be amended is undesirable. This is an unrealistic attitude and one not generally held, or

(See Page 38)



Newly completed Youth Education and Recreation Center, Mission Hills Congregational Church, San Diego, Calif.

Architect—  
Walter C. See

## Building Committee

## Follows ARCHITECT'S ADVICE...

Mission Hills Congregational Church  
1800 N. Imperial Street, San Diego 16, California  
March 29, 1950

Dear Mr. Hillyard:

In the construction of this fine unit, we were happy to abide by the architect's recommendation that the hard wood floors be finished with "HILLYARD'S SUPER OXYMATION FINISH" and sealed with "HILLYARD'S SUPER OXYMATION FINISH".

Our maintenance program provides for the use of your SUPER HILLYARD as recommended by our architect, Walter C. See.

We are confident that by the continued use of your SUPER HILLYARD...

Very truly yours,  
Walter C. See

**Uses HILLYARD**  
Floor Products  
with great success!

## Finds Maintainer Helpful

For floors of superior beauty at lowest maintenance cost, always use specialized Hillyard Products, recommended nation-wide, by leading Architects, Builders, Flooring Manufacturers.

Write for the name and address of the Hillyard Maintainer in your vicinity. He'll help with your floor problems. Free!

(N-14)



HANDLE WITH CARE  
**HILLYARD**  
CARE

St. Joseph,  
Missouri

Branches in Principal Cities





**SISALATION**  
REFLECTIVE INSULATION

**COSTS 50%  
LESS THAN "BULK" or  
"BLANKET" TYPES OF INSULATION**  
... AND, IN ADDITION, ACTS AS A VAPOR-  
BARRIER (MEETS FHA REQUIREMENTS). COSTS  
LESS TO APPLY. WRITE FOR SAMPLES AND  
FULL INFORMATION ON ALL USES!

**The SISALKRAFT CO.**  
55 New Montgomery St. San Francisco 5, California

**JUDSON PACIFIC-MURPHY CORP.**

**Steel Fabricators  
and  
Erectors**

**REINFORCING STEEL  
STRUCTURAL STEEL  
BRIDGE CRANES**

4300 EASTSHORE HWY. Phone:  
EMERYVILLE, CALIF. OL 3-1717

**CLINTON  
CONSTRUCTION CO.**

**OF CALIFORNIA**

**General Contractors**

923 FOLSOM STREET • SAN FRANCISCO

SUtter 1-3440

**HOGAN LUMBER CO.**

*Wholesale and Retail*

**LUMBER**

---

**MILL WORK • SASH & DOORS**

---

*Office, Mill, Yard and Docks*  
**SECOND AND ALICE STREETS • OAKLAND, CALIF.**  
Telephone **Glencourt 1-6861**

**BOOK REVIEWS  
PAMPHLETS AND CATALOGUES**

**HOW TO PLAN AND BUILD YOUR FIREPLACE.** Lane Publishing Co., San Francisco. Price \$1.50.

Home owners, architects, and builders will find this publication the most complete volume of its kind. It gives information on the building of new fireplaces and the remodeling of old ones, including the chimney.

Suggestions are included as to the location of a fireplace and the working of it into room design.

More than 300 photographs and drawings, plus blueprints and building specifications are included in the one volume.

**ELECTRIC ILLUMINATION.** Second Edition. By John O. Kraehnenbuhl. John Wiley & Sons, New York. Price \$8.00.

This book represents the principles underlying the specification and design of electrical lighting for commercial and industrial buildings. It stresses the essentials of an adequate and safe lighting system. It incorporates the changes and developments that have taken place in the field since the publication of the first edition.

Additions to the book include the subjects of glare and glare calculations; louverall lighting systems, and a complete revision of the subject of economics of light production.

The author is professor of electrical engineering at the University of Illinois and is the author of more than 42 publications on the subject of lighting.

**SWEDEN BUILDS.** By G. E. Kidder Smith. Bonniers Publishers. New York. Price \$8.50.

The author, G. E. Kidder Smith, is recognized as one of the outstanding architectural photographers of the world, in addition to being a practicing architect. As an architect he sees and knows how and why a building is put together; as a critic he appreciates it as a product of history, climate and the character of its builders.

The book contains native building types and the wooden tradition; then follows the contemporary Swedish architecture which is so impressing the world today.

A wide variety of subjects are covered including residential, commercial, and industrial, together with site planning. The book contains more than 662 photographs and drawings, some in color.

The author is a member of the A.I.A. and until recently was an advanced design critic at the Yale School of Architecture.

**NEW CATALOGUES AVAILABLE**

*Any of the catalogues or folders described here may be obtained by forwarding your request as indicated in the coupon below to the office of the ARCHITECT & ENGINEER. Merely mark the items you want and clip or paste the coupon to your letterhead.*

**267. SILACONE WATER REPELLENT.** A new and amazingly effective water repellent for the protection of all stone and masonry building materials is described in this pamphlet. Product is packaged in liquid form and comes ready to be applied by the use of either a brush or spray gun. In addition to preventing the passage of water or moisture through the pores of most masonry materials, the product adds years to the life of a building by preventing the deterioration of exterior surfaces from the disintegration caused by successive freezing and thawing. Colorless and does not change the appearance of the surface. Packaged in sizes from 1 gal. to 50-gal. drums. 3/51.

**268. THE STORY OF SURFACE COATINGS BASED ON VINYLITE RESINS.** A new 28-page booklet discusses the many essential applications of protective and decorative surface coatings and is illustrated with a wide selection of photographs. From tiny metal closures to huge railroad hoppers and oil tanks, the booklet emphasizes actual case histories of outstanding performance after years of use. Land, sea, and air transportation, dairy equipment, packaging materials, and other fields where destructive forces such as weather, abrasion, moisture, chemical attack, and rust are at work, have been included in the booklet. Various techniques of application such as spraying, brushing, roller and knife coating, and dip coatings to which surface coatings of this type are suitable are also included in the material just published. 3/51.

**269. ARCHITECTURAL GRADE PLYWOOD.** A new and profusely illustrated manual devoted to  $\frac{3}{4}$ " Architectural Grade Weldwood Plywood has just been published for architects and engineers. The booklet provides a wealth of valuable reference information in a single, easy to read, source. It is practically a complete "short course" in the types, characteristics and uses of architectural grades of plywood. The booklet with text, photographs and line drawings, describes the most popular types of architectural plywood and veneer cuts, types of veneer matching, how to make corners, joints, curved panels and counterfit layouts and includes architectural specifications. Two detailed charts reveal the availability of various woods and the characteristics, origin and length range of thirty-six veneers. 3/51.

**270. LIQUID LEVEL CONTROLS.** A new 4-page bulletin which explains the reasons for using two bellows for control instead of the ordinary single bellows design has just been issued by a large national manufacturer. The bulletin also outlines the results to be expected from this type of control, together with typical specifications. It is liberally illustrated and will be of interest to engineers, contractors, and architects. 3/51.

**271. FENESTRA RESIDENCE STEEL CASEMENT WINDOWS**

"Fenestra Residence Steel Casement Windows" is the title of a new two-color folder by Detroit Steel Products Company. It describes the new, time-saving Fenestra outside-inside metal trimmed casement unit which is installed and completely trimmed, outside and inside, in minutes. Covered also are installation accessories such as the Combination Metal Fin and Inside Trim, Inside Metal Trim, and the Metal Fin. Instructions and sketches are included for installing the trimmed casement window in frame, brick veneer or concrete block construction. Specifications and construction features of Fenestra casements, and a detailed description of types and sizes, are also given. 4 pages illus. RE-23, 2/51.

**272. RADIANT CEILING**

A new type of acoustical and radiant heating ceiling is illustrated and detailed in a bulletin just released by the Burgess-Manning Company. This is a development of the ceiling invented by Gunnar Frenger of Oslo, Norway. The whole installation is pre-fabricated and can be installed without alterations. A.I.A. 30C-44, 4 pages illus. 2/51.

**273. CORRUGATED PLEXIGLAS**

A new two-color 24-page brochure describing the uses of corrugated Plexiglas presents 19 photographic case histories that show how this form of acrylic plastic sheet can be used to advantage in interior architecture for homes and offices, in signs and store fronts, in domestic, institutional and commercial lighting, and as glazing for industrial plants. A.I.A. 26-D, 24 pages illus., PL-78. 3/51.

**274. INDUSTRIAL COOLING TOWERS**

The new cooling tower manufactured by Aqu-Therm, Inc., is described in their new bulletin. A feature of the cooling tower is the packing bed of corrosion resistant ceramic saddles which provide a greatly increased surface area in relation to total volume. The technical data is covered in a specimen cooling tower problem which is shown in a typical cooling tower application. 4 pages illus., 2/26/51.

**ARCHITECT AND ENGINEER**

68 Post Street, San Francisco, Calif.

I would like to have a copy of each of the New Catalogues I have circled.

267	268	269	270
271	272	273	274

Please send to the address on my letterhead, or as I have indicated, and to my attention. (Please print your name—no literature will be sent on this coupon after April, 1951.—A. & E.)

THE latest figures show that California has 179,000 civilian federal employees, or more than the District of Columbia.

**PACIFIC MANUFACTURING CO.**

High Class Interior Finish Quality Millwork

16 Beale St., San Francisco  
GARfield 1-7755

2215 El Camino Real, San Mateo  
S. M. 5-0687

304 Bryant Street, Palo Alto  
P. A. 3373

2610 The Alameda, Santa Clara  
S. C. 607 (Factory)

6820 McKinley Avenue, Los Angeles  
THornwall 4196

MAIN OFFICE — SANTA CLARA

**"AMERICAN - MARSH"**  
CONDENSATION UNIT

Pumping  
Machinery  
for  
Every  
Purpose

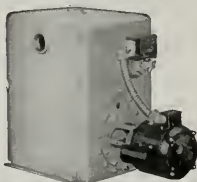

For Service  
Call  
DOuglas  
2-6794  
or  
MUtual 8322

**SIMONDS MACHINERY CO.**  
SAN FRANCISCO 816 FOLSOM  
LOS ANGELES 455 EAST 4TH

**VERMONT MARBLE COMPANY**

DOMESTIC AND IMPORTED MARBLES  
GRANITE VENEER

525 MARKET STREET • SAN FRANCISCO

Phone: SUtter 1-6747

3522 COUNCIL STREET • LOS ANGELES

Phone: DUknirk 2-7831

The Most Complete Line of  
**STEELS and STEEL BUILDING MATERIALS**  
Made by a Single Producer



See Sweet's Catalog File or write us for full information.

**REPUBLIC STEEL CORPORATION**

GENERAL OFFICES: CLEVELAND, OHIO

DENVER, COLORADO . . . CONTINENTAL OIL BUILDING  
LOS ANGELES, CALIF. . . GENERAL PETROLEUM BUILDING  
SAN FRANCISCO, CALIFORNIA . . . RIALTO BUILDING  
SEATTLE, WASH. . . . . WHITE-HENRY-STUART BUILDING

## FORDERER CORNICE WORKS

*Manufacturers of*

Hollow Metal Products • Interior Metal Trim  
Elevator Fronts and Cabs  
Metal Plaster Accessories • Sanitary Metal Base  
Flat and Roll Metal Screens  
Metal Cabinets • Commercial Refrigerators

269 POTRERO AVE.

SAN FRANCISCO, CALIF.

HEMLOCK 1-4100

## Parker, Steffens & Pearce

BUILDERS

135 South Park, San Francisco

Phone: EXbrook 2-6639

*Looked into  
all these lately?*

It's growing all the time—the list of uses for which gas is superior:

Cooking	House heating
Refrigeration	Clothes drying
Water heating	Garbage disposal
All-year air conditioning	

If your technical data files are low on any of these, why not get in touch with your Gas Company for details?

*The West  
prefers*

**GAS**

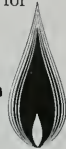

BETTER • QUICKER • CHEAPER

## STANDARD CONTRACT FORMS

(From Page 35)

there would not be so many copies of the AIA forms used as happens to be the case. I believe the Standard Documents perform a valuable service to both Architects and Contractors. The Committee on Contract Documents endeavors to insure that value by protecting them from ill-considered amendments.

### APPROVE INDUSTRIAL PLANT SITE NEAR ANAHEIM

The Orange County Planning Commission and Board of Supervisors have approved a land use application of the Robertshaw-Fulton Controls Co., manufacturers of thermostatic control devices, for construction of a 225,000 ft. industrial plant.

A 21-acre tract will be used for locating one building 180x280 ft. and an office building 40x160 ft. Three additional manufacturing units are planned for the future.

### AIR FORCE HOUSING PROJECT AT VICTORVILLE NEAR COMPLETION

Finishing touches are being put on the 650-unit housing project adjoining the George Air Force Base at Victorville.

The project comprises 250 officer dwellings that vary in size from 4-bedroom, to one and two-bedroom homes, and 400 homes for enlisted men with wives and families.

The new housing units are the first to be constructed at the Base under the Wherry bill, and completion has been delayed somewhat by material shortages.

### NEW ENGINEERING PLANT ERECTED IN EAST PASADENA

A new plant for the Consolidated Engineering Corporation is nearing completion in the Hastings Ranch area in East Pasadena. It represents a number of special features including a complete piping layout for transmission of liquids, gas and air to all parts of the plant. The plant is also completely air conditioned, with temperature controlled laboratories; a special transformer station and a complex intertelephone system with ceiling recessed speakers for public address system.

Special design effort was centered on the floor plan by architects MacDonald & Markwitt of Los Angeles, in an effort to expedite the movement of personnel, materials and instruments.

### OPENS SAN FRANCISCO OFFICE

The Herman Nelson Division of the American Air Filter Company, Inc., has opened a branch office at 225 Bush Street, San Francisco.

E. C. Sanford has been appointed manager in charge of the new office, company officials announced.

# ESTIMATOR'S GUIDE

## BUILDING AND CONSTRUCTION MATERIALS

PRICES GIVEN ARE FIGURING PRICES AND ARE MADE UP FROM AVERAGE QUOTATIONS FURNISHED BY MATERIAL HOUSES TO SAN FRANCISCO CONTRACTORS. 3% SALES TAX ON ALL MATERIALS BUT NOT LABOR

All prices and wages quoted are for San Francisco and the Bay District. There may be slight fluctuation of prices in the interior and southern part of the state. Freight charge, at least, must be added in figuring country work.

**BONDS**—Performance or Performance plus Labor and Material Bond(s), \$10 per \$1000 on contract price. Labor & Material Bond(s) only, \$5.00 per \$1000 on contract price.

### BRICKWORK—MASONRY—

Common Brick—Per 1 M laid—\$100.00 up (according to class of work).  
Face Brick Per 1 M laid—\$200.00 and up (according to class of work).  
Brick Steps—\$3.00 and up.  
Common Brick Veneer on Frame Bldgs.—Approx. \$1.20 and up—(according to class of work).  
Face Brick Veneer on Frame Bldgs.—Approx. \$2.00 and up (according to class of work).  
Common Brick—\$36.00 per M—truckload lots, delivered.

Face Brick—\$81.00 to \$106.00 per M, truckload lots, delivered.

### Glassed Structural Units—

Clear Glazed—  
2 x 6 x 12 Furring ..... \$1.60 per sq. ft.  
4 x 6 x 12 Partition ..... 1.90 per sq. ft.  
4 x 6 x 12 Double Faced  
Partition ..... 2.25 per sq. ft.  
For colored glaze add ..... 30 per sq. ft.

Manila Fire Brick—\$105.00 per M—F.O.B. Pittsburgh.

Fire Brick—Per M—\$111.00 to \$147.00.

Carriage—Approx. \$10.00 per M.

Paving—\$75.00.

### Building Tile—

8 1/2"x12-inches, per M ..... \$139.50

6 5/8"x12-inches, per M ..... 105.00

4 5/8"x12-inches, per M ..... 84.00

### Hollow Tile—

12x12x4-inches, per M ..... \$146.75

12x12x3-inches, per M ..... 156.95

12x12x4-inches, per M ..... 177.10

12x12x6-inches, per M ..... 235.30

F.O.B. Plant

### BUILDING PAPER & FELTS

1 ply per 1000 ft. roll ..... \$5.30

2 ply per 1000 ft. roll ..... 7.80

3 ply per 1000 ft. roll ..... 9.70

Brownkin, Standard 500 ft. roll ..... 6.85

Sisalraft, reinforced, 36 in. by 500 ft. roll ..... 7.00

### Sheathing Papers—

Asphalt sheathing, 15-lb. roll ..... \$2.00

30-lb. roll ..... 2.79

Dempcourse, 21 1/4 ft. roll ..... 2.95

Blue Plasterboard, 40-lb. roll ..... 5.10

### Felt Papers—

Decending felt, 3/4-lb., 50-ft. roll ..... \$3.23

Decending felt, 1-lb. .... 3.79

Asphalt roofing, 15-lbs. .... 2.00

Asphalt roofing, 30-lbs. .... 2.79

### Roofing Papers—

Asphalt Flg., 15 lb. .... \$2.09

Standard Grade, 108-ft. roll Light ..... 1.87

Smooth Surface, Medium ..... 2.18

Heavy ..... 2.56

M. S. Extra Heavy ..... 2.96

### BUILDING HARDWARE—

Sash cord com. No. 7 ..... \$2.65 per 100 ft.

Sash cord com. No. 8 ..... 3.80 per 100 ft.

Sash cord spot No. 7 ..... 3.65 per 100 ft.

Sash cord spot No. 8 ..... 3.35 per 100 ft.

Set weights, cast iron \$100.00 ton.

1-Ton lots, per 100 lbs. .... \$3.75

Less than 1-Ton lots, per 100 lbs. .... 34.75

Nails, per keg, basic ..... \$11.50

8-in. spikes ..... 11.80

Rim lock sets ..... 1.80

Bolts, dull brass plated on steel, 3/8x3/2 .76

### CONCRETE AGGREGATES—

The following prices net to Contractors unless otherwise shown. Carload lots only.

	Bunker per ton	Del'd per ton
Gravel, all sizes	\$2.44	\$2.90
Top Sand	2.38	3.13
Concrete Mix	2.38	3.06
Crushed Rock, 1/4" to 3/4"	2.38	2.90
Crushed Rock, 3/4" to 1 1/2"	2.38	2.90
Roofing Gravel	2.81	2.90
River Sand	2.50	3.00
Sand—		
Lapis (Nos. 2 & 4)	3.56	3.94
Olympta (Nos. 1 & 2)	3.56	3.88

Common (all brands, paper sacks), carload lots, \$3.55 per bbl. F.o.b. car; delivered \$3.60.

Per Sack, small quantity (paper) ..... \$1.05

Carload lots, in bulk per bbl. .... 2.79

Cash discount on carload lots, 10c a bbl. 10%

Prox., less than carload lots \$4.00 per bbl. F.o.b. warehouse or delivered.

Cash discount 2% on L.C.L.

Trinity White { 1 to 100 sacks, \$3.13 each

Medusa White { warehouse or del'd; \$9.56 bbl. carload lots.

### CONCRETE READY-MIX—

1-2-4 mix, to 10 yards\* ..... \$12.00

10 to 100\* yards ..... 11.00

100 to 500 yards ..... 10.50

Over 500 yards ..... 10.30

\* Delivered to site.

### CONCRETE BLOCKS—

4x8x16-inches each ..... Hay-dite \$1.17, Sa-salt \$1.18

6x8x16-inches, each ..... 22 .75

8x8x16-inches, each ..... 26 .76

12x8x16-inches, each ..... 34 .39

12x8x24-inches, each ..... 40 .75

Haydite Aggregates—

3/8-inch to 3/4-inch, per cu. yd. .... 7.25

3/4-inch to 1 1/2-inch, per cu. yd. .... 7.25

No. 6 to 0-inch, per cu. yd. .... 7.25

### DAMP-PROOFING and WATER-PROOFING—

Two-coat work, \$9.00 per square.

Membrane waterproofing—4 layers of saturated felt, \$10.00 per square.

Hot coating work, \$5.00 per square.

Medusa Waterproofing, \$3.50 per lb. San Francisco Warehouse.

Tricosal concrete waterproofing, 60c a cubic yd. and up.

### ELECTRIC WIRING—\$15 to \$20 per outlet for conduit work (including switches).

Knob and tube average \$6.00 per outlet.

### ELEVATORS—

Prices vary according to capacity, speed and type. Consult elevator companies.

Average cost of installing a slow speed automatic passenger elevator in small four story apartment building, including entrance doors, about \$9,500.00.

### EXCAVATION—

Sand, \$1.00; clay or shale, \$1.50 per yard.

Trucks, \$30 to \$45 per day.

Above figures are an average without water. Steam shovel work in large quantities, less; hard material, such as rock, will run considerably more.

### FIRE ESCAPES—

Ten-foot galvanized iron balcony, with stairs, \$250 installed on new buildings; \$300 on old buildings.

### FLOORS—

Asphalt Tile, 1/8 in. gauge 18c to 35c per sq. ft.

Composition Floors, such as Magnesite, 50c per square foot.

Linoleum, standard gauge, sq. yd. .... \$2.75

Mastipave—\$1.50 per sq. yd.

Bathslip Linoleum—1/8"—\$3.00 sq. yd.

Terazzo Floors—\$1.50 per sq. ft.

Terazzo Steps—\$2.50 per lin. ft.

Mastic Wear Coat—according to type—20c to 35c.

### Hardwood Flooring—

#### Oak Flooring—T & G—Unfin.—

Clear Old, White ..... \$3 1/2 x 1/2 x 3/2 \$2 x 2

Clear Old, Red ..... 405 380 \$ 5

Select Old, Red or White ..... 355 340 335 315

Select Pine, Red or White ..... 340 325 300

Select Pine, Red or White ..... 340 325 300

#1 Common, Red or White 315 310 305 280

#2 Common, Red or White 305

#### Prefinished Oak Flooring—

1/2 x 2 ..... Prime Standard \$369.00 \$359.00

1/2 x 2/4 ..... 370.00 370.00

3/4 x 2/4 ..... 390.00 381.00

3/4 x 3/4 ..... 375.00 355.00

3/4 x 2 1/4 x 3/4 Ranch Plank ..... 375.00 375.00

3/4 x 2 1/4 x 3/4 Ranch Plank ..... 415.00

#### Unfinished Maple Flooring—

1 1/2 x 2 1/4 First Grade ..... \$370.00

1 1/2 x 2 1/4 2nd Grade ..... 365.00

1 1/2 x 2 1/4 2nd & Btr. Grade ..... 375.00

1 1/2 x 2 1/4 3rd Grade ..... 240.00

1 1/2 x 3/4 3rd & Btr. Jtd. EM ..... 380.00

1 1/2 x 3/4 2nd & Btr. Jtd. EM ..... 390.00

33/32 x 2 1/4 First Grade ..... 400.00

33/32 x 2 1/4 2nd Grade ..... 360.00

33/32 x 2 1/4 3rd Grade ..... 320.00

Floor Layer Wage \$2.50 hr.

### GLASS—

Single Strength Window Glass ..... \$ .30 per sq. ft.

Double Strength Window Glass ..... .45 per sq. ft.

Plate Glass, 1/4 polished to 75 ..... 1.60 per sq. ft.

75 to 100 ..... 1.74 per sq. ft.

1/4 in. Polished Wire Plate Glass ..... 2.35 per sq. ft.

1/4 in. Rgh. Wire Glass ..... .71 per sq. ft.

1/4 in. Polished Wire Plate Glass ..... 2.00 per sq. ft.

1/4 in. Rgh. Wire Glass ..... .64 per sq. ft.

1/2 in. Obscure Glass ..... .40 per sq. ft.

3/4 in. Obscure Glass ..... .64 per sq. ft.

1/2 in. Heat Absorbing Obscure ..... 58 per sq. ft.

1/4 in. Heat Absorbing Wire ..... 86 per sq. ft.

Glazing of above additional \$1.15 to 30 per sq. ft.

Glass Blocks, set in place ..... 3.50 per sq. ft.

### HEATING—

Average, \$3.50 to \$4.00 per sq. ft. of radiation, according to conditions.

Warm air (gravity) average \$64 per register.

Forced air average \$91 per register.



## INSULATION AND WALLBOARD—

Rockwool Insulation—	
(2") Less than 1,000 sq. ft.	\$64.00
(2") Over 1,000 sq. ft.	\$9.00
Cotton Insulation—Full thickness	
(3 1/2")	\$75.50 per M sq. ft.
Sitelation Aluminum Insulation—Aluminum coated on both sides.	
Tileboard—1/8" panel	\$7.00 per panel
Wallboard—1/2" thickness	\$55.00 per M sq. ft.
Finished Plank	\$69.00 per M sq. ft.
Ceiling Tileboard	\$69.00 per M sq. ft.

**IRON**—Cost of ornamental iron, cast iron, etc., depends on designs.

## LUMBER—

S4S No. 2 and better common O.P. or D.F., per M. f.b.m.	\$100.00
Rough, No. 2, common O.P. or D.F., per M. f.b.m.	100.00

## Flooring—

Per M Delvd.	
V.G.-D.F. 8 & 8tr. 1 x 4 T & G Flooring	\$225.00
"C" and better—all	225.00
"D" and better—all	225.00
Rwd. Rustic—"A" grade, medium dry	185.00
8 to 24 ft.	
Plywood, per M sq. ft.	
1/2-inch, 4,000 0-515	\$170.00
3/4-inch, 4,000 0-515	200.00
5/8-inch, per M sq. ft.	315.00
Plyscord	117c per ft.
Phylform	25c per ft.

## Shingles (Rwd. not available)—

Red Cedar No. 1—\$9.50 per square; No. 2, \$7.00; No. 3, \$5.00.
Average cost to lay shingles, \$6.00 per square.
Cedar Shakes—1/2" to 3/4" x 24/26 in handsplit tapered or split resawn, per square—\$15.25
3/4" to 1 1/4" x 24/26 in split resawn, per square—17.00
Average cost to lay shaves.—8.00 per square
Pressure Treated Lumber—
Wolmanized—Add \$35 per M to above
Crossed, 8-lb. treatment—Add \$45 per M to above

## MARBLE—(See Dealers)

## METAL LATH EXPANDED—

Standard Diamond, 3.40, Copper Bearing, L.C.I., per 100 sq. yds.	\$43.50
Standard Ribbed, ditto	\$47.50

## MILLWORK—Standard.

D. F. \$150 per 1000. R. W. Rustic \$175 per 1000 (delivered).
Double hung box window frames, average with trim, \$12.50 end up, each.
Complete door unit, \$15 to \$25.
Screen doors, \$8.00 to \$12.00 each.
Patent screen windows, \$1.25 a sq. ft.
Cases for kitchen pantries seven ft. high, per lineal ft., upper \$9.00 to \$11.00; lower \$12.00 to \$13.00.
Dining room cases, \$20.00 per lineal foot. Rough and finish about \$1.00 per sq. ft.
Labor—Rough carpentry, warehouse heavy framing (average), \$75.00 per M.
For smaller work average, \$85.00 to \$100. per 1000.

## PAINTING—

Two-coat work	per yard 85c
Three-coat work	per yard \$1.10
Cold water painting	per yard 25c
Whitewashing	per yard 15c
Linseed Oil, Strictly Pure	Wholesale
(Basis 7 1/4 lbs. per gal.)	Raw Boiled
Light iron drums	per gal. \$2.28
5-gallon cans	per gal. 2.40
1-gallon cans	each 2.52
Quart cans	each 71
Pint cans	each 38
1/2-pint cans	each 24
Turpentine	Pure Gum
(Basis, 7.2 lbs. per gal.)	Spirits
Light iron drums	per gal. \$1.65
5-gallon cans	per gal. 1.76
1-gallon cans	each 1.88
Quart cans	each 54
Pint cans	each 31
1/2-pint cans	each 20

## Pioneer White Lead in Oil Heavy Paste and All Purpose (Soft - Paste)

Net Weight	per 100	List Price	Price to Painters
Packages	lbs.	pkgs.	lbs.
100-lb. kegs	\$28.35	\$29.35	\$27.50
50-lb. kegs	30.05	15.03	28.15
25-lb. kegs	30.35	7.59	28.45
5-lb. cans*	33.35	1.24	31.25
1-lb. cans*	36.00	.36	33.75

500 lbs. (one delivery) 3/4c per pound less than above.  
\*Heavy Paste only.

## Pioneer Dry White Lead—Litharge—Dry Red Lead—Red Lead in Oil

Products	Price to Painters—Price Per 100 Pounds		
	lbs.	lbs.	lbs.
Dry White Lead	\$28.30	\$	25
Litharge	25.95	26.60	26.90
Dry Red Lead	27.20	27.85	28.15
Red Lead in Oil	30.65	31.30	31.60

Pound cans, \$37 per lb.

## PATENT CHIMNEYS—

6-inch	\$2.50 lineal foot
8-inch	3.00 lineal foot
10-inch	4.00 lineal foot
12-inch	5.00 lineal foot

## PLASTER—

Neat wall, per ton delivered in S. F. in paper bags, \$17.60.

## PLASTERING (Interior)—

	Yard
3 Coats, metal lath and plaster	\$3.00
Keece cement on metal lath	3.50
Ceilings with 3/4 hot roll channels metal lath (lathed only)	3.00
Ceilings with 3/4 hot roll channels metal lath plastered	4.50
Single partition 3/4 channel lath 1 side (lath only)	3.00
Single partition 3/4 channel lath 2 inches thick plastered	6.00
4-inch double partition 3/4 channel lath 2 sides (lath only)	5.75
4-inch double partition 3/4 channel lath 2 sides plastered	6.75
Thermax single partition; 1" channels; 2 1/2" cover lip partition width. Plastered both sides	7.50
Thermax double partition; 1" channels; 3/4" overall partition width. Plastered both sides	11.00
3 Coats over 1" Thermax nailed to one side wood studs or joists	4.50
3 Coats over 1" Thermax suspended to one side wood studs with spring sound isolation clip	5.00
Note—Channel lath controlled by limitation orders.	

## PLASTERING (Exterior)—

	Yard
2 coats cement finish, brick or concrete wall	\$2.50
3 coats cement finish, No. 18 gauge wire mesh	3.50
Lime—\$4.00 per bbl. at yard.	
Processed LLime—\$4.15 per bbl. at yard.	
Rock or Grip Lath—1/2"—30c per sq. yd.	
1/4"—29c per sq. yd.	
Composition Stucco—\$4.00 sq. yard (applied).	

## PLUMBING—

From \$200.00 per fixture up, according to grade, quality and runs.

## ROOFING—

"Standard" tar and gravel, 4 ply—\$11.00 per sq. for 30 sqs. or over.	
Less than 30 sqs. \$14.00 per sq.	
Tile \$40.00 to \$50.00 per square.	
No. 1 Redwood Shingles in place, 4 1/2 in. exposure, per square	\$18.25
5/2 No. 1 Cedar Shingles, 5 in. exposure, per square	14.50
5/8 x 16"—No. 1 Little Giant Cedar Shingles, 5" exposure, per square	18.25

4/2 No. 1-24" Royal Cedar Shingles 7/2" exposure, per square	23.00
Re-coat with Gravel \$5.50 per sq.	
Asbestos Shingles, \$27 to \$35 per sq. laid.	
1/2 to 3/4 x 25" Resawn Cedar Shakes, 10" Exposure	\$30.00
3/4 to 1 1/4 x 25" Resawn Cedar Shakes, 10" Exposure	\$35.00
1 x 25" Resawn Cedar Shakes, 10" Exposure	22.00

Above prices are for shakes in place.

## SEWER PIPE—

C.I. 6-in. to 24-in. B. & S. Class B and heavier, per ton	\$99.50
Vitrified, per foot: L.C.L. F.O.B. Warehouse, San Francisco.	
Standard, 8-in.	\$.66
Standard, 12-in.	1.30
Standard, 24-in.	5.41
Clay Drain Pipe, per 1,000 L.F.	
L.C.L. F.O.B. Warehouse, San Francisco	
Standard, 6-in. per M.	\$240.00
Standard, 8-in. per M.	400.00

## SHEET METAL—

Windows—Metal, \$2.50 a sq. ft.  
Fire doors (average), including hardware \$2.80 per sq. ft., size 12'x12'. \$3.75 per sq. ft., size 3'x6'.

## SKYLIGHTS—(not glazed)

Copper, \$1.25 sq. ft. (flat).  
Galvanized iron, 65c sq. ft. (flat).  
Vented hip skylights, \$1.50 sq. ft.

## STEEL—STRUCTURAL—

\$220 per ton erected, when out of mill.  
\$270 per ton erected, when out of stock.

## STEEL REINFORCING—

\$200.00 per ton, in place.	
1/4-in. Rd. (Less than 1 ton)	\$8.40
3/8-in. Rd. (Less than 1 ton)	7.30
1/2-in. Rd. (Less than 1 ton)	7.00
5/8-in. Rd. (Less than 1 ton)	6.75
3/4-in. & 7/8-in. Rd. (Less than 1 ton)	6.65
1-in. up (Less than 1 ton)	6.60
1 ton to 5 tons, deduct 25c.	

## STORE FRONTS (None available)

## TILE—

Ceramic Tile Floors—Commercial \$1.20 to \$1.60 per sq. ft.	
Over 8-1/2"—\$1.40 per lin. ft.	
Quartz Tile Floors, 6 1/2" with 6" base @ \$1.35 per sq. ft.	
Tile Wainscots & Floors, Residential, 4 1/4 x 9 1/4", @ \$1.65 to \$2.00 per sq. ft.	
Tile Wainscots, Commercial Jobs, 4 1/4 x 9 1/4", @ \$1.50 to \$1.65 per sq. ft.	
Asphalt Tile Floor 16" sq. ft. @ \$.18 - .35 sq. yd.	
Light shades signum nomen.	
Cork Tile—\$.70 per sq. ft.	
Mosaic Floors—See dealers.	
Lino-Tile—\$1.00 per sq. ft.	
Rubber Tile—\$.55 to \$.75 per sq. ft.	
Building Tile—	
8 1/2 x 12-inches, per M	\$139.50
12 x 12-inches, per M	105.00
4 1/2 x 12-inches, per M	84.00
Hollow Tile—	
12 x 12-inches, per M	\$146.75
12 x 14-inches, per M	156.85
12 x 16-inches, per M	177.10
12 x 24-inches, per M	235.30

F.O.B. Plant

## VENETIAN BLINDS—

75c per square foot end up. Installation extra.

## WINDOWS—STEEL—INDUSTRIAL

Cost depends on design and quality required.

# ARCHITECT AND ENGINEER ESTIMATOR'S DIRECTORY

## Building And Construction Materials

EXPLANATION—Building and construction materials are shown in major classified groups for general identification purposes with names and addresses of suppliers of materials listed in detail under group classification where name first appears—main offices are shown first, with branch or district offices following. The numeral appearing in listings refers to the major group classification where complete data on the dealer, or representative, may be found.

### AIR CONDITIONING (1b)

Air Conditioning & Cooling  
UTILITY APPLIANCE CORP.  
Los Angeles 58, 4851 S. Alameda St.  
San Francisco, 1355 Market St., UN 1-4908

### ARCHITECTURAL VENEER (1a)

Ceramic Veneer  
PACIFIC CLAY PRODUCTS  
San Francisco: 605 Market St., GA 1-3970  
Los Angeles, Portland, Salt Lake City  
GLADDING, McBEAN & CO. \*(1)  
Porcelain Veneer  
PORCELAIN ENAMEL PUBLICITY BUREAU  
(Dept. AE-450)  
Room 601, Franklin Building, Oakland 12, California  
P. O. Box 186, East Pasadena Station, Pasadena 8, California  
Granite Veneer

VERMONT MARBLE COMPANY  
San Francisco 5: 525 Market Street, SU 1-6747  
Los Angeles 4: DU 2-7834

Marble Veneer  
VERMONT MARBLE COMPANY  
San Francisco 5: 525 Market Street, SU 1-6747  
Los Angeles 4: DU 2-7834

BANKS-FINANCING (1b)  
CROCKER FIRST NATIONAL BANK OF S. F.  
San Francisco, Port & Montgomery St's., EX 2-7700

BRASS PRODUCTS (1a)  
GREENBERG'S, M. & SONS  
San Francisco, Calif.: 765 Folsom, EXbrook 2-3143

BRICKWORK (1)  
Face Brick  
GLADDING, McBEAN & CO.  
San Francisco: Harrison at 9th Sts., UN 1-7400  
Los Angeles: 2901 Los Feliz Blvd., OL 2121  
Offices at Portland, Seattle, Spokane  
KRAFTLE  
Niles, California, Niles 3611  
San Francisco 5: 50 Hawthorne St., DO 2-3780  
Los Angeles 13: 406 South Main St., MU 7241  
REMILLARD-DANDINI CO.  
San Francisco: 400 Montgomery St., EX 2-4988

BRONZES PRODUCTS (1b)  
GREENBERG'S, M. & SONS  
San Francisco, Calif.: 765 Folsom, EXbrook 2-3143

BUILDING PAPER & FELTS (2)  
SISALKRAFT COMPANY  
San Francisco: 55 New Montgomery St., EX 2-3066  
Chicago, Ill.: 205 West Wacker Drive  
ANGIER PACIFIC CORP.  
San Francisco 5: 55 New Montgomery St., DO 2-4416  
Los Angeles: 7424 Sunset Boulevard

BUILDING HARDWARE (3)  
THE STANLEY WORKS  
San Francisco: Monadnock Bldg., YU 6-5914  
New Britain, Conn.

CEMENT (c)  
PACIFIC PORTLAND CEMENT  
San Francisco: 417 Montgomery St., GA 1-4100

CONCRETE AGGREGATES (4)  
Lightweight Aggregates  
AMERICAN PERLITE CORP.  
Richmond, Calif.: 26th & B Sts.—Yard 2, R1 4307

### FIRE ESCAPES (5)

SOULE STEEL  
San Francisco: 1750 Army St., VA 4-4141  
Los Angeles, Calif.—LA 0911  
Portland, Ore.—BE 5155  
Seattle, Wash.—SE 3010  
MICHAEL & PFEFFER IRON WORKS, INC.  
San Francisco 3: Tenth & Harrison Sts.,  
MA 1-5966

### FLOORS (16)

Hardwood Flooring  
HOGAN LUMBER COMPANY  
Oakland: Second and Alice Sts., GL 1-6861  
E. K. WOOD LUMBER CO.  
Los Angeles: 4710 S. Alameda St., JE 3111  
Oakland: 727 Kennedy St., KE 4-8466  
Portland: 827 Terminal Sales Building  
Floor Treatment & Maintenance  
HILLIARD SALES CO. (Western)  
470 Alabama St., San Francisco, MA 1-7766  
Los Angeles, 923 E. 3rd, Trinity 8282  
Seattle, 3440 E. Marginal Way

### GLASS (17)

W. P. FULLER COMPANY  
San Francisco: 301 Mission St., EX 2-7151  
Los Angeles, Calif.  
Portland, Oregon

### HEATING (8)

HENDERSON FURNACE & MFG. CO.  
Sebastopol, Calif.  
S. T. JOHNSON CO.  
Oakland 8: 940 Arlington Ave., OL 2-6000  
San Francisco: 585 Potrero Ave., MA 1-2757  
Philadelphia 8, Pa.: 401 N. Broad St.  
SCOTT COMPANY  
San Francisco: 243 Minna St., YU 2-0400  
Oakland: 113 - 10th St., GL 1-1937  
San Jose, Calif.  
Los Angeles, Calif.  
THOMAS B. HUNTER (Designer)  
San Francisco: 41 Sutter St., GA 1-1164  
UTILITY APPLIANCE CORP. \*(b)

### INSULATION AND WALLBOARD (9)

LUMBER MANUFACTURING CO.  
San Francisco: 225 Industrial Ave., JU 7-1760  
SISALKRAFT COMPANY \*(2)  
WESTERN ASBESTOS COMPANY  
San Francisco: 675 Townsend St., KL 2-3868  
Oakland: 251 Fifth Avenue, GL 1-2345  
Sacramento: 1224 I Street, 2-8993  
Stockton: 1120 E. Weber Ave., 4-1863  
Fresno: 1837 Marced Street, 3-3277  
San Jose: 201 So. Market St., BA 4359-J

### IRON-Ornamental (10)

MICHEL & PFEFFER IRON WORKS, INC. \*(5)

### LANDSCAPE (11a)

Landscape Contractors  
HENRY C. SOTO CORPN.  
Los Angeles, 13000 S. Avalon Blvd. ME 4-6617

### LIGHTING FIXTURES (11)

SMOOT-HOLMAN COMPANY  
Inglewood, Calif., OR 8-1217  
San Francisco: 55 Mississippi St., MA 1-8474

### LUMBER (12)

HOGAN LUMBER COMPANY \*(6)  
LUMBER MANUFACTURING CO. \*(9)  
E. K. WOOD LUMBER CO \*(6)  
Shingles  
SIDEWALL LUMBER COMPANY  
San Francisco 24: 1995 Oakdale Ave., AT 2-8121

### MARBLE (13)

VERMONT MARBLE COMPANY  
San Francisco: 525 Market St., SU 1-6747  
Los Angeles 4: 3522 Council St., DU 2-7834

### METAL LATH EXPANDED (14)

FORDERER CORNICE WORKS  
San Francisco: 269 Potrero Ave., HE 1-4100  
SOULE STEEL \*(5)

### MILLWORK (15)

PACIFIC MANUFACTURING COMPANY  
San Francisco: 16 Beale St., GA 1-7755  
Sante Clara: 2610 The Alameda, SC 607  
Los Angeles: 6820 McKinley Ave., TH 4196  
MULLEN MANUFACTURING COMPANY  
San Francisco: 60-80 Rausch St., UN 1-5815  
LUMBER MANUFACTURING COMPANY \*(9)

### PAINTING (16)

Paint  
W. P. FULLER COMPANY \*(7)

### PLASTER (17)

Exteriors  
PACIFIC PORTLAND CEMENT COMPANY \*(4)  
Interiors—Metal Lath & Trim  
FORDERER CORNICE WORKS \*(14)

### PLASTIC CEMENT (f)

PACIFIC PORTLAND CEMENT CO.  
San Francisco: 417 Montgomery St., GA 1-4100

### PLUMBING (18)

THE SCOTT COMPANY \*(8)  
ELECTROMODE CORPN. (Distributors)  
San Francisco, 1201 Bryant St., UN 3-4000  
Emeryville, 5400 Hollis St., OL 3-4433  
Sacramento, 1131 S St., GI 3-9001  
Fresno, 1234 O St., Fresno 4-4746  
Redding, 2146 Pine St., Redding 200  
THE HALSEY TAYLOR COMPANY  
Redlands, Calif.  
Warren, Ohio  
HAWES DRINKING FAUCET COMPANY  
Berkeley 10: 1435 Fourth St., LA 5-3341  
CONTINENTAL WATER HEATER COMPANY  
Los Angeles 31: 1801 Pasadena Ave., CA 6178  
SIMONDS MACHINERY COMPANY  
San Francisco: 816 Folsom St., DO 2-6794  
Los Angeles: 455 East 4th St., MU 8322  
SECURITY VALVE COMPANY  
Los Angeles 31: 410 San Fernando Rd., CA 6191

### SEWER PIPE (19)

GLADDING, McBEAN & CO. \*(1)

PACIFIC CLAY PRODUCTS  
San Francisco: 605 Market St., GA 1-3970  
Los Angeles, Portland, Salt Lake City

SAN JOSE STEEL COMPANY  
San Jose: 195 North Third St., CO 4184

MICHEL & PFEFFER IRON WORKS, INC. \* (5)  
SOULE STEEL COMPANY \* (5)

**SHEET METAL (20)**

Windows  
DETROIT STEEL PRODUCTS COMPANY  
Oakland 8: 1310 - 63rd St., OL 2-8826  
San Francisco: Russ Building, DO 2-0890  
MICHEL & PFEFFER IRON WORKS, INC. \* (5)  
SOULE STEEL COMPANY \* (5)

Fire Doors  
DETROIT STEEL PRODUCTS COMPANY  
Skylights  
DETROIT STEEL PRODUCTS COMPANY

**STEEL—STRUCTURAL (21)**

COLUMBIA STEEL CO.  
San Francisco: Russ Bldg., SU 1-2500  
Los Angeles: 2087 E. Slauson, LA 1171  
Portland: 2345 N. W. Nicolai, BE 7261  
Seattle: 1331 3rd Ave. Bldg., MA 1972  
Salt Lake City: Walker Bank Bldg., SL 3-6733  
HERRICK IRON WORKS  
Oakland: 18th & Campbell Sts., GL 1-1767  
JUDSON PACIFIC-MURPHY CORP.  
Emeryville: 4300 Eastshore Highway, OL 3-1717  
PUBLIC STEEL CORP.  
San Francisco: 116 N. Montgomery St., GA 1-0977  
Los Angeles: Edison Building  
Seattle: White-Henry-Stuart Building  
Salt Lake City: Walker Bank Building  
Denver: Continental Oil Building  
KRAFFILE COMPANY \* (1)

**STEEL—REINFORCING (22)**

REPUBLIC STEEL CORP. \* (21)  
HERRICK IRON WORKS \* (21)  
SAN JOSE STEEL CO. \* (21)  
COLUMBIA STEEL CO. \* (21)

**TILE (23)**

GLADDING, McBEAN & CO. \* (11)  
KRAFFILE COMPANY \* (1)  
PACIFIC CLAY PRODUCTS  
San Francisco: 605 Market St., GA 1-3970  
Los Angeles, Portland, Salt Lake City

**TIMBER—REINFORCING (b)**

Trusses  
WEYERHAEUSER SALES CO.  
Tacoma, Wash.  
St. Paul, Minn.  
Newark, N. J.  
Treated Timber  
J. H. BAXTER CO.  
San Francisco 4: 333 Montgomery St., DO 2-3883  
Los Angeles 13: 601 West Fifth St., MI 6294

**WALL TILE (24)**

GLADDING, McBEAN & CO. \* (11)  
KRAFFILE COMPANY \* (1)

**WINDOVS STEEL (25)**

DETROIT STEEL PRODUCTS CO. \* (20)

**GENERAL CONTRACTORS (26)**

DINWIDDIE CONSTRUCTION COMPANY  
San Francisco: Crocker Building, YU 6-2718  
CLINTON CONSTRUCTION COMPANY  
San Francisco: 923 Folsom St., SU 1-3440  
MATCOCK CONSTRUCTION COMPANY  
San Francisco: 604 Mission St., GA 1-5516  
PARKER, STEFFENS & PEARCE  
San Francisco: 153 So. Park, EX 2-6639  
STOLTE, INC.  
Oakland: 8451 San Leandro Blvd., TR 2-1064  
SWINERTON & WALBERG COMPANY  
San Francisco: 225 Bush St., GA 1-2980  
Oakland: 1723 Webster St., HI 4-4322  
Los Angeles, Sacramento, Denver  
P. J. WALKER COMPANY  
San Francisco: 391 Sutter St., YU 6-5916  
Los Angeles: 3920 Whitehite St., AN 9-8567

**TESTING LABORATORIES**

(ENGINEERS & CHEMISTS) (27)  
ABBOT A. HANKS, INC.  
San Francisco: 624 Sacramento St., GA 1-1697  
ROBERT W. HUNT COMPANY  
San Francisco: 251 Kearny St., EX 2-4634  
Los Angeles: 3050 E. Slauson, JE 9131  
Chicago, New York, Pittsburgh  
PITTSBURGH TESTING LABORATORY  
San Francisco: 651 Howard St., EX 2-1747

**BUILDING TRADES WAGE (JOB SITES) NORTHERN, CENTRAL AND SOUTHERN CALIFORNIA**

ATTENTION: The following are the PREVALING hourly rates of compensation being paid and in effect by employers by agreement between employees and their union; or as recognized and determined by the U. S. Department of Labor. (Revised to March 1, 1951.)

CRAFT	San Francisco		Alameda		Costa		Fresno		Sacramento		Joan		Santa Clara		Solano		Los Angeles		San Bernardino		San Diego		Santa Barbara		Kern
	\$2.50	\$2.50	\$2.50	\$2.50	\$2.50	\$2.50	\$2.50	\$2.50	\$2.50	\$2.50	\$2.50	\$2.50	\$2.50	\$2.50	\$2.50	\$2.50	\$2.50	\$2.25	\$2.25	\$2.25	\$2.25	\$2.25	\$2.25	\$2.25	
ASBESTOS WORKERS	2.53	2.53	2.53	2.53	2.53	2.53	2.53	2.53	2.53	2.53	2.53	2.53	2.53	2.53	2.53	2.53	2.53	2.25	2.25	2.25	2.25	2.25	2.25	2.25	2.25
BOILERMAKERS	2.53	2.53	2.53	2.53	2.53	2.53	2.53	2.53	2.53	2.53	2.53	2.53	2.53	2.53	2.53	2.53	2.53	2.25	2.25	2.25	2.25	2.25	2.25	2.25	2.25
BRICKLAYERS	3.25**	3.15*	3.15	3.15	2.85	3.25	3.00	3.25	3.00	3.25	3.00	3.25	3.00	3.25	3.00	3.25	3.00	2.625	2.625	2.625	2.625	2.625	2.625	2.625	2.625
BRICKLAYERS, HODCARRIERS	2.45	2.45	2.45	2.45	2.00	2.40	2.25	2.375	2.40	2.25	2.375	2.40	2.25	2.375	2.40	2.25	2.375	2.20	2.20	2.20	2.20	2.20	2.20	2.20	2.20
CARPENTERS	2.325	2.25	2.175	2.175	2.175	2.175	2.175	2.175	2.175	2.175	2.175	2.175	2.175	2.175	2.175	2.175	2.175	2.20	2.20	2.20	2.20	2.20	2.20	2.20	2.20
CEMENT FINISHERS	2.20	2.20	2.20	2.20	2.20	2.20	2.20	2.20	2.20	2.20	2.20	2.20	2.20	2.20	2.20	2.20	2.20	2.28	2.28	2.28	2.28	2.28	2.28	2.28	2.28
ELECTRICIANS	2.75	2.60	2.60	2.60	2.75	2.50	2.50	2.625	2.60	2.50	2.625	2.60	2.50	2.625	2.60	2.50	2.50	2.50	2.50	2.50	2.50	2.50	2.50	2.50	2.50
ELEVATOR CONSTRUCTORS	2.75	2.75	2.75	2.75	2.75	2.75	2.75	2.75	2.75	2.75	2.75	2.75	2.75	2.75	2.75	2.75	2.75	2.25	2.25	2.25	2.25	2.25	2.25	2.25	2.25
ENGINEERS: MATERIAL HOIST	2.19	2.19	2.19	2.19	2.19	2.19	2.19	2.19	2.19	2.19	2.19	2.19	2.19	2.19	2.19	2.19	1.9875	1.9875	1.9875	1.9875	1.9875	1.9875	1.9875	1.9875	1.9875
GLAZIERS	2.30	2.30	2.30	2.30	2.30	2.30	2.30	2.30	2.30	2.30	2.30	2.30	2.30	2.30	2.30	2.30	2.00	2.00	2.00	2.00	2.00	2.00	2.00	2.00	2.00
IRONWORKERS: ORNAMENTAL	2.425	2.425	2.425	2.425	2.425	2.425	2.425	2.425	2.425	2.425	2.425	2.425	2.425	2.425	2.425	2.425	2.25	2.25	2.25	2.25	2.25	2.25	2.25	2.25	2.25
IRONWORKERS: STRUCTURAL	2.375	2.375	2.375	2.375	2.375	2.375	2.375	2.375	2.375	2.375	2.375	2.375	2.375	2.375	2.375	2.375	2.00	2.00	2.00	2.00	2.00	2.00	2.00	2.00	2.00
REINFORCING	2.75	2.75	2.75	2.75	2.75	2.75	2.75	2.75	2.75	2.75	2.75	2.75	2.75	2.75	2.75	2.75	2.25	2.25	2.25	2.25	2.25	2.25	2.25	2.25	2.25
LABORERS: BUILDING	1.65	1.65	1.65	1.65	1.65	1.65	1.65	1.65	1.65	1.65	1.65	1.65	1.65	1.65	1.65	1.65	1.65	1.65	1.65	1.65	1.65	1.65	1.65	1.65	1.65
CONCRETE	1.65	1.65	1.65	1.65	1.65	1.65	1.65	1.65	1.65	1.65	1.65	1.65	1.65	1.65	1.65	1.65	1.65	1.65	1.65	1.65	1.65	1.65	1.65	1.65	1.65
PLASTERERS	2.60	2.60	2.60	2.60	2.60	2.60	2.60	2.60	2.60	2.60	2.60	2.60	2.60	2.60	2.60	2.60	2.25	2.25	2.25	2.25	2.25	2.25	2.25	2.25	2.25
MARBLE SETTERS	2.375	2.375	2.375	2.375	2.375	2.375	2.375	2.375	2.375	2.375	2.375	2.375	2.375	2.375	2.375	2.375	2.40	2.40	2.40	2.40	2.40	2.40	2.40	2.40	2.40
PAINTERS	2.45**	2.45	2.45	2.45	2.45	2.45	2.45	2.45	2.45	2.45	2.45	2.45	2.45	2.45	2.45	2.45	2.22	2.22	2.22	2.22	2.22	2.22	2.22	2.22	2.22
PILEDRIVERS	2.325	2.325	2.325	2.325	2.325	2.325	2.325	2.325	2.325	2.325	2.325	2.325	2.325	2.325	2.325	2.325	2.33	2.33	2.33	2.33	2.33	2.33	2.33	2.33	2.33
PLASTERERS	3.00	3.15*	3.15	3.15	3.15	3.00	3.125	3.00*	3.15	3.00*	3.125	3.00*	3.15	3.00*	3.125	3.00*	2.50	2.75	2.50	2.50	2.50	2.50	2.50	2.50	2.50
PLASTERERS, HODCARRIERS	2.60	2.80	2.80	2.80	2.50	2.40	2.50	2.75	2.50	2.40	2.50	2.75	2.50	2.40	2.50	2.75	2.50	2.25	2.25	2.25	2.25	2.25	2.25	2.25	2.25
PLASTERERS, HODCARRIERS	2.625	2.625	2.625	2.625	2.625	2.625	2.625	2.625	2.625	2.625	2.625	2.625	2.625	2.625	2.625	2.625	2.50	2.50	2.50	2.50	2.50	2.50	2.50	2.50	2.50
PLUMBERS	2.50	2.50	2.50	2.50	2.50	2.50	2.50	2.50	2.50	2.50	2.50	2.50	2.50	2.50	2.50	2.50	2.25	2.00	1.90	2.00	2.00	2.00	2.00	2.00	2.00
ROOFERS	2.3125	2.3125	2.3125	2.3125	2.40	2.50	2.375	2.3125	2.375	2.40	2.375	2.3125	2.375	2.40	2.375	2.3125	2.15	2.15	2.15	2.15	2.15	2.15	2.15	2.15	2.15
SHEET METAL WORKERS	2.625	2.625	2.625	2.625	2.625	2.625	2.625	2.625	2.625	2.625	2.625	2.625	2.625	2.625	2.625	2.625	2.25	2.25	2.25	2.25	2.25	2.25	2.25	2.25	2.25
SPRINKLER FITTERS	2.625	2.625	2.625	2.625	2.625	2.625	2.625	2.625	2.625	2.625	2.625	2.625	2.625	2.625	2.625	2.625	2.50	2.50	2.50	2.50	2.50	2.50	2.50	2.50	2.50
STEAMFITTERS	2.625	2.625	2.625	2.625	2.625	2.625	2.625	2.625	2.625	2.625	2.625	2.625	2.625	2.625	2.625	2.625	2.25	2.25	2.25	2.25	2.25	2.25	2.25	2.25	2.25
TRUCK DRIVERS—1/2 Ton or less	1.58	1.58	1.58	1.58	1.58	1.58	1.58	1.58	1.58	1.58	1.58	1.58	1.58	1.58	1.58	1.58	1.58	1.58	1.58	1.58	1.58	1.58	1.58	1.58	1.58
TRUCK DRIVERS—3/4 Ton or less	2.875	2.875	2.875	2.875	2.50	2.875	2.4325	2.875	2.4325	2.875	2.4325	2.875	2.4325	2.875	2.4325	2.875	2.50	2.50	2.50	2.50	2.50	2.50	2.50	2.50	2.50
TILESETTERS	2.875	2.875	2.875	2.875	2.50	2.875	2.4325	2.875	2.4325	2.875	2.4325	2.875	2.4325	2.875	2.4325	2.875	2.50	2.50	2.50	2.50	2.50	2.50	2.50	2.50	2.50

\* 6 Hour Day, \*\* 7 Hour Day.

Prepared and compiled by:

CENTRAL CALIFORNIA CHAPTER, ASSOCIATED GENERAL CONTRACTORS OF AMERICA, with the assistance and cooperation of secretaries of General Contractors Associations and Builders Exchanges of Northern California; and the above information for southern California is furnished by the Labor Relations Department of the Southern California Chapter, ASSOCIATED GENERAL CONTRACTORS OF AMERICA.

**CLASSIFIED ADVERTISING**

RATE: 20c PER WORD . . . CASH WITH ORDER

MINIMUM \$5.00

**PLANNING CHURCH BUILDINGS.** Portfolio—64 oversized pages 144 cuts; floor plans, exterior and interior views; recently planned buildings costing \$30,000 upward. Largest collection plans of Protestant churches assembled. Price \$2.00 p.p. WRITE Bureau of Architecture, 300 Fourth Ave., New York 10, N. Y.

**BUILDERS!** You can make more money; get information you need before it is published elsewhere; Subscribe to the daily ARCHITECTS REPORTS, only \$10.00 per month. Complete information from ARCHITECTS REPORTS, 68 Post Street, San Francisco, Phone DOuglas 2-8311.

**WANTED:** Experienced specification writer and building estimator by San Francisco ARCHITECT. Write WE 1-6 c/o ARCHITECT & ENGINEER, 68 Post Street, S. F.

**GET THE BEST.** don't be satisfied with anything but the best. Window sash, Doors, Cabinets, etc. Town Talk Sash & Door Mill, 524 9th St., Sacramento.

**PHOTOGRAPHY.** For the best in construction photography, including exterior and interior, aerial, and progress views . . . you will find as many others have that it's the SKELTON STUDIO'S, 137 Harlan Place, San Francisco, Telephone YUkon 6-6321.

**FLOOR COVERINGS** for industrial, commercial, and residential construction. Complete lines, one of the oldest, best established organizations in the Sacramento Valley. LATTIN'S, INC., 1519 Alhambra Blvd., Sacramento.



## ARCHITECTS FOR SCHOOL PROJECTS ARE SELECTED

Donald L. Hardison, architect of Richmond, has been chosen by the Richmond Board of Education to draft plans for the construction of a new Bayview grammar school.

Charles F. Strothoff, architect of San Francisco, has been chosen by the Richmond Board of Education to design another new grammar school in Richmond.

Swartz & Hyberg, architects of Fresno, have been selected by the Firebaugh Joint Union School District to draft plans for three new grammar schools in Firebaugh, Fresno County, to cost \$993,998.

Robert C. Kaestner, architect of Visalia, has been chosen by the Palo Verde Union Elementary School District, Tulare County, to draw plans for an addition to the grammar school project, cost \$202,000.

## LOS ANGELES CHURCHES

There were sixty-two building permits, amounting to \$2,831,940, issued in Los Angeles for church buildings during 1950.

## SHOPPING CENTER FOR COSTA MESA

Construction of a 5-block shopping center in Costa Mesa has started which represents an investment of \$750,000 in land and construction.

The development will have a spacious area for off-street customer parking.

## NEW RESIDENTIAL CONSTRUCTION

250 new homes are being constructed at Mt. View by the Meadow Development Company of Mountain View. Each unit is of frame construction and will cost \$7,000 each.

40 new homes are being built at Benicia by the Slegge Construction Company of Vallejo. Each unit is of single story frame construction and will cost \$8,000.

28 new homes are being built in Ashbury Park, near Concord, Contra Costa County, by the Ver Mehr-Smith Company of Berkeley. Each unit is of frame construction and will cost \$7,000 per unit.

85 new homes are under construction in the San Lorenzo area by the San Lorenzo Homes Company. Of frame and stucco construction each unit will cost \$7,000.

77 new homes are being built in the Concord Estates tract near Concord by the Lockwood Estates Company of Oakland. One story frame type construction they will sell for \$6,000 each.

14 new homes are being built on Fernwood Street in San Mateo by the Peninsula Home Builders of San Mateo. Frame and stucco construction each unit will sell for \$6,000.

## GETS TUCSON CONTRACT

The L. M. White Contracting Company of Tucson has been awarded a \$104,113 contract by the Tucson City Council for the construction and improvements in the 16th and South Park Ave. district and paving improvement project.

## ARCHITECT SELECTED

Fred L. Markham, architect of Provo, Utah, has been chosen to design a student union building for the Utah State Agricultural College in Salt Lake City. Cost is \$1,000,000.

# ELECTROMODE ALL-ELECTRIC ROOM HEATER... THE WORLD'S FINEST!

**First choice of architects and engineers in thousands of California homes — for these reasons:**

- (1) **SAFETY SWITCH**—Automatically shuts off current if temperature of element rises above normal operating level. Prevents overheating in case fan fails to operate or when circulation of air is retarded by furniture or drapes.
- (2) **G. E. FAN**—Famous for long life and quiet operation. Its factory sealed motor never needs oiling!
- (3) **DOWN-FLO CIRCULATION**—Warmed air is gently fan-forced down into the living zone and does not pile up wastefully at the ceiling. This exclusive method of distributing heat uniformly throughout a room also prevents smudge on wall above heater.

- (4) **PATENTED ELEMENT**—The greatest feature any all-electric heater ever had—and only Electromode has it! No exposed red-hot wires—no danger of fire, shock, or burn! It consists of a nickel chromium wire resistor coil, insulated with a fused oxide powder, encased in a seamless metal tube, and embedded in a finned aluminum casting, which completely seals the tube. There is perfect thermal contact between all portions of the element, assuring superior heat diffusion. Heat transfer surface is 888 square inches—many times greater than a bare coil—which means maximum heating efficiency at minimum cost. Designed in every detail for a life-time of trouble-free service!

- (5) **SILVER-GREY FINISH**—Blends well into any home decorative scheme. Face plate is practically flush with wall. Smooth, hammered finish is easy to keep clean.

- (6) **STANDARD WALL BOX**—Easy to install. Regardless of capacity, all Electromode Down-Flo heaters have the same size wall box and fit between standard studs. Installation is just as simple as wiring in a standard 240-volt outlet.



Electromode Down-Flo heaters are practically flush with the wall.

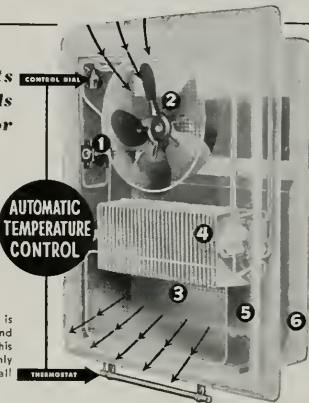

Approved by Underwriters' Laboratories

**AUTOMATIC CONTROL**—If desired, temperatures varying from 55 to 85 degrees can be maintained simultaneously in different rooms of the same house! Each heater has its own built-in thermostat of the reliable, hydraulic type. A fingertip control dial is located within easy access near the top of the heater, on the outside.

## Write for Catalog

Electromode heaters are manufactured by Electromode Corp. of Rochester, N. Y., the world's leading exclusive manufacturer of all-electric heaters. They are distributed in Northern California by Dunham, Carrigan & Hayden; General Electric Supply Corp.; Gray Electric Co., Inc.; Leo J. Meyberg Co.; The Thomson-Diggs Co.; and other leading wholesalers. For complete information on Electromode heaters for domestic, commercial, and industrial use, write to Dept. A41, Russell & Co., 1355 Market St., S. F. 3.



Whatever the main heating system may be, every home should have an Electromode heater in the bathroom for quick comfort on chilly mornings. This wall type electric heater may be automatic or non-automatic. It operates on standard 120 volt wiring, comes in white or chrome finish, and has all safety features of other Electromodes!

**ELECTROMODE**  
Room Heaters



## CONSTRUCTION CONTRACTS AWARDED AND MISCELLANEOUS PERSONNEL DATA

**HOUSING PROJECT.** Fort Ord, Monterey County. U. S. Army, owner. 500 family dwellings under Wherry Act. \$4,500,000. ARCHITECT: Geo. Shaffer, El Monte. STRUCTURAL ENGINEER: James Hill, Los Angeles. 7 buildings—4 one bedroom units; 115 duplex, 2-bedrooms; 70 residences, 2-bedrooms; 46 duplex, 3-bedrooms, and 80 3-bedroom houses. All are of pre-cast pumice concrete construction. GENERAL CONTRACTOR: Likins, Foster & Associates, Huntington Park.

**CHURCH.** Taft, Kern County. Roman Catholic Diocese of Monterey-Fresno, owner. St. Mary's Parish, \$85,000. STRUCTURAL ENGINEER: Lawrence D. Voile, North Hollywood. Frame and stucco construction with tile roof. GENERAL CONTRACTOR: John Howard Construction Co., Taft.

**FACTORY BUILDING.** San Pablo, Contra Costa County. Rheem Mfg. Co., owner. On foundation, \$1,000,000. ARCHITECT: Alben Froberg, Oakland. 1 story with 200,000 sq. ft., reinforced concrete and structural steel construction. GENERAL CONTRACTOR: Christensen & Lyons, Oakland.

**SANTA FE GRAMMAR SCHOOL.** Shafter, Kern County. Richland Elementary School District, owner. Addition and storage warehouse and maintenance shop. \$405,838. ARCHITECT: Kump Associates, San Francisco. Frame and stucco construction. GENERAL CONTRACTOR: Guy E. Hall, Bakersfield.

**MORTUARY.** Palo Alto, Santa Clara County. Reller & Hopgood, owner. \$150,000. ARCHITECT: Leslie L. Nichols, Palo Alto. 1-story with 12,000 sq. ft., frame and stucco construction, some stone veneer, brick walls, composition roofing with shake roof, and forced hot air conditioning. GENERAL CONTRACTOR: Aro & Okerman, Palo Alto.

**HOSPITAL.** Hollister, San Benito County. Hazel Hawkins Hospital, owner. Addition to present building, \$89,598. ARCHITECT: Binder & Curtis, San Jose. 1-story frame and stucco construction. GENERAL CONTRACTOR: Bridges Construction Co., San Jose.

**ALAMEDA HOSPITAL.** Alameda, Alameda County. Alameda Hospital, owner. Remodel and addition to present building, \$84,210. ARCHITECT: D. D. Stone & Lou Mulloy, San Francisco. 1-story reinforced concrete and structural steel to contain laboratory, pharmacy, dining room and doctors' lounge. GENERAL CONTRACTOR: Anderson-Haglund, Inc., Oakland.

### PANACALITE

The Standard for Perlite Aggregates  
An Engineered Product—Engineering Service

Air Classified—Sized & Graded for  
Plaster, Concrete & Stucco  
Aggregates

Listed Underwriters' Laboratories  
Re-examination Service

Fire Ratings:  
Non-Bearing Walls—2 hours  
Floor and Beam—2 hours  
Column—2 & 3 hours  
Suspended Ceiling—4 hours  
Others

Manufactured by

**American Perlite Corporation**  
26th & 8 Sts.—Yard 2—Richmond  
BEcon 5-1385

**PARISH HOUSE.** San Francisco. St. Luke's Episcopal Church, owner. \$120,000. ARCHITECT: Ward & Bolles, San Francisco. 3-story with basement, reinforced concrete construction. GENERAL CONTRACTOR: Dinwiddie Construction Co., San Francisco.

**OFFICE BUILDING.** South San Francisco, San Mateo County. Guy F. Atkinson Co., owner. \$175,000. ARCHITECT: Alired W. Johnson, San Francisco. 2-story and basement reinforced concrete construction. owner builds and awards separate contracts.

**SAN LORENZO HIGH SCHOOL.** San Lorenzo, Alameda County. Hayward Union High School District, owner. Addition of a gymnasium, \$313,923. ARCHITECT: Schmidts & Hardman, Berkeley. Reinforced concrete and structural steel and frame. GENERAL CONTRACTOR: California Builders Co., Inc., Oakland.

**NURSES SCHOOL ADD'N. & REMODEL.** San Francisco. Dental Nurses Training School, owner. \$58,000. ARCHITECT: B. G. Nobler, San Francisco. 2-story 50x70 ft., concrete block, wood floors and roof. GENERAL CONTRACTOR: Central California Construction Company, San Francisco.

**MEDICAL BUILDING.** Oakland, Alameda County. Harry Penn, owner. \$83,475. ARCHITECT: B. J. Sabarwal, San Francisco. 2-story, frame and stucco with structural steel frame. GENERAL CONTRACTOR: Harry K. Jensen, Oakland.

**POST OFFICE & COURT HOUSE CHANGES.** San Francisco. U. S. Public Buildings Services, owner. Modernization of building at 7th and Mission, \$263,900. GENERAL CONTRACTOR: Barrett & Hilp, San Francisco.

**FIRE STATION.** San Pablo, Contra Costa County. County of Contra Costa, owner. Fire station No. 2, \$30,868. ARCHITECT: Schmidts & Hardman & Cough, Berkeley. 1-story, concrete block and frame construction. GENERAL CONTRACTOR: R. F. Johnson & Son, El Cerrito.

**CHURCH & SUNDAY SCHOOL.** Stockton, San Joaquin County. Grace Methodist Church, owner. \$204,187. GENERAL CONTRACTOR: Shepherd & Green, Stockton.

**HIGH SCHOOL.** Princeton, Colusa County. Princeton Joint Union High School District, owner. Science building addition, \$32,388. ARCHITECT: Koblik & Fisher, Sacramento. Frame and stucco construction. GENERAL CONTRACTOR: A. F. Miller, Sacramento.

**RED CROSS BUILDING.** Walnut Creek, Contra Costa County. American Red Cross, owner. \$23,822. ARCHITECT: Leonard Ford, Walnut Creek. 1 story, 2,000 sq. ft. Aggregate block and frame construction, tile roof. GENERAL CONTRACTOR: Wendt Construction Company, Berkeley.

**BONNY VIEW GRAMMAR SCHOOL.** Redding, Shasta County. Redding Elementary School District, owner. 8 classrooms, office and toilet room, \$196,427. ARCHITECT: Clayton Kantz, Redding. Frame construction. GENERAL CONTRACTOR: B. R. Construction Co., San Francisco.

**GRAMMAR SCHOOL.** Dos Palos, Fresno County. Bryant Elementary School District, owner. \$145,000. ARCHITECT: Coates & Metz, Fresno. Frame and stucco construction. GENERAL CONTRACTOR: Clarence Ward Construction Co., Fresno.

**LIBRARY BUILDING.** Monterey, Monterey County. City of Monterey, owner. \$300,127. ARCHITECT: Wursler, Bernardi & Emmons, San Francisco. 1 story and basement and mess, 18,000 sq. ft. Reinforced concrete,

structural steel frame, shake roof. GENERAL CONTRACTOR: Harold C. Geyer, Monterey.

**CONVENT.** Vallejo, Solano County. Roman Catholic Archbishop of S. F., owner. \$142,251. ARCHITECT: Ryan Lee, San Francisco. 1 and 2 story, frame and stucco construction, composition and tile roof. GENERAL CONTRACTOR: Herbert A. Crocker Co., San Rafael.

**PAROCIAL SCHOOL AND CONVENT.** Marysville, Yuba County. Roman Catholic Diocese of Sacramento, owner. 8 classrooms and kindergarten. \$296,400. ARCHITECT: Harry J. Devine, Sacramento. GENERAL CONTRACTOR: C. A. Otto, Marysville.

**THOMAS JEFFERSON SCHOOL ADDITION.** San Leandro, Alameda County. San Leandro Elementary School District, owner. 4 classrooms, multi-purpose, kitchen, toilet room, other meeting room into 2 classrooms, \$192,999. ARCHITECT: Schmidts & Hardman, Berkeley. Frame and stucco construction. GENERAL CONTRACTOR: Steadman & Powell, Oakland.

**WOODROW WILSON SCHOOL ADDITION.** San Leandro, Alameda County. San Leandro Elementary School District, owner. 4 classrooms, multi-purpose, kitchen, 2 dressing rooms, storage room and toilet room. \$213,500. ARCHITECT: Schmidts & Hardman, Berkeley. Frame and stucco construction. GENERAL CONTRACTOR: Pacific Co., Oakland.

**HIGH SCHOOL ADDITION.** Alpaugh, Tulare County. Alpaugh Union High School District, owner. Combination gymnasium and auditorium, 2 classrooms and shop building. \$149,400. ARCHITECT: Walter Wagner, Fresno. Gym: concrete block and structural steel frame. Classroom: frame and stucco construction. GENERAL CONTRACTOR: Dalke Bros., Shafter.

**CHURCH.** Sunnyvale, Santa Clara County. First Baptist Church, owner. \$60,000. ARCHITECT: Donald Powers Smith, San Francisco. Concrete block and frame construction. GENERAL CONTRACTOR: Harris & Feldheim, Menlo Park.

**JAMES A. GARFIELD SCHOOL ADDITION.** San Leandro, Alameda County. San Leandro Elementary School District, owner. 4 classrooms and multi-purpose room. \$82,921. ARCHITECTS: Schmidts & Hardman, Berkeley. Frame and redwood siding and brick veneer. GENERAL CONTRACTOR: L. Nielsen, Lafayette.

**MECHANICAL SUPERVISORS BUILDING.** Avon, Contra Costa County. Tidewater Associated Oil Co., owner. \$50,000. ARCHITECT: Reynolds & Chamberlain, Oakland. 1 story concrete block and frame construction, steel sash, asphalt tile floors. GENERAL CONTRACTOR: Vezey Construction Co., Oakland.

**GRAMMAR SCHOOL ADDITION.** Bakersfield, Kern County. Edison Elementary School, owner. 3 classrooms, 3 auxiliary rooms and toilet room. \$92,100. ARCHITECT: Ernest L. McCoy, Bakersfield. 5820 sq. ft. frame and stucco construction, steel sash, asphalt tile floors, radiant heating. GENERAL CONTRACTOR: Willard K. Michael, Bakersfield.

**HIGH SCHOOL ADDITION.** Campbell, Santa Clara County. Campbell Union School District, owner. Girls' gym, swimming pool, music building and home making unit. \$496,990. ARCHITECT: Birge M. Clark and Walter Stromquist, Palo Alto. Frame and stucco construction. GENERAL CONTRACTOR: E. A. Hathaway & Co., San Jose.

**SEWAGE DISPOSAL PLANT.** Santa Rosa, Sonoma County. City of Santa Rosa, owner. \$876,859. ENGINEER: BROWN & CALDWELL, San Francisco. Reinforced con-

crete construction. GENERAL CONTRACTOR: Walsh Construction Co.

#### BUS DEPOT ADDITION AND REMODEL.

Santa Rosa, Sonoma County. Pacific Greyhound Lines, owner. \$65,985. ARCHITECT: C. A. Caulkins, Santa Rosa. Reinforced construction, some structural steel and frame construction. GENERAL CONTRACTOR: Walter L. Olson, Santa Rosa.

#### DOWNEY HIGH SCHOOL ADDITION.

Modesto, Stanislaus County. Modesto Board of Education, owner. 6 classrooms, 2 shop buildings, 2 home economics units, boys' gymnasium, boys' toilet rooms. \$359,500. ARCHITECT: Harry J. Devine, Sacramento. Reinforced, concrete and frame construction. GENERAL CONTRACTOR: Frank A. Payne & Son, Orinda.

#### GRAMMAR SCHOOL ADDITION.

Oildale, Kern County. Standard Elementary School District, owner. 7 classrooms, toilet rooms. \$99,750. ARCHITECT: Altard & Thomas, Bakersfield. Frame and stucco construction, insulated steel sash, asphalt tile floors. 9,000 sq. ft. GENERAL CONTRACTOR: Rissler Construction Co., Bakersfield.

#### WAREHOUSE BUILDING.

Oakland, Alameda County. Fruitvale Warehouse Co., Inc., owner. \$600,000. STRUCTURAL ENGINEER: J. Y. Long Co., Oakland. 1 story, 180,000 sq. ft. Reinforced concrete walls, wood roof. GENERAL CONTRACTOR: Van Bekkelen-Cole Co., Oakland.

#### BOHANNON GRAMMAR SCHOOL ADDITION.

San Lorenzo, Alameda County. San Lorenzo Elementary School District, owner. 13 classrooms, administration, library, music, multi-purpose, kitchen, craft room, home making room and toilet room. \$578,000. ARCHITECT: Schmidts & Hardman, Berkeley. GENERAL CONTRACTORS: Indenco, Oakland.

#### NEW GRAMMAR SCHOOL AND KINDERGARTEN.

Alamo, Contra Costa County. Alamo Elementary School District, owner. 5 classrooms, administration and toilet rooms. \$149,892. ARCHITECT: Floyd Comstock, Walnut Creek. Frame construction, redwood exterior. GENERAL CONTRACTOR: A. F. Stewart, Berkeley.

#### GYMNASIUM BUILDING.

Middletown, Lake County. Middletown Unified High School District, owner. \$64,000. ARCHITECT: Clayton Van Wagner, Oakland. Frame and stucco construction. GENERAL CONTRACTOR: Robert E. Griffin, El Cerrito.

#### PAROCHIAL HIGH SCHOOL.

Salinas, Monterey County. Roman Catholic Diocese of Fresno-Monterey, owner. Administration, 8 classrooms and toilet room, \$190,000. ARCHITECT: Chas. E. Butner, Salinas. Reinforced concrete and frame and stucco construction. GENERAL CONTRACTOR: Vera R. Buck, Salinas.

#### GRAMMAR SCHOOL ADDITION.

Delano, Kern County. Delano Elementary School District, owner. 5 classrooms, outdoor classrooms and toilet room. \$127,723. ARCHITECT: Kump Assoc., San Francisco. Frame and stucco construction. GENERAL CONTRACTOR: Midstate Construction Co., Fresno.

#### SUNVALLEY GRAMMAR SCHOOL.

San Rafael, Marin County. San Rafael Board of Education, owner. 5 classrooms, offices and toilet room. \$158,752. ARCHITECT: Kirby & Mulvin, San Francisco. Frame and stucco construction. GENERAL CONTRACTOR: Alfred P. Fisher, San Francisco.

#### BURBANK JUNIOR HIGH SCHOOL ADDITION.

Berkeley, Alameda County. Berkeley Board of Education, owner. \$596,700. ARCHITECT: Miller & Wearnke, San Francisco. 2 story, reinforced concrete construction. GENERAL CONTRACTOR: Herbert E. Ellis, Berkeley.

#### DEPARTMENT STORE BUILDING.

San Mateo County. Dr. A. O. Shanakey, owner.

\$390,000. ARCHITECT: Albert F. Roller, San Francisco. 2 story and basement, 100x 139 reinforced concrete and structural steel frame, escalator and elevator. GENERAL CONTRACTOR: Dinwiddie Construction Co., San Francisco.

#### FACTORY AND OFFICE BUILDING.

San Leandro, Alameda County. Frank Lechner, owner. \$250,000. PLANS BY: Austin Co., Oakland. 1 story, 60,000 sq. ft. Tilt-up reinforced concrete walls, structural steel frame and some wood roof trusses, steel sash, concrete floors. GENERAL CONTRACTOR: Austin Co., Oakland.

#### ELECTRONICS RESEARCH LABORATORY BUILDING.

Palo Alto, Santa Clara County. Stanford University, owner. \$184,774. 1 story, concrete block and frame construction, concrete floor. GENERAL CONTRACTOR: Wagoner and Martinez, San Francisco.

#### GRAMMAR SCHOOL BUILDING.

Fresno, Fresno County. Hough-on-Kearney Union Elementary School District, owner. \$236,500. ARCHITECT: Wm. J. Hostrup, Fresno. GENERAL CONTRACTOR: Lewis C. Nelson & Sons, Selma.

#### MARKET BUILDING.

San Francisco, Felix Martinucci, owner. \$88,781. ARCHITECT: Leonard S. Magias, San Francisco. 1 story, reinforced concrete, wood roof, trusses, some structural steel. GENERAL CONTRACTOR: Rude Construction Co., San Francisco.

#### TEMPORARY CHURCH.

San Francisco. Roman Catholic Church, owner. \$56,498.

ARCHITECT: Vincent Buckley, San Francisco. Frame and stucco construction. GENERAL CONTRACTOR: Robt. McCarthy Co., San Francisco.

#### HOWE GRAMMAR SCHOOL.

Sacramento, Sacramento County. Arcado Elementary School District, owner. 12 classrooms, kindergarten, administration and toilet room. \$302,286. ARCHITECT: Gordon Stafford, Sacramento. Frame construction, redwood and brick veneer exterior. GENERAL CONTRACTOR: Guth & Schmidt, Sacramento.

#### OFFICE BUILDING.

Sacramento County. A. Teichert & Sons, owner. \$181,000. ARCHITECT: Herbert E. Goodpostor, Sacramento. 1 and 2 story, reinforced concrete and frame construction. GENERAL CONTRACTOR: Erickson Construction Co., North Sacramento.

## MONSON BROS.

building  
construction

475 Sixth Street San Francisco 3

DOuglas 2-5357

## How to place telephone outlets to protect home's future beauty

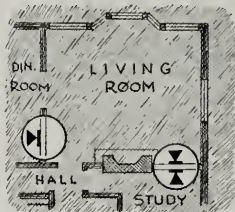

You protect the beauty of home interiors by providing for extra telephone outlets in the plans. Current building practices, such as the reduction in size or omission of inside trim, make future installation of telephone facilities difficult. But concealment of facilities is assured when built-in conduit is indicated in blueprints.

Plan for telephone service where the users will spend most of their time. Low-cost facilities for concealed wiring are easy to install, mean extra client satisfaction. New telephones can be added without running wires along the walls or floor. For free help in planning, call your local Pacific Telephone office, ask for "Architects & Builders Service."

Put built-in telephone facilities in your plans



Pacific Telephone

# IN THE NEWS

## ARCHITECT FOR NEW HIGH SCHOOL

The architectural firm of Koblik & Fisher of Sacramento have been commissioned by the Paradise Unified School District to draw plans for a new six year high school building in Paradise, California.

Cost of the frame and stucco building will be about \$500,000.

## BUILDING HOMES AT PALM SPRINGS

Kuri & Morrison of Beverly Hills has been selected by the Palm Desert Corporation to build a group of special climate-controlled desert homes at Palm Springs, according to Cliff W. Henderson, president of the corporation and developers of the property south of the million dollar Shadow Mountain Club.

Two model homes will be started immediately and will require 21 days to complete. Completely furnished they will represent low-cost homes for families who are making the desert their permanent home.

Everett Burnside of Kuri & Morrison has been appointed sales representative of the new homes.

## ARCHITECT CHOSEN FOR ARMY HOUSING PROJECT

The architectural firm of Ferris & Erskine of Reno, Nevada, have been commissioned by the Corps of Engineers, U. S. Army, to draft plans for the construction of 125 housing units at the Sierra Ordnance Depot, Herlong, Lassen County, California.

The project is to be constructed under terms and provisions of the Wherry Act.

## RECOMMENDED COMMERCIAL STANDARD SEPTIC TANKS

A recommended Commercial Standard for Bituminous Coated Metal Septic Tanks (Single compartment, residential) has been circulated to manufacturers, distributors, installers, and users by the Commodity Standards Division of the Office of Industry and Commerce, U. S. Department of Commerce.

The recommendation sets forth generally acceptable requirements for single compartment, residential, metal septic tanks of satisfactory design and durability for a better understanding between manufacturers, distributors, architects and builders.

## ARCHITECT SELECTED FOR COUNTY OFFICE

Architects Birge M. Clark and Walter Stomquist of Palo Alto have been chosen by the Santa Clara County Board of Supervisors to draft plans for the construction of a new county office building in San Jose.

Cost of the 1-story, reinforced concrete structure will be about \$451,200.

## SCHOOL BONDS VOTED

Voters of the San Lorenzo Valley Unified School District recently approved a bond issue of \$182,000 for the construction of a new grammar school and high school at Boulder Creek, Santa Cruz County.

Architect John Lyon Reid, San Francisco, has been selected to draw the plans. An additional state aid loan of \$900,000 has been approved for the project.

## ARMY HOUSING SAN FRANCISCO

Anqup McSweeney, architect of San Francisco, has been chosen by the Corps of Engineers, U. S. Army to draw plans and specifications for a 500 unit housing project to be built in the Presidio of San Francisco under provisions of the Wherry Act.

## IDEAL SUBDIVISION BY WOMAN BUILDER

Dorothy Shehan, developer of Park McDowell housing project in Phoenix, Arizona, has realized a 20-year ambition in converting a piece of farm property nine miles out of Phoenix into one of the finest subdivisions in the Southwest.

## LOW INCOME HOUSING PROJECT FOR FRESNO

A government grant of \$505,711 has been approved for the construction of a 224 low income housing project for Fresno. Total cost of the project will exceed \$1,500,000, according to the Housing Authority of the City of Fresno.

Architect Walter Wagner of Fresno has been commissioned to draft plans for the buildings which are to be of frame and stucco construction with a plywood interior.

## NEW SCREEN AND STORM DOOR LATCH

A new screen and storm door latch for doors from  $\frac{3}{4}$  in. to 1 $\frac{1}{2}$  in. in thickness has been announced by The Stanley Works of New Britain, Conn.



Made in steel or brass it is smartly designed to harmonize with exterior of any home. Easy to install. Operates smoothly by push-pull action; self latching, even on doors equipped with a door closer. Another feature is trip lever which locks door securely, but won't lock you out. Available in standard hardware finishes.

## WELFARE BUILDING ARCHITECT CHOSEN

The San Francisco architectural firm of D. D. Stone and Lou B. Mulloy have been chosen by the San Mateo County board of supervisors to draft plans for a new health and welfare building in San Mateo.

The buildings are to be erected near the San Mateo County Community Hospital and will cost approximately \$475,000.

## MOFFETT FIELD EXPANSION

The engineering firm of Knappan, Tippets, Abbett Engineering Company of San Francisco has been selected by the U. S. Navy, Bureau of Yards and Docks, to design additional naval facilities at the Naval Air Station at Moffett Field in Santa Clara County.

Details of the project have not been an-

nounced, however, it is estimated the cost of the work to be done will be in the neighborhood of \$14,000,000.

## SCHOOL BONDS ARE VOTED

Voters of the Rodeo Elementary School District, Contra Costa County, have approved a bond issue of \$587,000 for the construction of an addition to the Hillcrest School and a new 13-classroom school at Garretton Heights.

## ARCHITECT HAS NEW ADDRESS

Architect Joseph Kaiser, whose former address was Lake Arrowhead, California, is among those who will be served by the new Post Office established by the post office department at Crest Park, California.

Kaiser's new address is: P. O. Box 9, Crest Park, California.

## KITCHEN ADDED TO COUNTY HOSPITAL

The Contra Costa County board of supervisors has commissioned the architectural firm of Masten & Hurd of San Francisco to design a new kitchen addition to the County Hospital at Martinez.

## ARCHITECT CHOSEN FOR COUNTY BUILDINGS

The architectural firm of Confer & Willis of Oakland have been chosen by the Contra Costa County Board of Supervisors to draft plans for the remodeling of county buildings at Martinez.

The old juvenile Hall will be converted into office building, with remodel of both the exterior and interior.

## ENGINEER SELECTED FOR DRYDOCK PROJECT

The U. S. Navy Bureau of Yards and Docks, San Francisco office, has selected the engineering firm of L. H. & B. L. Nishkian of San Francisco to design and supervise repairs to several dry docks at the San Francisco Naval shipyard at Hunters Point.

## NEW GRAMMAR SCHOOL

The Farmersville Elementary School District, Tulare County, has chosen architects David Horn and Marshall Morland of Fresno to draft plans for two new grammar schools at a cost of \$465,000.

The schools will contain 10 classrooms, two kindergartens, two administration and two all purpose rooms, kitchen, domestic science, shop and toilet rooms.

## FEDERAL FUNDS ALLOTTED

The Corps of Engineers, U. S. Army, office of district engineer in San Francisco, has announced the allotment of \$5,050,000 for the construction of two new warehouses at the Benicia Arsenal in Solano County.

The buildings are to be constructed of reinforced concrete and structural steel.

## ARCHITECT SELECTED

Masten & Hurd, architectural firm of San Francisco, has been selected by the San Bruno Elementary School District to draft plans for an addition to the San Bruno Edgemont Grammar School. Estimated cost is \$125,000.

## NEW GRAMMAR SCHOOL

Leslie C. Irwin, architect of San Francisco, has been chosen by the San Bruno



### Thinking of Building?

From our cost records and experience, an advance estimate may be made from decidedly general information. Based on our knowledge of labor and material costs, gained on current jobs, such an estimate may be helpful in determining your construction program.

ALL TYPES CONSTRUCTION  
SAN FRANCISCO • SACRAMENTO

**SWINERTON & WALBERG CO.**  
OAKLAND • LOS ANGELES • DENVER

### STATIONERY SCHOOL & OFFICE SUPPLIES

•  
Printing Engraving  
Announcements

### CENTER STATIONERY

468 McAllister

San Francisco UN 1-3703

## MULLEN MFG. COMPANY

BANK, STORE AND OFFICE  
FIXTURES—CABINET WORK  
OF GUARANTEED QUALITY  
CHURCH SEATING

—  
Office and Factory  
40-80 RAUSCH ST., Bet. 7th and 8th Sts.  
San Francisco  
Telephone UNderhill 1-5815

Park Elementary School District to draw plans for a new 18-classroom grammar school to be erected in the Northwest District.

Of frame and stucco construction the new school will cost \$700,000.

### APPOINTED

H. W. Sanders, vice president of the Air Reduction Pacific Co., Emeryville, has been appointed vice chairman of the California State Chamber of Commerce's important Central Coast Industrial Committee. The committee initiates and executes studies and projects for furthering the industrial activities of nine counties.

### SCHOOL BID REJECTED

The Bonita Unified School District has rejected a bid of \$180,000 for the construction of a new 9-classroom, kindergarten, office and toilet rooms grammar school.

Of frame and stucco construction the project will be readvertised for bids.

### ARCHITECT CHOSEN

The Conejo Elementary School District, Fresno County, has commissioned architect Benjamin Lippold of Fresno to draft plans for a new grammar school.

Of frame and stucco construction the building will contain 5 classrooms, kitchen, storeroom, and toilet rooms, library, multipurpose room, and administrative facilities. Cost \$149,225.

### HUNTERS POINT

Leland S. Rossner, engineer of San Francisco, has been selected by the U. S. Navy, Bureau of Yards and Docks, to design plans for the remodeling of several buildings at Hunters Point.

### ENGINEER CHOSEN

Kaiser Engineers, Inc. of Oakland, have been chosen by the U. S. Navy, Bureau of Yards and Docks, to design additional runways and a jet engine repair shop at the U. S. Naval Air Station at Alameda.

Cost of the project will exceed \$7,000,000 according to present plans.

### HOSPITAL ADDITION

Architectural firm of Skidmore, Owings & Merrill of San Francisco has announced plans are under way for the construction of a 52-bed addition to St. Lukes Hospital, San Francisco, at an estimated cost of \$3,000,000.

The addition will also contain a laboratory, nursery, clinic, and addition to the nurses homes.

### NEW RESIDENCES

#### FOR SAN LEANDRO

Groom-Mayers & Associates of Oakland have announced the construction of 86 new homes in the San Leandro area.

Of frame and stucco construction the houses are to sell for \$7,000 each.

### HOUSING PROJECT FOR U. S. AIR FORCE

The National Engineering Development Company of Tampa, Florida, has started work on the construction of 980 housing units for the U. S. Air Force near Fairfield, California.

The project consists of 59 one-bedroom multi-family units; 296 two-bedroom multi-family units; 234 three-bedroom multi-family units for officers; 40 one-bedroom duplexes; 192 two-bedroom single units; and 156 three-bedroom single units, and 4 four-room units.

Construction is under the Wherry Act and will represent an expenditure of \$9,000,000.

## Scott Company

HEATING • PLUMBING  
REFRIGERATION



San Francisco  
Oakland  
San Jose  
Los Angeles

## DINWIDDIE CONSTRUCTION COMPANY

•  
**BUILDERS**

•  
CROCKER BUILDING  
SAN FRANCISCO



**HERRICK  
IRON WORKS**  
STRUCTURAL STEEL  
REINFORCING STEEL

18TH AND CAMPBELL STS.  
OAKLAND, CALIF.  
Phone GLencourt 1-1767

Phone GArdfield 1-1144

## Thomas B. Hunter

DESIGNER OF HEATING

AIR CONDITIONING  
VENTILATING AND WIRING  
SYSTEMS, MECHANICAL  
AND ELECTRICAL EQUIP-  
MENT OF BUILDINGS



41 SUTTER STREET  
ROOM 710

San Francisco

California

Fine  
**ENGRAVINGS**  
POOR  
RICHARD  
PHOTO ENGRAVING CO.  
320-324 COMMERCIAL STREET  
SAN FRANCISCO 47



**PITTSBURGH  
TESTING LABORATORY**

**ENGINEERS AND CHEMISTS**

Testing and Inspection of Concrete,  
Steel and Other Structural Materials

Design of Concrete Mixes

Offices in all principal cities

651 Howard St., San Francisco 5  
EXbrook 2-1747

**MATTOCK  
CONSTRUCTION  
COMPANY**

★

**BUILDERS**

★

604 MISSION STREET  
SAN FRANCISCO

Subscribe  
Now —

**ARCHITECT  
and  
ENGINEER**

**\$3.00  
Per Year**

**STOLTE INC.**

**General Contractors**

—:—

**OAKLAND • CALIFORNIA**

**Index to Advertisers**

AMERICAN Perlite Corp.....	44
ANGIER Pacific Corp.....	48
ARCHITECTS Reports .....	25
CLASSIFIED Advertising .....	42
CENTER Stationery .....	47
CLINTON Construction Company...	36
COLUMBIA Steel Co.....	*
CROCKER Bank .....	22
DINWIDDIE Construction Co.....	47
ELECTROMODE .....	43
FULLER, W. P. Co.....	*
FORDERER Cornice Works.....	38
GLADDING McBean & Company.....	*
GREENBERG'S, M. Sons.....	24
HANKS, Inc., Abbott A.....	48
HAWS Drinking Faucet Co.....	28-29
HERRICK Iron Works.....	47
HILLYARD Chemical Co.....	35
HOGAN Lumber Co.....	36
HUNT, Robert W., Company.....	48
HUNTER, Thos. B.....	47
JOHNSON, S. T. Co.....	*
JUDSON, Pacific-Murphy Corp.....	36
KRAFTILE Company .....	28
MARBLE Institute of America .....	*
MATTOCK Construction Co.....	48
MICHEL & Pfeiffer Iron Works.....	2
MONSON Bros.....	45
MULLEN Mfg. Co.....	47
NORTHERN California Electric Bureau .....	33
PACIFIC Clay Products Co.....	*
PACIFIC Coast Gas Association.....	38
PACIFIC Manufacturing Company.....	37
PACIFIC Portland Cement Company.....	Back Cover
PACIFIC Telephone & Telegraph Co.	45
PARKER, Steffens & Pearce.....	38
SOTO, Henry; Landscape.....	48
POOR Richard Engraving Co.....	47
PORCELAIN Enamel Architectural Division, Publicity Bureau.....	32
REMILLARD-Dandini Co.....	48
REPUBLIC Steel Corporation.....	37
SCOTT Co.....	47
SIMONDS Machinery Company.....	37
SISALKRAFT Company .....	36
SMOOT-Holman Company .....	34
SOTO, Henry; Landscape.....	34
STANLEY Works, The.....	*
STOLTE, Inc.....	48
SWINERTON & Walberg Co.....	47
U. S. Bonds.....	Inside Front Cover
UNITED STATES Steel Corp'n.....	*
UTILITY Appliance Corp'n.....	23
VERMONT Marble Company.....	37
WESTERN Asbestos Company.....	*

\*Indicates Alternate Months



**Brownskin**  
**VAPORSEAL**

The resilient building paper creped to S-T-R-E-T-C-H

Quality Products Since 1915

**ANGIER PACIFIC CORPORATION**  
15 NEW MONTGOMERY ST. SAN FRANCISCO 5, CALIF. • 7401 SUNSET BOULEVARD LOS ANGELES 44, CALIF.

A complete line of Angier products available from your building material dealer

**ABBOT A. HANKS, INC.  
Engineers & Chemists**

INSPECTING — TESTING — CONSULTING  
CONCRETE • STEEL • MATERIALS  
CHEMICAL AND TESTING  
LABORATORIES

• RESEARCH AND INVESTIGATION •

TESTS OF STRUCTURAL MATERIALS  
DESIGN OF CONCRETE MIXES  
SHOP AND ERECTION INSPECTION OF  
STRUCTURES AND EQUIPMENT  
INVESTIGATION OF STRUCTURES  
AND MATERIALS  
TESTS AND INVESTIGATION OF  
FOUNDATION SOILS  
FIRE RESISTANCE AND INSULATION  
TESTS

624 Sacramento Street, San Francisco

**ROBERT W. HUNT CO.**

**ENGINEERS**

**INSPECTING TESTING**

**STRUCTURAL MATERIALS  
CONCRETE MIX DESIGN  
CHEMICAL ANALYSIS  
EQUIPMENT**

PRINCIPAL CITIES  
UNITED STATES • EUROPE  
SAN FRANCISCO LOS ANGELES  
PORTLAND SEATTLE

**REMILLARD-DANDINI Co.**

**Brick and  
Masonry Products**

★

400 MONTGOMERY STREET  
SAN FRANCISCO, CALIF.

# ARCHITECT AND ENGINEER

STATLER HOTEL and OFFICE BUILDING — Los Angeles, California

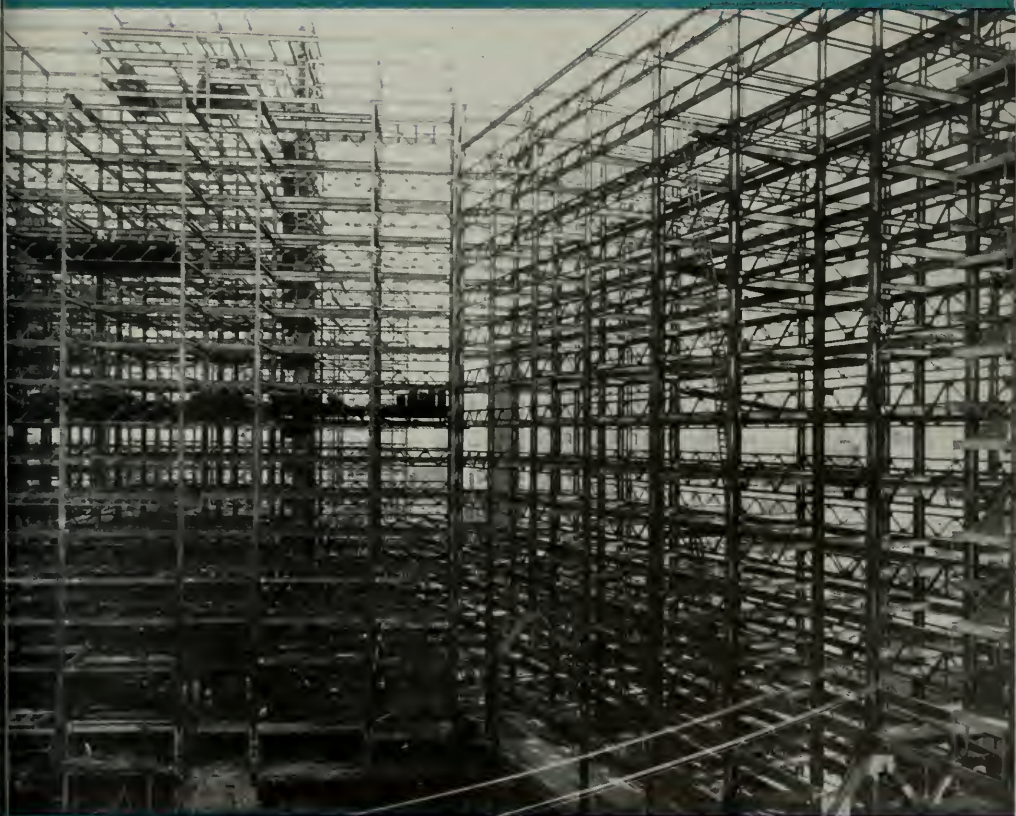

HOLABIRD & ROOT & BURGEE, Architects & Engineers

MAY

1951

**PORCELAIN ENAMEL VENEER PROVIDES...**

- *Absolute design freedom*
- *Speed of construction*
- *Resistance to wear and weather*
- *Fire-safety and fadeless colors*

**Porcelain  
ENAMEL VENEER**



General Contractors: Harry W. Lukens, Los Angeles  
Design by: Architectural Division of the Real Estate Department of Goodyear Tire & Rubber Inc.

Regardless of style or intended use,  
any building, new or old,  
is more attractive, more easily maintained,  
with clean, modern facing of  
Porcelain Enamel Veneer. Write today for details.



*Architectural Division*

Investigate Porcelain Enamel Panels for curtain walls in essential building construction

**PORCELAIN ENAMEL PUBLICITY BUREAU**  
P. O. BOX 186, EAST PASADENA STATION, PASADENA 8, CALIFORNIA  
ROOM 801, FRANKLIN BUILDING, OAKLAND 12, CALIFORNIA



# ARCHITECT

Vol. 185

No. 2

AND

# ENGINEER

ARCHITECTS' REPORTS—Published Daily

## Contents for

# MAY

EDWIN H. WILDER  
Editor

MARK DANIELS, A.I.A.  
Associate Editor

J. WELLS HASTINGS  
Contributing Editor

PROF. LELAND VAUGHAN  
Landscape Architecture

JOHN A. BLUME  
Structural Engineering

MICHAEL GOODMAN  
Planning

JOHN S. BOLLES, A.I.A.  
Book Reviews



### COVER PICTURE

New Staller Hotel and Office Building, Los Angeles, California. Architects and Engineers: Holsbird & Root & Burgee of Chicago, Illinois. Associate Architect: William B. Tabler.

Erection of steel has been completed, representing 7200 tons held together by 200,000 rivets.

Building is 13-stories high, 1275 outside hotel rooms; 150,000 sq. ft. office space; 500 car garage; a complete laundry and 70,000 sq. ft. of shops on three levels.

Is the largest hotel constructed in the United States in last 20-years, and largest construction job on West Coast since the War.

(U. S. Steel photo)

ARCHITECT & ENGINEER

is indexed regularly by

ENGINEERING INDEX, INC.

EDITORIAL NOTES . . . . .	4
JOINT INFORMATION COMMITTEE . . . . .	6
American Institute of Architects & Producers Council	
NEWS & COMMENT ON ART . . . . .	7
SURVEYING EXISTING BUILDINGS FOR SHELTER USES, A PROGRAM IN PORTLAND OREGON . . . . .	9
By R. EVAN KENNEDY, Engineer	
McMURRY FOTO COMPANY, Sacramento, California . . . . .	10
Architect, Gordon Stafford; Contractor, Mackey Construction Company	
WOODSIDE RESIDENCE OF MR. & MRS. KING E. PARKER, Woodside Calif. . . . .	14
Architect, CLARK & BEUTTLER	
INTEGRATED RESEARCH DEVELOPS A NEW BUILDING METHOD San Antonio, Texas . . . . .	16
By Staff Members of Institute of Inventive Research	
LIGHTWEIGHT PUZZOLAN FOR CONSTRUCTION . . . . .	23
By FRANK B. ANDERSON	
A.I.A. ACTIVITIES . . . . .	26
WITH THE ENGINEERS . . . . .	28
PRODUCERS COUNCIL PAGE . . . . .	30
Edited by CARL B. FRANK, Detroit Steel Products.	
BOOK REVIEWS, Pamphlets and Catalogues . . . . .	36
ESTIMATOR'S GUIDE, Building and Construction Materials . . . . .	39
ESTIMATOR'S DIRECTORY, Building and Construction Materials . . . . .	41
BUILDING TRADES WAGE SCALES, Northern, Central & Southern California . . . . .	42
CLASSIFIED ADVERTISING . . . . .	42
CONSTRUCTION CONTRACTS AWARDED, General Data . . . . .	44
IN THE NEWS . . . . .	32-46
INDEX TO ADVERTISERS . . . . .	48

ARCHITECT AND ENGINEER (Established 1905) is published on the 15th of the month by The Architect and Engineer, Inc., 68 Post St., San Francisco 4; Telephone EXbrook 2-7182. President, K. P. Kierulff; Vice-President and Manager, L. B. Penhorwood; Treasurer, E. N. Kierulff.

Los Angeles Office: Wentworth F. Green, 439 So. Western Ave., Los Angeles 5; Telephone DUnkirk 7-8135.

Entered as second class matter, November 2, 1905, at the Post Office in San Francisco, California, under the Act of March 3, 1879. Subscriptions United States and Pan America, \$3.00 a year; \$5.00 two years; foreign countries \$5.00 a year; single copy 50c. ARCHITECTS' REPORTS are published daily from this office, Vernon S. Yallop, Manager, Telephone DOuglax 2-8311.





# EDITORIAL NOTES

## THE ARCHITECT'S TRAINING

The architect is primarily a professional, and undergoes intensive training as well as an "internship" before he is even permitted to take the qualifying examination to obtain a license to do business.

The "examination" is given by the State, and qualifies the architect to "hang out his shingle" as a Registered Architect.

The pre-examination period usually includes about five or six years of advanced scholastic work at a recognized architectural school, and possibly an additional period of internship in the office of a qualified architectural practitioner.

The architect may become, after proper training, a specialist at some particular phase of architectural design, such as industrial, commercial, or residential construction. More often however, he becomes a general practitioner, and is qualified by training and experience to give you invaluable assistance in realizing your construction desires.

\* \* \*

THE nation's prefabricated home manufacturers, who produced 55,000 "ready-made" dwellings in 1950, will double their output in 1951.

\* \* \*

## ECONOMIC PROBLEM OF DEFENSE

So long as the foreign policy of the United States and other free nations must be underwritten with military strength, the economic problem of defense will remain with us.

The economic problem of defense—which differs both from the problem of peace and the problem of war—has three parts:

a) To build up our military strength rapidly to a high level and be prepared to maintain it for a long time if necessary.

b) To promote the continued growth of our productive capacity and its ability to meet greatly increased military requirements.

c) To avoid inflation and preserve the stability of our economy.

The necessary condition for a solution of this problem is that the total demand for goods and services—government, business and consumers' demands—must be held in balance with the available supply of goods and services. Put another way, the non-military demands must be held in balance with the supply of goods and services available for non-military purchase.

If this balance is achieved, the necessary resources will be released for the military programs,

the demands for the remaining non-military supplies will not be so excessive as to cause general increases of prices, and the pressures of organized groups for higher prices or wage rates will be restrained. If this balance is not achieved, the military programs will have to compete with non-military demand, and prices of both military and civilian supplies will increase.

THE 1942 war workers house cost \$6,000—the same house in 1951 will cost \$11,650 . . . same size, same quality.

## NO NEED TO STOP

While many shortages and disruptions are occurring throughout the construction field at this time, it is still possible to plan that new construction and in many instances to even start work and at the same time cooperate in the government's defense efforts.

One of the most satisfactory ways of meeting today's situation is to observe a number of factors well in advance of the time you contemplate the start of actual construction. In this manner you can meet many of the conditions of governmental bureaus and agencies which require time in determining compliance with innumerable "rules, regulations and directives."

Among the items that should be given advance thought are 1) Make your financing arrangements well in advance. Banks and building and loan associations can be of considerable assistance to you as they are well versed in credit restrictions and availability of construction funds; 2) Give your General Contractor plenty of time to review plans and specifications. He may need a few weeks' more leeway than in normal years to assure ample materials and labor supply; 3) Confer with your General Contractor immediately on available subcontractors and their ability to perform work without dangers of delay for lack of materials or fixtures. Make color and style selections in plumbing, tile, bath and kitchen fixtures and furnishings, and have orders placed with material dealers and manufacturers at once.

4) It is well to be prepared to accept different models and colors and to substitute some equipment if necessary; 5) Don't, however, be panicked into accepting shoddy substitutes. Barring an all-out war, producers of quality materials should be producing a sufficient quantity to meet actual needs; 6) and in the probability of paramount importance DON'T BUY IN THE BLACK MARKET.

# How Colorful Clay Brick *Enhances* School Architecture

An excellent example of modern school architecture utilizing Clay Brick is the Antioch, California High School. Ernest J. Kump, A. I. A., Architect. Wallace D. Harkins, Contractor.

Clay Brick's color and texture give this classroom warmth and interest.



PHOTOS BY ROGER STURTEVANT



*Inside or Outside*  
**A CLAY BRICK WALL  
BEST FINISH OF ALL**

**WARM, FRIENDLY COLOR**—Clay Brick's built-in color and texture make it a top choice in building materials wherever economy and beauty must be combined.

**MAINTENANCE COST... ZERO**—Clay Brick walls never need painting or refinishing. Unlike most materials that need periodic refurbishing, Clay Brick's texture and color become more appealing with the years.

**IMMUNITY TO VANDALISM**—Clay Brick walls have a rugged surface that even school children, careless and rough as they are, find difficult to mar.

**FLEXIBILITY**—Clay Brick's small modular scale makes it easy to combine effectively with other construction materials.

## **CLAY BRICK & TILE ASSOCIATION**

OF NORTHERN CALIFORNIA

55 NEW MONTGOMERY STREET • SAN FRANCISCO

Krafftile Company  
Remillard Dandini

L. P. McNear Brick Co.  
San Jose Brick & Tile  
United Materials & Richmond Brick Company

Port Costa Brick Works  
Stockton Brick & Tile Co.

# JOINT INFORMATION COMMITTEE

AMERICAN INSTITUTE OF ARCHITECTS and THE PRODUCERS COUNCIL, INC.

The American Institute of Architects in Washington, D. C., through The Department of Education and Research, Committee on Expansion of Research Facilities, is submitting to AIA members throughout the nation a questionnaire containing ten items pertaining to a Basic System for Specifications and Manufacturers Literature.

The questionnaire is the result of action stimulated by the Joint Information Committee representing members of the Northern California Chapter of the AIA and the Northern California Chapter of the Producers Council, Inc., to bring up to date a simplified method of preparing specifications for construction and a complete review of information, detailed and scientific, describing building materials, products, and equipment for submission to the architectural profession.

F. Bourn Hayne, San Francisco architect who has pioneered this movement and developed a preliminary "System for Better Specifications and Manufacturers Literature" in an effort to solve many of the perplexities now existent in the relationships between the manufacturer and distributor of building materials and equipment and the architect; stresses the point that any plan to moderate the present situation should embody at least the three following points:

First. Basic information cards, and literature, should be of a uniform, standard size for ease and convenience in classifying and filing.

Second. The already existing 41-divisions of the AIA Standard Filing System should adopt new methods of preparing and presenting their information to architects in keeping with changing conditions in the construction industry. An effort should be made to keep the architect well informed on new methods, new products, and new applications.

Three. A Board of Review should be established as a part of the Educational Program of the AIA for the purpose of considering all problems arising among manufacturers, distributors,

trade associations and the architects relating to specifications and manufacturers literature.

"By establishing such a logical and simple system will first of all give a good and needed reason for architects to join The American Institute of Architects.

"Secondly it will give any manufacturer a reason for belonging to and backing up their various trade associations.

"By starting with the associations and larger manufacturing firms in this way, the AIA will be relieved of a tremendous load in its initial task of making up a set of good specifications cards and materials data. Perhaps, in many cases this properly edited material and specifications of the associations will be all that is needed for a basic AIA cards and brochures program.

"Cost of such a program," Hayne pointed out, "will be supplied by those who submit their material for editing and review by the AIA Board of Review. As a program of this character has for its main objective the simplicity of standardization and uniformity of application, it will, if carried out at the top level benefit contractors, engineers, estimators, manufacturers, and architects."

It has been pointed out that the program suggested by the Joint Information Committee, AIA and Producers Council, is not designed nor intended to supplement that activity already being engaged in by the Department of Education and Research of the AIA, but is a grass-roots study of the present day situation and could become a part of the national program.

That the national program is quite active is evidenced by the fact that a jury representing leading architects of the AIA throughout the nation commended some thirty-two building product manufacturers and trade associations at The American Institute of Architects annual convention in Chicago last month for their excellence in preparing and presenting technical and promotional literature as a guide to the architectural profession.

*NOTE: This news space is being contributed by ARCHITECT & ENGINEER Magazine to the JOINT INFORMATION COMMITTEE representing the Northern California Chapter of The American Institute of Architects and the Northern California Chapter of the Producer's Council, Inc., and is available to this Committee for the purpose of bringing to the attention of leaders within the Construction Industry various phases of the Architectural profession and building materials industry procedures for general consideration and comment. Your "ideas" and any suggestions for the better pooling of thoughts along these lines should be sent to Joint Information Committee, c/o The Architect & Engineer, 68 Post Street, San Francisco, where they will be immediately forwarded to the proper committee members.*

# NEWS AND COMMENT ON ART

## PORTLAND ART MUSEUM

Thomas C. Colt, Jr., director of the Portland Art Museum, West Park and Madison, has arranged the following exhibits and events for the month of May:

Artists of Oregon, 1951. This annual event has been prepared and selected by a committee comprising Alexander Archipenko, noted sculptor at the University of Washington; Sherman Lee, assistant director of the Seattle Art Museum, and David McCosh, Associate Professor in the School of Architecture and Allied Arts at the University of Oregon.

The spring film series will feature the work of Erven Jourdan, formerly of Portland, whose documentary film entitled *Architecture West* deals with buildings by Pietro Belluschi and John Yeon. Another film will deal with *Factory Sequence* and two other showings will highlight "A Child's World," and Frank Lloyd Wright's *California Houses*.

Summer Sessions at the Museum will open June 18 and continue for six weeks. Classes offered are Ceramics, Hal Riegger; Painting, Lucia Wiley; Lettering and Calligraphy, Arnold Bank.

## M. H. deYOUNG MEMORIAL MUSEUM

The M. H. deYoung Memorial Museum in Golden Gate Park, San Francisco, is offering a number of special exhibitions from its permanent exhibitions in fine and applied arts.

## INSTITUTE OF INTERNATIONAL EDUCATION AND ART AWARDS

Talented young American artists will once again have the opportunity to study abroad on U. S. Government grants, the Department of State recently announced in Washington. Awards for the 1952-53 academic year will be made to graduate

## SAN FRANCISCO MUSEUM OF ART

*Andean Landscape, 1941. Oil by Hector Poleo, Venezuelan. A landscape depicting the Andean highlands. From the Latin American Collection of the San Francisco Museum of Art.*





students with records of accomplishment in the fields of painting, sculpture, architecture, art history and the industrial art field.

Applicants must be citizens of the United States and must have adequate knowledge of the language of the country in which they wish to study. Applications may be made to the Institute of International Education, Two West 45th Street, New York.

### **SAN FRANCISCO MUSEUM OF ART**

The San Francisco Museum of Art, War Memorial Building, Civic Center, will feature the following exhibitions and events for May:

**EXHIBITIONS:** Architecture of Bernard Maybeck; Photographs by Imogen Cunningham; Phelan Awards Competition in Graphic Arts; Pottery of Bernard Leach; Derivations from Color Photographs; Development of Painting; A Studio Residence by Hillmer; and an Exhibit by Arshile Gorky.

**SPECIAL EVENTS:** A demonstration of "Do's and Don'ts of Flower Arranging" by Helen Van Cleave Park; Concerts featuring the Barati Chamber Orchestra Society; Bernard Abramowitz, Pianist; Cineconcert by Althya Youngman; Murray Graitzer, Flutist; Frances Wiener, Violinist and Lev Shorr, Pianist; and the Composers' Forum.

The lecture series will continue on Sundays at 3:15 and on Wednesday evenings at 8:15. The lectures on Modern Art will continue on Monday evenings at 8 p.m. The Children's Saturday morning art classes, 10 to 11 a.m.

### **CITY OF PARIS**

The Rotunda Art Gallery of the City of Paris, San Francisco, will show the 10th Annual Pacific Coast Ceramic Exhibition and sale of Pottery and Sculpture during May and until June 16, according to an announcement by Beatrice Judd Ryan, curator.

The Jury of Award comprises Whitney Atchley, Mary Erckenbrack, James Vovera, Richard Pettersen, Zygmund Sazevich, Laura Andreson and Beatrice Judd Ryan.

The Pictures of the Month will feature a display of Watercolors by Mary Elizabeth Lyman.

### **ART GROUP OFFER A SERIES OF TV PROGRAMS**

The San Francisco Museum of Art has inaugurated a bi-monthly television program called "Art in Your Life" over Station KRON—Channel 4.

Allon Schoener, of the Museum staff is directing the programs. Associated with him in the venture are Frank Stauffacher, director of the Museum's

"Art in Cinema" series, and Robert Katz, an instructor at the California School of Fine Arts.

It is believed that this is the first time any Art program has been TV'd on a regular schedule.

### **SAN FRANCISCO ART ASSOCIATION**

The annual exhibition of works of the California School of Fine Arts Faculty is currently on exhibit at the M. H. deYoung Memorial Museum. Some twenty-five artists have work on display, forming one of the more interesting exhibits being shown.

### **EXHIBIT OF AMERICAN DESIGNS TO BE SHOWN AT MILAN, ITALY**

The Society of Industrial Designers, New York City, has shipped to Milan, Italy, an exhibit of current American Designs, which will be placed on view at the "Nona Triennale di Milano," a triennial exhibition of art, manufacturing, and architecture.

The exhibit consists of seventy photographs of recently designed American products, transportation equipment, and commercial buildings, representing all parts of the nation.

### **ARCHITECTS NEWLY LICENSED IN CALIFORNIA**

The Division of Architecture, Department of Professional and Vocational Standards, State of California, has released a list of names of applicants who have been granted license to practice architecture.

Among those granted licenses are: Horace G. Barnard, Jr., William E. Brown, Rolland E. Cooper, Harvey R. Harwood, Carroll S. Rankin, and Charles F. Swift of Los Angeles; James F. Bernard, Walter H. Costa, Evelyn H. Gilcrest, Ted R. Moulton and Omar B. Nehls of Berkeley; Walter L. Bogart, Jr., and Samuel Postil, Burbank; Paul F. Bogen, and R. Stuart Johnston, Sonoma.

L. F. J. Centurion, Temple Dick, Robert P. Tobin, and Daniel W. B. Warner, San Francisco; Charles W. Dennis, Concord; William B. DuBois, Alan E. Morgan, and Frederic S. Schachtman, Oakland; Jack A. Edson, San Mateo; Alfred M. Fisher, Joseph J. Jozens, and Hugh K. Phares, Jr., Sacramento.

David F. Potter, and Walter L. Keller, Menlo Park; Kenneth K. Kaestner, Visalia; Ralph B. Priestley, San Luis Obispo; George F. Rhoda, Monterey; H. Steve Sander, and S. David Underwood, La Crescenta; John M. Scheideman, and Harry R. Wilson, Van Nuys; Carl Schwarz, and Joe L. Stetman, Pasadena; Vernon Tree, Long Beach; and Robert A. Kennard, Fort Lee, Virginia.

Richard R. Griffiths, San Rafael; Donald F. Haines, Redwood City; Ward R. Helman, West Covina; and Edward B. Hendricks of Riverside.

## A PROGRAM

# SURVEYING EXISTING BUILDINGS FOR SHELTER

## CIVIL DEFENSE ACTIVITY IN PORTLAND, OREGON

By **R. EVAN KENNEDY,**

**President, Structural Association of Oregon,  
Chief Engineer, Barrett & Logan Architects**

More than 40 per cent of the population of the metropolitan city of Portland, Oregon can be accommodated in "sheltered areas" in case of an air raid. This was brought out by a recent survey of the major buildings of the city, a structural study made by the architects and engineers of the area.

Last November Mayor Dorothy M. Lee asked for Professional Engineers of Oregon to study the major buildings of the city to determine the possibility of using parts of some as air raid shelters. John Corenbaum, President of the Professional Engineers, asked the writer to form a committee to examine the matter, and to take such steps as necessary to carry out a study of the shelter problem. A committee was set up consisting of representatives of the Oregon Chapter of the American Institute of Architects, the Oregon Section of the American Society of Civil Engineers, the Structural Engineers Association of Oregon, the Oregon Chapter of the American Society of Heating and Ventilating Engineers, the city Building Department and the city Civil Defense department.

Preliminary committee discussions and investigation soon established the fact that no part of any existing structure in the city could be deemed safe enough to be termed a bomb shelter in the sense that great numbers of people should be directed to it for protection. It was pointed out, however, that many buildings do have areas within that are more tenable in case of an attack than other areas would be, and that the casualty rate could be reduced if such areas were used for shelters. It was

therefore decided to set up a program that would produce a designation of an area or areas within existing structures in which area it is felt an occupant has a greater chance of survival than he would have if outside that area. It is in such areas that sufficient room has been found for about 223,000 people to occupy, based on an occupancy of 4 square feet per person.

The first thing done by the committee was to produce a means of evaluating the structures to determine their probable weak points and strong points for the use intended. It was desired to develop a means that would produce more or less consistent results when used by various individuals. The result was a check or evaluation sheet\* on which are listed the most important items a shelter should have such as proper water facilities. With this form, designed to be used with and to augment it, was developed an instruction or discussion sheet which went over the problem at hand and pointed out the basic features a good shelter should have. The check sheet was cross ruled on the back for use in sketching out areas selected as shelter areas. The final use of the check sheet is as a record of the structural features of the building, a record of the area or areas within, if any, which are thought to be the most likely to suffer the least, and a record of the deficiencies

*\*NOTE: Copies of this form may be obtained by writing to R. Evan Kennedy, Chief Engineer, Barrett and Logan Architects, Portland, Oregon.*

(See Page 24)



# McCURRY FOTO COMPANY

Sacramento, California

ARCHITECT: GORDON STAFFORD

CONTRACTOR: MACKAY CONSTRUCTION CO.

Still pioneering in the modern sense after 44 years of steady expansion, the McCurry Foto Company, one of Sacramento's oldest business firms, opened its all-new, all-modern photo equipment and camera store recently.

The new building is located in downtown Sacramento at the corner of 8th and Eye streets and represents a concrete structure modern in both design and functional arrangement with the architect, Gordon Stafford, planning a particular need throughout for various departments and technical facilities.

From the street level, the main entrance opens onto a spacious sales floor, while at the rear of the building, entrances open onto both the street level and the ground floor.

The building provides 11,200 sq. ft. of working area. All of this space is utilized with maximum efficiency, yet in every department there is a feeling of generous space.

#### Exterior

The front of the building extends 80 ft. along Eye street, and the side, 70 ft. along 8th street. A 60 x 80 ft. parking lot adjoins the building at the rear. This parking lot is owned and operated by the firm for the convenience of its customers who can enjoy free parking while shopping in the photographic store.

The exterior finish of the building is green plaster, which affords a complementary contrasting color for the attractive Roman brick trim.

Plate glass extends from floor to ceiling across

Interior design  
of motion  
picture  
department



the entire front of the building, forming a continuous show window almost 80 ft. in length. Beneath this enormous window is a Roman brick plant box, and above is a wide marquee which provides shade in the summer and can be brilliantly illuminated at night.

This marquee gives way over the main entrance to a vertical wall surface which forms a py-

lon where an 18 ft. baked enamel two-tube neon sign is mounted. This sign is the well known McCurry trade-mark. Another smaller neon sign is affixed to the West end of the marquee for traffic approaching from the West. The show-window effect is carried out on the 8th street side by four large, separate windows.

Two Roman brick columns, with the face brick



Professional  
department  
for display  
of cameras,  
equipment and  
supplies.



## MCCURRY FOTO'S . . .

laid in stack bond, create an impressive front entrance. These brick columns form both the interior and exterior faces of the entrance wall, through which customers enter the store by means of solid glass double doors. The rear of the building is fitted with a large sliding door for the receiving department, a special port for shipping and delivery, and a door from the parking lot for the convenience of customers.

### Main Floor

The huge sales floor, surfaced with maroon asphalt tile, is 80 ft. long and 40 ft. wide. It is extremely well illuminated with 40 300 watt recessed incandescent lights. Abundant natural light is provided by the plate glass front of the building, the four windows on the 8th street side, and by a strip of clear-story windows on the north wall, just below the high, sloping ceiling.

The interior is finished throughout in white California stucco, trimmed in green and tan, with clear, straight-grained white oak woodwork and showcases. The showcases, 58 in all, are specially designed with the counter cases devoted half to display space and half to storage space, with drawers throughout of different sizes to accommodate various types of merchandise. The wall cases, equipped with recessed lights, have storage bins underneath. In the movie department, the wall cases are fitted with sliding panels opening into the projection room to permit selection

of merchandise from either the sales floor or the projection room.

Inside the showcases, merchandise is displayed on an ornamental maroon covering to match the floor. Electric outlets are provided in each case to facilitate the demonstration of equipment.

Four wrapping benches, topped with maroon linoleum, are conveniently located throughout the store. Each is equipped with a telephone, intercom, electrical outlet, and a complete stock of supplies, including wrapping paper, paper bags, scotch and paper tape dispensers, order forms, want order books, and many other items for the customers convenience.

### Equipment

Large equipment, such as enlargers, printers, washers and dryers are displayed in specially designed cabinets, as are accessories. A film cabinet, designed to permit loading at the top, dispenses film at the bottom. Island cases feature glass construction at eye level, on both sides and the top, to permit an unobstructed view throughout the store.

The photo finishing benches are topped with glass under which sample prints are attractively displayed. Drawers accommodate finishing work. A chute is provided in one of the brick columns at the front of the building to accommodate customers who wish to leave photo finishing work or return rental films when the store is closed.



### Business Offices

Sales Offices  
are at left:  
Administrative  
Offices are at  
right.

All rental films are stored in special racks. The rental counter, covered with linoleum and equipped with a pass-through, is designed for storage of rental films and equipment after these items are returned and before they are checked. A specially built bench behind the rental counter contains power rewinds for checking films and rental records.

Moulding samples are displayed in one wall case, while another includes a built-in unit, with swinging panels to take care of the display of photographic mounts.

### Departments

The Professional Department is so arranged that all supplies are stored directly behind the department and are easily accessible to the salesmen.

Shelves are conveniently located to accommodate special orders, and two dutch doors, both equipped with buzzers, connect the store and the stock room. For the convenience of waiting customers, posture chairs and tables have been provided.

Along one wall is a panel for display of 16" x 20" mounts. It is available for salon print exhibits and by camera clubs.

The Commercial Department occupies the largest part of the ground floor. It comprises the main work room, work equipment, and desks for the manager of operations and for the manager of the Commercial Department and a receptionist. A special room is used exclusively for the storage and mixing of chemicals. There are two developing rooms, where the drying cabinet is located above the wash tanks. More than 200,000 negatives are on file in this department in special filing cabinets.

The enlarging room is equipped to make large murals, with the enlarger operating on a track set in the concrete floor. There are two printing rooms and both have lightproof pass-throughs to the washer. The copy room is equipped with a copy camera mounted on a track set in the concrete floor, and the room is fitted with specially adapted lighting units.

The Commercial Department is 20 x 40 ft., with white plaster walls. Lockers have been provided for each commercial photographer. When ready to go out on a job, the photographers use a dumb waiter to transport their equipment outside the building, where the company's commercial vehicles are parked.

The building is equipped with a Photo Finishing and a Framing Department, both of which are individual, yet a unified, operation. The Photo Finishing Department comprises three main rooms all equipped with latest equipment. The Framing Department contains all tools necessary for making frames and space has been provided for

equipment used in the routine maintenance of the building.

### Interior

The entire sales floor, business offices, and stock rooms can be surveyed from the glass enclosed, centrally located manager's office which is elevated above the main floor level for privacy. This office is handsomely paneled from floor to ceiling in clear, straight grained white oak. The ceiling is soundproof acoustical tile, and the floor is covered with a wall-to-wall maroon carpet that harmonizes with pastel drapes.

The business office is divided into two parts—general and sales. At the rear of this section is a bulletin board and coatroom for employees' use. A 25 ft. counter, topped with linoleum, extends the full length of the general office. At the front is the telephone switchboard, with five trunk lines and 20 extensions. The bookkeeping and credit departments are equipped with newest machines and devices. This section of the building is illuminated with slim-line fluorescent lighting fixtures.

A stock room is located at the rear of the sales floor, and a dumb waiter connects the sales floor and the service department. Special shelving has been used to provide for the storage of all types and sizes of equipment.

### Ground Floor

A paneled oak staircase connects the main floor and the lower, or ground floor. At the bottom of the stairway is a comfortably furnished waiting room, equipped with a refrigerated drinking fountain.

Adjoining this is a recreation room for the use of the employees, equipped with lounge furniture, refrigerator, hot plate, kitchen sink, and candy and soft drink dispensers.

The main section of the lower floor accommodates the Commercial department, Photo-finishing department, Service department and the Framing Department, all opening into the central area.

The lower floor is finished in white California stucco, trimmed in grey.

A central heating plant and air conditioning system is situated on this floor, providing excellent independent ventilation for each room.

Carefully thought out details of the finishing include alkali-resistant grey paint and weather-stripping in the darkrooms, lead-lined sinks, water drains in the floor, and waterproof cement plaster extending six feet up the walls.

A special safety feature of all darkrooms is a light switch at the entrance door which turns on the safe light only, to prevent accidental fogging of paper. The white light switch is situated opposite the entrance. All electric outlets on the ground floor are three-way units, with one ground wire for safety.



*Photo by Jon Wells*

# WOODSIDE RESIDENCE OF MR. and MRS. KING E. PARKER

Woodside, California

LOT AREA—4 ACRES

ARCHITECT—CLARK & BEUTLER

**EXTERIOR:**

Long overhanging eaves serve as protection to walks along the side of the house and to the exterior walls which are of brick.

Steel sash has been used in all window and door spaces.

Drive-in area is paved, with approach to the garage at a slightly lower level than balance of the house.

**ROOF:** In complete harmony with the adjacent wooded areas, the roof is constructed of substantial Cedar Shakes.

**HEATING:** Panel heating is used throughout the house. Tubing being spaced about 1-foot apart in the floors, and in the larger rooms additional tubing has been installed in the walls. A large central unit furnishes the hot water.

**FLOORS:** Basic floors are of concrete, covered with a well seasoned Oak in the living and dining rooms. Bedroom floors are carpeted, and composition coverings in the kitchen and other utility spaces.

**LANDSCAPE:** The entire area surrounding the home has been beautifully landscaped, adding to the pleasure of the site, and contributing much to the popularity of "out-door-living".



**LIVING ROOM**

Showing the exposed overhead beams and arrangement of large window overlooking adjacent hills

Fire place adds to the livability of the home.



# INTEGRATED RESEARCH DEVELOPS A NEW BUILDING METHOD

By Staff Members of the Institute of Inventive Research  
San Antonio, Texas

How integrated scientific research, properly directed and conducted by experienced technologists teaming with specialists, can produce new products or processes soundly and economically is demonstrated in the development of a new building method which has captured the imagination of progressive members of the building industry.

The Youtz-Slick Lift Slab Building Method, also known as the "raised-slab" method of construction, has moved a number of contractors, architects and engineers to term it "revolutionary," "cost-saving," and "the first great forward step in the building industry in half a century."

The Institute of Inventive Research, which developed the method over a three-year period of rigorous research and testing on its own laboratory grounds, has proven its possibilities in cost savings and improved working conditions.

The Institute is one of three nonprofit scientific research organizations established on Essar Ranch near San Antonio. The others are Southwest Research Institute and the Foundation of Applied Research. With the assistance of the former, the Institute of Inventive Research aids inventors in developing what it believes may be worthwhile inventions, and assists manufacturers to expand their production by supplying them with new devices, machines and processes through license arrangement.

## Construction Technology

Besides the Youtz-Slick Method, the Institute has developed the widely known Poulter Seismic Method, a more economical process for oil exploration; the McFarland Spray Gun, an improved agricultural tool; the Bassinger Drill Bit, a new oil-well drilling device, and other useful machines and processes.

Development of the Youtz-Slick Lift Slab Building Method came about through submission of an invention the Institute evaluation panel believed had merit. The affiliated Southwest Research Institute operates a division of Housing and Construction Technology which supplies manufacturers of building components with laboratory research work to improve their products and integrate them into completed buildings and houses. The two institutions thus formed an ideal combination to undertake the project.

Southwest's staff has repeatedly pointed out that economies in construction can be achieved only through cooperative effort on the parts of builders, architects, research institutes, manufacturers, financing agencies and code authorities working together and pooling their skills and experience.

## Integrated Research

Development of the Youtz-Slick Building Method is an example of cooperation by various elements under the direction of the Institute of Inventive Re-

William J. Lance

C. W. Smith

Robinson Brown

Judson Swearingen

Harold Vogtborg



See Page 22 for details of above personnel.

search and Southwest Research Institute, the latter of which performed much of the technical work involved. The new method is a case history of an integrated research and development program in a coordinated attack on one typical problem of the construction business.

Ever since reinforced concrete became widely used as a structural material, columns, beams, and floors have been constructed by placing the reinforcing and pouring the concrete into forms which were built as molds of the finished structure. Such molds or forms are expensive. They have been made of modular material or wood units or, more frequently, have been constructed of standard lumber, cut and fitted piece by piece. In any event, such forms had to be built, leveled, plumbed, squared, braced and shored into position with a supporting labyrinth of under-pinning strong enough to support the plastic concrete construction until it had set.

### **Costly Process**

Since such molds or forms must be separately built for each floor or roof, all of the form materials must be elevated and erected in a hazardous location at considerable expense. The reinforcing steel, electrical conduit and sleeves for plumbing, and sheet metal work must be elevated and installed in the floors by hand under expensive and hazardous conditions and the wet concrete raised in small batches to be poured into the forms.

When the concrete has set, the forms or molds must all be removed by expensive hand labor. Attempts to salvage and re-use forms on upper floors is in itself a costly process. A source of even greater expense is the fact that conventional concrete forms or molds are almost never built accurately or placed true because they are erected by hand labor and by "rough" carpenters. Expensive cutting, fitting and patching is almost always required on the part of other trades because the basic concrete form is seldom, if ever, accurate.

### **Independent Invention**

Pondering over these difficulties resulting in expensive methods used for reinforcing concrete structures, two inventors, unknown to each other, independently conceived a technique which might simplify such a process. Tom Slick, San Antonio oil producer and rancher, and Philip N. Youtz, New York architect, almost simultaneously initiated experiments with upper floor and roof slabs poured on the ground and raised into permanent positions after the concrete had set and attained a reasonable strength.

Although both inventors projected initial experiments separately it was soon apparent that considerable research and development work would be required to perfect the technique and solve a variety of problems in such an unorthodox process before it could be used advantageously in the erection of buildings in the field. The interests of

**Partial view of finished Trinity University Administration Building.**



## INTEGRATED RESEARCH . . .

Messrs. Slick and Youtz were joined in submitting the problem to the Institute of Inventive Research for development, perfecting, patenting and licensing to the construction industry.

### Coordinated Development

Under the direction and coordination of Mr. William J. Lance of the Institute of Inventive Research, development work was started on the Youtz-Slick technique in the summer of 1948.

Southwest Research Institute was assigned a large portion of the technological work which

divided itself principally into two problems: 1) Discovery of an efficient and economical material to use as a separator between the slabs as they are formed on the ground in a sandwich, and 2) efficient and economical equipment for use in lifting upper floor and roof slabs into position and building coordinating controls for this equipment to assure an equal rate of travel at each column to eliminate undesirable stresses resulting from uneven lifting.

### Chemical Engineering Research

Southwest Research Institute's Department of Chemical Engineering, under the direction of Dr. Judson Swearingen, Chairman, conducted experiments with a wide variety of possible separating materials to determine their suitability. General requirements were: 1) Minimum bonding between concrete faces; 2) a ceiling texture suitable for application of tile or paint; 3) minimum cost and 4) ease of application and removal.

A number of liquid spray solutions were evaluated as separating compounds, including wax, paraffin and soluble oil emulsions, as well as plastic films. In the last analysis it was found that plastic treated sheets of fabric were more effective. They produced absolutely no bond between the concrete layers, the texture of the slabs was satisfactory, such sheets were easy to apply and remove and, although the first cost was considerably

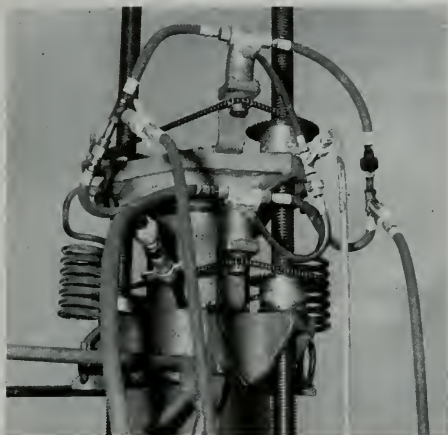

◀ Hydraulic Lifting Unit atop steel column.



Laying steel for second floor concrete slab on Trinity University Administration Building in San Antonio.

higher, re-use of the sheet material provided economies on any sizable operation.

**Engineering Mechanics Research**

Working on lifting devices and their control was carried on under Mr. Robinson Brown, Supervisor of Engineering Design in Southwest's Department of Engineering Mechanics.

This method, as it concerned the lifting operation, consisted of pouring a ground slab and then, using it as a form, pouring a roof slab or a number of upper floor and roof slabs directly on the ground slab. When these slabs above the ground have set up to strength, they are raised on the building columns to their permanent positions and made secure.

**Lifting Problem Specifications**

In an effort to reach a successful solution to the lifting problem, an ideal set of specifications on equipment was written by the Department of Engineering Design which then considered all lifting methods against these specifications which are here set forth:

- 1) Lifting load would be concentric on columns.
- 2) Equipment should be suited to any column design.
- 3) Slab must stack.
- 4) Two safety control members at each station, either of which will carry the load.
- 5) Lifting and follow-up safety controls at or below eye level when standing on roof slab.

- 6) Follow-up means kept tight to snub load at all times.
- 7) Metered increments at each station coordinated between stations.
- 8) Ability to lift roof slab and one or more lower slabs with same set of equipment.
- 9) Simple, and as near foolproof as possible, means of indicating off level or automatic leveling controls.
- 10) All lifting elements to be stopped in case of failure of any one to lift.
- 11) Ability to raise slab flush with top of columns.



**Ken Hewitt, SRI engineer at control for lifting concrete slabs.** ▶

**Trinity University Construction showing lifting slabs in background for roof and second floor. Note control panel on top of roof slab in center.**

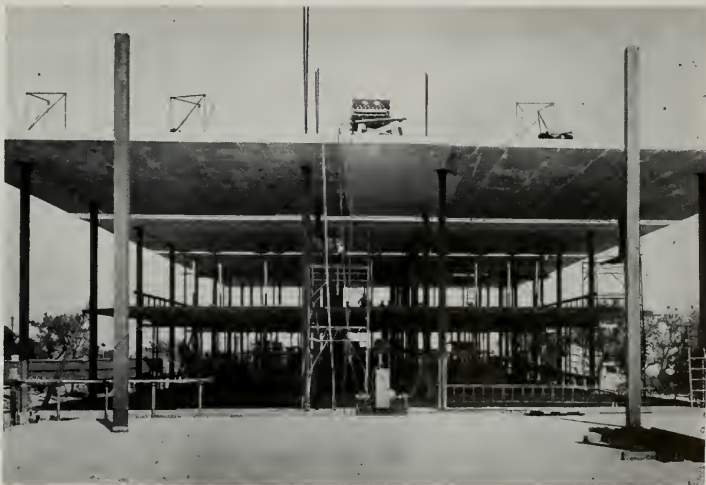



## INTEGRATED RESEARCH . . .

- 12) Equipment must be capable of operating through a wide variation of weather conditions and in the presence of dust and dirt.
- 13) Equipment must be easy to set up, break down, and transport.
- 14) Heavy equipment must be designed to lift 160,000 pounds per station.

The fields of investigation included:

- 1) Mechanics.
- 2) Hydraulics.
- 3) Instrumentation.
- 4) Electric control systems.
- 5) Servo mechanisms.

The following methods were analyzed:

- 1) Continuous hydraulic with mechanical follow-up safety controls.
- 2) Intermittent hydraulic with mechanical follow-up safety controls.
- 3) Mechanical lifting and follow-up, powered by hydraulic motor.
- 4) Mechanical lifting and follow-up, powered by hydraulic jack.
- 5) Mechanical lifting powered by electric motor drive.
- 6) Low pressure pneumatic lifting.

Of the many methods analyzed it was decided that, considering the heavy loads involved, the safest type of equipment was that of intermittent hydraulic with mechanical follow-up safety controls needing lightweight, high-strength equipment such as is used in some phases of aeronautics.

The Institute engaged the Gassner Aircraft Engineering Company as consultants and collabo-

rated with the engineering company's staff on some aspects in working out the engineering design problems.

### Structural Engineering

Coincidental with the laboratory projects, work was started in the field of structural design. The Institute was particularly fortunate in securing the consulting services of Mr. Fred N. Severud, of New York, who is outstanding in the field of structural engineering and reinforced concrete design and who contributed much in the way of advice and helpful counsel to the project.

Nobody knew the amount of adhesion which might exist between slabs poured in a sandwich and nobody knew how much lifting power might be required to separate such slabs over and above the power necessary to lift a slab once it was in the air. No one could be certain that slabs poured on the ground could be lifted without cracking. As a matter of fact, there was little or no applicable experience or design criteria available.

### Experimental Slabs Built

An experimental slab was called for to find out what some of the problems would be. The first slab was formed with pan construction. It was 42 by 50 feet in size, and collars were placed in the slab around tubular columns. The columns were set in footings under the base or floor slab. Nine columns were used to support this slab and these were spaced at 18-foot intervals, eight of them around the perimeter and one inside the slab area. After the concrete had set for ten days, hand winches were placed on top of the roof slab and

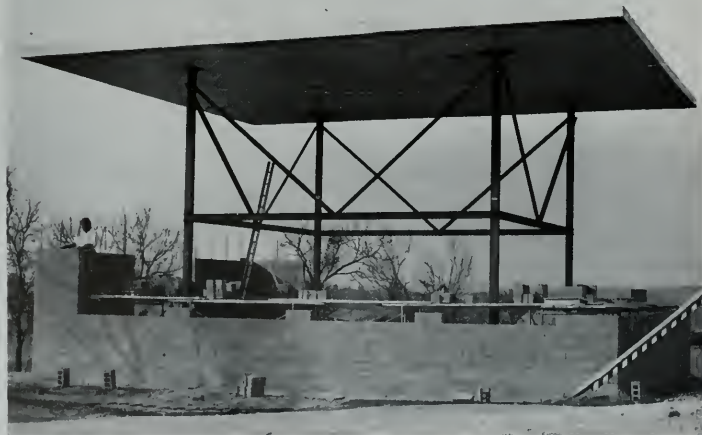

Second experimental slab constructed on ground by the Institute of Inventive Research. This slab used a period of more than two years to test improved lifting equipment, finally was utilized as a test laboratory for the Engineering Mechanics Department of Southwest Research Institute.

cables attached to the tops of the columns. Nine men operating winches coordinated their efforts as best they could and had no difficulty in separating slabs or in lifting the roof into position where the collars were welded to the columns as a permanent support.

**It should be emphasized that work on the experimental slab, laboratory exploration of separating materials, engineering design on mechanical lifting devices and structural design work all proceeded simultaneously and were coordinated to obtain the most valuable results and design data in the most economical manner possible.**

#### Technique Found Practical

It was now apparent that the technique was practical from a mechanical and physical standpoint, and the next problem was to pool the knowledge gained and simplify the procedure so that an appraisal could be made of the economic factors and any design advantages which might appear.

While the engineers continued to perfect the lifting mechanism, the structural designers evolved a flat slab with no joists, beams or pans and eliminated the need for perimeter columns by designing the slab to cantilever out from interior columns. At the same time Mr. Lance projected cost estimates, worried over problems of franchise to the industry, rental and transportation of jacks and other essential details concerned with the practical application of such a new technique in the field.

#### Trinity University Construction

During this period the Institute was approached by interested groups despite the fact that premature use of the method was discouraged pending perfection of the techniques and the obtaining of accurate cost data. Trinity University of San Antonio, for example, planned an entire new campus with structures of contemporary design and insisted on a chance to consider using the Youtz-Slick technique.

The University had obtained a top-flight group of architects to design its new buildings. This group included Bartlett Cocke, Harvey P. Smith and O'Neil Ford of San Antonio, and it benefited by the close association and helpful assistance of William W. Wurster as consultant. The architects for Trinity University looked over the first experimental slab and the new cantilever flat slab design, and were impressed with the possibilities.

#### Second Experimental Slab

A second experimental slab structure was set up at the Institute and the latest refinements in structural design, in separators, and in synchronized hydraulic lifting equipment were thoroughly tested and found to be eminently satisfactory.

As finally developed, the equipment consisted of a single hydraulic cylinder mounted on a casting which rested on top of each column. The piston of the cylinder carried a short beam which traveled with the piston through a limited two-inch stroke. Two 4-thread Acme screws extended from

**Physics building at Southwest Research Institute which has as its roof the first experimental concrete slab erected on the grounds of the Institute of Inventive Research's laboratories. This initial roof slab was used to test manually operated mechanical roof lifting units. Upon conclusion of such tests, non-load bearing walls were erected and the structure now serves as an experimental physics laboratory.**



## INTEGRATED RESEARCH . . .

the top of the column into bushings which were secured in the slab on each side of the column. The actual lifting at each station was accomplished by the hydraulic cylinder while a low pressure oil system served to furnish power to two wobble plate hydraulic motors which, in turn, drove two follow-up nuts on each rod in such a fashion that these nuts were always in bearing so that in case of line or power failure, the load would be snubbed and not allowed to drop back.

### Lifting Equipment

Rate of rise control at each station was obtained by metering the high pressure oil to each cylinder through a separate flow valve so that each station would receive a given quantity of oil in a given period of time regardless of the back pressure due to the load at the particular station. A visual check against the flow valves was maintained by a set of solenoid-operated counters which took their count at each station in increments of 83-thousandths of an inch. All of the lifting equipment was controlled from a central panel by a single operator.

The Institute's structural engineers working under Mr. Lance, and with the help of Mr. Fred Severud, collaborated with the architects for Trinity University to evolve a design for the first unit of the new campus—an administration building which could be built with either conventional construction or the Youtz-Slick technique.

### Youtz-Slick Method Bids Lower

Bids were solicited for construction with both the new and old methods and while it was no surprise to those working on the project, skeptics were amazed to find the bids on the Youtz-Slick method 10 per cent lower for this first commercial application of the new method than for the well-documented and perfected old type of conventional construction with which the bidders were thoroughly familiar.

The Trinity contract was let to the James Stewart Construction Company of New York and Dallas early in 1950. By March 16, slabs were being poured and, seven weeks later, all of them had been raised and welded into position. The lifting equipment functioned perfectly and no structural cracks were developed in the entire operation. The rate of lift was 2 inches in one minute, 35 seconds, with a 50-second interval to retract the jacks after each 2-inch stroke. After the first two sections had been lifted and welded in place, and the four-man crew had become familiar with moving and setting up the equipment, the total time required to move on to a slab, rig up, and lift both the roof and the second floor was only 36 hours per section.

### Slab Weight 278,000 Pounds

The floor area of the Trinity University Administration Building was divided into seven bays or sections, approximately 44 by 73 feet in size, for the most economical repetitive utilization of eight lifting jacks in each bay. The roof slabs were 8 inches thick and the floor slabs, which were 9 inches thick, weighed 278,000 pounds each. These sections were later connected by pouring a 4-foot section of concrete, with conventional forms between the bays. The reinforcing steel from adjacent bays overlapped in this connection area. Another advantage realized through sectionalizing the slabs and the lifting operation was the re-use of the plastic separating materials which were recovered from the early slabs and re-inserted between the ones poured later.

So far as Institute engineers know, there are no technical reasons why a slab of infinite size could not be poured monolithically and lifted in one piece. Such an operation would require a larger investment in separating material and lifting jacks than is justified when the equipment can be used repeatedly to achieve the same result, and the pouring and lifting can be scheduled consecutively as the concrete attains the desired strength in each adjacent section of a large slab area.

### Limitations Unknown

Nobody yet knows what limitations exist on the height of buildings and the number of floors which can be erected economically with the Youtz-Slick technique. The height of free standing columns, before the slabs are raised, might be limited to three or four floors without elaborate guying apparatus. Longer columns could easily be fabricated in sections and welded on top of each other as the lower

## INSTITUTE OF INVENTIVE RESEARCH

### Personnel

**WILLIAM J. LANCE:** Primarily responsible for the development of the Youtz-Slick Lift Slab Building Method.

**ROBINSON BROWN:** Supervisor, Engineering Design, who designed and developed the lifting machinery essential to the Youtz-Slick Lift Slab Method.

**JUDSON SWEARINGEN:** Chairman of Chemical Engineering, whose department determined the type of separating materials used between slabs.

**C. W. SMITH:** Director of the Division of Housing Construction and Technology for Southwest Research Institute.

**HAROLD VAGTBORG:** Director of the Institute of Inventive Research and President of Southwest Research Institute.

sections were stabilized through the lifting and spacing of slabs.

No official announcements of the savings actually realized in the construction of the Trinity slabs have been made. It is certain that savings have resulted not only from the elimination of all except perimeter forms and forms for connecting the bays, but also in the placing of reinforcing steel, electrical conduit, plumbing sleeves and the fact that no materials had to be elevated, placed in position and finished by hand in inconvenient and sometimes hazardous locations.

#### **Collateral Economies**

Final cost comparisons, when the entire building program is completed, may reveal a variety of collateral economies. True slabs accurately positioned mean less cutting and fitting for all other trades on the job. Flat slabs require no false ceiling; they are finished by applying acoustical tile on the under side with a mastic. Use of fewer interior columns with the perimeter of the slabs cantilevered permits use of continuous curtain wall modular components and large glass areas for inclosure. On the south side of the administration building, the curtain walls are set inside the floor overhang which provides an economical method of sun control. The architects have exploited many similar design features which are economically facilitated by inherent advantages in the Youtz-Slick technique. Furthermore, the dramatic possibilities of such a new technique stimulate reappraisal of conventional design principles and encourage architects to forget the limitations imposed by traditional techniques, materials and designs.

All of these factors jointly contribute to economies in construction and to greater efficiency in the finished structure. The Trinity University buildings are being constructed at a cost which, when compared with the cost of most traditional and conventional structures designed for similar use, will indicate a substantial saving.

Southwest Research Institute and its affiliated Institute of Inventive Research are justifiably proud of their contribution to society and the construction industry in the Youtz-Slick Lift Slab system. As this technology becomes widely used and its advantages in building design and economies become appreciated and experienced, the construction industry will again benefit from the same kind of stimulation and rejuvenation it enjoyed toward the end of the nineteenth century when another generation of engineers evolved the structural frame enclosed by curtain walls to supplant the former load bearing wall construction.

#### **Technological Progress**

"Raising the roof" with the Youtz-Slick method is a spectacle which attracts great public interest and

provides a dramatic example of technological progress through scientific research. It is not, however, the result of any mysterious process. Cooperative and coordinated research has been commonplace for years in many businesses and in the great industrial laboratories of this country. It is new to the building business because there never previously existed any single organization willing to assume the responsibility for a program of overall achievement in the field of housing and building construction.

Southwest Research Institute, through its Division of Housing and Construction Technology, is providing individual manufacturers, trade associations, code authorities and financing institutions not only a favorable environment for individually sponsored research projects, but also an opportunity to integrate such individual efforts into a broad program of demonstrated value to society as a whole.

Firms with which the Institute has reached franchise agreements on the licensing of the Youtz-Slick Lift Slab Method include: James Stewart & Company, New York, Dallas and Chicago; Long Construction Company, Kansas City, Missouri; Frank R. Lount & Co., Winnipeg, Manitoba, and Texstar Corporation of San Antonio.

## **LIGHT-WEIGHT PUZZOLAN FOR CONSTRUCTION**

**By FRANK B. ANDERSON**

Within the next few months there promises to be developed in California a new industry of which the construction industry has been aware for a number of years, but which for one reason or another has never been exploited. It is the manufacture of a puzzolan material similar to that used by the Romans in the construction of aqueduct and marine structures which are still in use after 2000 years.

The particular deposit of puzzolan under consideration for development is located at Red Rock in Lassen County, California, and is on the mainline of the railroad.

Puzzolan is a siliceous material, which when combined with lime or with portland cement and water, forms an insoluble cementitious product of a volcanic ash nature.

The many uses to which the product can be put has attracted widespread attention but utilization



of this particular deposit has been retarded until now because of lack of an organization to manufacture. With the organization of the California Pozzolana Corporation, owned by P. F. Frund of Sausalito, California, the concern is now financially able to proceed with development of the project.

Puzzolan deposits are quite rare, hence the general use of the material has been limited to the few more or less exclusive firms that use it in their own business and manufacturing processes.

The U. S. Bureau of Mines issued this description of the material in its circular 6974 of October 1937:

"A type of mineral that has been known for several milleniums as the pozzolanic materials or 'pozzolans'. Roman structures made with lime and volcanic ash 3000 years ago are still standing. Recently admixtures have been made to cement which unite with the lime liberated during the setting of the cement and thus add to the cement materials normally present. In the larger dams and other structures built in the West in recent years certain addition of pozzolanic mineral has been specified. Cement mortars can, under correct conditions, be made more plastic, more impermeable, non-corrosive, and even stronger by including pozzolanic admixtures."

The Lassen volcanic material is chemically and physically similar to some of the best Italian materials, according to a report prepared a number of years ago by Winfield H. Arata, civil engineer and concrete technologist, member of the American Concrete Institute of the Northern California Chapter of the Associated General Contractors.

Arata states in his report that there is a "very large field of use awaiting Lassen Pumicite. The market is open for a product of this type which has merit and can be marketed at a reasonable price. A survey of the field indicates that a market for considerable tonnage can be developed both for use with portland cement and for industrial purposes."

His report went on to explain many of the uses

to which the material can be put. As an admixture in portland cement concrete, plasters, mortars and stuccos it would produce the qualities of workability, cohesion, impermeability increased strength, density, durability and elimination of efflorescence.

For a blend or cement replacement for producing sulfate resistant and non-corrosive concrete, he explained, it is highly desirable for uses in sea water structures, sewage works, septic tanks, water works, concrete pipe, concrete in alkaline soils, canal linings, etc.

This material, he went on to declare, has a field for use in acoustic plaster and light-weight concrete in connection with light-weight aggregates now on the market, and in technical uses it would be applicable to cleaning powers, insecticides, paints and varnishes, paper products, polishes, explosives, binder asphaltic concrete, etc.

Experiments made some years ago show the usefulness of this material in combating the deterioration of floors in canneries where fruit acids practically destroy ordinary floors in a season.

E. Lorenzo Howard, testing engineer for the Pacific Coast Aggregates, was the author of an article entitled "Food Acids vs. Concrete" in the magazine "Concrete", in January 1948. He told about the success found in mixing this particular puzzolan with portland cement in laboratory experiments as well as using it in the floors of canneries.

The Howard article brought letters of inquiry from all parts of the world and soon exhausted copies of the magazine. The construction industry proved to be extremely interested in the subject.

While the deposit of this particular pozzolanic material has been known for a long time, it was only recently that efforts have been made to develop it. P. F. Frund, learning that the property was available, acquired a long term lease on 200 acres and has since sunk a shaft some 100 feet deep, determining that the material gets better and better as the shaft is lowered. Preliminary estimates indicate the supply is practically unlimited.

---

## SURVEYING BUILDINGS

(From Page 9)

of the area which deficiencies can be remedied in the future if and when funds are available for such purposes.

The city building department had a list of approximately 104 structures to be examined. To carry out such a program as this in a short time a letter was sent from the office of the Mayor to the members of the Oregon Section of the ASCE, to the Oregon Chapter of the AIA, and to the Structural Engineers Association of Oregon, asking them to come to the city hall for briefing and

registration. The response to this letter was the most important phase of the success of the program. The engineers and architects filled to overflowing the council chambers on two occasions.

At the short evening briefing meetings the program was outlined and the registrations taken on cards. The card information included the time preferable for work on the program, buildings preferred, and parts of the city preferred. The cards were then taken by the city Building Department and sorted into those representing like groups, time-wise and area-wise. Clip boards were then

prepared for three specific buildings, with check sheets, cross section paper, instruction sheets, and scratch pads. The volunteers were then called and were formed into groups of three as they appeared at the city hall building department. It was attempted to form each group from both architects and engineers whenever possible. The groups then went to the specific buildings and returned their data when the survey was completed.

The groups looked for areas of buildings that were protected from flying debris, that would not become flooded or filled with gas, and that would be accessible. There was no minimum standard set to which all areas had to be graded. It was attempted to find which areas seemed to offer a degree of protection that was better than other parts of the building, and which could be defined as less likely to be destroyed than other parts of that same building. The buildings were restricted to those, however, that were of reinforced concrete or steel frame. Other types of structures were not deemed satisfactory for protection against any reasonably well placed bomb.

More than 90 per cent of the 104 buildings were surveyed in the first two days of the program, with the balance completed in less than one week. Upon completion of the survey on the major structures, all the schools within the city limits were surveyed and evaluated. The results, in duplicate, were turned over to the city which is now working out the program of designating the areas found by the engineers and architects.

The study pointed up the fact that casualties can probably be greatly reduced by getting the population into less exposed areas of existing buildings. Air raid shelter programs of new shelters if any will be correlated with the analyses of the existing structures and population density information for the most effective use of the new shelter money.

#### FOUNDATION FIRM PUBLISHES UNUSUAL TRADE BOOKLET

The Casey & Case Foundation Company of Maywood, and Berkeley, California, recently issued a very interesting booklet, describing in some detail and interestingly illustrating the subject of foundations.

The publication covers the installation of foundation structures, pressure grouting, drainage, de-watering, underpinning, and shoring and drilling for sub-surface exploration. Various types of work done by the firm are illustrated and the booklet includes a number of drawings and technical tables.



Specify Utility equipment!—The one sure way to avoid the headaches of an installation that just doesn't measure up to your specifications. You're sure with Utility because it sets the industry standard for quality and performance.

#### A FULL RANGE OF UTILITY HEATING EQUIPMENT

**Floor Furnaces**—45,000 BTU./Hr. input, flat and dual; also, 60,000 BTU./Hr. input, flat and dual (both sizes, shallow-type construction). **Wall Heaters**—Single—27,500 BTU./Hr. input; Dual—35,000 BTU./Hr. input and 50,000 BTU./Hr. input. **Forced Air Furnaces**—75,000 BTU./Hr. input; 100,000 BTU./Hr. input; 125,000 BTU./Hr. input and 150,000 BTU./Hr. input. **Unit Heaters**—4 sizes. All Utility Heating Equipment is tested and approved by A.G.A.



#### UTILITY EVAPORATIVE AIR COOLERS AND VENTILATING EQUIPMENT FOR EVERY PURPOSE

Utility's air delivery tables are complete and authentic, derived from tests made in accordance with A.S.H.V.E. test codes. Every Utility cooler is tested in accordance with these same codes. You can meet every requirement with Utility. The line includes evaporative coolers, both Fan and Blower types... sizes to meet all requirements.

#### SEND FOR AIA ENGINEERING INFORMATION

For this complete technical data on Utility equipment, plus valuable tables, charts, installation details, write (on your letterhead) to Engineering Dept. Counsel from a Utility Engineer available without charge.

UTILITY APPLIANCE CORP.  
4851 S. Alameda Street, Los Angeles 58, California



EVAPORATIVE AIR COOLERS      GAS-FIRED FURNACES  
VENTILATING EQUIPMENT

Manufacturers of Gaffers & Sattler and Occidental Gas Ranges

# American Institute



# of Architects

Ralph Walker, president  
Glenn Stanton, 1st vice president  
Kenneth E. Wischmeyer, 2nd vice president  
Clair W. Ditchy, secretary  
Charles F. Cellarius, treasurer

#### Arizona Chapter:

Edward L. Varney, President; Ralph B. Haver, Secretary,  
P. O. Box 786, Phoenix, Arizona.

#### Central Valley of California:

William Koblak, President; Gordon Stafford, Vice-President;  
John W. Bamberger, Secretary; Albert B. Thomas, Treasurer,  
Secretary's Offices P. O. Box 1943, Modesto.

#### Coast Valleys Chapter:

William F. Hempel, President; Lawrence Gentry, Vice-  
President; Walter Stramquist, Secretary-Treasurer. Sec-  
retary's office, 321 Channing Ave., Palo Alto.

#### Colorado Chapter:

Henry J. Van Wyl, President; Charles H. Overholt, Sec-  
retary, 2509 W. 36th Avenue, Denver, Colorado.

National Headquarters —  
1741 New York Avenue, N. W.  
Washington 6, D. C.

Edmund R. Purves  
Executive Secretary

#### Northern California Chapter:

Ralph N. Pollack, President; Francis J. McCarthy, Vice-  
President; William B. McCormick, Secretary; George A.  
Downs, Treasurer, Offices 369 Pine St. San Francisco.

#### Oregon Chapter:

Herman Brookman, President; Donald J. Stewart, Vice-  
President; Raymond Kermit Thompson, Secretary; Millard  
H. Schmeer, Jr., Treasurer. Secretary's office 429 S. W. 4th  
Avenue, Portland.

#### Pasadena Chapter (California):

Culver Heaton, President; Don Neptune, Vice President;  
Arthur Frick, Treasurer; (Mrs.) Dorothy Gray, Secretary.  
Directors: John N. Douglas, Boyd George, Roland E. Coote  
and Burton Romberger. Office 1041 East Green St., Pasca-  
dena.

## WINS HOME BUILDERS DESIGN CONTEST

Bruce Walker, 28 year old graduate student at the Harvard School of Architecture has been awarded top national honors and first prize in the Better Living Home design contest which was sponsored by the National Association of Home Builders and the Magazine of Building.

Over 2,700 entries were submitted representing every state in the Union.

Walker is a graduate from the University of

Washington, Seattle, and prior to entering Harvard for his Master's Degree, was associated with the architectural firm of McClure & Adkinson in Seat-  
tle.

## SAN FRANCISCO ARCHITECTURAL CLUB BUILDING FUND PROJECT

The San Francisco Architectural Club, thru its officers and directors, has expressed appreciation and thanks for the cooperation extended the Club during its recent Building Fund Drive, the results of which have been declared as "quite successful."

A number of awards were given in conjunction with the event and among the winners were: Walter Kuhn, James Dennis, Russell Pennell, W. H. Hansen, and Milton L. Allen.

## ANNUAL WASHINGTON CHAPTER A.I.A. CONVENTION

The annual meeting of the Washington State Chapter of The American Institute of Architects will be held on June 1, 1951 in the Washington Athletic Club, Seattle.

The Annual Banquet, scheduled for the same evening, will be held at the Rainier Golf and Country Club.

## SOUTHERN CALIFORNIA CHAPTER

The recent Fort Moore Memorial Wall competition drew 77 entries, with first prize going to Kazumi Adachi and Dike Nagano for their simple treatment of the problem. Whitney R. Smith and Wayne R. Williams took second place; George Shinno, third; Sam Luden, Roger Hayward and Ben H. O'Connor, fourth; Herbert J. Powell, fifth; and Robert Orr, W. T. Strange, Jr., and Robert Inslee, sixth.

John J. Landon, Paul R. Hunter, Charles O. Matcham, Henry L. Wright, Maynard Lyndon, Samuel E. Lunden, Charles Fry, Earl T. Heit-

Remember it's

# KRAFTILE

for GLAZED STRUCTURAL WALL UNITS  
PATIO TILE  
SWIMMING POOL OVERFLOW  
GUTTER  
QUARRY TILE  
FACE AND ROMAN BRICK  
ACID BRICK  
BRICKETTES  
MINWAX TILE & CONCRETE  
FLOOR FINISH  
STRAN-STEEL FRAMING  
QUONSET BUILDINGS

For complete information and prompt service, phone or write

## KRAFTILE COMPANY

NILES, CALIFORNIA

NILES 3611

SAN FRANCISCO 5: 50 Hawthorne St.—DUgles 2-3780

LOS ANGELES 13: 406 South Main Street—MUTual 7241

**East Bay Chapter:**

Harry A. Bruno, President; Chester H. Treichel, Vice-President; Ira D. Beals, Secretary; Cecil S. Mayer, Treasurer. Secretary's office, 1444 Webster St., Oakland.

**Montana Chapter:**

E. Edward Sawcroft, President (Billings); J. Van Teylingen, Vice-President (Great Falls); H. C. Cheever, Secretary-Treasurer. Secretary office, Bozeman.

**Nevada Chapter:**

George L. F. O'Brien, President; Aloysius MacDonald, Vice-President; Graham Erskine, Secretary; Edward S. Parsons, Treasurer. Offices 160 Chestnut St., Reno.

**Nevada State Board of Architects:**

L. A. Ferris, President, Reno; Walter Zick, Secretary, Las Vegas; Directors: Aloysius MacDonald, Las Vegas; Russell Mills and Edward Oarson, Reno. Office, P. O. Box 2107, Las Vegas, Nevada.

**San Diego Chapter:**

Jack R. Lewis, President; Louis A. Dean, Vice-President; Donald Campbell, Secretary; Victor L. Wulff, Jr., Treasurer. Directors: C. J. Poderevski, G. C. Hatch. Secretary office, 1250 Prospect St., La Jolla.

**San Joaquin Chapter: (California)**

Fred L. Swartz, President, Fresno; Lloyd J. Fletcher, Vice President, Visalia; Walter Wagner, Secretary, Fresno; Robert W. Stevens, Treasurer, Fresno. Directors: Alastair Simpson, William D. Coats, William F. Baxter. Maurice J. Metz, Delegate, California Council of Architects. Office, Sec. Fulton-Fresno Bldg.

**Santa Barbara Chapter (California):**

Robert L. Hoyt, President; Harold E. Burket, Vice-President; Roy W. Chesman, Secretary; Lutah M. Riggs, Treasurer. Address, 242 San Marcos Bldg.

**Southern California Chapter:**

John J. Landon, President; Chas. Frey, Vice-President; C. Day Woodford, Secretary; Wm. G. Balch, Treasurer. Directors: Paul O. Davis, Henry Wright, John Rex, and Kemper Nomland. Ex. Sec. Rita E. Miller. Chapter Headquarters, 3723 Wilshire Blvd., Los Angeles 5.

**Spokane Chapter:**

Richard H. Eddy, President; Harry C. Waller, Vice-President 1; Kenneth D. Stormont, Vice-President 2; Victor L. Wulff, Secretary, and Carl Johnson, Treasurer. Office 1023 W. Riverside Ave., Spokane, Washington.

**Utah Chapter:**

Howell O. Cannon, President; William J. Monroe, Jr., Secretary, 3707 South 32nd West Street, Salt Lake City 7, Utah.

**Washington State Chapter:**

Perry B. Johanson, President; Paul Thiry, 1st Vice-President; Thomas F. Haysis, Jr., 2nd Vice-President; John S. Deltie, Secretary; Lawrence G. Waldron, Treasurer. Office 714 American Bldg., Seattle 4.

**Tacoma Society:**

E. N. Duxon, President; P. G. Ball, Vice-President; Lyle Swedberg, Secretary-Treasurer.

**Hawaii Chapter:**

James C. Simms, President; Alfred Pries, Secretary, 1507 Kapiolani Blvd., Honolulu, T. H.

**CALIFORNIA COUNCIL OF ARCHITECTS**

John L. Rex, President; Wm. Koblak, Vice-President; Maurice J. Metz, Secretary-Treasurer. Executive Secretary office 3723 Wilshire Blvd., Los Angeles.

**OTHER ARCHITECTURAL ORGANIZATIONS****San Francisco Architectural Club:**

Alfred T. Kirkevoild, President; Charles Dennis, Vice President; William C. Thieleman, Treasurer; Milton Bromberg, Secretary. Office 507 Howard Street.

schmidt, Kemper Nomland, Edla Muir, Paul O. Davis, Savo Stoshitch, Stanley R. Gould, Richard Neutra, C. Day Woodford, William S. Beckett, C. M. Deasy and Arthur Froelich were named delegates to the annual A.I.A. Chicago convention.

**WASHINGTON STATE CHAPTER**

The May meeting was devoted to a joint session with students in Architecture at the University of Washington, and the Alumni. A full program was scheduled with selection of the Honor Awards Competition and presentation to students of the annual A.I.A. Award for Excellence in Design, Alpha Rho Chi Medal and the Faculty Award.

It has been decided to continue the Small House Plans Bureau for the time being, or until a new method for providing economical service has been accepted by the Chapter.

The recent School Conference, held at the University of Washington, continues to draw favorable reactions. Concensus is that the project was very successful and should be repeated with more school authorities present.

Leonard Bindon, William H. Carleton, Waldo B. Christenson, John S. Deltie, Robert L. Durham, Clyde Grainger, Perry B. Johanson, B. Marcus Priteca, Paul Thiry and Edwin T. Turner, together with alternates Paul G. Carlson, Lamonte J. Shoret, Walter H. Rothe, Ivan W. Meyer and Andrew Wiltsen, were named official delegates to the A.I.A. Chicago convention.

New Associates: Junior Associates include Robert M. Mommsen and Robert A. Bennighof; Student Associates include Arnold C. Amundson, Jr.

**HONORARY MEMBERSHIPS GRANTED BY A.I.A.**

The American Institute of Architects has granted Honorary Memberships to Edwin S. Burdell, Director of the Cooper Union; Lewis Mumford, author and critic; and W. Englebert Reynolds, Commissioner of Public Buildings, Washington, D. C.

These awards for distinguished service to the profession of architecture or allied arts and sciences, are given persons not eligible for corporate membership in the architects' professional organization. They were made at the annual A.I.A. Convention in Chicago early in May.

**NORTHERN CALIFORNIA CHAPTER**

John Reber, nationally recognized for his proposal to remake the San Francisco Bay, spoke at a recent meeting on the widespread interest and progress being made in his program. Reber proposes, by means of dams and dikes and control gates to regulate the flow of waters in the bay and to convert much of the present tidelands into industrial sites.

The project has been under consideration for a number of years.

**AMERICAN ARCHITECTURAL FOUNDATION ACTIVITIES**

The American Architectural Foundation, Inc., founded in the State of New York in 1942 by a group of architects, has announced a list of projects which the Foundation is now supporting.

Among current activities is a program of education in the fields of Modular Co-ordination of Building Materials, Teacher-training Institutes in Architecture and other Fine Arts, Endowed Chairs of Lectureships in the Humanities, Fellowship for Ad-

(See Page 38)



# WITH THE ENGINEERS

Structural Engineers Association of California  
Arthur W. Anderson, President; Harold P. King, Vice-  
President; Henry J. Degenkolb, Sec.-Treas.; Office of  
Sec., 405 Montgomery St., Room 1121, San Francisco.

Structural Engineers Association of  
Northern California

John E. Rinne, President; John J. Gould, Vice-Presi-  
dent; Wm. W. Brewer, Sec.; Franklin P. Ulrich, Treas.;  
Directors, Walter L. Dickey, Leslie W. Graham, Hy-  
man Rosenthal, and Howard A. Schirmer.

Structural Engineers Association of  
Central California

William H. Petersen, President; Walter S. Wassum,  
Vice President; O. T. Illerich, Sec. Treas.; Ernest D.  
Francis, M. A. Ewing, and Arthur A. Sauer, directors.  
Office O. T. Illerich, c/o Div. of Arch., Sacramento.

American Society of C. E.  
San Francisco Section

Clement T. Wiskocil, President; John S. Longwell, Vice-  
president; J. G. Wright, Vice-president; H. C. Medbery,  
Treasurer; R. D. Dewell, Secretary. Secretary's Office,  
604 Mission St., San Francisco.

Structural Engineers Association of  
Southern California

Donald F. Shugar, President; Harold P. King, Vice  
President; Robert J. Short, sec.-Treas.; Directors, Wil-  
liam T. Wheeler, William T. Wright, Ernest C. Hillman,  
Jr., John Case, and John K. Minasiom. Office, 202  
Architects Bldg., Los Angeles 13.  
Structural Engineers Association of  
Oregon

R. Evan Kennedy, President; Guy H. Taylor, Vice  
President; James R. Griffith, Secretary-Treasurer; Direc-  
tors Jerome A. McDevitt, H. Loren Thompson, and  
Robert L. Tidball. Offices, Portland.

Puget Sound Engineering Council  
(Washington)

R. E. Kister, A. I. E. E., Chairman; E. R. McMillan,  
A. S. C. E., Vice Chairman; L. B. Cooper, A. S. M. E.,  
Secretary; A. E. Nickerson, I. E. S., Treasurer. Offices,  
L. B. Cooper, c/o University of Washington, Seattle 5,  
Washington.

American Society Testing Materials  
Northern California District

L. A. O'Leary, Chairman; P. V. Garin, Vice-chairman;  
H. P. Hoopes, Sec. Office Sec., 1550 Powell St., Emery-  
ville, Calif.

## ENGINEERING FOUNDATION REPORTS ON RESEARCH PROJECTS

The Engineering Foundation, joint research or-  
ganization of the American Society of Civil En-  
gineers, American Institute of Mining and Metal-  
lurgical Engineers, The American Society of

Mechanical Engineers, and the American Institute  
of Electrical Engineers, recently reported on the  
progress of 14 projects being carried out under its  
sponsorship.

Three are in the field of mechanical engineer-  
ing, five in civil engineering, four in mining and  
metallurgical engineering, and two are co-operative  
projects.

## ENGINEER WINS FELLOWSHIP AWARD

Dr. Lester E. Reukema, professor of electrical  
engineering on the Berkeley campus of the Uni-  
versity of California, has been named a "Fellow"  
in the Institute of Radio Engineers.

The fellowship award was given to Prof. Reu-  
kema for his research work in the field of antennas  
and antenna systems.

## AGRICULTURAL ENGINEER APPOINTED AT DAVIS

Lloyd E. Lamouria has been appointed to the  
agricultural engineering staff of the University  
of California at Davis. He will have charge of the  
farm course in gas and electric engines and  
tractors.

Lamouria comes to California from the Iowa  
State College.

## STRUCTURAL ENGINEERS ASSOCIATION OF CALIFORNIA

State-wide committees have been appointed by  
president Arthur W. Anderson to arrange technical  
and entertainment programs for the Annual Con-  
vention scheduled for Yosemite in October. The  
dates of October 11, 12 and 13 should be set aside  
and plans made now to attend these important  
meetings.

Always specify  
**HAWS**  
for Highest Quality

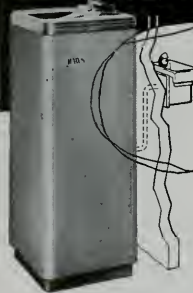

**HAWS Electric Water**  
Coolers easily adapt to re-  
mote installations of HAWS  
Drinking Fountains...thus  
serving several locations.

• A COMPLETE LINE of  
coolers, fountains, fau-  
cets, equipment, filters  
and accessories. • A rep-  
utation for reliability since 1909. • Check in  
Sweets, or write for complete HAWS catalog.

**HAWS DRINKING FAUCET CO.**  
1441 FOURTH STREET (Since 1909) BERKELEY 10, CALIFORNIA  
Agents and Sales Representatives in All Principal Cities

Representatives met with Chas. H. Purcell, Director of Public Works, recently to discuss modification of fees paid by the State Division of Architecture for professional services on State projects.

The Board of Directors has approved a policy designed to cooperate with architects and engineers and other interested parties to secure fees that will insure complete service with a fair profit; to establish a standard structural engineering fee to be specified by the State in its architectural contracts (Fee to be a minimum of one quarter of the architects fee); and to urge the State to award construction to Structural Engineers where the services required are predominantly engineering.

#### ENGINEER APPOINTED AT CALIFORNIA POLYTECHNIC

Ralph B. Priestley has been appointed dean of the Division of Engineering at the California State Polytechnic College at San Luis Obispo, according to a recent announcement by Julian A. McPhee, president.

Priestley has been serving as head of the school's department of architectural engineering since 1948, coming to the college from Chicago. He will have charge of the aeronautical engineering, air conditioning and refrigeration engineering, architectural engineering, electrical engineering, electronic and radio engineering, mechanical engineering, maintenance engineering and printing departments.

#### STRUCTURAL ENGINEERS ASSOCIATION OF SOUTHERN CALIFORNIA

The regular May meeting was held in the Alexandria Hotel, Los Angeles, with a discussion of "Problems of Corps of Engineers in the Present Emergency" with Lt. Colonel William R. Shuler, Los Angeles District Engineers Office Corps of Engineers, Dept. of Army.

A report was also made on the recent conference in Sacramento between members of the State Legislature and representatives of the Structural Engineers Association of California.

New members: Floyd E. Weaver and Clare F. Meyer, Associate Members. Bent N. Cardan, Member; and Byron P. Weintz, Affiliate Member.

#### ENGINEERS CONFER WITH ARMY AND NAVY ON DEFENSE WORK

A joint committee composed of Clement T. Wisocil, American Society of Civil Engineers, San Francisco Section; G. M. Simmonson, Consulting Engineers Association, and John E. Rinne, Structural Engineers Association of Northern California met with a group of high Army and Navy officials on defense work problems.

Suggestions were made to the military that

where projects involve preliminary engineering work, prime contracts be given to Engineers. Also that in all instances local engineers be given preference on local projects.

#### CARLTON PROCTOR NOMINATED FOR 1952 ASCE PRESIDENT

Carlton S. Proctor, New York City, was nominated for 1952 president of the American Society of Civil Engineers at a meeting of the ASCE Board of Directors in Houston, Texas.

Proctor has served the Society with distinction in several important posts. He was Director for District 1 from 1936-1938, and vice president for Zone 1 in 1948-49, serving on the executive committee of the Board of Directors during part of his tenure in both offices.

#### STRUCTURAL ENGINEERS ASSOCIATION OF NORTHERN CALIFORNIA

The regular April meeting was held in the Sutter Club in Sacramento and consisted of a "get acquainted" gathering with members of the California State Legislature. The Committee in charge of the arrangements included Milton Bromberg, Will Dreusike, Joseph Guptil, Robert Harrington, Robert P. Moffett, Earl W. Paddack, Walter Pickthall, Henry C. Powers, Jr., Charles Scurich, Alfred

(See Page 31)



Always specify

**HAW'S**

for Highest Quality

Sanitary Drinking Fountains

Electric Water Coolers

Drinking Faucets, Equipment,  
Filters and Accessories

• A reputation for reliability since 1909. Check in Sweets or write for HAW'S catalog.

**HAW'S DRINKING FAUCET CO.**  
1441 FOURTH STREET (Since 1909) BERKELEY 10, CALIFORNIA  
Agents and Sales Representatives in All Principal Cities

# PRODUCER'S COUNCIL PAGE

The National Organization of Manufacturers of Quality Building Materials and Equipment  
affiliated with THE AMERICAN INSTITUTE OF ARCHITECTS

President, Arthur C. Staet  
Natural Gas Equipment, Inc.  
1150 Folsom Street

Vice-President, Fred A. Figue  
Otis Elevator Company  
1 Beach Street

Secretary, Howard Noleen  
E. F. Hauserman Company  
500 Second Street

Treasurer, A. L. West, Jr.  
Aluminum Company of America  
Russ Bldg.

Edited by Carl B. Frank, DETROIT STEEL PRODUCTS CO.

## TABLE-TOP MEETING

On Wednesday, May 23, at the Fairmont Hotel, the San Francisco Chapter will hold its annual Table-Top Exhibit. This exhibit will be open to the architects, engineers and draftsmen from 3:30 in the afternoon until 7:00 P.M., with cocktails served from 5:00 until 7:00 P.M.

The theme of this exhibit is "Specify with Assurance." This theme is certainly an appropriate one as one of the principal objectives of this year's Council activities is to promote a better specification setup through working with the A.I.A.

We are looking forward to seeing a good representative group in attendance from the ranks of the architects and engineers so as to improve if possible, over last year's fine exhibit. Last year, the exhibit was held at the St. Francis Hotel and we recorded an attendance in the neighborhood of 450 to 500.

There is a tremendous amount of work that goes into the planning of any exhibit such as this one, and Jack Armstrong of David E. Kennedy Co. who is chairman of the Table-Top this year, certainly deserves our heartfelt thanks for his fine work on the job. I might add that Jack is no slouch with a shot glass either, which certainly goes a long way toward breaking the monotonous regularity of the meetings of the committee that are required to shape such a show as this.

## CHAPTER NEWS LETTER

The national headquarters of the Producers' Council has made available to us a periodic paper to be known as the "Chapter News Letter". This letter will contain timely industry information on

such items as N.P.A. Regulations, Civilian Steel Output — Supply & Demand, and many others which our Washington headquarters is in a position to pass on to us. In addition to this information which would be on the front side of this one-page news letter, the reverse side would be available for Chapter use, in inserting local news, etc. We thought this would be a fine idea and decided to put one out on a trial basis. In so doing, we decided to put the preliminary announcement for our June golf meeting, asking that the interested architects and engineers drop a postcard or telephone us, if they would like to participate, giving their handicap if any.

We can now confirm a long standing suspicion to the effect that the modern business man never reads the last paragraph, as we have received only two cards in answer to our request. We know darn well that there are more architects and engineer golfers than that reply would indicate.

With the above in view, the following questions now come up for discussion:

1. Should we continue the News Letter?
2. If we continue the News Letter, should we put the Chapter news first and the National News last?
3. How far is up?

## EDUCATIONAL COMMITTEE

In previous issues, we have brought to your attention Herb Duncan's Educational Committee, and we are pleased to announce that due to the success of our program at the University of California, Stanford University has now requested a similar series of educational films on the Industry. We are indeed pleased with this additional opportunity to place our programs before the future Don Kirbys.

USE QUALITY PRODUCTS



CONSULT AN ARCHITECT

## WITH THE ENGINEERS

(From Page 29)

Sperry, Bert Summers, K. V. Steinbrugge and Lloyd White.

Arrangements with the legislators were in charge of the California Legislative Council of Professional Engineers, under auspices of the Structural Engineers Association of California. The Central California Association were in charge of meeting details and a large number of Southern California Association members chartered an airplane and flew to the conference.

New Members: Walter F. Koller, Cyril M. Peletz, Bennett L. Ralpin and John M. Sardis are new members. New Affiliate members include Richard C. Clark, George H. de la Vergne, Robert W. Harrington, and W. F. Pruden a transfer from Southern California.

## MILITARY AIR TRANSPORT NEEDS MANY ENGINEERS

The Military Air Transport Service has announced its needs for a number of qualified civil, mechanical, general, structural and construction engineers in the civilian ranks of its Washington, D. C. headquarters.

Also needed are engineers in the heating, ventilating, refrigeration, air-conditioning and sanitary fields. Permanent positions in government service are open to those who meet the requirements in educational and practical experience.

## ENGINEERS GROUP TO MEET WITH CALIFORNIA STATE BOARD

A committee comprising Henry J. Degenkolb of San Francisco, Allen H. Brownfield of Sacramento, and Ernest C. Hillman, Jr., of Los Angeles have been named by various engineering groups to meet with members of the California State Board of Registration for Civil Engineers and Professional Engineers to discuss a number of adverse factors on the present procedure and conditions pertaining to examinations for Structural Engineers.

Action has also been inaugurated to have the State Division of Architecture re-activate the Advisory Board as provided for in the California Administrative Code.

## FEMINEERS MEET

The April meeting of the Femeiners was held in San Francisco at the Elks Club, with Mrs. Ed McKeon in charge of arrangements.

**HENRY C. POWERS** has been named vice-chairman of the San Francisco Building Industry Conference Board which meets semi-monthly in the Commercial Club.

## PUGET SOUND CHAPTER OF THE AMERICAN SOCIETY FOR METALS

Reported by

E. J. TURNER, Boeing Airplane Co.

At the April meeting, H. P. Rassbach, metallurgical engineer with the Electro Metallurgical Division of the Union Carbide and Carbon Corporation, presented a technical lecture on the "Effects of Alloying Additions in Steel."

Rassbach devoted the first part of his talk to the cleaning of steel. The carbon-oxygen boil of steel making leaves oxygen in the bath that must be removed to prevent inclusions. The major ton-nages of steel are deoxidized with manganese, silicon or aluminum used singly or in combination. Best results are obtained by combinations. Numerous other elements deoxidize steel. Calcium or a combination of calcium, manganese and silicon produces the cleanest steel.

Vanadium is the best "nitrogen getter" but aluminum is generally used. Hydrogen is a problem on larger ingots in excess of 6 inch diameter. Introducing argon is the best means of flushing it out.

Because inclusions become larger as the rate of cooling is decreased it is believed that the gases are in solution and, therefore, must be removed by

**HOLLYWOOD JUNIOR**  
COMBINATION  
SCREEN and METAL SASH DOOR  
★  
The "WEATHER-WISE"  
DOOR!!

**A VENTILATING SCREEN DOOR  
A SASH DOOR  
A PERMANENT OUTSIDE DOOR  
ALL 3 IN 1!**

Discriminating home owners and architects have chosen Hollywood Junior as the TRIPLE DOOR VALUE in the COMBINATION SCREEN and METAL SASH DOOR field. A sturdy dependable door, constructed of quality material, HOLLYWOOD JUNIOR'S EXCLUSIVE PATENTED FEATURES have outmoded old-fashioned screen doors and other doors of its type entirely! . . .

**IT GUARANTEES YOU YEAR 'ROUND  
COMFORT, CONVENIENCE and ECONOMY**

WE ALSO MANUFACTURE A COMPLETE LINE OF  
SHUTTERS, C. C. DOORS, SCREENS, SCREEN DOORS, LOUVRE DOORS

**WEST COAST SCREEN CO.**  
1145 EAST 13th STREET      L. S. ANGELES, CALIFORNIA  
ADAMS 11124

★ • WRITE FOR FREE ILLUSTRATED LITERATURE • ★



chemical action. Mr. Rassbach pointed out that the lower carbon content required in a steel results in a greater content of residual oxygen that must be removed by deoxidizers.

The speaker covered the alloying effect of elements in the second part of his talk. Manganese and silicon are used as ferrite stiffeners with manganese the most widely used due to relative cost. The carbide formers are chromium, vanadium and molybdenum. Chromium is next to manganese in total tonnage used. It adds wear and corrosion resistance to steel. Molybdenum provides resistance to red brittleness and strength at elevated temperatures. Vanadium is believed to act as a grain refiner. Silicon is useful by increasing strength and scale resistance.

By itself nickel has little effect but as in deoxidizing, combinations of elements develop properties not realized by either when used singly and hence nickel becomes an important alloying element.

Rassbach showed comparative hardenability curves for several steels alloying with the above elements.

The main alloying element of stainless steel is chromium because of its corrosion resistance. Straight chromium steels are both hardenable and non-hardenable depending on the chromium content. Sulphur or selenium is added if free machining is desired.

For increased corrosion resistance, nickel is added to produce the austenitic stainless steel. By decreasing the chromium nickel content of the standard 18-8, strength from work hardening is improved. By increasing these elements, scaling and corrosion resistance is benefited.

Columbium or titanium is added to 18-8 stainless to prevent intergranular carbide precipitation. Because columbium is scarce, extra low carbon is now being used for applications up to 800° F. Due to the strength loss above 800° F. stainless steel stabilized with columbium or titanium must be used.

An interesting side light on nitrogen is its ability to form austenite. The addition of manganese and nitrogen to austenitic stainless steels increases strength and saves 3-3½% nickel.

#### **ENGINEER LEAVES FOR EXTENDED VACATION**

Mr. and Mrs. William Adrian left San Francisco recently via steamer from San Pedro for the east coast of South America. They will go through the Panama Canal and then down the east coast to Buenos Aires.

In addition to sight seeing, fishing and picture taking, Adrian will deliver a number of talks before Engineering Societies on the subject "California Practices with respect to Design for Building Safety".

## **IN THE NEWS**

#### **APPOINTED UTAH DIRECTOR OF FEDERAL HOUSING ADMINISTRATION**

David W. Cannon, native of Salt Lake City, has been named Utah State director of the Federal Housing Administration succeeding Gordon Wegeland, resigned.

Cannon, a graduate of the University of Utah, became associated with the newly-formed Federal Housing Administration in Utah as executive assistant to the state director in 1934 and subsequently was named assistant director.

#### **SF ARCHITECTURAL CLUB SEMINAR**

In announcing the annual San Francisco Architectural Club architectural Seminar, a typographical error appeared in the outline of the Seminar lectures, as appeared in this magazine.

The Seminar consists of twenty lectures (not two) given by well qualified men in the architectural and engineering profession and cover all divisions of the State examination.

#### **RESEARCH FELLOWSHIP IN CIVIC DESIGN**

The Department of Architecture, Yale University, has announced that for the academic year 1951-52 a Fellowship of \$1,500 is offered to graduates in architecture from accredited universities, to encourage research in Yale's new program of civic design.

The projects undertaken by the recipient may form part of the requirements for the Degree of Master of City Planning.

The holder of the Fellowship will be expected to undertake research in three-dimensional or other aspects of Civic Design and to assist in guiding projects by other graduate students in the department. Applications should be made to Christopher Tunnard, Associate Professor of City Planning, Department of Architecture, Yale University, New Haven, Connecticut.

#### **ATOMIC ENERGY COMMISSION TO BUILD HUGE NEW PLANT**

The United States Atomic Energy Commission has announced it will build a new production plant on a four square mile site in the rocky flats area of Boulder and Jefferson counties in Colorado. Acquisition of land for the new facility, a secret type of operation, is being undertaken by the Missouri River Division of the Corps of Engineers, Department of the Army.

Construction is scheduled to commence early in May, following completion of engineering studies, and it is expected about 2,000 construction workers will be employed at the site during the peak of the building early in the next year. Estimated cost of the facility is 45-million dollars.

The plant will be administered by AEC's Santa Fe Operations Office which is responsible for research, development, production and testing of atomic weapons. Carrol L. Tyler, manager of the Santa Fe Operations Office, said "a new AEC field office will be established at the Colorado site" with David W. Persons, of Regional Operations Division, Office of Engineering and Construction at Los Alamos assigned as project engineer.

The new production project will handle radio active material as do many other AEC facilities throughout the nation. Protective measures used in the Atomic Energy Program have been so effective that the Commission's safety record is better than in industry generally.

The Dow Chemical Company of Midland, Michigan, will operate the plant and has assisted in establishing production requirements and site criteria. It is expected more than 1,000 persons will be employed when full operations commence, according to F. N. Langwell of Dow who will manage the plant.

#### "WESTERN HOLLY" OFFERS NEW BUILT IN GAS UNITS

The Western Stove Company, Inc., of Culver City, long identified in the home furnishing and construction industry of the west, have announced the manufacture of a new "Built-In" gas cooking unit.

The new custom built-in, automatic, units incorporate many years of advanced research and design experience and are built to the highest approved standards. They have a lifetime stainless steel finish; have smooth flowing lines; oversize baking oven of one-piece construction; electric timer; and other features include the exclusive top burner Tempa-Plates, the Western Holly's modern-way glide out broiler, and an overall pleasing eye appeal that makes them a "must" for any kitchen.

#### SIMPLIFIED PRACTICE IRON AND STEEL ROOF

Simplified Practice Recommendation 78-50 covering the Iron and Steel Roofing, Siding, and Ridge Roll, are now available from the U. S. Department of Commerce.

First issued in 1928 and reaffirmed in 1931-33-34 and 37, the current revision provides for producers, distributors, users, and others concerned, a simplified list of lengths, widths, and gauges of several kinds of iron and steel roofing and siding; and



**WANTED**

**ADEQUATE WIRING**  
**Certified**

**LIBERAL REWARD**

**You Too  
Can be a "Lawman"**

No reason why the small fry should have the corner on righting wrongs. Take home wiring, for example. There's a heap o' room for improvement.

Many homes being built today are "guilty" of robbing the homeowner of much comfort, convenience, safety and economy because of skimpy wiring. Yet, today's electric living — with its dozens of appliances—makes ADEQUATE WIRING the most WANTED feature in the home.

You can be a "good guy" in the fight for justice by putting the CERTIFIED ADEQUATE WIRING brand on every set of plans you specify. Reward? You can bet you'll be rewarded by being known as a top hand in the building business. And your clients will be rewarded, too, with the most livable, satisfying homes they ever had.

*Northern California Electrical Bureau*  
1355 MARKET STREET - SAN FRANCISCO 3



# A Combined

Landscape Architecture  
and Contracting Service

for

Tract, Industrial and Residential  
Development

We can do the Complete Job for you

- Landscape Architecture
- Finish Grading and Landscaping
- Asphalt Drives and Parking Lots
- Chain Link Fencing

## HENRY C. SOTO CORPORATION

*Landscape Contractors*

13000 SO. AVALON BLVD. LOS ANGELES 61, CALIF.

Phone MEno 4-6617

diameters, girth, length, and gauges of three kinds of ridge roll. It covers corrugated, V-crpi, drain type, pressed standing seam, and roll iron and steel roofing, galvanized or painted; and plain, corrugated, and specially formed ridge roll, galvanized or lead coated.

### NAMED MANAGER ARCHITECTURAL PRODUCTS PROMOTION DEPARTMENT

Albert E. Barnes has been appointed manager of the Architectural Products Promotion for Gladding, McBean & Company, according to a recent announcement by F. B. Ortman, president of the company.



ALBERT E. BARNES  
Gladding, McBean

Barnes was associated with the company for a period of twenty years in the sales and service divisions, prior to 1945.

His headquarters will be in the firm's Los Angeles office and his new assignment will enable the company to expand its policy of providing a maximum service to users of ceramic products in the architectural and building fields.

# Eyes Right!

## RIGHT LIGHTING

• The eyes have rigid requirements in efficient lighting. Smoot-Holman certified illumination meets those requirements with unvarying quality and performance created by superior engineering and skill. Beauty, high efficiency and dependable operation are the hallmarks of the finer lighting equipment that bears the Smoot-Holman label in institutional, commercial and industrial installations.

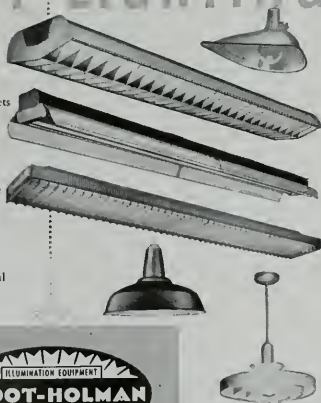

OFFICES IN PRINCIPAL WESTERN CITIES • BRANCH AND WAREHOUSE IN SAN FRANCISCO

### GREAT DEMAND FOR HOLLYWOOD DOORS

In spite of the fact that it is supposed to be the eastern and northern parts of the United States where most of the quickly changeable weather and severe winters are experienced, it took a Californian, the owner of the West Coast Screen Company, Francis H. Hanson to design and manufacture a combination all-weather, all-purpose door that is now receiving national recognition in the construction industry.

The convenient working arrangement of the new Hollywood combination screen and metal sash door makes it possible to change the door quickly and easily from a two-way, ventilating, summer door into a snug fitting, weather-proof winter door without the necessity of adding or removing any panels.

That the new product is commanding attention is attested by the fact that several midwestern jobbers have recently sent their own truck to the West Coast Screen factory in Los Angeles in order to get quick delivery on quantity lots. The obvious effort on the part of many jobbers to obtain the Hollywood Door for their architect and contractor customers indicates the wide acceptance of the new product on the construction materials market. An example of this is a recent U. S. Navy con-

struction project wherein to comply with regulations it was necessary to advertise for bids. Specifications from detailed plans of the Hollywood Door were included in the advertisements with the result that this particular combination door satisfied the bid requirements and the Navy obtained the product desired.

The firm was accorded national recognition recently when a leading woodworking publication, in a featured article, emphasized that the plant contained some of the best machinery, woodworking equipment, and methods of operation of any similar plant in the country. This is the result of twenty-seven years of continual development, and according to Hanson "a strict adherence to progressive design and quality of material and workmanship".

The new Hollywood Doors are available in a number of standard stock sizes and models ranging in width from 2' 0" to 3' 0" x 6' 7" and 2' 0" to 3' 0" x 6' 9". A.I.A. File 35-P1 containing detailed information is available upon request.

#### NEW DOOR OPENER FOR GLASS DOORS

An invisible doorman that opens and closes heavy glass doors yet requires none of the major structural changes common to other types of openers was recently installed in a remodeling of the Clift Hotel in San Francisco.

Remodel of the hotel was designed by the Leo Roselyn Company, industrial designers and the Allied Properties consulting architect, Gardner A. Dailey, A.I.A.

The new unit, called the Pittcomatic, and exclusively distributed on the West Coast by W. P. Fuller & Co., is a small electric-hydraulic automatic power hinge which controls 250 pound doors with a feather-like touch. A slight push or pull on the door handle activates the unit, which can be entirely self contained in a Pittco checking door hinge unit.

The new unit is the first automatic door opener that may be used on store fronts where doors are set flush with the sidewalk. It has been developed primarily for use with the tempered all glass Herculite doors that now line the Main streets of America, and is adaptable to a wide variety of installations.

SCHOOL BONDS VOTED by the Sonora Elementary School District will be used for the construction of additions to the Grammar School at Sonora (California).

Steel required for 850,000 homes will take only 1.8 per cent of the total output of the steel industry.

## PLANNING COMPACTNESS AND CONVENIENCE ?

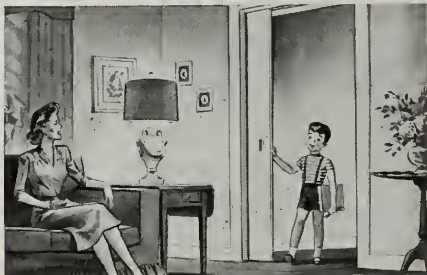

### STANLEY Residential SLIDING DOOR HARDWARE

Sliding Doors Pay Extra Dividends in smart appearance, easy, effortless operation, and more freedom for furnishings. Leading architects and engineers are emphasizing these advantages in the trend to lightweight interior doors where compactness and convenience are important.

Wide Range of Applications—single or multiple doors—is matched by modern Stanley design . . . V-shaped track for minimum friction . . . quick and easy adjustment with a screw driver without removing trim. Complete plans are packed with each set. The Stanley Works, New Britain, Connecticut.



Send for Comprehensive Folder

HARDWARE • TOOLS • ELECTRIC TOOLS • STEEL STRAPPING • STEEL

## JOHNSON BURNERS

*really* **SAVE Oil**

IN HOMES  
HOSPITALS  
HOTELS  
FACTORIES  
STORES  
PUBLIC  
BUILDINGS

— wherever  
dependable  
automatic heat  
is needed!

Johnson Burners give you more usable heat from every gallon of oil that you buy. Why? Because they capture and utilize an exceptionally high percentage of the heat generated in combustion. This extra "efficiency" is the product of 48 years of oil-burner research and "know how." It is paying off in homes, skyscrapers and industries all over the nation. It can save fuel oil and money for you. Let your Heating Engineer or your nearest Johnson Dealer show you why and how.



### S. T. JOHNSON CO.

940 Arlington Ave.  
Oakland 8, California

401 N. Broad Street  
Philadelphia 8, Pa.



## JUDSON PACIFIC-MURPHY CORP.

Steel Fabricators  
and  
Erectors

REINFORCING STEEL  
STRUCTURAL STEEL  
BRIDGE CRANES

4300 EASTSHORE HWY.  
EMERYVILLE, CALIF.

Phone:  
OL 3-1717

## CLINTON CONSTRUCTION CO. OF CALIFORNIA

General Contractors

923 FOLSOM STREET • SAN FRANCISCO

SUHer 1-3440

## HOGAN LUMBER CO.

Wholesale and Retail

LUMBER

MILL WORK • SASH & DOORS

Office, Mill, Yard and Docks  
SECOND AND ALICE STREETS • OAKLAND, CALIF.

Telephone GLencaurt 1-6861



**PROTECTIVE  
BUILDING PAPER ...  
WATERPROOF, REINFORCED ... USED  
AS SHEATHING PAPER, PROVIDES LIFE-LONG  
PROTECTION FROM ENTRY OF WIND, DUST AND  
MOISTURE. IDEAL FOR STUCCO-BACK, OVER  
SUBFILL, CONCRETE CURING, UNDER FLOORING,  
etc. Write for samples and complete data.**

**The SISALKRAFT CO.**

55 New Montgomery St. San Francisco 5, California

## BOOK REVIEWS PAMPHLETS AND CATALOGUES

**ASTM MANUAL ON QUALITY CONTROL OF MATERIALS.**  
American Society for Testing Materials, Philadelphia, Pa.  
Price \$1.75.

This new Manual has been sponsored by the Society's committee on Quality Control of Materials and is designed to replace the Manual on Presentation of Data.

The book is organized into three parts. One, covers the presentation of data; two, presents limits of uncertainty of an observed average; and three, explains the control chart method of analysis and methods for presentation of data.

**A GUIDE TO CONTEMPORARY ARCHITECTURE IN SOUTHERN CALIFORNIA.** By Weston Bonenberger and Frank Harris. Watling & Co., Publishers, Santa Monica, Calif. \$1.95.

Keved to the building boom which has zoomed throughout Southern California the book offers a new guide to the development of contemporary architecture in that region.

The authors have chosen 229 examples of residential, commercial and public buildings as most representative and characteristic of the current architectural trends in the southern part of California. The material is presented according to zones, and while most of the buildings mentioned have been erected since World War II, there are several references to the works of Frank Lloyd Wright and R. M. Shindler of the early twenties.

Assisting the authors who are graduate students in architecture at the University of Southern California are: Arthur B. Gallion, Dean of the UCLA School of Architecture; Pietro Belluschi, architect; and Harold Hauf, formerly Dean of the Yale School of Architecture.

**FUNDAMENTALS OF PERSPECTIVE.** By Theodore De Postels, A.I.A. Reinhold Publishing Co., 330 W. 42nd St. New York. Price \$5.00, Second Enlarged Edition.

The widely known author has evolved a simple and easily understandable method of showing the order in which the lines of a perspective are drawn.

By numbering each line of the constructed perspective and signifying its direction with arrows, the procedure and reasons for it become quickly apparent. To clarify examples, four colors are used to show 1) what is given, 2) what are the essential elements, 3) what lines are needed for the construction of perspective and 4) the perspective of the object itself.

By using a system of colors, numbers, and narrows, the author has simplified his subject.

## NEW CATALOGUES AVAILABLE

Any of the catalogues or folders described here may be obtained by forwarding your request as indicated in the coupon below to the office of the ARCHITECT & ENGINEER. Merely mark the items you want and clip or paste the coupon to your letterhead.

**275. DRILLED AND Poured FOUNDATION STRUCTURES.** Casey & Case Foundation Company of California have just issued an unusual brochure on drilled and poured foundation structures for structural engineers, contractors and construction companies. Types and application of foundation structures, pressure grouting, drainage, dewatering, shoring and sub-surface soil exploration are illustrated and described in case history fashion. There are included valuable tables prepared for the assistance of engineers in estimating drilled and poured foundation piling and coissons. Of particular interest are the tables on volume of different diameter caisson bells in relation to various size shafts. 24 pages illus., 5/3/51.

**276. PLYWOOD BUILT-IN FEATURES PORTFOLIO.** A portfolio of architectural designs for plywood built-in features offering new guideposts to better living has just been issued by Douglas Fir Plywood Association. Designs range from handsome living room storage walls to free-standing outdoor storage fences.

Compiled in handy file format for ready reference, the portfolio contains more than 50 architectural drawings of indoor and outdoor built-ins designed to achieve added comfort and greater livability in every area of the house.

The drawings shown are of the national award-winning better living features developed in the greatest house design competition ever held—the 1951 NAHB Forum competition which attracted 2,727 entries. Arranged by area of the house, the designs for built-ins include storage units for books, records, papers, etc., in living rooms, free-standing breakfast bar and dining room partitions, ingenious closets for finger-tip convenience in the bedroom. 16 pages, illus., 4/27/51.

**277. REDWOOD AND CEDAR FINISHES.** A new brochure, covering Liquid Row-Hide Finishes has just been released by the Linsed Oil Products Company which covers the four basic products produced by this company. Included are specifications for each of the finishes. A.I.A. 25-B-17, 4 pages, 4/8/51.

**278. FREON COOLER CATALOG.** Patterson-Kelley Co., Inc., 312 Barcon St., East Stroudsburg, Pa., manufacturers of refrigeration and heat exchange equipment, has just issued a 12-page illustrated catalog devoted to freon or ammonia coolers of the dry expansion type. The catalog should be a valuable aid to those concerned with air conditioning, process, industrial and commercial refrigeration applications. 12 pages illus., 4/16/51.

**279. MARBLE FOR THE MODERN BANK.** A booklet describing the use of marble in the modern bank interior is available. Photos are shown of the most recent counter, stair, lobby and elevator wall installations. The booklet includes a membership list of the M. I. A. 22-A, 8 pages illus., 4/31.

**280. MASTIC CAULKING AND POINTING.** A brochure containing detailed and short specifications for mastic application on masonry construction, has recently been published by The Tremco Manufacturing Company. Attractively illustrated by photographs and drawings, "Mastic Caulking and Pointing" is a complete discussion of the subject. The specifications, indexed for handy reference, cover 7 pages and include caulking, pointing, bedding and buttering. A. I. A. 7-D, 12 pages illus., 4/51.

**281. METAL LATH NEWS FEATURES LIGHTWEIGHT AGGREGATE GATES.** The first quarterly issue of Metal Lath News, for 1951, highlights the Metropolitan Life Insurance Company's new Park Merced Housing Project, in San Francisco, California, where metal lath and lightweight aggregate plaster interior construction is one of the outstanding features. Studless 2-inch solid partitions of metal lath and lightweight aggregate plaster were used to conserve space, reduce weight, deaden sound and yet provide the ultimate in protection. Other construction jobs illustrate fireproofing of columns and beams with metal lath and vermaculite or perlite aggregate plaster. The examples show how metal lath and lightweight aggregates combine to bring about a dramatic reduction of dead weight to achieve important savings in structural steel—in complete conformance with today's Defense Program efforts to conserve steel. A. I. A. 20-B-1, 14 pages, illus., 4/4/51.

**282. AUTOMATIC-ELECTRIC WALL FURNACES.** A catalog sheet covering the introduction of a new improvement with the WESIX WALL FURNACE. This is the successor to the F S E line of flush wall automatic electric heaters. The sheet shows installation details as well as wall opening dimensions and ratings of the heater. A. I. A. 31K-3, 2 pages illus., 5/1/51.

**283. INTERIOR FINISH MATERIALS.** A beautiful new four-color booklet on Celotex Interior Finish materials is just off the press. The booklet illustrates home remodeling and decorating ideas utilizing the various types of Celotex Interior Finishes, several rooms are done in the two newest exclusive Celotex colors—Blue-Green and Sierra Rose. These modern colors, selected after a nation-wide consumer survey conducted by the New York color engineering firm of Howard Ketchum, Inc., are proving highly popular additions to the Celotex line. 8 pages illus., 4/51.

#### ARCHITECT AND ENGINEER

68 Post Street, San Francisco, Calif.

I would like to have a copy of each of the New Catalogues I have circled.

275      276      277      278      279  
280      281      282      283

Please send to the address on my letterhead, or as I have indicated, and to my attention. (Please print your name — no literature will be sent on this coupon after April, 1951.—A. & E.)

## "AMERICAN - MARSH"

CONDENSATION UNIT

Pumping Machinery for Every Purpose

For Service Call DOuglas 2-6794 or MUtual 8322

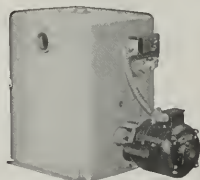

SIMONDS MACHINERY CO.

816 FRANCISCO  
54 FOLSOM

LOS ANGELES  
455 EAST 4TH

## VERMONT MARBLE COMPANY

DOMESTIC AND IMPORTED MARBLES  
GRANITE VENEER

525 MARKET STREET • SAN FRANCISCO

Phone: SUHer 1-6747

3522 COUNCIL STREET • LOS ANGELES

Phone: DUkirk 2-7831

The Most Complete Line of  
STEELS and STEEL BUILDING MATERIALS  
Made by a Single Producer



See Sweet's Catalog File or write us for full information.

REPUBLIC STEEL CORPORATION

GENERAL OFFICES: CLEVELAND, OHIO

DENVER, COLORADO . . . . . CONTINENTAL OIL BUILDING  
LOS ANGELES, CALIF. . . . . GENERAL PETROLEUM BUILDING  
SAN FRANCISCO, CALIFORNIA . . . . . RIALTO BUILDING  
SEATTLE, WASH. . . . . WHITE-HENRY-STUART BUILDING

## PACIFIC MANUFACTURING CO.

High Class Interior Finish Quality  
Millwork

16 Beale St., San Francisco  
GARfield 1-7755

2215 El Camina Real, San Mateo  
S. M. 5-0687

304 Bryant Street, Pala Alta  
P. A. 3373

2610 The Alameda, Santa Clara  
S. C. 607 (Factory)

6820 McKinley Avenue, Los Angeles  
THornwall 4196

MAIN OFFICE — SANTA CLARA

## A.I.A. ACTIVITIES

(From Page 27)

vanced Study and Research in Architecture and Related Fields, Author-fellowships or Publication Subsidies for Architectural Textbooks, Educational Sound-Movie Films, and The Octagon Library of American Architecture.

Among research projects are studies in Fire-resistant Wall Construction, Unit Wall Construction, Construction Assembly Evaluations, Corrosion of Building Materials, Acoustics, Sound Transmission and Noise Abatement, and the effect of wind on smaller structures and building elements.

### OPENS ARCHITECT OFFICE

Bernard J. Sabaroff, A.I.A., has announced the opening of offices at 1179 Market Street, San Francisco, for the general practice of architecture.

Sabaroff has been engaged in the architectural profession for a number of years in San Francisco.

### WASHINGTON ARCHITECTS BOWLING LEAGUE

Plans are being made for the 1951-52 Architects Bowling League with enlargement of the league from eight to ten teams.

Named at the annual banquet to serve as officers for the ensuing year were: Carl Forssen,

re-elected President; George A. Graham, Jr., re-elected Treasurer; and John B. Skilling, engineer for W. H. Witt Co., elected Secretary.

The team of Stuart & Durham won top honor for the season just closed.

### AWARDED THE EDWARD C. KEMPER A.I.A. RECOGNITION FOR 1950

Marshall Shaffer, chief architect of the U. S. Public Health Service was given the Edward C. Kemper Award by the American Institute of Architects at the recent annual convention.

The award is given for outstanding contributions to the architectural profession or to the Institute, and was given Shaffer in recognition of his leadership in the vast hospital construction program of the U. S. Public Health Service.

### ARCHITECT LECTURES AT ART GATHERING

Robert Anshen, A.I.A. Architect of the firm of Anshen & Allen, recently spoke before members of the San Francisco Museum on Art on the subject "The Architect and Construction."

Anshen discussed the architect's approach to the problems of designing a home or structure, and his relations to the client.

### NCC SPONSORS A.I.A. ARCHT. SCHOOL LECTURE

The Northern California Chapter of the A.I.A., and the School of Architecture of the University of California, recently sponsored a program at the San Francisco Museum of Art dealing with the subject "Philosophy of the New Architecture."

Speaker for the program was Marcel Breuer, who was introduced by William W. Wurster, Dean of the School of Architecture, University of California.

### LANDSCAPE DESIGNER GIVEN NATIONAL A.I.A. RECOGNITION

Thomas D. Church, Landscape Architect and Designer of San Francisco, was awarded the Fine Arts Medal of the American Institute of Architects at their annual meeting in Chicago, early this month.

Church has been responsible for much of the outdoor planning of the so called "Bay Region Style" houses.

Besides his extensive residential work, Church has prepared site plans, and planting plans and specifications for a number of public housing projects in San Francisco and the Bay Area.

EVERY house built by the government in its costly, socialized housing program means less critical building materials available for homes for defense workers.

*Looked into  
all these lately?*

It's growing all the time—the list of uses for which gas is superior:

Cooking	House heating
Refrigeration	Clothes drying
Water heating	Garbage disposal
All-year air conditioning	

If your technical data files are low on any of these, why not get in touch with your Gas Company for details?

*The West  
prefers*

**GAS**



**BETTER • QUICKER • CHEAPER**

# ESTIMATOR'S GUIDE

## BUILDING AND CONSTRUCTION MATERIALS

PRICES GIVEN ARE FIGURING PRICES AND ARE MADE UP FROM AVERAGE QUOTATIONS FURNISHED BY MATERIAL HOUSES TO SAN FRANCISCO CONTRACTORS. 3% SALES TAX ON ALL MATERIALS BUT NOT LABOR

All prices and wages quoted are for San Francisco and the Bay District. There may be slight fluctuation of prices in the interior and southern part of the state. Freight charge, at least, must be added in figuring country work.

**BONDS**—Performance or Performance plus Labor and Material Bond(s), \$10 per \$1000 on contract price. Labor & Material Bond(s) only, \$5.00 per \$1000 on contract price.

**BRICKWORK—MASONRY—**

Common Brick—Per 1 M laid—\$100.00 up (according to class of work).  
Face Brick—Per 1 M laid—\$200.00 and up (according to class of work).  
Brick Steps—\$3.00 and up.  
Common Brick Veneer on Frame Bldgs.—Approx. \$1.20 and up (according to class of work).  
Face Brick Veneer on Frame Bldgs.—Approx. \$2.00 and up (according to class of work).  
Common Brick—\$36.00 per M—truckload lots, delivered.  
Face Brick—\$81.00 to \$106.00 per M, truckload lots, delivered.

**Gleazed Structural Units—**

Clear Gleazed—  
2 x 4 x 12 Furring.....\$1.60 per sq. ft.  
4 x 4 x 12 Partition.....1.90 per sq. ft.  
4 x 6 x 12 Double Faced  
Partition.....2.25 per sq. ft.  
For colored glass add......30 per sq. ft.  
Mantel Fire Brick—\$105.00 per M—F.O.B. Pittsburg.

Fire Brick—Per M—\$111.00 to \$147.00.

Castings—Approx. \$10.00 per M.

Paving—\$75.00.

**Building Tile—**

8 5/8 x 12 inches, per M.....\$139.50

6 5/8 x 12 inches, per M.....105.00

4 5/8 x 12 inches, per M.....84.00

**Hollow Tile—**

12 1/2 x 2 inches, per M.....\$146.75

12 1/2 x 3 inches, per M.....156.85

12 1/2 x 4 inches, per M.....177.10

12 1/2 x 6 inches, per M.....235.30

F.O.B. Plant

**BUILDING PAPER & FELTS**

1 ply per 1000 ft. roll.....\$5.30

2 ply per 1000 ft. roll.....7.80

3 ply per 1000 ft. roll.....9.70

Brownkin, Standard 500 ft. roll.....6.85

Sisalraft, reinforced, 36 in. by 500 ft. roll.....7.00

**Sheathing Papers—**

Asphalt sheathing, 15-lb. roll.....\$2.00

30-lb. roll.....2.79

Dampcourse, 216-ft. roll.....2.95

Blue Pisterboard, 60-lb. roll.....5.10

**Felt Papers—**

Deadening felt, 3/4-lb., 50-ft. roll.....\$3.23

Asphalting felt, 1-lb.....3.79

Asphalt roofing, 15-lb.....2.00

Asphalt roofing, 30-lb.....2.79

**Roofing Papers—**

Asphalt Flg., 15-lb.....\$2.00

Standard Grade, 108-ft. roll, Light......87

Smooth Surface, Medium.....2.18

Heavy.....2.56

M. S. Extra Heavy.....2.76

**BUILDING HARDWARE—**

Sash cord com. No. 7.....\$2.65 per 100 ft.

Sash cord com. No. 8.....3.80 per 100 ft.

Sash cord spf. No. 7.....3.65 per 100 ft.

Sash cord spf. No. 8.....3.35 per 100 ft.

Sash weights, cast iron \$100.00 ton.

1-Ton lots, per 100 lbs.....\$3.75

Less than 1-ton lots, per 100 lbs.....\$4.75

Nails, per keg, base.....\$11.80

8-in. spikes.....11.80

8-in. Knob lock sets.....1.80

Butts, dull brass plated on steel, 3/8 x 3/8......76

**CONCRETE AGGREGATES—**

The following prices net to Contractors unless otherwise shown. Carload lots only.

	Bunker per ton	Del'd per ton
Gravel, all sizes.....	\$2.44	\$2.90
Top Sand.....	2.38	3.13
Concrete Mix.....	2.38	3.06
Crushed Rock, 1/4" to 3/4".....	2.38	2.90
Crushed Rock, 3/4" to 1 1/2".....	2.38	2.90
Roofing Gravel.....	2.81	2.90
River Sand.....	2.50	3.00

Sand—		
Lapis (Nos. 2 & 4).....	3.56	3.94
Olympic (Nos. 1 & 2).....	3.56	3.88

**Cement—**

Common (all brands, paper sacks), carload lots, \$3.55 per bbl. f.o.b. car; delivered \$3.60.

Per Sack, small quantity (paper).....\$1.05

Carload lots, in bulk per bbl.....2.79

Cash discount on carload lots, 10c a bbl., 10th Prov., less than carload lots \$4.00 per bbl. f.o.b. warehouse or delivered.

Cash discount 2% on L.C.L.

Trinity White	1 to 100 sacks, \$3.13 sack warehouse or del.; \$9.56 bbl. carload lots.
Madusa White	

**CONCRETE READY-MIX—**

1-2-4 mix, to 10 yards\*.....\$12.00

10 to 100\* yards.....11.00

100 to 500 yards.....10.50

Over 500 yards.....10.30

\* Delivered to site.

**CONCRETE BLOCKS—**

4x8 1/2 inches each.....\$ .17

6x8 inches, each......22

8x8 1/2 inches, each......26

12x8 1/2 inches, each......34

12x24 inches, each......60

**Haydite Aggregates—**

3/4-inch to 3/8-inch, per cu. yd.....\$7.25

3/8-inch to 1/4-inch, per cu. yd.....7.25

No. 6 to 10-inch, per cu. yd.....7.25

**DAMP-PROOFING and Waterproofing—**

Two-coat work, \$9.00 per square.

Membrane waterproofing—4 layers of saturated felt, \$10.00 per square.

Hot coating work, \$5.00 per square.

Madusa Waterproofing, \$3.50 per lb. San Francisco Warehouse.

Tricoat concrete waterproofing, 60c a cubic yd. end up.

**ELECTRIC WIRING—\$15 to \$20 per outlet for conduit work (including switches).**

Knob end tube average \$6.00 per outlet.

**ELEVATORS—**

Prices vary according to capacity, speed end type. Consult elevator companies. Average cost of installing a slow speed automatic passenger elevator in small four story apartment building, including entrance doors, about \$9,500.00.

**EXCAVATION—**

Send, \$1.00; clay or shale, \$1.50 per yard.

Trucks, \$30 to \$45 per day.

Above figures are an average without water. Steam shovel work in large quantities, less; hard material, such as rock, will run considerably more.

**FIRE ESCAPES—**

Ten-foot galvanized iron balcony, with stairs, \$250 installed on new buildings; \$300 on old buildings.

**FLOORS—**

Asphalt Tile, 1/8 in. gauge 18c to 35c per sq. ft.

Composition Floors, such as Magnesite, 50c per square foot.

Linoleum, standard gauge, sq. yd.....\$2.75

Mastipave—\$1.50 per sq. yd.

Battleship Linoleum—1/8"—\$3.00 sq. yd.

Terazzo Floors—\$1.50 per sq. ft.

Terazzo Steps—\$2.50 per lin. ft.

Mastic Wear Coat—according to type—20c to 35c.

**Hardwood Flooring—**

Oak Flooring—T & G—Unfin—

Clear Old, White.....\$12 1/4

Clear Old, Red.....405

Clear Pine, Red or White.....355

Select Pine, Red or White.....340

#1 Common, Red or White.....315

#2 Common, Red or White.....305

Prime Standard

1/2 x 2.....\$369.00

1/2 x 2 1/2.....380.00

4 1/2 x 2 1/4.....390.00

8 1/2 x 3 1/4.....375.00

3 1/2 x 2 1/4 Ranch Plank.....415.00

**Unfinished Maple Flooring—**

3 1/2 x 2 1/4 First Grade.....\$390.00

3 1/2 x 2 1/4 2nd Grade.....365.00

3 1/2 x 2 1/4 2nd & Btr. Grade.....375.00

3 1/2 x 2 1/4 3rd Grade.....240.00

3 1/2 x 3 1/4 3rd & Btr. Jtd. EM.....390.00

3 1/2 x 3 1/4 2nd & Btr. Jtd. EM.....390.00

3 1/2 x 2 1/4 First Grade.....400.00

3 1/2 x 2 1/4 2nd Grade.....360.00

3 1/2 x 2 1/4 3rd Grade.....370.00

Floor Layer Wage \$2.50 hr.

**GLASS—**

Single Strength Window Glass.....\$ .30 per sq. ft.

Double Strength Window Glass......45 per sq. ft.

Plate Glass, 1/4 polished to 75.....1.60 per sq. ft.

75 to 100.....1.74 per sq. ft.

1/4 in. Polished Wire Plate Glass.....2.35 per sq. ft.

1/4 in. Rgh. Wire Glass......71 per sq. ft.

1/4 in. Polished Wire Plate Glass.....2.00 per sq. ft.

1/4 in. Rgh. Wire Glass......44 per sq. ft.

1/8 in. Obscure Glass......40 per sq. ft.

1/8 in. Obscure Glass......44 per sq. ft.

1/8 in. Heat Absorbing Obscure......58 per sq. ft.

1/4 in. Heat Absorbing......86 per sq. ft.

Glazing of above additional \$1.15 to 3.00 per sq. ft.

Glass Blocks, set in place.....3.50 per sq. ft.

**HEATING—**

Average, \$3.50 to \$4.00 per sq. ft. of radiation, according to conditions.

Warm air (gravity) average \$64 per register.

Forced air average \$91 per register.



## INSULATION AND WALLBOARD—

Rockwool Insulation—	
(2") Less than 1,000 sq. ft.	\$64.00
(2") Over 1,000 sq. ft.	\$9.00
Cotton Insulation—Full thickness (3 3/4")	\$95.50 per M sq. ft.
Station Aluminum Insulation—Aluminum coated on both sides	\$23.50 per M sq. ft.
Tileboard—1/8" panel	\$9.00 per panel
Wallboard—1/2" thickness	\$55.00 per M sq. ft.
Finishing Plank	\$49.00 per M sq. ft.
Ceiling Tileboard	\$69.00 per M sq. ft.

**IRON**—Cost of ornamental iron, cast iron, etc., depends on designs.

## LUMBER—

S4S No. 2 and better common O.P. or D.F., per M, f.b.m.	\$100.00
Rough, No. 2 common O.P. or D.F., per M, f.b.m.	100.00

## Flooring—

Per M Delvd.	
V.G.-D.F. 8 & 8tr. 1 x 4 T & G Flooring	\$25.00
"C" and better—all	\$22.00
"D" and better—all	\$25.00
Rwd. Rustic—"A" grade, medium dry 8 to 24 ft.	185.00

Plywood, per M sq. ft.	
1/4-inch, 4,0x8,0 S15	\$170.00
1/2-inch, 4,0x8,0 S15	250.00
3/4-inch, per M sq. ft.	315.00
Phycord	11 1/2¢ per ft.
Phylform	25¢ per ft.

## Shingles (Rwd. not available)—

Red Cedar No. 1—\$9.50 per square; No. 2, \$7.00; No. 3, \$5.00.	
Average cost to lay shingles, \$6.00 per square.	
Cedar Shakes—1/2" to 3/4" x 24/26 in handsplit tapered or split resawn, per square	\$15.25
3/4" to 1 1/4" x 24/26 in split resawn, per square	17.00
Average cost to lay shakes, \$8.00 per square	
Pressure Treated Lumber—	
Volminized	Add \$35 per M to above
Crested, 8-in. treatment	Add \$45 per M to above

## MARBLE—(See Dealers)

## METAL LATH EXPANDED—

Standard Diamond, 3,40, Copper Bearing, LCL, per 100 sq. yds.	\$43.50
Standard Ribbed, ditto	\$47.50

## MILLWORK—Standard.

D. F. \$150 per 1,000, R. W. Rustic \$175 per 1,000 (delivered).	
Double hung bow window frames, average with trim, \$12.50 to up, each.	
Complete door unit, \$15 to \$25.	
Screen doors, \$8.00 to \$12.00 each.	
Patent screen windows, \$1.25 a sq. ft.	
Cases for kitchen pantries seven ft. high, per lineal ft., upper \$9.00 to \$11.00; lower \$12.00 to \$13.00.	
Dining room cases, \$20.00 per lineal foot. Rough and finish about \$1.00 per sq. ft.	
Labor—Rough carpentry, warehouse heavy framing (average), \$75.00 per M.	
For smaller work average, \$85.00 to \$100. per 1,000.	

## PAINTING—

Two-coat work	per yard	85¢
Three-coat work	per yard	\$1.10
Cold water painting	per yard	25¢
Whitewashing	per yard	15¢
Linseed Oil, Strictly Pure	Wholesale	
(Basis 7 1/2 lbs. per gal.)	Raw	Boiled
Light iron drums	per gal.	\$2.28
5-gallon cans	per gal.	2.46
1-gallon cans	each	2.52
Quart cans	each	.71
Pint cans	each	.38
1/2-pint cans	each	.24
Turpentine	Pure Gum	
(Basis, 7.2 lbs. per gal.)	Spirits	
Light iron drums	per gal.	\$1.65
5-gallon cans	per gal.	1.76
1-gallon cans	each	1.88
Quart cans	each	.54
Pint cans	each	.31
1/2-pint cans	each	.20

## Pioneer White Lead in Oil Heavy Paste and

All - Purpose (Soft - Paste)					
Net Weight	per 100	Pr. per	100	Pr. per	100
Packages	lbs.	pkgs.	lbs.	pkgs.	
50-lb. kegs	\$28.35	\$29.35	\$27.50	\$27.50	
50-lb. kegs	30.05	15.03	28.15	15.08	
25-lb. kegs	30.35	7.59	28.45	7.12	
5-lb. cans	33.35	1.34	31.25	1.25	
1-cant.	36.00	3.6	33.75	3.4	
500 lbs. (on delivery)	3/4¢	per pound	less than	above.	
*Heavy Paste only.					

## Pioneer Dry White Lead—Litharge—Dry Red Lead—Red Lead in Oil

Price to Painters—Price	per 100	Pounds
	100	25
Products	lbs.	lbs.
Dry White Lead	\$24.30	
Litharge	25.95	26.60
Dry Red Lead	27.20	27.85
Red Lead in Oil	30.65	31.30
Pound cans, \$37 per lb.		

## PATENT CHIMNEYS—

6-inch	\$2.50	lineal foot
8-inch	3.00	lineal foot
10-inch	4.00	lineal foot
12-inch	5.00	lineal foot

## PLASTER—

Neat wall, per ton delivered in S. F. in paper bags, \$17.60.

## PLASTERING (Interior)—

3 Coats, metal lath and plaster	3.00
Kearce cement on metal lath	\$3.50
Ceilings with 3/4" hot roll channels metal lath (lathed only)	3.00
Ceilings with 3/4" hot roll channels metal lath plastered	4.50
Single partition 3/4" channel lath 1 side (lath only)	3.00
Single partition 3/4" channel lath 2 inches thick plastered	8.00
4-inch double partition 3/4" channel lath 2 sides (lath only)	5.75
4-inch double partition 3/4" channel lath 2 sides plastered	8.75
Thermax single partition; 1" channels; 2 1/4" overall partition width. Plastered both sides	7.50
Thermax double partition; 1" channels; 4 1/4" overall partition width. Plastered both sides	11.00
3 Coats over 1" Thermax nailed to one side wood studs or joists	4.50
3 Coats over 1" Thermax suspended to one side wood studs with spring sound isolation clip	5.00
Note—Channel lath controlled by limitation orders.	

## PLASTERING (Exterior)—

2 coats cement finish, brick or concrete wall	\$2.50
3 coats cement finish, No. 18 gauge wire mesh	3.50
Lime—\$4.00 per bbl. at yard.	
Processed Lime—\$4.15 per bbl. at yard.	
Rock or Grip Lath—3/4"—30¢ per sq. yd.	
"A"—29¢ per sq. yd.	
Composition Stucco—\$4.00 sq. yard (applied).	

## PLUMBING—

From \$200.00 per fixture up, according to grade, quality and runs.

## ROOFING—

"Standard" tar and gravel, 4 ply—\$11.00 per sq. for 30 sqs. or over.	
Less than 30 sqs. \$14.00 per sq.	
Tile \$40.00 to \$50.00 per square.	
No. 1 Redwood Shingles in place, 4 1/2" in. exposure, per square	\$18.25
5/2 No. 1 Cedar Shingles, 5 in. exposure, per square	14.50
5/8 x 16"—No. 1 Little Giant Cedar Shingles, 5" exposure, per square	18.25

4/2 No. 1-24" Royal Cedar Shingles 7 1/2" exposure, per square	23.00
Re-coat with Gravel \$5.50 per sq.	
Asbestos Shingles, \$27 to \$35 per sq. laid 1/2 to 3/4 x 25" Resawn Cedar Shakes, 10" Exposure	\$30.00
3/4 to 1 1/4 x 25" Resawn Cedar Shakes, 10" Exposure	\$35.00
1 x 25" Resawn Cedar Shakes, 10" Exposure	27.00
Above prices are for shakes in place	

## SEWER PIPE—

C.I. 6-in. to 24-in. B. & S. Class B and heavier, per ton	\$99.50
Vitrified, per foot: L.C.L. F.O.B. Ware house, San Francisco.	
Standard, 8-in.	\$.66
Standard, 12-in.	1.30
Standard, 24-in.	5.41
Clay Drain Pipe, per 1,000 L.F.	
L.C.L., F.O.B. Warehouse, San Francisco	
Standard, 6-in. per M.	\$240.00
Standard, 8-in. per M.	400.00

## SHEET METAL—

Windows—Metal, \$2.50 a sq. ft. Fire doors (average), including hardware \$2.80 per sq. ft., size 12'x12'. \$3.75 per sq. ft., size 3'x6'.

## SKYLIGHTS—(not glazed)

Copper, \$1.25 sq. ft. (flat). Galvanized iron, 65¢ sq. ft. (flat). Vented hip skylights, \$1.50 sq. ft.

## STEEL—STRUCTURAL—

\$220 per ton erected, when out of mill. \$270 per ton erected, when out of stock.

## STEEL REINFORCING—

\$200.00 per ton, in place.	
1/4-in. Rd. (Less than 1 ton)	\$8.40
3/8-in. Rd. (Less than 1 ton)	7.30
1/2-in. Rd. (Less than 1 ton)	7.00
5/8-in. Rd. (Less than 1 ton)	6.75
3/4-in. & 7/8-in. Rd. (Less than 1 ton)	6.65
1-in. & up (Less than 1 ton)	6.60
1 ton to 5 tons, deduct 25¢.	

## STORE FRONTS (None available)

## TILE—

Ceramic Tile Floors—Commercial \$1.20 to \$1.60 per sq. ft.	
Cove Base—\$1.40 per lin. ft.	
Quarry Tile Floors, 6x6" with 6" base @ \$1.35 per sq. ft.	
Tile Wainscots & Floors, Residential, 4 1/4 x 4 1/4", 7" tile, \$1.65 to \$2.00 per sq. ft.	
Tile Wainscots, Commercial Jobs, 4 1/4 x 4 1/4", Tile, @ \$1.50 to \$1.65 per sq. ft.	
Asphalt Tile Floor 1/4" thick @ \$.18 - \$.35 sq. yd. Light shades shatter resistant.	
Cork Tile—\$.70 per sq. ft.	
Mosaic Floor—See orders.	
Lino Tile—\$1.00 per sq. ft.	
Rubber Tile—\$.55 to \$.75 per sq. ft.	

## Building Tile—

6x5 1/2-inches, per M.	\$139.50
6x5 1/2-inches, per M.	105.00
4x5 1/2-inches, per M.	84.00
Hollow Tile—	
12x12 1/2-inches, per M.	\$146.75
12x12 1/2-inches, per M.	155.85
12x12 1/2-inches, per M.	177.10
12x12 1/2-inches, per M.	235.30
F.O.B. Plant	

## VENETIAN BLINDS—

75¢ per square foot and up. Installation extra.

## WINDOWS—STEEL—INDUSTRIAL

Cost depends on design and quality required.

# ARCHITECT AND ENGINEER ESTIMATOR'S DIRECTORY

## Building and Construction Materials

EXPLANATION—Building and construction materials are shown in major classified groups for general identification purposes with names and addresses of suppliers of materials listed in detail under group classification where name first appears—main offices are shown first with branch or district offices following. The numeral appearing in listings refers to the major group classification where complete data on the dealer, or representative, may be found.

### AIR CONDITIONING (1b)

Air Conditioning & Cooling  
UTILITY APPLIANCE CORP.  
Los Angeles 58, 4851 S. Alameda St.  
San Francisco, 1355 Market St., UN 1-4908

### ARCHITECTURAL VENEER (a)

Ceramic Veneer  
PACIFIC CLAY PRODUCTS  
San Francisco: 605 Market St., GA 1-3970  
Los Angeles, Portland, Salt Lake City  
GLADDING, McBEAN & CO. \*(1)

### Porcelain Veneer

PORCELAIN ENAMEL PUBLICITY BUREAU  
(Dept. AE-450)  
Room 601, Franklin Building, Oakland 12, California  
P. O. Box 186, East Pasadena Station, Pasadena 8,  
California

### Granite Veneer

VERMONT MARBLE COMPANY  
San Francisco 5: 525 Market Street, SU 1-6747  
Los Angeles 4: DU 2-7834

### Marble Veneer

VERMONT MARBLE COMPANY  
San Francisco 5: 525 Market Street, SU 1-6747  
Los Angeles 4: DU 2-7834

### BANKS-FINANCING (1b)

CROCKER FIRST NATIONAL BANK OF S. F.  
San Francisco, Post & Montgomery St's., EX 2-7700

### BRASS PRODUCTS (1a)

GREENBERG'S, M. & SONS  
San Francisco, Calif.: 765 Folsom, EXbrook 2-3143

### BRICKWORK (1)

Face Brick  
GLADDING, McBEAN & CO.  
San Francisco: Harrison at 9th Sts., UN 1-7400  
Los Angeles: 2901 Los Feliz Blvd., OL 2121  
Offices at Portland, Seattle, Spokane  
KRAFTLE  
Niles, California, Niles 3611  
San Francisco 5: 50 Hawthorne St., DO 2-3780  
Los Angeles 13: 406 South Main St., MU 7241  
REMILLARD-DANDINI CO.  
San Francisco: 400 Montgomery St., EX 2-4988

### BRONZE PRODUCTS (1b)

GREENBERG'S M. & SONS  
San Francisco, Calif.: 765 Folsom, EXbrook 2-3143

### BUILDING PAPER & FELTS (2)

SISALKRAFT COMPANY  
San Francisco: 55 New Montgomery St., EX 2-3066  
Chicago, Ill.: 205 West Wacker Drive  
ANGIER PACIFIC CORP.  
San Francisco 5: 55 New Montgomery St., DO 2-4416  
Los Angeles: 7424 Sunset Boulevard

### BUILDING HARDWARE (3)

THE STANLEY WORKS  
San Francisco: Monadhock Bldg., YU 6-5914  
New Britain, Conn.

### CEMENT (c)

PACIFIC PORTLAND CEMENT  
San Francisco: 417 Montgomery St., GA 1-4100

### CONCRETE AGGREGATES (4)

Lightweight Aggregates  
AMERICAN PERLITE CORP.  
Richmond, Calif.: 26th & B Sts.—Yard 2, RI 4307

### DOORS (4a)

Hollywood Doors  
WEST COAST SCREEN CO.  
Los Angeles: 1127 E. 63rd St. AD 1-1108  
Distributors:

W. P. FULLER CO.  
Seattle, Tacoma, Portland  
NICKOLI DOOR SALES CO.  
San Francisco: 3045 19th St.  
F. M. COBB CO.  
Los Angeles: & San Pedro

SOUTHWEST SASH & DOOR  
Phoenix, Arizona  
HOUSTON SASH & DOOR  
Houston, Texas

### Screen Doors

WEST COAST SCREEN CO.  
(See Hollywood Door listing above)

### FIRE ESCAPES (5)

SOULE STEEL  
San Francisco: 1750 Army St., VA 4-4141  
Los Angeles, Calif.—LA 0911  
Portland, Ore.—BE 5155  
Seattle, Wash.—SE 3010  
MICHAEL & PFEFFER IRON WORKS, INC.  
San Francisco 3: Tenth & Harrison Sts.,  
MA 1-5966

### FIREPLACES (5a)

Heat Circulating  
SUPERIOR FIREPLACE CO.  
Los Angeles: 1708 E. 15th St. PR 8393  
Baltimore, Md.: 601 No. Point Rd.

### FLOORS (6)

Hardwood Flooring  
HOGAN LUMBER COMPANY  
Oakland: Second and Alice Sts., GL 1-6861  
E. K. WOOD LUMBER CO.  
Los Angeles: 4710 S. Alameda St., JE 3111  
Oakland: 727 Terminal St., KE 4-8466  
Portland: 827 Terminus Sales Building  
Floor Treatment & Maintenance  
HILLYARD SALES CO. (Western)  
470 Alabama St., San Francisco, MA 1-2756  
Los Angeles: 923 E. 3rd, Trinity 8282  
Seattle, 3440 E. Marginal Way

### GLASS (7)

W. P. FULLER COMPANY  
San Francisco: 301 Mission St., EX 2-7151  
Los Angeles, Calif.  
Portland, Oregon

### HEATING (8)

HENDERSON FURNACE & MFG. CO.  
Sebastopol, Calif.  
S. T. JOHNSON CO.  
Oakland 8: 940 Arlington Ave., OL 2-6000  
San Francisco: 585 Potrero Ave., MU 1-2757  
Philadelphia 8, Pa.: 401 No. Broad St.

### SCOTT COMPANY

San Francisco: 243 Minna St., YU 2-0400  
Oakland: 113 - 10th St., GL 1-1937  
San Jose, Calif.  
Los Angeles, Calif.  
ELECTROMODE CORPN. (Distributors)  
San Francisco, 1201 Bryant St., UN 3-4000  
Emeryville, 5400 Hollis St., OL 3-4433  
Sacramento, 1131 S St., GI 3-9001  
Fresno, 1234 O St., Fresno 4-4746  
Redding, 2146 Pine St., Redding 200  
THOMAS B. HUNTER (Designer)  
San Francisco: 41 Sutter St., GA 1-1164  
UTILITY APPLIANCE CORP. \*(b)

### INSULATION AND WALLBOARD (9)

LUMBER MANUFACTURING CO.  
San Francisco: 225 Industrial Ave., JU 7-1760  
SISALKRAFT COMPANY \*(2)

### WESTERN ASBESTOS COMPANY

San Francisco: 675 Townsend St., KL 2-3868  
Oakland: 251 Fifth Avenue, GL 1-2345  
Sacramento: 1224 I Street, 2-8993  
Stockton: 1120 E. Weber Ave., 4-1863  
Fresno: 1837 Merced Street, 3-3277  
San Jose: 201 So. Market St., BA 4359-J

### IRON—Ornamental (10)

MICHEL & PFEFFER IRON WORKS, INC. \*(5)

### LANDSCAPE (11a)

Landscape Contractors  
HENRY C. SOTO CORPN.  
Los Angeles, 13000 S. Avalon Blvd. ME 4-6617

### LIGHTING FIXTURES (11)

SMOOTH-HOLMAN COMPANY  
Inglewood, Calif., OR 8-1217  
San Francisco: 55 Mississippi St., MA 1-8474

### LUMBER (12)

HOGAN LUMBER COMPANY \*(6)  
LUMBER MANUFACTURING CO. \*(9)  
E. K. WOOD LUMBER CO \*(6)

### Shingles

SIDEWALL LUMBER COMPANY  
San Francisco 24: 1995 Oakdale Ave., AT 2-8112

### MARBLE (13)

VERMONT MARBLE COMPANY  
San Francisco: 525 Market St., SU 1-6747  
Los Angeles 4: 3522 Council St., DU 2-7834

### METAL LATH EXPANDED (14)

FORDERER CORNICE WORKS  
San Francisco: 269 Potrero Ave., HE 1-4100  
SOULE STEEL \*(5)

### MILLOWK (15)

PACIFIC MANUFACTURING COMPANY  
San Francisco: 16 Beale St., GA 1-7755  
Santa Clara: 2610 The Alameda, SC 607  
Los Angeles: 6820 McKinley Ave., TH 4196  
MULLEN MANUFACTURING COMPANY  
San Francisco: 60-80 Rausch St., UN 1-5815  
LUMBER MANUFACTURING COMPANY \*(9)

### PAINTING (16)

Paint  
W. P. FULLER COMPANY \*(7)

### PLASTER (17)

Exteriors  
PACIFIC PORTLAND CEMENT COMPANY \*(4)  
Interiors—Metal Lath & Trim  
FORDERER CORNICE WORKS \*(14)

### PLASTIC CEMENT (f)

PACIFIC PORTLAND CEMENT CO.  
San Francisco: 417 Montgomery St., GA 1-4100

### PLUMBING (18)

THE SCOTT COMPANY \*(8)  
THE HALSEY TAYLOR COMPANY  
Redlands, Calif.  
Warren, Ohio  
HAWS DRINKING FAUCET COMPANY  
Berkeley 10: 1435 Fourth St., LA 5-3341  
CONTINENTAL WATER HEATER COMPANY  
Los Angeles 31: 1801 Pasadena Ave., CA 6178  
SIMONDS MACHINERY COMPANY  
San Francisco: 816 Folsom St., DU 2-6794  
Los Angeles: 455 East 4th St., MO 8322  
SECURITY VALVE COMPANY  
Los Angeles 31: 410 San Fernando Rd., CA 6191

**SEWER PIPE (19)**

GLADDING, McBEAN & CO. \*(1)  
 KRAFTILE CLAY PRODUCTS  
 San Francisco: 605 Market St., GA 1-3970  
 Los Angeles, Portland, Salt Lake City

**SHEET METAL (20)****Windows**

DETROIT STEEL PRODUCTS COMPANY  
 Oakland 8: 1310 - 63rd St., OL 2-8826  
 San Francisco: Russ Building, DO 2-0890

MICHEL & PFEFFER IRON WORKS, INC. \*(5)  
 SOULE STEEL COMPANY \*(5)

**Fire Doors**

DETROIT STEEL PRODUCTS COMPANY

**Skylights**

DETROIT STEEL PRODUCTS COMPANY

**STEEL—STRUCTURAL (21)****COLUMBIA STEEL CO.**

San Francisco: Russ Bldg., SU 1-2500  
 Los Angeles: 2087 E. Slauton, LA 1171  
 Portland: 2345 N. W. Nicolai, BE 7261  
 Seattle: 1331 3rd Ave. Bldg., MA 1972  
 Salt Lake City: Walker Bank Bldg., SL 3-6733  
 HERRICK IRON WORKS  
 Oakland: 18th & Campbell Sts., GL 1-1677  
 JUDSON PACIFIC-MURPHY CORP.  
 Emeryville: 4300 Eastshore Highway, OL 3-1717  
 REPUBLIC STEEL CORP.  
 San Francisco: 116 N. Montgomery St., GA 1-0977  
 Los Angeles: Edison Building  
 Seattle: White-Henry-Stuart Building

Salt Lake City: Walker Bank Building

Denver: Continental Oil Building  
 KRAFTILE COMPANY \*(1)  
 SAN JOSE STEEL COMPANY  
 San Jose: 195 North Thirtieth St., CO 4184

**STEEL—REINFORCING (22)**

REPUBLIC STEEL CORP. \*(21)  
 HERRICK IRON WORKS \*(21)  
 SAN JOSE STEEL CO. \*(21)  
 COLUMBIA STEEL CO. \*(21)

**TILE (23)**

GLADDING, McBEAN & CO. \*(11)  
 KRAFTILE COMPANY \*(11)  
 PACIFIC CLAY PRODUCTS  
 San Francisco: 605 Market St., GA 1-3970  
 Los Angeles, Portland, Salt Lake City

**TIMBER—REINFORCING (b)****Trusses**

WEYERHAEUSER SALES CO.  
 Tacoma, Wash.  
 St. Paul, Minn.  
 Newark, N. J.  
 Treated Timber  
 J. H. BAXTER CO.  
 San Francisco 4: 333 Montgomery St., DO 2-3883  
 Los Angeles 13: 601 West Fifth St., MI 6294

**WALL TILE (24)**

GLADDING, McBEAN & CO. \*(11)  
 KRAFTILE COMPANY \*(11)

**WINDOWS STEEL (25)**

DETROIT STEEL PRODUCTS CO. \*(20)  
 MICHEL & PFEFFER IRON WORKS, INC. \*(5)  
 SOULE STEEL COMPANY \*(5)

**GENERAL CONTRACTORS (26)**

DINWIDDIE CONSTRUCTION COMPANY  
 San Francisco: Crocker Building, YU 6-2718  
 CLINTON CONSTRUCTION COMPANY  
 San Francisco: 923 Folsom St., SU 1-3440  
 MATCOCK CONSTRUCTION COMPANY  
 San Francisco: 604 Mission St., GA 1-5516  
 PARKER, STEFFENS & PEARCE  
 San Francisco: 135 So. Park, EX 2-6639  
 STOLTE, INC.  
 Oakland: 8451 San Leandro Blvd., TR 2-1064  
 SWINERTON & WALBERG COMPANY  
 San Francisco: 225 Bush St., GA 1-2980  
 Oakland: 1723 Webster St., HI 4-4322  
 Los Angeles: Sacramento, Danver  
 P. J. WALKER COMPANY  
 San Francisco: 391 Sutter St., YU 6-5916  
 Los Angeles: 3920 Whitehite St., AN 9-8567

**TESTING LABORATORIES**

(ENGINEERS & CHEMISTS) (27)  
 ABBOT A. HANKS, INC.  
 San Francisco: 624 Sacramento St., GA 1-1697  
 ROBERT W. HUNT COMPANY  
 San Francisco: 251 Kearny St., EX 2-4634  
 Los Angeles: 3050 E. Slauton, JE 9131  
 Chicago, New York, Pittsburgh  
 PITTSBURGH TESTING LABORATORY  
 San Francisco: 651 Howard St., EX 2-1747

**BUILDING TRADES WAGE (JOB SITES) NORTHERN, CENTRAL AND SOUTHERN CALIFORNIA**

ATTENTION: The following are the PREVALING hourly rates of compensation being paid and in effect by employers by agreement between employees and their union; or as recognized and determined by the U. S. Department of Labor. (Revised to March 1, 1951.)

CRAFT	San Francisco		Alameda		Costa		Fresno		Sacramento		San Joaquin		San Clara		Solano		Santa		Angelas		San Bernardino		San Barbara		Kern	
	\$2.50	\$2.50	\$2.50	\$2.50	\$2.50	\$2.50	\$2.50	\$2.50	\$2.50	\$2.50	\$2.50	\$2.50	\$2.50	\$2.50	\$2.50	\$2.50	\$2.50	\$2.50	\$2.50	\$2.50	\$2.50	\$2.50	\$2.50	\$2.50	\$2.50	
ASBESTOS WORKERS	2.50	2.50	2.50	2.50	2.50	2.50	2.50	2.50	2.50	2.50	2.50	2.50	2.50	2.50	2.50	2.50	2.50	2.50	2.50	2.50	2.50	2.50	2.50	2.50	2.50	
BOILERMAKERS	2.53	2.53	2.53	2.53	2.53	2.53	2.53	2.53	2.53	2.53	2.53	2.53	2.53	2.53	2.53	2.53	2.53	2.53	2.53	2.53	2.53	2.53	2.53	2.53	2.53	
BRICKLAYERS	3.25**	3.15*	3.15	2.85	3.25	3.00	3.00	3.00	3.00	3.25	2.45	2.45	2.45	2.45	2.45	2.45	2.45	2.45	2.45	2.45	2.45	2.45	2.45	2.45	2.45	
BRICKLAYERS, HODCARRIERS	2.45	2.45	2.45	2.45	2.45	2.45	2.45	2.45	2.45	2.45	2.45	2.45	2.45	2.45	2.45	2.45	2.45	2.45	2.45	2.45	2.45	2.45	2.45	2.45	2.45	
CARPENTERS	2.325	2.325	2.175	2.175	2.175	2.175	2.175	2.175	2.175	2.175	2.175	2.175	2.175	2.175	2.175	2.175	2.175	2.175	2.175	2.175	2.175	2.175	2.175	2.175	2.175	
CEMENT FINISHERS	2.20	2.20	2.20	2.20	2.20	2.20	2.20	2.20	2.20	2.20	2.20	2.20	2.20	2.20	2.20	2.20	2.20	2.20	2.20	2.20	2.20	2.20	2.20	2.20	2.20	
ELECTRICIANS	2.75	2.40	2.40	2.75	2.50	2.50	2.425	2.40	2.50	2.50	2.425	2.40	2.50	2.50	2.50	2.50	2.50	2.50	2.50	2.50	2.50	2.50	2.50	2.50	2.50	
ELEVATOR CONSTRUCTORS	2.75	2.75	2.75	2.75	2.75	2.75	2.75	2.75	2.75	2.75	2.75	2.75	2.75	2.75	2.75	2.75	2.75	2.75	2.75	2.75	2.75	2.75	2.75	2.75	2.75	
ENGINEERS: MATERIAL HOIST	1.19	2.19	2.19	2.19	2.19	2.19	2.19	2.19	2.19	2.19	2.19	2.19	2.19	2.19	2.19	2.19	2.19	2.19	2.19	2.19	2.19	2.19	2.19	2.19	2.19	
GLAZIERS	2.30	2.30	2.30	2.30	2.30	2.30	2.30	2.30	2.30	2.30	2.30	2.30	2.30	2.30	2.30	2.30	2.30	2.30	2.30	2.30	2.30	2.30	2.30	2.30	2.30	
IRONWORKERS: ORNAMENTAL	2.425	2.425	2.425	2.425	2.425	2.425	2.425	2.425	2.425	2.425	2.425	2.425	2.425	2.425	2.425	2.425	2.425	2.425	2.425	2.425	2.425	2.425	2.425	2.425	2.425	
IRONWORKERS: REINF. ROOMEN	2.375	2.375	2.375	2.375	2.375	2.375	2.375	2.375	2.375	2.375	2.375	2.375	2.375	2.375	2.375	2.375	2.375	2.375	2.375	2.375	2.375	2.375	2.375	2.375	2.375	
IRONWORKERS: STRUCTURAL	2.575	2.575	2.575	2.575	2.575	2.575	2.575	2.575	2.575	2.575	2.575	2.575	2.575	2.575	2.575	2.575	2.575	2.575	2.575	2.575	2.575	2.575	2.575	2.575	2.575	
LABORERS: BUILDING	1.65	1.65	1.65	1.65	1.65	1.65	1.65	1.65	1.65	1.65	1.65	1.65	1.65	1.65	1.65	1.65	1.65	1.65	1.65	1.65	1.65	1.65	1.65	1.65	1.65	
LABORERS: CONCRETE	1.65	1.65	1.65	1.65	1.65	1.65	1.65	1.65	1.65	1.65	1.65	1.65	1.65	1.65	1.65	1.65	1.65	1.65	1.65	1.65	1.65	1.65	1.65	1.65	1.65	
LATHERS	3.00	3.00*	3.00*	2.75	2.975	2.75	2.975	2.75	2.975	2.75	2.975	2.75	2.975	2.75	2.975	2.75	2.975	2.75	2.975	2.75	2.975	2.75	2.975	2.75	2.975	
MARBLE SETTERS	2.60	2.60	2.60	2.60	2.60	2.60	2.60	2.60	2.60	2.60	2.60	2.60	2.60	2.60	2.60	2.60	2.60	2.60	2.60	2.60	2.60	2.60	2.60	2.60	2.60	
MOSAIC & TERRAZZO	2.375	2.375	2.375	2.375	2.375	2.375	2.375	2.375	2.375	2.375	2.375	2.375	2.375	2.375	2.375	2.375	2.375	2.375	2.375	2.375	2.375	2.375	2.375	2.375	2.375	
PAINTERS	2.45**	2.45	2.45	2.15	2.45	2.45	2.275	2.45	2.275	2.45	2.45	2.45	2.45	2.45	2.45	2.45	2.45	2.45	2.45	2.45	2.45	2.45	2.45	2.45	2.45	
PILEDRIVERS	2.325	2.325	2.325	2.325	2.325	2.325	2.325	2.325	2.325	2.325	2.325	2.325	2.325	2.325	2.325	2.325	2.325	2.325	2.325	2.325	2.325	2.325	2.325	2.325	2.325	
PLASTERERS	3.00	3.15*	3.15	2.75	3.00	3.00	3.125	3.00*	3.00*	3.00*	3.00*	3.00*	3.00*	3.00*	3.00*	3.00*	3.00*	3.00*	3.00*	3.00*	3.00*	3.00*	3.00*	3.00*	3.00*	
PLASTERERS, HODCARRIERS	2.60	2.80	2.80	2.50	2.40	2.50	2.40	2.50	2.40	2.50	2.40	2.50	2.40	2.50	2.40	2.50	2.40	2.50	2.40	2.50	2.40	2.50	2.40	2.50	2.40	
PLUMBERS	2.425	2.425	2.425	2.425	2.425	2.425	2.425	2.425	2.425	2.425	2.425	2.425	2.425	2.425	2.425	2.425	2.425	2.425	2.425	2.425	2.425	2.425	2.425	2.425	2.425	
ROOFERS	2.50	2.50	2.50	2.50	2.50	2.50	2.50	2.50	2.50	2.50	2.50	2.50	2.50	2.50	2.50	2.50	2.50	2.50	2.50	2.50	2.50	2.50	2.50	2.50	2.50	
SHEET METAL WORKERS	2.3125	2.3125	2.3125	2.40	2.50	2.375	2.3125	2.375	2.3125	2.375	2.3125	2.375	2.3125	2.375	2.3125	2.375	2.3125	2.375	2.3125	2.375	2.3125	2.375	2.3125	2.375	2.3125	
SPRINKLER FITTERS	2.625	2.625	2.625	2.625	2.625	2.625	2.625	2.625	2.625	2.625	2.625	2.625	2.625	2.625	2.625	2.625	2.625	2.625	2.625	2.625	2.625	2.625	2.625	2.625	2.625	
STEAMFITTERS	2.625	2.625	2.625	2.625	2.625	2.625	2.625	2.625	2.625	2.625	2.625	2.625	2.625	2.625	2.625	2.625	2.625	2.625	2.625	2.625	2.625	2.625	2.625	2.625	2.625	
TRUCK DRIVERS—1/2 Ton or less	1.58	1.58	1.58	1.58	1.58	1.58	1.58	1.58	1.58	1.58	1.58	1.58	1.58	1.58	1.58	1.58	1.58	1.58	1.58	1.58	1.58	1.58	1.58	1.58	1.58	
TILESETTERS	2.875	2.875	2.875	2.50	2.875	2.425	2.875	2.425	2.875	2.425	2.875	2.425	2.875	2.425	2.875	2.425	2.875	2.425	2.875	2.425	2.875	2.425	2.875	2.425	2.875	

\* 4 Hour Day, \*\* 7 Hour Day.

Prepared and compiled by:

CENTRAL CALIFORNIA CHAPTER, ASSOCIATED GENERAL CONTRACTORS OF AMERICA, with the assistance and cooperation of secretaries of General Contractors Association and Builders Exchange of Northern California; and the above information for southern California is furnished by the Labor Relations Department of the Southern California Chapter, ASSOCIATED GENERAL CONTRACTORS OF AMERICA.

# CLASSIFIED ADVERTISING

RATE: 20c PER WORD . . . CASH WITH ORDER

MINIMUM \$5.00

**PLANNING CHURCH BUILDINGS.** Portfolio—64 oversized pages 144 cuts; floor plans, exterior and interior views; recently planned buildings costing \$30,000 upward. Largest collection plans of Protestant churches assembled. Price \$2.00 p.p. Write Bureau of Architecture, 300 Fourth Ave., New York 10, N. Y.

**BUILDERS!** You can make more money; get information you need before it is published elsewhere; Subscribe to the daily ARCHITECTS REPORTS, only \$10.00 per month. Complete information from ARCHITECTS REPORTS, 68 Post Street, San Francisco. Phone DOuglas 2-8311.

**WANTED:** Experienced specification writer and building estimator by San Francisco ARCHITECT. Write WE 1-6, c/o ARCHITECT & ENGINEER, 68 Post Street, S. F.

**GET THE BEST,** don't be satisfied with anything but the best. Window sash, Doors, Cabinets, etc. Town Talk Sash & Door Mill, 524 9th St., Sacramento.

**PHOTOGRAPHY.** For the best in construction photography, including exterior and interior aerial, and progress views. . . you will find as many others have that it's the SKELTON STUDIO'S, 137 Harlan Place, San Francisco. Telephone YUkon 6-6321.

**FLOOR COVERINGS** for industrial, commercial, and residential construction. Complete lines, one of the oldest, best established organizations in the Sacramento Valley. LATTIN'S, INC., 1519 Alhambra Blvd., Sacramento.

## REVISED STANDARD ABBREVIATIONS FOR USE ON DRAWINGS ADOPTED

A revised edition of the American Standard Abbreviations for Use on Drawings has recently been published, bringing the 1946 edition up to date.

The new edition will materially aid draftsmen, shopmen, assemblers, and construction men in interpreting industrial drawings done by various companies and branches of the government.

It contains special new sections on abbreviations for colors, valves, and screw threads. Over 200 changes have been made in the original edition and more than 40 new abbreviations have been added.

## LOW INCOME HOUSING PROJECT

The Housing Authority of San Joaquin County (California) have undertaken a project whereby 400 low income housing units are to be built in Stockton at an estimated cost of \$3,500,000.

Hoard G. Bissell, Stockton, is the architect and Ellis E. Eckland, Stockton, is the engineer.

## PRIZE WINNING HOME PLAN PUT INTO MASS PRODUCTION

Plans originated by Wurdeman & Becket, Los Angeles, architectural organization that captured second place in a national contest sponsored by the national Association of Home Builders, have been adopted for construction on a project of 47 homes at Palm Terrace in Ontario, California.

The home design features economies in construction in tracts where 50 or more units were to be built.

## NEW STANFORD HOSPITAL

The Stanford University Board of Trustees have tentatively approved the construction of a new Medical Center building to be built in San Francisco at a cost of \$8,500,000. The site of the proposed building is at Clay and Webster streets.

## AIR FORCE CENTER SELECTED

The U. S. Air Force, Washington, D. C., has announced its intention of constructing a new Air Force Indoctrination Center on Highway 50 near Dublin in Alameda county. The center will provide for 30,000 men and will cost \$33,058,000 to build.

THE Commerce Department estimates construction of all kinds by private builders during 1951 will be \$15 billion, or 27 per cent under the 1950 total.

PRODUCTION of housing units has increased from 247,000 in 1920 to 1,389,500 in 1950.

## FORDERER CORNICHE WORKS

*Manufacturers of*  
Hollow Metal Products • Interior Metal Trim  
Elevator Fronts and Cabs  
Metal Plaster Accessories • Sanitary Metal Base  
Flat and Roll Metal Screens  
Metal Cabinets • Commercial Refrigerators

269 POTRERO AVE.  
SAN FRANCISCO, CALIF. HEMLOCK 1-4100

## Parker, Steffens & Pearce

BUILDERS

135 South Park, San Francisco

Phone: EXbrook 2-6639

## BARRETT & HILP

CONTRACTORS

*Builders of the West*

918 Harrison Street • San Francisco  
Telephone DOuglas 2-0700

234 West 37th Place • Los Angeles  
Telephone ADams 3-8161

**Brown Skin**  
STANDARD

The resilient building paper creped to S-T-R-E-T-C-H

Quality Products Since 1895  
**ANGIER PACIFIC CORPORATION**  
15 NEW MONTGOMERY ST. • 7624 SUNSET BOULEVARD  
SAN FRANCISCO 5, CALIF. • LOS ANGELES 48, CALIF.

A complete line of Angier products available from your building material dealer

## STOP

Penetration Of  
MOISTURE  
WIND  
DUST  
VERMIN

EVERLASTING  
PROTECTION



## CONSTRUCTION CONTRACTS AWARDED AND MISCELLANEOUS PERSONNEL DATA

**OFFICE REMODEL**, San Francisco. Parker Pen Co., owner. \$42,445. ARCHITECT: John K. Branner, San Francisco. DESIGNER: Gratton English, San Francisco. Interior remodel. GENERAL CONTRACTOR: Jacks & Irvine, San Francisco.

**GEORGE WASHINGTON CARVER SCHOOL**, Fresno, Fresno County. Fresno Board of Education, owner. \$276,000. ARCHITECT: Wm. E. Hastrup, Fresno. Frame and stucco construction. GENERAL CONTRACTOR: Clarence Ward, Fresno.

**GRAMMAR SCHOOL**, Dobbins, Yuba County. Dobbins Elementary School District, owner. 3 classrooms and toilet room. \$86,179. ARCHITECT: Chas. F. Dean, Sacramento. Frame and stucco construction. GENERAL CONTRACTOR: Burroughs & Son, Marysville.

**BOBBY VIEW GRAMMAR SCHOOL**, Redding, Shasta County. Redding Elementary School District, owner. 8 classrooms, office and toilet room. \$196,427. ARCHITECT: Clayton Kantz, Redding. Frame construction. GENERAL CONTRACTOR: B & R Construction Co., San Francisco.

**HIGH SCHOOL ADDITION**, Morgan Hill, Santa Clara County. Live Oak Union School District, owner. 2 shop buildings. \$204,272. ARCHITECT: Robert Stanton, Carmel. Agricultural shop building, general shop, cafeteria, paving. GENERAL CONTRACTOR: Wm. Radtke & Son.

**HOSPITAL ADDITION**, Alameda County. Samuel Merritt Hospital, owner. Maternity wing addition. \$800,000. ARCHITECT: Mastern & Hurd, San Francisco. 4 story, reinforced concrete and structural steel construction. GENERAL CONTRACTOR: Swinerton & Walberg, Oakland.

**NEW GRAMMAR SCHOOL**, Kingsburg, Fresno County. Kings River Union Elementary School District, owner. 9 classrooms, administration, all-purpose and kitchen and toilet rooms. \$320,000. ARCHITECT: Coates & Metz, Fresno. Frame and stucco construction. GENERAL CONTRACTOR: Midstate Construction Co., Fresno.

**BAKERY BUILDING**, Hayward, Alameda County. Cottage Baking Co., owner. \$62,500. ENGINEER: Preston M. Jones, Oakland. 1 story, 60x180 brick and structural steel, wood roof, steel sash, maple floor. GENERAL CONTRACTOR: C. Ross McLeilan, Hayward.

**EDUCATIONAL BUILDING**, San Mateo, San Mateo County. Congregational Church, owner. \$70,000. ARCHITECT: Ratcliff

Haymond-Ratcliff, Berkeley. 2 story, frame and stucco construction. GENERAL CONTRACTOR: Arthur Bros., San Mateo.

**AIR FORCE HOUSING PROJECT**, Fairfield, Solano County. National Engineering Development Co., sponsor. 390 housing units. \$9,000,000. ARCHITECT: W. D. Peuhg, San Francisco. Frame and stucco construction. 58 1-bedroom, multi-family units, 296 2-bedroom, multi-family units, 234 3-bedroom, multi-family units for officers, 40 1-bedroom duplexes, 192 2-bedroom single units and 156 3-bedroom, single units and 4 4-bedroom units. GENERAL CONTRACTOR: MacDonald, Young & Nelson & Morrison & Knudsen Co., San Francisco.

**CHURCH AND SUNDAY SCHOOL**, Palo Alto, Santa Clara County. First Church of the Nazarene, owner. \$55,000. DRAFTSMAN, David R. Garcia, Palo Alto. Frame and stucco construction.

**POST OFFICE AND STORE BUILDING**, Kentfield, Marin County. Kentwoodlands Co., owner. \$50,361. ARCHITECT: J. S. Gould. 1 story, frame and stucco construction. GENERAL CONTRACTOR: Wagner & Martinez, San Francisco.

**HEATING PLANT ADDITION**, Morgan Hill, Santa Clara County. Live Oak Union High School District, owner. \$36,880. ARCHITECT: Robert Stanton, Carmel. GENERAL CONTRACTOR: Geo. C. Renz Construction Co., Gilroy.

**APARTMENT STORE REMODEL**, San Francisco. Raphael Weill & Co., owner. \$1,253,780. ARCHITECT: W. P. Day, San Francisco. Interior remodel for new escalators from basement to 5th floor. GENERAL CONTRACTOR: Cahill Bros., San Francisco.

**CHERRYLAND GRAMMAR SCHOOL ADDITION**, Hayward, Alameda County. Hayward Elementary School District, owner. 4 classrooms, multi-purpose stage and kitchen, toilet room, \$227,444. ARCHITECT: Anderson & Simonds, Oakland. Frame and stucco construction. GENERAL CONTRACTOR: Steadman & Powell, Oakland.

**CAFETERIA BUILDING**, Sunnyvale, Santa Clara County. Sunnyvale Union High School District, owner. \$103,650. ARCHITECT: Maston & Hurd, San Francisco. 1 story, frame and stucco construction, concrete floor. GENERAL CONTRACTOR: Earl W. Emley, Saratoga.

**KIMBALL GRAMMAR SCHOOL ADDITION**, Hayward, Alameda County. Hayward Elementary School District, owner. 6 classrooms, multi-purpose room kitchen, \$204,623. ARCHITECT: Anderson & Simonds, Oakland. Frame and stucco construction. GENERAL CONTRACTOR: N. T. Lewis, Hayward.

**EL SOBERRANTE SCHOOL ADDITION**, El Sobrante, Contra Costa County. Pinole-Hercules Elementary School District, owner. 2 classrooms and toilet room, \$61,832. ARCHITECT: Jack Buchter, Orinda. Frame and stucco construction. GENERAL CONTRACTOR: V. P. Keutenberg, Martinez.

**STORE BUILDING**, Marysville, Yuba County. Masonic Hall Association, owner. \$68,234. ARCHITECT: J. S. Gould, San Francisco. 1 story concrete block and frame and brick veneer. GENERAL CONTRACTOR: Burroughs & Son, Marysville.

**INSURANCE OFFICE ADDITION**, San Francisco. Metropolitan Life Insurance Company, owner. New wing, \$3,000,000. ARCHITECT: Harry A. Thomsen and Alex Wilson, San

Francisco. New 7 story and 2 basement wing on Calif. St. side, structural steel frame, reinforced concrete, steel windows, terra cotta exterior, 3 new elevators. GENERAL CONTRACTOR: Cahill Bros., San Francisco.

**WILLARD JUNIOR HIGH SCHOOL**, Berkeley, Alameda County. Berkeley Board of Education, owner. Addition and remodel gym, shops, crafts and music building, \$55,730. ARCHITECT: Blanchard & Maher, San Francisco. Reinforced concrete and frame and stucco construction. GENERAL CONTRACTOR: John E. Bramagh & Son, Piedmont.

**HOWE GRAMMAR SCHOOL**, Sacramento, Sacramento county. Arcado Elementary School District, owner. 12 classrooms, kindergarten, administration & toilet room, \$302,296. ARCHITECT: Gordon Stafford, Sacramento. Frame construction, redwood & brick veneer exterior. GENERAL CONTRACTOR: Guth & Schmidt, Sacramento.

**GRAMMAR SCHOOL**, Willow Creek, Humboldt County. Trinity Valley Joint Union Elementary School District, owner. 5 classrooms, kindergarten, administration & toilet room, \$197,910. ARCHITECT: Frank T. Grossman, Eureka. Frame construction. GENERAL CONTRACTOR: A. C. Johnson & Sons.

**FREMONT GRAMMAR SCHOOL ADDITION**, Fresno, Fresno County. Fresno Board of Education, owner. \$53,000. ARCHITECT: Stevens & Clark, Fresno. Frame & Stucco construction. GENERAL CONTRACTOR: Robert E. Jolly, Fresno.

**HIGH SCHOOL ADDITION**, Morgan Hill, Santa Clara County. Live Oak Union School District, owner. 2 shop buildings, \$204,272. ARCHITECT: Robert Stanton, Carmel. GENERAL CONTRACTOR: Wm. Radtke & Son.

**NEW GRAMMAR SCHOOL**, Kingsburg, Fresno County. Kings River Union Elementary School District, owner. 9 classrooms, administration, all purpose, kitchen & toilet rooms, \$328,030. ARCHITECT: Coates & Metz, Fresno. Frame & stucco construction. GENERAL CONTRACTOR: Midstate Construction Co., Fresno.

**AUTO SERVICE BUILDING**, Vallejo, Solano County. Mullen Motor Co., owner. \$73,240. ARCHITECT: Ray F. Keefer, Oakland. 1 & 2 store, reinforced concrete, basaltic block, some structural steel, wood roof trusses, composition roof & steel sash. GENERAL CONTRACTOR: Karl E. R. Johnson, Vallejo.

**VANDALLIA GRAMMAR SCHOOL**, Porterville, Tulare County. Porterville Union Elementary School District, owner. 11 classrooms, kindergarten, administration & toilet room, \$152,221. ARCHITECT: Robert C. Koester, Visalia. Frame & stucco construction. GENERAL CONTRACTOR: L. H. Hansen & Sons, Fresno.

**GRAMMAR SCHOOL**, Stockton, San Joaquin County. Waverly Elementary School District, owner. 8 classrooms, kindergarten, offices, multi-purpose room, toilet room, \$244,875. ARCHITECT: Mayo & Johnson, Stockton. Frame & stucco construction. GENERAL CONTRACTOR: Nomellini Construction Co., Stockton.

**AUTO SALES & SERVICE BUILDING**, Remodel, San Francisco. James F. Waters, Inc., owner. \$70,000. ENGINEER: Myron C. Gould & Associates, San Francisco. 5 story, install reinforced concrete ramp in place of elevator. GENERAL CONTRACTOR: John A. Rademann, San Francisco.

**GUALT GRAMMAR SCHOOL ADDITION**, Santa Cruz, Santa Cruz County. Santa Cruz Board of Education, owner. 2 classrooms,

## PANACALITE

The Standard for Perlite Aggregates  
An Engineered Product—Engineering Service

Air Classified—Sized & Graded for  
Plaster, Concrete & Stucco  
Aggregates

Listed Underwriters' Laboratories  
Re-examination Service

Fire Ratings:  
Non-Bearing Walls—2 hours  
Floor and Beam—4 hours  
Columns—2 & 3 hours  
Suspended Ceiling—4 hours  
Others

Manufactured by

American Perlite Corporation  
26th & B Sts.—Yard 2—Richmond  
BEcon 5-1385

kindergarten, \$82,847. ARCHITECT: Lynn R. Duckering, Santa Cruz. Frame & stucco construction. GENERAL CONTRACTOR: K. J. McGrannahan, Santa Cruz.

**HIGH SCHOOL ADDITION.** Dixon, Solano County. Dixon Unified School District, owner. Agricultural shop, \$96,890. ARCHITECT: Kolb & Fisher, Sacramento. Frame & stucco construction. GENERAL CONTRACTOR: Affiliated Engineers & Contractors, Sacramento.

**WAREHOUSE BUILDING ADDITION.** San Jose, Santa Clara County. Clapp Baby Food Co., owner. \$200,000. ARCHITECT: Binder & Curtis, San Jose. 1 story, 200 x 240, reinforced concrete walls, wood roof, steel sash, concrete floors. GENERAL CONTRACTOR: Lew Jones Construction Co., San Jose.

**AIR FORCE HOUSING PROJECT.** Sacramento, Sacramento County. Beck-Utah-Hopkins Co., owner. 750 units, \$7,500,000. ARCHITECT: Jos. H. Gaylord, Texas; Ned H. Abrams, Sunnyvale. 1 story concrete block & frame construction.

**EL CAMINO HIGH SCHOOL ADDITION.** Carmichael, Sacramento County. San Juan Union High School District, owner. 5 classrooms, \$1,250. ARCHITECT: Chas. F. Dean, Sacramento. Frame & stucco construction. GENERAL CONTRACTOR: Arthur Odman, Fair Oaks.

**RESIDENCE.** Belvedere, Marin County. Don Gilmore, owner. \$86,000. ARCHITECT: Clarence W. W. Mayhew, San Francisco. 1 story, 4,000 sq. ft., frame & stucco construction, w/whit paneling, swimming pool. GENERAL CONTRACTOR: A. W. Baum, San Francisco.

**GRAMMAR SCHOOL ADDITION.** Le Grand Merced County. Le Grand Elementary School District, owner. 5 classrooms, locker room, \$59,905. ARCHITECT: Frank Wynrook & Assoc., Fresno. Reinforced concrete frame, concrete block walls & frame construction. GENERAL CONTRACTOR: Hubbard & Son, Turlock.

**SUPER MARKET.** Millbrae, San Mateo County. Max Schmidt, owner. \$200,000. ENGINEER: L. F. Robinson, San Mateo. 1 story, 175 x 180, reinforced concrete, tilt-up construction, wood roof, 60 ft. structural steel tower covered with architectural porcelain.

**OFFICE & FACTORY.** San Francisco. Patent Scaffolding Co., Inc., owner. \$150,000. ENGINEER: R. F. Wildman, San Francisco. 1 story, 30,000 sq. ft. class C reinforced concrete, concrete block & wood roof. GENERAL CONTRACTOR: W. C. Tail Co., San Francisco.

**HILLCREST ELEMENTARY SCHOOL.** San Francisco, City & County of San Francisco, owner. Units 2 & 3 kindergarten, 4 classrooms & 2 kindergartens, \$255,140. ARCHITECT: W. P. Day, San Francisco. 2 story, reinforced concrete construction, composition roof, wood sash. Yard work & fencing. GENERAL CONTRACTOR: S. J. Amoroso Const. Co., San Francisco.

**HIGH SCHOOL ADDITION.** Centerville, Alameda County. Washington High School District, owner. 4 classrooms, business education unit, \$86,233. ARCHITECT: Birge M. Clark & Walter Stromquist, Palo Alto. Frame & stucco construction. GENERAL CONTRACTOR: Ralph Larsen & Son, San Francisco.

**WAREHOUSE BUILDING.** South San Francisco, San Mateo County. General Warehouse Co., San Francisco. \$2,000,000. ARCHITECT: Ward & Bolles, San Francisco. 1 story, 570,00 sq. ft., reinforced concrete & frame construction, steel sash. GENERAL CONTRACTOR: Barrett & Hilp, San Francisco.

**BOYS CLUB HOUSE.** San Francisco. S. F. Boys Club, Inc., owner. \$285,862. ARCHITECT: Albert F. Roller, San Francisco. 1 & 2 story, reinforced concrete structural steel, roof trusses. GENERAL CONTRACTOR: Barrett & Hilp, San Francisco.

**SHOPPING CENTER.** Santa Clara, Santa Clara County. El Camino Homes, Inc., owner. \$211,000. ARCHITECT: John B. Anthony, Oakland. 1 story, 100 x 400, concrete block & structural steel frame, wood roof, plate glass aluminum store front.

**OFFICE BUILDING.** Oakland, Alameda County. Thos. Ferro, owner. \$180,000. ARCHITECT: John B. Anthony, Oakland. 2 story, 18,000 sq. ft., reinforced concrete & structural steel construction, aluminum sash, 1 auto park elevator. GENERAL CONTRACTOR: Anderson-Haglund, Oakland.

**FRANKLIN GRAMMAR SCHOOL ADDITION.** San Jose, Santa Clara County. Franklin-McKinley Elementary School District, owner. Home economics building & shop building, \$40,204. ARCHITECT: Kress & Gibson, San Jose. Frame & stucco construction. GENERAL CONTRACTOR: E. A. Hathaway & Co., San Jose.

**NEW HIGH SCHOOL BUILDING.** San Carlos-Belmont, San Mateo County. Sequoia Union High School District, owner. 3 classrooms, wings, multi-purpose, administration, 2 science wings, commerce wing, home economics wing, kitchen, library, shower, locker, toilet rooms, \$1,378,300. ARCHITECT: Frank Wynrook & Assoc., San Francisco. Reinforced concrete, concrete block & frame & stucco construction. GENERAL CONTRACTOR: Parker, Steffens & Pearce, San Francisco.

**FACTORY BUILDING.** Oakland, Alameda County. Tom Riley, owner. \$50,000. ARCHITECT: Albin Froberg, Oakland. 1 story,

reinforced concrete construction. GENERAL CONTRACTOR: Christensen & Lyons, Oakland.

**JAMES T. O'DOWD HIGH SCHOOL.** Oakland, Alameda County. Roman Catholic Archbishop of San Francisco, owner. 1st unit, classrooms, administration, science, domestic science, cafeteria & shop building, \$1,183,200. ARCHITECT: Blanchard & Maher & Paulus, San Francisco. 1 story reinforced concrete construction. GENERAL CONTRACTOR: Barrett & Hilp, San Francisco.

**OFFICE BUILDINGS.** Redwood City, San Mateo County. San Mateo Title Co., Mr. Currio, owner. \$250,000. ARCHITECT: Arthur D. Jansson, Menlo Park. (A) 1 story, mezz & basement, 75 x 100, reinforced concrete & frame construction, ceramic veneer. (B) 1 story, 3,000 sq. ft., reinforced concrete & frame construction. GENERAL CONTRACTOR: Julian N. Basin, Menlo Park.

**SCHOOL BUILDING.** San Francisco. West Portal Lutheran Church, owner. 4 classrooms, administration, library, \$60,000. ARCHITECT: Martiñ J. Rist, San Francisco. 1 story, frame & stucco construction, aluminum sash, asphalt tile & quarry tile floor, acoustical plaster. GENERAL CONTRACTOR: O. C. Moroney, Burlingame.

**SHOP BUILDING.** Ukiah, Mendocino County. Ukiah Union High School District, owner. \$113,586. ARCHITECT: C. A. Coulkins, Santa Rosa. Frame & stucco construction, steel sash, concrete floor. GENERAL CONTRACTOR: H. J. Schmiedeskamp, San Francisco.

**WAREHOUSE BUILDING.** San Francisco. Sears, Roebuck Co., owner. \$300,000. ARCHITECT: W. D. Peugh, San Francisco. 1 story, 200 x 480 reinforced concrete construction. GENERAL CONTRACTOR: Barrett & Hilp, San Francisco.

## Why built-in conduits and extra outlets win client satisfaction



Owners of new homes often need telephone extensions later on...in a bedroom, den or kitchen. When you plan built-in conduit and extra outlets for popular rooms, you're giving a service your client will appreciate. Then he can add extensions and not mar beauty of interiors through exposed wiring.

It's inexpensive to install facilities for concealed wiring during construction...the price of a few pieces of tubing. And your client's needs will be taken care of—for now and the future. For free help in planning, call your local Pacific Telephone office today and ask for "Architects and Builders Service."

Put built-in telephone facilities in your plans



Pacific Telephone

## IN THE NEWS

### COMMUNITY HOSPITAL SAN MATEO COUNTY

Working drawings have been completed for the construction of a 126-bed community hospital on El Camino Real in Hillsborough, according to an announcement by the architectural firm of D. D. Stone & Lou Mulloy of San Francisco.

Plans call for a five-story T-shape building of reinforced concrete construction which will cost in the neighborhood of \$2,950,000.

### PACIFIC COAST BUILDING OFFICIALS CONFERENCE

The Central District of the Pacific Coast Building Officials Conference met in Oakland recently to hear George Janssen, supervisor of the Second District of Alameda County, discuss a number of important subjects pertaining to the construction industry.

### NEW RESIDENCE CONSTRUCTION

Among the larger new residential construction projects noted during the past few weeks are the following:

599 new homes in the Lakewood area of Downey at a cost of \$9,000,000, by the Aldon Construction Company of Norwalk.

550 new homes in Phoenix, Arizona, by the F. & S. Construction Company.

30 new homes in Cameo Acres near Danville, Contra Costa County, by V. Flashman of Alameda at a cost of \$6,492 each.

50 new homes in the Santa Anita Highlands area, by the George Elkins Company. Dwellings are in the \$20,000 to \$40,000 class.

34 new homes are being built in the San Lorenzo area of Alameda county by the Lorenzo Development Company at a cost of \$8,000 each. Frame and stucco construction.

20 new homes are under construction in Centerville, Alameda county, by the Smith-Peters Investment Company at a cost of \$5,500 each. Single story, frame and stucco.

### ARCHITECT SELECTED

Raymond R. Franceschi of Sacramento has been selected to draft plans for a new annex to the Placer County court house in Auburn.

The new addition will be a two story reinforced concrete building.

### LOW BID ON LARGE CIVIL WORKS CONTRACT

The U. S. Army Engineers have announced the Guy F. Atkinson Company of South San Francisco, the Ostrander Construction Company of Portland, and the J. A. Jones Construction Company of Charlotte, North Carolina, as a joint venture, submitted the lowest bid of \$58,416,459 for completion of the McNary Dam on the Columbia River in Oregon.

The McNary Dam, a multiple-purpose navigation and power project, is one of the major units in the Corps of Engineers' comprehensive plan for the development, conservation and utilization of water resources of the Columbia River Basin in the Pacific Northwest. Total estimated cost of the project is \$270,000,000 of which approximately \$112,000,000 has been appropriated to date.

### REAPPOINTED BY ARIZONA HIGHWAY COMMISSION

The Arizona Highway Commission has reappointed W. C. Lefebvre, state engineer, and J. Melvin Goodson, executive secretary of the commission. Fred D. Schammer of Prescott has been appointed a member of the commission by the Governor, for a five year term.

### VALLEY PLANNING HOLDS EXHIBIT

The Valley Planning Institute held an exhibition recently on proposed development for the San Fernando Valley.

Prepared under the direction of Charles B. Bennett, director of the City Planning Department, the exhibit was shown in the Victory-Vanowen Recreation Center.

In conjunction with the exhibit a public forum was held to consider proposals of the Planning Department. Among those taking part were Milton Breivogel, city planner; Edmund McKanna, City Planning Commission; and Stanley A. Moe, president Architects of San Fernando Valley.

### ENGINEER SELECTED

John A. Blume, engineer, San Francisco, has been selected to design two warehouse buildings at the Benicia Arsenal for the Corps of Engineers, U. S. Army.

Of reinforced concrete and structural steel construction, the project will cost some \$5,050,000.

### SOUTHERN CALIFORNIA BUILDING PERMITS UP

More than \$317,285,453 worth of building permits have been issued in 72 southern California localities in the first quarter of this year. This exceeds by \$52,280,480 the total for the similar period of last year.

The increase marks a great new surge of building activity for the Southland and sets a new record pace for southern California for the rest of the year.

### NEW LOS ANGELES BANK BUILDING

The Citizens National Bank of Los Angeles has opened its new branch bank at Eastern and Sheila Ave. in East Los Angeles, according to H. D. Ivey, president of the bank.

The ultramodern building was designed by Architect Stiles Clements. It has a facing of Roman brick and Durastone and provides approximately 4,000 feet of floor space. Ample paved parking space has also been provided.

### NAVAL HOUSING PROJECTS

Housing projects scheduled for construction in San Francisco include a 250 unit which is being designed by architect Angus McSweeney, and a 100 unit project which is being designed by architect H. C. Baumann, also of San Francisco.

Another Navy housing project is under way near Port Chicago with the architectural firm of Miller & Warnecke of San Francisco designing a 126-unit group.

### NEW FACTORY BUILDING

The Rheem Mfg. Company have started construction of a new \$1,000,000 factory building in San Pablo. The structure will be of 1-story type, reinforced concrete and structural steel and will contain some 200,000 sq. ft.

Alben Froberg, Oakland, is the architect and Christensen & Lyons, Oakland, the general contractors.

### PUBLIC HEARING ON PUBLIC HOUSING

A public hearing was recently held in Los Angeles to consider the proposal of the Housing Authority of the City of Los Angeles to erect a 699-unit low rent public housing development on the site of the Jordan Downs temporary war housing project. It was the first of a series to be held by the Planning Commission on sites to erect 10,000 units of low rent public housing.

### FEDERAL FUNDS FOR AIR BASE

The U. S. Air Force recently announced plans for the construction of additional facilities at the Travis Air Force Base near Fairfield, California representing an expenditure of \$9,361,000.

Federal funds for the expansion program have been allotted.

### S. F. CONTRACTORS GET UTAH CONTRACT

The contracting firm of Moore and Roberts, and the B. R. Construction Company, both of San Francisco, have been awarded contract by the U. S. Army to construct eleven new buildings at the Dugway Proving Ground near Dugway, Utah.

Cost of the project is \$4,250,000.

### RETIRED ENGINEERS REACTIVATED BY GE

Twenty retired General Electric specialists, six of them Pacific Coast residents, have put their talents back to work to help meet the growing shortage of technical personnel in industry. The former sales and engineering experts volunteered as exhibit engineers on GE's "More Power to America Special" exhibit train, and for the next three

## ACOUSTI CELOTEX

Sound Conditioning  
... combines the  
correct materials and  
25 years experience  
in every type, size  
and technique of  
acoustical installation  
Acoustical Contractors

## WESTERN ASBESTOS COMPANY

San Francisco: 675 Townsend, KL 2-3868  
Oakland: 251 Fifth Avenue, GL 1-2345  
Sacramento: 1224 Eye Street, GI 2-8991  
Stockton: 733 So. Van Buren St., 4-1863  
Fresno: 434 "P" Street, 2-1600  
San Jose: 460 Park Avenue, CY 3-1317



**STATIONERY  
SCHOOL & OFFICE  
SUPPLIES**

•  
**Printing Engraving  
Announcements**

•  
**CENTER STATIONERY**

**468 McAllister**

**San Francisco UN 1-3703**

**MULLEN MFG.  
COMPANY**

—  
**BANK, STORE AND OFFICE  
FIXTURES—CABINET WORK  
OF GUARANTEED QUALITY  
CHURCH SEATING**

—  
**Office and Factory  
46-80 RAUSCH ST., Bet. 7th and 8th Sts.  
San Francisco  
Telephone UNderhill 1-5815**

**Thinking of Building?**

From our cost records and experience, an advance estimate may be made from decidedly general information. Based on our knowledge of labor and material costs, gained on current jobs, such an estimate may be helpful in determining your construction program.

**ALL TYPES CONSTRUCTION  
SAN FRANCISCO • SACRAMENTO**

**SWINERTON & WALBERG CO.  
OAKLAND • LOS ANGELES • DENVER**

**Fine  
ENGRAVINGS**



**POOR  
RICHARD**

**PHOTO ENGRAVING CO.**  
320-324 COMMERCIAL STREET  
SAN FRANCISCO 11

months will supply utility and industry leaders with technical information.

Among those participating in the 10-car streamliner's 30,000 mile tour of the nation are: C. A. Binns, Auburn; C. M. Davis, Porterville; W. C. Smith, Palo Alto (all of California); G. O. Hodgson, Denver; L. M. Moyer, Portland and C. L. Penny, Lake Grove, Oregon; and G. A. Boring of Seattle, Washington.

**ARCHITECT  
SELECTED**

C. J. Ryland, architect of Monterey, has been chosen by the Santa Clara County Board of Supervisors to design an exhibit building at the County Fairgrounds in San Jose.

Cost of the project is \$500,000.

**"SURE-GRIP" HOLDER  
WITH RUBBER ROLLER**

The Stanley Works, New Britain, Conn., has redesigned their No. 205 "sure-grip" holder, a smooth working clip with rubber roller that is handy for holding hats, papers, towels, reports, wall charts and cards.



Made of wrought steel it is furnished in brown lacquer and other standard hard-wear finishes. Easy to install.

**SALT LAKE CITY  
ELEMENTARY SCHOOL**

Ware & McCaughan, architects of Salt Lake City, have been appointed by the Salt Lake City Board of Education, to design a new 14-room elementary school building. Estimated cost of the building is \$500,000.

**SCHOOL BONDS  
ARE VOTED**

Voters of the Palo Alto public schools system have approved a \$4,000,000 bond issue for the construction of and additions to the grammar schools of the city.

**LOS ANGELES CONTRACTORS  
CONFER IN SACRAMENTO**

A delegation of southern California contractors representing the Building Contractors Association of California conferred with members of the State Legislature in Sacramento recently.

Headed by Edward M. Sils, executive vice-president, and Irving Jordan, chairman of the legislative committee, the group are interested in more than 135 bills effecting the construction industry.

**NEWSPAPER BUILDING**

The Monterey Peninsula Herald, Monterey, California, is constructing a new one story and mezzanine building to house the operations of the daily newspaper.

Wurster, Bernardi & Emmons of San Francisco are the architects.

**ENGINEER SELECTED**

Mac D. Perkins, engineer, of San Francisco has been selected as the engineer for the construction of a new cannery at Merced.

Of reinforced concrete and frame construction the plant will cost \$1,000,000.

**Subscribe  
Now —**

**ARCHITECT  
and  
ENGINEER**

**\$3.00  
Per Year**

**DINWIDDIE  
CONSTRUCTION  
COMPANY**

•  
**BUILDERS**

•  
**CROCKER BUILDING  
SAN FRANCISCO**



**HERRICK  
IRON WORKS  
STRUCTURAL STEEL  
REINFORCING STEEL**

**18TH AND CAMPBELL STS.  
OAKLAND, CALIF.  
Phone GLencourt 1-1747**

Phone GArfield 1-1164

**Thomas B. Hunter  
DESIGNER OF HEATING**

**AIR CONDITIONING  
VENTILATING AND WIRING  
SYSTEMS, MECHANICAL  
AND ELECTRICAL EQUIP-  
MENT OF BUILDINGS**

★  
**41 SUTTER STREET  
ROOM 710**

**San Francisco California**



**MATTOCK  
CONSTRUCTION  
COMPANY**



**BUILDERS**



604 MISSION STREET  
SAN FRANCISCO

Subscribe  
Now —

**ARCHITECT  
and  
ENGINEER**

**\$3.00  
Per Year**

**STOLTE INC.**

*General Contractors*



**OAKLAND • CALIFORNIA**

**PITTSBURGH  
TESTING LABORATORY**

**ENGINEERS AND CHEMISTS**

Testing and Inspection of Concrete,  
Steel and Other Structural Materials

Design of Concrete Mixes

Offices in all principal cities

651 Howard St., San Francisco 5  
EXbrook 2-1747

**Index to Advertisers**

AMERICAN Perlite Corpn.....	44
ANGIER Pacific Corp.....	43
ARCHITECTS Reports .....	43
BARRETT & HILP, Contractors.....	43
CLASSIFIED Advertising .....	42
CENTER Stationery .....	47
CLINTON Construction Company .....	36
COLUMBIA Steel Co.....	*
CROCKER, First National Bank.....	22
DINWIDDIE Construction Co.....	47
ELECTROMODE Corpn.....	43
FULLER, W. P. Co.....	*
FORDERER Cornice Works.....	43
GLADDING McBean & Company .....	*
GREUBERG'S, M. Sons .....	*
HANKS, Inc., Abbott A.....	48
HAWS Drinking Faucet Co.....	28-29
HERRICK Iron Works.....	47
HILLYARD Chemical Co.....	*
HOGAN Lumber Co.....	36
HUNT, Robert W., Company.....	48
HUNTER, Thos. B.....	47
JOHNSON, S. T. Co.....	35
JUDSON, Pacific-Murphy Corp.....	36
KRAFTILE Company .....	28
MARBLE Institute of America .....	2
MATTOCK Construction Co.....	48
MICHEL & Pfeiffer Iron Works.....	*
MULLEN Mfg. Co.....	47
NORTHERN California Electric Bureau .....	33
PACIFIC Clay Products Co.....	*
PACIFIC Coast Gas Association.....	38
PACIFIC Manufacturing Company.....	37
PACIFIC Portland Cement Company.....	Back Cover
PACIFIC Telephone & Telegraph Co.	45
PARKER, Steffens & Pearce.....	43
PITTSBURGH Testing Laboratory.....	48
POOR Richard Engraving Co.....	47
PORCELAIN Enamel (Architectural Division) Publicity Bureau .....	Inside Front Cover
REMILLARD-Dandini Co.....	48
REPUBLIC Steel Corporation.....	37
SCOTT Co.....	48
SIMONDS Machinery Company.....	37
SISALKRAFT Company .....	36
SMOOT-Holman Company .....	34
SOTO, Henry C.; Corpn, Landscape .....	34
STANLEY Works, The.....	35
STOLTE, Inc.....	48
SWINERTON & Walberg Co.....	47
U. S. Bonds.....	1
UNITED STATES Steel Corp'n.....	*
UTILITY Appliances Corp'n.....	25
VERMONT Marble Company.....	37
WEST Coast Screen Co.....	31
WESTERN Asbestos Company.....	46

\*Indicates Alternate Months

**ABBOTT A. HANKS, INC.  
Engineers & Chemists**

INSPECTING — TESTING — CONSULTING  
CONCRETE • STEEL • MATERIALS  
CHEMICAL AND TESTING  
LABORATORIES

• RESEARCH AND INVESTIGATION •

—  
TESTS OF STRUCTURAL MATERIALS  
DESIGN OF CONCRETE MIXES  
SHOP AND ERECTION INSPECTION OF  
STRUCTURES AND EQUIPMENT  
INVESTIGATION OF STRUCTURES  
AND MATERIALS  
TESTS AND INVESTIGATION OF  
FOUNDATION SOILS  
FIRE RESISTANCE AND INSULATION  
TESTS

—  
624 Sacramento Street, San Francisco

**ROBERT W. HUNT CO.**

**ENGINEERS**

**INSPECTING TESTING**

**STRUCTURAL MATERIALS  
CONCRETE MIX DESIGN  
CHEMICAL ANALYSIS  
EQUIPMENT**

PRINCIPAL CITIES  
UNITED STATES • EUROPE  
SAN FRANCISCO LOS ANGELES  
PORTLAND SEATTLE

**REMILLARD-DANDINI Co.**

**Brick and  
Masonry Products**



400 MONTGOMERY STREET  
SAN FRANCISCO, CALIF.

**Scott Company**

**HEATING • PLUMBING  
REFRIGERATION**



San Francisco  
Oakland  
San Jose  
Los Angeles

# ARCHITECT AND ENGINEER

PALM SPRINGS RACQUET CLUB



CLARK & FREY, Architects

JUNE

1951

# Defense is your job, too—how to help your country now



- ★ "The Defense\* Bonds I bought through Payroll Savings in '41 helped me to buy my new home!" says **G. F. Nelson**, manufacturing technologist at Shell Oil Company. Congratulating Mr. Nelson is Shell Vice President and former Air Force General "**Jimmy**" **Doolittle**, who adds, "At Shell we believe in Payroll Savings—it's a patriotic and practical way to do a job for defense!"



- ★ "The Savings Bonds I'm buying now for America's defense will add almost \$100 a month to my company pension when I retire," SP Engineer **Frank Bacher** tells his old friend, **A. T. Mercier**, President of the Southern Pacific Railroad. "They're an extra step toward independence in which the railroad helped me by encouraging me to join the Payroll Savings Plan."



- ★ **Mrs. Eleanor Miukvic**, drill press operator of Burroughs Adding Machine Company, introduces her Army veteran son **Vernon**, to her boss, Burroughs President **John S. Coleman**. "In 1942 I began buying Bonds through Payroll Savings at Burroughs," says Mrs. Miukvic. "Today they're helping Vernon's G.I. allowance to see him through college!"

## TEAM UP WITH THESE TYPICAL AMERICANS IN THE PAYROLL SAVINGS PLAN!



- ★ **Pasquale Santella**, millwright at United States Steel Company's Carrie Furnaces of the Homestead District Works, has a very personal reason for buying Savings Bonds. As he told **C. F. Hood**, United States Steel Company executive vice president, "My son Tony, 19, is missing in Korea. Used to be I bought bonds because it was my duty and it was a good way to save money. Now I want to help lick the Reds and get Tony back. I buy one bond every payday and when Uncle Sam needs more money, I'll buy more bonds." He has bought bonds regularly since 1943; has never cashed one.

## \* U.S. Savings Bonds are Defense Bonds Buy Them Regularly!

TODAY join with these Americans—business leaders and employees—in their drive to make our country and our citizens more secure. If you're an employee, go to your company's pay office *now* and start buying U. S. Defense Bonds through the Payroll Savings Plan—the safe, sure way to save for America's defense and for personal dreams-come-true.

If you're an employer, and have not yet installed the easily handled Plan, you will soon be contacted by one of industry's leading executives. Sign up with him—and help him put the Plan in every company! It's a practical, hard-sense way to help preserve our nation's future, its fortune, and the very institutions that make our lives worth while!



Your Government does not pay for this advertising. It is donated by this publication in cooperation with The Advertising Council and the Magazine Publishers of America.

# ARCHITECT

Vol. 185

No. 3

# AND ENGINEER

ARCHITECTS' REPORTS—Published Daily

## Contents for

# JUNE

EDWIN H. WILDER  
Editor

MARK DANIELS, A.I.A.  
Associate Editor

J. WELLS HASTINGS  
Contributing Editor

PROF. LELAND VAUGHAN  
Landscape Architecture

JOHN A. BLUME  
Structural Engineering

MICHAEL GOODMAN  
Planning

JOHN S. BOLLES, A.I.A.  
Book Reviews



### COVER PICTURE

RACQUET CLUB  
Palm Springs  
California

Clark & Frey, Architects

Where east meets west — movie celebrities, socialites, professional people from New York to Los Angeles and many others spend their vacations here.

Nestled in the colorful land of the quiet desert of Southern California is the Racquet Club with its Guest Bungalows, designed by Architects Clark & Frey of Palm Springs to capture the full impact of the desert. (See page 16).

ARCHITECT & ENGINEER

is indexed regularly by

ENGINEERING INDEX, INC.

EDITORIAL NOTES . . . . .	4
JOINT INFORMATION COMMITTEE American Institute of Architects & Producers Council . . . . .	6
NEWS & COMMENT ON ART . . . . .	7
THE ROLE OF ATOMIC ENERGY IN THE WORLD ECONOMY . . . . . By Gordon Dean, Chairman U. S. AEC.	9
NEW OFFICE BUILDING, United States Gypsum Company, Los Angeles By Richard Iander, Cejay Parsons, Architect; William Taggart, Structural Engineer; George W. Carter Co., General Contractor.	12
RACQUET CLUB, Palm Springs, California . . . . . Clark & Frey, Architects	16
REJUVENATION OF AN EARLY CALIFORNIA FARM HOUSE, Santa Rosa, California . . . . . Carl Young, General Contractor	20
JUNIOR HIGH SCHOOL, New California Style, Antioch, California . . . . . Kump & Falk, Architects	22
A.I.A. ACTIVITIES . . . . .	26
WITH THE ENGINEERS . . . . .	28
PRODUCERS COUNCIL PAGE . . . . . Edited by CARL B. FRANK, Detroit Steel Products.	30
BOOK REVIEWS, Pamphlets and Catalogues . . . . .	36
ESTIMATOR'S GUIDE, Building and Construction Materials . . . . .	39
ESTIMATOR'S DIRECTORY, Building and Construction Materials . . . . .	41
BUILDING TRADES WAGE SCALES, Northern, Central & Southern California . . . . .	42
CLASSIFIED ADVERTISING . . . . .	42
CONSTRUCTION CONTRACTS AWARDED, General Data . . . . .	44
IN THE NEWS . . . . .	46
INDEX TO ADVERTISERS . . . . .	48

ARCHITECT AND ENGINEER (Established 1905) is published on the 15th of the month by The Architect and Engineer, Inc., 68 Post St., San Francisco 4; Telephone EXbrook 2-7182. President, K. P. Kierulff; Vice-President and Manager, L. B. Penhorwood; Treasurer, E. N. Kierulff.

Los Angeles Office: Wentworth F. Green, 439 So. Western Ave., Los Angeles 5; Telephone DUnkirk 7-8135.

Entered as second class matter, November 2, 1905, at the Post Office in San Francisco, California, under the Act of March 3, 1879. Subscriptions United States and Pan America, \$3.00 a year; \$5.00 two years; foreign countries \$5.00 a year; single copy 50c. ARCHITECTS' REPORTS are published daily from this office, Vernon S. Yallop, Manager, Telephone DOuglas 2-8311.





# EDITORIAL NOTES

## CONSIDER THE ARCHITECT

The layman's concept of an "Architect", in the singular, is a lone wolf, an all-powerful and all-seeing individual who because of his tremendous knowledge is able unassisted to devise, design and build any building.

It is quite important therefore that the "Architect" conduct his client relations, as well as his contact with the general public, in such a manner that this initial professional respect be maintained, and at the same time it be recognized that his greatest value is in the great variety and wide scope of professional and technical service at his command.

The "Architect" offers a broad professional planning and building service as a cooperative operation. He is a part of a team. Under his wise leadership are applied the skills, knowledge and ideas of architects, draftsmen, structural engineers, mechanical engineers, electrical engineers, civil engineers, acoustical consultants, lighting experts, landscape architects, special consultants, specifications writers, construction superintendents, estimators, his own office help, and material dealers and manufacturers.

That all these talents could be combined in a single individual is inconceivable. It is conceivable, however, that an individual can wisely and judiciously employ all of the talents which are available to him, and thus render his clients, the public, and his profession a worthy service.

There are over 2,300,000 persons engaged in contract construction work, in the United States.

## A NEED FOR BALANCE

With greatly enlarged defense requirements the problem of reconciling adequate taxation with dynamic production has become acute. It is likely to remain so for some time and perhaps become even more critical if defense requirements increase. We urgently need, but do not have, a balanced policy for dealing with this problem.

In our opinion the key to this problem lies in two facts:

First, taxes are only one element in the necessary program for controlling inflation. Taxes help control inflation by reducing the demand for goods and services. But there are other ways to reduce demand. The government's demand can be reduced by economy in government expenditure. Private demand can be restrained by restriction of credit and by promotion of private saving.

Our goal should be taxes high enough to serve as part of an adequate total program to control

inflation. The program should be balanced in the sense that it does not rely on any one element—such as taxes—to the neglect of other measures that could restrain inflation with less impairment of production.

Second, different kinds of taxes differ greatly in their effects upon inflationary pressure and upon production. That is, per dollar of revenue yield, some taxes have much more anti-inflation effect and less anti-production effect than others. Therefore the possibility of developing a strongly anti-inflationary tax program without serious detriment to production will depend in large degree upon the kinds of taxes that are imposed.

Wedding bells chimed for 1,585,000 couples in 1949 in the U. S. and 3,729,000 babies were born. Two good reasons why an unhampered housing production program should be maintained.

## HOME BUILDING INDUSTRY LAY-OFFS

The National Association of Homebuilders, an organization extending throughout the entire nation, has just released the results of a survey taken to determine the effect of recent Government controls on the home construction industry.

According to the report some 600,000 building trades workers have become unemployed in new and private residential construction because of Government regulation within the homebuilding industry.

Figures show, according to the Association, that a year ago there were some 1,400,000 workers employed as against 875,000 for this year.

Many areas are reporting acute housing shortages in direct conflict with Government officials who claim the total number of homes to be constructed this year, as compared with last, can be reduced 50 per cent.

## BALANCE IS NECESSARY

Experience shows that the necessary balance between total demand and total supply, or between civilian demand and civilian supply, will not come about automatically. It must be achieved by positive measures. One basic reason is that individual and businesses earn incomes from production, whether the production is for military purposes or for non-military purposes. But the goods and services available for them to buy come only from the non-military production. As military expenditures rise the gap between total production and non-military production rises, and so does the gap between incomes and the supplies available to be bought with those incomes.

"When designing the Montecito School, our firm chose Clay Brick, inside and outside, as one of the structural materials because it provides a durable surface for both interior and exterior use, requiring practically no maintenance and having a rich, pleasing appearance value."

John Lyon Reid, A.I.A.



*An excellent example of modern school architecture is Montecito School at Martinez, California. Designed by John Lyon Reid, A.I.A., it illustrates Clay Brick's adaptability for both indoor and exterior use as well as flexibility in combination with other building materials.*

## Inside and Outside Clay Brick adds Beauty and Functional Values

**BUILT-IN COLOR.** Clay Brick's warm friendly color and texture is there to stay. Weathering only enhances it.

**NO MAINTENANCE NEEDED.** Clay Brick never needs the refinishing or repainting required by other materials every few years.

**FLEXIBILITY.** Clay Brick's small modular scale makes it easy to combine effectively with other building materials.

**RESISTANCE TO VANDALISM.** Clay Brick walls have a rugged surface that does not lend itself easily to marring or scuffing.

### CLAY BRICK & TILE ASSOCIATION

OF NORTHERN CALIFORNIA

55 NEW MONTGOMERY STREET • SAN FRANCISCO

Kroffile Company  
Remillard Dandini

L. P. McNear Brick Co.  
San Jose Brick & Tile

Port Costo Brick Works  
Stockton Brick & Tile Co.

United Materials & Richmond Brick Company

# JOINT INFORMATION COMMITTEE

AMERICAN INSTITUTE OF ARCHITECTS and THE PRODUCERS COUNCIL, INC.

---

At this time it might be well to review some of the events which have developed since the advent of the Joint Information Page in the Architect and Engineer. August 1950 was the initial publication of this page and from then until now we have steadily printed all of the available information on the subject of Uniform Specifications and Manufacturers Literature as it pertained to the building profession.

This led to the publication of F. Bourn Hayne's suggestions in three parts which appeared in our November, December and January issues. The immediate result of this publication ended in its attention being called to the National Joint Information Committee which in turn caused a questionnaire to be sent nation-wide to architects questioning them concerning the value of these suggestions.

To date of course we have given precedence to the views of the architect. There are always two sides to every discussion and it becomes apparent that the building materials manufacturer is faced with a problem which is not easily adapted to the complete needs of the architect. First is the cost of revising all of his current trade literature which is directed to the architect. What is nominally overlooked is the fact that through the normal process of sale of a building material it must be sold to the man making the installation.

Realistically this buyer of the manufacturer's product may or may not be controlled by the architect's specification in the choice of unit or material. As a result the manufacturer must be sure to sell his product to the installer. He must be approached from a different viewpoint and therefore manufacturers' literature must be usable by both the installer and the architect.

Last, but not least is the owner for whom the structure is being built. It is this man's money

which pays the architect's fee and finances the construction so the contractor can build it and make a profit. He is the top man in this sequence and the manufacturer also has to produce literature that he can understand and use as a guide for purchase.

Here we have shown three distinct needs for information material by the manufacturer for three different factors in the use of his product. The cost of producing sufficient information for each one of these important people according to classification is extremely high if enough thought and quantity is involved. Thought and quantity mean talent costs which must be paid to the advertising agency or members of their own staffs hired for this job. The quantities run up the cost from the production end and it is frequent that printing a single promotion piece will cost over \$5,000.00.

Under the circumstances economics demands that compilation of this material be consolidated for use as much as possible. The logical place to consolidate is in the material which is to be used by the architect and the craftsman or contractor or building materials dealer. If an information piece can be printed which will serve the need of all of these people obviously a great saving can be accomplished.

As soon as we realize that such a consolidation is frequently necessary we see that all of the architect's problems cannot be solved by very simple revisions. It is far from simple. Also the architect will find that if he relies too much on the manufacturer for specification material he may be transferring some of the responsibility for the structure which is his own to the manufacturer.

We have heard the architect point out that he is responsible for structural failures so the question comes forth is the architect still responsible if he relies too greatly on canned specifications.

---

*NOTE: This news space is being contributed by ARCHITECT & ENGINEER Magazine to the JOINT INFORMATION COMMITTEE representing the Northern California Chapter of The American Institute of Architects and the Northern California Chapter of the Producer's Council, Inc., and is available to this Committee for the purpose of bringing to the attention of leaders within the Construction Industry various phases of the Architectural profession and building materials industry procedures for general consideration and comment. Your "ideas" and any suggestions for the better pooling of thoughts along these lines should be sent to "Joint Information Committee, c/o The Architect & Engineer, 68 Post Street, San Francisco," where they will be immediately forwarded to the proper committee members.*

# NEWS AND COMMENT ON ART

## STATE ARTIST EXHIBIT FOR CALIFORNIA STATE FAIR

One of the West's major art shows is being planned for the California State Fair at Sacramento, August 30th to September 9th, according to Grant Duggins, exhibit supervisor.

Last year more than 955 entries were submitted from Los Angeles and the San Francisco Bay Area alone and it is expected this number will be considerably increased this year due to the increase of premium awards to \$15,000.

Ned Green, secretary-manager of the Fair, has named the following Fair's Art Jury:

Conservative Oils—Nat Levy, San Francisco; Stan Parkhouse, Glendale; and Reginald Poland, San Diego. Modern Oils—Francis de Erdely, Los Angeles; Erle Loran, Berkeley, and Reginald Poland, San Diego. Prints and Water Colors—Francis de Erdely, Los Angeles; Erle Loran, Berkeley; Reginald Poland, San Diego, and Stan Parkhouse, Glendale. Sculpture—Donal Hord, San Diego, and Richard O'Hanlon, Berkeley. Ceramics and Enameling, Metal Work, Jewelry and Weaving—Katherine Choy, Oakland; Otto Nahzler, Los Angeles; Mary Walker Phillips, San Francisco; Winfield Scott Wellington, Berkeley, and Robert Winston.

## CALIFORNIA SCHOOL OF FINE ARTS

Twenty faculty members will offer a wide variety of courses in the California School of Fine Arts Summer Session which opens July 2nd. The six-week session will offer courses in all art media, including painting, drawing, sculpture, lithography, engraving, etching, silk screen, ceramics, design,

color, advertising art, illustrations, jewelry making, photography and motion pictures.

A special program for teachers, "The Art Education Workshop" is also being offered, as well as a series of weekly lectures on "The Role of Art in Society Today."

The regular Fall Term will commence on September 10th, offering three year courses in Painting, Sculpture, Graphic Arts, Design for Commerce and Industry, and Photography.

## SAN FRANCISCO MUSEUM OF ART

The San Francisco Museum of Art, War Memorial Building, Civic Center, will offer an exhibition of recent additions to the Permanent Collection during June. Among those being shown are Matthew Barnes' THE APPOINTMENT; Picasso's UNTITLED 20-4-21; Dufy's SAUMUR; De Chirico's THE VEXATIONS OF THE THINKER; and Morris Graves' BIRD MADDENED BY THE SOUND OF MACHINERY IN THE AIR. In all, twenty-four acquisitions in various media will be shown.

EXHIBITIONS for June will include: Seattle Drawings; Picasso Lithographs; Art In Education; Television Illustrations; Architecture of Bernard Maybeck; Pottery of Bernard Leach; Mexican Graphic Art; and Archie Gorky.

EVENTS: The "Art in Your Life" television program will be presented every other Sunday at 1:30 P.M. over station KRON Channel 4. Lectures offered by the staff members include "Bernard Leach" by Ailon Schoener, "Bernard Maybeck" by Barbara Fitzwilliams, "Arshile Gorky" by Nancy Bordewick, and "Mexican Woodcuts by Garcia Maldonado" by Anneliese Hoyer, with the lectures

## RECENT ACCESSION SAN FRANCISCO MUSEUM OF ART CIVIC CENTER, SAN FRANCISCO

### HOUSE AT VILLEJUIF

Oil by Maurice Utrillo

Now on exhibition among recent accessions.

Bequest of Harriet Lane Levy.





## NEWS AND COMMENT ON ART . . .

being given on Sunday afternoons at 3:15. The Wednesday evening lectures, 8 o'clock, will be "Bernard Maybeck" by William Wurster, "Ceramics Out Doors" by Mary Lindheim, Antonio Prieto, and Lawrence Holprin; "Art in Cinema" by Frank Stauffacher, and "Art in General Education" by Seymour Locks.

Gallery Tours, given by selected members of the staff, are held each Sunday at 2:30; and the Children's drawing and painting classes, closed for the summer, will be resumed in September.

### PAINTING BY CHICAGO ARTIST GOES TO SAN FRANCISCO MUSEUM

The San Francisco Museum of Art has been selected as one of the seven major American art museums to receive a painting by the Chicago artist, William S. Schwartz.

The painting, "Symphonic Forms No. 6," is now on exhibit at the Museum and is being given anonymously by a Chicago art patron.

### M. H. deYOUNG MEMORIAL MUSEUM

The M. H. deYoung Memorial Museum in Golden Gate Park, San Francisco, has scheduled the following exhibits and events for the month of June, according to Walter Heil, director.

"Pictures of San Francisco," a total of more than 150 photographs, prize winners of competition from the salon exhibit of the Northern California

Council of Camera Clubs is on exhibition for early June.

"Italy at Work: Her Renaissance in Design Today" is one of the most significant modern design exhibitions to be shown at the Museum in a long time. It consists of five full size interiors conceived by Italy's finest architect-designers, and 1,500 diverse objects are shown.

The exhibit is a co-operative project of the Italian Government acting through the Campagna Nazionale Artigiana and the Art Institute, representing eleven other museums in the United States.

Italy's creative individualism lay dormant for more than two decades under a dictatorship, and was completely suppressed during the war years that followed. The establishment of a democracy released the imagination and warmth of the nation's artisans who, calling upon traditional Italian technical virtuosity in their urge to rebuild after the ravages of war, were inspired to this new and vivid phase of creative design. The distinguishing feature of Italian design rests on a controlled fantasy of form, a direct expression of this nation's delight in color, texture and material, conveying a humanity and warmth that is so often lacking in contemporary design.

### CITY OF PARIS

The Rotunda Art Gallery of the City of Paris, San Francisco, under the direction of Beatrice Judd

(See Page 43)



### SAN FRANCISCO ART ASSOCIATION

800 Chestnut Street

#### EDWARD CORBETT ROSENBERG FELLOWSHIP WINNER

The Board of Directors of the San Francisco Art Association have announced that Edward Corbett, a resident of Taos, New Mexico, has been awarded the 1951 Abraham Rosenberg Traveling Fellowship in Art, and will be granted \$2,400 to carry out approved projects in the fields of painting.

Corbett, graduate of the California School of Fine Arts, was a member of the CSFA faculty through 1950, and has exhibited in leading museums and galleries throughout the country.

Corbett's work was chosen as outstanding by a jury composed of Robert B. Howard, Waldemar Johansen, Felix Ruvolo, Ninfa Valvo and Archie Wedemeyer.

Edward Corbett: Pen and ink sketches, 1945  
Collection of Mr. and Mrs. Walter Lander.

# THE ROLE OF ATOMIC ENERGY IN THE WORLD ECONOMY

By GORDON DEAN

Chairman, United States Atomic Energy Commission

I count it a privilege to participate in the Science Conference which is a part of Northwestern University's Centennial Celebration. You have set out for exploration a great and a grave question: "Can Science and Technology meet the demands on world resources of a growing population?"

You have asked me to speak on the subject: "The Role of Atomic Energy in the World Economy." And this is but a segment of your total exploration in this series. I must, therefore, pay tribute to the breadth of vision of those who conceived this conference. They have not set their sights low. And I think it is well that upon occasions such as this, we set our sights high—and peer just as far as we possibly can into the region where the visionaries of today, faltering and uncertain as their sights may be, may assist in bringing to realization the hopes of those, of all eras, who have tried to think straight and to think ahead.

Since the founding of Northwestern University, history has seen the advent of mass-produced steel, the telephone, the electric light, the linotype, the automobile, radio, X-ray, television, the airplane, motion pictures, the dynamo, and the typewriter, among other things.

All of these arrived on the scene openly and most have found or are finding their place in world economy through the operation of normal economic forces, influenced on occasions by military needs, but certainly not dominated by them. Even so, it was extremely difficult for economists and financiers of the time to predict their economic ramifications, as witness the difficulty which the automobile pioneers had in securing investors in their enterprise.

Now, at the very end of Northwestern's first century we have a newcomer: atomic energy—perhaps, the most significant of all.

Unlike the others, atomic energy first found its application in a military way. Unlike the others, it is being developed very largely in secret and under government control. Its military application is still its dominating characteristic and, because

of this, it has been isolated from the operation of some of the normal economic forces, and may remain so for some time. Any estimates of what its ultimate role in world economy will be, therefore, must largely be based upon conjecture.

I welcome the opportunity to address myself to this subject for it gives me a chance to stand off from the trees and attempt to see the forest. We who serve the Atomic Energy Commission are pretty well occupied with the trees at the moment. As you know, we have a very large expansion program underway. Our objective is to increase greatly our capacity to produce fissionable materials. This is very closely related to the national defense in this period of national emergency.

We have longer-range objectives that, when achieved, will unquestionably have a solid impact upon the peacetime economy, both in this country and abroad. Let us say that we have a pretty good idea where we are headed in atomic energy but we don't have all the answers on what effects our achievements will have when we get there. These are questions that ultimately will be answered by the economist, the statesman, the scholar and the citizen—and the answers cannot be any more than exploratory until there is more information than is now available.

In viewing our own atomic energy program with the perspective provided by the title of this address, one clear fact emerges: as of **today** the role of atomic energy in this nation's economy is more negative than positive. That is to say, our atomic energy program is taking more out of the wealth and resources of our country than it is putting in.

There is nothing that illustrates this point more vividly than the fact that the Atomic Energy Commission has recently entered into a contract with a new company called "Electric Energy, Inc." whereby the company will supply approximately one-half of the power needs of the Commission's new uranium separation plant to be built near Paducah, Kentucky. To do this the firm will have to build a new steam plant to generate power here in Illinois. When the day comes that a company called "Atomic Energy, Inc." is formed to provide power for the electrical systems of this country we will be in a much better position to discuss intelli-

---

*Editor's Note: Herewith is text of an address delivered by Gordon Dean, Chairman of the United States Atomic Energy Commission, in conjunction with Northwestern University's Centennial Celebration, recently observed.*

gently the positive impact of atomic energy upon our economy. The fact remains that while the world ultimately looks to the atom to produce power the atomic energy program is today the largest single **consumer** of power. This is not a pleasant fact but it is a fact.

We have, then, two phases of atomic energy development. One—the phase we are in now—where atomic energy development is largely **controlled**, and its impact is largely negative; and two—the phase we shall inevitably reach at some point in the future—where atomic energy will be unfettered and its impact will be largely positive. This will be the phase in which atomic energy will add to the wealth of the world. There are a great many variables in any determination of just when this day will come, and some of them are variables over which we in the Atomic Energy Commission have little control. Not the least among the variables are the plans and actions of the men who direct the destiny of the Communist world.

They have not been wise planners. They have been most short-sighted. If their plan is to curtail the atomic weapons program of this nation, they have been stupid; for it is they and only they who have required us to be strong. They have literally said by their blindness on matters of international comity and control of weapons: "America! You must build many bombs." And this we have done. If their plan is to deny to us the peacetime benefits of atomic energy they have again been stupid, for we are determined that whatever crisis of the moment may come we shall continue to support and encourage the beneficial uses of the atom. There will be those who will say "We cannot afford both courses." I insist that we cannot afford **not** to take both courses. Fortunately, they need not conflict. Fortunately our country is strong enough to push both. And that is what we are doing in our present program. The greatest tragedy would be that in the course of increasing strength for the moment we miss the benefits which Russia today is most anxious that we deny ourselves. This calls for a program of balance. We are determined to keep our program in balance.

There are, of course, some variables over which we do have a measure of control. One of the most obvious of these is the rate of our progress in technological research and development. Under the present system of control in this country it is largely up to the Atomic Energy Commission itself—or to others operating with our consent and aid—to prove the technical feasibility of using atomic energy for important industrial and other peacetime purposes. I would like to say we are mindful of this responsibility and that we are doing everything within our power that is consistent with our paramount objectives of defense and security to

speed the day when atomic technology will produce something of significant value to industry.

Our two sets of objectives—those having to do with defense and those having to do with peacetime economy—are not unrelated. Most of what we accomplish in the one area is of definite value to the other. We are, therefore, along with our weapons work and partly because of it, advancing toward the day when the technical feasibility of utilizing atomic energy for industrial and other purposes will be demonstrated. We have every hope and every reason to believe that such a day will arrive.

Before we look more closely at the role atomic energy may play in our future economy, let us examine the impact that it is having on our economy today—this negative impact. For how we handle the problems that confront us today will undoubtedly have a very important if not decisive bearing on the future.

To examine the negative impact of atomic energy development on our economy today is to raise some questions:

Is this impact too great? Are the returns we are receiving in the area of national security and the returns we hope to receive in the future in peaceful benefits worth the sacrifices we are making? These are particularly pertinent questions at this time when we are engaged in a tremendous expansion program.

Or—on the other hand—are our efforts perhaps not great enough? Could we safely be doing more? Could our economy, burdened as it is with our great defense mobilization program, stand a greater strain and would the results we would achieve be worth it? In answering, remember that in the fiscal year 1951 the Congress has appropriated about \$2 billion for the Atomic Energy Commission and that the appropriations for the Military Establishments have been to date about \$42 billion, and requests for more are to come.

Whether we can stand greater strains is still a hard question to answer.

To understand the setting in which it must be considered, it is helpful to understand the general nature of the atomic energy program and the factors which determine its magnitude. To do this let us visualize a schematic presentation in the form of a pyramid. The base of this pyramid is composed of raw uranium ore. Upward at succeeding levels are the great feed materials processing plants, uranium separation plants, plutonium-producing reactors, research and development laboratories, weapons facilities and testing areas—and throughout there is a vast accumulation of intricate and expensive equipment and highly trained people. At the peak are the end products—atomic weapons, isotopes for use in industry, agriculture,

research and medicine, and a considerable amount of technological information of infinite value to tomorrow's economy.

As this pyramid is increased in size—something we are doing at a growing rate at the moment—points of resistance are met at a number of different places. There may, for example, be a shortage of reactor technicians at one point, thus limiting the overall size of the structure, or there may be a critically short material at another. Or perhaps there are too few skilled construction workers here, or a too small capacity to supply vital equipment there. At each point where resistance is encountered is can be overcome, but sometimes at a very high price. For example, we may be able to obtain an adequate supply of some critical material only to find that we are taking it away from general industry, or more important, perhaps from some other vital part of the national defense effort.

Parenthetically I should like to give you some idea of the magnitude of our expansion effort. To date, the Congress has appropriated more than six billion dollars for atomic energy in this country. Two of these six billions were appropriated during the current year—a sum comparable to the entire amount expended by the Manhattan Engineering District on atomic energy during World War II. In the personnel field alone it has been estimated that 5% of the total scientific and engineering population of the country is engaged in atomic energy work. I have referred to some of the limiting factors which determine the size of our program. But the ultimate size is determined by ore. In other words, while our program might be made big enough—at a sacrifice—to handle almost any supply of uranium ore, the program is a pyramid and ore is the base. Uranium then is crucial.

When one considers the future of atomic energy development it is encouraging to reflect that one part in each 250,000 parts of the earth's crust is uranium. On this line of reasoning it can be pointed out that uranium is 1000 times as plentiful as gold, 100 times as plentiful as silver and almost as plentiful as lead or zinc.

One might ask, "If this is true, why don't we go all out to get this uranium out of the ground and into the form of bombs? Why are our activities limited to the relatively rich deposits?"

We could do this if we were willing to pay the cost. We could, for example, and I choose this example fully aware that it is extreme, extract uranium from sea water. It is well known, for example, that magnesium is extracted economically from sea water. It is also known that in sea water there is uranium which has been calculated to occur at a ratio of about five tons per cubic mile. We could get this uranium. But let us consider, for a moment, what this would cost.

In the first place, magnesium is much more prevalent in sea water than is uranium. It has been estimated that if we were to build a plant the size of a normal economical magnesium sea water processing plant we would get on the order of only 50 to 70 pounds of uranium from it per year. Two scientists, several years ago, calculated that to obtain uranium from sea water at a rate of 100 tons a year—enough to make it an interesting source—we would need a plant capable of processing 12 million tons of sea water per hour, and the cost of such a plant was estimated at in the neighborhood of 150 billion dollars.

This, I believe anyone will agree, would be an uneconomic way of obtaining uranium. We could do it, but what would we have done to our economy in the process? What would we have done to the rest of our defense effort?

The fact is that, although uranium composes one part in each 250,000 parts of the earth's crust, significant concentrations occur very sparingly.

We now mine some deposits containing but 1 part of uranium oxide to each 1000 parts of ore. Like other minerals, those deposits which can be mined most economically, whether because of grade, accessibility or the presence of other valuable materials in the ore, are mined first. Today the great bulk of our supply of ore comes from those deposits—the Congo, Canada and Colorado.

But where do we go from here?

First, we have a program underway to stimulate exploration. We want to find other deposits—preferably high-grade.

Second, we are turning increasingly to lower-grade deposits. The most obvious of these are deposits where uranium can be had as a byproduct of the production of some other valuable mineral. For example, we recently announced that the United States and the United Kingdom had entered into an agreement with the Union of South Africa whereby we will obtain uranium produced as a byproduct of gold production. Pilot plants for the extraction of uranium are already in operation at some of the South African gold mines.

Third, we are vigorously pursuing a research program that we hope will produce economic methods for extracting uranium from such other very low-grade deposits as the phosphates.

And fourth, we have just today increased the prices we pay for uranium in this country and the bonus we will pay for production from new mines. This is an important step. It will make production from lower grade deposits more profitable to the miner; it will stimulate development of known deposits whose extent is now still largely undetermined, and it will stimulate our exploration program.

(See Page 23)





Photographs by Robert C. Cleveland

NEW OFFICE BUILDING

United States Gypsum Co.

Los Angeles, California

By RICHARD IANDER

ARCHITECT · CEJAY PARSONS

STRUCTURAL ENGINEER · WILLIAM TAGGERT

GENERAL CONTRACTOR · GEORGE W. CARTER CO.

## . . . NEW OFFICE BUILDING

Embodying in construction an unusual engineering problem is the recently completed reinforced brick masonry office building for United States Gypsum Co. in Los Angeles, Calif. Architect was Cejay Parsons, of San Marino. William M. Taggart, of Los Angeles, was structural engineer, and the George W. Carter Co., also of Los Angeles, was general contractor and builder.

Grade characteristics of the building site gave rise to the engineering problem. The building was to be constructed on a steep lot, measuring 100 ft. in frontage by 119 ft. in depth. Rises in grade were presented along both dimensions—a rise of 8 ft., west to east, along the street front, as well as a rise of 18 ft., front to back, in the depth of the lot.

Added to this, it was discovered that the entire lot was "fill," ranging to a maximum depth of 17 ft. Therefore, it was necessary to employ sunken bell caissons to provide acceptable support piers, as prescribed under Los Angeles city building code requirements. Throughout the building, therefore, all of the reinforced brick masonry load-bearing

walls rest on these "floating" bell caissons of poured concrete.

Additional problems were presented in the positioning of the building on the lot. Requirements of the U. S. Gypsum Co. called for a minimum of 6,000 sq. ft. of office space. While this was readily attainable, experimentation and extreme care had to be exercised in the positioning of the structure on the unusual site. This was of paramount importance in order to avoid extensive grading and construction of retaining walls, and resultant mounting costs. It is a tribute to the architect, engineering and building team-work on this project that the problem was resolved with a negligible minimum of grading and the total elimination of retaining walls.

Final plans provided for a one-floor building, 64'x95', producing the required 6,000 sq. ft. of floor space. To eliminate the grading-and retaining-wall problem, the building was placed toward the rear of the lot, where the grade rise was greatest. The rear portion of the building thus rested on the nat-

**View of reception area of main floor from head of stairway from main portal below. Note ample fluorescent day-light, acoustical tile ceiling, with ample all year heating and ventilating outlets from duct system in ceiling.**



## NEW OFFICE BUILDING . . .

ural grade, with the forward or facade portion elevated above the dropping grade and extending out to rest on the poured concrete caisson piers at a height of 18 ft. at the facade.

The main floor level thus is 18 ft. above street level. In the center of the facade, therefore, a stairway and well of highly arresting architectural decor, was placed to form a main portal leading to the reception hall and main floor 18 ft. above. On either side of this main portal, bays were provided between the caisson piers beneath the overhang of the building. These bays, measuring 20 ft. in depth, provide a parking area for a total of eight cars.

Los Angeles building code requirements call for parking area provisions for one car for every one thousand square feet of floor space constructed. Thus, in the plan resorted to, this requirement was effectively provided for, with some to spare.

It was necessary to conform to a specification of the ground lease which stipulated the sole use of common red brick in construction. Facade, too, was

to be of plain brick decor. The simple, but nonetheless highly striking, appearance of the facade was achieved primarily through the use of Roman red ruffled brick which was laid in American or running bond for the entire expanse of the facade above the parking bays. Each horizontal course was deeply raked, as were the vertical joints as well. It has been held that such vertical or butt joints should be struck flush in order to heighten the illusion of greater horizontal expanse. In the new U. S. Gypsum Co. building, however, graphic demonstration is given that raking of such vertical joints appears not to destroy the illusion, but, moreover, provides a greater tapestry effect and pattern relief.

Fenestration, comprised of aluminum sash having fixed glass panels as well as wing openings of casement type, is inset in the facade in a 5 ft. high strip opening running the entire length of the main floor elevation of the building. This strip opening provides further decor to the facade by a deeply raked single row-lock course of the ruffled red brick serving as a surround.



**Main portal detail showing veneer application of Roman brick laid vertically with stacked joints to give illusion of greater expanse. Stairway and floor are terrazzo finished. Area is enclosed in 9 ft. high plate glass panels inset with double glass doors.**

## . . . NEW OFFICE BUILDING

Further embellishment of the facade was accomplished by treating the caisson piers flanking the main portal at street level with a veneer of Roman brick laid vertically with stacked joints. Within the main portal, in the vestibule and on the walls of the stair well, this same veneer treatment was carried out to create a pattern of broadening effect against the comparatively constricted area produced by the stair well and vestibule. Finishes of both the floor and the "free-floating" staircase are of terrazzo. Free-floating construction of the staircase provided space beneath it for a planter well, visible as a display from the street.

The entire main portal vestibule and staircase is enclosed with 9 ft. high panels of clear plate glass, inset with double glass doors. A second planter well of Roman brick laid in a quarter-arc fills one corner and adds to the beauty of the vestibule, as well as to the airiness of atmosphere. For night display both planter areas behind the plate glass are spot high-lighted.

Side and back walls of the new building are finished in grout-lock brick, laid in the running bond with all mortar joints simply sacked and then finish painted in a neutral buff color.

The caisson piers across the facade—apart from the two flanking the main portal—are finished with a white sparkle coat of Cemalith. They form divisions of the parking area and the sparkle coat provides further accent to the brick finish of the facade above.

Interior wall finishes of the offices are of flat-coat painted plaster. Ceiling finishes are of acoustical tile. In the "dead-air" space between ceiling and the built-up composition roof, ducting for all-year-round heating and air conditioning of the building is provided, with ample vent openings at strategic and uniformly spaced points in the ceiling.

All general lighting is by fluorescent mixed daylighting tubing. In the general office this lighting is of strip ceiling panel suspension type. In the reception area, at the top of the stairway up from the main portal, this lighting is inset in ceiling wells.

Finish throughout the main floor—office area and reception hall alike—is of asphalt tile set in mastic directly on the poured concrete floor base.

The entire building is an exemplary demonstration of the possibilities of obtaining high utility and architectural beauty at well-controlled cost, despite building code, topographical, engineering or other restrictions.

### GENERAL OFFICE AREA







Photos by Julius Shulman

# RACQUET CLUB

## PALM SPRINGS, CALIFORNIA

Clark & Frey, Architects

Southern California's new desert resort, the Racquet Club of Palm Springs, has been called many things from a "cloistered haven" to a "refreshing retreat," but in any event its architectural design has been geared to the warm sunshine of the western desert country.

Movie celebrities, prominent socialites, outstanding professional people from New York to Los Angeles and from Mexico to Canada have visited the Racquet Club to vacation and feel the nearness of oneself with the calm of the desert—a desert that is shaded by great mountains, immense and near, and where an ancient sun passes slowly across the sky from horizon to horizon.

Nestled in this colorful land of quiet desert beauty is the Racquet Club, symbol of magic and gaiety. Paradoxically enough, the decension of this man-made club upon this God-made country was

neither rude nor unwanted. On the contrary, so beautifully and harmoniously was the Racquet Club designed by Architects Clark and Frey to afford the guests the utmost in convenience and comfort for enjoying the many beauties and wonders of desert life, that this development completes a picture of perfection.

The property was first developed some sixteen years ago by Charles Farrell and Ralph Bellamy who sought a place to play tennis while relaxing at Palm Springs. The original tennis court was located on some property north of the town itself and from that modest beginning the present Racquet Club, with all its modern conveniences, was developed. Somewhere along the line a huge swimming pool was constructed and about 1940 saw the original construction of "patio rooms," which are augmented with a complete set of new

offices, shops, dining room, and guest bungalows.

Some of the world's greatest tennis players have smashed lobs over the Racquet Club's nets, and driven drives unsurpassed at Wimbledon, Bobby Riggs, Don Budge, Fred Perry, Gene Mako, Ted Schroeder, Pancho Segura, Jack Kramer, Ellsworth Vines, Helen Wills Moody, Alice Marble, Bob, Tom and Jinx Falkenburg and more recently Nancy Chaffey, Gussie Moran, Art Larson, U. S. singles champion, and Budge Patty, now reigning world tennis champion. The Pimm's Cup Tournament held at the Racquet Club each year, originated by Charlie Farrell and Dave Gillman, is still one of the outstanding and colorful highlights of the winter season.

It would be impossible to list the names of movie celebrities who vacation at the Racquet Club each season. The list is so long and continues to grow each year. A few, however, who call it their second home include Spencer Tracy, Paul Lucas, Bill and Mousie Powell, Honorary Mayor of Palm Springs Bob Hope, Jane Wyman, Tony Martin, Jimmie Ritz, Eddie Cantor, Frank Sinatra, Leo Fields, Ginger Rogers, Rosalind Russell, Clark Gable, Randolph Scott and Jack Benny, who broadcasts from the Club once a year with his hilarious "Murder at the Racquet Club."

Each year there are many more reasons for the continued increase in popularity of the Club, as each year additional plans for expansion are con-

sumated and facilities are improved for the comfort, greater convenience and larger selection of activities for the guests.

Strictly modern guest bungalows are now available with each arranged as an individual house where architectural design and construction techniques have provided an unobstructed view of the desert and the nearby mountains. Each bungalow has an all day sunny exposure and at the same time has absolute privacy from adjacent bungalows, Club activities and public thoroughfares. Each bungalow is also a definite part of the Club and its facilities which are just beyond the wooded stream that flows gently past the rear of the bungalows.

Convenient and individual parking for automobiles has been provided for each unit. Each bungalow has a private porch, an individual lawn area and a spacious walled-in sunbathing patio that is private from surrounding areas.

Construction of the bungalows are thoroughly modern in every respect. They are of sturdy frame and stucco general construction with cement floors covered with utility covering to meet the living requirements of each room. The roofs are of distinctive tile and add considerably to the harmony of the entire development.

Entertainment facilities at the Club includes the largest chess set in the world which stands outside the U-shaped group of patio rooms. Each chess-

**PLOT PLAN of Guest Bungalows. Identical units are staggered to afford privacy and views. Porches and patios face south-east to south-west. Desert location of the Racquet Club is two miles from the center of the City of Palm Springs, California.**

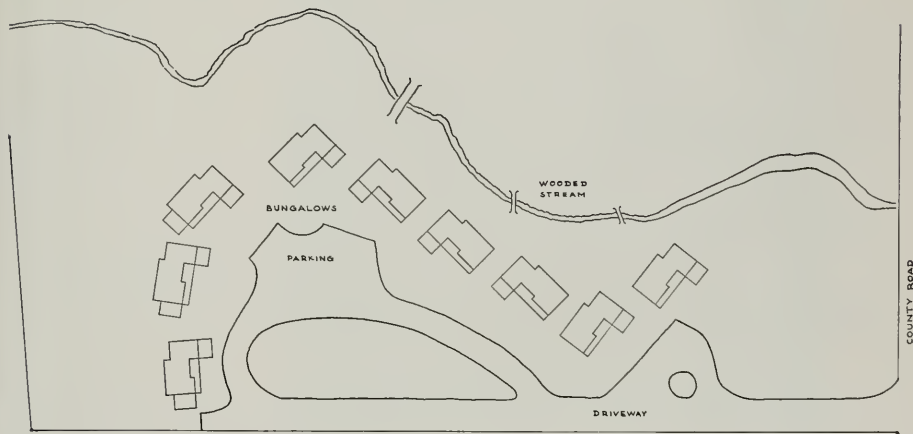

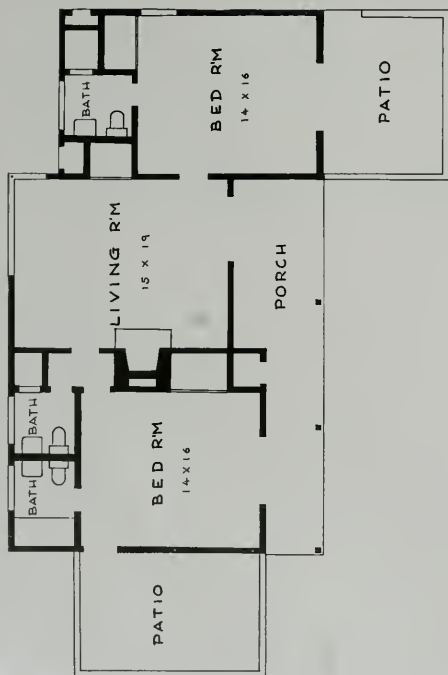

**THE GARDEN ROOM (above)**

As viewed from the bar to dining room, Modern-fold partitions permit separation when desired. Air conditioning ducts and outlets are out of sight in the ceiling and are readily accessible.

**FLOOR PLAN**

The Guest Bungalows each contain three rooms and three baths for occupancy as single rooms or may be used as a suite. Living room has couch beds and fireplace, and each room is equipped with wardrobe closets with sliding doors.

man is three feet high and novice as well as "expert" chess players find additional enjoyment in following the game on this unique set. A new league game called "Wiskit," using rackets similar to those of Jai Alai, and played on a baseball diamond, is being practiced at the Racquet Club this season. Fashion Shows, a wide variety of swimming events and diving exhibitions, and of course tennis and tennis tournaments, offers a diversity in entertainment that has a universal appeal. Activities are planned to appeal to every one who visits the Club irrespective of their "normal" interests and no one ever finds interesting entertainment lacking.

The dining room is a reflection of the warmth and brilliance of the owner and manager of the Racquet Club, and the colorful fantasy of multi-colored lucy bubbles on the ceiling of the dining room, created by architect Albert Frey, is as has been expressed a "new experience of soothing harmony and richness meant to reflect the person-

ality and gaiety of this splendiferous spot." Modern design includes the kitchen, bar and cocktail lounge, offices and a new group of individual specialty shops.

So, now in the sixteenth year of its existence, things go on pretty much the same as they did when Charlie and Ralph first played tennis there. The warm and friendly atmosphere is probably even more friendlier and warmer, and while Bellamy disposed of his financial interest in the project and transferred his business interests to New York, Charlie Farrell is still running around in his tennis shorts, trying to find his racquet, chatting with guests, answering the telephone, or rushing into Palm Springs to attend a city council meet-

It is said "Charlie and his Racquet Club are a tradition in Palm Springs. And today when wholesome traditions are so few, and worry and strife has run rampant, we stop to appreciate and take pride in this ever growing tradition that has brought so much happiness to so many."

**GARDEN ROOM**

Looking toward the swimming pool, is used for breakfast, lunch and cocktails.

The perforated metal supports induce the upward growth of the tropical vines.

Indirect lighting is concealed by supports and egg-crate ceiling.







**BEFORE  
REMODELING**

**BELOW:** The same house  
after a rejuvenation by  
"California Originals"  
building products.



# REJUVENATION OF AN EARLY CALIFORNIA FARM HOUSE

Santa Rosa, California

General Contractor: Carl Young

Total Cost: 3,600



CLOSE UP BEFORE ALTERATION—See below.

Located a few miles north of Santa Rosa, this early California farm house represented one of the more pretentious rural dwellings at the time it was constructed more than seventy years ago.

In recent years, however, the old house began to feel the burden of years of farm living and numerous changes of ownership which left their mark in the upkeep of the property.

With new ownership came the problem of refurbishing or tearing down entirely and the deci-

sion was made to modernize after a careful inspection of the property indicated much of the building was sound and good for many more years of comfortable living.

Under the direction of Carl Young, general contractor of nearby Healdsburg, in cooperation with a building materials representative in Santa Rosa and Wayne H. Hancock, Consumer Sales Supervisor for Pabco, the old home was rechecked for basic reconstruction needed and for uses of mod-

(See Page 43)

**SIDE VIEW of completed alterations showing on application of modern insect and moisture proof building material.**

**Photos by  
Ken Schroll  
Studio.**





Photo by Roger Sturtevant (Courtesy Clay Brick & Tile Ass'n Northern California).

# JUNIOR HIGH SCHOOL NEW CALIFORNIA STYLE

ANTIOCH, CALIFORNIA

Cost \$10.40 per square foot

The unique and original educational plant features designed by the architectural firm of Kump & Falk of San Francisco, to solve the owner's special program requirements and the crowded site, represents a two-story, eight room junior high school building that is one of the outstanding examples of modern school architecture on the Pacific Coast.

The basic design is the prototype of the multi-storied, bilaterally lighted classroom building that may be extended as many classrooms out, or as many stories high, as is deemed compatible to structural reinforcing.

To protect the wide outside corridors from prevailing breezes, utility rooms 14 ft. wide at either end of the building were extended 12 ft. from the classroom section, the width of the corridors. This added space also affords needed room for glassed-

in stairways, and the boys and girls toilets, the latter on the second floor. The corresponding space at the opposite end of the building, on the upper floor, is occupied by hot water equipment for radiant heating of the entire building. The storage room below is being used temporarily as the principal's office.

A 4 ft. steel and concrete fence installed at the outer edge of the balcony insures student safety. Posts of the rail are 2 in. steel pipes curved inward 6 in. at the top, where they are welded to a railing of the same size. Inch thick panels between posts, 4 ft. apart, are composed of metal lath with cement plaster on both sides, and are placed 9 in. above the floor and 6 in. below the top rail. These panels are painted a russet red to harmonize with the picturesque clay brick veneer exterior walls.

Plaster seams of the brick masonry, which is tied into reinforced concrete walls, extends continuously from bottom to top of walls, giving a very decorative effect. The exterior walls of the corridor are covered with cement stucco plaster.

Approximately 60 per cent of the concrete end sections, 40 ft. by 14 ft. is allotted to stairway. There is a landing half-way to the second floor where a walk, protected by banisters, leads to the room at the end of this section of the building. The 12 ft. by 24 ft. ends comprise twelve 4 ft. by 5 ft. panes of special type glass thus affording plenty of natural light for the stairway.

Interiors of the classroom are natural brick at either end and partitions between rooms are of wood frame joists and plywood panels which permit easy shifting of partitions to make larger or smaller rooms as they may be desired. Panels are painted a very light shade of green beneath the 4 ft. square clerestory windows. The ceiling, next to the windows, contains 3 ft. sections of hot water pipes for heating the air directly beneath that portion, and the balance of the ceilings are acoustical tile suspended on steel channels.

The floors are concrete slab containing pipes for circulating hot water radiant heating and covered with asphalt tile.

The total cost of the building, exclusive of land, was \$139,121.10.

## ROLE OF ATOMIC ENERGY

(From Page 11)

Dr. Vannevar Bush in his stimulating book "Modern Arms and Free Men," said: "To build a large stock of atomic bombs is an undertaking that will strain the resources of any highly industrialized nation. The strain will be greater if very dilute sources of raw materials have to be utilized, as seems probable."

By such actions as we have taken today we are gaining access to more dilute sources of these raw materials. But we are doing it at a price—to the taxpayer and to our economy. At this point I'm convinced the price is not too great.

In facing up to these questions we have a yardstick. In our constant efforts to increase the base of our program and therefore our program's total size we encounter a point where the cost of achieving our goals increases in geometric proportion to the progress we make. It is here we pause. To go further is to place a strain on our economy which in the long run might penalize us more in our competitive position in relation to the Communist world than it would help us. We must be mindful of the fact that we are in economic as well as military and political competition with communism.

This basic fact figures today in any considera-

tion we give to the problems of world economy and our national economy. Today a healthy economy is just as much a part of our arsenal of defense as our supply of machine guns or atomic bombs. Today our economy is geared to our national preparedness effort, and may remain so for some time. How we handle ourselves now will inevitably have a decisive effect upon the economic well being of this country and of the whole world. If we wreck our economy we will have lost in our competition with world communism and the discussion held at this conference will be meaningless. If we nurture our economy through this emergency, and still arm ourselves and our allies with greater military strength than our competitor we shall survive.

Of necessity one of the factors we must take into account when we attempt to arrive at a balance between our military needs and their effect on our economy is the position we occupy in relation to Russia in weapons generally and atomic weapons in particular. I am prevented from reporting to you on this because of security considerations, but it must always be a factor in any calculation.

Vannevar Bush has also said: "Mind that the most effective progress in the race will not come from throwing all of the country's resources directly



Distinctive architectural design, involving even round columns is easy with versatile

### PORCELAIN ENAMEL VENEER

• In addition, this colorful, lasting beauty is ideal for the most punishing applications. Analyze, compare, investigate—write today for complete details.

*Architectural Division*

PORCELAIN ENAMEL PUBLICITY BUREAU (Dept. AE)  
P. O. BOX 187, EAST PASADENA STATION, PASADENA 2, CALIFORNIA  
RFD-10, FRANKLIN BUILDING, OAKLAND 12, CALIFORNIA



## Another famous western brand

The West's accepted brand of quality in lighting equipment! Look for the mark of excellence in meeting your lighting needs. Smoot-Holman Illumination is distinguished by outstanding design, superior construction and economical performance in commercial, industrial and institutional uses.

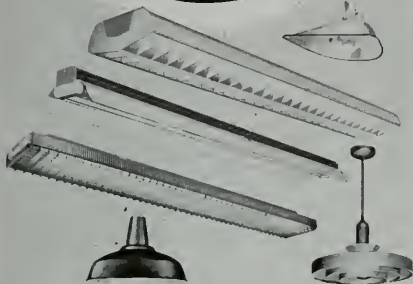

SMOOT-HOLMAN COMPANY, Woodland, Calif. Offices in Principal Western Cities • Branch and Warehouse in San Francisco

into the making of weapons of war. In fact, that would be a sure way of losing in the long run. To win the race we must have a healthy people. We must raise our standard of living so that more of our population may perform well. We must learn to make our industrial machine operate smoothly and avoid interruptions because of quarrels over division of the product.

"Now there is not the slightest doubt that we could thus overextend ourselves, and the corollary is that our military expenditures and our expenditures for aid to our friends must be made within reason, and with careful logic, correlation and economy. There is also no doubt that the most important thing for us to do, to maintain our full strength and bring the world back to sanity, is to keep our industrial and economic health, keep the machine running full blast without inflation or depression. Should we fail in so doing, the resulting distress in the world would play directly into the hands of those who would build on chaos."

Assuming that we handle ourselves successfully during this emergency period, let us look briefly at the potentially important positive role that atomic energy may some day play in world economy. To approach this intelligently, we should begin with the positive role today. For there is one. The total impact may be negative, but atomic energy nevertheless is already having a noticeable positive effect on our economy.

Today there are produced by the atomic energy programs of the United States, Great Britain and Canada radioisotopes which may be purchased both in the countries producing them and abroad. These materials are not secret and the work that is done with them is not secret, although there is some measure of control over their use, largely for reasons of health and safety.

Here, therefore, we have an example of a product of atomic energy that is being left relatively free to find its own place in world economy. We are still in only the very earliest stages of this development, but already we are beginning to see directions in which we are likely to go.

There are those who today see as the greatest contribution atomic energy will make to world economy the results of work with the radioactive elements and compounds that are produced in nuclear reactors.

For example, there has recently been completed a study by the Cowles Commission for Research in Economics of the University of Chicago under the auspices of the Social Science Research Council. In this report, which deals in an exploratory way with the economic aspects of atomic power, the authors—Sam H. Schurr and Jacob Marschak—have this to say:

"Nor do we know what uses will be made of cheap radioactive elements and compounds, an-



# A Combined

Landscape Architecture  
and Contracting Service

for

Tract, Industrial and Residential  
Development

We can do the Complete Job for you

- Landscape Architecture
- Finish Grading and Landscaping
- Asphalt Drives and Parking Lots
- Chain Link Fencing

**HENRY C. SOTO CORPORATION**  
*Landscape Contractors*

13000 SO. AVALON BLVD. LOS ANGELES 61, CALIF.  
Phone MEnlo 4-6617

other product of nuclear fission. Perhaps the most important though less immediate applications will be due to the new knowledge of matter, both dead and living, which scientists hope to acquire by using radioactive 'tracers.' For example: if, helped by these new research tools, we learn to imitate the action of green leaves in absorbing the sun's energy, both uranium and coal may, at some time and for some countries, acquire a formidable competitor, and the effect on food supplies may be even more important."

The radioisotopic byproducts of the atomic energy program are tools which can be used in this research. It may well be that in this area atomic energy will make its most significant contribution.

Already from the use of radioisotopes in industry some concrete developments have taken place. I should like to cite a few examples:

The Ford Motor Company is using radioisotopes to discover hidden flaws in metal castings and as accurate thickness controls in metal rolling.

The Standard Oil Company of California has recently placed on the market a new engine oil developed with the aid of radioactive piston rings which revealed the lubricating quality of the oil in development tests.

Rutgers University is developing a process for the study of soil density with radioisotopes with the ultimate goal of determining how soil density affects traffic damage to highways.

The University of Michigan is using radioisotopes to test the efficiency of various laundering techniques. In the experiment radiophosphorus is fed to bacteria, these are mixed with a soil preparation and this is smeared on two-inch square cloths. After washing the cloths can be "geiger-counted."

The U. S. Testing Company is using radiocobalt to make comparative tests of wearing characteristics of floor wax.

The B. F. Goodrich Company is attempting to use radiophosphorus to trace leaks in the cooling water line of an air-conditioning system. The Goodrich Company also uses radioisotopes to test various types of tire treads.

Goodyear uses radioisotopes to measure the thickness of its pliofilm.

The Bell Telephone Laboratories have used radio-strontium in studying the penetration of preservatives in telephone poles with the goal of developing more efficient methods of extending the useful life of the poles.

The Quebec North Shore Paper Company has used radioactive iodine from Chalk River to make a continuing survey of the pulp solutions and substances working together at every mixture stage in the manufacture of newsprint.

Radioactive antimony is used to mark the sep-

(See Page 31)

Cooling Performance  
Guaranteed to Meet  
Your Specifications

Guaranteed  
Air  
Delivery

Specify Utility equipment!—The one sure way to avoid the headaches of an installation that just doesn't measure up to your specifications. You're sure with Utility because it sets the industry standard for quality and performance.

#### UTILITY EVAPORATIVE AIR COOLERS AND VENTILATING EQUIPMENT FOR EVERY PURPOSE

Utility's air delivery tables are complete and authentic, derived from tests made in accordance with A.S.H.V.E. test codes. Every Utility cooler is tested in accordance with these same codes. You can meet every requirement with Utility for the line includes evaporative fan coolers, duct coolers, rotary spray washer type coolers, and blowers.



#### A FULL RANGE OF UTILITY HEATING EQUIPMENT

**Floor Furnaces**—45,000 BTU/Hr. input, flat and dual; also, 60,000 BTU/Hr. input, flat and dual (both sizes, shallow-type construction). **Wall Heaters**—Single—27,500 BTU/Hr. input; Dual—35,000 BTU/Hr. input and 50,000 BTU/Hr. input. **Forced Air Furnaces**—75,000 BTU/Hr. input; 100,000 BTU/Hr. input; 125,000 BTU/Hr. input and 150,000 BTU/Hr. input. **Unit Heaters**—4 sizes. All Utility Heating Equipment is tested and approved by A.G.A.

#### SEND FOR AIA ENGINEERING INFORMATION

For this complete technical data on Utility equipment, plus valuable tables, charts, installation details, write (on your letterhead) to Engineering Dept. Counsel from a Utility Engineer available without charge.

UTILITY APPLIANCE CORP.  
4851 S. Alameda Street, Los Angeles 58, California



EVAPORATIVE AIR COOLERS      GAS-FIRED FURNACES  
VENTILATING EQUIPMENT

Manufacturers of Gaffers & Sattler and Occidental Gas Ranges

# American Institute



# of Architects

Glenn Stanton, President  
Kenneth E. Wischmeyer, 1st Vice-president  
Norman J. Schlossman, 2nd Vice-president  
Clair W. Ditchy, Secretary  
Maurice J. Sullivan, Treasurer

National Headquarters —  
1741 New York Avenue, N. W.  
Washington 6, D. C.  
Edmund R. Purves  
Executive Secretary

Arizona Chapter:  
Edward L. Varney, President; Ralph B. Haver, Secretary,  
P. O. Box 786, Phoenix, Arizona.

Central Valley of California:  
William Koblík, President; Gordon Stafford, Vice-President;  
John W. Bomberger, Secretary; Albert B. Thomas, Treasurer,  
Secretary's Offices P. O. Box 1943, Modesto.

Coast Valleys Chapter:  
William F. Hempel, President; Lawrence Gentry, Vice-  
President; Walter Stromquist, Secretary-Treasurer, Secretary's  
office, 321 Channing Ave., Palo Alto.

Colorado Chapter:  
Henry J. Von Wyl, President; Charles H. Overholt, Secretary,  
2509 W. 36th Avenue, Denver, Colorado.

Northern California Chapter:  
Ralph N. Pollock, President; Francis J. McCarthy, Vice-  
President; William B. McCormick, Secretary; George A.  
Downs, Treasurer, Offices 369 Pine St. San Francisco.

Oregon Chapter:  
Herman Brookman, President; Donald J. Stewart, Vice-  
President; Raymond Kermit Thompson, Secretary; Millard  
H. Schmeer, Jr., Treasurer, Secretary's office 429 S. W. 4th  
Avenue, Portland.

Pasadena Chapter (California):  
Culver Heaton, President; Don Neptune, Vice President;  
Arthur Frick, Treasurer; (Mrs.) Dorothy Gray, Secretary,  
Directors, John M. Douglas, Boyd Gearty, Roland E. Coote  
and Burton Romberger, Office 1041 East Green St., Pasadena.

## STANFORD UNIVERSITY STUDENT AWARDED FELLOWSHIP FUND

Thomas T. Williamson, of Berkeley, graduating senior in architecture at Stanford University has been awarded a \$750 European travel fellowship by the Ernest A. Grunfeld Fund, according to a recent announcement by the university's department of art and architecture.

Williamson received the fellowship on the basis of his academic record, his professional promise in the field of architecture, and his personality.

Other fellowships granted by the Grunfeld Fund will go to one student from Massachusetts Institute of Technology and another from the University of Illinois.

Purpose of the award is to promote the personal and professional growth of a senior in architecture by giving him an opportunity for study abroad.

## COMPREHENSIVE EXHIBIT OF BERNARD MAYBECK WORK

The San Francisco Museum of Art recently held a comprehensive exhibition of the work of Bernard Maybeck, distinguished California and Bay Area Architect who was awarded the 1951 Gold Medal of The American Institute of Architects.

The exhibition consisted of 18-panels, drawings, plans, and photographs, illustrating the major aspects of Maybeck's work. Included were the First Church of Christ Scientist in Berkeley, considered by many to be his masterpiece; the Palace of Fine Arts, designed for the Panama Pacific International Exposition of 1915 in San Francisco; the Principia College, Elsch, Illinois; the Hearst Hall on the Campus of the University of California at Berkeley; and a number of various type residences.

Born in New York City in 1862, Maybeck founded the School of Architecture at the University of California in 1899, and since 1903 has engaged in the private practice of architecture.

## ELECTED TO AMERICAN INSTITUTE OF ARCHITECTS FELLOWSHIP

Among leading architects throughout the nation to be elevated to a Fellowship in The American Institute of Architects were nine men representing the West.

Those selected in the State of Washington were: Clyde Grainer, Seattle; B. Marcet Priceta, Seattle; and Paul Thiry, Seattle. Oregon was represented by Herman Brookman of Portland, and Walter E. Church of Portland, California was represented by

**SPEED CONSTRUCTION**  
WITH FIRESAFE, SAG-PROOF  
EASY-TO-USE

**STRAN-  
STEEL**



AVAILABLE  
**STEEL FRAMING**  
"Metal Lumber"

\*PROMPT DELIVERIES ON  
**STUDS · JOISTS · CHANNELS**  
IN STANDARD SIZES

For complete information and prompt service, phone or write

**KRAFTILE COMPANY**

NILES, CALIFORNIA NILES 3611  
SAN FRANCISCO 5: 50 Hawthorne St.—DOUGLAS 2-3780  
LOS ANGELES 13: 406 South Main Street—MUTUAL 7241

East Bay Chapter:  
Harry A. Bruno, President; Chester H. Treichel, Vice-President; Ira D. Beala, Secretary; Geary S. Mayer, Treasurer. Secretary's office, 1444 Webster St., Oakland.

Montana Chapter:  
E. Edward Scowcroft, President (Billings); I. Van Teylingen, Vice-President (Great Falls); H. C. Cheever, Secretary-Treasurer, Secretary office, Bozeman.

Nevada Chapter:  
George L. F. O'Brien, President; Aloysius McDonald, Vice-President; Graham Erickson, Secretary; Edward S. Parsons, Treasurer. Offices 160 Chestnut St., Reno.

Nevada State Board of Architects:  
L. A. Ferris, President, Reno; Walter Zick, Secretary, Las Vegas; Directors, Aloysius McDonald, Las Vegas; Russell Mills and Edward Orsonson, Reno. Office, P. O. Box 2107, Las Vegas, Nevada.

Pasadena Chapter:  
Culver Heaton, President; Don Neptune, Vice-President; Arthur Frick, Treasurer; Mrs. Dorothy Gray, Secretary. Directors John M. Douglas, Boyd George, Roland E. Coots, and Burton Romberger. Offices 1041 E. Green St., Pasadena 1.

San Diego Chapter:  
Jack R. Lewis, President; Louis A. Dean, Vice-President; Donald Campbell, Secretary; Victor L. Wulff, Jr., Treasurer. Directors C. J. Paderewski, G. C. Hatch. Secretary office, 1230 Prospect St., La Jolla.

San Joaquin Chapter (California):  
Fred L. Swartz, President, Fresno; Lloyd J. Fletcher, Vice President, Visalia; Walter Wagner, Secretary, Fresno; Robert W. Stevens, Treasurer, Fresno. Directors: Alastair Simpson, William D. Coats, William F. Baxter, Maurice J. Metz, Delegate California Council of Architects. Office 1, Sec. Fulton-Fresno Bldg., Santa Barbara Chapter (California):  
Robert I. Hoyt, President; Harold E. Burkett, Vice-President;

Roy W. Cheesman, Secretary; Lutch M. Riggs, Treasurer. Address, 242 San Marcos Blvd.

Southern California Chapter:  
John J. Landon, President; Chas. Frey, Vice-President; C. Day Woodford, Secretary; Wm. G. Balch, Treasurer, Directors, Paul O. Davis, Henry Wright, John Rex, and Kemper Noyland. Ex. Sec. Rita E. Miller. Chapter Headquarters, 3723 Wilshire Blvd., Los Angeles 5.

Spokane Chapter:  
Richard E. Eckard, President; Harry C. Waller, Vice-President 1; Kenneth D. Stormont, Vice-President 2; Victor L. Wulff, Secretary, and Carl Johnson, Treasurer. Office 1023 W. Riverside Ave., Spokane, Washington.

Utah Chapter:  
Howell O. Cannon, President; William J. Monroe, Jr., Secretary, 3707 South 32nd West Street, Salt Lake City 7, Utah.

Washington State Chapter:  
Perry B. Johanson, President; Paul Thiry, 1st Vice-President; Thomas F. Hargis, Jr., 2nd Vice-President; John S. Dettie, Secretary; Lawrence G. Waldron, Treasurer. Office 714 American Bldg., Seattle 4.

Tacoma Chapter:  
E. N. Duigan, President; P. G. Ball, Vice-President; Lyle Swedberg, Secretary-Treasurer.

Hawaii Chapter:  
James C. Simms, President; Alfred Preis, Secretary, 1507 Kapiolani Blvd., Honolulu, T. H.

CALIFORNIA COUNCIL OF ARCHITECTS  
John L. Rex, President; Wm. Koblik, Vice-President; Maurice J. Metz, Secretary-Treasurer. Executive Secretary office 3723 Wilshire Blvd., Los Angeles.

#### OTHER ARCHITECTURAL ORGANIZATIONS

San Francisco Architectural Club:  
Alfred T. Kirkevoold, President; Charles Dennis, Vice President; William C. Thiesman, Treasurer; Milton Bromberg, Secretary. Office 507 Howard Street.

Andrew T. Hass of San Francisco; Montana was represented by Chandler C. Cohagen of Billings; and Texas was represented by Maurice J. Sullivan, Houston and Thomas D. Broad of Dallas.

### ELECTED PRESIDENT OF THE AMERICAN INSTITUTE OF ARCHITECTS

Glenn Stanton, Portland, Oregon, architect was elected president of The American Institute of Architects for the ensuing year at the Institute's recent annual meeting.

Among Stanton's architectural achievements are the Oregon Journal Publishing Company plant in Portland, and the J. J. Newberry Company store in the same city. He also designed numerous Oregon school buildings including the Lewis and Clark College, and several Christian Science churches.

Stanton heads a new group of Institute officers that include Kenneth E. Wischmeyer, St. Louis, first vice president; Norman J. Schlossman, Chicago, second vice president; Clair W. Ditchy, Detroit, secretary; and Maurice J. Sullivan, Houston, treasurer.

Regional directors included Chas. O. Matcham, Los Angeles, Sierra Nevada District; Edward L. Wilson, Fort Worth, Texas District; and Leonard H. Baily, Oklahoma City, Central States District.

### SOUTHERN CALIFORNIA CHAPTER

"Editors' Night" was observed on June 12th with members rubbing elbows with the newspaper elite of northern California. Among the speakers representing the Fourth Estate were Russell Quisenberry, President of the Valley Times and Chairman of the California-Nevada Press Association who spoke on "Sub-Urban Responsibility;" Ed Ainsworth, Los Angeles Times, whose subject was "Architecture The Oldest Legitimate Art;" Walter Scratch, Holly-

wood Citizen News, "Architects Place in the Community;" John Server, Southwest Builder and Contractor, "Architecture Greatest Business Agent;" and Jose Rodriguez, Los Angeles Examiner, who spoke on "Architectural Development in Southern California."

Robert B. Stacy-Judd was Program Chairman of the meeting.

Dr. Karl Wolf, formerly Director of the Modern Institute of Art recently spoke before Chapter members on "Form, Function and Symbols."

### EAST BAY CHAPTER A.I.A. TOURS KRAFTILE PLANT

In conjunction with a program of construction industry education, members of the East Bay Chapter of the A.I.A., were recently taken on a tour of the Kraftile Company Plant at Niles, California, where they were shown the methods and process of tile manufacturing.

Arrangements for the tour were handled by Chester H. Treichel, program chairman of the Chapter, and details of the plant inspection were handled by Chas. W. Kraft, president of Kraftile Company.

### ANNUAL A.I.A. CONVENTION SCHEDULED FOR SAN DIEGO

October should be an outstanding month for California architects with the largest convention to date planned at the Hotel del Coronado, across the bay from San Diego.

Reports from Burton Romberger, Convention Chairman, indicate that every effort is being made to fill the dates, October 4th, 5th and 6th, with such well selected and many varied activities that it appears the convention is already assured a tremendous success.

(See Page 38)



# WITH THE ENGINEERS

## Structural Engineers Association of California

Arthur W. Anderson, President; Harold P. King, Vice-president; Henry J. Degenkolb, Sec.-Treas.; Office of Sec., 405 Montgomery St., Room 1121, San Francisco.

## Structural Engineers Association of Northern California

John E. Rinne, President; John J. Gould, Vice-President; Wm. W. Brewer, Sec.; Franklin P. Ulrich, Treas.; Directors, Walter L. Dickey, Leslie W. Graham, Hyman Rosenthal, and Howard A. Schirmer.

## Structural Engineers Association of Central California

William H. Petersen, President; Walter S. Wassum, Vice President; O. T. Illerich, Sec. Treas.; Ernest D. Francis, M. A. Ewing, and Arthur A. Sauer, directors. Office O. T. Illerich, c/o Div. of Arch., Sacramento.

## American Society of C. E. San Francisco Section

Clement T. Wiskocil, President; John S. Longwell, Vice-president; J. G. Wright, Vice-president; H. C. Medbery, Treasurer; R. D. Dewell, Secretary. Secretary's Office, 604 Mission St., San Francisco.

## Structural Engineers Association of Southern California

Donald F. Shugart, President; Harold P. King, Vice President; Robert J. Short, sec.-Treas.; Directors, William T. Wheeler, William T. Wright, Ernest C. Hillman, Jr., John Case, and John K. Minasian. Office, 202 Architects Bldg., Los Angeles 13.

## Structural Engineers Association of Oregon

R. Evan Kennedy, President; Guy H. Taylor, Vice President; James R. Griffith, Secretary-Treasurer; Directors Jerome A. McDevitt, H. Loren Thompson, and Robert L. Tidball. Offices, Portland.

## Puget Sound Engineering Council (Washington)

R. E. Kister, A. I. E. E., Chairman; E. R. McMillan, A. S. C. E., Vice Chairman; L. B. Cooper, A. S. M. E., Secretary; A. E. Nickerson, I. E. S., Treasurer. Offices, L. B. Cooper, c/o University of Washington, Seattle 5, Washington.

## American Society Testing Materials

### Northern California District

L. A. O'Leary, Chairman; P. V. Garin, Vice-chairman; H. P. Hoopes, Sec. Office Sec., 1550 Powell St., Emeryville, Calif.

## STRUCTURAL ENGINEERS ASSOCIATION OF SOUTHERN CALIFORNIA

Charles M. Corbit, Jr., of the American Institute of Steel Construction was the principal speaker at the regular June meeting. He discussed "The Availability of Structural Steel" and included a general briefing on the government's Controlled Materials Plan for the construction industry.

Corbit also served as moderator of a panel discussion on the subject of "Fabricated Structural Steel" which included discussions by R. W. Binder, Chief Engineer, Bethlehem Steel Company; Chas. Goddard, Chief Engineer, Apex Steel Corporation; Chas. Orr, Assistant Chief Engineer of Consolidated Western Steel Corporation; and Cliff Little, Sales Manager of the Union Steel Company.

New Members introduced at the meeting included: Edward M. O'Conner, Associate Member; and Henry J. Senecal, Allied Member.

Announcement was made that the Association's annual Field Day would be held at the Oakmont Country Club on Friday, August 3rd.

## CALIFORNIA STATE LEGISLATURE ACTS ON ENGINEERING MEASURES

The Education Committee of the California State Legislature recently rejected AB 2831, which would have removed from the jurisdiction of the Division of Architecture all public school buildings having less than nine class rooms; and AB 2832 which provided for standard plans for public school buildings having not more than two class rooms.

Among the engineers appearing before the Education Committee in opposition to the bills were: Mark Falk, Leslie Graham, Robert Dalton, Wesley Hayes, Robert Dewell, E. Verner, and Harold Hammill.

## STRUCTURAL ENGINEERS ASSOCIATION OF NORTHERN CALIFORNIA

"Structural Lightweight Concrete" was the subject of a talk by Wallace Grant, Concrete Technologist of the Readyxmix Concrete Company, Ltd., at the regular May meeting of the Association, while the June meeting was devoted to the annual "Beef" Session when members are given an op-

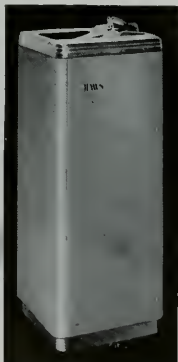

Always  
Specify  
**HAWES**  
for Highest  
Quality

- Sanitary Drinking Fountains • Electric Water Coolers • Drinking Faucets, Equipment, Filters and Accessories.

A reputation for reliability since 1909. Check in Sweet's or write for complete HAWES catalog.

## HAWES DRINKING FAUCET CO.

1441 FOURTH STREET (Since 1909) BERKELEY 10, CALIFORNIA  
Agents and Sales Representatives in All Principal Cities

portunity to "speak their mind" or forever (a year at least) hold their peace.

The Joint Committee on Lateral Forces announced its report has been published by the American Society of Civil Engineers under the title "Lateral Forces of Earthquake and Wind." Copies may be obtained by writing to the Society's offices in New York.

The Annual Picnic will be held on Saturday, July 14 at the Old Hearst Ranch, near Pleasanton, with arrangements completed for a full day of golf, soft-ball, tennis, swimming, horseshoe pitching, and steak dinner. General arrangements are in charge of Armond Nishkian. Stan Bernhard, Harry B. Corlett, and Bill Brewer. M. C. Poulsen and Lloyd White are in charge of the Golf tournament; Buzz Wright is in charge of softball; and Jack Long is in charge of the Tennis.

New Members include: Robert A. Hanson, Douglas J. Murray, Albert T. Simpson, Ned P. Clyde, Junior Member, Fred A. Sandermann, and Affiliate Members, Theodore E. Newman, Marshall H. Pitney, Charles E. Pynchon, Jr.

#### FEMINERS

The June 20 meeting at the Elks Club, San Francisco, with luncheon at 12:30 noon marked the third of a series of interesting Spring meetings.

On May 16th the monthly meeting was held at the Art and Garden Center in Walnut Creek, with Russell Graff, Charles Scurich and Harry Corlett leading a general discussion on activities of the Structural Engineers Association of California and the Annual Convention.

The second successful meeting was devoted to an evening of dinner-dancing at the Claremont Hotel in Berkeley with more than thirty couples participating.

#### STRUCTURAL ENGINEERS ASSOCIATION OF CALIFORNIA

Harry B. Corlett, Chairman of the Committee on Attendance and Registration for the Annual Fall Convention of the Structural Engineers Association of California, announces that plans are rapidly being crystallized for this year's event.

The Convention has been set for October 11 to 13 and will be held in Yosemite Park with general convention headquarters at the Ahwahnee Hotel.

Preparation of the program and schedule of entertainment is being formulated by a number of special committees, and will be announced soon.

#### ELECTRICAL MAINTENANCE ENGINEERS ASSOCIATION OF SOUTHERN CALIFORNIA

Gordon E. McIntyre, representing the Dow Corning Corporation's Michigan Plant, addressed the members of the Electrical Maintenance Engineers Association of Southern California recently and

presented a story of the use of silicones in Class H insulation and silicone greases for increasing the life of an electric motor.

Following McIntyre a round table discussion disclosed a number of interesting personal experiences with Class H Insulation.

More than 160 members were present at the meeting.

"Do's and Don't's of Electrical Maintenance" was the subject of a talk given at the June meeting by R. Gubser of the California Consumers Corporation. Gubser illustrated his comments with a number of examples of industrial failures which have come to his attention.

#### FIRST U. S. CONFERENCE ON PRESTRESSED CONCRETE

More than 35 engineers and architects have been tentatively selected to speak before the first U. S. conference on prestressed concrete scheduled for August 14-16, at the Massachusetts Institute of Technology, according to Prof. Myle J. Holley, Jr., associate professor of civil engineering, and conference coordinator.

Co-sponsors cooperating with M.I.T. are the American Concrete Institute, The American Institute of Architects, the American Railway Engineer-

(See Page 33)



Always  
Specify  
**HAWS**  
for Highest Quality

**A complete line** of fountains, electric water coolers, faucets, filters and accessories. • Individual or multiple installations. • A reputation for reliability since 1909. • Check in Sweet's or write for complete HAWS catalog.

**HAWS DRINKING FAUCET CO.**

1441 FOURTH STREET · Since 1909 · BERKELEY 10, CALIFORNIA

Agents and Sales Representatives in All Principal Cities

# PRODUCER'S COUNCIL PAGE

The National Organization of Manufacturers of Quality Building Materials and Equipment  
affiliated with THE AMERICAN INSTITUTE OF ARCHITECTS

President, Arthur C. Stout  
Natural Gas Equipment, Inc.  
1150 Folsom Street

Vice-President, Fred A. Figone  
Otis Elevator Company  
1 Beach Street

Secretary, Howard Naleen  
E. F. Hauserman Company  
500 Second Street

Treasurer, A. L. West, Jr.  
Aluminum Company of America  
Russ Bldg.

Edited by Carl B. Frank, DETROIT STEEL PRODUCTS CO.



## TABLE TOP MEETING

On Wednesday, May 23, the Chapter held its annual Table-Top Exhibit in the Terrace Room of the Fairmont Hotel. The exhibit was open to invited architects and engineers from 3:00 in the afternoon until 7:00 P.M., with cocktails served from 5:00 until 7:00. Forty-one companies displayed their wares and the accompanying picture shows one corner of the exhibit room.

We thought our exhibit was a big success last year when we had a total attendance in the neighborhood of 450 people, however, this year that record was surpassed with a total attendance of 560, approximately 500 of whom were architects and engineer guests. All in all, we feel our exhibit proved an outstanding success.

## ANNUAL SPORTS MEETING

In the last issue, we mentioned our Sports Dinner and stated that this meeting will take place on June 15 at the California Country Club. Cow Pasture Pool will be the order of the day with flights starting just after sunrise. I am given to understand that there will be an abundance of trophies for such accomplishments as low gross, low net, high score in the 19th hole, and best slice of the day. Also, the Ray Brown trophies—such as the Ray Brown Perpetual, the Ray Brown Memorial, the Ray Brown Dub's Flight, and the Ray Brown Hole-in-One.

After the day's activities on the green, there will be a dinner and program with Norman Brown of Bell & Gossett acting as master of ceremonies.

USE QUALITY PRODUCTS



CONSULT AN ARCHITECT

The entire program has been in the charge of Emil teGroen of Cambridge Tile Co., and Emil has certainly done a bang up job in getting the show together.

#### COMMITTEE CHAIRMAN APPOINTMENTS

Art Staat recently announced that George Conroy of Johns-Manville has been honored (or stuck depending on viewpoint) with the general chairmanship of the Christmas Jinx. By way of explanation, this is no easy job since it consists partially of writing the Christmas play, making hotel arrangements, dinner arrangements, selecting a cast for the play, acting in the play, choosing a master of ceremonies, arranging for costumes, and giving monthly reports to the executive committee on his progress. In addition to this, a side duty is to attempt to earn a living if you can find time. George's only vengeance will be the fact that he will have a chance to appoint additional members to this committee to help out.

#### ROLE OF ATOMIC ENERGY

(From Page 25)

ation "faces" between different grades and types of gasoline, diesel oil and stove oil carried in a single eight-inch pipeline from Salt Lake City to Boise, Idaho and eventually to Pasco, Washington. With the radioisotope it is possible to chart the movement of the oils and gasolines, which do not blend because of differing densities, so that they can be removed at different tank points without intermixing.

These are only a few of the many industrial applications of radioisotopes. The effect of their use in this way is a subtle one, but it is one that will be felt increasingly in our economy.

In the field of agriculture radioisotopes have been used:

To determine the effectiveness of insecticides in killing insects; to find more effective ways of treating plant diseases; to determine the efficiency of various fertilizers and the most effective means of placement and use; to determine better and more efficient ways of feeding livestock, of breeding better livestock and of keeping them in good health.

The physical well-being of the populations has a great deal to do with the economic health of a nation or of the world.

As tracers, radisotopes are helping scientists to understand life processes and mechanisms which have been only partly understood for lack of such a key to unlock their secrets. With a better understanding of life processes will come a better understanding of how to keep the body free from debilitating and deadly diseases.

Radioisotopes are finding an early practical application in diagnosis and in treatment.

The tremendous amount of potentially releas-

*Looked into  
all these lately?*

It's growing all the time—the list of uses for which gas is superior:

- |                           |                  |
|---------------------------|------------------|
| Cooking                   | House heating    |
| Refrigeration             | Clothes drying   |
| Water heating             | Garbage disposal |
| All-year air conditioning |                  |

If your technical data files are low on any of these, why not get in touch with your Gas Company for details?

*The West  
prefers*

**GAS**



**BETTER • QUICKER • CHEAPER**

**HOLLYWOOD JUNIOR**  
COMBINATION  
SCREEN and METAL SASH DOOR  
★  
*The "WEATHER-WISE"  
DOOR!!*

**A VENTILATING SCREEN DOOR  
A SASH DOOR  
A PERMANENT OUTSIDE DOOR  
ALL 3 IN 1!**

Discriminating home owners and architects have chosen Hollywood Junior as the TRIPLE DOOR VALUE in the COMBINATION SCREEN and METAL SASH DOOR field! A sturdy dependable door, constructed of quality materials, HOLLYWOOD JUNIOR'S EXCLUSIVE PATENTED FEATURES have outmoded old-fashioned screen doors and other doors of its type entirely!

**IT GUARANTEES YOU YEAR 'ROUND  
COMFORT, CONVENIENCE and ECONOMY**

WE ALSO MANUFACTURE A COMPLETE LINE OF  
SHUTTERS, C. C. DOORS, SCREENS, SCREEN DOORS, LOUVRE DOORS

**WEST COAST SCREEN CO.**  
1145 EAST 33rd STREET      ADAMS 11108      LOS ANGELES, CALIFORNIA

★ ◆ WRITE FOR FREE ILLUSTRATED LITERATURE ◆ ★



able energy contained in uranium has made it an intriguing potential source of useful power. According to Schurr and Marschak one pound of uranium, fully consumed, would yield about 2½ million KWH of electric power, which is equivalent to approximately 1,250 tons of bituminous coal.

As far as we can determine with the knowledge we have available to us today it is not possible to convert fission energy into electric energy without passing through a steam or gas turbine. All we can replace with nuclear energy components in the conventional power plant, therefore, is the fire box and the boiler. All the heat transfer apparatus, the turbines, the generators and the distribution system would remain the same. What we have then in uranium, as far as we know now, is a substitute for coal or natural gas or petroleum fuel in an otherwise similar system.

Uranium has some advantages (size) over other types of fuel and also some disadvantages (shielding) but ultimately the place it will find, unless some new technique or information is uncovered, will be determined by its relative cost in various areas as compared with other forms of fuel.

But there is enough energy locked up in the world's uranium resources to have a definite impact on world economy when it becomes feasible to release it in the form of electric power.

The program of the Commission in this field includes:

An experimental breeder reactor — to produce some useful power as a byproduct; a submarine reactor which will give us the first use of atomic power for propulsive purposes; and certain experimental reactors, such as the Materials Testing Reactor which will add to our knowledge of how to build future reactors.

The net result of these will be to demonstrate the technical feasibility of atomic power for useful peacetime purposes.

The use of nuclear reactors to produce useful amounts of power economically becomes much more feasible—particularly at this early stage of development—if the fissionable material produced in the reactor can be sold to the Government and the return applied to the cost of the power. This intriguing prospect has resulted in proposals from private industrial concerns under which the firms would be permitted to study the feasibility of developing and operating reactors for the production of plutonium and electric power.

The studies that will be undertaken as a result of these proposals will add much to our understanding of the problems associated with the economic production of atomic power.

When electricity was discovered no person foresaw its potential uses or the myriad devices that were developed and which found a place in our economy because of it.

**BRONZE PRODUCTS**  
*by* **GREENBERG**

**Your best and nearest source for standard and special Bronze products**



STABILITY since 1854

**M. GREENBERG'S SONS**

765 Folsom St. • San Francisco • Calif. • EXbrook 2-3143

Manufacturers of Fire Hydrants and Fire Protection  
Brass Goods • Industrial, Navy and Maritime  
Brass Valves and Fittings • Plumbing and  
Hardware Brass Specialties • Bronze Plaques,  
Letters and Name Plates.

LOS ANGELES • SEATTLE • PORTLAND • SPOKANE • SALT LAKE CITY • DENVER • EL PASO • NEW YORK • HARTFORD • WASHINGTON, D. C.

And today no one knows what techniques or what instruments, for releasing and using the energy locked in the heart of the atom, will result decades from now. All we can do is seek, working toward our short range goals with our longer range goals in mind, and with a constant effort to turn up new information that may revolutionize our current thinking.

Our guesses of today will, I am sure, seem quite feeble 20 years from today. I would make my short range predictions on the conservative side. I would make my long range predictions on the enthusiastic side. I would hope that my long range predictions would prove true both in our short and long range programs.

## WITH THE ENGINEERS

(From Page 29)

ing Association, the American Society of Civil Engineers, the Associated General Contractors of America, and the Portland Cement Association.

The M.I.T. departments of architecture, building engineering and construction, and civil engineering will be hosts to the meeting.

Among the scheduled speakers are F. W. Panhorst, Bridge Engineer, California State Division of Highways; R. F. Blanks, Chief, U. S. Bureau of Reclamation, Denver, Colorado; and H. J. Hansen, Head, Structures Research Department, U. S. Naval Civil Engineering Research and Evaluation Laboratory, Port Hueneme, California.

## NEW ENGINEERING INSTITUTE PUBLISHES STUDY BROCHURE

The Earthquake Engineering Research Institute, a non-profit engineering scientific association organized a number of months ago, and which is dedicated to the objective of public welfare service in the field of engineering seismology, has just published a brochure covering the activities of the Institute.

Among the subjects covered in the new pamphlet are: "Why the Institute Was Formed;" "How the Institute Was Formed;" "The Functions of the Institute;" and "The Policies and Plans of the Institute." Copies are available from the Secretary John A. Blume, 45 Second Street, San Francisco.

Officers of the Institute include: George W. Housner, President; Samuel B. Morris, Vice-president; Franklin P. Ulrich, Treasurer; and John A. Blume, Secretary. Board of Directors are Geo. W. Housner, Samuel B. Morris, Franklin P. Ulrich, John S. Bolles, Harmer E. Davis, D. C. Willett, and John A. Blume.



New terrazzo lobby in \$1,700,000 Field House is Hillyard-treated for permanent beauty, and easy maintenance. Terrazzo during construction for slow, hard-as-flint curing, Onex-Seal for a safe beauty finish, Super-Hil-Tone for daily maintenance.

Glamming gymnasium floor in Field House guarantees non-skid no-glare play . . . is sealed with Hillyard Wood Primer, coated with Star Gym, the finish for champions now in use on 15,000 gym floors. Needs only occasional Super Shine-All cleaning.



### HILLYARD FLOOR CARE IN THE BLUEPRINTS at the RICE INSTITUTE

This recently completed field house is an excellent example of the way functional floor design, coupled with proper Hillyard treatment materials, is meeting present educational needs for beautiful floors that BASICALLY assure future, low cost maintenance.

From blueprint planning, through every stage of construction, architects, flooring contractors and school planners relied freely on the counsel of the Hillyard Maintainer in the Texas territory. Choose only those Hillyard products specialized for the type of floor.

Countless schools, universities, clubs, factories, institutions, hotels, hospitals for many years have relied on approved Hillyard Care. We'd like to show you its cost-saving advantages.



### OUR FLOOR EXPERTS WILL HELP YOU . . .

Whether you are planning a new building, remodeling, or "dressing up" an old one—our experienced Maintainers are at your service. It is wise to get their helpful suggestions BEFORE you act. Advice is FREE.

*on your staff not your payroll*



**St. Joseph, Missouri**  
Branches in Principal Cities

### WRITE FOR CURRENT LITERATURE TODAY

Hillyard Chemical Co.

St. Joseph, Mo., Dept. N 1-6

Please send me FREE current catalog information on approved Hillyard Floor products.

Name.....Title.....

Institution.....

Address.....

City.....State.....

# ELECTROMODE ALL-ELECTRIC ROOM HEATER... THE WORLD'S FINEST!

**First choice of architects and engineers in thousands of California homes — for these reasons:**

(1) **SAFETY SWITCH**—Automatically shuts off current if temperature of element rises above normal operating level. Prevents overheating in case fan fails to operate or when circulation of air is retarded by furniture or drapes.

(2) **G. E. FAN**—Famous for long life and quiet operation. Its factory sealed motor never needs oiling!

(3) **DOWN-FLO CIRCULATION**—Warmed air is gently fan-forced down into the living zone and does not pile up wastefully at the ceiling. This exclusive method of distributing heat uniformly throughout a room also prevents smudge on wall above heater.

(4) **PATENTED ELEMENT**—The greatest feature any all-electric heater ever had—and only Electromode has it! No exposed red-hot wires—no danger of fire, shock, or burn! It consists of a nickel chromium wire resistor coil, insulated with a fused oxide powder, encased in a seamless metal tube, and embedded in a finned aluminum casting, which completely seals the tube. There is perfect thermal contact between all portions of the element, assuring superior heat diffusion. Heat transfer surface is 838 square inches—many times greater than a bare coil—which means maximum heating efficiency at minimum cost. Designed in every detail for a life-time of trouble-free service!

(5) **SILVER-GREY FINISH**—Blends well into any home decorative scheme. Face plate is practically flush with wall. Smooth, hammertone finish is easy to keep clean.

(6) **STANDARD WALL BOX**—Easy to install. Regardless of capacity, all Electromode Down-Flo heaters have the same size wall box and fit between standard studs. Installation is just as simple as wiring in a standard 240-volt outlet.



*Electromode Down Flo heaters are practically flush with the wall.*

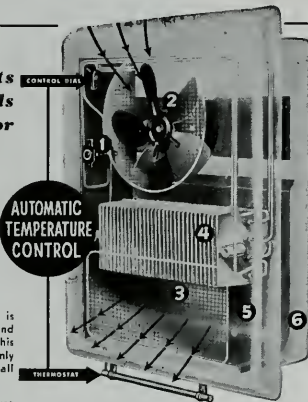

*Approved by Underwriters' Laboratories*

**AUTOMATIC CONTROL**—If desired, temperatures varying from 55 to 85 degrees can be maintained simultaneously in different rooms of the same house! Each heater has its own built-in thermostat of the reliable, hydraulic type. A finger-tip control dial is located within easy access near the top of the heater, on the outside.

#### Write for Catalog

Electromode heaters are manufactured by Electromode Corp. of Rochester, N. Y., the world's leading exclusive manufacturer of all-electric heaters. They are distributed in Northern California by Dunham, Carrigan & Hayden; General Electric Supply Corp.; Graybar Electric Co., Inc.; Leo J. Meyberg Co.; The Thomson-Diggs Co.; and other leading wholesalers. For complete information on Electromode heaters for domestic, commercial, and industrial use, write to Dept. A41, Russell & Co., 1355 Market St., S. F. 3.



*Whatever the main heating system may be, every home should have an Electromode heater in the bathroom for quick comfort on chilly mornings. This wall type electric heater may be automatic or non-automatic. It operates on standard 110 volt wiring, comes in white or chrome finish, and has all safety features of other Electromodes!*

**ELECTROMODE**  
*Room Heaters*

#### REMODEL SENATOR HOTEL, SACRAMENTO

A plan to remodel and modernize the Senator Hotel in Sacramento has been announced. It will include converting part of the first floor into stores; addition of new air conditioning system; remodel the elevators, and modernize the kitchen.

Cost of the project is \$800,000. Leonard F. Starks of Sacramento is the architect.

#### LOS ANGELES BUILDING BOOMS

Since the end of World War II, more than 408,249 new dwelling units and apartments have been started in Los Angeles county.

In the first two months of this year \$58,718,649 worth of building permits have been issued. This exceeds by \$10,965,358 the combined totals of Chicago and Detroit, and is the largest construction volume of any city, except New York, in the nation.

#### HOSPITAL EDITION

The San Rafael General Hospital have announced construction will soon start on the addition of an additional story to the present 3-story building. The new floor will be of reinforced concrete and frame construction.

H. H. Winner, of Ross, is the architect.

#### ARCHITECT SELECTED

The architectural firm of Ward & Bales, San Francisco, has been chosen by the Housing Authority of San Francisco to draft plans for a 200 unit low income housing project in San Francisco.

The construction will be an addition to the Potrero Terrace project.

#### APARTMENT ZONING PERMIT IN ALAMEDA

The Alameda Bayside Construction Company, subsidiary of the Congress Construction Company of Alameda, has been granted a permit to construct 103 apartment buildings in Alameda at an estimated cost of \$12,500,000. The structures are to be of 3-story frame and stucco construction.

Spencer & Ambrose of San Francisco are the architects.

#### FEDERAL FUNDS OK FOR AIR FORCE BASE

Federal funds have been allocated for the construction of a number of projects at the Castle Air Force Base at Merced, California, according to a recent announcement.

Included in the work to be done is construction of new landing strips, parking ramps, navigation aids, storage facilities, a base communications building, and additional barracks for air force personnel.

Total funds approved for the work amount to \$4,354,500.

#### BUREAU OF RECLAMATION AT DENVER SEEKS BIDS

Invitations to bids have been issued by the Bureau of Reclamation at Denver, Colorado, for the construction of the Trauger Pumping Plant and high level distribution reservoir in the Lindsay-Strathmore irrigation district of California.

#### ARCHITECT CLOSES OFFICE AT STOCKTON

Architect Joseph Losekann has announced the closing of his offices in the Elks Building in Stockton. No announcement was made as to the future plans of Architect Losekann.



**SACRAMENTO COUNTY TO BUILD NEW HOSPITAL**

Plans are under way for the construction of a new 100-bed hospital building in Sacramento to be built by the Sutter Hospital at an estimated cost of \$1,000,000.

Facilities will be especially designed for women and children patients.

**LOW INCOME HOUSING PROJECT FOR WINTERS**

The Yolo County Housing Authority has announced construction of a 30-unit low income housing project to be built in Winters (California) at a cost of \$270,000.

The units will be 1-story duplex residences of frame and stucco construction.

Joseph Milano of Berkeley is the architect.

**HOSPITAL ADDITION AT SAN JOSE**

The San Jose Hospital will construct a 70-bed addition to the present hospital buildings.

Of 4-story design the building will be of reinforced concrete and structural steel construction and will cost \$700,000. State and Federal funds have been approved.

D. D. Stone and Lou Mulloy of San Francisco are the architects.

**NEW DUPLEX RESIDENCES**

The Gamel Construction Company of Mountain View is constructing a group of 16 duplex residences in the Sunset Garden Subdivision of Mt. View. The homes are of frame and stucco construction and will sell for \$18,000 each when completed.

**NEW HANGAR AT PALMDALE AIRPORT**

Construction of a modern new airplane hangar at the Palmdale Airport has been announced by E. H. Farmer, plant engineer for Lockheed Aircraft Corp.

The main portion will measure 150x160 ft. while connected with it will be a 30x160 ft. four level section, and will cost \$400,000.

Farkinson, Powelson, Briney, Bernard & Woodford of Los Angeles are the architects.

**LOW BIDDER ON PHOENIX SCHOOL**

The Wes Meyers Construction Company of Phoenix was the low bidder for the construction of an "H"-shaped classroom building for School District No. 31 of Phoenix at \$343,056.

Lescher & Mahoney of Phoenix are the architects.

**ARCHITECT FOR SCHOOL AUDITORIUM**

Architect H. Rafael Lake and Elso B. DiLuck of Fresno, have been commissioned by the Fresno Board of Education to draft plans for the construction of a new auditorium building for the Roosevelt High School.

Funds in the amount of \$1,000,000 have been made available for the project.

**PERMANENTE TO BUILD HOSPITAL IN SAN FRANCISCO**

The Permanente Foundation Hospital with general headquarters in Oakland, have announced the construction of a 6-story, reinforced concrete hospital building in the new Anza Vista Tract in San Francisco.

The building will contain 210 beds and will cost \$2,300,000.

Architects for the project are Wolf & Phillips of Portland, Oregon.

- architects
- designers
- draftsmen
- engineers

*Write Today*  
identifying your trade

for  
**Complimentary  
HEATFORM\*  
FIREPLACE  
BOOK**

This 36-page book contains 50 beautiful interiors and fireplace designs.

These photographs were selected from our National Photo Prize Contest. The book contains elevations, sections and plans for installation of two HEATFORM Models: "A" and "S." It also shows proper location of fireplace for best heating results; how to heat adjacent rooms on first and second floor, and other valuable fireplace information you will want.



• Model "A" is the standard HEATFORM used in homes throughout America for the past 30 years. Complete information on Model "A" and Superior Form Dampers is contained in:

- 1951—Sweet's Architectural File, Section 29k/Su
- 1951—Sweet's Builder's File, Section 4-d/Su
- 1950-51—Western States A-E-C Catalog File

Model "S" completely described in HEATFORM Fireplace Book.

**SUPERIOR FORM DAMPER**

— the Architects' Friend — always building good fireplaces without your personal supervision. It saves in labor time — no forms to build, no bricks to cut, no throat to plaster. Cracking of masonry is eliminated by use of rack wool and detached lintel bar. It is constructed of heavy steel for lifetime service.

\* T. M. Reg.

**SUPERIOR FIREPLACE CO.**

Dept. AE 511  
1708 East 15th St.  
Los Angeles 21, Calif.

Dept. AE 511  
601 North Point Rd.  
Baltimore 6, Maryland

Pioneer manufacturers of heat circulating fireplaces and Form Dampers. Nationally advertised to millions of potential users. Sold through leading building supply dealers everywhere.

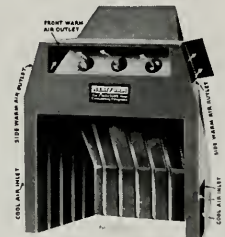
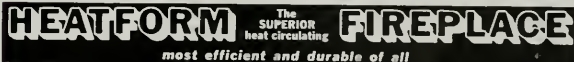

HEATFORM Model "A"  
Eight stack sizes 24" to 72"



HEATFORM Model "S"  
View of Fire from Front & Side

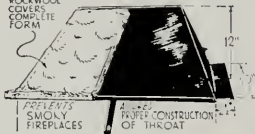

SUPERIOR FORM DAMPER  
the Architects' Friend



# CLINTON CONSTRUCTION CO.

OF CALIFORNIA

**General Contractors**

923 FOLSOM STREET • SAN FRANCISCO

SUtter 1-3440

# HOGAN LUMBER CO.

Wholesale and Retail

**LUMBER**

**MILL WORK • SASH & DOORS**

Office, Mill, Yard and Docks

SECOND AND ALICE STREETS • OAKLAND, CALIF.

Telephone GLencourt 1-6861



**COSTS 50%  
LESS THAN "BULK" or  
"BLANKET" TYPES OF INSULATION  
... AND, IN ADDITION, ACTS AS A VAPOR-  
BARRIER (MEETS FHA REQUIREMENTS). COSTS  
LESS TO APPLY. WRITE FOR SAMPLES AND  
FULL INFORMATION ON ALL USES!**

**The SISALKRAFT CO.**

55 New Montgomery St. San Francisco 5, California

# JUDSON PACIFIC-MURPHY CORP.

Steel Fabricators  
and  
Erectors

REINFORCING STEEL  
STRUCTURAL STEEL  
BRIDGE CRANES

4300 EASTSHORE HWY.  
EMERYVILLE, CALIF.

Phone:  
OL 3-1717

## BOOK REVIEWS PAMPHLETS AND CATALOGUES

**CONTEMPORARY LIGHTING IN MODERN AND TRADITIONAL INTERIORS.** Illuminating Engineering Society, 51 Madison Ave., N. Y. Price \$1.00.

This 64-page book describes a wide variety of lighting ideas for the principal rooms in present-day homes whether furnished and decorated in modern or any of several traditional styles.

There are 130 large scale illustrations showing actual interiors and sketches of construction details for numerous new ideas in the use of light and color in different home surroundings: from Colonial and Early American through Victorian and Modern decorative schemes.

The book provides an excellent working guide for home builders, contractors, architectural and interior designers, and home makers.

**PLANT LAYOUT—Planning and Practice.** By Randolph W. Mallick and Armand T. Gaudreau, John Wiley & Sons, Inc., 440 4th Ave., New York, Price \$7.50.

A practical book with material called from years of actual experience, written with the administrative executive and plant engineer in mind, and is a handy guide for senior and junior engineers; and a handy reference for engineering colleges and schools of business administration.

Covers the subjects of engineering techniques; plant layout projects; re-layouts and new plants; designing; and evaluation. Numerous illustrations, charts and drawings.

**A NEW THEORY OF GRAVITATION—By Dr. Jakob Mandelker.** Philosophical Library, New York, Price \$2.75.

This book on a new theory of gravitation, which harmonizes with the popular nature of electrostatic and electromagnetic fields, has been written by Dr. Jakob Mandelker, Assistant Professor of Mechanics at the Georgia Institute of Technology, Atlanta, Georgia.

The author's approach to this perennial problem is both simple and direct and is based upon the premise that radiation is a manifestation of force directly opposed to gravitation.

## NEW CATALOGUES AVAILABLE

Any of the catalogues or folders described here may be obtained by forwarding your request as indicated in the coupon below to the office of the ARCHITECT & ENGINEER. Merely mark the items you want and clip or paste the coupon to your letterhead.

**284. SOME FACTS YOU SHOULD KNOW ABOUT LACQUER.**

The reasons for the ready availability of lacquer today, and for the foreseeable future, are given in a new leaflet "Some Facts You Should Know About Lacquer," published by Hercules Powder Company. The leaflet points out that of all the production-line finishes in use today nitrocellulose lacquer is the least vulnerable to shortages. Basically the reasons for the availability of lacquer are: ample production capacity for both nitrocellulose and lacquers to take care of military and essential civilian demands; lacquer formulations are so flexible that lacquer is not tied to any one critical material, or to any group of materials. 4 pages, 6/4/51.

**285. STEEL SWIMMING POOLS.** A new informative 12-page swimming manual has just been prepared by Koven Steel Swimming Pools. This manual covers in detail all of the factors involved in planning Municipal and Community pools, pools for hotels, clubs and private institutions and private pools. The manual also discusses the advantages of a steel swimming pool and gives full design, construction and erection details of the Koven Large Pools and the Koven Standard Pools. 12 pages illus., 6/51.

**286. NEW ADHESIVE BACKED FELT STRIPPING.** A folder published by the King Felt Engineering department illustrates the properties and uses of Adhesive backed reinforced felt for weather stripping, thermal insulation, sealing against dust and many protective applications. King Felt is manufactured in rolls 1/4" to 66" wide and 1/64" to 1/4" thick. 5/28/51.

**287. FIREPLACE BOOK.** A book containing 50 interiors and fireplace designs is available from the Superior Fire Place Company. The book contains elevations, sections and plans for installation of two Heatform Models. It also shows proper location

of fireplace for best heating results; how to heat adjacent rooms on first and second floor, 36 pages, illus., 6/51.

**288. REVISION OF FIRE RESISTIVE RATINGS.** A new comprehensive summary of Metal Lath and Plaster Fire Resistive Ratings—First Revision—April, 1951, has been prepared by the Metal Lath Manufacturers Association. There are four pages of tables, listing 85 fire-resistance ratings ranging from one hour to four hours. The summary gives the thicknesses required in providing metal lath and plaster fire protection for columns, steel beams, girders and trusses, various floor assemblies (including steel joist, cellular, and wood joist) and steel roof deck assemblies. 4 pages, 4/51.

**289. PRACTICAL POINTERS ON AIR CONDITIONING.** "Practical Pointers on Air Conditioning," a booklet for both layman and expert, covering all phases of air treatment and air handling, has just been published by the United States Air Conditioning Corporation. The new, liberally-illustrated booklet describes the properties of air, the problems of its control and the application of diversified types of equipment to solve these problems. 16 pages, illus., 1059 FC, 5/51.

**290. LIGHTING GUIDE TO BETTER DRAFTING.** A "Lighting Guide to Better Drafting" has just been produced by the Lamp Department of the General Electric Company because, as this eight-page 8 1/2 x 11 inch leaflet indicates: "Production for national mobilization begins in the drafting room." The guide makes liberal use of drawings and photographs to illustrate proper lighting for straight-edges and shiny surfaces, proper positioning of drafting boards, and recommended types of lighting systems for better drafting. Also given are helpful hints on the right illumination for tracing tasks, for reference and index systems, and for comfortable seeing of clerical work in drafting operations. LS-137, 8 pages, illus., 5/24/51.

**291. REVISED BOOKLET ON CONCRETE WALL FORMS.** Now available from Symons Clamp & Mfg. Co. is the revised Directions Booklet on Symons Wall Forms. Complete details are given for the erection of Symons Forms including panel alignment, stripping, spacing of ties, safe work load for ties and pressure per square foot that the forms will stand. Information also includes how to get the best performance and longest use out of Symons Forms. 8 pages, illus., 4/6/51.

**292. PERIMETER INSULATION FOR STANDARD HEATING SYSTEMS.** A booklet relating "The Story of Perimeter Insulation for Standard Heating Systems" has been published by Owens-Corning Fiberglas Corporation. The booklet contains many diagrammatic sketches illustrating the proper method of installing perimeter insulation. The publication has been prepared for heating equipment manufacturers and owners, builders and contractors of homes, as well as architects, according to the Fiberglas Corporation, in view of "the ever increasing demand for basementless houses using concrete slab floors on grade." The booklet relates that temperatures inside and outside the home and those below the house must be considered and that much heat is lost through the concrete floor slab and the stone and gravel fill if perimeter insulation is not installed below ground along the foundation wall. 20 pages, illus., 5/51.

#### ARCHITECT AND ENGINEER

88 Post Street, San Francisco, Calif.

I would like to have a copy of each of the New Catalogues I have circled.

284      285      290      286      287      288  
289                      291                      292

Please send to the address on my letterhead, or as I have indicated, and to my attention. (Please print your name — no literature will be sent on this coupon after July, 1951.—A. & E.)

#### ARCHITECT LECTURES AT SAN FRANCISCO MUSEUM OF ART

Robert Anshen, A.I.A., San Francisco architect, recently was the guest speaker at the San Francisco Museum of Art choosing as his subject "The Architect and Construction."

The series of lectures was designed to develop an understanding and appreciation of various aspects of modern art and architect Anshen was selected to represent the architectural profession.

## VERMONT MARBLE COMPANY

DOMESTIC AND IMPORTED MARBLES  
GRANITE VENEER

525 MARKET STREET • SAN FRANCISCO

Phone: SUtter 1-6747

3522 COUNCIL STREET • LOS ANGELES

Phone: DUUnikr 2-7831

The Most Complete Line of  
STEELS and STEEL BUILDING MATERIALS  
Made by a Single Producer



See Sweet's Catalog File or write us for  
full information.

### REPUBLIC STEEL CORPORATION

GENERAL OFFICES: CLEVELAND, OHIO

DENVER, COLORADO . . . CONTINENTAL OIL BUILDING  
LOS ANGELES, CALIF. . . GENERAL PETROLEUM BUILDING  
SAN FRANCISCO, CALIFORNIA . . . RIALTO BUILDING  
SEATTLE, WASH. . . . . WHITE-HENRY-STUART BUILDING

## PACIFIC MANUFACTURING CO.

High Class Interior Finish Quality  
Millwork

16 Beale St., San Francisco  
GARfield 1-7755

2215 El Camino Real, San Mateo  
S. M. 5-0687

304 Bryant Street, Palo Alto  
P. A. 3373

2610 The Alameda, Santa Clara  
S. C. 607 (Factory)

6820 McKinley Avenue, Los Angeles  
THornwall 4196

MAIN OFFICE — SANTA CLARA

## "AMERICAN - MARSH" CONDENSATION UNIT

Pumping  
Machinery  
for  
Every  
Purpose

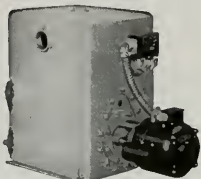

For Service  
Call  
DOuglas  
2-6794  
or  
MUtual 8322

### SIMONDS MACHINERY CO.

SAN FRANCISCO  
816 FOLSOM

LOS ANGELES  
455 EAST 4TH

MEMO

Next payday  
open a savings  
account at  
Crocker - It's  
a good place  
to bank



**CROCKER FIRST NATIONAL BANK**  
1 Montgomery Street SAN FRANCISCO • 250-14th Street OAKLAND  
MEMBER FEDERAL DEPOSIT INSURANCE CORPORATION

## VALUABLE NEWS SERVICE

- BUILDING MATERIAL DEALERS
- CONTRACTORS
- ENGINEERS
- FINANCIAL INSTITUTIONS

**ARCHITECTS REPORTS** gives advance news on construction projects in Northern California, lists: name of projects, location, architect, proposed cost and other pertinent information.

**HANDY** individual slip-reports, issued daily at a total cost of only

\$10 a month

## ARCHITECT'S REPORTS

Published Daily

The ARCHITECT and ENGINEER, Inc.  
68 Post Street, San Francisco - DO 8311

## A.I.A. ACTIVITIES

(From Page 27)

Robert Field, Jr., of the Southern California Chapter, is chairmaning the Programs Committee which, under such capable leadership, plans to provide the best known and best qualified speakers that the Country has to offer. Exhibits—architectural, A.I.A. Chapter and allied professional—will be special features and will be selected to tie-in with the educational part of the program.

Preliminary investigation by the various chapters of the W. A. L. (Women's Architectural League) indicates that many more women plan, this year, to take their architect-husbands to the convention, and Robert Bradt of the San Diego Chapter and Chairman of the Reservations Committee is expecting an attendance which may run 50% in excess of any convention to date.

### NORTHERN CALIFORNIA CHAPTER

The regular June meeting was the annual joint meeting of the Northern California Chapter and the East Bay Chapter, in conjunction with the Architectural Students of the University of California, and was held in the Men's Faculty Club on the University campus. Dinner was served at the International House, following which presentation of awards and an exhibition of the work of the students was held in the "Ark."

### WASHINGTON STATE CHAPTER

The Architects-Producers Council Golf Tournament was held early in June at the Olympic View Golf Course, with entertainment following a dinner being provided by the Producers Council.

New Members include Associates Carver L. Baker; Student Associates, Jose V. Silvestre, Jr., Charles W. Brummitt, Dorsey A. Longmire, Felix M. Campanella, Wojciech J. Koczarski, and William G. Graff.

The Seattle Building Department has notified the Chapter that (1) The Department of Building will no longer accept certification of plans in lieu of actual examination, and (2) all members should see that no job is started until a building permit has been obtained.

### WILLIAM WURSTER, A.I.A. GIVES MAYBECK LECTURE

A special viewing of the architectural work of Bernard Maybeck was on display at the San Francisco Museum of Art during June, and one of the highlights of the exhibition was a special lecture by William Wurster, head of the Department of Architecture at the University of California on the subject "Architecture of Bernard Maybeck."

The exhibition and lecture was in conjunction with the recent award of the 1951 Gold Medal of the American Institute of Architects to Maybeck.

# ESTIMATOR'S GUIDE

## BUILDING AND CONSTRUCTION MATERIALS

PRICES GIVEN ARE FIGURING PRICES AND ARE MADE UP FROM AVERAGE QUOTATIONS FURNISHED BY MATERIAL HOUSES TO SAN FRANCISCO CONTRACTORS. 3% SALES TAX ON ALL MATERIALS BUT NOT LABOR

All prices and wages quoted are for San Francisco and the Bay District. There may be slight fluctuation of prices in the interior and southern part of the state. Freight charge, at least, must be added in figuring country work.

**BONDS**—Performance or Performance plus Labor and Material Bond(s), \$10 per \$1000 on contract price. Labor & Material Bond(s) only, \$5.00 per \$1000 on contract price.

### BRICKWORK—MASONRY—

Common Brick—Per 1 M laid—\$100.00 up (according to class of work).  
Face Brick—Per 1 M laid—\$200.00 and up (according to class of work).  
Brick Steps—\$3.00 and up.  
Common Brick Veneer on Frame Bldgs.—Approx. \$1.20 and up—(according to class of work).  
Face Brick Veneer on Frame Bldgs.—Approx. \$2.00 and up (according to class of work).  
Common Brick—\$36.00 per M—truckload lots, delivered.

Face Brick—\$91.00 to \$106.00 per M, truckload lots, delivered.

### Glazed Structural Units—

Clear Glazed—  
2 x 6 x 12 Units..... \$1.60 per sq. ft.  
4 x 6 x 12 Partition..... 1.70 per sq. ft.  
4 x 6 x 12 Double Faced  
Partition..... 2.25 per sq. ft.  
For colored glaze add..... 30 per sq. ft.

Manter's Fire Brick—\$105.00 per M—F.O.B. Pittsburgh.

Fire Brick—Per M—\$111.00 to \$147.00.

Certificates—Approx. \$10.00 per M.

Paving—\$75.00.

### Building Tile—

8x5/8x12-inches, per M..... \$139.50

6x5/8x12-inches, per M..... 105.00

4x5/8x12-inches, per M..... 84.00

### Hollow Tile—

12x12x2-inches, per M..... \$146.75

12x12x3-inches, per M..... 156.85

12x12x4-inches, per M..... 177.10

12x12x6-inches, per M..... 235.30

F.O.B. Plant

### BUILDING PAPER & FELTS

1 ply per 1000 ft. roll..... \$5.30

2 ply per 1000 ft. roll..... 7.20

3 ply per 1000 ft. roll..... 9.70

Brownstain, Standard 500 ft. roll..... 6.85

Sisalcraft, reinforced, 36 in. by 500 ft. roll..... 7.00

### Sheathing Papers—

Asphalt sheathing, 15-lb. roll..... \$2.00

30-lb. roll..... 2.79

Dampcourse, 216-ft. roll..... 2.95

Blue Plasterboard, 60-lb. roll..... 5.10

### Felt Papers—

Deadenin felt, 3/4-lb., 50-ft. roll..... \$3.23

Disinfectant felt..... 3.79

Asphalt roofing, 15-lbs..... 2.00

Asphalt roofing, 30-lbs..... 2.79

### Roofing Papers—

Asphalt Felt, 15 lb..... \$2.09

Standard Grade, 108-ft. roll, Light..... 1.87

Smooth Surface, Medium..... 2.18

Heavy..... 2.56

M. S., Extra Heavy..... 2.96

### BUILDING HARDWARE—

Sash cord com. No. 7..... \$2.65 per 100 ft.

Sash cord com. No. 8..... 3.80 per 100 ft.

Sash cord spot No. 7..... 3.45 per 100 ft.

Sash cord spot No. 8..... 3.35 per 100 ft.

Sash weights, cast iron, \$100.00 ton.

1-Ton lots, per 100 lbs..... \$3.75

1-Ton lots, per 100 lbs..... \$4.75

Nails, per keg, base..... \$11.80

8-in. spikes..... 11.80

Rim Knob lock sets..... 1.80

Burns, dull brass plated on steel, 3/16x3/2..... .76

### CONCRETE AGGREGATES—

The following prices net to Contractors unless otherwise shown. Carload lots only.

Gravel, all sizes..... \$2.44 \$2.90

Top Sand..... 2.38 3.13

Concrete Mix..... 2.38 3.06

Crushed Rock, 1/4" to 3/4"..... 2.38 2.90

Crushed Rock, 3/4" to 1 1/2"..... 2.38 2.90

Roofing Gravel..... 2.81 2.90

River Sand..... 2.50 3.00

Sand—

Lepis (Nos. 2 & 4)..... 3.56 3.94

Olympia (Nos. 1 & 2)..... 3.56 3.98

Cement—

Common (all brands, paper sacks), carload lots, \$3.55 per bbl. f.o.b. car; delivered \$3.60.

Per Sack, small quantity (paper)..... \$1.05

Carload lots, in bulk per bbl..... 1.79

Cash discount on carload lots, 10c a bbl., 10% Prov., less than carload lots \$4.00 per bbl. f.o.b. warehouse or delivered.

Cash discount 2% on L.C.L.

Trinity White { 1 to 100 sacks, \$3.32 set

Medusa White { warehouse or del.; \$9.56

{ bbl. carload lots.

### CONCRETE READY-MIX—

1-2.4 mix, to 10 yards\*..... \$12.00

10 to 100\* yards..... 11.00

100 to 500 yards..... 10.50

Over 500 yards..... 10.30

\* Delivered to site.

### CONCRETE BLOCKS—

4x8x16-inches each..... Hay-dite \$17 \$18

6x8x16-inches, each..... 22 22.5

8x8x16-inches, each..... 26 26

12x8x16-inches, each..... 34 39

12x8x24-inches, each..... 40 46

Haydite Aggregates—

3/4-inch to 3/8-inch, per cu. yd..... \$7.25

3/4-inch to 3/8-inch, per cu. yd..... 7.25

No. 6 to 0-inch, per cu. yd..... 7.25

### DAMP-PROOFING and Waterproofing—

Two-coat work, \$9.00 per square.

Membrane waterproofing—4 layers of saturated felt, \$10.00 per square.

Hot coating work, \$5.00 per square.

Medusa Waterproofing, \$3.50 per lb. San Francisco Warehouse.

Tricolac concrete waterproofing, 60c a cubic yd. and up.

### ELECTRIC WIRING—\$15 to \$20 per outlet for conduit work (including switches).

Knob and tube average \$6.00 per outlet.

### ELEVATORS—

Prices vary according to capacity, speed and type. Consult elevator companies. Average cost of installing a slow speed automatic passenger elevator in small four story apartment building, including entrance doors, about \$7,500.00.

### EXCAVATION—

Sand, \$1.00; clay or shale, \$1.50 per yard.

Trucks, \$30 to \$45 per day.

Above figures are on average without water. Steam shovel work in large quantities, less hard material, such as rock, will run considerably more.

### FIRE ESCAPES—

Ten-foot galvanized iron balcony with stairs, \$250 installed on new buildings; \$300 on old buildings.

### FLOORS—

Asphalt Tile, 1/8 in. gauge 18c to 35c per sq. ft.

Composition Floors, such as Magnestite 50c per square foot.

Linoleum, standard gauge, sq. yd..... \$2.75

Mastipeve—\$1.50 per sq. yd.

Tarflashlin Linoleum—1/8"—\$3.00 sq. yd.

Terazzo Floors—\$1.50 per sq. ft.

Terazzo Steps—\$2.50 per lin. ft.

Mastic Wear Coat—according to type—20c to 35c.

Hard-wood Flooring—

Oak Flooring—T & G—Unfin.—

Clear Qtd., White..... \$1 1/2 1/4 1/2 3/4 3/2 4 1/2

Clear Qtd., Red..... 405 380 5

Select Qtd., Red or White..... 355 340

Clear Pin, Red or White..... 355 340 335 315

Select Pin, Red or White..... 340 330 325 300

#1 Common, Red or White 315 310 305 280

#2 Common, Red or White 305

Prerefined Oak Flooring—

1/2 x 2..... Prime Standard \$349.00 \$339.00

1/2 x 2 1/2..... 380.00 370.00

1/2 x 2 1/4..... 390.00 381.00

1/2 x 2 3/4..... 375.00 355.00

1/2 x 3/4..... 375.00 375.00

3/8 x 2 1/4 & 3/4 Ranch Plank..... 415.00

### Unfinished Maple Flooring—

1 1/2 x 2 1/4 First Grade..... \$370.00

1 1/2 x 2 1/4 2nd Grade..... 365.00

1 1/2 x 2 1/4 2nd & 3rd Grade..... 375.00

1 1/2 x 2 1/4 3rd Grade..... 240.00

1 1/2 x 3/4 3rd & 3rd Btr. Jtd. EM..... 380.00

1 1/2 x 3/4 2nd & 3rd Btr. Jtd. EM..... 390.00

33/32 x 2 1/4 First Grade..... 400.00

33/32 x 2 1/4 2nd Grade..... 360.00

33/32 x 2 1/4 3rd Grade..... 320.00

Floor Layer Wage \$2.50 hr.

### GLASS—

Single Strength Window Glass..... \$ .30 per sq. ft.

Double Strength Window Glass..... .45 per sq. ft.

Plate Glass, 1/4 polished to 75..... 1.60 per sq. ft.

75 to 100..... 1.74 per sq. ft.

1/4 in. Polished Wire Plate Glass..... 2.35 per sq. ft.

1/4 in. Rgh. Wire Glass..... .71 per sq. ft.

1/4 in. Polished Wire Plate Glass..... 2.00 per sq. ft.

1/4 in. Rgh. Wire Glass..... .64 per sq. ft.

1/4 in. Obscure Glass..... .40 per sq. ft.

1/4 in. Obscure Glass..... .64 per sq. ft.

1/4 in. Heat Absorbing Obscure..... .58 per sq. ft.

1/4 in. Heat Absorbing Wire..... .86 per sq. ft.

Glazing of above additional \$1.15 to .30 per sq. ft.

Glass Blocks, set in place..... 3.50 per sq. ft.

### HEATING—

Average, \$3.50 to \$4.00 per sq. ft. of radiation, according to conditions.

Warm air (gravity) average \$64 per register.

Forced air average \$91 per register.



## INSULATION AND WALLBOARD—

Acrowool Insulation—	
(2") Less than 1,000 sq. ft.	\$64.00
(2") Over 1,000 sq. ft.	\$9.00
Cotton Insulation—Full thickness	
(3 1/2")	\$95.50 per M sq. ft.
Insulation Aluminum—Aluminum coated on both sides.	\$23.50 per M sq. ft.
Insulation—1/4" panel	\$9.00 per panel
Wallboard—1/2" thickness	\$55.00 per M sq. ft.
Finished Plank	\$69.00 per M sq. ft.
Ceiling Tileboard	\$69.00 per M sq. ft.

IRON—Cost of ornamental iron cast iron, etc., depends on designs.

## LUMBER—

\$45 No. 2 and better common O.P. or D.F., per M. f.b.m.	\$100.00
Rough, No. 2 common O.P. or D.F., per M. f.b.m.	100.00

## Flooring—

	Per M Delivd.
V.G.-D.F. 8 & 8tr. 1 x 4 T & G Flooring.	\$225.00
"C" and better—all.	225.00
"D" and better—all.	225.00
Rwd. Rustic—"A" grade, medium dry.	185.00
	8 to 24 ft.
Plowood, per M sq. ft.	\$170.00
1/2-inch, 4.0x8-0.515	250.00
1/2-inch, 4.0x8-0.515	250.00
3/4-inch, per M sq. ft.	315.00
Pliswood	110c per ft.
Plifwood	25c per ft.

## Shingles (Rwd. not available)—

Red Cedar No. 1—\$9.50 per square; No. 2, \$7.00; No. 3, \$5.00.	
Average cost to lay shingles, \$6.00 per square.	
Cedar Shakes—1/2" to 3/4" x 24/26 in handsplit tapered or split resawn, per square.	\$15.25
3/4" to 1 1/2" x 24/26 in split resawn, per square	17.00
Average cost to lay shales, \$8.00 per square	
Pressure Treated Lumber—	
Walmized	Add \$35 per M to above
Croated.	
8-lb. treatment	Add \$45 per M to above

## MARBLE—(See Dealers)

## METAL LATH EXPANDED—

Standard Diamond, 3.40, Copper Bearing, LCL, per 100 sq. yds.	\$43.50
Standard Ribbed, ditto.	\$47.50

## MILLWORK—Standard.

D. F. \$150 per 1000. R. W. Rustic \$175 per 1000 (delivered).
Double hung box window frames, average with trim, \$12.50 and up, each.
Complete door unit, \$15 to \$25.
Screen doors, \$8.00 to \$12.00 each.
Petant screen windows, \$1.25 a sq. ft.
Cases for kitchen pantries seven ft. high, per lineal ft., upper \$9.00 to \$11.00; lower \$12.00 to \$13.00.
Dining room cases, \$20.00 per lineal foot.
Rough and finish about \$1.00 per sq. ft.
Labor—Rough carpentry, warehouse heavy framing (average), \$75.00 per M.
For smaller work average, \$85.00 to \$100. per 1000.

## PAINTING—

Two-coat work	per yard \$8.00
Three-coat work	per yard 31c
Cold water painting	per yard 25c
Whitewashing	per yard 15c
Linseed Oil, Strictly Pure	
(Basis 7 1/2 lbs. per gal.)	
Light iron drums	per gal. \$2.26
5-gallon cans	per gal. 2.40
1-gallon cans	each 2.52
Quart cans	each .71
Pint cans	each .38
1/2-pint cans	each .24
Turpentine	
(Basis, 7 1/2 lbs. per gal.)	
Light iron drums	per gal. \$2.15
5-gallon cans	per gal. 1.76
1-gallon cans	each 1.88
Quart cans	each .54
Pint cans	each .31
1/2-pint cans	each .20

## Pioneer White Lead in Oil Heavy Paste and All Purpose (Soft - Paste)

Net Weight Packages	lbs.	pkgs.	List Price	Price to Painters
100-lb. kegs	\$28.35	\$29.35	\$27.50	\$27.50
50-lb. kegs	30.05	15.03	28.15	14.08
25-lb. cans	30.35	7.57	28.45	7.12
15-lb. cans	33.35	1.34	31.25	1.25
1-lb. cans	36.00	.36	33.75	.34
500-lb. (one delivery)	3/4c	per 300 lbs. than above.		

## Pioneer Dry White Lead—Litharge—Dry Red Lead—Red Lead in Oil

Products	lbs.	lbs.	lbs.
Dry White Lead	\$23.30	\$	\$
Litharge	25.95	26.60	26.90
Dry Red Lead	27.20	27.85	28.15
Red Lead in Oil	30.65	31.30	31.60
Found cans, \$37 per lb.			

## PATENT CHIMNEYS—

6-inch	\$2.50 lineal foot
8-inch	3.00 lineal foot
10-inch	4.00 lineal foot
12-inch	5.00 lineal foot

## PLASTER—

Neat wall, per ton delivered in S. F. in paper bags, \$17.60.

## PLASTERING (Interior)—

3 Coats, metal lath and plaster.	3.00
Keene cement on metal lath.	3.50
Ceilings with 3/4 hot roll channels metal lath (lathed only).	3.00
Ceilings with 3/4 hot roll channels metal lath plastered.	4.50
Single partition 3/4 channel lath 1 side (lath only)	3.00
Single partition 3/4 channel lath 2 inches thick plastered.	8.00
4-inch double partition 3/4 channel lath 2 sides (lath only).	5.75
4-inch double partition 3/4 channel lath 2 sides plastered.	8.75
Thermax single partition; 1" channel; 2 1/2" overall partition width. Plastered both sides.	7.50
Thermax double partition; 1" channel; 4 1/2" overall partition width. Plastered both sides.	11.00
3 Coats over 1" Thermax nailed to one side wood studs or joists.	4.50
3 Coats over 1" Thermax suspended to one side wood studs with spring sound isolation clip.	5.00
Note—Channel lath controlled by limitation orders.	

## PLASTERING (Exterior)—

2 coats cement finish, brick or concrete wall.	\$2.50
3 coats cement finish, No. 18 gauge wire mesh.	3.50
Time—\$4.00 per bbl. at yard.	
Processed L.L.Lime—\$4.15 per bbl. at yard.	
Rock or Grip Lath—3/8"—30c per sq. yd.	
1/4"—29c per sq. yd.	
Composition Stucco—\$4.00 sq. yard (applied).	

## PLUMBING—

From \$200.00 per fixture up, according to grade, quality and runs.

## ROOFING—

"Standard" tar and gravel, 4 ply—\$11.00 per sq. for 30 sqs. or over.	
Less than 30 sqs. \$14.00 per sq.	
Tile \$40.00 to \$50.00 per square.	
No. 1 Redwood Shingles in place, 4 1/2 in. exposure, per square.	\$18.25
5/2 No. 1 Cedar Shingles, 5 in. exposure, per square.	14.50
5/8 x 16"—No. 1 Little Giant Cedar Shingles, 5" exposure, per square.	18.25

4/2 No. 1-24" Royal Cedar Shingles 7/2" exposure, per square.	23.00
Ro-coast with Gravel \$5.50 per sq. laid.	
Asbestos Shingles, \$2.50 to \$3.50 per sq. laid.	
1/2 to 3/4 x 25" Resawn Cedar Shakes, 10" Exposure	\$30.00
3/4 to 1 1/4 x 25" Resawn Cedar Shakes, 10" Exposure	\$35.00
1 x 25" Resawn Cedar Shakes, 10" Exposure	22.00
Above prices are for shakes in place	

## SEWER PIPE—

C.I. 6-in. to 24-in. B. & S. Class B and heavier, per ton	\$99.50
Vitrified, per foot: L.C.L. F.O.B. Warehouse, San Francisco.	
Standard, 8-in.	\$.66
Standard, 12-in.	1.30
Standard, 24-in.	5.41
Clay Drain Pipe, per 1,000 L.F. L.C.L., F.O.B. Warehouse, San Francisco	
Standard, 6-in. per M.	\$240.00
Standard, 8-in. per M.	400.00

## SHEET METAL—

Windows—Metal, \$2.50 a sq. ft. Fire doors (average), including hardware \$2.80 per sq. ft., size 12'x12'. \$3.75 per sq. ft., size 3'x6'.

## SKYLIGHTS—(not glazed)

Copper, \$1.25 sq. ft. (flat). Galvanized iron, 65c sq. ft. (flat). Vented hip skylights, \$1.50 sq. ft.

## STEEL—STRUCTURAL—

\$220 per ton erected, when out of mill. \$270 per ton erected, when out of stock.

## STEEL REINFORCING—

\$200.00 per ton, in place.	
1/4-in. Rd. (Less than 1 ton)	\$8.40
3/8-in. Rd. (Less than 1 ton)	7.30
1/2-in. Rd. (Less than 1 ton)	7.00
3/4-in. Rd. (Less than 1 ton)	6.75
1-in. & 7/8-in. Rd. (Less than 1 ton)	6.65
1-in & up (Less than 1 ton).	6.60
1 ton to 5 tons, deduct 25c.	

## STORE FRONTS (None available)

## TILE—

Ceramic Tile Floors—Commercial \$1.20 to \$1.60 per sq. ft.	
Cove Base—\$1.40 per lin. ft.	
Quartz Tile Floors, 6x6" with 1/4" base @ \$1.35 per sq. ft.	
Tile Wainscots & Floors, Residential, 4 1/2 x 4 1/2", @ \$1.65 to \$2.00 per sq. ft.	
Tile Wainscots, Commercial, 4 1/2 x 4 1/2", @ \$1.50 to \$1.65 per sq. ft.	
Asphalt Tile Floor 1/2" x 1/2" @ \$.18 - \$.35 sq. yd.	
Light shades slightly higher.	
Cork Tile—\$.70 per sq. ft.	
Mosaic Floors—See dealers.	
Lin-Tile—\$1.00 per sq. ft.	
Rubber Tile—\$.55 to \$.75 per sq. ft.	
Building Tile—	
8x5 1/2 x 12-inches, per M.	\$139.50
6x5 1/2 x 12-inches, per M.	105.30
4x5 1/2 x 12-inches, per M.	84.00
Hollow Tile—	
12x12x2-inches, per M.	\$146.75
12x12x3-inches, per M.	156.85
12x12x4-inches, per M.	177.10
12x12x6-inches, per M.	235.30
F.O.B. Plant	

## VENETIAN BLINDS—

75c per square foot and up. Installation extra.

## WINDOWS—STEEL—INDUSTRIAL

Cost depends on design and quality required.

# ARCHITECT AND ENGINEER ESTIMATOR'S DIRECTORY

## Building and Construction Materials

EXPLANATION—Building and construction materials are shown in major classified groups for general identification purposes with names and addresses of suppliers of materials listed in detail under group classification where name first appears—main offices are shown first with branch or district offices following. The numeral appearing in listings refers to the major group classification where complete data on the dealer, or representative, may be found.

### AIR CONDITIONING (b)

Air Conditioning & Cooling  
UTILITY APPLIANCE CORP.  
Los Angeles 58, 4851 S. Alameda St.  
San Francisco, 1355 Market St., UN 1-4908

### ARCHITECTURAL VENEER (a)

Ceramic Veneer  
PACIFIC CLAY PRODUCTS  
San Francisco: 605 Market St., GA 1-3970  
Los Angeles, Portland, Salt Lake City  
GLADDING, McBEAN & CO. \*(1)

### Porcelain Veneer

PORCELAIN ENAMEL PUBLICITY BUREAU  
(Dept. AE-450)  
Room 601, Franklin Building, Oakland 12, California  
P. O. Box 186, East Pasadena Station, Pasadena 8,  
California

### Granite Veneer

VERMONT MARBLE COMPANY  
San Francisco 5: 525 Market Street, SU 1-6747  
Los Angeles 4: DU 2-7834

### Marble Veneer

VERMONT MARBLE COMPANY  
San Francisco 5: 525 Market Street, SU 1-6747  
Los Angeles 4: DU 2-7834

### BANKS-FINANCING (1b)

CROCKER FIRST NATIONAL BANK OF S. F.  
San Francisco, Port & Montgomery Sts., EX 2-7700

### BRASS PRODUCTS (1a)

GREENBERG'S, M. & SONS  
San Francisco, Calif.: 765 Folsom, EXbrook 2-3143

### BRICKWORK (1)

Face Brick  
GLADDING, McBEAN & CO.  
San Francisco: Harrison at 9th Sts., UN 1-7400  
Los Angeles: 2901 Los Feliz Blvd., OL 2121  
Offices at Portland, Seattle, Spokane  
KRAFTILE  
Niles, California, Niles 3611  
San Francisco 5: 50 Hawthorne St., DO 2-3780  
Los Angeles 13: 406 South Main St., MU 7241  
REMILARD-DANDINI CO.  
San Francisco: 400 Montgomery St., EX 2-4988

### BRONZE PRODUCTS (1b)

GREENBERG'S M. & SONS  
San Francisco, Calif.: 765 Folsom, EXbrook 2-3143

### BUILDING PAPER & FELTS (2)

SISALKRAFT COMPANY  
San Francisco: 55 New Montgomery St., EX 2-3066  
Chicago, Ill.: 205 West Wacker Drive  
ANGIER PACIFIC CORP.  
San Francisco 5: 55 New Montgomery St., DO 2-4416  
Los Angeles: 7424 Sunset Boulevard

### BUILDING HARDWARE (3)

THE STANLEY WORKS  
San Francisco: Monodnock Bldg., YU 6-5914  
New Britain, Conn.

### CEMENT (c)

PACIFIC PORTLAND CEMENT  
San Francisco: 417 Montgomery St., GA 1-4100

### CONCRETE AGGREGATES (4)

Lightweight Aggregates  
AMERICAN PERLITE CORP.  
Richmond, Calif.: 26th & B Sts.—Yard 2, RI 4307

### DOORS (1a)

Hollywood Doors  
WEST COAST SCREEN CO.  
Los Angeles: 1127 E. 63rd St. AD 1-1108  
Distributors:

W. P. FULLER CO.  
Seattle, Tacoma, Portland  
NICKOLI DOOR SALES CO.  
San Francisco: 3045 19th St.  
F. M. COBB CO.  
Los Angeles: & San Pedro  
SOUTHWEST SASH & DOOR  
Phoenix, Arizona  
HOUSTON SASH & DOOR  
Houston, Texas

### Screen Doors

WEST COAST SCREEN CO.  
(See Hollywood Door listing above)

### FIRE ESCAPES (5)

SOULE STEEL  
San Francisco: 1750 Army St., VA 4-4141  
Los Angeles, Calif.—LA 0911  
Portland, Ore.—BE 5155  
Seattle, Wash.—SE 3010  
MICHAEL & PFEFFER IRON WORKS, INC.  
San Francisco 3: Tenth & Harrison Sts.,  
MA 1-5966

### FIREPLACES (5a)

Heat Circulating  
SUPERIOR FIREPLACE CO.  
Los Angeles: 1708 E. 15th St. PR 8393  
Baltimore, Md.: 601 No. Point Rd.

### FLOORS (1)

Hardwood Flooring  
HOGAN LUMBER COMPANY  
Oakland: Second and Alice Sts., GL 1-6861  
E. K. WOOD LUMBER CO.  
Los Angeles: 4710 S. Alameda St., JE 3111  
Oakland: 727 Kennedy St., KE 4-8466  
Portland: 827 Terminal Sales Building  
Floor Treatment & Maintenance  
HILLYARD SALES CO. (Western)  
470 Alabama St., San Francisco, MA 1-7766  
Los Angeles, 923 E. 3rd, TRinity 8282  
Seattle, 3440 E. Marginal Way

### GLASS (7)

W. P. FULLER COMPANY  
San Francisco: 301 Mission St., EX 2-7151  
Los Angeles, Calif.  
Portland, Oregon

### HEATING (8)

HENDERSON FURNACE & MFG. CO.  
Sebastopol, Calif.  
S. T. JOHNSON CO.  
Oakland 8: 940 Arlington Ave., OL 2-6000  
San Francisco: 585 Potrero Ave., MA 1-2757  
Philadelphia 8, Pa.: 401 No. Broad St.  
SCOTT COMPANY  
San Francisco: 243 Minna St., YU 2-0400  
Oakland: 113 - 10th St., GL 1-1937  
San Jose, Calif.  
Los Angeles, Calif.  
ELECTROMODE CORP.  
Rochester, N. Y.

### Electric Heaters

San Francisco: 1355 Market St., KL 2-2311  
Northern California Distributors  
GENERAL ELECTRIC SUPPLY CORP.  
San Francisco: 1201 Bryant St., UN 3-4000  
Emeryville: 5400 Hollis St., OL 3-4433  
Sacramento: 1131 S St., GI 3-9001  
Fresno: 1234 Q St., Fresno 4-7446  
INCANDESCENT SUPPLY COMPANY  
Redding: 2146 Pine St., Redding 200  
THOMAS B. HUNTER (Designer)  
San Francisco: 41 Sutter St., GA 1-1164

### UTILITY APPLIANCE CORP. \*(b)

INSULATION AND WALLBOARD (9)  
LUMBER MANUFACTURING CO.  
San Francisco: 225 Industrial Ave., JU 7-1760  
SISALKRAFT COMPANY \*(2)  
WESTERN ASBESTOS COMPANY  
San Francisco: 675 Townsend St., KL 2-3868  
Oakland: 251 Fifth Avenue, GL 1-2345  
Sacramento: 1224 J Street, 2-8993  
Stockton: 1120 E. Weber Ave., 4-1863  
Fresno: 1837 Merced Street, 3-3277  
San Jose: 201 So. Market St., BA 4359-J

### IRON—Ornamental (10)

MICHEL & PFEFFER IRON WORKS, INC. \*(5)

### LANDSCAPE (11a)

Landscape Contractors  
HENRY C. SOTO CORPN.  
Los Angeles, 13000 S. Avalon Blvd. ME 4-6617

### LIGHTING FIXTURES (11)

SMOOT-HOLMAN COMPANY  
Inglewood, Calif., OR 8-1217  
San Francisco: 55 Mississippi St., MA 1-8474

### LUMBER (12)

HOGAN LUMBER COMPANY \*(6)  
LUMBER MANUFACTURING CO. \*(9)  
E. K. WOOD LUMBER CO \*(6)

### Shingles

SIDEWALL LUMBER COMPANY  
San Francisco 24: 1995 Oakdale Ave., AT 2-8112

### MARBLE (13)

VERMONT MARBLE COMPANY  
San Francisco: 525 Market St., SU 1-6747  
Los Angeles 4: 3522 Council St., DU 2-7834

### METAL LATH EXPANDED (14)

FORDERER CORNICE WORKS  
San Francisco: 269 Potrero Ave., HE 1-4100  
SOULE STEEL \*(5)

### MILLWORK (15)

PACIFIC MANUFACTURING COMPANY  
San Francisco: 16 Beale St., GA 1-7755  
Santa Clara: 2610 The Alameda, SC 607  
Los Angeles: 6820 McKinley Ave., TH 4196  
MULLEN MANUFACTURING COMPANY  
San Francisco: 60-80 Rausch St., UN 1-5815  
LUMBER MANUFACTURING COMPANY \*(9)

### PAINTING (16)

Paint  
W. P. FULLER COMPANY \*(7)

### PLASTER (17)

Exteriors  
PACIFIC PORTLAND CEMENT COMPANY \*(4)  
Interiors—Metal Lath & Trim  
FORDERER CORNICE WORKS \*(14)

### PLASTIC CEMENT (f)

PACIFIC PORTLAND CEMENT CO.  
San Francisco: 417 Montgomery St., GA 1-4100

### PLUMBING (18)

THE SCOTT COMPANY \*(8)  
THE HALSEY TAYLOR COMPANY  
Redlands, Calif.  
Warren, Ohio  
HAWKS DRINKING FAUCET COMPANY  
Berkeley 10: 1435 Fourth St., LA 5-3341  
CONTINENTAL WATER HEATER COMPANY  
Los Angeles 31: 1801 Pasadena Ave., CA 6178

**SIMONDS MACHINERY COMPANY**  
San Francisco: 816 Folsom St., DO 2-6794  
Los Angeles: 455 East 4th St., MU 3222  
**SECURITY VALVE COMPANY**  
Los Angeles 31: 410 San Fernando Rd., CA 6191

**SEWER PIPE (19)**

GLADDING, McBEAN & CO. \*(1)  
PACIFIC CLAY PRODUCTS  
San Francisco: 605 Market St., GA 1-3970  
Los Angeles, Portland, Salt Lake City

**SHEET METAL (20)**

Windows

DETROIT STEEL PRODUCTS COMPANY  
Oakland 8: 1310 - 63rd St., OL 2-8826  
San Francisco: Russ Building, DO 2-0890  
MICHEL & PFEFFER IRON WORKS, INC. \*(5)  
SOULE STEEL COMPANY \*(5)

Fire Doors

DETROIT STEEL PRODUCTS COMPANY  
Skylights  
DETROIT STEEL PRODUCTS COMPANY

**STEEL—STRUCTURAL (21)**

COLUMBIA STEEL CO.  
San Francisco: Russ Bldg., SU 1-2500  
Los Angeles: 2087 E. Slauson, LA 1171  
Portland: 2345 N. W. Nicolai, BE 7261  
Seattle: 1331 3rd Ave. Bldg., MA 1972  
Salt Lake City: Walker Bank Bldg., SL 3-6733  
HERRICK IRON WORKS  
Oakland: 18th & Campbell Sts., GL 1-1767

**JUDSON PACIFIC-MURPHY CORP.**  
Emanville: 4300 Eastshore Highway, OL 3-1717  
**REPUBLIC STEEL CORP.**  
San Francisco: 116 N. Montgomery St., GA 1-0977  
Los Angeles: Edison Building  
Seattle: White-Henry-Stuart Building

Salt Lake City: Walker Bank Building  
Denver: Continental Oil Building  
**KRAFTILE COMPANY \*(1)**  
**SAN JOSE STEEL COMPANY**  
San Jose: 195 North Thirtieth St., CO 4184

**STEEL—REINFORCING (22)**

REPUBLIC STEEL CORP. \*(21)  
HERRICK IRON WORKS \*(21)  
SAN JOSE STEEL CO. \*(21)  
COLUMBIA STEEL CO. \*(21)

**TILE (23)**

GLADDING, McBEAN & CO. \*(1)  
KRAFTILE COMPANY \*(1)  
PACIFIC CLAY PRODUCTS  
San Francisco: 605 Market St., GA 1-3970  
Los Angeles, Portland, Salt Lake City

**TIMBER—REINFORCING (b)**

Trusses  
WEYERHAEUSER SALES CO.  
Tacoma, Wash.  
St. Paul, Minn.  
Newark, N. J.  
Treated Timber

J. H. BAXTER CO.  
San Francisco: 4: 333 Montgomery St., DO 2  
Los Angeles 13: 601 West Fifth St., MI 6294

**WALL TILE (24)**

GLADDING, McBEAN & CO. \*(1)  
KRAFTILE COMPANY \*(1)

**WINDOWS STEEL (25)**

DETROIT STEEL PRODUCTS CO. \*(20)  
MICHEL & PFEFFER IRON WORKS, INC. \*(5)  
SOULE STEEL COMPANY \*(5)

**GENERAL CONTRACTORS (26)**

BARRETT & HILP  
San Francisco: 918 Harrison St., DO 2-0700  
Los Angeles: 234 W. 37th Place, AD 3-8161  
DINWIDDIE CONSTRUCTION COMPANY  
San Francisco: Crocker Building, YU 6-2718  
CLINTON CONSTRUCTION COMPANY  
San Francisco: 923 Folsom St., SU 1-3440  
MATTOCK CONSTRUCTION COMPANY  
San Francisco: 604 Mission St., GA 1-5516  
PARKER, STEFFENS & PEARCE  
San Francisco: 135 So. Park, EX 2-6639  
STOLTE, INC.  
Oakland: 8451 San Leandro Blvd., TR 2-1064  
SWINERTON & WALBERG COMPANY  
San Francisco: 225 Bush St., GA 1-2980  
Oakland: 1723 Webster St., HI 4-4322  
Los Angeles, Sacramento, Denver  
P. J. WALKER COMPANY  
San Francisco: 391 Sutter St., YU 6-5916  
Los Angeles: 714 W. Olympic Blvd., RI 7-5522

**BUILDING TRADES WAGE (JOB SITES) NORTHERN, CENTRAL AND SOUTHERN CALIFORNIA**

ATTENTION: The following are the PREVAILING hourly rates of compensation being paid and in effect by employers by agreement between employees and their union; or as recognized and determined by the U. S. Department of Labor. (Revised to March 1, 1951.)

	San Francisco		Alameda		Contra Costa		Fresno		Sacramento		San Joaquin		Santa Clara		Solano		Los Angeles		San Bernardino		San Diego		San Francisco		Santa Barbara		Kern			
	\$2.50	\$2.50	\$2.50	\$2.50	\$2.50	\$2.50	\$2.50	\$2.50	\$2.50	\$2.50	\$2.50	\$2.50	\$2.50	\$2.50	\$2.50	\$2.50	\$2.50	\$2.50	\$2.50	\$2.50	\$2.50	\$2.50	\$2.50	\$2.50	\$2.50	\$2.50	\$2.50			
ASBESTOS WORKERS	2.50	2.50	2.50	2.50	2.50	2.50	2.50	2.50	2.50	2.50	2.50	2.50	2.50	2.50	2.50	2.50	2.50	2.50	2.50	2.50	2.50	2.50	2.50	2.50	2.50	2.50	2.50	2.50		
BOILERMAKERS	2.53	2.53	2.53	2.53	2.53	2.53	2.53	2.53	2.53	2.53	2.53	2.53	2.53	2.53	2.53	2.53	2.53	2.53	2.53	2.53	2.53	2.53	2.53	2.53	2.53	2.53	2.53	2.53	2.53	
BRICKLAYERS	3.25**	3.15*	3.15	3.15	2.85	3.25	3.00	3.00	3.25	2.75	2.40	2.25	2.375	2.40	2.20	2.20	2.20	2.20	2.20	2.20	2.20	2.20	2.20	2.20	2.20	2.20	2.20	2.20	2.20	
BRICKLAYERS, HODCARRIERS	2.45	2.45	2.45	2.45	2.45	2.45	2.45	2.45	2.45	2.45	2.45	2.45	2.45	2.45	2.45	2.45	2.45	2.45	2.45	2.45	2.45	2.45	2.45	2.45	2.45	2.45	2.45	2.45	2.45	
CARPENTERS	2.325	2.325	2.175	2.175	2.175	2.175	2.175	2.175	2.175	2.175	2.175	2.175	2.175	2.175	2.175	2.175	2.175	2.175	2.175	2.175	2.175	2.175	2.175	2.175	2.175	2.175	2.175	2.175	2.175	
CEMENT FINISHERS	2.20	2.20	2.20	2.20	2.20	2.20	2.20	2.20	2.20	2.20	2.20	2.20	2.20	2.20	2.20	2.20	2.20	2.20	2.20	2.20	2.20	2.20	2.20	2.20	2.20	2.20	2.20	2.20	2.20	
ELECTRICIANS	2.75	2.60	2.60	2.75	2.50	2.50	2.50	2.625	2.60	2.50	2.50	2.50	2.50	2.50	2.50	2.50	2.50	2.50	2.50	2.50	2.50	2.50	2.50	2.50	2.50	2.50	2.50	2.50	2.50	2.50
ELEVATOR CONSTRUCTORS	2.75	2.75	2.75	2.75	2.75	2.75	2.75	2.75	2.75	2.75	2.75	2.75	2.75	2.75	2.75	2.75	2.75	2.75	2.75	2.75	2.75	2.75	2.75	2.75	2.75	2.75	2.75	2.75	2.75	2.75
ENGINEERS: MATERIAL HOIST	2.19	2.19	2.19	2.19	2.19	2.19	2.19	2.19	2.19	2.19	2.19	2.19	2.19	2.19	2.19	2.19	2.19	2.19	2.19	2.19	2.19	2.19	2.19	2.19	2.19	2.19	2.19	2.19	2.19	2.19
GLAZIERS	2.30	2.30	2.30	2.30	2.30	2.30	2.30	2.30	2.30	2.30	2.30	2.30	2.30	2.30	2.30	2.30	2.30	2.30	2.30	2.30	2.30	2.30	2.30	2.30	2.30	2.30	2.30	2.30	2.30	2.30
IRONWORKERS: ORNAMENTAL	2.425	2.425	2.425	2.425	2.425	2.425	2.425	2.425	2.425	2.425	2.425	2.425	2.425	2.425	2.425	2.425	2.425	2.425	2.425	2.425	2.425	2.425	2.425	2.425	2.425	2.425	2.425	2.425	2.425	2.425
REINFORCING	2.375	2.375	2.375	2.375	2.375	2.375	2.375	2.375	2.375	2.375	2.375	2.375	2.375	2.375	2.375	2.375	2.375	2.375	2.375	2.375	2.375	2.375	2.375	2.375	2.375	2.375	2.375	2.375	2.375	2.375
STRUCTURAL	2.575	2.575	2.575	2.575	2.575	2.575	2.575	2.575	2.575	2.575	2.575	2.575	2.575	2.575	2.575	2.575	2.575	2.575	2.575	2.575	2.575	2.575	2.575	2.575	2.575	2.575	2.575	2.575	2.575	2.575
LABORERS: BUILDING	1.65	1.45	1.45	1.55	1.45	1.45	1.45	1.45	1.45	1.45	1.45	1.45	1.45	1.45	1.45	1.45	1.45	1.45	1.45	1.45	1.45	1.45	1.45	1.45	1.45	1.45	1.45	1.45	1.45	1.45
CONCRETE	1.65	1.45	1.45	1.55	1.45	1.45	1.45	1.45	1.45	1.45	1.45	1.45	1.45	1.45	1.45	1.45	1.45	1.45	1.45	1.45	1.45	1.45	1.45	1.45	1.45	1.45	1.45	1.45	1.45	1.45
LATHERS	3.00	3.00*	3.00*	2.75	2.875	2.75	3.00	3.00	2.8125	2.50	2.50	2.50	2.50	2.50	2.50	2.50	2.50	2.50	2.50	2.50	2.50	2.50	2.50	2.50	2.50	2.50	2.50	2.50	2.50	2.50
MARBLE SETTERS	2.60	2.40	2.40	2.60	2.40	2.40	2.40	2.40	2.40	2.40	2.40	2.40	2.40	2.40	2.40	2.40	2.40	2.40	2.40	2.40	2.40	2.40	2.40	2.40	2.40	2.40	2.40	2.40	2.40	2.40
MOOSAIC & TERRAZZO	2.375	2.375	2.375	2.375	2.375	2.375	2.375	2.375	2.375	2.375	2.375	2.375	2.375	2.375	2.375	2.375	2.375	2.375	2.375	2.375	2.375	2.375	2.375	2.375	2.375	2.375	2.375	2.375	2.375	2.375
PAINTERS	2.45**	2.45	2.45	2.15	2.45	2.275	2.45	2.45	2.45	2.45	2.45	2.45	2.45	2.45	2.45	2.45	2.45	2.45	2.45	2.45	2.45	2.45	2.45	2.45	2.45	2.45	2.45	2.45	2.45	2.45
PLEDRIERS	2.325	2.325	2.325	2.325	2.325	2.325	2.325	2.325	2.325	2.325	2.325	2.325	2.325	2.325	2.325	2.325	2.325	2.325	2.325	2.325	2.325	2.325	2.325	2.325	2.325	2.325	2.325	2.325	2.325	2.325
PLASTERERS	3.00	3.15*	3.15	2.75	3.00	3.00	3.125	3.00*	2.50	2.50	2.50	2.50	2.50	2.50	2.50	2.50	2.50	2.50	2.50	2.50	2.50	2.50	2.50	2.50	2.50	2.50	2.50	2.50	2.50	2.50
PLASTERERS, HODCARRIERS	2.625	2.625	2.625	2.625	2.625	2.625	2.625	2.625	2.625	2.625	2.625	2.625	2.625	2.625	2.625	2.625	2.625	2.625	2.625	2.625	2.625	2.625	2.625	2.625	2.625	2.625	2.625	2.625	2.625	2.625
PLUMBERS	2.625	2.625	2.625	2.625	2.625	2.625	2.625	2.625	2.625	2.625	2.625	2.625	2.625	2.625	2.625	2.625	2.625	2.625	2.625	2.625	2.625	2.625	2.625	2.625	2.625	2.625	2.625	2.625	2.625	2.625
ROOFERS	2.50	2.50	2.50	2.50	2.50	2.375	2.50	2.50	2.50	2.50	2.50	2.50	2.50	2.50	2.50	2.50	2.50	2.50	2.50	2.50	2.50	2.50	2.50	2.50	2.50	2.50	2.50	2.50	2.50	2.50
SHEET METAL WORKERS	2.3125	2.3125	2.3125	2.40	2.50	2.40	2.50	2.40	2.50	2.40	2.50	2.40	2.50	2.40	2.50	2.40	2.50	2.40	2.50	2.40	2.50	2.40	2.50	2.40	2.50	2.40	2.50	2.40	2.50	2.40
SPRINKLER FITTERS	2.425	2.425	2.425	2.425	2.425	2.425	2.425	2.425	2.425	2.425	2.425	2.425	2.425	2.425	2.425	2.425	2.425	2.425	2.425	2.425	2.425	2.425	2.425	2.425	2.425	2.425	2.425	2.425	2.425	2.425
STEAMFITTERS	2.625	2.625	2.625	2.625	2.625	2.625	2.625	2.625	2.625	2.625	2.625	2.625	2.625	2.625	2.625	2.625	2.625	2.625	2.625	2.625	2.625	2.625	2.625	2.625	2.625	2.625	2.625	2.625	2.625	2.625
TRUCK DRIVERS—1/2 Ton or less	1.58	1.58	1.58	1.58	1.58	1.58	1.58	1.58	1.58	1.58	1.58	1.58	1.58	1.58	1.58	1.58	1.58	1.58	1.58	1.58	1.58	1.58	1.58	1.58	1.58	1.58	1.58	1.58	1.58	1.58
TILESETTERS	2.875	2.875	2.875	2.50	2.875	2.425	2.875	2.425	2.875	2.425	2.875	2.425	2.875	2.425	2.875	2.425	2.875	2.425	2.875	2.425	2.875	2.425	2.875	2.425	2.875	2.425	2.875	2.425	2.875	2.425

\* 6 Hour Day, \*\* 7 Hour Day.

## EARLY CALIFORNIA HOUSE

(From Page 21)

ern techniques in building materials.

A few simple changes in architectural design were made: Windows were cut into the old attic, adding living area; new windows replaced old ones throughout; false dormers were introduced into the floor line; and an attractive portico was added to grace the entrance.

Gypsum wallboard was applied to the interior walls and room partitions rearranged. Asbestos cement siding made the exterior gleam, while grey asbestos cement siding gave the proper architectural balance to the foundation portion. A new roof was installed over the age-old cedar shingles with its interlocking feature providing long lasting protection against the varying climatic conditions of upper Sonoma county.

To complete the harmony of the exterior, paint was used on the trim.

## NEWS AND COMMENT ON ART

(From Page 6)

Ryan, will feature the "Tenth Annual Pacific Coast Ceramic Exhibition," and Sale of Pottery and Sculpture is June.

Awards for this year include: First prize in Ceramic Sculpture to Miriam Hoffman for her "Terra Cotta Figure;" First Prize in Ceramic Pottery to Caroline Smith for "Decorative Bowls." The Jury for Selection and Award included Whitney Atchley, Mary Erckenbrack, James Lovera, Richard Patterson, Zygmund Sazevich, Laura Anderson, and Beatrice Judd Ryan.

The "Pictures For the Month," exhibited in the Rotunda Little Gallery, are a group of Water-colors by Mary Elizabeth Lyman.

## PORTLAND ART MUSEUM

Thomas C. Colt, Jr., director of the Portland Art Museum, West Park and Madison, announces the following exhibits and events for the month of June:

The Annual Exhibition of the Museum Art School; 20th Century Prints; Indian Baskets, showing examples of fine basket-making from the Museum's collection of Northwest Indian Arts; Lettering and Calligraphy; and Photographs by Minor White students.

Purchases from the recent Artists of Oregon exhibition include "Bay Composition No. 2," Oil by Louis Bunce; "Lands End," Gouache, by Charles Voorhies; and "Through the Gorge, Vision No. 2," lithograph by Jeanne Moment.

The Art Committee announces that the Museum will organize full exhibitions of the work of artists Charles Heaney and Carl Morris for exhibition next winter and the fall of 1952.

## Parker, Steffens & Pearce

BUILDERS

135 South Park, San Francisco

Phone: EXbrook 2-6639

## BARRETT & HILP

CONTRACTORS

*Builders of the West*

918 Harrison Street • San Francisco  
Telephone DOuglas 2-0700

234 West 37th Place • Los Angeles  
Telephone ADams 3-8161



Quality Products Since 1895  
**ANGIER PACIFIC CORPORATION**  
51 NEW MONTGOMERY ST. • 7424 SUNSET BOULEVARD  
SAN FRANCISCO 5, CALIF. • LOS ANGELES 41, CALIF.  
A complete line of Angier products available  
from your building material dealer.

## STOP

Penetration Of  
**MOISTURE**  
**WIND**  
**DUST**  
**VERMIN**

EVERLASTING  
PROTECTION

## FORDERER CORNICE WORKS

*Manufacturers of*

Hollow Metal Products • Interior Metal Trim  
Elevator Fronts and Cabs  
Metal Plaster Accessories • Sanitary Metal Base  
Flat and Roll Metal Screens  
Metal Cabinets • Commercial Refrigerators

269 POTRERO AVE.

SAN FRANCISCO, CALIF.

HEMLOCK 1-4100



## CONSTRUCTION CONTRACTS AWARDED AND MISCELLANEOUS PERSONNEL DATA

**LAUNDRY & STOREHOUSE BUILDING,** San Francisco, University of California, owner, \$448,810. STRUCTURAL ENGINEER: R. J. Fisher, San Francisco; ARCHITECT: Kent & Hess, San Francisco; MECHANICAL ENGINEER: Keller & Ganon, San Francisco, 4 story, 35,500 sq. ft., reinforced concrete construction. 1st 2 floors, structural steel frame & reinforced concrete above 3rd floor; 1st 2 floors, storehouse & office; 3rd & 4th floors, laundry, hydraulic freight elevator. GENERAL CONTRACTOR: Erbentrost & Summers, San Francisco.

**MORTUARY,** San Francisco, S. F. Funeral Service, owner, \$250,000. ARCHITECT: A. Quincy Jones, Jr., Los Angeles. Frame & stucco construction. GENERAL CONTRACTOR: Cahill Construction Co., San Francisco.

**MAYFAIR GRAMMAR SCHOOL ADDITION,** San Jose, Santa Clara County, Alum Rock Union School District, owner, 11 classrooms, 1 kindergarten, multi-purpose room, kitchen toilet room, \$240,000. ARCHITECT: Kress & Gibson, San Jose. Frame & stucco construction. GENERAL CONTRACTOR: Samuel E. Earth, San Jose.

**AGRICULTURAL SHOP BUILDING,** Eureka, Humboldt County, Eureka Union High School, owner, \$71,000. ARCHITECT: Masten & Hurd, San Francisco. Frame construction, redwood exterior, concrete floor. GENERAL CONTRACTOR: C. S. Phillips, North Petaluma.

**BRANCH OFFICE BUILDING,** Stockton, San Joaquin County, State of California, owner, \$222,450. ARCHITECT: Peter L. Sala, Stockton. 1 story & mezzanine, 18,650 sq. ft. reinforced concrete steel sash, wood roof, stud partitions, composition roofing, steel columns & roof girders. GENERAL CONTRACTOR: Nemellini Construction Co., Stockton.

**IGNACIO VALLEY SCHOOL ADDITION,** Concord, Contra Costa County, Mt. Diablo Unified School District, owner, 6 classrooms, library, multi-purpose kitchen, \$212,777. ARCHITECT: Reynolds & Chamberlain, Anderson & Simonds, Conter & Willis & John Lyon Reid, Oakland. 1 story, frame & stucco construction, 15,000 sq. ft. GENERAL CONTRACTOR: Intra-State Builders, Berkeley.

**FACTORY BUILDING,** Belmont, San Mateo County, Western Gear Works, owner, \$2,000,000. ENGINEER: J. Herbert Davies, Long Beach. 1 story, reinforced concrete & structural steel frame, steel sash. GENERAL CONTRACTOR: Barrett & Hilt, San Francisco.

### PANACALITE

The Standard for Perlite Aggregates  
An Engineered Product—Engineering Service

Air Classified—Sized & Graded for  
Plaster, Concrete & Stucco  
Aggregates

Listed Underwriters' Laboratories  
Re-examination Service

Fire Ratings:  
Non-Bearing Walls—2 hours  
Floor and Beams—4 hours  
Columns—2 & 3 hours  
Suspended Ceiling—4 hours  
Others

Manufactured by  
**American Perlite Corporation**  
26th & B Sts.—Yard 2—Richmond  
Econ 5-1385

**EDENDALE ELEMENTARY SCHOOL,** San Lorenzo, Alameda County, San Lorenzo Elementary School District, owner, 14 classrooms, administration, multi-purpose & kitchen shop, home-making & toilet rooms, \$589,000. ARCHITECT: Schmidts & Hardman, Berkeley. Frame & stucco construction. GENERAL CONTRACTOR: C. R. Hills, San Leandro.

**ELEMENTARY SCHOOL ADDITION,** Paso Robles, San Luis Obispo County, Paso Robles Board of Education, owner, 2 classrooms, boys shower & locker building, \$72,000. ARCHITECT: Frank Wynkoop & Assoc., Bakersfield. Frame & stucco construction. GENERAL CONTRACTOR: C. E. Pumphrey, Paso Robles.

**MORELAND GRAMMAR SCHOOL ADDITION,** Campbell, Santa Clara County, Moreland Elementary School District, owner, 6 classrooms, 2 kindergartens, administration and multi-purpose room, \$250,300. ARCHITECT: Birge M. Clark & Walter Stromquist, Palo Alto. Frame & stucco construction. GENERAL CONTRACTOR: Geo. J. Lauer, San Jose.

**NEW ALTOS ACRES SCHOOL,** North Sacramento, Sacramento County, North Sacramento Elementary School District, owner, 9 classrooms, kindergarten, administration, all-purpose room, kitchen, toilet room, \$334,386. ARCHITECT: Kobilik & Fisher, Sacramento. Frame & stucco construction. GENERAL CONTRACTOR: United Construction Co., Sacramento.

**SUPER MARKET BUILDING,** Corte Madera, Marin County, Littleman Stores Inc., owner, \$200,000. ARCHITECT: John Lyon Ried, San Francisco. 1 story 175 x 125, frame & stucco & redwood exterior, plate glass front, pile foundations. GENERAL CONTRACTOR: Elvin C. Stendell, San Francisco.

**UNION GRAMMAR SCHOOL ADDITION,** Los Gatos, Santa Clara County, Union Elementary School District, owner, 13 classrooms, administration, home-economics, & shop building, \$15,398. ARCHITECT: Higgins & Root, San Jose. Frame & stucco construction. GENERAL CONTRACTOR: W. R. Kalsched, San Jose.

**BANK BUILDING,** Novato, Marin County, 1st National Bank of San Rafael, owner, \$139,300. ARCHITECT: H. H. Winner, Ross. 1 story, 50 x 140, reinforced construction. GENERAL CONTRACTOR: E. P. Merritt, San Rafael.

**ENGINEERING FIELD STATION BUILDING,** Richmond, Contra Costa County, University of California, owner, \$106,564. ARCHITECT: John Hudspeth, Oakland. 1 story, 47 x 158, frame & stucco construction, linoleum floors, hot water convactor heating system. GENERAL CONTRACTOR: Marvin E. Collins, El Cerrito.

**ALEXANDER HAMILTON JUNIOR HIGH SCHOOL ADDITION,** Fresno, Fresno County, Fresno Board of Education, owner, new classrooms, building, industrial art building, lunchroom building, \$366,114. ARCHITECT: H. Raphael Lake & Elsie B. DiLuck, Fresno. GENERAL CONTRACTOR: Harris Const. Co., Fresno.

**WAREHOUSE BUILDING ADDITION,** Oakland, Alameda County, W. H. Pollard, owner, \$47,000. ARCHITECT: Alben Proberg, Oakland. 1 story, reinforced concrete construction. GENERAL CONTRACTOR: Christensen & Lyons, Oakland.

**SACRAMENTO JUNIOR HIGH SCHOOL,** Sacramento, Sacramento County, Sacra-

mento Board of Education, owner, 3 buildings, \$355,693. ARCHITECT: Harry J. Devine, Sacramento, reinforced concrete construction. GENERAL CONTRACTOR: James P. Morton, Placerville.

**GRAMMAR SCHOOL ADDITION,** Solinas, Monterey County, Washington Elementary School District, owner, 2 classrooms, \$69,561. ARCHITECT: Wm. H. Rowe, San Francisco; Jerome Kasovan, Solinas, frame & stucco construction. GENERAL CONTRACTOR: Francis J. Salinas.

**NEW INTERMEDIATE SCHOOL,** Vacaville, Solano County, Vata Valley Union Elementary School District, owner, 5 classrooms, administration, cafeteria, music building, toilet rooms, \$263,100. ARCHITECT: Kobilik & Fisher, Sacramento, frame & stucco construction. GENERAL CONTRACTOR: Pacific Co., Oakland.

**PATRICK HENRY ELEMENTARY SCHOOL ADDITION,** San Francisco, City & County of San Francisco Department of Public Works, owner, 12 classrooms, combination auditorium & lunch room, kitchen, playroom, \$728,154. ARCHITECT: W. D. Peugh, San Francisco, 2 & 3 story, reinforced concrete construction. GENERAL CONTRACTOR: Biltwell Construction Co., San Francisco.

**OFFICE BUILDING REMODEL,** San Francisco, 400 Montgomery Street Corp., owner, \$103,673. ARCHITECT: W. D. Peugh, San Francisco, interior & exterior remodel. GENERAL CONTRACTOR: Spencer B. Bagge, San Francisco.

**GOODWIN AVENUE GRAMMAR SCHOOL, HOOPER GRAMMAR SCHOOL ADDITION,** Redwood City, San Mateo County, Redwood City Elementary School District, owner, 17 classrooms, administration, kindergarten, library, home economics, music shop, multi-purpose room, kitchen, & toilet rooms; 14 classrooms, administration, multi-purpose room, kitchen, music, home economics, library, shop & toilet rooms, \$1,120,000. ARCHITECT: Arthur Janssen, Menlo Park, frame & stucco construction. GENERAL CONTRACTOR: Carl N. Swenson Co., San Jose.

**AUTO SERVICE & REPAIRS BUILDING,** San Francisco, Transportation Guarantee Co., owner, \$70,000. ARCHITECT: Bruce Heiser, San Francisco, 1 story, reinforced concrete, tilt-up construction. GENERAL CONTRACTOR: Mills Construction Co., San Francisco.

**BANK ADDITION & REMODEL,** Willits, Mendocino County, Bank of Willits, owner, \$60,000. ARCHITECT: Wm. F. Gunnison, San Francisco, addition, 1 story to present bank building, interior & exterior remodel. GENERAL CONTRACTOR: Henry Mercer, Ukiah.

**500 UNIT AIR FORCE HOUSING PROJECT,** Hamilton Field, Marin County, Claude T. Lindsay, owner, \$5,000,000. ARCHITECT: Anderson & Rowe, San Francisco, 300 units for cirmen & families; 200 units for officers & families, frame & stucco construction, equipped with stoves, refrigerators, & hot water heaters.

**LOW INCOME HOUSING PROJECT,** Newmarket, Stanislaus County, Housing Authority of Stanislaus County, owner, 16 units, \$120,000. ARCHITECT: Donald Powers Smith, San Francisco, frame & stucco construction, 8 duplex residences.

**HIGH SCHOOL ADDITION,** Shafter, Kern County, Kern County High School District, owner, 2 classrooms, offices, library, agricultural laboratory, agricultural shop, showers, etc., \$172,000. ARCHITECT: Wright, Metcalf & Parsons, Bakersfield, reinforced brick construction, structural steel roof, trusses, asphalt tile, radiant heating, insulation. GENERAL CONTRACTOR: Guy E. Hall, Bakersfield.

**NEW NORTH GRAMMAR SCHOOL,** Tracy, San Joaquin County, Tracy Elementary

School District, owner, 6 classrooms, administration, kindergarten, multi-purpose, toilet room, \$254,951. ARCHITECT: Elmore G. Ernst, Stockton, frame & stucco construction. GENERAL CONTRACTOR: Shepherd & Green, Stockton.

**NEW GRAMMAR SCHOOL.** Cloverdale, Sonoma County, Cloverdale Elementary School District, owner, 10 classrooms, kindergarten, multi-purpose, toilet rooms, \$332,880. ARCHITECT: Ernest F. Winkler, San Francisco, frame & stucco construction. GENERAL CONTRACTOR: Myrl R. Crane, San Francisco.

**DINING HALL & KITCHEN.** San Anselmo, Marin County, San Francisco Theological Seminary, owner, \$195,000. ARCHITECT: James H. Mitchell & Harold W. Hawes, San Francisco. GENERAL CONTRACTOR: Robt. McCarthey Co., San Francisco.

**NEW GRAMMAR SCHOOL.** Santa Rosa, Sonoma County, Belong Unified School District, owner, 15 classrooms, administration, all-purpose room, kitchen & toilet rooms, \$445,527. ARCHITECT: C. A. Caulkins, Santa Rosa, frame & stucco construction. GENERAL CONTRACTOR: Santa Rosa Grammar School Addition, Eleton, Sacramento County, Isleton Union Elementary School District, owner, 2 classrooms, administration, all-purpose & kitchen rooms, \$145,621. ARCHITECT: Geo. C. Sellon, Sacramento, frame & stucco construction. GENERAL CONTRACTOR: Wismer & Miller, Lodi.

**AUTO SHOP BUILDING.** San Jose, Santa Clara County, East Side Union School District, owner, \$54,944. ARCHITECT: Kreses & Gibson, San Jose, 1 story, reinforced concrete & frame construction. GENERAL CONTRACTOR: W. J. Nicholson Co., Santa Clara.

**GRAMMAR SCHOOL ADDITION.** Campbell, Santa Clara County, Cambrian Elementary School District, owner, 12 classrooms, 2 kindergartens, home economics, shop building, toilet rooms, \$358,979. ARCHITECT: Chas. E. Bulner, frame & stucco construction. GENERAL CONTRACTOR: Nielson & Nielson, San Jose.

**HILLVIEW GRAMMAR SCHOOL ADDITION.** Los Altos, Santa Clara County, Los Altos Elementary School District, owner, 10 classrooms, kindergarten, health, multi-purpose, kitchen, toilet rooms, \$309,915. ARCHITECT: Lawrence W. Gentry, Los Altos, frame & stucco construction. GENERAL CONTRACTOR: E. A. Hathaway & Co., San Jose.

**SHOP BUILDING.** Arcata, Humboldt County, Arcata Union High School District, owner, \$98,631. ARCHITECT: Masten & Hurd, San Francisco, reinforced concrete construction, structural steel frame, steel roof deck. GENERAL CONTRACTOR: A. C. Johnson & Sons, Eureka.

**ELEMENTARY SCHOOL.** Fortuna, Humboldt County, Fortuna Union Elementary School District, owner, 9 classrooms, kindergarten, administration, all purpose kitchen & toilet rooms, \$338,808. ARCHITECT: Masten & Hurd, San Francisco, frame construction. GENERAL CONTRACTOR: H. L. Peterson Construction Co., San Francisco.

**RECTORY.** Burlingame, San Mateo County, Roman Catholic Archbishop of San Francisco, owner, Our Lady of The Angel's Parish, San Francisco, 2 story & part basement frame & stucco construction, wood sash, tile roof, asphalt tile & linoleum, floors, some brick work. GENERAL CONTRACTOR: O. C. Moroney, Burlingame.

**MUSIC BUILDING, BENJAMIN FRANKLIN JR. HIGH SCHOOL.** Vallejo, Solano County, Vallejo Unified School District, owner, \$125,044. ARCHITECT: Masten & Hurd, San Fran-

cisco, frame & stucco construction. GENERAL CONTRACTOR: L. Nielsen, Loyalmete. **SAN JOSE HOSPITAL ADDITION.** San Jose, Santa Clara County. San Jose Hospital, owner, 70 beds, elevators & kitchen equipment, \$1,089,376. ARCHITECT: D. D. Stone & Lou Mulloy, San Francisco, 2 story, reinforced concrete construction, 1 elevator metal sash, terrazzo, rubber & asphalt floor. GENERAL CONTRACTOR: Elmer J. Freathy, El Cerrito.

**MARKET BUILDING, HARDWARE & DRUG STORE BUILDING.** Sacramento, Sacramento County, Suburban Enterprises, Inc., owner, \$225,000. ARCHITECT: Rickey & Brooks, Sacramento, 1 story, concrete block & frame construction. GENERAL CONTRACTOR: Erickson Construction Co., North Sacramento.

**ALICE BIRNEY ELEMENTARY SCHOOL.** Fresno, Fresno County, Fresno Board of Education, owner, \$497,534. ARCHITECT: Franklin & Simpson, Fresno. GENERAL CONTRACTOR: R. Pedersen & Son, Fresno. **OFFICE, SALES ROOM & WAREHOUSE.** Reno, Nevada, Tay Holbrook, Inc., San Francisco, \$94,000. ARCHITECT: Edward S. Parson, Reno, 1 story, brick & structural steel construction, wood roof. GENERAL CONTRACTOR: Frank Capriotti, Reno.

**BRANCH OFFICE BUILDING.** Stockton, San Joaquin County, State of California, owner, state employment department, \$291,521. ARCHITECT: Peter L. Sala, Stockton, 1 story, mezzanine, 8,650 sq. ft., reinforced concrete, steel sash, wood roof, stud partitions, composition roofing, steel columns & roof girders. GENERAL CONTRACTOR: Nomenclini Construction Co., Stockton.

**MARKET BUILDING.** San Francisco, R. D. Lang, owner, \$150,000. ARCHITECT: Geo.

Mou, Berkeley, 1 story & basement, 83x190, reinforced concrete construction, wood roof, plate glass front. GENERAL CONTRACTOR: Thos. Ellingson, San Francisco.

**MILLVIEW GRAMMAR SCHOOL ADDITION.** Los Altos, Santa Clara County, Los Altos Elementary School District, owner, 10 classrooms, kindergarten, health, multi-purpose, kitchen, toilet rooms, \$309,915. ARCHITECT: Lawrence W. Gentry, Los Altos. Frame & stucco construction. GENERAL CONTRACTOR: E. A. Hathaway & Co., San Jose.

**SAFEBAY MARKET BUILDING.** San Francisco, Bramwell Construction Co., owner, \$168,000. ARCHITECT: Joseph & Joseph, San Francisco, 1 story, reinforced concrete block & brick veneer, wood roof. GENERAL CONTRACTOR: Jos. Bettancourt, San Bruno.

**LIVE OAK.** Sutter County, Sacramento Valley Walnut Growers Association, owner, \$200,000. ENGINEER: H. M. Engle, San Francisco, 1 story, reinforced concrete, steel & frame construction. GENERAL CONTRACTOR: Younger Construction Co., San Francisco.

**CHURCH & SUNDAY SCHOOL.** Danville, Contra Costa County, Community Presbyterian Church, owner, \$68,219. ARCHITECT: Donald Powers Smith, San Francisco, frame & stucco construction. GENERAL CONTRACTOR: Pike & Hill, Diablo.

**STORE & OFFICE BUILDING.** Reno, Nevada, Onslow S. Dodd, owner, \$379,875. ARCHITECT: Paul C. Overmir, San Francisco. STRUCTURAL ENGINEER: Hyman Rosenthal, San Francisco, 4 story, basement, 95x100, class A structural steel frame, reinforced concrete construction, porcelain enameled exterior, 2 elevators, steel windows & doors. GENERAL CONTRACTOR: A. J. Hopper Co., San Francisco.

## How to plan telephone facilities for best year-around living...

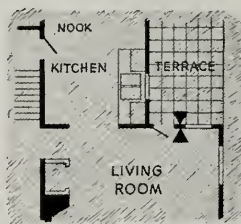
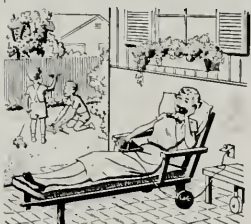

Preferred locations for telephones often vary with seasons—for example, you may want to plan for a portable telephone outlet on the terrace in summer. So home owners find extra convenience in having telephones where and when they need them. Flexibility is assured by thoughtful builders who provide for additional outlets in their blueprints.

Home owners appreciate built-in conduit and outlets and the cost of installing them during building is small. These extra facilities make it easy to add telephones later, without marring the beauty of interiors through exposed wiring. For free help in planning, call your local Pacific Telephone office and ask for "Architects and Builders Service."

Put built-in telephone facilities in your plans



Pacific Telephone

# IN THE NEWS

## ARCHITECT SELECTED

Angus McSweeney, architect of San Francisco, has been chosen to draft plans for the construction of a 400 unit low income housing project to be constructed in San Francisco by the San Francisco Housing Authority.

The construction will be located at Hunter's Point.

## PUBLIC WORKS IN LOS ANGELES UP

Forty-three highway, street and bridge projects totaling \$6,327,808 were launched in Los Angeles county last month. This brings to 58 the number of projects started since the first of the year, totaling some \$11,032,347.

In addition four flood control projects totaling \$8,141,313 were started in the county.

## AIR FORCE HOUSING

Work has started on the construction of 750 new residences at the Mathis Air Force Base near Sacramento under provisions of the Wherry Act. The houses are to be of one story construction and will represent a cost of \$7,500,000.

Jos. H. Gaylord of Fort Worth, Texas, and Ned H. Abrams, Sunnyvale, California, are the architects.

## SACRAMENTO SIGNAL CORPS IMPROVEMENT

The Corps of Engineers, U. S. Army, has announced a program of improvements at the Sacramento Signal Depot, Sacramento, California, comprising a new maintenance shop and a vehicle processing plant.

Federal funds in the amount of \$4,197,000 have been approved for the work.

## HELICOPTER ADDITION

The United Helicopter Company of Palo Alto are constructing an addition to their plant, comprising a 1-story 160x160 structural steel, and structural glass exterior.

Mott Lehmann of Redwood City is the Engineer.

## ARCHITECT SELECTED

The architectural firm of Clark & Buettler, San Francisco, have been chosen to draft plans for the construction of a \$700,000 addition to the French Hospital in San Francisco.

The addition will be of 2-story reinforced concrete construction with basement.

## NEW MEDICAL DENTAL BLDG.

A new Medical-Dental building is being constructed in Orland (California) for Dr. Theo. Poulsen by Earl C. Vail, general contractor of Willows.

Albert W. Kahl of San Mateo is the architect.

## ELECTED PRESIDENT PLUMBING CONTRACTORS

William H. Nethoff of Los Angeles has been elected president of the Associated Plumbing Contractors of California for the year 1951.

A 45-year veteran of the plumbing industry, with two sons in the business, Nethoff is past president of the Los An-

geles Chapter and of the Southern California Federation of the Plumbing and Heating Industry.

His successors Lester G. Doell of Oakland. Other officers elected at the recent annual convention in San Francisco include William S. Peters, San Jose, vice president; Richard Heald, Long Beach, secretary-treasurer; Directors: Harvey S. Holland, Sacramento; Lester G. Doell, Oakland; Joseph C. Sand, San Francisco; Fred A. Schmitz, Redwood City; John Holdener, San Diego; Earl Van Atta, Puente; and Frank E. Hess, Los Angeles.

## ARCHITECT OPENS OFFICE

Herbert Mullen, Architect, recently opened an office at 2015 Jay Street, Sacramento, for the general practice of architecture.

He was formerly located at 4817 Brand Way, same city.

## LOS ANGELES COUNTY BUILDING BOOMS

Los Angeles county industrial expansion at the present time is more than 400 per cent greater than last year, while the rate of increase for the nation as a whole is only 66 per cent.

This disclosure was made by James F. Bone, manager Industrial Department of the Los Angeles Chamber of Commerce at a recent meeting of the Society of Industrial Realtors at Los Angeles.

## LOW INCOME HOUSING PROJECT

Architect Walter Wagner, Fresno, has completed working drawings on four Low Income Housing projects to be constructed in Fresno County by the Housing Authority of the City of Fresno.

The projects represent a combined construction of 300 units which are to be of frame and stucco construction with plywood interiors.

## SCHOOL BONDS APPROVED

Voters of the Sequoia Union High School District of Redwood City have approved a bond issue of \$1,500,000 for the purpose of completing the new High School at San Carlos-Belmont.

The work consists of reinforced concrete construction, and is part of an original bid held by Parker, Steffens & Pearce Contractors.

## NPA PERMIT GRANTED

An N. P. A. Permit has been granted to the Rancho Wilder Company of Los Altos for the construction of a \$200,000 Shopping Center near Los Altos.

The Center will be of frame construction with redwood and brick veneer exterior.

## PILE FOUNDATION CONTRACT AWARDED

The Continental Construction Company of Sacramento was awarded a \$213,500 contract by the State Department of Public Works for the pile foundation of the new California State Printing office to be built in North Sacramento.

The contract covers the furnishing and driving of 500 concrete piles and pile caps, plus a certain amount of foundation work, excavating and backfill, and grading.

## AIR FORCE CENTER NEGOTIATED CONTRACT

The District Engineer, Corps of Engineers, San Francisco, has negotiated a contract with the Macco Corp., Theo. G. Meyer &

Sons, Chas. L. Harney, and Barret & Hiip, a joint venture, for the construction of a new air force indoctrination center to be built on the site of Camp Parks and Camp Shoemaker, near Dublin in Alameda county.

The project consists of 181 barracks buildings and seven mess halls to accommodate an estimated 30,000 men.

## NEW COUNTY OFFICES

Architects Birge M. Clark and Walter Stromquist of Palo Alto are working on plans for the construction of new county office building in the new government Civic Center in San Jose for the county of Santa Clara.

Of 1-story reinforced concrete construction, the building will cost an estimated \$451,200.

## ARCHITECT CHOSEN FOR CITY HALL

Architect Leslie N. Nichols of Palo Alto has been selected by the City of Palo Alto to draft plans for the construction of a new City Hall.

Estimated cost of the project is \$380,000.

## MC-CLELLAN AIR FORCE BASE

A recent announcement by the U. S. Air Force shows that among improvements to be made in the air force facilities throughout the nation is a \$5,099,000 allotment for the McClellan Air Force Base near Sacramento.

## U. S. NAVY WANTS CONSTRUCTION CB

Seabees are needed by the U. S. Navy to strengthen its inactive Volunteer Reserve program and men with construction trade experience are being sought.

Recalls to active duty will not be made unless the rating specialty is vitally needed to fill a billet in an active Naval Construction Battalion.

Approximately 60 different construction trades are represented in the Seabee organization and are combined into 14 Navy ratings. Complete information is available through any Navy Recruiting Office.

## CONTRACTOR MOVES INTO NEW OFFICES

The P. J. Walker Construction Company recently moved their executive offices from 555 South Flower Street, Los Angeles, to 714 West Olympic Boulevard, same city. The new telephone number is Richmond 7-5521.

## STRUCTURAL CLAY PRODUCTS SURVEY

The Structural Clay Products Institute has released a survey on the announced policy of top-level military construction authorities committed to a consideration of initial cost only in building for defense needs.

The Institute has taken the position that equally in importance with initial construction is maintenance, and any construction should include this factor in maintaining a policy designed to prevent wasteful spending of public funds.

## REVISION IN SCHOOL CODE WILL SAVE MONEY

Cleveland taxpayers will save over \$100,000 in the next 5 years as a result of a revision in Ohio's school building code.

Arthur Baer, architect for the Cleveland school system, reports that building of 10 ft. ceiling classrooms, rather than the customary 12 ft. ceilings, plus modern lighting equipment will not only meet the needs of



## MULLEN MFG. COMPANY

BANK, STORE AND OFFICE  
FIXTURES—CABINET WORK  
OF GUARANTEED QUALITY  
CHURCH SEATING

Office and Factory  
40-80 RAUSCH ST., Bet. 7th and 8th Sts.  
San Francisco  
Telephone UNDERhill 1-5815

### Thinking of Building?

From our cost records and experience, an advance estimate may be made from decidedly general information. Based on our knowledge of labor and material costs, gained on current jobs, such an estimate may be helpful in determining your construction program.

ALL TYPES CONSTRUCTION  
SAN FRANCISCO • SACRAMENTO  
**SWINERTON & WALBERG CO.**  
OAKLAND • LOS ANGELES • DENVER

STATIONERY  
SCHOOL & OFFICE  
SUPPLIES

Printing Engraving  
Announcements

CENTER STATIONERY  
468 McAllister  
San Francisco UN 1-3703

*Fine*  
**ENGRAVINGS**



**POOR  
RICHARD**  
PHOTO ENGRAVING CO.  
320-324 COMMERCIAL STREET  
SAN FRANCISCO, 13

the student, but will save considerable construction cost.

"Building codes usually lag behind the times in relation to new materials," declared Boer, "Ohio, however, stands as a leader in the modernization of state building codes, and Ohio citizens will be richer for it."

#### ARCHITECT SELECTED

Gilford E. Sobey, architect of Los Gatos, has been selected to design a 50-bed hospital for the West Valley Hospital District of Los Gatos.

Cost of the construction is estimated at \$500,000.

#### APARTMENT HOUSE

Work has started on the construction of an 8-apartment building in Santa Rosa, which is of 2-story frame and stucco type construction. Cost of the building is \$50,000.

#### APARTMENT HOUSE

E. A. Corum & Son of Sacramento have started construction of sixteen apartment buildings near Sacramento at a cost of \$552,500. Each building, of 2-story frame and stucco construction, will contain six apartments.

#### ARCHITECT SELECTED

The architectural firm of Swartz & Hybe of Fresno have been chosen by the Firebaugh Joint Union School District to design three new grammar schools, comprising 27 classrooms, 3 administration, 3 kindergartens, 3 multi-purpose and kitchen rooms, and an arts and crafts unit.

Of frame and stucco construction the buildings will cost \$993,998. Bonds for construction of the buildings have been voted by the district.

#### PABCO EXPANDS

Pabco Products Inc. of San Francisco recently acquired controlling interest in the Pacific Roofing Company of Portland, Oregon, and Tacoma, Washington.

T. C. Young will actively continue as president of the Pacific Roofing Co., and there will be no change in the name.

#### NEW WAREHOUSE

Fred D. Parr, president of the General Warehouse Company of San Francisco, announces construction on a new 1-story warehouse building containing 570,000 sq. ft. has started in South San Francisco.

Cost of the reinforced concrete and frame building is \$2,000,000.

Ward & Bolles of San Francisco are the architects and Barrett & Hip, San Francisco the general contractors.

#### RESIDENTIAL ACTIVITY GROWS IN LOS ANGELES

In 1949 there were 500 new residential tracts, with a total of 32,034 lots, recorded in Los Angeles county. There were 820 new subdivisions, with 62,074 lots, recorded last year, and during the first quarter of this year 192 new tracts with 10,481 lots were recorded.

#### HOME DEVELOPMENT FOR WILL ROGERS RANCH

The 12-acre plateau that was the avocado grove and orchard of the famed Will Rogers Ranch in Brentwood, southern California, has been bought by Max Rosenberg & Sons, home builders for \$100,000.

The tract will be sub-divided and 33 new residences built. It is to be called the Will Rogers Riviera.



**HERRICK  
IRON WORKS**  
STRUCTURAL STEEL  
REINFORCING STEEL

18TH AND CAMPBELL STS.  
OAKLAND, CALIF.  
Phone Glencourt 1-1767

Phone GARfield 1-1164

**Thomas B. Hunter**  
DESIGNER OF HEATING

AIR CONDITIONING  
VENTILATING AND WIRING  
SYSTEMS, MECHANICAL  
AND ELECTRICAL EQUIP-  
MENT OF BUILDINGS

★  
41 SUTTER STREET  
ROOM 710  
San Francisco California

Subscribe  
Now —

**ARCHITECT  
and  
ENGINEER**

\$3.00  
Per Year

**DINWIDDIE  
CONSTRUCTION  
COMPANY**

**BUILDERS**

CROCKER BUILDING  
SAN FRANCISCO



Subscribe  
Now —

**ARCHITECT  
and  
ENGINEER**

**\$3.00  
Per Year**

**STOLTE INC.**

*General Contractors*



**OAKLAND • CALIFORNIA**

**PITTSBURGH  
TESTING LABORATORY**

**ENGINEERS AND CHEMISTS**

Testing and Inspection of Concrete,  
Steel and Other Structural Materials

Design of Concrete Mixes

Offices in all principal cities

651 Howard St., San Francisco 5  
EXbrook 2-1747

**MATTOCK  
CONSTRUCTION  
COMPANY**



**BUILDERS**



604 MISSION STREET  
SAN FRANCISCO

**Index to Advertisers**

AMERICAN Perlite Corp.....	44
ANGLER Pacific Corp.....	43
ARCHITECTS Reports .....	38
BARRETT & HILP, Contractors .....	43
CLASSIFIED Advertising .....	42
CENTER Stationery .....	47
CLAY Brick & Tile Association.....	5
CLINTON Construction Company.....	36
COLUMBIA Steel Co.....	*
CROCKER, First National Bank.....	38
DINWIDDIE Construction Co.....	47
ELECTROMODE Corpn. ....	34
FULLER, W. P. Co.....	*
FORDERER Cornice Works.....	43
GLADDING McBean & Company.....	*
GREENBERG'S, M. Sons .....	32
HANKS, Inc., Abbott A.....	48
HAW'S Drinking Faucet Co.....	28-29
HERRICK Iron Works.....	47
HILLYARD Chemical Co.....	*
HOGAN Lumber Co.....	36
HUNT, Robert W., Company.....	48
HUNTER, Thos. B.....	47
JOHNSON, S. T. Co.....	*
JUDSON, Pacific-Murphy Corp.....	26
KRAFTILE Company .....	26
MARBLE Institute of America .....	*
MATTOCK Construction Co.....	48
MICHEL & Pfeiffer Iron Works.....	2
MULLEN Mfg. Co.....	47
PACIFIC Cloy Products Co.....	*
PACIFIC Coast Gas Association .....	31
PACIFIC Manufacturing Company.....	37
PACIFIC Portland Cement Company.....	Back Cover
PACIFIC Telephone & Telegraph Co. 45	
PARKER, Steffens & Pearce.....	43
PITTSBURGH Testing Laboratory.....	48
POOR Richard Engraving Co.....	47
PORCELAIN Enamel (Architectural Division) Publicity Bureau .....	23
REMILLARD-Dandini Co.....	48
REPUBLIC Steel Corporation.....	37
SCOTT Co.....	48
SIMONDS Machinery Company.....	37
SISALKRAFT Company .....	36
SMOOT-Holman Company .....	24
SOTO, Henry C.; Corpn, Landscape ..	24
STANLEY Works, The.....	*
STOLTE, Inc.....	48
SUPERIOR Fireplace Co.....	35
SWINERTON & Walberg Co.....	47
U. S. Bonds .....	Inside Front Cover
UNITED STATES Steel Corp'n.....	*
UTILITY Appliances Corp'n.....	25
VERMONT Marble Company.....	37
WEST Coast Screen Co.....	31
WESTERN Asbestos Company.....	*

\*Indicates Alternate Months

**ROBERT W. HUNT CO.**

**ENGINEERS**

**INSPECTING TESTING**

**STRUCTURAL MATERIALS  
CONCRETE MIX DESIGN  
CHEMICAL ANALYSIS  
EQUIPMENT**

PRINCIPAL CITIES  
UNITED STATES • EUROPE  
SAN FRANCISCO LOS ANGELES  
PORTLAND SEATTLE

**REMILLARD-DANDINI Co.**

**Brick and  
Masonry Products**



400 MONTGOMERY STREET  
SAN FRANCISCO, CALIF.

**Scott Company**

**HEATING • PLUMBING  
REFRIGERATION**



San Francisco  
Oakland  
San Jose  
Los Angeles

**ABBOT A. HANKS, INC.  
Engineers & Chemists**

**INSPECTING — TESTING — CONSULTING  
CONCRETE • STEEL • MATERIALS  
CHEMICAL AND TESTING  
LABORATORIES  
• RESEARCH AND INVESTIGATION •**

TESTS OF STRUCTURAL MATERIALS  
DESIGN OF CONCRETE MIXES  
SHOP AND ERECTION INSPECTION OF  
STRUCTURES AND EQUIPMENT  
INVESTIGATION OF STRUCTURES  
AND MATERIALS  
TESTS AND INVESTIGATION OF  
FOUNDATION SOILS  
FIRE RESISTANCE AND INSULATION  
TESTS

624 Sacramento Street, San Francisco

# ARCHITECT AND ENGINEER

FIRST NATIONAL BANK Building, Chicago



Architect: W. D. Cowi, S. J. A., Chicago

JULY

1951

# Porcelain

## ENAMEL VENEER

Here is a modern facing material so versatile that:

*Whatever you can create on paper—  
PORCELAIN ENAMEL can execute.*

*Whatever colors you need—  
PORCELAIN ENAMEL can match.*

This completely functional facing is strong, durable, firesafe—and simple washing maintains Lifetime Beauty.

Write today for detailed information—and specify *Porcelain Enamel Veneer, inside and out*

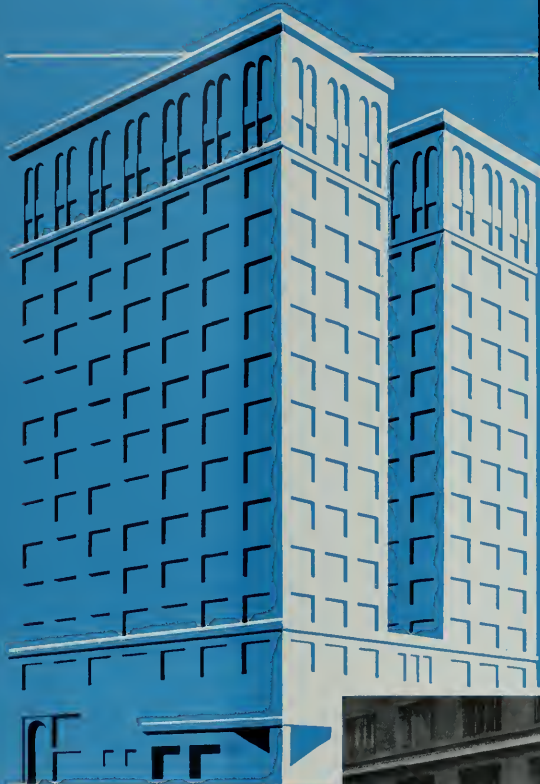

Architects:  
Ponsford & Price  
Burke & Kober

Foreman & Clark selected Porcelain Enamel for this beautifully practical two-story remodeling job. The base is black marble.

Investigate Porcelain Enamel Panels for curtain walls in essential building construction.



*Architectural Division*

**PORCELAIN ENAMEL PUBLICITY BUREAU**  
P. O. BOX 186, EAST PASADENA STATION, PASADENA 8, CALIFORNIA  
ROOM 601, FRANKLIN BUILDING, OAKLAND 12, CALIFORNIA

# ARCHITECT

Vol. 186 No. 1

# AND ENGINEER

ARCHITECTS' REPORTS—Published Daily

## Contents for

# JULY

EDWIN H. WILDER  
Editor

MARK DANIELS, A.I.A.  
Associate Editor

J. WELLS HASTINGS  
Contributing Editor

PROF. LELAND VAUGHAN  
Landscape Architecture

JOHN A. BLUME  
Structural Engineering

MICHAEL GOODMAN  
Planning

JOHN S. BOLLES, A.I.A.  
Book Reviews



## COVER PICTURE

Among the outstanding new commercial buildings of the Pacific Northwest, is the industrial branch of the First National Bank in Portland, Oregon.

The Cover illustration shows a night view which gives a striking outline of the structural lines and utility features, as designed by Architect Morton H. Caine, A.I.A. For complete details see story on Page 16.

ARCHITECT & ENGINEER  
is indexed regularly by  
ENGINEERING INDEX, INC.

EDITORIAL NOTES . . . . .	4
JOINT INFORMATION COMMITTEE . . . . .	6
American Institute of Architects & Producers' Council.	
NEWS AND COMMENT ON ART . . . . .	7
TIPS ON PAINTING ON HOT SUMMER DAYS . . . . .	9
By Dr. W. Schweisheimer.	
THE CRUMBLING TRANSONIC BARRIER . . . . .	10
By C. Desmond Pengeley, Chm., Engineering Mechanics, Southwest Research Institute, San Antonio, Texas.	
INFORMALITY MARKS CHARM OF NEW INDUSTRIAL BRANCH BANK DESIGN, Portland, Oregon . . . . .	16
By Arthur W. Priaulx, Merton H. Caine, A.I.A., Architect; Al Teller Construction Co., Contractor; Arthur Erfeldt, Landscape Architect.	
A DREAM IN THE DESERT, NEW ELEMENTARY SCHOOL, McKittrick, Calif. . . . .	20
Wright, Metcalf and Parsons, Architects, Bakersfield.	
SOMETHING NEW UNDER THE SUN, AN ALUMINUM LATH HOUSE, Beverly Hills, California . . . . .	22
REMODEL LATHAM SQUARE BUILDING, Oakland, California . . . . .	25
A.I.A. ACTIVITIES . . . . .	26
WITH THE ENGINEERS . . . . .	28
PRODUCERS COUNCIL PAGE . . . . .	30
Edited by CARL B. FRANK, Detroit Steel Products.	
BOOK REVIEWS, Pamphlets and Catalogues . . . . .	36
ESTIMATOR'S GUIDE, Building and Construction Materials . . . . .	39
ESTIMATOR'S DIRECTORY, Building and Construction Materials . . . . .	41
BUILDING TRADES WAGE SCALES, Northern, Central & Southern California . . . . .	42
CLASSIFIED ADVERTISING . . . . .	43
CONSTRUCTION CONTRACTS AWARDED, General Data . . . . .	44
IN THE NEWS . . . . .	46
INDEX TO ADVERTISERS . . . . .	48

ARCHITECT AND ENGINEER (Established 1905) is published on the 15th of the month by The Architect and Engineer, Inc., 68 Post St., San Francisco 4; Telephone EXbrook 2-7182. President, K. P. Kierulff; Vice-President and Manager, L. B. Penhorwood; Treasurer, E. N. Kierulff.

Los Angeles Office: Wentworth F. Green, 439 So. Western Ave., Los Angeles 5; Telephone DUnkirk 7-8135.

Entered as second class matter, November 2, 1905, at the Post Office in San Francisco, California, under the Act of March 3, 1879. Subscriptions United States and Pan America, \$3.00 a year; \$5.00 two years; foreign countries \$5.00 a year; single copy 50c. ARCHITECTS' REPORTS are published daily from this office, Vernon S. Yallop, Manager, Telephone DOuglas 2-8111.





# EDITORIAL NOTES

## NEED FOR GOVERNMENT ECONOMY

The need for government economy is clear. Our tremendous productive machine, running at full tilt, is still incapable of meeting all the demands that are placed upon it. We shall all have to do without things we want, things to which we feel entitled and for which we would be willing to pay.

High taxes and credit controls are imposed to compel us, as individuals and businesses, to restrain our expenditures; we are exhorted to recognize our responsibility as citizens to save. It is intolerable that the Federal government, which next year will spend about one-fourth of the national income, should not share in the general belt-tightening. (Federal, state and local expenditures will account for about one-third of the national income!)

In fact, the government's responsibility is greater than even its large percentage share would indicate. The government is in a position of leadership. The extent to which it demonstrates self-restraint will have a great influence upon the willingness of the public to accept the taxes and other restraints necessary to our economic and political strength.

THE defense department has an Industrial Services Branch to provide industry and labor with information on the armed services. Offices are in the Pentagon, Washington, D. C.

## COLD STEEL

It is difficult to conceive how any enemy of the democratic way of life could successfully compete with this nation in any show-down situation.

The ability of American men and women to produce essential commodities and goods under pressure is not known, although the many outstanding records of manufacturing plants during World War II bespeak of a record that is unequalled by any other people of the world.

Even in peace-time many industries maintain production schedules that are outstanding. The steel industry, for example, reached an important milestone in 1950 when the annual ingot capacity passed the 100 million ton mark, which is 47.2 million tons or nearly 90 per cent more than was produced by the American steel industry in 1939. This figure is about 12 per cent more than the peak wartime production of this country in 1944.

One hundred million ingot tons of steel is approximately equal to the estimated steel capacity of the rest of the world combined, and is more than three times the estimated steel production of

Russia and its satellite countries in 1950.

The superiority of the American in production is probably as important as the atom bomb in the eventual and continued security of this nation.

## VULNERABLE HIGHWAY FUNDS

A recent attempt in the Arizona House of Representatives to establish a State Tourist Bureau to be financed the first year by an appropriation of \$250,000 from road funds, is something that should be given very careful consideration by everyone interested in the continued development of good roads and highways throughout the West.

There are a great many excellent arguments in support of a state-wide, non-commercial, and non-political agency whose efforts are devoted to the business of selling the scenic beauties and climatic advantages of any region. Such a program brings untold new dollars from tourists and pours them into every commercial enterprise, many manufacturing channels, and numerous professional activities within the areas involved.

The long and enviable experience of such outstanding travel development organizations as the Redwood Empire Association, the All Year Club of Southern California, Californians Inc., Oregon-Pacific Highway Association, Evergreen Play-ground Association, Inland Empire Association, Puget Sounders', Montanans' Inc., Pacific Northwest Tourist Association, South Idaho, Inc., the Cody Club of Wyoming, and a host of local, regional and state chambers of commerce, are indisputable proof of the value of associations and organizations whose chief objective is the stimulation of tourist travel and possibly permanent residents.

On the other hand, it is as equally important that any plan which dips into highway construction and maintenance funds is bound to result in serious disadvantage to the ever increasing needs of the motoring public for safe and adequate highways. Even the most ardent advocate of a state financed tourist development program will recognize the fact that without good, safe highways you can not attract tourists.

Engineering progress, continued improvement of construction materials and methods, and a steadily growing highway traffic, is a triangle that can only be unified by adequate funds, and any proposal to divert a portion of road funds to any other than maintenance and construction purposes is only courting eventual highway traffic stagnation.

# How Colorful Clay Brick *Enhances* School Architecture

An excellent example of modern school architecture utilizing Clay Brick is the Antioch, California High School. Ernest J. Kump, A.I.A., Architect. Wallace D. Harkins, Contractor.

Clay Brick's color and texture give this classroom warmth and interest.



PHOTOS BY ROGER STURTEVANT



*Inside or Outside*  
**A CLAY BRICK WALL  
BEST FINISH OF ALL**

**WARM, FRIENDLY COLOR**—Clay Brick's built-in color and texture make it a top choice in building materials wherever economy and beauty must be combined.

**MAINTENANCE COST... ZERO**—Clay Brick walls never need painting or refinishing. Unlike most materials that need periodic refurbishing, Clay Brick's texture and color become more appealing with the years.

**IMMUNITY TO VANDALISM**—Clay Brick walls have a rugged surface that even school children, careless and rough as they are, find difficult to mar.

**FLEXIBILITY**—Clay Brick's small modular scale makes it easy to combine effectively with other construction materials.

## **CLAY BRICK & TILE ASSOCIATION**

OF NORTHERN CALIFORNIA

55 NEW MONTGOMERY STREET • SAN FRANCISCO

Kroftile Company  
Remillard Dandini

L. P. McNear Brick Co.  
San Jose Brick & Tile

Port Costa Brick Works  
Stockton Brick & Tile Co.

United Materials & Richmond Brick Company

# JOINT INFORMATION COMMITTEE

AMERICAN INSTITUTE OF ARCHITECTS and THE PRODUCERS COUNCIL, INC.

---

In recapitulating the results of the survey conducted by the A.I.A. we find that 21% of the membership replied with questionnaires completed. At first glance this would seem unrepresentative of the problem surrounding consideration of a card file or loose leaf type of specification service.

Actually considered realistically the normal apathy that exists when an attempt to obtain factual material by survey is made this result is phenomenally high. It shows a real consideration on the part of the membership keeping up with current developments. Usually 10 per cent can be considered a good return for this type of survey.

The careful consideration of questions 3, 6 and 7 is well worth pursuing. Question 3 "Do you feel that a continuously maintained specifications service would be of use?" was answered yes by 1222 architects and no by only 60 out of a total number returning the survey of 1344. This leaves little room for doubt concerning the value of such a proposal.

Question 6 "Would you use a flexible, card or looseleaf type of specification service if initiated by the A.I.A. and kept up to date with Acceptable practices?" was answered in the affirmative by 1178 of the membership and no by 74. This is definite confirmation of the idea of UNIFORM SPECIFICATIONS in its most elementary form.

Question 7 "If such a system is initiated would you favor permitting individual manufacturers and trade associations to provide separate cards (of contrasting color) if edited by the A.I.A. staff" was also answered in the affirmative by an overwhelming majority of 1211 yes to 94 no.

The practically unanimous affirmative reply

shown for the use of this type of specification proposal leaves little room for doubt concerning its value to the Architect. It points up the approval of the idea for UNIFORM SPECIFICATIONS as stated before. What now remains to be done is the slow steady process of building a large awareness of the idea and its general acceptance to the point where it can be initiated by popular demand.

The invitation extended to the manufacturers and trade associations to participate in the development of such a system is far seeing and will undoubtedly contribute to the eventual practicability of such a plan. Many mutual exchanges of opinion are in order to create the best possible system for all concerned.

The appointment of F. Bourn Hayne to the National Joint Information Committee of the A.I.A. is a fair tribute to the basic work and invaluable contribution he has made to initiate the steps toward UNIFORM SPECIFICATIONS. With his representation on the committee the continuation of the work started will be assured for the Western Chapters of the A.I.A. who have taken the initial steps in this idea.

The ARCHITECT AND ENGINEER magazine will continue to support this development so that it can have the greatest possible publication at all times to all members of the building profession most concerned with the specification and trade literature problem. The initial steps have been successful and with great care we can now proceed to the next phase which will probably be experimental samples for the best type of system to be used for Specification Files.

---

*NOTE: This news space is being contributed by ARCHITECT & ENGINEER Magazine to the JOINT INFORMATION COMMITTEE representing the Northern California Chapter of The American Institute of Architects and the Northern California Chapter of the Producer's Council, Inc., and is available to this Committee for the purpose of bringing to the attention of leaders within the Construction Industry various phases of the Architectural profession and building materials industry procedures for general consideration and comment. Your "ideas" and any suggestions for the better pooling of thoughts along these lines should be sent to "Joint Information Committee, c/o The Architect & Engineer, 68 Post Street, San Francisco," where they will be immediately forwarded to the proper committee members.*

# NEWS AND COMMENT ON ART

## ROSICRUCIAN EGYPTIAN ORIENTAL MUSEUM

James C. French, Curator of the Rosicrucian Egyptian, Oriental Museum and Art Gallery, Rosicrucian Park, San Jose, California, has announced a special showing of the works of Contemporary Berlin Artists will be shown at the Museum from June 15th through July 15th.

The Museum is open daily and is free to the public.

## CALIFORNIA SCHOOL OF FINE ARTS

The Annual Student Exhibition and granting of Certificates of Completion, and the awarding of scholarships was recently held at the California School of Fine Arts in San Francisco.

Two top honors, the Fletcher Cup Award and the I. N. Walter Sculpture Prize were awarded to Charles Wong and Fenton Kastner. Herbert Abraham, Miriam Hoffman and Deborah Remington were awarded Honor Scholarships for the ensuing academic year starting in September. Twenty-one working scholarships were also given.

Stephen Van Heune, Pasadena City College; Kenneth Skillicorn, Monterey Peninsula College; Rudolph Miranda, Richmond Union High School; Jeanne Tvedt, Oakland Technical High School; and David Nelson of the Herbert Hoover High School of Glendale, were awarded the Junior College and High School Scholarships.

Katherine Wyllys of Tempe, Arizona, received the National Scholastic Award Scholarship, and the Latham Foundation Scholarship was given to Jeanne Jenkinson of Hanford, California.

## SYRACUSE MUSEUM OF FINE ARTS ANNOUNCES NATIONAL

The 16th Ceramic National to be held at the Syracuse Museum of Fine Arts, Syracuse, New York, from November 4th through December 2nd, is an open competition consisting of pottery, ceramic sculpture and enamels.

Prizes include some \$2300 and include a number of special awards in particular fields.

For the first time a special Architectural Citation will be given for the best example of the use of ceramic sculpture as an integral part of an architectural plan with the entries to consist of photographs of actual installations.

All entries must be received on September 13, 14 and 15 at the following regional centers:

The School of the Boston Museum of Fine Arts;

The Cleveland Museum of Art; The Los Angeles County Art Institute; The San Francisco Museum of Art; The University of Georgia, Athens, Ga.; the Montreal Museum of Fine Arts; and the Syracuse Museum of Fine Arts. Ceramists must send their entries to the Regional Center nearest them.

The final Jury of Selection and Awards: Viktor Schreckengost, Cleveland, Ohio, ceramist and industrial designer, Ivan Mestrovic, sculptor and Professor of Sculpture, Syracuse University; and Paul Bogatay, Columbus, Ohio, ceramist and Professor of Ceramic Art, Ohio State University.

Prize works and other selected pieces from the initial showing will be circulated as usual by the Syracuse Museum on a 14-month tour.

## CITY OF PARIS

The Rotunda Art Gallery of the City of Paris, San Francisco, under the direction of Beatrice Judd Ryan will feature the Summer Annual Print Exhibition during July.

The Exhibit consists of Serigraphs, Lithographs and Colored Etchings by a group of Eastern and Western Artists, supplemented by the work of several well known French artists.

Also on exhibition will be Decoupage Chinois, comprising chests, credenzas, taborets, cabinets and tables by Lovina.

The Pictures of the Month will feature French and American Oils and Watercolors.

Announcement is made that a special exhibition of African sculpture will be shown during August. The exhibit is being loaned to the City of Paris by the Segy Gallery.

## M. H. deYOUNG MEMORIAL MUSEUM

The M. H. deYoung Memorial Museum in Golden Gate Park, San Francisco, under the direction of Walter Heil, has scheduled a special exhibition of Italy At Work, Her Renaissance In Design Today, for the month of July.

The exhibition has been arranged by twelve American Museums with the aid of the Economic Control Administration and the Italian Government and shows the resurgence of a nation freed of dictatorship and aided by the Marshall Plan. It is comprised of some 1500 items representing the works of hundreds of designers and craftsmen and chosen by a distinguished American Jury.

The Museum also offers permanent exhibitions in the Fine and applied Arts, and a number of outstanding Historical Collections.



## NEWS AND COMMENT ON ART . . .

Among the special events offered is Painting for Pleasure, a class for adults; The Workshop, a class for the practice of observation and appreciation; and painting Classes for Children, offering drawing and painting for children.

### SAN FRANCISCO MUSEUM OF ART

The San Francisco Museum of Art, War Memorial Building, Civic Center, will offer a new exhibition entitled "A Search for Values in the Visual Arts" during July. The exhibit has been prepared by the Department of Fine Arts of the City College of San Francisco underlying the successful release of creative energy.

Other exhibitions include: Painting by Marion Massinger and Charles Tracy; "Knife, Fork, Spoon"; Arshile Gorky; Art in General Education; Picasso Lithographs; Mexican Graphic Arts; a group of 35 drawings by Seattle artists, and a number of Museum Collections.

The Hungarian String Quartet, presented in association with Mills College, will offer concerts each Tuesday evening at 8:30 p.m.

Sunday lectures are scheuled for 3:15 p.m. and will cover five subjects in the field of art. Allon Schoener, Nancy Bordewich, Barbara Fitzwilliams, and Anneliese Hoyer will lead the discussions. The Wednesday evening, 8:00 o'clock, lectures will feature Peter Macchiarini and Bill Brewer.

Dorothy Cravath will conduct the Sunday afternoon Gallery Tours which are designed to provide an introduction to current exhibitions.

The Art for the Laymen, and Children's Saturday Morning Art Classes will both be resumed in September.

### PORTLAND ART MUSEUM

Thomas C. Colt, Jr., director of the Portland Art Museum, West Park and Madison, announces the following exhibits and events for the month of July.

A special Exhibition of the work of Arnold Bank, well-known Calligrapher of New York City. Included in the exhibit are examples of design and lettering for book jackets and bindings, folders, catalogs, calendars and letterheads.

Banks is a scholar and teacher, as well as artist, and his work traces some of the historical developments in hand writing through the ages. He is an instructor in lettering and layout at the Art Students League in New York, Brooklyn Museum Art School, and Columbia University.

He will also conduct special classes in lettering at the Portland Museum during the summer.

### BENDER GRANTS-IN-AID WINNERS ARE ANNOUNCED

The Board of Trustees of the Albert M. Bender Memorial Fund have announced the 1950-51 awards to the following:

Ernest Briggs and Norman Woodbury, the Grants-in-Aid for painting; Lee Florian Gerlach and George P. Elliott, the Grants for literature; and to Charles Wong the first Grant in the field of Photography.

The Bender Grants are in the amount of \$1200 and are open to persons under thirty-five years of age who have resided in the Bay Area for at least two years, and allow the recipient to carry out projects of their own choice.

### 1951 JAMES D. PHELAN GRAPHIC ARTS AWARD

The James D. Phelan 1951 award in Graphic Arts has been given to Myoko Ito of Chicago. Second prize was awarded to Murray Justice of San Francisco. Both of these awards were in the field of lithography.

First and second prize in blockprint was awarded to John L. Horton of Chicago and Phyllis Bailey of Claremont. Jean Kellogg of Carmel was given first prize for her work in etching and engraving with second award going to Leonard Edmondson of Pasadena.

### COMPLETES TOUR OF UNIVERSITIES

Karl Kasten, artist member of the Board of Directors of the San Francisco Art Association, has just completed a month's tour as General Director of an all-university art exhibition comprised of student work from the four University of California campuses.

All phases of the visual arts were represented, painting, sculpture, graphics, architecture, city and regional planning, landscape architecture, decorative arts, ceramics, commercial design, theatre design and photography.

The exhibit remained at each university four days and was attended by over 18,000 people.

### SPOKANE PREPARES FOR NATIONAL HOME WEEK

Work has begun in Spokane, Washington, on the "Home Builders Home for 1952", for display during National Home Week, September 9 to 16.

Sponsored by the Home Builder's Association of Spokane, the design used is one which won a \$100,000 architectural contest sponsored by the National Association of Home Builders.

# TIPS ON PAINTING ON HOT SUMMER DAYS

By DR. W. SCHWEISHEIMER

## Factors That Improve Working Conditions

Factors that help men to endure high temperatures are: shade, breeze sufficient to keep the skin dry, no clothing if already shaded, acclimatization to heat, plenty of water and salt, physical fitness, and adequate sleep.

Factors known to threaten endurance are radiation, heavy or impermeable clothing, heavy work, alcohol, diarrhea or vomiting, lack of appetite for food, and wounds or infections.

In these short terms E. F. Adolph in Public Health Reports surveys the tolerance of man toward hot atmospheres. Hot, humid environment means definite disadvantages for human activities. No amount of morale can compensate for the physiological strains imposed by a hot atmosphere. Temperatures above 90° F. can rarely be endured indefinitely. During work the intolerable temperature may be as low as 80° F. or less.

## It's the Humidity

Any occupation near hot ovens or heat-radiating machines on hot days, is bound to create the hazard of heat and humidity. Whoever invented that old saying: it's not the heat, it's the humidity—meaning the cause of unpleasant feelings—knew perfectly well what he was talking about. In the removal of heat the evaporation of moisture from the skin plays an important part. The combination of high temperature and high air humidity is uncomfortable because the humidity prevents the skin evaporation as well as perspiration and does not allow the human body to release its surplus of heat through the natural ways.

Secretion of sweat is part of the heat-regulating mechanism of the body. Sweat is a weak solution of sodium chloride in water with traces of other salts. In hot climates the daily secretion may amount to 3,000 c.c. daily and in very torrid atmospheres it may be as much as ten liters. This makes imperative the drinking of an equal quantity of fluid in order to maintain the normal water content of the body and the vital "turgor" (tension) in the blood.

A painter who is working near a heat-radiating

machine but in a dry atmosphere, may still feel comfortable because he can perspire freely, and this means giving off heat freely. On the other hand, if the air of the work room is humid besides the heat, the surrounding air does not absorb the moisture his body gives off with the perspiration, he feels oppressed and near heat exhaustion.

Some workers can tolerate more heat than others. Painters who are accustomed to cool climate, suffer particularly when they are exposed to unusual heat waves or excursions to hotter climates. A New England painter needs some acclimatization before he is as efficient in the South as he was at home. It may be necessary to assign certain tasks connected with radiant heat to certain men who can tolerate heat better. Contrary to popular belief Negroes are much more susceptible to heat stroke than white people, two to six times more so. A colored painter, therefore, may suffer where a white painter gets along very well.

## Solvents in Summer

The Safety Research Institute has warned that special attention should be given to the solvent department when preparing the plant for summer temperatures. Solvents play an important part in the painting industry, there is no way of avoiding them. Since solvent volatility increases with higher temperatures, there is likely to be more solvent vapor in the workroom air during warm weather, unless sufficient ventilation is provided.

Most solvent departments are equipped with mechanical ventilation throughout the year. During the summer months, there is a tendency of employees to open windows or change the exhaust rate, to increase personal comfort, and this should not interfere with the mechanical ventilation. The opening of a window near a degreasing tank, for example, may set up a current of air which will reduce the efficiency of the exhaust and blow vapor into the workroom.

For small solvent operations it may be possible to overcome summer difficulties by providing fans in the workroom. In most cases, local exhaust ven-

(See Page 43)



One of fourteen Laboratory Buildings which comprise the Southwest Research Institute at San Antonio, Texas.

# THE CRUMBLING TRANSONIC BARRIER

By **C. DESMOND PENGELLEY**,

**Chairman, Engineering Mechanics Southwest Research Institute,  
San Antonio, Texas**

Shortly after World War II, the U. S. Air Force experimental airplane XS-1 exceeded the speed of sound. For about a year, this was denied officially but was finally confirmed as a scientific and military fact available for publication. Prior to this accomplishment, the nonscientific press and semitechnical magazines had made reference to the so-called "Transonic Barrier" which, it was presumed, would prevent supersonic flight of airplanes. Since that time, consid-



**C. DESMOND PENGELLEY**

erable mention has been made with regard to shock waves, buffeting, drag increases, and other undesirable phenomena encountered near the speed of sound. Relatively little information is available, outside of the specialized field of aerodynamics, regarding the meaning of such undefined terms. It is the purpose of this paper to present a qualitative picture of the physical significance of these phenomena.

The formal mathematics associated with high speed flight and compressible fluid flow are extremely complicated, and actual test data pertaining to full-scale controlled flight at or near the speed of sound is classified in the category of military secrets. There is, however, a considerable body of fundamental information that can be visualized readily and understood by people grounded in the basic sciences who are, however, by no

## ... TRANSONIC BARRIER

means, aeronautical specialists. A knowledge of this information permits at least a physical understanding of the problems that are encountered in transonic flight, and one can at least make intuitive guesses with regard to the problems that remain to be solved and the degree to which success may be anticipated in the immediate future.

A fundamental theorem in physics states that the speed of sound in gas is proportional to the square root of the absolute temperature. It should be pointed out, however, that sound inherently involves extremely small pressure disturbances within a gas. Provided that these disturbances are small, the velocity is constant at any given temperatures. Extremely large disturbances, such as those associated with shock waves sent out by an exploding bomb, travel at a speed considerably in excess of that of sound. Nevertheless, the speed of sound is an extremely important quantity to which reference must frequently be made in high speed aerodynamics. In speaking of high speed flight, it is customary to take the point of view of the pilot and consider only the relative velocity of the air flowing past the airplane which is then expressed as a ratio of the speed of sound. This quantity is known as the Mach number. The symbol  $M$  is used to define this nondimensional ratio. It may be noted for reference that the speed of sound in air at  $60^{\circ}$  F. is approximately 760 miles/hour.

From the foregoing, it may be seen that when  $M=1$  the flow is at the speed of sound. When  $M$  is less than 1, the velocity is said to be subsonic. When  $M$  is greater than 1, it is described as supersonic. When the velocity is very much less than the speed of sound, that is,  $M$  is less than .2, the flow is said to be incompressible; and in actual practice, under these circumstances, a gas flowing around a body such as the wing of an airplane acts, for practical purposes, in just the same manner as though it were an incompressible fluid such as water. At very low speeds where incompressible flow may be assumed, certain fundamental aerodynamic characteristics are present which may be described in a fairly simple manner and which were understood by the Wright Brothers. One of these is the fact that the force exerted on any rigid body by an incompressible fluid is directly proportional to the square of the velocity. It is thus possible to establish a force coefficient for any chosen body which is independent of speed. In addition, it may be found that for a body of a given shape where the over-all size may be changed but the proportions remain fixed that the total force is also proportional to the air density and the projected area of the body. This law has

been set forth in Reference (1) and may be represented by the following basic equation:

$$\text{Force} = (C_F/2) (\text{Density}) (\text{Area}) (\text{Velocity})^2 \quad (1)$$

The factor of  $1/2$  has been introduced into the above equation simply because it is conventional and it is of no actual physical significance. As stated above, provided the fluid is incompressible, the force coefficient,  $C_F$ , is independent of speed. Therefore, equation (1) may be used to compute the force on a body of a given shape but of any size in a gas of any density and at any incompressible velocity provided the force coefficient,  $C_F$ , has been determined by a single test under one chosen set of conditions.

As the speed increases, however, and approaches the speed of sound, it is found that the force coefficient changes noticeably. Up to a Mach number of .6 or .8, this rise is usually found to be quite uniform and consistent. Depending upon the actual air flow, however, there comes a time when the curve becomes irregular and the flow very unsteady. As the Mach number changes by very small amounts, the force may rise and fall; and in fact, at one given speed, rapid fluctuations may be encountered causing what is known as compressibility buffet. The irregular forces encountered under these circumstances are frequently so severe as to cause structural damage.

If it is possible, by any means, to increase the speed beyond the speed of sound and still save the wing from destruction, it will be found that by the time a Mach number of about 1.2 has been reached the flow will again be quite stable and a steady force will again be encountered.

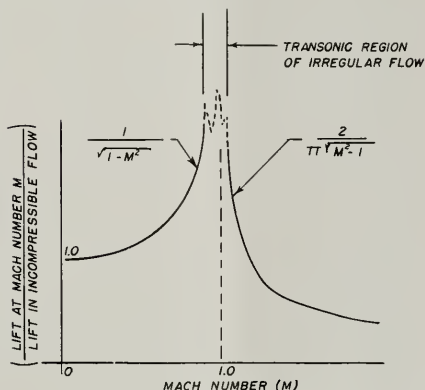

FIG 1  
EFFECT OF MACH NUMBER UPON LIFT COEFFICIENT



## TRANSONIC BARRIER . . .

The phenomena described above have been illustrated graphically in Figure 1, reference having been made to the "Life Coefficient,"  $C_L$ , on a wing, which is merely the component of the force coefficient measured perpendicular to the air stream. The algebraic expression shown in Figure 1 may readily be derived from the equations on pages 150 and 153 of Reference (2) and page 38 of Reference (1).

The uniform variations in lift coefficient at both subsonic and supersonic speeds have caused little difficulty in aircraft design. The catastrophic irregularities, however, encountered near the speed of sound—that is, between Mach numbers of about .8 and 1.2—present such tremendous problems that this speed range has popularly been termed the "Transonic Barrier." As of today, no reliable working theory exists which is capable of predicting the forces that may be produced on an airplane flying in this region. Very complicated testing procedures are needed for measuring these forces. Experience has made it possible to extrapolate design procedures which have been successfully used at lower speeds so that the velocity at which transonic phenomena first appear may be pushed to higher and higher values of Mach number. Beyond this, however, it has been essential to use a lot of common sense and faith; and as a result of so doing, several airplanes have actually succeeded in exceeding the speed of sound successfully.

The primary reason for the irregularities encountered in the transonic region is the formation of "Normal Shock Waves." A qualitative understanding of shock waves is quite possible. A theoretical method is available which is capable of predicting their characteristics in certain forms of simple flow such as a one-dimensional pipe. However, when it comes to complex three-dimensional problems involving airplane wings and fuselages, no such theory has ever been completely developed.

In order to understand what a shock wave is and to be able to visualize how and why it may occur, it is essential to discuss one-dimensional flow in a simple closed channel. Figure 2 shows diagrammatically a section through such a pipe. At low speeds where compressibility is negligible, the flow in such a convergent-divergent channel is quite straightforward and, of course, results in the well known principles of the Venturi. Under such conditions, since the rate of mass flow is the same at all points along the tube, it is evident that the velocity must be inversely proportional to the cross sectional area. Thus, the maximum velocity occurs at the throat where the cross sectional area is minimum. As the ratio of inlet to exit pressure is

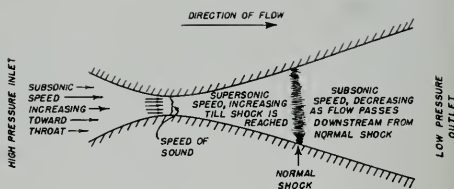

FIG 2  
COMPRESSIBLE FLOW IN A CLOSED PIPE

increased, however, it will be found that the velocity in the throat increases up to a critical value. This critical value is the speed of sound in the gas. Additional increases in the pressure ratio will not produce velocities in the throat which exceed the speed of sound, but the gas will continue to accelerate in the divergent downstream part of the channel, and supersonic velocities will be encountered in the region shown. These phenomena are well known to mechanical engineers, and the principles are used in the design of the Laval nozzle. In many cases, the nozzle has an open end, and gas emits at supersonic velocities, little thought being given to the physical process through which its pressure is raised and it is brought back to subsonic speeds.

In a case where the pipe continues, a very important and not so widely known phenomenon is encountered. This is the presence of a normal shock. For any given set of conditions, it is quite obvious that a finite rate of mass flow must pass through the throat. Imagine a condition where the speed of sound has been achieved in the throat, and supersonic speeds have been obtained downstream. It must be noted that under these circumstances the density of the gas decreases as it moves downstream and its velocity increases, thus maintaining a constant mass flow through a divergent nozzle. By comparison with a simple incompressible Venturi tube, it would be quite possible for the same mass flow to take place if the density were to remain constant or increase and the velocity decrease as the size of the channel increased. Thus, there is intuitively at least one other inherently different way in which the gas may act while it is flowing through a divergent nozzle. Both of these types of flow are physically possible with a compressible fluid. In addition, it takes only some relatively small freak of nature to determine which type of flow will take place in any given circumstance. Ordinarily, it will be found that the flow

## ... TRANSONIC BARRIER

changes suddenly from one type to the other. The one is always supersonic; the other is always subsonic. Neglecting the effects of viscosity and assuming a perfect gas, there are absolutely no intermediate possibilities; and when the flow changes, it does so catastrophically in an infinitely small time. In actual practice due to viscosity and other deviations from a perfect gas, this change may actually take place over an axial distance of a fraction of an inch when the air is flowing at a supersonic velocity in the order of magnitude of a thousand or more miles per hour. This indicates how very nearly exact it is to say that the change takes place instantaneously, and it can readily be seen why the phenomenon is called a shock. Unfortunately, however, the axial position in the pipe at which this phenomenon takes place is by no means stable, and this diaphragm or filament which represents the sudden transition from super to subsonic flow may oscillate up and downstream many feet at a very high and irregular frequency. In addition to the instability of the position in the stream where the shock is located, a great deal of turbulence is likely to be encountered in the subsonic region downstream from the normal shock.

It is very difficult to visualize intuitively the physical possibility of the shock described above. Any scientist or engineer who has engrained in his system an underlying respect for mass and inertia and the necessity for gradual changes in velocity inherently finds something of this nature almost impossible to believe. Nevertheless, it is a very firmly established phenomenon which may be measured and observed in many different ways. It may be measured accurately by means of static pressure orifices in the walls of the pipe, and it may be observed visually by means of various optical systems such as the Schlieren method, the interferometer, and the shadowgraph. An equally peculiar and almost identically analogous phenomenon occurs in the flow of water in an open channel. This may be readily observed even under the kitchen faucet. It is illustrated in Figure 3. It is essential that a smooth streamlined flow be achieved from the faucet. This can normally be managed by merely placing a fine wire screen under the faucet. If the stream of water is then allowed to impinge on a flat surface such as the bottom of the sink, it will be observed that it moves out radially in a very thin high velocity layer shown in cross section in Figure 3 where an analogy to supersonic flow is indicated. A very clear shock may be observed a few inches out radially from where the stream first strikes the bottom of the sink. The water will actually build up in a ring around the faucet

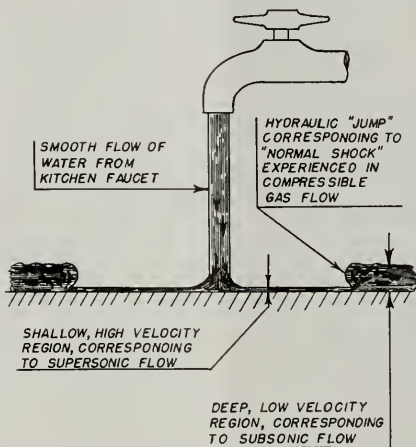

FIG. 3

ILLUSTRATION OF ANALOGY BETWEEN LIQUID FLOW WITH OPEN SURFACE, AND COMPRESSIBLE GAS FLOW IN CLOSED CHANNEL.

many times the thickness of the so-called supersonic layer. The actual radial velocity of the water in the analogous subsonic layer is only a small fraction of that encountered in the supersonic layer. It should be noted that the water actually flows from a position of low static head to a position of high static head. Needless to say, there is a transfer from kinetic to potential energy, but it actually looks as though the water is flowing uphill. The low velocity deep water which occurs after the shock is equivalent to the low velocity, high density air encountered in the closed channel. This water analogy is actually very closely related to the normal shock encountered when gas flows through a diverging nozzle. At any rate, it provides a very simple means of illustrating the phenomenon which when first encountered appears to be inconsistent with most experience.

It is now possible to discuss the formation of shock waves on an airplane wing as it approaches the speed of sound. Figure 4 shows a typical section of a wing with streamlines flowing around it. It should be noted that the streamlines are imaginary filaments indicating the direction of resultant flow at all points in the fluid. No flow of fluid occurs across a streamline, and adjacent streamlines form boundaries for imaginary tubes, through each of

# TRANSONIC BARRIER . . .

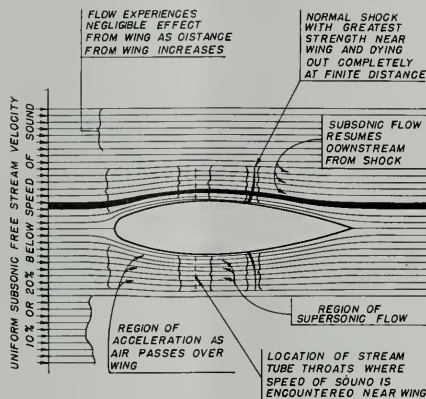

FIG. 4  
FLOW OVER WING AT HIGH SUBSONIC SPEED SHOWING LOCAL REGION OF SUPERSONIC FLOW AND FORMATION OF NORMAL SHOCK

which the mass flow is uniform. If a particle of dust should be located on a certain streamline before the air passes over the wing, it will remain on that streamline as it goes around the wing. In order then to illustrate clearly what happens to the air as it passes over the wing, one of the stream tubes between a pair of streamlines has been shaded in close to the upper surface of the wing. A little study of Figure 4 will readily show that this tube forms an imaginary convergent-divergent nozzle very similar to the real one shown in Figure 2. It may be expected that the air will exhibit exactly the same characteristics under these circumstances as it did when it was flowing in an actual channel. Thus, it tends to accelerate as it starts to come up over the wing and reaches a maximum velocity in the throat where the cross sectional area is minimum. Provided that the speed in the throat is subsonic, the air then proceeds to slow down as it goes through the diverging portion of the stream tube. As the airplane speed increases, however, there comes a time when the speed of sound is actually attained in the minimum section of the stream tube; and at all higher speeds, a region of supersonic flow followed by a normal shock may be expected to occur downstream from the throat.

It should be noted that the ratio of throat size to free tube size is a minimum near the wing and becomes greater, approaching unity, as the distance from the surface of the wing increases. Thus, as the

free stream velocity increases from a very low value, the speed of sound will be first encountered in a stream tube close to the wing; however as the speed still further increases, the speed of sound will be encountered at distances further and further removed from the wing. As already indicated, supersonic velocities will occur downstream, and a normal shock will be encountered in each stream tube that has achieved the speed of sound at its minimum cross section. This normal shock will tend to be the strongest close to the wing and will die out completely when it gets out to the stream tubes which do not have the speed of sound occurring in their throats. This normal shock is shown in Figure 4. It must be remembered that the location of a normal shock is not usually stable. As the flow passes the position of the normal shock, the velocity changes suddenly from supersonic to a subsonic value. There is a corresponding abrupt change in pressure. The position at which the shock occurs may oscillate erratically up and downstream. As it does so, the surface of the wing will feel rapidly fluctuating pressures. These not only have a severe effect upon the lift characteristics of the wing but also cause severe structural forces; and in addition, considerable turbulence is encountered downstream from the shock. It is the erratic behavior of these shock waves that cause serious difficulty in transonic flight.

To the knowledge of the writer, there is no practical theory available at the present time to analyze transonic flow characteristics on an actual airplane or missile; however, two design devices may be used to reduce greatly the severity of the transonic phenomena or to postpone their onset until higher speeds have been reached. One of these involves the use of very thin wings. By reference to Figure 4, it can readily be seen that the convergence and divergence of the stream tubes are inherently a function of the wing thickness and curvature. Reduction in wing thickness, therefore, inherently reduces the tendency for shock waves to form. Another method of achieving somewhat the same results is to provide sweepback.

The exact mathematical theory pertaining to the characteristics of sweepback wings is extremely involved, but there is a very simple straightforward way of at least qualitatively visualizing the important effect of sweepback. Figure 5A illustrates a section taken out of a wing subjected to an air speed of velocity  $v$ . Let it be assumed that the velocity  $v$  is such that no shock waves form on the wing. Now imagine that the wing is moved spanwise with the velocity  $u$ . Provided that the wing sections are all constant and the wing is of great

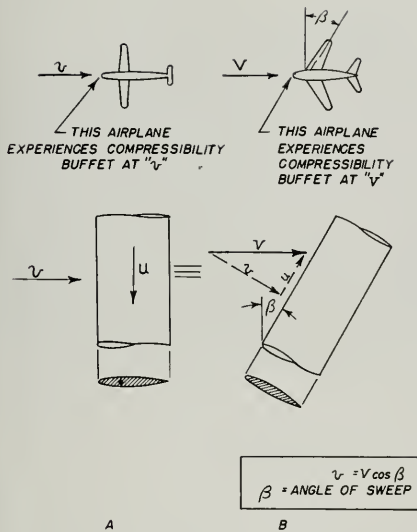

FIG. 5  
 DIAGRAM ILLUSTRATING EFFECT OF SWEEP

length, that is to say, two-dimensional, it may be stated intuitively that the spanwise velocity  $u$  will not have an appreciable effect upon the flow characteristics. In fact, if the wing is perfectly smooth and there is no viscosity in the air, it may be assumed that this spanwise component of velocity will have no effect whatever upon the aerodynamic characteristics due to the normal velocity  $v$ . The resultant velocity, however, that the wing actually encounters is shown in Figure 5B, and this is a velocity vector  $V$  inclined at an angle to the leading edge and, of course, equal to the vector sum of  $u$  and  $v$ . This system may also be considered in reverse. That is to say, when the result-

**PRESIDENT TRUMAN MAY VISIT TRACY PROJECT**

Persistent rumor has it that President Truman will attend dedication ceremonies at the Tracy Pumping Plant on Augusts 3, 4 and 5, which signalizes completion of another portion of the vast Central Valley Reclamation Project.

In addition to the President, dozens of other high federal, state and local dignitaries will be on hand for the festivities. These will include Secretary of the Interior Oscar Chapman, Governor Earl Warren of California, Members of Congress, Commis-

sioner of Reclamation Michael W. Straus, L. M. McClellan, chief engineer of the Bureau of Reclamation, John L. Savage, who designed many of the physical features of the project, Richard L. Boke, regional director for Reclamation, Tully C. Knowles, chancellor of the College of the Pacific, Bruce Hotchkiss and R. J. Marraccini, co-chairman of the Tracy committee, and a host of others.

ant air  $V$  is inclined to the leading edge of the wing, then aerodynamic compressibility characteristics are a function only of the component normal to the leading edge; namely,  $v$ . Thus, if  $v$  is the maximum velocity that can be attained without shock waves forming, then if the wing is swept so that the leading edge encounters the air coming at an angle, it is possible for the airplane to fly at a higher velocity, namely,  $V$ , before shock waves will be encountered.

Sweepback does not in any way appreciably change the character of the shock waves, but it does postpone their onset to a considerably higher speed. It is, in fact, possible for a sweptback wing to operate at a supersonic speed and yet aerodynamically act as a straight wing would at subsonic speeds. The simple, physical explanation just given is thoroughly justified only for a two-dimensional wing of infinite span and absolutely constant cross section acting in a nonviscous fluid. Fortunately, however, the qualitative characteristics still occur even for actual wings of finite span and nonconstant section, and this accounts for the sweptback designs that appeared since World War II.

Only the most fundamental transonic phenomena have been discussed, but it is believed that the most serious difficulties in transonic flight stem directly or indirectly from normal shocks; if these can be controlled and predicted, most other problems will probably be resolved accordingly. It may safely be assumed that flight at the speed of sound will become more or less commonplace in years to come. It is probable, however, that it will always be more difficult to maintain stability and control in the transonic region than at Mach numbers well removed from 1.

REFERENCES:  
 (1) Millikan, Clark B., *Aerodynamics of the Airplane*. (John Wiley & Sons, Inc., 1941.)  
 (2) Liepmann, Hans Wolfgang, and Allen E. Puckett, *Introduction to Aerodynamics of a Compressible Fluid*. (John Wiley & Sons, Inc., 1947.)

ARCHITECT MOVES OFFICES

The architectural offices of Franklin Everett have been moved from Ventura, California, to 1979 Palmetton Place, Los Angeles.





Front and side elevation of delightfully informal new Industrial Branch  
of the First National Bank of Portland, Oregon.

# INFORMALITY MARKS CHARM OF NEW INDUSTRIAL BRANCH BANK DESIGN

Portland, Oregon

By **ARTHUR W. PRIAULX**

ARCHITECT: MORTON H. CAINE, A.I.A.

CONTRACTOR: AL TELLER CONSTRUCTION CO.

LANDSCAPE ARCHITECT: ARTHUR ERFELDT

When you build a branch bank in the heart of a city's industrial district make the building fit the needs of the customers and design it so that it belongs to the district.

Morton H. Caine, one of Portland's younger and

more imaginative architects, achieved both objectives in the newly completed Industrial Branch of the First National Bank.

In the center of industrial Portland, the building has charm and informality which makes it stand

## . . . INDUSTRIAL BRANCH BANK

out among factories, warehouses and industrial structures, but is still gives the feeling of belonging to the neighborhood.

The Industrial Branch has been so designed as to make banking quick and easy. A large parking area, occupying a full block, excepting for the ground covered by the bank, provides customers with free parking. To the customer who is really in a hurry, two drive-in windows are provided so that banking business can be carried on right from a customer's car. For conventional banking customers, two large and easy double-door entrances of full-length glass off the street and off the parking lot enable customers to step from their cars into the bank.

Not only has Caine achieved an informality unusual in banking establishments, but he has also given the building an aura of friendliness where a customer can feel at ease. A lounge, furnished with leather-covered chairs and davenport just inside the street entrance gives an almost country-club atmosphere.

The \$135,000 structure is built largely of reinforced concrete and steel, while the exterior features a pink Roman brick in combination with tempered plate glass doors, aluminum trim, part Redwood siding and copper gutters. The combination of glass, wood, brick and metal has been cleverly

blended to create a pleasant illusion of part home, part commercial structure.

Inside the spacious lobby Caine has introduced delightful variety in his design. One wall is Roman brick, one a plaster wall painted in pastel colors, one wall in vertical grain West Coast hemlock wainscot in natural finish with plaster above and the fourth wall behind the tellers' cages is plaster, topped by large second-story level plate glass windows offset above the counter line in a clerestory lighting arrangement to give true north light.

The entire ceiling is perforated acoustical tile, while lighting is incandescent, recessed lens type in the main lobby and recessed fluorescent in the work areas and conference room. The floor covering is a light tan asphalt tile laid on a concrete slab floor. Fixtures are specially designed, made up of limed rift oak with special top. The building is heated by steam furnished through baseboard panels augmented by a ventilation system.

Roof is a built-up paper and tar type. A partial cement basement contains storage vault, transformer room and heating plant for the building.

One of the unique features of this newest, and 64th branch of the First National Bank chain, is the novelty of the two drive-in banking windows. The tellers' cages for the drive-in trade are fool-proof and robber-proof. The teller is protected at all times

**This view shows the novel "drive-in" banking windows and the exit driveway from the large banking and bank-park area.**





Full interior view from street entrance of banking and lobby space showing clerestory lighting (left above) and soft effect from limed oak fixtures with West Coast hemlock wainscotting.

View of bank interior from parking space entrance. Lounge is in rear beyond tellers' cages. Recess lighting and other features are shown in this illustration.

(All photos by Ackroyd Photography, Inc.)



**CONFERENCE ROOMS**

Have warmth and friendliness of a cosy den at home, are also finished in attractive West Coast hemlock paneling.



and there is never a clear opening between the teller and the customer. Inch-thick plate glass, tempered and bullet proof, protects the teller above the counter line and armor plate steel shields the bank employee below the counter line. Caine has designed these cages so that the customer can get

fast service and so that the employee is protected at all times from any holdup attempts.

An interesting feature about the high clerestory lighting installation is that glare has been almost completely eliminated in the banking rooms.

(See Page 38)

**Officers have plenty of conference and work space in an atmosphere relaxed by the use of proper balance between paneling and masonry.**







Student body and teaching staff of unique California Elementary School District.

# A DREAM IN THE DESERT

# New Elementary School

McKITTRICK, CALIFORNIA

BUILDING COST PER STUDENT — \$4,000

WRIGHT, METCALF AND PARSONS

ARCHITECTS

The town of McKittrick in Western Kern county, which can boast of more oil wells than residents in the community, has completed what is probably one of the most unusual elementary school buildings in the United States.

Each school day of the year, a district bus picks up the entire student body of some sixty-five youngsters from the far reaches of the 180 square mile

district, and takes them to their new dream school—a \$260,000 strictly modern building that stands as a distinct contrast to the surrounding clusters of oil derricks.

Yet it is to these same oil derricks that the children, teachers and school board owe the reality of their new school building, for each of the producing oil wells in the district pays a substantial

## . . . DREAM SCHOOL

amount annually in local, state and national taxes.

With the reasonable assurance of a continuing income from these taxes the school district of only 300 people was able to plan and build a new school with an auditorium and a cafeteria, teachers' lounge, six large classrooms, and included in the furnishings is some \$28,000 worth of single unit, all year air conditioning equipment. Homes for the school principal and teaching staff were also included in the project.

The most remarkable feature of the project, however, is that the total investment of more than a quarter of a million dollars will be completely paid off in five years.

The principal of the school, Frederick Ammann, a young progressive educator, and the three-man school board justified the unusual project on several grounds and completely satisfied the first adverse reaction of some of the money-minded taxpayers to the plan.

For one thing, they pointed out, the old school building built in 1900 was inadequate and unsafe, and in this arid area of Kern county, where sum-

mer temperatures frequently hit 115 degrees and winter cold gets as low as zero, the old frame building discouraged teachers and hampered the normal processes of education. Its forbidding appearance made it almost impossible to attract teachers to McKittrick.

Too, McKittrick has long been considered the logical point for location of the surrounding region's combined school districts. When that happens, the new school could easily be expanded to take care of the additional students.

McKittrick is a typical upper San Joaquin Valley oil producing community. At the turn of the century it was a thriving center of between 15,000 and 20,000 people, while today its population has decreased to less than 400 persons. The town has twice burned down, and its people have migrated slowly to other more favorable living and working areas. Not only is the climate hot in the summer and cold in winter, but there are no trees, no streams, no lakes, and few places for recreation.

"The new school has become our weather proof meeting place," points out Ammann. "It is our

(See Page 24)

Cleanly Designed Classroom

Photo's by Servel, Inc.





Lath house for professional growers.

(Photo by Aluminex, Inc.)

Something New Under The Sun

## AN ALUMINUM LATH HOUSE

For the Amateur and Professional Floriculturist

BEVERLY HILLS, CALIFORNIA

Aluminum lath houses, with the added feature of an adjustable, movable, secondary roof for complete shade-rain-sun control, is the latest development on the West Coast to answer Mark Twain's old cliché, "Everyone talks about the weather but no one does a thing about it."

These newly developed units incorporate a specially fabricated aluminum lath of superior strength and major installations have already been made at the University of California, Berkeley; the Rancho Santa Ana Botanical Gardens, Claremont; the UCLA Horticultural Division, Los Angeles; the

Desert Botanical Gardens—Papago Park, Tempe, Arizona; the Huntington Memorial Gardens at San Marino; and the California State Hospital at Spadra.

Of particular interest to professional growers in their study of the performance of the aluminum lath house is the drip-proof and water-control features that eliminate entirely the "wash-out" bugaboo of the old style conventional lath house. Developments of the movable secondary roof also provided complete weather control, making it possible to completely ward off heavy rainfall, and to



## . . . ALUMINUM LATH HOUSE

control the amount of sun and shade entering the enclosed space by merely moving the adjustable roof from an all-open to a completely closed interlapped lath position.

Control of the roof is accomplished by a manual chain and sprocket controls which allow for adjustment of different panels of the roof structure to any degree of sun-rain or shade desired and thereby provide a flexibility of growth control not previously achieved.

Of equal importance is the complete freedom of maintenance and repair, which actually makes the aluminum lath house less expensive than the conventional type units. The patented aluminum lath are corrosion proof and are completely unaffected by even the salt air pitting usually associated with metal installations along the coastal seaboard areas. Lattice type, light steel columns and braces provide a ruggedness that, in the case of Papago Park installation, withstood extremely high wind conditions approaching hurricane intensities. This gale did not affect the large unit

which had been installed there in any single respect.

Additional shade area is provided in view of the fact that the sidewall panels are hinged at the top and can be raised at will. This also permits easy movement of large units in and out of buildings. Potting tables, cultivators, trucks, and other gardening equipment can be moved through any of the sides without difficulty. Three foot, six inch wide doors are provided at any location in the structure for normal use.

Erection is also simple and actually provides portability, with units for amateur flower growers being available in small sizes, while larger units are available in desired sizes. Some installations have been made for use as car ports, cabanas, patio shades as well as floriculture lath houses.

Based upon the experience of this type of lath houses, many units are now being produced for home owners and amateur flower hobbyists, as well as for a number of Agricultural District Fairs and County Fairs throughout California.

**Interior view of typical installation of new innovation in lath houses using aluminum lath and structural steel frame. Note free expanse of floor area, limited pole supports, shade patterns and general maintenance free construction. Adjustable secondary roof provides complete sun-rain control.**

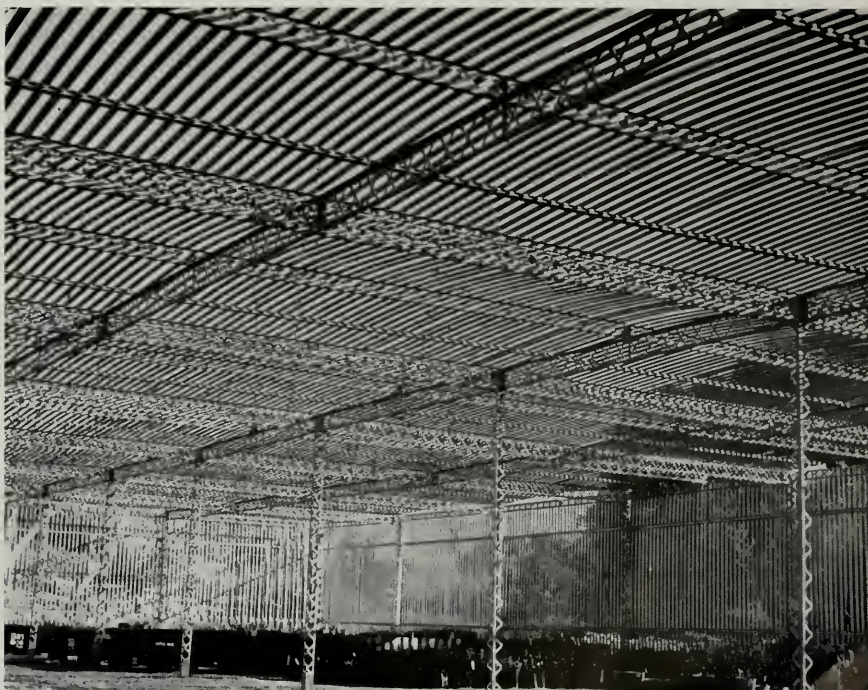



## McKITTRICK DREAM SCHOOL NATION'S MOST UNUSUAL

(From Page 21)

movie hall, our dance hall, our banquet hall, our entertainment center, and our community building. But, best of all, it is a fine place to teach our children."

The principal and his three man board of education spared little in planning their building with the architectural firm of Wright, Metcalf and Parsons of nearby Bakersfield.

The board, for example, justified the installation of the strictly modern year-round heating and cooling and air conditioning equipment on the basis of community liveability. With the range of temperatures, zero to 115 degrees, they knew the very best air conditioning was a necessity.

After more than a year of careful planning and investigating, the board and the architects approved a plan and construction was started.

The completed school building comprises the square type classrooms, with large windows to the north. Built-in cabinets contain space for students' wraps; there are private closets for the teachers'; storage space has been provided for various school room supplies, and there is a sink with a small work table. Artificial light is provided by four 1,000-watt concentric ring fixtures, which give a good indirect light for dull days. All of the rooms are painted in a pale green.

The kindergarten has special toilet facilities, sink and work space, and counter along the north window. An ample play porch is located at the east end of the main room. Floors are laid out in play circles and squares, with cheerful insets of clowns, ducks, rabbits and other animals in the asphalt tile.

The auditorium has a modern stage and three dressing rooms. Entrances to the stage are provided from the rear so that large groups can be assembled in the adjoining classrooms and brought onstage without going through the audience.

Hot lunches for the children are prepared in the kitchen and served in the lunchroom which is adjacent to the auditorium.

Administrative units consist of an office for a teaching principal which connects directly to a classroom. A nurse's room is located just off the principal's office.

A teachers' lounge is provided with a small adjacent kitchen.

The entire building forms an inner court, which can be used on spring and summer evenings to

seat approximately 600 people in an open air theatre that is protected from the prevailing wind. The floor of the building is concrete, covered with asphalt tile. The ceilings are finished in acoustic tile. The roofing material has been selected to meet the varying climatic conditions and consists of a durable white asbestos shingle. The doors are finished in a flush birch and have been left natural in color and are unvarnished.

In addition to the actual structure, the board of education is building residences for the principal and the teaching staff. These homes are rent free as long as the teachers remain employed by the district and to the uncomplaining townsfolk, principal Ammann justifies the expenditures on the grounds that a more or less remote district such as McKittrick must provide additional incentive if it is to attract and retain competent teachers. It is inconsistent, he feels, to go to the trouble and expense of building a beautiful school building and then not follow through and get a good teaching staff.

Already, this planning is paying dividends. The board had no trouble in engaging a young teacher for the kindergarten. They were able to offer such undeniable attractions as a home of her own, a good salary, a splendid new school plant, and a reasonably small group of children to work with—to say nothing of the obviously implied support of a progressive principal in local education program and community activities.

Credit for the realization of the new dream school at McKittrick belongs to the entire community—to the members of the board of education who have the welfare and the future of the district's children deeply rooted in their thinking, and to Principal Ammann, a young man who left the comfortable promise of a large community school to direct the destinies of one of the more remote school districts in California, and to the people of the district who wholeheartedly approve and cooperate in the program.

Certain it is, that completion of the nation's richest-per-pupil school is conclusive proof of what can happen when far sighted community planning and modern education trends meet—particularly in a township populated principally by oil wells.

### NEW AIRCRAFT BUILDING

Construction is well under way on the new \$2,000,000 Lockheed Aircraft Corp. building at Burbank. The five story reinforced concrete flat slab building will contain 165,000 square feet when completed and will provide accommodations for 1500 administrative and engineering personnel.

Welton Becket and Associates are the architects.

## MODULAR METHOD IN HOME BUILDING GETS APPROVAL

Use of "modular coordination" by architects to reduce home construction costs and save materials is being supported by the Housing and Home Finance Agency of the U. S. Government, as the result of a recent survey conducted by the Housing Research Division of the agency.

Modular coordination is described in a booklet issued by the agency "as the standardization of building materials and plans on a uniform basis of measurement, or module" and is designed to eliminate waste caused by cutting and fitting at the building site.

Substantial economies in home building can be

achieved by cooperative effort of materials and equipment producers, architects, and builders, and according to Raymond M. Foley, agency administrator, "Three kinds of related activities are involved in modular coordination, 1) design and production of building parts in sizes established on a uniform system dimensions, 2) use of modular specifications for determining product sizes and fitting the uniform-sized parts into building structures, and 3) preparation of architectural drawings for building according to the same dimensional system.

IN terms of goods produced and marketed and services rendered, 1950 was the most productive in California's history.



Photo by Architectural Division, Porcelain Enamel Publicity Bureau.

A recent remodeling of the corner exterior surface of the ground floor portion of the Latham Square Building in Oakland, California by Ponsford & Price, Architects and Burke & Kober, industrial designers, presented a number of intricate problems to the owners of the property and the contractor.

Being one of the larger office buildings in downtown Oakland, it was essential to make the improvements with a minimum of inconvenience to the general public and to the national clothing firm which occupied the store space.

Another factor which had to be taken into consideration, was the property-line measurement

limitations which permitted only 1½" of space for surfacing.

To meet the physical requirements of our building, and because of an adequate supply of material which could be quickly and economically applied, and thereby reduce to a bare minimum the inconvenience caused building tenants and the public at large, we selected Porcelain Enamel Veneer, pointed out the Architects. The net result was an architecturally attractive store front, with modern merchandise display windows and a considerable improvement to the general appearance of the building.

# American Institute



# of Architects

Glenn Stanton, President  
Kenneth E. Wischmeyer, 1st Vice-president  
Norman J. Schlossman, 2nd Vice-president  
Clair W. Ditchy, Secretary  
Maurice J. Sullivan, Treasurer

Arizona Chapter:  
Edward L. Varney, President; Ralph B. Haver, Secretary,  
P. O. Box 786, Phoenix, Arizona.  
Central Valley of California:  
William Koblik, President; Gordon Stafford, Vice-President;  
John W. Bomberger, Secretary; Albert B. Thomas, Treasurer,  
Secretary's Offices P. O. Box 1943, Modesto.  
Coast Valleys Chapter:  
William F. Hempel, President; Lawrence Gentry, Vice-  
President; Walter Stromquist, Secretary-Treasurer. Secretary's  
office, 321 Channing Ave., Palo Alto.  
Colorado Chapter:  
Paul Atchison, President; James M. Hunter, Vice-President;  
Dudley T. Smith, Secretary; Victor Hornbein, Treasurer. Offices  
1254 Monaco Parkway, Denver.

National Headquarters —  
1741 New York Avenue, N. W.  
Washington 6, D. C.  
Edmund R. Purves  
Executive Secretary

Northern California Chapter:  
Francis J. McCarthy, President; Albert R. Williams, Vice-  
President; Wendell R. Spackman, Secretary; Helen D.  
Franch, Treasurer. Offices 369 Pine Street, San Francisco.  
Oregon Chapter:  
Herman Brookman, President; Donald J. Stewart, Vice-  
President; Raymond Kermit Thompson, Secretary; Millard  
H. Schmeier, Jr., Treasurer. Secretary's office 429 S. W. 4th  
Avenue, Portland.  
Pasadena Chapter (California):  
Culver Heaton, President; Don Neptune, Vice President;  
Arthur Frick, Treasurer; (Mrs.) Dorothy Gray, Secretary,  
Directors, John N. Douglas, Boyd Georgi, Roland E. Coate  
and Burton Romberger. Office 1041 East Green St., Pasadena.

## TEXAS ARCHITECTURAL FIRM WINS A.I.A. MERIT AWARD

The architectural firm of Stone and Pitts of Houston, Texas, were awarded the top honors in the industrial field award of The American Institute of Architects for their design of a soft drink bottling plant.

The building was cited for its design which aided efficient production, and its appearance combined good merchandising and strong community relations.

An electronics plant at San Carlos, California, designed by Francis J. McCarthy, San Francisco architect, received an award of merit in the industrial division.

In the house design division awards were given to architects Anshen and Allen, San Francisco; Bowman and York, San Antonio; Maynard Lyndon, Los Angeles; Richard J. Neutra, Los Angeles, Raphael S. Soriano, Los Angeles; and Wurster, Bernardi and Emmons of San Francisco.

In the hospital division merit awards were given architects George B. Allison and Ulysses and Floyd Rible of Los Angeles for their Goodyear Memorial Pavilion, Ventura, California; and Golemon and Rolfe, Houston, Texas for their St. Francis Cabrini Hospital in Alexandria, La.

Remember it's

**KRAFTILE**

for **GLAZED STRUCTURAL WALL UNITS**  
**PATIO TILE**  
**SWIMMING POOL OVERFLOW**  
**GUTTER**  
**QUARRY TILE**  
**FACE AND ROMAN BRICK**  
**ACID BRICK**  
**BRICKETTES**  
**MINWAX TILE & CONCRETE**  
**FLOOR FINISH**  
**STRAN-STEEL FRAMING**  
**QUONSET BUILDINGS**

For complete information and prompt service, phone or write

**KRAFTILE COMPANY**

HILES, CALIFORNIA

HILES 3611

SAN FRANCISCO 5: 50 Hawthorne St.—DUgias 2-3780

LOS ANGELES 13: 306 South Main Street—MILual 7241

## SOUTHERN CALIFORNIA CHAPTER

The regular July meeting was held in the Mona Lisa Restaurant with the program being devoted to a report by Architect Robert Alexander of his recent trip to India where he had been commissioned by the United Nations and the Indian Government to prepare complete plans for the town and country living of the inhabitants of a 37,000 acre site.

Alexander supplemented his remarks with a number of very interesting colored slides.

## ARCHITECT'S MODERN RANCH HOME PART OF VALLEY EXHIBIT

The modern ranch type home of Architect Edwin R. Cleveland in Hidden Hills, a new community being developed north of Ventura Blvd. and directly west of Topanga Canyon Blvd. in the Calabassas region of the San Fernando Valley, will be one of the outstanding attractions of the region.

The Cleveland ranch home will occupy an acre-plus site, providing 1600 square feet of living

**East Bay Chapter:**

Harry A. Bruno, President; Chester H. Treichel, Vice-President; Ira D. Beale, Secretary; Cecil S. Meyer, Treasurer. Secretary's office, 1444 Webster St., Oakland.

**Montana Chapter:**

E. Edward Sowercraft, President (Billings); I. Van Teylingen, Vice-President (Great Falls); H. C. Cheever, Secretary-Treasurer. Secretary office, Bozeman.

**Nevada Chapter:**

George L. F. O'Brien, President; Aloysius McDonald, Vice-President; Graham Erskine, Secretary; Edward S. Parsons, Treasurer. Offices 160 Chestnut St., Reno.

**Nevada State Board of Architects:**

L. A. Ferris, President; Reno; Walter Zick, Secretary, Las Vegas; Directors: Aloysius McDonald, Las Vegas; Russell Mills and Edward Carson, Reno. Office, P. O. Box 2107, Las Vegas, Nevada.

**Pasadena Chapter:**

Culver Heaton, President; Don Neptune, Vice-President; Arthur Frick, Treasurer; Mrs. Dorothy Gray, Secretary. Directors John N. Douglas, Boyd George, Roland E. Coate, and Burton Romberg. Offices 1041 E. Green St., Pasadena 1.

**San Bruno Chapter:**

Jack R. Lewis, President; Louis A. Dean, Vice-President; Donald Campbell, Secretary; Victor L. Wullt, Jr., Treasurer. Directors C. J. Paderewski, G. C. Hatch. Secretary office, 1250 Prospect St., La Jolla.

**San Joaquin Chapter: (California)**

Fred L. Swartz, President, Fresno; Lloyd J. Fletcher, Vice President, Yuba; Walter Wagner, Secretary, Fresno; Robert W. Stevens, Treasurer, Fresno. Directors: Alastair Simpson, William D. Coats, William F. Baxter, Maurice J. Metz, Delegate California Council of Architects, Office, Sec. Fulton-Fresno Bldg.

**Santa Barbara Chapter: (California):**

Robert I. Hoyt, President; Harold E. Burket, Vice-President;

Roy W. Cheesman, Secretary; Lutah M. Riggs, Treasurer.

Address, 242 San Marcos Bldg.

**Southern California Chapter:**

John J. Landon, President; Chas. Frey, Vice-President; C. Day Woodard, Secretary; Wm. G. Balch, Treasurer, Directors, Paul C. Davis, Henry Wright, John Rex, and Kemper Nonland. Ex. Sec. Rita E. Miller. Chapter Headquarters, 3723 Wilshire Blvd., Los Angeles 5.

**Spokane Chapter:**

Richard H. Eddy, President; Harold C. Weller, Vice-President 1; Kenneth D. Stormant, Vice-President 2; Victor L. Wullt, Secretary, and Carl Johnson, Treasurer. Office 1023 W. Riverside Ave., Spokane, Washington.

**Utah Chapter:**

Howell Q. Cannon, President; William J. Monroe, Jr., Secretary; 3707 South 32nd West Street, Salt Lake City 7, Utah.

**Washington State Chapter:**

Paul Thiry, President; John S. Detlie, 1st Vice President; Walter H. Rothe, 2nd Vice President; Robert H. Dietz, Secretary; Lawrence G. Waldron, Treasurer. Office 714 American Building, Seattle 4.

**Tacoma Society:**

E. N. Dugan, President; P. G. Ball, Vice-President; Lyle Swedberg, Secretary-Treasurer.

**Hawaii Chapter:**

James C. Simms, President; Alfred Pries, Secretary, 1507 Kapiolani Blvd., Honolulu, T. H.

**CALIFORNIA COUNCIL OF ARCHITECTS**

John L. Rex, President; Wm. Koblik, Vice-President; Maurice J. Metz, Secretary-Treasurer, Executive Secretary office 3723 Wilshire Blvd., Los Angeles.

**OTHER ARCHITECTURAL ORGANIZATIONS**

San Francisco Architectural Club:

Alfred T. Kirkveold, President; Charles Dennis, Vice President; William C. Thieleman, Treasurer; Milton Bromberg, Secretary. Office 507 Howard Street.

space, including three bedrooms, a hobby room and two and three-quarters bathrooms. Estimated cost of the home and land is \$27,000.

The home will be of wood frame with shake roof and landscaping fitting the general motif of the Hidden Hills development.

**NORTHERN CALIFORNIA CHAPTER**

The architectural exhibit prepared in conjunction with the annual Marin Art & Garden Fair, and featuring architecture of Marin county, proved to be one of the major drawing attractions at the Show which was held the early part of July. Preparation of the material was in charge of Jack Herman, member of the Activities Committee.

Mrs. Helen Douglas, treasurer of the Chapter, has been appointed to membership in the National A.I.A. Membership Committee, in the Department of Public and Professional Relations. She will represent California for a term lasting through 1954.

**ARCHITECTS CHOSEN FOR STATE BUILDING**

Architects Harry A. Thomsen and Alec L. Wilson, of San Francisco, were selected by California State Public Works Director C. H. Purcell, to design a new State Employment Building to be erected in Sacramento. Cost of the project is estimated at \$7,000,000.

**ARCHITECT PARTICIPATES IN INTERNATIONAL MEMORIAL JURY**

Percival Goodman, prize-winning American architect and illustrator and a member of the School of Architecture at Columbia University, left by air recently for Israel where he will join a panel of judges in an international competition for a me-

morial to be built in Jerusalem honoring the late Theodore Herzl, founder of the Zionist movement.

Goodman will help select the best design for a crypt, monument and memorial park to be erected on Mt. Herzl, and will be the only non-Israeli to sit on the panel.

The competition is open to architects throughout the world and more than fifteen designs have already been submitted by American architects.

**STOCKTON ARCHITECT IS ACTIVE IN PROFESSION**

Among California's architects devoting a considerable amount of time and effort to the interests and activities of their professional organization,

The California Council of Architects, is Frank Mayo of the Stockton architectural firm of Mayo & Johnson.

Aside from serving as President of the association last year, Mayo now devotes considerable time to attending Board and Advisory Committee meetings of the organization.

**FRANK MAYO**

Among major activities of the California Council at the present time is consideration of defense against an atomic attack; study and recommendations to authoritative school representatives' problems on school design, costs and upkeep; a uniform procedure in construction accounting on a statewide basis; and a study to determine the possibilities of codifying existing building and safety rules and regulations.



# WITH THE ENGINEERS

## Structural Engineers Association of California

Arthur W. Anderson, President; Harold P. King, Vice-president; Henry J. Degenkolb, Sec.-Treas.; Office of Sec., 405 Montgomery St., Room 1121, San Francisco.

## Structural Engineers Association of Northern California

John E. Rinne, President; John J. Gould, Vice-President; Wm. W. Brewer, Sec.; Franklin P. Ulrich, Treas.; Directors, Walter L. Dickey, Leslie W. Graham, Hyman Rosenthal, and Howard A. Schirmer.

## Structural Engineers Association of Central California

William H. Petersen, President; Walter S. Wassum, Vice President; C. T. Illich, Sec. Treas.; Ernest D. Francis, M. A. Ewing, and Arthur A. Sauer, directors. Office O. T. Illich, c/o Div. of Arch., Sacramento.

## American Society of C. E. San Francisco Section

Clement T. Wiskocil, President; John S. Longwell, Vice-president; J. G. Wright, Vice-president; H. C. Medbery, Treasurer; R. D. Dewell, Secretary. Secretary's Office, 604 Mission St., San Francisco.

## Structural Engineers Association of Southern California

Donald F. Shugart, President; Harold P. King, Vice President; Robert J. Short, sec-Treas.; Directors, William T. Wheeler, William T. Wright, Ernest C. Hillman, Jr., John Case, and John K. Minasian. Office, 202 Architects Bldg., Los Angeles 13.

## Structural Engineers Association of Oregon

R. Evan Kennedy, President; Guy H. Taylor, Vice President; James R. Griffith, Secretary-Treasurer; Directors Jerome A. McDevitt, H. Loren Thompson, and Robert L. Tidball. Offices, Portland.

## Puget Sound Engineering Council (Washington)

R. E. Kister, A. I. E. E., Chairman; E. R. McMillan, A. S. C. E., Vice Chairman; L. B. Cooper, A. S. M. E., Secretary; A. E. Nickerson, I. E. S., Treasurer. Offices, L. B. Cooper, c/o University of Washington, Seattle 5, Washington.

## American Society Testing Materials Northern California District

L. A. O'Leary, Chairman; P. V. Garin, Vice-chairman; H. P. Hoopes, Sec. Office Sec., 1550 Powell St., Emeryville, Calif.

## STRUCTURAL ENGINEERS ASSOCIATION SOUTHERN CALIFORNIA

The Structural Engineers Association of Southern California held its monthly June meeting at the Alexandria Hotel in Los Angeles.

The program for the evening was "A Panel Discussion of Structural Steel". C. M. Corbit, Jr. acted as moderator for the group and started the pro-

gram by giving a brief summary and discussed the highlights of the new Controlled Materials Plan and the Materials Orders as given by the National Production Authority. Before getting into the actual panel discussion, Mr. Corbit also brought out and discussed a few of the usual problems that confront a structural steel fabricator. The panel which followed Mr. Corbit's opening remarks consisted of Charles Orr, Assistant Chief Engineer, Consolidated Western Steel Corp.; Charles Goddard, Chief Engineer, Apex Steel Corporation; R. W. Binder, Chief Engineer, Fabricated Steel Construction, Bethlehem Pacific Steel Corporation and Cliff Little, Sales Manager of Union Steel Company.

## NEW OFFICERS OF ASTM ANNOUNCED FOR 1951-52

At the annual meeting of the American Society for Testing Materials held at Atlantic City, recently, the following officers were named for the following year:

Truman S. Fuller, President, Leslie C. Beard, Jr., Vice-president and John W. Bolton, Rudolph A. Schatzel, E. O. Slater, Stanton Walker, and F. P. Zimmerli were named to the Board of Directors.

## CIVIL ENGINEERING SCHOLARSHIPS

Winners for 1951 of the ten scholarships in civil engineering awarded annually by the American Institute of Steel Construction, have just been announced.

The winners were selected from a group of high school seniors nominated by steel fabricating companies in nationwide competition and represent nineteen states.

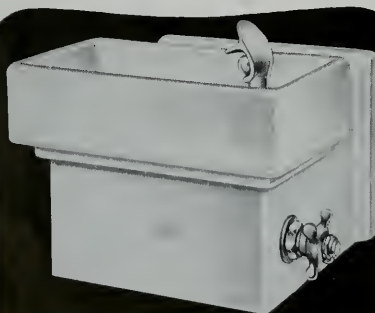

*Always specify* **HAWS**

### FOR HIGHEST QUALITY

- Sanitary Drinking Fountains
- Electric Water Coolers
- Drinking Faucets, Equipment, Filters and Accessories

*A reputation for reliability since 1909.  
Check in Sweet's or write for HAWS catalog.*

## HAWS DRINKING FAUCET CO.

1441 FOURTH STREET (Since 1909) BERKELEY 10, CALIFORNIA  
Agents and Sales Representatives in All Principal Cities

Each candidate may use his \$1,000 scholarship at any engineering school on the approved list of accredited institutions.

Among the winners were Kerry S. Havner, Tulsa, Oklahoma and Twyman Jones of Missouri Valley, Iowa.

The jury of educators which made final choices included Wesley J. Hennessy, assistant dean, Columbia University; Nichol H. Memory, director of admissions, Stevens Institute of Technology, and Robert W. Van Houten, president, Newark College of Engineering. Technical consultant was Arthur L. Benson, Educational Testing Service, Princeton, N. J.

#### ARMY ENGINEERS EFFECT SAVING BY USE OF MODELS

A saving of approximately \$62,000,000 on Army Corps of Engineers civil works projects has been effected during the past ten years by the use of hydraulic model studies at the Vicksburg, Mississippi, waterways experiment station, according to a recent report by Major General Lewis A. Pick, chief of engineers.

The compilation is based upon 59 model studies for which data is available showing savings effected in construction and operation of the original projects.

The small scale model analyses cover three major phases of Engineer projects 1) initial detailed investigation of the problem, 2) design, and 3) construction.

Significant elements pertinent to a major problem are reproduced as accurately as possible to scale. Proposed works or changes in design are installed in the model. The effects are noted and revisions are made in the model until the most desirable or efficient plan is developed.

The problems, involving flood control, navigation, tides, wave action, river meander, salt-water intrusion and shoaling, are frequently complex and subjected to model experimentation for exact solution in advance of the start of operations on an actual project.

#### STRUCTURAL ENGINEERS ASSOCIATION NORTHERN CALIFORNIA

The Annual Picnic at the Old Hearst Ranch near Pleasanton, Alameda county, proved to be no exception to the rule that each year the event gets better and better. Final reports on the golf, tennis, softball, horseshoes and numerous other games are not available as this is written, however, when winners are announced it will be only after the judges have given due consideration to all contestants.

With events starting early in the morning, the day was concluded with a steak dinner on the

Terrace in the late afternoon, with the Picnic Committee of A. M. Nishkian, and Stan Bernhard reporting everything went along according to schedule.

#### PORTLAND SCENE OF ANNUAL ASHVE NATIONAL CONVENTION

The 1951 Semi-Annual Meeting of the American Society of Heating and Ventilating Engineers was held in Portland, Oregon, early this month with one of the largest number of heating and ventilating experts in attendance.

The technical program consisted of twelve papers on the main subjects of "panel heating and cooling", "warm air heating and the heat pump", while among special features was an address by Dean G. W. Gleeson of the School of Engineering and Industrial Arts of Oregon State College, on the subject "Energy—Choose it Wisely Today for Safety Tomorrow."

A number of special reports were made by committees and by studies concluded at the ASHVE Laboratory in Cleveland on four conventional types of ceiling plaster panels.

J. Donald Kroeker, consulting engineer; John H. Bonebrake, engineer; and James A. Melvin, chief

(See Page 31)

**Always specify**  
**HAWS**  
**for Highest Quality**



**HAWS Electric Water Coolers** easily adapt to remote installations of HAWS Drinking Fountains... thus serving several locations.

- A COMPLETE LINE of coolers, fountains, faucets, equipment, filters and accessories. • A reputation for reliability since 1909. • Check in Sweets, or write for complete HAWS catalog.

**HAWS DRINKING FAUCET CO.**  
1441 FOURTH STREET (Since 1909) BERKELEY 10, CALIFORNIA  
Agents and Sales Representatives in All Principal Cities

# PRODUCER'S COUNCIL PAGE

The National Organization of Manufacturers of Quality Building Materials and Equipment  
affiliated with THE AMERICAN INSTITUTE OF ARCHITECTS

President, Arthur C. Staat  
Natural Gas Equipment, Inc.  
1150 Folsom Street

Vice-President, Fred A. Fiquero  
Ois Elevator Company  
1 Beach Street

Secretary, Howard Nolen  
E. F. Houseman Company  
500 Second Street

Treasurer, A. L. West, Jr.  
Aluminum Company of America  
Russ Bldg.

Edited by Carl B. Frank, DETROIT STEEL PRODUCTS CO.

One of our newer members, C. T. (Ted) Bakeman, owner of the C. T. Bakeman & Associates (representing five of the nation's outstanding national lighting fixture manufacturers), is a former resident of Seattle, Washington, and for more than twenty-three years prominently identified with the electric power industry of the Pacific Northwest.



C. T. (TED) BAKEMAN  
C. T. Bakeman & Associates  
Manufacturers Representatives

Bakeman is rapidly adjusting himself to his new surroundings, and has already acquired a substantial acquaintance in the construction and allied industries of the San Francisco-Oakland bay area and northern California.

Ted was born on May 23, 1903 in the thriving city of Snohomish, Washington, and following graduation from the University of Washington as an Electrical Engineer, became associated with the Puget Sound Power & Light Company. He ran the gamut of jobs available to a young and promising engineer with a growing public utility corporation—meter reader, lineman, plant foreman, power engineer, sales engineer, ass't sales manager, ass't to the vice president, lighting director, industrial and commercial director, and after some twenty years of sticktiveness arrived at the position of Director of Industrial Development, a position he held until resigning to form his own organization.

In addition to his duties with the Puget Sound Power & Light Company, and subsidiaries, Ted found time to take an active part in many community and professional activities.

He serves as Regional Vice-President of the Illuminating Engineering Society; Chairman of the Northwest Industrial Development Committee of the Northwest Power Association; Chairman of the

War Production Conference, Northwest Technical Society's War Production Committee; Chairman of the Supervisor's Sessions of the Seattle Safety Council and joint sponsorship; Asst. Director and Consultant—U. S. Office of Civilian Defense, Northwest sector; Consultant for the Western Defense Command and Second Interceptor Command; Consultant for the Washington State Defense Council; Member of the Governor's Advisory Committee, State of Washington; and a number of civic and other groups.

Not satisfied with all these activities, Ted has been an active member of the Illuminating Engineering Society, San Francisco Bay Chapter; the California Society of Professional Engineers; and the Pacific Coast Electric Association of San Francisco Electric Club, since establishing his business connections in the Bay Area.

Ted was awarded a Fellowship by the Illuminating Engineering Society for "outstanding contributions to technical activities, inventions, and work" in the electric industry, an award which Ted considers among "top priority" among his many accomplishments.

Ted is married and the father of two sons and one daughter; his principal hobby, aside from community service, is fishing.

## COMING ATTRACTIONS

Two outstanding events which will soon occur in California which are of special interest to all members are:

ANNUAL FALL CONVENTION  
of the  
STRUCTURAL ENGINEERS ASSOCIATION  
Of California  
Yosemite Park, October 11 to 13

ANNUAL CONVENTION  
of the  
CALIFORNIA COUNCIL OF ARCHITECTS  
A. I. A.  
Coronado, October 4, 5, 6.

USE QUALITY PRODUCTS



CONSULT AN ARCHITECT

## WITH THE ENGINEERS

(From Page 29)

operating engineer of the Oregonian Building presented a paper describing the application of a water-to-water heat pump and complete air conditioning of the Portland Oregonian, one of the West's most outstanding daily newspapers.

The Oregon Chapter of the ASHVE served as hosts to the conference and included on the Committee of Arrangements were: General Chairman, Mr. Farnes; honorary chairman, Prof. E. O. Eastwood, ASHVE past president; vice chairman, Frank Urban; president Oregon Chapter, Harold McKenzie; reception, Bruce Morrison; sessions, Wayne McCarthy; finance, Don Kroeker; entertainment, Ed Lokey; ladies, John McDermott; banquet, Tom Taylor; sports, Dick Lankow; transportation, Al Freeman; attendance, Carrol Brissenden; publicity, Abe Hoss; special activities, Dick Blankenship, and Alaska Representative, Bill Hoss.

## AMERICAN SOCIETY FOR TESTING MATERIALS

Authors of outstanding technical papers presented at previous meetings of the American Society for Testing Materials were given awards at the 1951 ASTM Annual Meeting recently.

Among those receiving recognition were: Professors D. S. Clark and P. E. Duwez, California Institute of Technology, for their paper entitled "The Influence of Strain Rate on Some Tensile Properties of Steel", which won them the Charles B. Dudley Medal.

The Richard L. Templin Award went to R. L. Templin and W. C. Aber, Aluminum Company of America for their paper entitled "A Method for Making Tension Tests of Metals Using a Miniature Specimen". The Sam Tour Award went to C. T. Evans, Jr., of the Elliott Co., for his paper "Oil Ash Corrosion of Metals at Elevated Temperatures"; and the Sanford E. Thompson Award went to R. C. Mielenz, L. P. Witte and O. J. Glantz of the U. S. Bureau of Reclamation for their paper "Effect of Calcination on Natural Pozzolans."

## NATIONAL CONCRETE CONFERENCE

A national conference on prestressed concrete has been scheduled at the Massachusetts Institute of Technology from August 14 to 16.

The conference will have the sponsorship of a number of professional societies, and will have as its objective the answer to many of the questions which must be answered before the use of prestressed concrete can be fully extended in American construction practices.

Topics which will form the basis of consideration during the conference are: Present and pos-

sible future application of prestressed concrete construction; Manufacture and construction, including materials, techniques, and costs; and Problems in research and design presented by the use of prestressed concrete.

## JOINT COOPERATIVE COMMITTEE AGCA AND PC IS ANNOUNCED

Establishment of a national joint cooperative committee for the study of problems of mutual interest has been formed by the Producers' Council and The Associated General Contractors of America.

Purpose of the joint committee is to provide a medium through which producers of building materials and general contractors can cooperate to increase the efficiency of the industry. The committee will consider projects suggested by members of the committee, by members of chapters of either organization, by other groups in the construction industry or by the public.

Members of the new committee are: Producers' Council: David S. Miller, The Kawneer Co., Niles, Michigan, co-chairman; F. M. Hauserman, The E. F. Hauserman Co., Cleveland; Arthur Hedgren, H. H. Robertson Co., Pittsburgh; Edward P. Lockart,

**HOLLYWOOD JUNIOR**  
COMBINATION  
SCREEN and METAL SASH DOOR  
★  
The "WEATHER-WISE"  
DOOR!!

**A VENTILATING SCREEN DOOR  
A SASH DOOR  
A PERMANENT OUTSIDE DOOR  
ALL 3 IN 1!**

Discreet home owners and architects have chosen Hollywood Junior as the TRIPLE DOOR VALUE in the COMBINATION SCREEN and METAL SASH DOOR field.

A sturdy dependable door, constructed of quality materials, HOLLYWOOD JUNIOR'S EXCLUSIVE PATENTED FEATURES have outmoded old-fashioned screen doors and other doors of its type entirely!

**IT GUARANTEES YOU YEAR 'ROUND COMFORT, CONVENIENCE and ECONOMY**

WE ALSO MANUFACTURE A COMPLETE LINE OF  
SHUTTERS, C. C. DOORS, SCREENS, SCREEN DOORS, LOUVRE DOORS

**WEST COAST SCREEN CO.**  
1145 EAST 43RD STREET ★ JUNE 1951 LOS ANGELES, CALIFORNIA

WRITE FOR FREE ILLUSTRATED LITERATURE



American Structural Products Co., Toledo; Alex Marks, Otis Elevator Co., New York; Ludolph S. Meyer, Hydraulic-Press Brick Co., St. Louis; and Charles Mortensen, Executive Secretary, The Producers' Council, Washington, co-secretary.

A. G. C.: W. Murray Werner, The Werner Co., Shreveport, Louisiana, co-chairman; J. W. Cawdrey, Cawdrey & Vemo, Seattle; F. L. Shackelford, Potter-Shackelford Construction Co., Greenville, South Carolina; R. A. Smith, P. J. Walker Co., Los Angeles; J. R. Sweitzer, J. S. Sweitzer & Son, Inc., St. Paul; John A. Volpe, Volpe Construction Co., Malden, Massachusetts; and Welton A. Snow, Manager, Building Contractors' Division, A.G.C., Washington, co-secretary.

### ORGANIC PLANNING IN LANDSCAPE DESIGN

Organic planning in landscape design was described during the recent Louisiana State University Festival of Contemporary Art by Robert Deering, chairman of the landscape gardening division of the University of California at Davis.

Deering pointed out that "many otherwise well designed gardens, stress architectural details rather than a dynamic plan relating the plant materials to the growing and changing family group." A garden design should present a balance between

living and the architectural elements of planting. Organic planning develops use of the outdoor space radially from a central living core or structure, resulting in a garden estetically pleasing and graciously adapted to human activities. Gardens merely to look at and not to live in, are static in form and are rightly a thing of the past, Deering believes.

A number of speakers from several universities throughout the nation were on the Festival program which stressed all phases of art. Deering represented the field of landscape design.

### AUGUST WILL OBSERVE NATIONAL CLAY WEEK

The clay industry will be commemorated throughout the country from August 22 to 25 in the Second Annual National Clay Week.

"Make It Clay All The Way" is the theme of innumerable events being scheduled by the industry throughout the nation. Manufacturers of clay pipe, brick, tile, refractories, pottery, and china will observe "Open House" programs designed to enable the public to observe modern methods and equipment used in the manufacture of clay products.

### BRITISH BUILDING CONGRESS TO HEAR U. S. SPECIALISTS

Many American experts in the construction industry will present papers at the Building Research Congress of Great Britain to be held in London from September 11 to 20.

Included in the technical discussions will be representatives from Britain, Australia, Canada, South Africa, Austria, France, Germany, Holland, Sweden, Switzerland and the United States.

Objective of the Congress is to review recent developments in all branches of building science and to assess their importance and their effects on future building trends. In attendance will be architects, engineers, builders, contractors, and scientists.

### MARCH EMPLOYMENT HIGH IN CONSTRUCTION INDUSTRY

Employment in the construction industry probably reached its highest mark this year during March when 2.3-million workers were employed. Employment has dropped considerably since that time due to a 40 per cent slash in residential production imposed by the government.

The latest month for which figures are available, show that the average hourly earnings for workers was the second largest industry in the nation. February shows an average of \$2.155 per hour.

## WILL OUTLAST YOUR BUILDINGS

**NEW  
STANLEY  
"Full-  
Jeweled"  
ball bearing  
butt  
hinge**

*takes both lateral  
and vertical thrust*

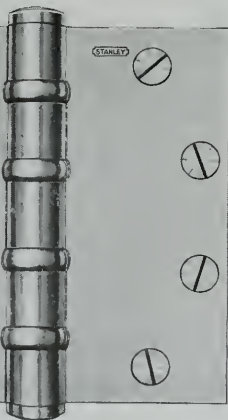

The Stanley Works  
New Britain, Connecticut



STANLEY • TOOLS • ELECTRIC TOOLS  
STEEL STRAPPING • STEEL

## MINERAL WOOL INDUSTRY ADOPTS NEW PROGRAM

The Industrial Mineral Wool Institute of New York has inaugurated a industry-wide certification program designed to assure standard quality and program to users of mineral wool products.

The new plan calls for a certification notice on each carton or section calling attention to the fact that the product's properties exceed minimum requirements prescribed by two commercial standards issued by the National Bureau of Standards, U. S. Department of Commerce.

The Institute comprises sixteen leading manufacturers of mineral wool insulation, with plants in all sections of the nation and Canada.

## NEEDS EQUIPMENT ENGINEERS

The Division of Highways, State of California, is seeking Associate Equipment Engineers to fill positions in the Sacramento office. Applications will be received by the State Personnel Board until July 14th for a civil service examination to be held in August.

Five years of engineering experience in work requiring a knowledge of the use and care of automotive and heavy construction equipment and the equivalent of college graduation is necessary.

## PANELBOARD COMMERCIAL STANDARD

A Recommended Commercial Standard for Pre-decorated Panelboard has been circulated by the Commodity Standards Division, Office of Industry and Commerce, to manufacturers, distributors and users.

The recommendation establishes a definite criteria of requirements that should be possessed by this material and presents a basis on which performance guarantees may be made by the manufacturer for the guidance and assurance of home owners, architects, and builders.

## ARCHITECTS NEEDED FOR SOUTHERN CAL

State of California construction projects in southern California have required an increase of 600 per cent in the staff of the Division of Architecture's Los Angeles office in the last two years and the office is still very much in need of help.

This situation was disclosed by the State Personnel Board in connection with release of a number of proposed major projects, either under way or about to be started, by Chas. H. Purcell, Director of Public Works.

The southern California projects account for a substantial part of the \$259,616,577 worth of business which the State Division of Architecture has undertaken during the past two years. The Division has set its sights on having the Los Angeles office handle \$15,000,000 worth of business a year.

The trend is to **QUALITY**  
in lighting equipment

ILLUMINATION EQUIPMENT  
**SMOOT-HOLMAN**  
INGLEWOOD, CALIFORNIA  
MADE IN U.S.A.

MEANS  
TOP  
QUALITY  
ALWAYS!

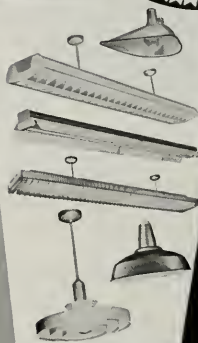

SMOOT-HOLMAN COMPANY Inglewood, Calif. Offices in Principal Western Cities • Branch and Warehouse in San Francisco



## A Combined

Landscape Architecture  
and Contracting Service

for

Tract, Industrial and Residential  
Development

We can do the Complete Job for you

- Landscape Architecture
- Finish Grading and Landscaping
- Asphalt Drives and Parking Lots

**HENRY C. SOTO CORPORATION**  
*Landscape Contractors*

13000 SO. AVALON BLVD. LOS ANGELES 61, CALIF.  
Phone MEnlo 4-6617



Specify Utility equipment!—The one sure way to avoid the headaches of an installation that just doesn't measure up to your specifications. You're sure with Utility because it sets the industry standard for quality and performance.

#### A FULL RANGE OF UTILITY HEATING EQUIPMENT

**Floor Furnaces**—45,000 BTU/Hr. input, flat and dual; also, 60,000 BTU/Hr. input, flat and dual (both sizes, shallow-type construction). **Wall Heaters**—Single—27,500 BTU/Hr. input; Dual—35,000 BTU/Hr. input and 50,000 BTU/Hr. input. **Forced Air Furnaces**—75,000 BTU/Hr. input; 100,000 BTU/Hr. input; 125,000 BTU/Hr. input and 150,000 BTU/Hr. input. **Unit Heaters**—4 sizes. All Utility Heating Equipment is tested and approved by A.G.A.



#### UTILITY EVAPORATIVE AIR COOLERS AND VENTILATING EQUIPMENT FOR EVERY PURPOSE

Utility's air delivery tables are complete and authentic, derived from tests made in accordance with A.S.H.V.E. test codes. Every Utility cooler is tested in accordance with these same codes. You can meet every requirement with Utility. The line includes evaporative coolers, both Fan and Blower types... sizes to meet all requirements.

#### SEND FOR AIA ENGINEERING INFORMATION

For this complete technical data on Utility equipment, plus valuable tables, charts, installation details, write (on your letterhead) to Engineering Dept. Counsel from a Utility Engineer available without charge.

UTILITY APPLIANCE CORP.  
4851 S. Alameda Street, Los Angeles 58, California



EVAPORATIVE AIR COOLERS      GAS-FIRED FURNACES  
VENTILATING EQUIPMENT

Manufacturers of Gaffers & Sattler and Occidental Gas Ranges

James Gillem, principal architectural designer in charge of the Los Angeles office is looking for structural designers and draftsmen, mechanical and electrical engineers, estimators of building construction, construction supervisors, and specifications writers.

The Los Angeles office was opened less than two years ago with 20 architects and engineers, and today the staff exceeds 150.

#### COMMERCIAL STANDARD STANDARD STOCK DOORS

A recommended revision of old growth Douglas Fir, Sitka Spruce and Western Hemlock Standard Stock Doors is being circulated by the Commodity Standard Division, Office of Industry and Commerce, to manufacturers, distributors and users for their consideration and written acceptance.

The revision, proposed by the Fir Institute, is to include a new grade and eight new stock layouts or designs, and will cover five standard grades and include layouts for house, garage and cupboard doors and side lights. Illustrations of sixty-seven different stock designs are shown from which selections can be made that will harmonize with various architectural styles.

Architect and Engineer  
68 Post Street  
San Francisco 4, California  
Gentlemen:

We want to express our appreciation for the interesting article and many photographic illustrations of the Frank Tripp residence, Eugene, which appeared in the April issue of *Architect & Engineer*, text of which was written by Arthur W. Pricaul.

There are many other interesting articles and the magazine is enjoyed by this office, including the news briefs and even the advertising.

We also thank you for the six additional copies you mailed us, which will be useful for distribution, one copy of which we are sure that Mr. Tripp will greatly appreciate.

Thank you again for including the Tripp home. We wish you much continued success and feel you will find cooperation from the architects in this territory.

Very truly yours,  
May 3, 1951.      Percy D. Bentley

#### SCHOOL OF MODERN HEATING OBSERVES FIRST BIRTHDAY

The "School of Modern Heating," sponsored by The Institute of Boiler and Radiator Manufacturers, reached its first birthday recently with Arthur L. Wales, instructor of the exhibit reporting a most successful year.

The school travels around the country and dur-

ing its first year visited 44 cities and was attended by more than 3,500 students. Enrollment in the school is open to contractors and their assistants, wholesalers and their representatives, and others in the heating industry who want to know more about their trade.

#### RADIO RELAY STATION

The Corps of Engineers of the U. S. Army have awarded a contract to J. Ar Waterbury and Fred J. Chapek of Sacramento, for the construction of a Radio Relay Station on top of Mt. Vace, near Vacaville, Solano county.

#### COMMERCIAL STANDARD HARDWOOD VENEER DOORS

Commercial Standard CS171-50 covering hardwood veneered doors have been approved and are now available from the U. S. Department of Commerce.

Proposed by the National Woodwork Manufacturers Association, the Standard provides specifications for standard sizes, layouts and construction of hardwood veneered doors. It serves as a guide to architects, builders, manufacturers, distributors and other interests.

The new standard covers panel and sash doors, solid-core flush doors, and hollow-core flush doors. Standard stock layouts and designs are included for cupboard, exterior, French or casement, flush, interior, and toilet doors, and for side lights. It also covers grades, tolerances, inspection, labeling and nomenclature and definitions.

#### FUNDS FOR CHURCH

The St. Mathews Episcopal Church, Sacramento, is endeavoring to raise \$150,000 for the purpose of completing Church properties at Edison and Bell Avenues in Sacramento. Chas. F. Dean of Sacramento is the architect.

#### WESTERN ASBESTOS COMPANY NAMED MATERIAL REPRESENTATIVE

The Western Asbestos Company has been appointed an approved applicator for the Nelson stud welding method for installing industrial corrugated and flat asbestos cement roofing and siding materials.

The franchise issued by the Nelson Stud Welding Division of the Morton Gregory Corporation, according to Clark E. Wayland, vice president in charge of sales for Western Asbestos, covers all of northern California.

#### HIGH SCHOOL BONDS VOTED

Voters of the City of Stockton have approved a bond issue of \$8,800,000 for construction of High and Elementary schools.

## Parker, Steffens & Pearce

**BUILDERS**

135 South Park, San Francisco

Phone: EXbrook 2-6639

## BARRETT & HILP

**CONTRACTORS**

*Builders of the West*

918 Harrison Street • San Francisco  
Telephone DOuglas 2-0700

234 West 37th Place • Los Angeles  
Telephone ADams 3-8161

**Brownskin**  
STANDARD

The resilient building paper creped to S-T-R-E-T-C-H

Quality Products Since 1815  
**ANGIER PACIFIC CORPORATION**  
55 NEW MONTGOMERY ST. 2424 SUNSET BOULEVARD  
SAN FRANCISCO 5, CALIF. LOS ANGELES 48, CALIF.

A complete line of Angier products available from your building material dealer

## STOP

Penetration Of  
**MOISTURE  
WIND  
DUST  
VERMIN**

EVERLASTING  
PROTECTION

## FORDERER CORNICE WORKS

*Manufacturers of*

Hollow Metal Products • Interior Metal Trim  
Elevator Fronts and Cabs  
Metal Plaster Accessories • Sanitary Metal Base  
Flat and Roll Metal Screens  
Metal Cabinets • Commercial Refrigerators

269 POTRERO AVE.

SAN FRANCISCO, CALIF.

HEMLOCK 1-4100



# HOGAN LUMBER CO.

Wholesale and Retail

## LUMBER

MILL WORK • SASH & DOORS

Office, Mill, Yard and Docks  
SECOND AND ALICE STREETS • OAKLAND, CALIF.  
Telephone GLencourt 1-6861



**PROTECTIVE  
BUILDING PAPER...  
WATERPROOF, REINFORCED... USED  
AS SHEATHING PAPER, PROVIDES LIFE-LONG  
PROTECTION FROM ENTRY OF WIND, DUST AND  
MOISTURE. IDEAL FOR STUCCO-BACK, OVER  
SUBFILL, CONCRETE CURING, UNDER FLOORING,  
etc. Write for samples and complete data.**

### The SISALKRAFT CO.

55 New Montgomery St. San Francisco 5, California

## JUDSON PACIFIC-MURPHY CORP.

Steel Fabricators  
and  
Erectors

REINFORCING STEEL  
STRUCTURAL STEEL  
BRIDGE CRANES

4300 EASTSHORE HWY.  
EMERYVILLE, CALIF.

Phone:  
OL 3-1717

## CLINTON CONSTRUCTION CO. OF CALIFORNIA

General Contractors

923 FOLSOM STREET • SAN FRANCISCO

SUtter 1-3440

## BOOK REVIEWS PAMPHLETS AND CATALOGUES

U. S. INDUSTRIAL DESIGN 1951—Studio-Crowell Publishers, New York. Edited by Society of Industrial Designers. Price \$10.00.

This second U. S. Industrial Design book includes such subjects as: products, transportation, commercial structures, and packaging and presents them as an industrial design process—as an active and continuing force in our American economy.

Designers themselves have explained their work and the items covered have but recently appeared on the market. Vacuum cleaners, washers, airplanes, factory machinery, steamships, automobiles, tractors, store interiors and exteriors, are but a few of the items regularly influenced by the analysis and creative thinking of industrial designers.

Anyone interested in design, architecture, engineering, and manufacturing will find the book very interesting.

LANDSCAPE ARCHITECTURE — Department of Landscape Architecture, Graduate School of Design, Harvard University, Cambridge, Mass. Price \$2.00.

The Department of Landscape Architecture, Graduate School of Design, of Harvard University has gathered a volume of selections taken from the contemporary work done by the men and women in the Department. The book also contains a few essays about Landscape Architecture.

The book has been edited by Lester Collins and Thomas Gillespie, with the foreword by Bremer W. Pond, Chairman, Department.

CLIMATE IN EVERYDAY LIFE. By C. E. P. Brooks. Philosophical Library, Publishers. New York City. Price \$4.75.

The book is the result of a paper given before the Royal Meteorological Society in 1946 entitled "Climate and the Deterioration of Metals" and for which the request for copies depleted the supply. It covers a wide scope of subjects and is intended to assist the reader to make the best of the climate in which he lives . . . in health, housing, lighting, clothing, transport, etc.

Three general classifications are covered: Part 1, Living With the Climate; Part 2, Climate as an Enemy, and Part 3, The Control of Climate.

### NEW CATALOGUES AVAILABLE

Any of the catalogues or folders described here may be obtained by forwarding your request as indicated in the coupon below to the office of the ARCHITECT & ENGINEER. Merely mark the items you want and clip or paste the coupon to your letterhead.

#### NEW CATALOGUES AVAILABLE

293. SOUND CONDITIONING OF SCHOOL BUILDINGS. A new brochure entitled "Sound Conditioning for Schools and Colleges" has just been published by The Celotex Corporation, pioneer manufacturers of acoustical materials. The book covers not only the general subject of noise control in schools, but also the particular sound problems of specific areas such as corridors, auditorium, cafeteria, music rooms, typewriting rooms, classrooms, library, gymnasium and administrative offices. 6/4/51.

294. PERIFX INDUSTRIAL CONTROLS. Three new bulletins on automatic controls and instruments for Perifx Draft Control Systems are now ready for distribution, according to Dale Cook, Manager Industrial Controls Dept., Perifx Corporation. One bulletin deals with oil, a second with gas, and a third with stoker-firing. In each bulletin it is pointed out that the Perifx Draft Control System handles three important functions: (1) Controls draft in the firebox during "off" periods to prevent excessive slack losses. (2) Opens damper before restarting burner to provide safe starting conditions and (3) Switches to automatic draft control during burner operation to maintain constant draft in the firebox. Application of each control is shown by a pictorial layout with functions of each control outlined. Each bulletin is complete with typical wiring diagrams suggesting how Perifx Control Systems can be easily incorporated into the burner control system. Wiring diagrams also show relationship of other automatic Perifx controls such as pressure and temperature controls, stoker timers and gas valves. 6/51.

**295. NEW INSHOT GAS BURNER BY DELTA.** A data sheet has just been released covering the new inshot gun-type gas burner with a balanced flame introduced by the Delta Heating Corporation. The data sheet covers all of the features of this new burner. Illus. 4/13/51.

**296. HOW TO DECORATE CLASSROOMS.** Following through on the Coordinated Classroom research of Dr. Darell Boyd Harmon, educationist, the Luminall Paint Division of National Chemical & Mfg. Company, has published a second and more comprehensive edition of the school color card "How to Decorate Classrooms in the Harmon Technic." To guide architects, educators and lighting engineers in selecting tested decorating patterns developed by Dr. Harmon at the Rosedale School, Austin, Texas, and used nationally in hundreds of school plants, the brochure offers a five step methodology for choosing color combinations for classrooms, laboratories and domestic science rooms. 12 pages illus. A.I.A. 35-B, 1/51.

**297. NEW COLOR IS HOW YOU LIGHT IT.** A new book which will enable decorators, designers, architects, engineers, industrialists, merchandisers and the average homemaker to predict how a color will look under any one of the eight colors of white light now available, was announced here today by Sylvania Electric Products Inc. Entitled "Color is How You Light It," the new book, according to Winonah Murphy, the company's color expert under whose supervision the work was done, is an improved and expanded version of the original introduced by the company two years ago. This second edition includes analyses of the two new De Luxe colors of fluorescent white light perfected since publication of the first Sylvania color and light book. 5/23/51.

**298. RADIANT BASEBOARD PANELS.** A simplified, rule-of-thumb method for estimating approximate heat losses, radiation requirements and materials costs for RADIANT-FAY brand baseboard heating is one of several important features in the new, revised "Easy Estimator" published by Radiant Baseboard Panels, Inc. Other features include simplified installation data; handy forms for computing individual room requirements; a special form for summarizing overall costs; price lists and a chart showing how to effect substantial savings in piping costs. 14 pages, illus. 6/12/51.

**299. CASCADE BATH ENCLOSURE.** The new Fiat Metal Mfg. Co. Cascade Bath Enclosure made of Plexiglas is described and shown in a brochure just released. Installation directions are shown as well as specifications. A.I.A. 35-H-6, 4 pages illus., 5/29/51.

**300. FENESTRA STEEL AND ALUMINUM BUILDING PANELS.** "Fenestra Steel and Aluminum Building Panels" is the title of a new 1951 Detroit Steel Products Company catalog containing valuable data for architects, engineers, contractors, school boards, owners, and others who are interested in better and more economical construction of schools, hospitals, residences, industrial and commercial buildings. The catalog provides detailed panel selection tables as a guide to choice of the most economical Fenestra panel for a given span and given load. The Detail Section has been revised to represent current practice, and the catalog contains numerous photos of new job installations completed in the past year. Complete descriptions of and specifications for various Fenestra wall, deck and floor panels are included. A.I.A. 17-A, 38 pages, illus. 1/51.

**ARCHITECT AND ENGINEER**

68 Post Street, San Francisco, Calif.

I would like to have a copy of each of the New Catalogues I have circled.

293	294	295	296
297	298	299	300

Please send to the address on my letterhead, or as I have indicated, and to my attention. (Please print your name — no literature will be sent on this coupon after August, 1951.—A. & E.)

**SAN DIEGO REPORTS ON HOUSING UNIT STARTS**

Residential construction in San Diego, California, during the past 21 years has reached a total of 60,132 dwelling units, according to a recent survey conducted by the City Planning Department.

**The Most Complete Line of STEELS and STEEL BUILDING MATERIALS Made by a Single Producer**



See Sweet's Catalog File or write us for full information.

**REPUBLIC STEEL CORPORATION**

GENERAL OFFICES: CLEVELAND, OHIO

DENVER, COLORADO . . . CONTINENTAL OIL BUILDING  
LOS ANGELES, CALIF. . . GENERAL PETROLEUM BUILDING  
SAN FRANCISCO, CALIFORNIA . . . RIALTO BUILDING  
SEATTLE, WASH. . . . . WHITE-HENRY-STUART BUILDING

**PACIFIC MANUFACTURING CO.**

High Class Interior Finish Quality Millwork

16 Beale St., San Francisco  
ARfield 1-7755

2215 El Camino Real, San Mateo  
S. M. 5-0687

304 Bryant Street, Palo Alto  
P. A. 3373

2610 The Alameda, Santa Clara  
S. C. 6-07 (Factory)

6820 McKinley Avenue, Los Angeles  
THornwell 4196

MAIN OFFICE — SANTA CLARA

**"AMERICAN - MARSH"**

CONDENSATION UNIT

Pumping Machinery for Every Purpose

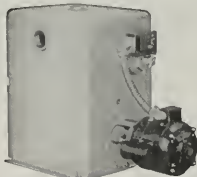

For Service Call DOuglas 2-6794 or MUtal 8322

**SIMONDS MACHINERY CO.**

SAN FRANCISCO 816 FOLSOM

LOS ANGELES 455 EAST 4TH

**VERMONT MARBLE COMPANY**

DOMESTIC AND IMPORTED MARBLES GRANITE VENEER

525 MARKET STREET • SAN FRANCISCO

Phone: SUtter 1-6747

3522 COUNCIL STREET • LOS ANGELES

Phone: DUkirk 2-7831

MEMO

Save  
time while  
saving money

Use  
Crocker Bank's  
Railway  
service



**CROCKER FIRST NATIONAL BANK**  
1 Montgomery Street SAN FRANCISCO - 360-14th Street OAKLAND  
MEMBER FEDERAL DEPOSIT INSURANCE CORPORATION

## VALUABLE NEWS SERVICE

- BUILDING MATERIAL DEALERS
- CONTRACTORS
- ENGINEERS
- FINANCIAL INSTITUTIONS

**ARCHITECTS REPORTS** gives advance news on construction projects in Northern California, lists: name of projects, location, architect, proposed cost and other pertinent information.

**HANDY** individual slip-reports, issued daily at a total cost of only

\$10 a month

## ARCHITECT'S REPORTS

Published Daily

The ARCHITECT and ENGINEER, Inc.

68 Post Street, San Francisco - DO 8311

## INDUSTRIAL BRANCH BANK

(From Page 19)

The grounds are to be attractively landscaped when the general contractors, Al Teller Construction Company, can get free of the mud in the garden areas. Parking lot has been blacktopped and the entire block-square area is surrounded by a striking saw-tooth design cedar slat picket fence.

One of the reasons for the building's charm is the tasteful and pleasing manner in which Caine has used native woods in the interior finish. West Coast hemlock paneling has been used in a room-high wainscoting effect on the wall back of the officers' sections and to provide walls for ceilingless conference rooms. Finished in natural colors, the warm golden effect of the wood breaks the solid pattern of brick and masonry. All of the structure is two stories high with main banking area two stories in the clear. Accounting offices and employees' rooms are on a part of the second level. Exterior covered areas are provided around two sides of the bank, over the drive-in teller's windows and along a portion of the rear of the building by a projecting roof member at the first floor level.

First National Bank's Industrial Branch is located between 18th and 19th, Raleigh and Savier Streets in the Northwest district. It will serve more than 400 business firms and an estimated 15,000 workers in the area. It is believed more than twelve per cent of the employed people in Portland work in this concentrated manufacturing, freight terminal and warehousing district.

Landscaping will be under the direction of Arthur Erteldt, landscape architect. He will use junipers, rhododendrons, daphnes, barbery, azaleas, miniature English ivy, Oregon grape and bush pine throughout the grounds. The bank officials expect to make these grounds one of the show places of Portland.

Caine has succeeded admirably in eliminating the typical coldness of the ordinary commercial bank interior from the Industrial Branch. He started out to design a building where people would feel at home the minute they stepped through either one of the entrance doors. Some of this effect of friendliness and homelike atmosphere he captures by the use of warm pastel shades in decorating masonry walls. Warmth of wood is further accentuated by finishing the hemlock paneling in natural color. Use of the Roman brick as an unfinished interior wall along one entire side was calculated to break down the deadness of uniformity. This compact banking establishment is a model of utility and originality and is a tribute to its designer Morton H. Caine, A.I.A. Architect.

# ESTIMATOR'S GUIDE

## BUILDING AND CONSTRUCTION MATERIALS

PRICES GIVEN ARE FIGURING PRICES AND ARE MADE UP FROM AVERAGE QUOTATIONS FURNISHED BY MATERIAL HOUSES TO SAN FRANCISCO CONTRACTORS. 3% SALES TAX ON ALL MATERIALS BUT NOT LABOR

All prices and wages quoted are for San Francisco and the Bay District. There may be slight fluctuation of prices in the interior and southern part of the state. Freight cartage, at least, must be added in figuring country work.

**BONDS**—Performance or Performance plus Labor and Material Bond(s), \$10 per \$1000 on contract price. Labor & Material Bond(s) only, \$5.00 per \$1000 on contract price.

### BRICKWORK—MASONRY—

Common Brick—Per 1 M laid—\$100.00 up (according to class of work).  
Face Brick—Per 1 M laid—\$200.00 and up (according to class of work).  
Brick Steps—\$3.00 and up.  
Common Brick Veneer on Frame Bldgs.—Approx. \$1.20 and up (according to class of work).  
Face Brick Veneer on Frame Bldg.—Approx. \$2.00 and up (according to class of work).  
Common Brick—\$36.00 per M—truckload lots, delivered.  
Face Brick—\$81.00 to \$106.00 per M, truckload lots, delivered.

### Glazed Structural Units—

Clear Glazed—  
2 x 4 x 12 Furring ..... \$1.60 per sq. ft.  
4 x 6 x 12 Partition ..... 1.90 per sq. ft.  
4 x 6 x 12 Double Faced .....  
Partition ..... 2.25 per sq. ft.  
For colored glaze add ..... .30 per sq. ft.  
Mantel Fire Brick—\$105.00 per M—F.O.B. Pittsburgh.

Fire Brick—Per M—\$111.00 to \$147.00.  
Cartage—Approx. \$10.00 per M.  
Paving—\$75.00.

**Building Tile—**  
6 5/8" x 12-inches, per M. .... \$139.50  
6 5/8" x 12-inches, per M. .... 105.00  
4 5/8" x 12-inches, per M. .... 84.00

**Hollow Tile—**  
12 1/2 x 24-inches, per M. .... \$146.75  
12 1/2 x 24-inches, per M. .... 156.35  
12 1/2 x 24-inches, per M. .... 177.10  
12 1/2 x 24-inches, per M. .... 235.30  
F.O.B. Plant

### BUILDING PAPER & FELTS

1 ply per 1000 ft. roll ..... \$5.30  
2 ply per 1000 ft. roll ..... 7.80  
3 ply per 1000 ft. roll ..... 9.70  
Brownskin, Standard 500 ft. roll ..... 6.85  
Sisalcraft, reinforced, 36 in. by 500 ft. roll ..... 7.00

**Sheathing Papers—**  
Asphalt sheathing, 15-lb. roll ..... \$2.00  
30-lb. roll ..... 2.79  
Dampcourse, 216-ft. roll ..... 2.95  
Blue Plasterboard, 40-lb. roll ..... 5.10

**Felt Papers—**  
Deadenng felt, 3/4-lb., 50-ft. roll ..... \$3.23  
Deadenng felt, 1-lb. .... 3.79  
Asphalt roofing, 15-lbs. .... 2.00  
Asphalt roofing, 30-lbs. .... 2.79

**Roofing Papers—**  
Asphalt Flg., 15 lb. .... \$2.09  
Standard Grade, 108-ft. roll, Light ..... 1.87  
Smooth Surface, Medium ..... 2.18  
Heavy ..... 2.56  
M. S. Extra Heavy ..... 2.96

### BUILDING HARDWARE—

3/8 in. cord com. No. 7 ..... \$2.65 per 100 ft.  
3/8 in. cord com. No. 8 ..... 3.80 per 100 ft.  
5/8 in. cord spot No. 7 ..... 3.45 per 100 ft.  
5/8 in. cord spot No. 8 ..... 3.35 per 100 ft.  
Sash cord, cast iron, \$100.00 ton .....  
1-Ton lots, per 100 lbs. .... \$3.75  
Less than 1-ton lots, per 100 lbs. .... \$4.75  
Nails, per keg, base ..... \$11.80  
Nails, spikes ..... 11.80  
Rim Knob lock sets ..... 1.80  
Butts, dull brass plated on steel, 3/4 x 3/4 ..... 76

### CONCRETE AGGREGATES—

The following prices net to Contractors unless otherwise shown. Carload lots only.

	Bunker per ton	Del'd per ton
Gravel, all sizes	\$2.44	\$2.90
Top Sand	2.38	3.13
Concrete Mix	2.38	3.06
Crushed Rock, 1/2" to 3/4"	2.38	2.90
Crushed Rock, 3/4" to 1 1/4"	2.38	2.90
Roofing Gravel	2.81	2.90
River Sand	2.50	3.00
Sand—		
Lepus (Nos. 2 & 4)	3.56	3.94
Olympic (Nos. 1 & 2)	3.56	3.88

Cement—  
Common (all brands, paper sacks), carload lots, \$3.55 per bbl, f.o.b. car; delivered \$3.60.  
Per Sack, small quantity (paper) ..... \$1.05  
Carload lots, in bulk per bbl. .... 2.79  
Cash discount on carload lots 10c x bbl, 10th Prox., less than carload lots \$4.00 per bbl f.o.b. warehouse or delivered.  
Cash discount 2% on L.C.L.

Trinity White } 1 to 100 sacks, \$3.13 sack  
Medusa White } warehouse or del.; \$7.56  
bbl. carload lots.

### CONCRETE READY-MIX—

1-2-4 mix, 1 to 10 yards ..... \$12.00  
10 to 100\* yards ..... 11.00  
100 to 500 yards ..... 10.50  
Over 500 yards ..... 10.30  
\* Delivered to site.

### CONCRETE BLOCKS—

	Hay-dite	Be-salt
4x8x16-inches each	\$1.17	\$1.18
6x8x16-inches, each	22	225
8x8x16-inches, each	26	26
12x8x16-inches, each	34	39
12x8x24-inches, each		60
Haydite Aggregates—		
3/4-inch to 3/8-inch, per cu. yd.	\$7.25	
3/8-inch to 1/2-inch, per cu. yd.	7.25	
No. 6 to 0-inch, per cu. yd.	7.25	

### DAMP-PROOFING and Waterproofing—

Two-coat work, \$9.00 per square.  
Membrane waterproofing—4 layers of saturated felt, \$10.00 per square.  
Hot coating work, \$5.00 per square.  
Medusa Waterproofing, \$3.50 per lb. San Francisco Warehouse.  
Tricoal concrete waterproofing, 60c a cubic yd. and up.

**ELECTRIC WIRING—**\$15 to \$20 per outlet for conduit work (including switches).  
Knob and tube average \$6.00 per outlet.

### ELEVATORS—

Prices vary according to capacity, speed and type. Consult elevator companies. Average cost of installing a slow speed automatic passenger elevator in small four story apartment building, including entrance doors, about \$9,500.00.

### EXCAVATION—

Sand, \$1.00; clay or shale, \$1.50 per yard. Trucks, \$30 to \$45 per day.  
Above figures are an average without water. Steam shovel work in large quantities, less; hard material, such as rock will run considerably more.

### FIRE ESCAPES—

Tan-foot galvanized iron balcony, with stairs, \$2.50 installed on new buildings; \$3.00 on old buildings.

### FLOORS—

Asphalt Tile, 1/8 in. gauge 18c to 35c per sq. ft.  
Composition Floors, such as Magnesite, 50c per square foot.  
Linoleum, standard gauge, sq. yd. .... \$2.75  
Mastipave—\$1.50 per sq. yd.  
BattleShip Linoleum—1/8"—\$3.00 sq. yd.  
Terrazo Floors—\$1.50 per sq. ft.  
Terrazo Steps—\$2.50 per lin. ft.  
Mastic War Coat—according to type—20c to 35c.

### Hardwood Flooring—

Oak Flooring—T & G—Unfin.—  
1 1/2" x 2 1/2" 1/2" 3/4" 1/2" 1/2"  
Clear Old, White ..... \$425 \$405 \$ \$ \$  
Clear Old, Red ..... 405 380 \$ \$ \$  
Select Old, Red or White ..... 355 340 \$ \$ \$  
Clear Plan, Red or White ..... 355 340 335 315 \$ \$ \$ \$  
Select Plan, Red or White ..... 340 330 325 300 \$ \$ \$ \$  
#1 Common, Red or White ..... 315 310 305 280 \$ \$ \$ \$  
#2 Common, Red or White 305

### Prefinished Oak Flooring—

	Prime	Standard
1/2 x 2	\$369.00	\$359.00
1/2 x 2 1/2	380.00	370.00
3/4 x 2 1/2	390.00	381.00
3/4 x 2 3/4	375.00	355.00
3/4 x 3/4	395.00	375.00
3/4 x 2 1/4 3/4 Ranch Plank	375.00	375.00
	315	415.00

### Unfinished Maple Flooring—

1 1/2" x 2 1/4 1st Grade	\$390.00
1 1/2" x 2 1/4 2nd Grade	365.00
1 1/2" x 2 1/4 2nd & 8tr. Grade	375.00
1 1/2" x 2 1/4 3rd Grade	240.00
1 1/2" x 3/4 3rd & 8tr. Jld. EM.	380.00
1 1/2" x 3/4 2nd & 8tr. Jld. EM.	390.00
33/32 x 2 1/4 1st Grade	400.00
33/32 x 2 1/4 2nd Grade	365.00
33/32 x 2 1/4 3rd Grade	320.00
Floor Layer Wage \$2.50 hr.	

### GLASS—

Single Strength Window Glass ..... \$ .30 per sq. ft.  
Double Strength Window Glass ..... .45 per sq. ft.  
Plate Glass, 1/4 polished to 75 ..... 1.60 per sq. ft.  
75 to 100 ..... 1.74 per sq. ft.  
1/4 in. Polished Wire Plate Glass ..... 2.35 per sq. ft.  
1/4 in. Rgh. Wire Glass ..... .71 per sq. ft.  
1/4 in. Polished Wire Plate Glass ..... 2.00 per sq. ft.  
1/4 in. Rgh. Wire Glass ..... .64 per sq. ft.  
1/4 in. Obscure Glass ..... .40 per sq. ft.  
3/8 in. Obscure Glass ..... .64 per sq. ft.  
1/8 in. Heat Absorbing Obscure ..... .58 per sq. ft.  
1/4 in. Heat Absorbing Wire ..... .86 per sq. ft.  
Glazing of above additional \$1.15 to .30 per sq. ft.  
Glass Blocks, set in place ..... 3.50 per sq. ft.

### HEATING—

Average, \$3.50 to \$4.00 per sq. ft. of radiation, according to conditions.  
Warm air (gravity) average \$64 per register.  
Forced air average \$91 per register.





# ARCHITECT AND ENGINEER ESTIMATOR'S DIRECTORY

## Building and Construction Materials

EXPLANATION—Building and construction materials are shown in major classified groups for general identification purposes with names and addresses of suppliers of materials listed in detail under group classification where name first appears—main offices are shown first with branch or district offices following. The numeral appearing in listings refers to the major group classification where complete data on the dealer, or representative, may be found.

### AIR CONDITIONING (b)

Air Conditioning & Cooling  
UTILITY APPLIANCE CORP.  
Los Angeles 58, 4851 S. Alameda St.  
San Francisco, 1355 Market St., UN 1-4908

### ARCHITECTURAL VENEER (a)

Ceramic Veneer  
PACIFIC CLAY PRODUCTS  
San Francisco: 605 Market St., GA 1-3970  
Los Angeles, Portland, Salt Lake City  
GLADDING, McBEAN & CO. \*(1)

Porcelain Veneer  
PORCELAIN ENAMEL PUBLICITY BUREAU  
(Dept. AE-450)  
Room 601, Franklin Building, Oakland 12, California  
P. O. Box 186, East Pasadena Station, Pasadena 8, California  
Irradiated Veneer  
VERMONT MARBLE COMPANY  
San Francisco 5: 525 Market Street, SU 1-6747  
Los Angeles 4: DU 2-7834  
Marble Veneer  
VERMONT MARBLE COMPANY  
San Francisco 5: 525 Market Street, SU 1-6747  
Los Angeles 4: DU 2-7834

ANKS-FINANCING (1b)  
CROCKER FIRST NATIONAL BANK OF S. F.  
San Francisco, Post & Montgomery Sts., EX 2-7700

### RASS PRODUCTS (1a)

GREENBERG'S, M. & SONS  
San Francisco, Calif.: 765 Folsom, EXbrook 2-3143

BRICK  
GLADDING, McBEAN & CO.  
San Francisco: Harrison at 9th Sts., UN 1-7400  
Los Angeles: 2901 Los Feliz Blvd., OL 2121  
Offices at Portland, Seattle, Spokane  
KRAFTILE  
Niles, California, Niles 3611  
San Francisco 5: 55 Hawthorne St., DO 2-3780  
Los Angeles 13: 406 South Main St., MU 7241  
REMILLARD-DANDINI CO.  
San Francisco: 400 Montgomery St., EX 2-4988

### RONZE PRODUCTS (1b)

GREENBERG'S M. & SONS  
San Francisco, Calif.: 765 Folsom, EXbrook 2-3143

### UILDING PAPER & FELTS (2)

SISALKRAFT COMPANY  
San Francisco: 55 New Montgomery St., EX 2-3066  
Chicago, Ill.: 205 West Wacker Drive  
ANGIER PACIFIC CORP.  
San Francisco 5: 55 New Montgomery St., DO 2-4416  
Los Angeles: 7424 Sunset Boulevard

### UILDING HARDWARE (3)

THE STANLEY WORKS  
San Francisco: Monastnock Bldg., BU 6-5914  
New Britain, Conn.

### EMENT (c)

PACIFIC PORTLAND CEMENT  
San Francisco: 417 Montgomery St., GA 1-4100

### ONCRETE AGGREGATES (4)

Lightweight Aggregates  
AMERICAN PERLITE CORP.  
Richmond, Calif.: 26th & B Sts.—Yard 2, RI 4307

### DOORS (4a)

Hollywood Doors  
WEST COAST SCREEN CO.  
Los Angeles: 1127 E. 63rd St. AD 1-1108  
Distributors:

W. P. FULLER CO.  
Seattle, Tacoma, Portland  
NICOLAI DOOR SALES CO.  
San Francisco: 3045 19th St.  
T. M. COBB CO.  
Los Angeles & San Pedro  
SOUTHWEST SASH & DOOR  
Phoenix, Arizona  
HOUSTON SASH & DOOR  
Houston, Texas

Screen Doors  
WEST COAST SCREEN CO.  
(See Hollywood Door listing above)

### FIRE ESCAPES (5)

SOULE STEEL  
San Francisco: 1750 Army St., VA 4-4141  
Los Angeles, Calif.—LA 0911  
Portland, Ore.—BE 5155  
Seattle, Wash.—SE 3010  
MICHAEL & PFEFFER IRON WORKS, INC.  
San Francisco 3: Tenth & Harrison Sts., MA 1-5966

### FIREPLACES (5a)

Heat Circulating  
SUPERIOR FIREPLACE CO.  
Los Angeles: 1708 E. 15th St. PR 8393  
Baltimore, Md.: 601 No. Point Rd.

### FLOORS (1b)

Hardwood Flooring  
HOGAN LUMBER COMPANY  
Oakland: Second and Alice Sts., GL 1-6861  
E. K. WOOD LUMBER CO.  
Los Angeles: 4710 S. Alameda St., JE 3111  
Oakland: 727 Kennedy St., KE 4-8466  
Portland: 827 Terminal Sales Building  
Floor Treatment & Maintenance  
HILLYARD SALES CO. (Western)  
470 Alabama St., San Francisco, MA 1-7766  
Los Angeles, 923 E. 3rd, TRinity 8282  
Seattle, 3440 E. Marginal Way

### GLASS (7)

W. P. FULLER COMPANY  
San Francisco: 301 Mission St., EX 2-7151  
Los Angeles, Calif.  
Portland, Oregon

### HEATING (8)

HENDERSON FURNACE & MFG. CO.  
Sebastopol, Calif.  
S. T. JOHNSON CO.  
Oakland 8: 940 Arlington Ave., OL 2-6000  
San Francisco: 585 Potrero Ave., MA 1-2757  
Philadelphia 8, Pa.: 401 No. Broad St.

### SCOTT COMPANY

San Francisco: 243 Minna St., YU 2-0400  
Oakland: 113 - 10th St., GL 1-1937  
San Jose, Calif.  
Los Angeles, Calif.  
ELECTROMODE CORP.  
Rochester, N. Y.

### Electric Heaters

San Francisco: 1355 Market St., KL 2-2311  
Northern California Distributors  
GENERAL ELECTRIC SUPPLY CORP.  
San Francisco: 1201 Bryant St., UN 3-4000  
Emeryville: 5400 Hollis St., OL 3-4433  
Sacramento: 1131 S St., GI 3-9001  
Fresno: 1234 O St., Fresno 4-4746  
INCANDESCENT SUPPLY COMPANY  
Redding: 2146 Pine St., Redding 200  
THOMAS B. HUNTER (Designer)  
San Francisco: 41 Sutter St., GA 1-1164

### UTILITY APPLIANCE CORP. \*(b)

INSULATION AND WALLBOARD (9)  
LUMBER MANUFACTURING CO.  
San Francisco: 225 Industrial Ave., JU 7-1760  
SISALKRAFT COMPANY \*(2)  
WESTERN ASBESTOS COMPANY  
San Francisco: 675 Townsend St., KL 2-3868  
Oakland: 251 Fifth Avenue, GL 1-2345  
Sacramento: 1224 I Street, 2-8993  
Stockton: 1120 E. Weber Ave., 4-1863  
Fresno: 1837 Marced Street, 3-3277  
San Jose: 201 So. Market St., BA 4359-J

IRON—Ornamental (10)  
MICHEL & PFEFFER IRON WORKS, INC. \*(5)

### LANDSCAPE (11a)

Landscape Contractors  
HENRY C. SOTO CORPN.  
Los Angeles, 13000 S. Avalon Blvd. ME 4-6617

### LIGHTING FIXTURES (11)

SMOOTH-HOLMAN COMPANY  
Inglewood, Calif., OR 8-1217  
San Francisco: 55 Mississippi St., MA 1-8474

### LUMBER (12)

HOGAN LUMBER COMPANY \*(6)  
LUMBER MANUFACTURING CO. \*(9)  
E. K. WOOD LUMBER CO \*(6)  
Shingles  
SIDEWALL LUMBER COMPANY  
San Francisco 24: 1995 Oakdale Ave., AT 2-8112

### MARBLE (13)

VERMONT MARBLE COMPANY  
San Francisco: 525 Market St., SU 1-6747  
Los Angeles 4: 3522 Council St., DU 2-7834

### METAL LATH EXPANDED (14)

FORDEYER CORNICE WORKS  
San Francisco: 269 Potrero Ave., HE 1-4100  
SOULE STEEL \*(5)

### MILLWORK (15)

PACIFIC MANUFACTURING COMPANY  
San Francisco: 16 Beale St., GA 1-7755  
Santa Clara: 2610 The Alameda, SC 607  
Los Angeles: 6820 McKinley Ave., TH 4196  
MULLEN MANUFACTURING COMPANY  
San Francisco: 650 Raush St., UN 1-5815  
LUMBER MANUFACTURING COMPANY \*(9)

### PAINTING (16)

Paint  
W. P. FULLER COMPANY \*(7)

### PLASTER (17)

Exteriors  
PACIFIC PORTLAND CEMENT COMPANY \*(4)  
Interiors—Metal Lath & Trim  
FORDEYER CORNICE WORKS \*(14)

### PLASTIC CEMENT (f)

PACIFIC PORTLAND CEMENT CO.  
San Francisco: 417 Montgomery St., GA 1-4100

### PLUMBING (18)

THE SCOTT COMPANY \*(8)  
THE HALSEY TAYLOR COMPANY  
Redlands, Calif.  
Warren, Ohio  
HAWKS DRINKING FAUCET COMPANY  
Berkeley 10: 1435 Fourth St., LA 5-3341  
CONTINENTAL WATER HEATER COMPANY  
Los Angeles 31: 1801 Pasadena Ave., CA 6178

**SIMONDS MACHINERY COMPANY**

San Francisco: 816 Folsom St., DO 2-6794  
Los Angeles: 455 East 4th St., MU 8322

**SECURITY VALVE COMPANY**

Los Angeles 31: 410 San Fernando Rd., CA 6191

**SEWER PIPE (19)**

GLADDING, McBEAN & CO. \*(1)

**PACIFIC CLAY PRODUCTS**

San Francisco: 605 Market St., GA 1-3970  
Los Angeles, Portland, Salt Lake City

**SHEET METAL (20)**

**Windows**

**DETROIT STEEL PRODUCTS COMPANY**

Oakland 8: 1310 - 63rd St., OL 2-8826  
San Francisco: Russ Building, DO 2-0890

**MICHEL & PFEFFER IRON WORKS, INC. \*(5)**

SOULE STEEL COMPANY \*(5)

**Fire Doors**

**DETROIT STEEL PRODUCTS COMPANY**

**Stylights**

**DETROIT STEEL PRODUCTS COMPANY**

**STEEL—STRUCTURAL (21)**

**COLUMBIA STEEL CO.**

San Francisco: Russ Bldg., SU 1-2500  
Los Angeles: 2087 E. Slauson, LA 1171  
Portland: 2345 N. W. Nicolai, BE 7261  
Seattle: 1331 3rd Ave. Bldg., MA 1972  
Salt Lake City: Walker Bank Bldg., SL 3-6733

**HERRICK IRON WORKS**

Oakland: 18th & Campbell Sts., GL 1-1747

**JUDSON PACIFIC-MURPHY CORP.**

Emeryville: 4300 Eastshore Highway, OL 3-1717

**REPUBLIC STEEL CORP.**

San Francisco: 116 N. Montgomery St., GA 1-0977  
Los Angeles: Edison Building  
Seattle: White-Henry-Stuart Building  
Salt Lake City: Walker Bank Building  
Denver: Continental Oil Building  
KRAFTITE COMPANY \*(1)  
SAN JOSE STEEL COMPANY  
San Jose: 195 North Thirtieth St., CO 4184

**STEEL—REINFORCING (22)**

REPUBLIC STEEL CORP. \*(21)

HERRICK IRON WORKS \*(21)

SAN JOSE STEEL CO. \*(21)

COLUMBIA STEEL CO. \*(21)

**TILE (23)**

GLADDING, McBEAN & CO. \*(1)

PACIFIC CLAY COMPANY \*(1)

PACIFIC CLAY PRODUCTS

San Francisco: 605 Market St., GA 1-3970

Los Angeles, Portland, Salt Lake City

**TIMBER—REINFORCING (b)**

**Trusses**

WEYERHAEUSER SALES CO.

Tacoma, Wash.

St. Paul, Minn.

Newark, N. J.

Treated Timber

J. H. BAXTER CO.

San Francisco 4: 333 Montgomery St., DO 2-3883

Los Angeles 13: 601 West Fifth St., MI 6294

**WALL TILE (24)**

GLADDING, McBEAN & CO. \*(1)

KRAFTITE COMPANY \*(1)

**WINDOWS STEEL (25)**

DETROIT STEEL PRODUCTS CO. \*(20)

MICHEL & PFEFFER IRON WORKS, INC.

SOULE STEEL COMPANY \*(5)

**GENERAL CONTRACTORS (26)**

BARRETT & HILP

San Francisco: 918 Harrison St., DO 2-0700

Los Angeles: 234 W. 37th Place, AD 3-8161

DINWIDDIE CONSTRUCTION COMPANY

San Francisco: Crocker Building, YU 6-2718

CLINTON CONSTRUCTION COMPANY

San Francisco: 923 Folsom St., SU 1-3440

MATCOCK CONSTRUCTION COMPANY

San Francisco: 604 Mission St., GA 1-5516

PARKER, STEFFENS & PEARCE

San Francisco: 135 So. Park, EX 2-6639

STOLTE, INC.

Oakland: 8451 San Leandro Blvd., TR 2-1066

SWINERTON & WALBERG COMPANY

San Francisco: 225 Bush St., GA 1-2980

Oakland: 1723 Webster St., HI 4-4322

Los Angeles, Sacramento, Denver

P. J. WALKER COMPANY

San Francisco: 391 Sutter St., YU 6-5916

Los Angeles: 714 W. Olympic Blvd., RI 7-55

**TESTING LABORATORIES**

(ENGINEERS & CHEMISTS) (27)

ABBOT A. HANKS, INC.

San Francisco: 624 Sacramento St., GA 1-16

ROBERT W. HUNT COMPANY

San Francisco: 251 Kearny St., EX 2-4634

Los Angeles: 3050 E. Slauson, JE 9131

Chicago, New York, Pittsburgh

PITTSBURGH TESTING LABORATORY

San Francisco: 651 Howard St., EX 2-1747

**BUILDING TRADES WAGE (JOB SITES) NORTHERN, CENTRAL AND SOUTHERN CALIFORNIA**

ATTENTION: The following are the PREVAILING hourly rates of compensation being paid and in effect by employers by agreement between employees and their union; or as recognized and determined by the U. S. Department of Labor. [Revised to March 1, 1951.]

CRAFT	San Francisco		Alameda		Contra Costa		Fresno		Sacramento		San Joaquin		Santa Clara		Solano		Los Angeles		San Bernardino		San Diego		Santa Barbara		Kern	
	\$2.50	\$2.50	\$2.50	\$2.50	\$2.50	\$2.50	\$2.50	\$2.50	\$2.50	\$2.50	\$2.50	\$2.50	\$2.50	\$2.50	\$2.50	\$2.50	\$2.25	\$2.25	\$2.25	\$2.25	\$2.25	\$2.25	\$2.25	\$2.25	\$2.25	
ASBESTOS WORKERS	2.50	2.50	2.50	2.50	2.50	2.50	2.50	2.50	2.50	2.50	2.50	2.50	2.50	2.50	2.50	2.50	2.25	2.25	2.25	2.25	2.25	2.25	2.25	2.25	2.25	
BOILERMAKERS	2.53	2.53	2.53	2.53	2.53	2.53	2.53	2.53	2.53	2.53	2.53	2.53	2.53	2.53	2.53	2.53	2.25	2.25	2.25	2.25	2.25	2.25	2.25	2.25	2.25	
BRICKLAYERS	3.25**	3.15*	3.15	2.85	3.25	3.00	3.00	3.25	3.00	3.25	3.00	3.25	3.00	3.25	3.00	3.25	2.625	2.625	2.625	2.625	2.625	2.625	2.625	2.625	2.625	
CRACKLAYERS, HODCARRIERS	2.45	2.45	2.45	2.00	2.40	2.25	2.375	2.40	2.25	2.375	2.40	2.25	2.375	2.40	2.25	2.375	2.20	2.20	2.20	2.20	2.20	2.20	2.20	2.20	2.20	
CARPENTERS	2.325	2.325	2.175	2.175	2.175	2.175	2.175	2.175	2.175	2.175	2.175	2.175	2.175	2.175	2.175	2.175	2.20	2.20	2.20	2.20	2.20	2.20	2.20	2.20	2.20	
CEMENT FINISHERS	2.20	2.20	2.20	2.20	2.20	2.20	2.20	2.20	2.20	2.20	2.20	2.20	2.20	2.20	2.20	2.20	2.28	2.28	2.28	2.28	2.28	2.28	2.28	2.28	2.28	
ELECTRICIANS	2.75	2.60	2.40	2.75	2.50	2.50	2.50	2.50	2.50	2.50	2.50	2.50	2.50	2.50	2.50	2.50	2.50	2.50	2.50	2.50	2.50	2.50	2.50	2.50	2.50	
ELEVATOR CONSTRUCTORS	2.75	2.75	2.75	2.75	2.75	2.75	2.75	2.75	2.75	2.75	2.75	2.75	2.75	2.75	2.75	2.75	2.25	2.25	2.25	2.25	2.25	2.25	2.25	2.25	2.25	
ENGINEERS: MATERIAL HOIST	2.19	2.19	2.19	2.19	2.19	2.19	2.19	2.19	2.19	2.19	2.19	2.19	2.19	2.19	2.19	2.19	1.9875	1.9875	1.9875	1.9875	1.9875	1.9875	1.9875	1.9875	1.9875	
GLAZIERS	2.30	2.30	2.30	2.30	2.30	2.08	2.30	2.08	2.30	2.08	2.30	2.08	2.30	2.08	2.30	2.08	2.00	2.00	2.00	2.00	2.00	2.00	2.00	2.00	2.00	
IRON WORKERS: ORNAMENTAL	2.425	2.425	2.425	2.425	2.425	2.425	2.425	2.425	2.425	2.425	2.425	2.425	2.425	2.425	2.425	2.425	2.255	2.255	2.255	2.255	2.255	2.255	2.255	2.255	2.255	
REINF. RODMEN	2.375	2.375	2.375	2.375	2.375	2.375	2.375	2.375	2.375	2.375	2.375	2.375	2.375	2.375	2.375	2.375	2.28	2.28	2.28	2.28	2.28	2.28	2.28	2.28	2.28	
STRUCTURAL	2.575	2.575	2.575	2.575	2.575	2.575	2.575	2.575	2.575	2.575	2.575	2.575	2.575	2.575	2.575	2.575	2.30	2.30	2.30	2.30	2.30	2.30	2.30	2.30	2.30	
LABORERS: BUILDING	1.65	1.65	1.65	1.55	1.65	1.65	1.65	1.65	1.65	1.65	1.65	1.65	1.65	1.65	1.65	1.65	1.65	1.65	1.65	1.65	1.65	1.65	1.65	1.65	1.65	
CONCRETE	1.65	1.65	1.65	1.55	1.65	1.65	1.65	1.65	1.65	1.65	1.65	1.65	1.65	1.65	1.65	1.65	1.65	1.65	1.65	1.65	1.65	1.65	1.65	1.65	1.65	
LATHERS	3.00	3.00*	3.00*	2.75	2.875	2.75	3.00	2.8125	2.50	2.50	2.50	2.50	2.50	2.50	2.50	2.50	2.50	2.50	2.50	2.50	2.50	2.50	2.50	2.50	2.50	
MARBLE SETTERS	2.60	2.60	2.60	2.60	2.60	2.60	2.60	2.60	2.60	2.60	2.60	2.60	2.60	2.60	2.60	2.60	2.25	2.25	2.25	2.25	2.25	2.25	2.25	2.25	2.25	
MOSAIC & TERRAZZO	2.375	2.375	2.375	2.375	2.375	2.375	2.375	2.375	2.375	2.375	2.375	2.375	2.375	2.375	2.375	2.375	2.40	2.40	2.40	2.40	2.40	2.40	2.40	2.40	2.40	
PAINTERS	2.45**	2.45	2.45	2.15	2.45	2.275	2.45	2.275	2.45	2.45	2.275	2.45	2.45	2.275	2.45	2.275	2.22	2.22	2.22	2.22	2.22	2.22	2.22	2.22	2.22	
PILEDRIVERS	2.325	2.325	2.325	2.325	2.325	2.325	2.325	2.325	2.325	2.325	2.325	2.325	2.325	2.325	2.325	2.325	2.325	2.325	2.325	2.325	2.325	2.325	2.325	2.325	2.325	
PLASTERERS	3.00	3.15*	3.15	2.75	3.00	3.00	3.125	3.00*	2.50	2.50	2.50	2.50	2.50	2.50	2.50	2.50	2.50	2.50	2.50	2.50	2.50	2.50	2.50	2.50	2.50	
PLASTERERS, HODCARRIERS	2.60	2.80	2.80	2.50	2.40	2.80	2.75	2.50	2.45	2.45	2.45	2.45	2.45	2.45	2.45	2.45	2.15	2.15	2.15	2.15	2.15	2.15	2.15	2.15	2.15	
SPRINKLER FITTERS	2.625	2.625	2.625	2.625	2.625	2.625	2.625	2.625	2.625	2.625	2.625	2.625	2.625	2.625	2.625	2.625	2.625	2.625	2.625	2.625	2.625	2.625	2.625	2.625	2.625	
STEAMFITTERS	2.625	2.625	2.625	2.625	2.625	2.625	2.625	2.625	2.625	2.625	2.625	2.625	2.625	2.625	2.625	2.625	2.625	2.625	2.625	2.625	2.625	2.625	2.625	2.625	2.625	
TRUCK DRIVERS—1/2 Ton or less	1.58	1.58	1.58	1.58	1.58	1.58	1.58	1.58	1.58	1.58	1.58	1.58	1.58	1.58	1.58	1.58	1.58	1.58	1.58	1.58	1.58	1.58	1.58	1.58	1.58	
TILESETTERS	2.875	2.875	2.875	2.50	2.875	2.875	2.875	2.875	2.875	2.875	2.875	2.875	2.875	2.875	2.875	2.875	2.50	2.50	2.50	2.50	2.50	2.50	2.50	2.50	2.50	

\* 6 Hour Day. \*\* 7 Hour Day.

Prepared and compiled by:

## TIPS ON PAINTING

(From Page 9)

tilation is desirable. A survey of ventilating equipment with these factors in mind should be made before hot weather starts. The Division of Industrial Hygiene in many states provides ventilating engineers.

Those painters are well off who have the blessed chance of working in an air-cooled room during excessively hot days. A drastic change of temperature is of no avail. Twenty degrees F. below outside temperatures are very pleasant and there is no danger of catching cold. The cool atmosphere and the resulting cool poise of everyone living and working in the room, are good for the nerves of the inmates as well as for their heart.

### Combating High Temperatures

Of the numerous methods suggested for combating high temperatures and their ill effects, ten have been appraised as useful by Skinner and Pierce. They had studied working conditions in a number of New England plants where hot processes are employed during the summer months. Salt tablets or drinking a 0.1 per cent salt solution were widely used. To produce cooling air motion, circulating fans were in use. An improvement on that method is general exhaust ventilation. In many cases the source of heat is concentrated over small areas; here local exhaust hoods, properly insulated to prevent re-radiation, are useful. It might be desirable to provide supply air, either from outdoors directly, or cooled by water sprays. To reduce radiant heat, baffles can be installed between high temperature sources of heat and the workers.

Any enclosed humid process is preferable to an open one from a health standpoint. Often a considerable amount of hot surface can be insulated. Adjustment of the working hours to avoid the hotter part of the day has some merit. In a few of the plants the men were allowed to go home at noon on days when the outside temperature rose much over 90° F. Sometimes water was sprayed on the roof to lessen the heat and the temperature of the air near the ceiling. Increased salt intake in work-

ers who perspire freely, has been provided for in many plants. However let's emphasize that the replacement of the lost liquid by drinking water is indispensable and cannot be replaced by salt tablets or anything else.

### Food in Summer

Another point, formerly approved, seems doubtful according to recent studies. Fruits, vegetables, salads are appropriate during a heat wave, only little fat. But why less protein? Protein-containing food are meat, eggs, vegetables, etc. The statement that the specific dynamic action of protein is greater than that of carbohydrates (bread, sugar, rice, potatoes, flour, etc.) and fats (butter, margarine, lard)—and that, therefore, we should eat less protein in hot weather, has been disproved by Forbes and Swift. Painters who have physical exertion on hot days, need their normal three meals a day. The energy needed for doing an efficient job has to be delivered from food rich in energies.

Plant managers anxious to keep up production through the "dog days," A. R. Smith suggests, would do well to supply milk, fruit and fruit juices for extra between-meal "pick ups" to their workers. Plant cafeterias should see to it that these foods are plentiful available.

Loose, thin, non-constricting clothes are useful, open at the neck so that body vapors can escape easily. White and yellow colors of the clothes are best to reflect and keep off the sun's heat rays. Holding the wrists under running cold water is extremely refreshing. Showers, of course, in industrial plants, are extremely helpful for all workers on hot days.

### NAVY CONVERTING DWELLING UNITS

Forty duplex dwellings at the U. S. Naval Air Station in Alameda are being converted into single family quarters at a cost of \$194,768.

PRELIMINARY drawings are underway for the construction of a new Junior High School in San Rafael, California.

# CLASSIFIED ADVERTISING

RATE: 20¢ PER WORD . . . CASH WITH ORDER

MINIMUM \$5.00

**PLANNING CHURCH BUILDINGS.** Portfolio—64 oversized pages 144 cuts; floor plans, exterior and interior views; recently planned buildings costing \$30,000 upward. Largest collection plans of Protestant churches assembled. Price \$2.00 p.p. WRITE Bureau of Architecture, 300 Fourth Ave., New York 10, N. Y.

**GET THE BEST,** don't be satisfied with anything but the best. Window sash, Doors, Cabinets, etc. Town Talk Sash & Door Mill, 524 9th St., Sacramento.

**BUILDERS!** You can make more money; get information you need before it is published elsewhere; Subscribe to the daily ARCHITECTS REPORTS, only \$10.00 per month. Complete information from ARCHITECTS REPORTS, 68 Post Street, San Francisco. Phone DOUGLAS 2-8311.

**PHOTOGRAPHY.** For the best in construction photography, including exterior and interior, aerial, and progress views . . . you will find as many others have that it's the SKELTON STUDIO'S, 137 Harlan Place, San Francisco. Telephone YUKON 6-6321.

**WANTED:** Experienced specification writer and building estimator by San Francisco ARCHITECT. Write WE 1-6. c/o ARCHITECT & ENGINEER, 68 Post Street, S. F.

**FLOOR COVERINGS** for industrial, commercial, and residential construction. Complete lines, one of the oldest, best established organizations in the Sacramento Valley. LATTIN'S, INC., 1519 Alhambra Blvd., Sacramento.



## CONSTRUCTION CONTRACTS AWARDED AND MISCELLANEOUS PERSONNEL DATA

**AUDITORIUM REMODEL**, Redwood City, San Mateo County, Sequoia Union High School District, owner, \$42,116. ARCHITECT: Blanchard, Maher & Paulus, San Francisco. GENERAL CONTRACTOR: Julian N. Basin, Menlo Park.

**STORE BUILDING**, San Jose, Santa Clara County, Melville T. Gellert, owner, 3 stores, \$38,233. DRAFTSMAN: George Mu, Berkeley, 1 story, concrete tilt up construction. GENERAL CONTRACTOR: Thos. Ellingson, San Francisco.

**MISSION BRANCH BANK REMODEL**, San Francisco. Bank of California, owner, \$150,000. ARCHITECT: Clark & Buetler, San Francisco, interior remodel new mezzanine, floor, etc. GENERAL CONTRACTOR: Dinwiddie Construction Co., San Francisco.

**STORE BUILDING ADDITION & REMODEL**, Marysville, Yuba County, National Dollar Stores, Ltd., owner, \$76,109. ARCHITECT: O. A. Deichman, San Francisco, rear addition, reinforced concrete construction, interior & exterior remodel & new store front. GENERAL CONTRACTOR: Peter Sartorio, San Francisco.

**GRAMMAR SCHOOL**, Willow Creek, Humboldt County, Trinity Valley Joint Union Elementary School District, owner, 5 classrooms, administration, kindergarten, toilet room, \$197,910. ARCHITECT: Frank T. Googreson, Eureka, frame construction. GENERAL CONTRACTOR: A. C. Johnson, Eureka.

**LOW INCOME HOUSING UNITS**, Winters, Yolo County, Yolo County Housing Authority, owner, 30 units, \$199,760. ARCHITECT: Joseph Milano, Berkeley, 1 story, duplex residences, frame & stucco construction. GENERAL CONTRACTOR: E. Philip Merritt, Inc., San Rafael.

**ABRAHAM LINCOLN HIGH SCHOOL ADDITION**, San Francisco. City and County of S. F., owner, auditorium wing, girl's gym, library, boy's gym, auto shop, athletic field, \$3,649,412. ARCHITECT: Weihe, Frick & Kruse, San Francisco, reinforced concrete construction. GENERAL CONTRACTOR: M. & R. Corp., San Francisco.

**NAVY HOUSING PROJECT**, Stockton, San Joaquin County, U. S. Navy, owner, 43 units, Wherry Act, \$379,736. ARCHITECT: Angus McSweeney, San Francisco, frame construction. GENERAL CONTRACTOR: Pickard Construction Co., Long Beach.

**HOLY SPIRITS PAROCHIAL SCHOOL ADDITION**, Sacramento, Sacramento County, Roman Catholic Diocese of Sacramento, owner, 4 classrooms, & toilet room, \$50,000. ARCHITECT: Borovetto & Thomas, Sacra-

mento, concrete pre-fab construction. GENERAL CONTRACTOR: Lewis Bennett, Sacramento.

**HIGH SCHOOL ADDITION**, Parterville, Tulare County, Parterville Union High School District, owner, 12 classrooms, \$272,000. ARCHITECT: Robert C. Koestner, Visalia, economics, agricultural shop, multipurpose room. GENERAL CONTRACTOR: Trewthitt, Shields & Fisher, Fresno.

**GRAMMAR SCHOOL**, Forest Hill, Placer County, Forest Hill Union Elementary School District, owner, 5 classrooms, offices, kindergarten, multi-purpose & toilet rooms, \$219,990. ARCHITECT: Gordon Stafford, Sacramento, frame & stucco construction. GENERAL CONTRACTOR: G. S. Herrington, Auburn.

**FIRE HOUSE**, Martinez, Contra Costa County, City of Martinez, owner, \$99,947. ARCHITECT: Confer & Willis, Oakland, 1 story, brick & light steel frame construction. GENERAL CONTRACTOR: Henry Brodsky, Walnut Creek.

**NEW HIGH & ELEMENTARY SCHOOL BUILDING**, Downville, Sierra County, Downville Unified School District, owner, 6 classrooms, administration, shop, clinic, toilet room, \$170,065. ARCHITECT: Chas. F. Dean, Sacramento, reinforced concrete frame & stucco construction. GENERAL CONTRACTOR: W. E. Frye, Grass Valley.

**OAK AVENUE GRAMMAR SCHOOL**, Sacramento, Sacramento County, Sylvan Elementary School District, owner, 9 classrooms, administration, multi-purpose, kitchen, kindergarten & toilet room, \$283,823. ARCHITECT: Chas. F. Dean, Sacramento, reinforced concrete frame & stucco construction. GENERAL CONTRACTOR: Lawrence Construction Co., Sacramento.

**WILLIAMS GRAMMAR SCHOOL ADDITION**, Concord, Contra Costa County, Mt. Diablo Unified School District, owner, 4 classrooms, administration, multi-use, library & toilet rooms, \$280,153. ARCHITECT: Reynolds & Chamberlain, Anderson & Simonds, Confer & Willis & John Lyon Reid, Oakland, 1 story, 19,760 sq. ft., frame & stucco construction. GENERAL CONTRACTOR: A. F. Stewart, Berkeley.

**NEW MEADOW HOMES GRAMMAR SCHOOL**, Concord, Contra Costa County, Mt. Diablo Unified School District, owner, 11 classrooms, kindergarten, administration, multi-purpose rooms & toilet rooms, \$310,882. ARCHITECT: Reynolds & Chamberlain, Anderson & Simonds, Confer & Willis & John Lyon Reid, Oakland, 1 story, 24,475 sq. ft., frame & stucco construction. GENERAL CONTRACTOR: Central-Stare Construction Co., San Francisco.

**STORE BUILDING ADDITION**, Berkeley, Alameda County, National Dollar Stores, Ltd., owner, \$108,495. ARCHITECT: O. A. Deichman, San Francisco, Rear addition, reinforced concrete construction, interior and exterior remodel, and new store front. GENERAL CONTRACTOR: A. J. Hopper, San Francisco.

**CAFETERIA BUILDING**, Fresno, Fresno County, Fresno Board of Education, owner, \$97,487. ARCHITECT: Walter Wagner, Fresno. GENERAL CONTRACTOR: Larsen-Ratto Construction Co., Fresno.

**HEADQUARTERS BUILDING**, Sacramento, Sacramento County, State of California, owner, Department of Motor Vehicles, \$4,898,833. ARCHITECT: Milton Plueger, San Francisco, 3 story and part 1 story, approx-

imately 300,000 sq. ft., reinforced concrete construction, penthouse, aluminum shag, composition roof, sectional metal partitions, hollow tile, metal stud partitions, appurtenant facilities, 1 service and passenger elevator. GENERAL CONTRACTOR: Williams & Burrows & Carl Swenson, Burlingame.

**ELEMENTARY SCHOOL "B" ADDITION UNIT 3**, Palo Alto, Santa Clara County, Palo Alto Unified School District, owner, 6 classrooms, toilet rooms, \$101,695. ARCHITECT: Birge M. Clark & Walter Stormquist, Palo Alto, Frame and stucco construction. GENERAL CONTRACTOR: Earl W. Emley, Saratoga.

**NORTH PRIMARY SCHOOL ADDITION**, Corcoran, Kings County, Corcoran Elementary School District, owner, 8 classrooms, administration, 2 kindergartens, cafeteria, toilet rooms, \$443,997. ARCHITECT: H. L. Gogerty, Los Angeles, Frame and stucco construction, steel arch, concrete and asphalt tile floors. GENERAL CONTRACTOR: Larsen-Ratto Construction Company, Fresno.

**NEW GRAMMAR SCHOOL**, Orland, Glenn County, Orland Joint Union Elementary School District, owner, 6 classrooms, administration, toilet rooms, \$129,354. ARCHITECT: Lawrence G. Thomson, Chico, Frame and stucco construction. GENERAL CONTRACTOR: Berlinger Construction Co., Chico.

**MCINLEY GRAMMAR SCHOOL ADDITION**, Petaluma, Sonoma County, Petaluma Elementary School District, owner, 2 classrooms, \$68,653. ARCHITECT: Robert Stanton, Carmel, Frame and stucco construction. GENERAL CONTRACTOR: Vogenson Construction Co., Petaluma.

**HEALTH CENTER**, Fresno, Fresno County, County of Fresno, owner, Primary buildings, \$530,424. ARCHITECT: Phillip Buckingham, Fresno, Type 1 construction, 20,000 sq. ft. GENERAL CONTRACTOR: Harris Construction Co., Fresno.

**GARFIELD JR. HIGH SCHOOL**, Berkeley, Alameda County, Berkeley Board of Education, owner, \$425,830. ARCHITECT: Masten & Hurd, San Francisco, Reinforced concrete construction. GENERAL CONTRACTOR: Zimmer I. Freeby, El Cerrito.

**OFFICE SALES & WAREHOUSE**, Stockton, San Joaquin County, Toy-Holbrook Inc., owner, \$130,000. ARCHITECT: Mayo & Johnson, Stockton, 1 story, 26,000 sq. ft., structural steel frame, wood roof, composition roofing. GENERAL CONTRACTOR: Cannon Construction Co., Stockton.

**PAROCHIAL SCHOOL**, North Sacramento, Sacramento County, Roman Catholic Diocese of Sacramento, owner, Our Lady of Fatima Parish, 5 classrooms, toilet rooms, \$53,950. ARCHITECT: Wallace J. Alexander, Sacramento, Concrete block and frame construction. GENERAL CONTRACTOR: Erickson Construction Co., No. Sacramento.

**HOSPITAL BUILDING**, Chester, Plumas County, Seward Hospital District, owner, 10 beds, \$276,000. ARCHITECT: D. D. Stone & Lou Mulley, San Francisco, Frame construction. GENERAL CONTRACTOR: Frances Construction Co., Santa Rosa.

**NEW GRAMMAR SCHOOL**, Cloverdale, Sonoma County, Cloverdale Unified Elementary School District, owner, 10 classrooms, kindergarten, multi-purpose, toilet rooms, \$332,880. ARCHITECT: Ernest F. Winkler, San Francisco, Frame and stucco construction. GENERAL CONTRACTOR: Myrl R. Crane, San Francisco.

**HIGH SCHOOL ADDITION**, Brentwood, Contra Costa County, Liberty Union High School District, owner, 4 classrooms, heater and toilet rooms, \$80,756. ARCHITECT: Young & Lloyd, Albany, Frame and stucco

## PANACALITE

The Standard for Perlite Aggregates  
An Engineered Product—Engineering  
Service

Air Classified—Sized & Graded for  
Plaster, Concrete & Stucco  
Aggregates

Listed Underwriters' Laboratories  
Re-Examination Service

Fire Ratings:  
Non-Bearing Walls—2 hours  
Floor and Beam—4 hours  
Columns—2 & 3 hours  
Suspended Ceiling—4 hours  
Others

Manufactured by  
**American Perlite Corporation**  
26th & B Sts.—Yard 2—Richmond  
Eacon 5-1385

construction. GENERAL CONTRACTOR: Hancock Construction Co., Lafayette.

**MCKINLEY ELEMENTARY SCHOOL**, Fresno County. McKinley Elementary School District, owner. \$499,453. ARCHITECT: Wm. Hastrup, Fresno. GENERAL CONTRACTOR: Harris Construction Co., Fresno.

**NEW AIRPORT ADMINISTRATION BUILDING**, South San Francisco, San Mateo County. City and County of S. F., owner. \$6,754,000. ARCHITECT: W. P. Day & Assoc., San Francisco. 6 story and control tower, 241,560 sq. ft., 200 x 400, 125 feet high reinforced concrete and steel construction; 4 elevators, marble and terrazzo floors, will contain offices, ticket office, waiting room, baggage room, restaurant, coffee shop and cocktail lounge. GENERAL CONTRACTOR: Clinton Construction Co., San Francisco.

**CHURCH AND CONVENT**, San Francisco. Roman Catholic Archbishop of San Francisco, owner. Corpus Christi Parish, \$429,714. ARCHITECT: Mario J. Ciampi, San Francisco. Reinforced concrete and structural steel construction. GENERAL CONTRACTOR: Jacks & Irvine, San Francisco.

**CHURCH**, San Jose, Santa Clara County. Roman Catholic Archbishop of S. F., owner. 1,000 seating capacity, \$338,000. ARCHITECT: Blanchard, Maher & Paulus, San Francisco. Reinforced concrete construction, steel roof trusses. GENERAL CONTRACTOR: Carl N. Swenson Co., San Jose.

**JOHN ADAMS ELEMENTARY SCHOOL**, Madera, Madera County. **JAMES MADISON SCHOOL**, Madera, Madera County. Madera Elementary School District, owner both schools, \$657,910. ARCHITECT: Chas James, Madera. Frame and stucco construction. GENERAL CONTRACTOR: Clarence Ward, Merced; R. W. Brown Construction Co., Madera.

**BULLARD ELEMENTARY SCHOOL ADDITION**, Fresno, Fresno County. Bullard Elementary School District, owner. 4 classrooms addition, \$113,660. ARCHITECT: Franklin & Simpson, Fresno. Frame and stucco construction. GENERAL CONTRACTOR: L. H. Hansen & Son, Fresno.

**LOW INCOME HOUSING PROJECT**, Woodland, Yolo County. Yolo County Housing Authority, owner. 60 units, \$424,997. ARCHITECT: Barvetto & Thomas, Sacramento. 20 buildings, 1 and 2 story frame and stucco construction. GENERAL CONTRACTOR: Midstate Construction Co., San Francisco.

**DEL MAR ELEMENTARY SCHOOL ADDITION**, Fresno, Fresno County. Fresno Board of Education, owner. ARCHITECT: Beni F. Lippold, Fresno. Frame and stucco construction. GENERAL CONTRACTOR: Walker & Walker, Fresno.

**NEW GRAMMAR SCHOOL**, Graton, Sonoma County. Oak Grove Elementary School District. 8 classrooms, administration, kitchen, \$271,000. ARCHITECT: J. Feliciano, Santa Rosa. Frame and stucco construction. GENERAL CONTRACTOR: C. S. Phillips, Petaluma.

**MERCY HIGH SCHOOL**, San Francisco. Sisters of Mercy, owners. Classrooms, administration, library, cafeteria, enclosed play area, home-making unit, \$750,000. ARCHITECT: Martin J. Rist, San Francisco. 4 story, reinforced concrete construction, aluminum sash, asphalt tile floors. GENERAL CONTRACTOR: Barrett & Hlip, San Francisco.

**NEW INTERMEDIATE SCHOOL**, Vacaville, Solano County. Vaca Valley Union Elementary School District, owner. 5 classrooms, administration, cafeteria, music building, toilet rooms, \$243,775. ARCHITECT: Koblik & Fisher, Sacramento. Frame and stucco construction. GENERAL CONTRACTOR: Pacific Co., Oakland.

**GRAMMAR SCHOOL ADDITION**, Healdsburg, Sonoma County. Healdsburg Union Elementary School District, owner. 4 classrooms, toilet rooms, \$64,531. ARCHITECT: J. Clarence Feliciano, Santa Rosa. Frame and stucco construction, concrete floors, radiant heating. GENERAL CONTRACTOR: R. R. Todd, Santa Rosa.

**MERCY HOSPITAL BUILDING**, Redding, Shasta County. Sisters of Mercy Hospital, owner. 75 beds, \$1,202,830. ARCHITECT: Harry J. Devine, Sacramento. 4 story, reinforced concrete construction, 2 elevators and coffee shop, etc. GENERAL CONTRACTOR: Central State Construction Co., San Francisco.

**NEW JUNIOR HIGH SCHOOL**, Hayward, Alameda County. Hayward Elementary School District, owner. 12 classrooms, administration, home-making, shops, multi-purpose, kitchen and toilet rooms, \$503,304. ARCHITECT: Anderson & Simonds, San Francisco. Frame and stucco construction. GENERAL CONTRACTOR: Zaballos Bros., Hayward.

**COUNTY HOSPITAL ADDITION**, Colusa, Colusa County. County of Colusa, owner. 30 beds and kitchen wing, \$244,835. ARCHITECT: J. S. Gould, San Francisco. 1 story, reinforced concrete and frame construction. GENERAL CONTRACTOR: H. W. Robertson, Inc., Sacramento.

**MAUSELUM ADDITION**, Oakland, Alameda County. First Hebrew Congregation of Oakland, owner. \$58,913. ARCHITECT: Wilton Smith, San Francisco. Reinforced concrete, marble and bronze interior. GENERAL CONTRACTOR: Ralph Larson & Son, San Francisco.

**BOWMAN GRAMMAR SCHOOL**, Hayward, Alameda County. La Vista Elementary School District, owner. 10 classrooms, kindergarten, administration, multi-purpose, kitchen and toilet rooms, \$347,653. ARCHITECT: Anderson & Simonds, Oakland. Frame and stucco construction. GENERAL CONTRACTOR: Zaballos Bros., Hayward.

**LOW INCOME HOUSING PROJECT**, Stockton, San Joaquin County. Housing Authority County of San Joaquin, owner. 400 units, 1 community house, \$2,839,333. ARCHITECT: Howard G. Bissel, Stockton; ENGINEER: Ellis E. Ecklund, Stockton. Concrete block and frame construction, utilities, landscaping. GENERAL CONTRACTOR: W. E. Robertson, Los Angeles.

**ERECT WAREHOUSE BUILDING**, San Francisco. Maxwell Reid, owner; \$137,500. ARCHITECT: R. H. Cooley, Oakland. GENERAL CONTRACTOR: J. J. Moore, Oakland.

**EMPLOYEES APARTMENT BUILDING**, Yosemite Valley. Yosemite Park & Curry Co., owner; 10 apartments, \$11,557. ARCHITECT: Spencer & Ambrose, San Francisco. 1 and 2 story, 11,000 sq. ft., frame construction, wood sash, asphalt tile floors. GENERAL CONTRACTOR: Hedahl-Martin Co., Redwood City.

**NEW HOSPITAL BUILDINGS**, San Jose, Santa Clara County. O'Connor Hospital, owner; 250 beds, \$4,096,300. ARCHITECT: Frank T. Georgeson, San Francisco; Marguelo & Quick, St. Louis. 4 story and basement, reinforced concrete construction, aluminum sash, metal stud partitions, terrazzo and rubber tile floors, 4 elevators, separate power and laundry house. GENERAL CONTRACTOR: Barrett & Hlip, San Francisco.

**SUNSET ELEMENTARY SCHOOL**, San Francisco, City & County of San Francisco, owner; 18 classrooms, 2 kindergarten, administration, multi-purpose, and toilet rooms, lunch rooms, \$1,282,891. ARCHITECT: Ward & Bolles, San Francisco, 1 and 2 story reinforced concrete construction. GENERAL CONTRACTOR: Joseph L. Barnes, San Francisco.

## Why your customers appreciate concealed wiring, extra outlets

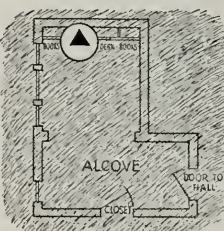

New home owners often like to add new telephone extensions later on... without marring the beauty of walls and woodwork through exposed wiring. That's never a problem when you plan built-in conduit and extra outlets for popular rooms... bedroom, kitchen, living room.

It's easy to install concealed raceways and extra outlets during construction. The cost is small and customer appreciation is great. For help in planning, call your local Pacific Telephone office and ask for "Architects and Builders Service." It's free, of course.

Put built-in telephone facilities in your plans



Pacific Telephone

## IN THE NEWS

### CONVENTION HALL FOR SAN FRANCISCO

Benj. Swig of San Francisco has announced plans for the construction of a two or three story reinforced concrete and structural steel building on Powell street, between California and Sacramento streets, to be used as a Convention Hall building.

The plans, designed by the architectural firm of Pereira & Luckman of Los Angeles, call for a garage in the basement. Cost of the project is estimated at \$700,000.

### LOW INCOME HOUSING PROJECT FOR STOCKTON

The Housing Authority of San Joaquin County are constructing a 400-unit and community building project on Sharps Lane in Stockton. Construction will be of concrete and frame.

Howard G. Bissell, Stockton, is the architect and Ellis E. Ecklund of Stockton is the engineer.

Cost of work is estimated at \$3,500,000.

### CONTRACTORS TO KEEP WASHINGTON INFORMED

A great upsurge in building contractor interest in trade association activities has been reported by Edward M. Sills, executive vice president of the Building Contractors Association of California, Los Angeles.

Sills says that "hundreds of contractors are querying" his organization to determine what steps are being taken to insure construction in California.

Steps are being taken to alert Washington to the importance of California as a strategic military and production center, as well as an area that has grown to greater population proportions than any other part of the United States.

### NEW MARKET AT SALINAS

Architect Robert R. Jones of Carmel, is completing plans for the construction of a new Sateway Market Building in Salinas for Sateway Stores.

The building will be of 1-story construction with brick veneer and wood roof.

### DISPOSAL PLANT BONDS VOTED

Voters of Mt. View, California, recently approved a bond issue of \$365,000 for the construction of a new sewage disposal plant.

### AIR FORCE HOUSING

Claude T. Lindsay, Inc., of San Francisco, has started construction of a 500 unit housing project at Hamilton Field in Marin county for the U. S. Air Force.

The project comprising 300 units for girmen and families, and 200 units for officers and families, will cost an estimated \$5,000,000.

All units will be of frame and stucco construction and will be equipped with stoves, refrigerators and hot water heaters.

### AUDITORIUM BUILDING PROPOSED AT FRESNO

The Fresno Board of Education plans the construction of a 2,000 seating capacity Auditorium Building at the Roosevelt High School, at a cost of \$1,200,000.

H. Rafael Lake and Elso E. Diluck, Fresno, are the architects.

### NAMED MANAGER OF DENVER OFFICE

C. P. "Phil" Lingel has been named manager of the Denver, Colorado branch of The Celotex Corp'n., in charge of sales.

Lingel, was formerly sales representative for the firm in their Seattle, Washington offices.

### FAMED CANAL ENGINEER PASSES AT TRACY

Oscar G. Boden, 66, familiarly known to many as "Mr. Canal," because of a lifetime spent in the engineering and construction of miles of canals throughout the West, died in Tracy, California, recently.

At the time of his death Boden was head construction engineer for the U. S. Bureau of Reclamation's multimillion dollar Tracy Pumping Plant, Delta-Mendota Canal and Delta Cross Channel projects of the Central Valley Project.

Boden had recently completed his fortieth year with the Reclamation Department.

### NEW HIGH SCHOOL FOR SPARKS

The Sparks, Nevada, High School District, has started construction of a \$1,152,277 new High School building.

DeLongchamps & O'Brien of Reno are the architects, for the structural steel frame, reinforced brick wall, and concrete floor building.

### LOS ANGELES MODEL HOME REMAINS OPEN

The three-bedroom "Southlander" model home, built for the recent Los Angeles Home

Show, will remain open indefinitely to meet the demands of the public who still pack the home at each display period.

The model home is located on the Pan Pacific Auditorium grounds. It was designed to achieve the maximum in gracious, outdoor southern California living, and is in the form of a ranch style structure.

### TILE COMPANY MOVES INTO NEW OFFICES

The southern California office of the Mo-saic Tile Company has moved to 829 North Highland in Hollywood, where facilities have been provided for a combination showroom and warehouse.

Tom Jordan, West Coast manager, reports the new 5,000 sq. ft. building "is centrally located" and convenient to southern California tile contractors and their customers.

### STANFORD UNIVERSITY SCHOOL CONFERENCE

More than 400 school officials, architects and builders met at Stanford University this month to attend the Annual Conference on School Planning.

The five day program covered all phases of school planning and construction from selection of a site to the ideal characteristics of classroom and other school facilities.

Among architects participating in the conference were: Irving Brown of San Mateo; Doyt Early, California State Division of School Planning; Daniel Fitzroy, San Rafael; William Koblik, Sacramento; John L. Reid, San Francisco; Geraldine K. Scott, Palo Alto, landscape architect; George Simons, Oakland; and Henry Wright of Los Angeles.

Among engineers appearing on the program were R. A. Boyd, University of Michigan; R. H. Jacobs, Minneapolis; and John Walsh, San Francisco.

### ARCADIA DOOR FIRM OPENS NEW OFFICES

The Arcadia Metal Products, manufacturers of sliding glass doors, has opened general sales offices in San Francisco.

Byron Nelson, former president of the Sacramento Executive Club, and manager of a Sacramento building materials firm, has been appointed northern California representative in charge of the new offices.

### LOW INCOME HOUSING PROJECT

The Housing Authority of the City of Oakland has started working on a new 336-unit Low Income Housing Project which will cost some \$3,000,000 to build.

Site of the project is at 102nd Avenue and E streets in east Oakland.

Edw. D. Cerruti and Ralph E. Westell of Oakland are the architects.

### GETS FEDERAL APPOINTMENT

John C. Emery, vice president of Plywood, Inc., Detroit, has been appointed to the Hardwood and Softwood Plywood Distributors' Advisory Committee of the Office of Price Stabilization.

### ELECTED PRESIDENT OF FAN MAKERS

John M. Frank, president of the I.L.G. Electric Ventilating Co., Chicago, has been elected president of the National Association of Fan Manufacturers, the selection being made at the recent national convention in Niagara Falls, Canada.

## ACOUSTI CELOTEX

Sound Conditioning  
... combines the  
correct materials and  
25 years experience  
in every type, size  
and technique of  
acoustical installation

Acoustical Contractors

## WESTERN ASBESTOS COMPANY

San Francisco: 675 Townsend, KL 2-3868  
Oakland: 251 Fifth Avenue, CL 1-2345  
Sacramento: 1224 Eye Street, GI 2-8991  
Stockton: 733 So. Van Buren St., 4-1863  
Fresno: 434 "P" Street, 2-1600  
San Jose: 460 Park Avenue, CY 3-1317



### Thinking of Building?

From our cost records and experience, an advance estimate may be made from decidedly general information. Based on our knowledge of labor and material costs, gained on current jobs, such an estimate may be helpful in determining your construction program.

ALL TYPES CONSTRUCTION

SAN FRANCISCO • SACRAMENTO

**SWINERTON & WALBERG CO.**

OAKLAND • LOS ANGELES • DENVER

### STATIONERY SCHOOL & OFFICE SUPPLIES

•  
Printing Engraving  
Announcements

### CENTER STATIONERY

468 McAllister

San Francisco UN 1-3703

## MULLEN MFG. COMPANY

—  
BANK, STORE AND OFFICE  
FIXTURES—CABINET WORK  
OF GUARANTEED QUALITY  
CHURCH SEATING

—  
Office and Factory  
46-80 RAUSCH ST., Bet. 7th and 8th Sts.  
San Francisco  
Telephone UNDERhill 1-5815

### WALTER R. STABY HEADS NEW GREENBERG OFFICE

Walter R. Staby has been named manager of the sales department of the new M. Greenberg's Sons & Josam-Pacific Co's offices in Phoenix, Arizona.

Staby has had many years of practical experience in the fields of brass and bronze products, plumbing and hardware specialties and has represented Greenberg and Josam products to the architects, specifying engineers, fire chiefs and water superintendents since 1941.

### OPENS NEW LA OFFICE

The Bossick Company, Bridgeport, Conn., manufacturers of casters and wheels, swivel chair controls, specialty automotive hardware, etc., has opened a complete warehouse in Vernon, California.

O. W. Ruddy, will serve as office manager.

### LOW INCOME HOUSING PROJECT

The Housing Authority of San Joaquin county, through Architect Howard G. Bissell, and Engineer Ellis E. Eckland, both of Stockton, are planning the construction of a 400 unit, plus community house, low income housing project.

Cost of the project, including construction, utilities and landscaping, will approximate \$2,839,333.

### NAMED SALES AND TRAINING SUPERVISOR

William C. Beddoe, has been appointed to the Merchandising Division of Pabco Products, Inc. in the Sales Publicity and Training Supervisor department.

Beddoe has been associated with the floor covering industry since 1928, and joined the Pabco company in 1948.

### MANUFACTURER PLANS LARGER QUARTERS

The A. Leitz Co., manufacturer and distributor of engineering, surveying and draftsmen's supplies and equipment, has transferred its main offices to San Francisco, according to a recent announcement by F. L. Frizzell, general manager.

The firm was started in 1882 and now maintain offices in Los Angeles and San Francisco.

### PROPOSED PAPER PLANT FOR SAN LEANDRO

The Crown Zellerbach Corporation of San Francisco, is working through Architect Albert C. Martin & Associates of Los Angeles, on plans and specifications for the construction of a new paper processing plant at San Leandro.

The 1-story building will contain 300,000 sq. ft. and will be of reinforced concrete and structural steel, and will cost approximately \$2,000,000.

### VETERANS HOSPITAL PLANS REVISED

The Veterans Administration, Washington, D. C., has announced plans for construction of a new 1000 bed Veterans Hospital at Fort Funston, San Francisco, are being revised.

Original plans called for a reinforced concrete and structural steel building with 12-in. walls, underground passage and reinforced roofs. Preliminary estimates set the cost of construction at \$18 to \$25,000,000.

Phone GARfield 1-1144

## Thomas B. Hunter

DESIGNER OF HEATING

AIR CONDITIONING  
VENTILATING AND WIRING  
SYSTEMS, MECHANICAL  
AND ELECTRICAL EQUIP-  
MENT OF BUILDINGS

★

41 SUTTER STREET  
ROOM 710

San Francisco California

Subscribe  
Now —

**ARCHITECT  
and  
ENGINEER**

\$3.00  
Per Year

## DINWIDDIE CONSTRUCTION COMPANY

•  
**BUILDERS**

•  
CROCKER BUILDING  
SAN FRANCISCO



**HERRICK  
IRON WORKS**  
STRUCTURAL STEEL  
REINFORCING STEEL

18TH AND CAMPBELL STS.  
OAKLAND, CALIF.  
Phone GLencourt 1-1747

*Fine*  
**ENGRAVINGS**



**POOR  
RICHARD**  
PHOTO ENGRAVING CO.  
322-324 COMMERCIAL STREET  
SAN FRANCISCO 11



# STOLTE INC.

*General Contractors*

OAKLAND • CALIFORNIA

## PITTSBURGH TESTING LABORATORY

ENGINEERS AND CHEMISTS

Testing and Inspection of Concrete,  
Steel and Other Structural Materials

Design of Concrete Mixes

Offices in all principal cities

651 Howard St., San Francisco 5  
EXbrook 2-1747

## MATTOCK CONSTRUCTION COMPANY

★  
**BUILDERS**

★  
604 MISSION STREET  
SAN FRANCISCO

Subscribe  
Now —

**ARCHITECT  
and  
ENGINEER**

\$3.00  
Per Year

## Index to Advertisers

AMERICAN Perlite Corpn.....	44
ANGIER Pacific Corp.....	35
ARCHITECTS Reports.....	38
BARRETT & HILP, Contractors.....	35
CLASSIFIED Advertising.....	43
CENTER Stationery.....	47
CLAY Brick & Tile Association.....	5
CLINTON Construction Company.....	36
COLUMBIA Steel Co.....	*
CROCKER, First National Bank.....	38
DINWIDDIE Construction Co.....	47
ELECTROMODE Corpn.....	*
FULLER, W. P. Co.....	*
FORDERER Cornice Works.....	35
GLADDING McBean & Company.....	*
GREENBERG'S, M. Sons.....	*
HANKS, Inc., Abbott A.....	48
HAWS Drinking Faucet Co.....	28-29
HERRICK Iron Works.....	47
HILLYARD Chemical Co.....	*
HOGAN Lumber Co.....	36
HUNT, Robert W., Company.....	48
HUNTER, Thos. B.....	47
JOHNSON, S. T. Co.....	*
JUDSON, Pacific-Murphy Corp.....	36
KRAFTILE Company.....	28
MARBLE Institute of America.....	2
MATTOCK Construction Co.....	48
MICHEL & Pfeffer Iron Works.....	*
MULLEN Mfg. Co.....	47
PACIFIC Clay Products Co.....	*
PACIFIC Manufacturing Company.....	37
PACIFIC Portland Cement Company.....	Back Cover
PACIFIC Telephone & Telegraph Co.	45
PARKER, Steffens & Pearce.....	35
PITTSBURGH Testing Laboratory.....	48
POOR Richard Engraving Co.....	47
PORCELAIN Enamel (Architectural Division) Publicity Bureau	Inside Front Cover
REMILLARD-Dandini Co.....	48
REPUBLIC Steel Corporation.....	37
SCOTT Co.....	48
SIMONDS Machinery Company.....	37
SISALKRAFT Company.....	36
SMOOTH-Holman Company.....	33
SOTO, Henry C., Corp., Landscape	33
STANLEY Works, The.....	32
STOLTE, Inc.....	48
SUPERIOR Fireplace Co.....	*
SWINERTON & Walberg Co.....	47
U. S. Bonds.....	1
UNITED STATES Steel Corp'n.....	*
UTILITY Appliances Corp'n.....	34
VERMONT Marble Company.....	37
WEST Coast Screen Co.....	31
WESTERN Asbestos Company.....	46

\*Indicates Alternate Months

## REMILLARD-DANDINI Co.

Brick and  
Masonry Products

400 MONTGOMERY STREET  
SAN FRANCISCO, CALIF.

## Scott Company

HEATING • PLUMBING  
REFRIGERATION

★  
San Francisco  
Oakland  
San Jose  
Los Angeles

## ABBOT A. HANKS, INC. Engineers & Chemists

INSPECTING — TESTING — CONSULTING  
CONCRETE • STEEL • MATERIALS  
CHEMICAL AND TESTING  
LABORATORIES

• RESEARCH AND INVESTIGATION •  
—  
TESTS OF STRUCTURAL MATERIALS  
DESIGN OF CONCRETE MIXES  
SHOP AND ERECTION INSPECTION OF  
STRUCTURES AND EQUIPMENT  
INVESTIGATION OF STRUCTURES  
AND MATERIALS  
TESTS AND INVESTIGATION OF  
FOUNDATION SOILS  
FIRE RESISTANCE AND INSULATION  
TESTS

624 Sacramento Street, San Francisco

## ROBERT W. HUNT CO.

ENGINEERS  
INSPECTING TESTING

STRUCTURAL MATERIALS  
CONCRETE MIX DESIGN  
CHEMICAL ANALYSIS  
EQUIPMENT

PRINCIPAL CITIES  
UNITED STATES • EUROPE  
SAN FRANCISCO LOS ANGELES  
PORTLAND SEATTLE

# ARCHITECT AND ENGINEER

GLEASON LIBRARY University of San Francisco



BARRETT & MILP, Contractors

**AUGUST**

**1951**

---

---

# *Serving California*

## **L U M B E R**

**FOR ALL PURPOSES  
WHOLESALE—RETAIL**



**ABOVE:**  
Santa Rosa  
Terminal for  
Mill to Job  
Shipments

**Below:**  
San Rafael  
Yard



**San Francisco Yard**



## **DICKINSONS LUMBER CO.**

JERROLD AVE AT QUINT STREET  
SAN FRANCISCO  
Telephone: Mission 7-2992



665 IRWIN STREET  
SAN RAFAEL  
Telephone: SR 2618

Teletype: S. F. 1176

---

---

# ARCHITECT

Vol. 186

No. 2

# AND ENGINEER

ARCHITECTS' REPORTS—Published Daily

## Contents for

# AUGUST

EDWIN H. WILDER  
Editor

MARK DANIELS, A.I.A.  
Associate Editor

J. WELLS HASTINGS  
Contributing Editor

PROF. LELAND VAUGHAN  
Landscape Architecture

JOHN A. BLUME  
Structural Engineering

MICHAEL GOODMAN  
Planning

JOHN S. BOLLES, A.I.A.  
Book Reviews



### COVER PICTURE:

GLEASON LIBRARY  
University of S. F.  
San Francisco

Among a wide variety of construction projects handled by the Barrett & Hilp firm of contractors, "Builders of the West", is the new Gleason Library at the University of San Francisco, which represents a portion of an extensive expansion program for the University.

Milton Pflueger, architect. Photo by J. H. Zum Brunnen. (See Page 19 for complete story.)

ARCHITECT & ENGINEER  
is indexed regularly by  
ENGINEERING INDEX, INC.

EDITORIAL NOTES . . . . .	6
JOINT INFORMATION COMMITTEE . . . . . American Institute of Architects & Producers Council	8
NEWS & COMMENT ON ART . . . . .	11
REVOLUTIONARY METHOD OF PRODUCING LIGHT . . . . . Sylvania Electric Products, Inc.	13
NEWEST BUILDING IN PHOTOGRAPHIC CENTER, HOLLYWOOD CALIFORNIA . . . . . Albert A. Schwartz, Architect; Winter Construction Co., Contractor	16
BUILDERS OF THE WEST IN THE AMERICAN TRADITION . . . . . BARRETT & HILP, General Contractors By B. A. STEPHENSON	19
A.I.A. ACTIVITIES . . . . .	38
WITH THE ENGINEERS . . . . .	40
PRODUCERS COUNCIL PAGE . . . . . Edited by CARL B. FRANK, Detroit Steel Products.	42
BOOK REVIEWS, Pamphlets and Catalogues . . . . .	48
ESTIMATOR'S GUIDE, Building and Construction Materials . . . . .	51
ESTIMATOR'S DIRECTORY, Building and Construction Materials . . . . .	53
BUILDING TRADES WAGE SCALES, Northern, Central & Southern California . . . . .	54
CLASSIFIED ADVERTISING . . . . .	55
CONSTRUCTION CONTRACTS AWARDED, General Data . . . . .	56
IN THE NEWS . . . . .	57
INDEX TO ADVERTISERS . . . . .	60

ARCHITECT AND ENGINEER (Established 1905) is published on the 15th of the month by The Architect and Engineer, Inc., 68 Post St., San Francisco 4; Telephone EXbrook 2-7182. President, K. P. Kierulff; Vice-President and Manager, L. B. Penhorwood; Treasurer, E. N. Kierulff.

Los Angeles Office: Wentworth F. Green, 439 So. Western Ave., Los Angeles 5; Telephone DUinkirk 7-8135.

Entered as second class matter, November 2, 1905, at the Post Office in San Francisco, California, under the Act of March 3, 1879. Subscriptions United States and Pan America, \$3.00 a year; \$5.00 two years; foreign countries \$5.00 a year; single copy 50c. ARCHITECTS' REPORTS are published daily from this office, Vernon S. Yallop, Manager. Telephone DOuglas 2-8311.





# EDITORIAL NOTES

## LIMITING THE MONEY SUPPLY

No program to stabilize the economy and control inflation can be effective unless it includes measures for limiting the expansion in the money supply and bank credit. The purchasing power which has been reduced by heavier taxation must not be replaced through borrowing from banks. This would mean undoing with one hand what is being done by the other.

Certainly one of the most effective available methods of limiting the expansion in the money supply and bank credit is action to make the money market, including the market for short-term Government securities, self-supporting. Such action requires flexibility in money rates, for no satisfactory way has as yet been found to restrict the availability of credit without affecting interest rates charged all borrowers, including the Government.

\* \* \*

TOTAL booking of fabricated structural steel for 1951 is estimated at 2,529,832 tons, the highest on record since 1930.

\* \* \*

## PREDICT REDUCED CONSTRUCTION

The Director of Defense Mobilization, Charles E. Wilson, has predicted that the total physical volume of new construction for the year 1952 will run about eighty per cent below that of the 1950 level.

Ralph Walker, outstanding international architect and former president of the American Institute of Architects, points out that the construction industry is seeking some tangible indication of possible permissible future construction volume in order that the architectural profession, the engineering profession, the construction industry, and the manufacturer of building supplies and material may have some sound basis upon which to proceed with confidence in future planning.

Some reasonably definite information is needed, Walker points out, to properly prepare necessary specifications, arrange financing, start on site work and engage in a multitude of other preliminaries necessary to the construction industry—to say nothing of the intricate needs of the building material manufacturers to have on hand and supply the wide variety of products essential to the satisfactory completion of any sizable national building program.

Wilson's predictions are the result of a broad scale study involving known and unknown factors covering the next year or two, and includes the major items of military and defense construc-

tion, and the essential civilian construction—commercial, industrial and residential.

While there are real possibilities for making sizable cuts in the volume of critical materials used in construction, it is essential that vigorous steps be taken to reduce material usage on government jobs as well as private construction. The better the job is done within the industry, the less the opportunity for bureaucratic controls.

\* \* \*

Over 66 per cent of all housing units in San Jose, California, are owner occupied.

\* \* \*

## PERSONAL SACRIFICES

When your representative in the State or Federal legislative bodies decide upon a substantial national defense program, a program that at present involves many unforeseen contingencies, perhaps of an international scope, they commit you as an individual to certain sacrifices

The size of the governmental program will determine the absolute use and reductions in supplies and material that will be available for private and non-emergency government use.

While it may not be necessary, at this time at least, to anticipate any great sacrifices, there are a number of items already appearing on the "scarce" list and some individuals are already having to reduce their level of consumption.

The problem may resolve itself down to the basic economic factor of having to buy less although we produce more. This would reduce the great dangers of inflation and would build an expendable reserve for use when present "emergencies" may disappear.

It is utter fallacy, however, to assume that any major program entered into by your legislative representative, is a problem that does not affect you. When such a program requires personal sacrifices you are the one who will make them.

\* \* \*

## PREDICTION OF THE NEW HOME

According to the "experts" in the field of home planning, construction, and financing, the typical new home built this year will probably consist of a one family structure of five rooms with a total floor area of about 900 square feet.

That is the general description of the average single family home insured in the past several months by FHA. This average property had a FHA valuation of \$8,286, including the value of the house, the building site and all of the physical improvements.

# design for PERMANENCE



ARCHITECTS: Naramore, Bain, Brady & Johanson  
CONTRACTORS: Sound Construction & Engineering Co.

## Ceramic Veneer

*A Non-Critical Building Facing*

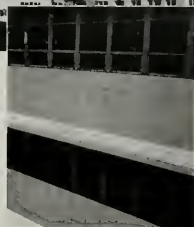

The majestic new Veterans Administration Hospital in Seattle, Washington exemplifies the functional beauty of Ceramic Veneer. The entire elevation shown is faced with this adhesion type machine perfected terra-cotta, including the projecting canopies at each story as shown in the small inset photograph.

Versatile Ceramic Veneer was also applied throughout the entire entrance lobby. The variety of colors — modern character — light weight and low maintenance cost makes Ceramic Veneer the best choice for a permanent, economical building facing.

## Ceramic Veneer IS A GLADDING, McBEAN & CO. PRODUCT

Other quality ceramic products include Glazed Structural Units, Hermosa Tru-Joint Tile, Face Brick, Roof Tile, Floor and Patio Tile, Refractories, Flue Linings, Vitriified Clay Pipe, Franciscan Ware and Franciscan Fine China

Since 1875

SEATTLE

1500 FIRST AVE., S.

SPOKANE

1102 N. MONROE ST.

PORTLAND

110 S. E. MAIN ST.

SAN FRANCISCO

1275 HARRISON ST.

LOS ANGELES

2901 LOS FELIZ BLVD.

ROCKY MOUNTAIN AFFILIATE: DENVER TERRA COTTA COMPANY - FIRST AND UMATILLA, DENVER, COLORADO

# JOINT INFORMATION COMMITTEE

AMERICAN INSTITUTE OF ARCHITECTS and THE PRODUCERS COUNCIL, INC.

---

As this issue goes to press we are advised that the NATIONAL PRODUCERS' COUNCIL is conducting a specification survey similar to the one recently completed by the A.I.A. Charles Mortensen, Managing Director of THE PRODUCERS' COUNCIL in response to our request for information replied by wire "Survey of Specifications Not complete. Impossible to send you story this issue."

The fact that this survey is in the works is the story in itself that is most important to all concerned at this point. Here is one more step toward UNIFORM SPECIFICATIONS and better Trade Literature. With both members of the JOINT INFORMATION COMMITTEE at the National level taking active steps to obtain concrete information the ultimate objective is a little closer.

Probably the results from this survey now under way will be equally or even more important than the results already obtained from the survey conducted by the A.I.A. The PRODUCERS' COUNCIL survey assumes this importance from the viewpoint of the manufacturer who in the final analysis will have to produce the great bulk of this material.

Without the initial compromises that the examination of two surveys covering both branches of the Building Profession can provide it is possible that much valuable effort can be lost.

Using the findings that these independently conducted surveys will indicate from the membership is sure to produce the best possible solution to a very difficult analysis far more than if it were

considered solely by the Joint Information Committee of the A.I.A. Obviously the Architect will receive greater benefit from the careful thought that can be given to the findings of both surveys on a practical level than would be possible using only the A.I.A. survey as an index.

Every Architect should be encouraged by the prompt consideration that is being given to the problem of UNIFORM SPECIFICATIONS by the Joint Information Committees of the A.I.A. and THE PRODUCERS' COUNCIL at the national level. The speed with which this program is moving after its initiation by the San Francisco chapter of the PRODUCERS' COUNCIL and the Northern California Chapter of the A.I.A. is gratifying to both chapters and the ARCHITECT AND ENGINEER.

Turning the wheels to start a movement such as being discussed is not enough, now that it is moving, continued enthusiasm is needed to prevent a reversion to inactivity. Many times fundamentally sound objectives are lost in group action simply because outside effort which this demands becomes burdensome and everybody decides to let George do it.

If we all decide to let George do it at this point it will never be accomplished. Both local chapters of the Joint Information Committee are now in the position of being good men for the job so they are more or less drafted. It now becomes an enforced responsibility for this regional Joint Information Committee to keep the ball rolling until definite action is indicated at the national level.

---

*NOTE: This news space is being contributed by ARCHITECT & ENGINEER Magazine to the JOINT INFORMATION COMMITTEE representing the Northern California Chapter of The American Institute of Architects and the Northern California Chapter of the Producer's Council, Inc., and is available to this Committee for the purpose of bringing to the attention of leaders within the Construction Industry various phases of the Architectural profession and building materials industry procedures for general consideration and comment. Your "idea" and any suggestions for the better pooling of thoughts along these lines should be sent to "Joint Information Committee, c/o The Architect & Engineer, 68 Post Street, San Francisco," where they will be immediately forwarded to the proper committee members.*

**"all that doesn't meet the eye"**

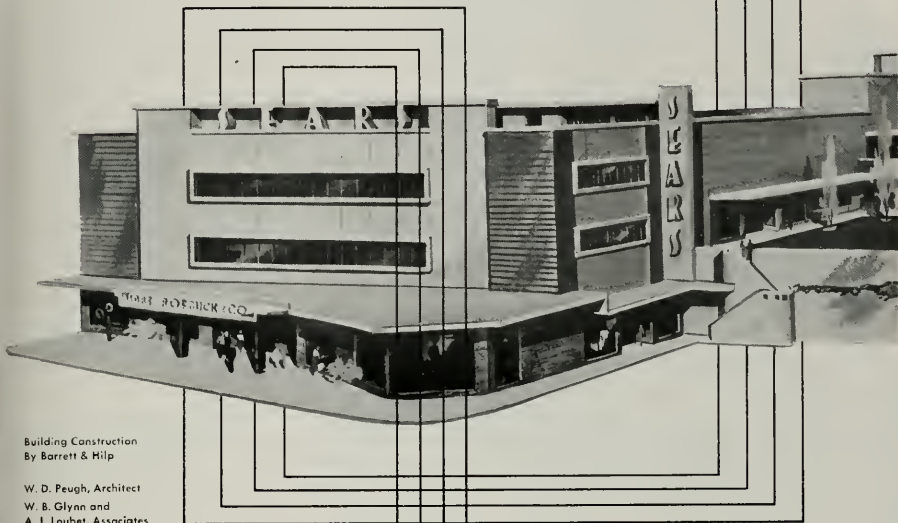

Building Construction  
By Barrett & Hilp

W. D. Peugh, Architect  
W. B. Glynn and  
A. J. Loubet, Associates

**plumbing**  
**heating**  
**ventilating**  
**air conditioning**

Much of pioneering and latest engineering science goes into the internals of this remarkable Sears Roebuck Building in San Francisco. Scott Company are mechanical contractors for Barrett & Hilp.

Finest materials... finest installations... is Scott Company's credo for doing things. And it's part of the reason why Scott Company has earned the loyalty of contractors and architects all over California.

***Scott Co.***

MECHANICAL CONTRACTORS TO THE WEST  
SAN FRANCISCO • OAKLAND • LOS ANGELES





*Ariston  
Metal Windows*



**Michel & Pfeffer Iron Works, Inc.**

South Linden & Tanforan Aves.

South San Francisco, Calif.

JUniper 4-8362

N. K. JUVET, Manager  
Metal Windows Division

# NEWS AND COMMENT ON ART

## PORTLAND ART MUSEUM

Thomas C. Colt, Jr., director of the Portland Art Museum, West Park and Madison, announces the following exhibits and events for the month of August.

Modern Print Masterpieces is an introduction to a series of smaller exhibitions showing contemporary prints. The group has been selected from the Portland Art Museum collection, the Art Institution of Chicago, the Museum of Modern Art, and the Buchholz Gallery of New York City.

Creative Calligraphy is an exhibition of lettering and typographical design by Arnold Bank, noted calligrapher, and teacher of lettering and typography. The exhibition shows all stages and uses of the lettering designing process.

American Indian Basketry, and an exhibition of Persian Rugs (Hirsch Collection) complete the special exhibitions.

At a recent organization of the Oregon Art Alliance, some thirty-two member organizations were enrolled in the Alliance.

## SAN FRANCISCO MUSEUM OF ART

The San Francisco Museum of Art, War Memorial Building, Civic Center, will offer the following exhibits and events during the month of August:

Exhibitions: A group of Paintings by Marion Messinger and Charles Tracy; a special selection of Museum Collections; "What Americans are Collecting"; Tradition and Experiment in Modern Sculpture; and "Advancing French Art".

Among specially scheduled events are the Sunday afternoon lectures at 3:15 which will feature "Experiments in Contemporary Sculpture," by Alton Schoener, August 12; Current Exhibitions, by

## PACIFIC ISLAND ART

### CALIFORNIA PALACE OF THE LEGION OF HONOR

Scattered over the South Pacific are the homes of many peoples who have developed distinctive cultures and a variety of striking art styles, some of them unsurpassed by any primitive peoples.

The arts of the Pacific are bewildering in their variety—in some areas the skill of the artist is all-important, in other islands, art is primarily a means of expressing or even containing spiritual forces.

An exhibition of Pacific Island Art is now being shown at the California Palace of the Legion of Honor, Lincoln Park, San Francisco. It comprises a loan from the University Museum, Chicago.

**MASK, NEW IRELAND**  
Lent by University Museum,  
Philadelphia



## NEWS AND COMMENT ON ART . . .

William H. Irwin, August 12; Museum Collection, by Nancy Bordewich, August 19; and "What Americans Are Collecting", by Anneliese Hoyer on August 26th.

The regular Wednesday evening lectures will not be given during August but will be resumed in September. The usual Gallery Tours will be combined with the Sunday afternoon lecture on the 5th and 12th and will be given at 2:30 p.m. on the 19th and 26th.

### CALIFORNIA PALACE OF THE LEGION OF HONOR

Thomas Carr Howe, Jr., Director of the California Palace of the Legion of Honor, Lincoln Park, San Francisco, has announced the following special exhibitions for August:

PAINTINGS, by Joan Miro; CHINESE RUBBINGS, from the collection of the University of California; SCULPTURE, by Marino (this is the first San Francisco exhibition of bronzes by this modern Italian sculptor); PAINTINGS, by Chaim Soutine. Comprises a group of 35 paintings from the Museum of Modern Art, New York City; CAST IRON TOYS from the collection of Mary L. Lowell; THE TRIUMPHS OF EMPEROR MAXIMILIAN I, a series of prints selected from the Achenbach Foundation for Graphic Arts; and PAINTINGS, by Oscar De Mejo. A group of 25 paintings by the Italian born painter who is now a resident of California.

### ANCIENT HOME

More than 3000 years ago, a wave of sensational "modern" home styles had the Egyptians of the 18th dynasty divided in opinions as to which was best.

A model of one of these 3000 year old "modern" homes is now being displayed in the Rosicrucian Egyptian Museum Park in San Jose, California. The model represents the estate of one of the notables in a revolutionary city founded by the leading radical of that time, Pharaoh Amenhotep IV.

Amenhotep IV, later known as Akhnaton, rebelled against the religious and cultural traditions of his time.

He abandoned the old capital of Egypt and dedicated a new city. According to archeologists the city was known as Tell el Amarna and was the center of the greatest culture ever attained by Egypt. The handiwork of its craftsmen and artists still amazes the modern world.

The model of the noble's estate, built by Oronzo Abbatecola, noted stage designer of Los Gatos,

was from original plans drawn by Dr. E. Baldwin Smith, authority on Egyptian architecture.

The main living quarters are two stories high, the entrance being in the side of a protruding vestibule. First story is exceptionally high with small windows at the top to "air condition" the room by allowing rising heat to be expelled.

The second story is smaller in area and serves as a penthouse overlooking magnificently landscaped grounds with pools and tiled walks. These are surrounded by a high wall like the present day patio.

A spacious reception room serves two purposes: to connect the central communal hall with the kitchen and outside servants' quarters, and to provide formal and informal entrance into the main living room. Both the north and west halls are decorated with a painted band at the level of the windows, which repeat a false grilled window as a decorative motif in the painted pattern.

The main dwelling contains a master bedroom, additional bedrooms, anointing room, lustration chamber, central hall and bathroom. Adjoining stables are shown with granary, and included in the model is a small chapel open to the sky and used for both religious purposes and as a place of relaxation in the cool gardens.

James C. French, curator of the Museum, says this is the only scale model of this ancient estate of the 18th dynasty in the United States and is on display daily, free to the public.

### NEW FRENCH PAINTINGS SHOWN AT SAN FRANCISCO MUSEUM OF ART

An exhibition of thirty-eight paintings by eight Parisian artists opened for public showing at the San Francisco Museum of Art, War Memorial Building, Civic Center, early this month and will continue until the middle of September.

The exhibition was selected in Paris by Louis Carre of the Carre Gallery and the American Federation of Arts has arranged for its tour in the United States. Included are works of Jean Bazaine, Maurice Esteve, Hans Hartung, Andre Lansky, Pierre Soulages, and Nicholas de Stael.

The significance of the exhibition lies in the evidence of a break with the "traditions" of Picasso, Matisse, Leger, a break which has in any case been long overdue. These comparatively young Parisians, the majority in their forties, have found a way to use the achievements of the older men and at the same time make their own contribution: a positive conception and use of darks.

# Revolutionary Method of Producing Light

A new and revolutionary method of producing light—entirely different from either incandescent or fluorescent light—employing thin flat sheets of glowing glass instead of bulbs or tubes, was demonstrated publicly in New York recently. It operates at extremely low cost on conventional household AC, and its inventors claim that it will have an expected life of one to five years.

Sheets of this glowing material can be made in almost any size to provide luminous ceilings, walls, tables, clock faces, stair risers, switch-plates, and signs, according to Dr. E. F. Lowry, head of the development group which perfected the new lighting principle. This "area" light source, said to be the goal of lighting engineers and architects for generations, is described in technical terms as "electro-luminescence" and is the creation of light by the excitation of certain materials placed in a fluctuating electric field. Such conditions are created by assembling these key materials between thin electrical conducting layers and applying alternating current. At least one layer must be transparent, either inherently or by its extreme thinness. The combination is literally a luminous condenser, a sandwich of light.

Although electro-luminescence employs fluorescent materials, it is not at all similar to the fluorescent lamp. Neither is it like an incandescent lamp. It has no filament, uses no bulbs or tubes, does not require the removal of oxygen through pumping. However, more important than these construction differences is its basic difference in concept. For the first time, architects, designers, and equipment manufacturers have available a true area light source.

Incandescent lamps have always been known as point sources. They have been applied most successfully where concentration of energy has been important; in general applications, it has been necessary to diffuse and redirect the concentrated radiation for maximum lighting effectiveness. In contrast with these, most arc discharge lamps—best exemplified by the fluorescent tube—are line sources. While it is not uncommon

to see such lamps curved or coiled into compact geometric shapes, nor to see parallel rows to simulate flat surfaces, the real emphasis on their use has been toward lines and rows. For the most flexible solutions of problems of architecture and mechanical devices, a new source was needed to meet the structural concepts created out of points, lines, and planes. The electro-luminescent lamp meets the third of these geometric needs and, therefore, should take its place as a major light source.

Three basic characteristics emphasize this point. First, the materials which make the luminescence possible are applied in thin films which together seldom add as much as 1/100th of an inch to the glass or other transparent materials which supports it. There is no limit, other than the practical ones of production equipment and handling facilities, to the area of glass which may be treated. Secondly, the light produced is uniform—a uniformity also dependent on the practical one of spray coating rather than any theoretical concept. Variations which exist in the luminosity are usually beyond the ability of the eye to dis-

Composition of "Electro-Luminescent" Sheet

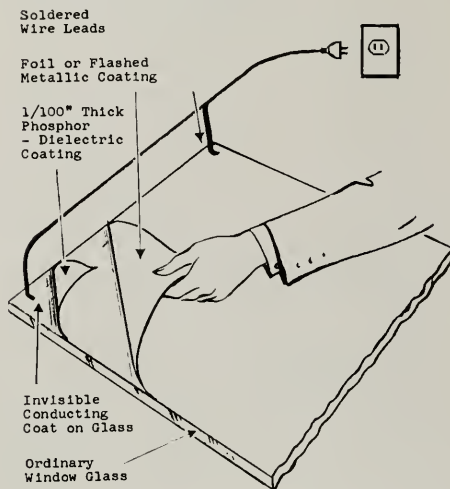

*NOTE: This article deals with a development in the field of producing light, representing a revolutionary new method being pioneered by the Sylvania Electric Products, Inc., which should be of unusual interest to Architects and Engineers. Editor.*



cern readily. Thirdly, for most applications, it is the coolest of all sources. It has no cathode or filament concentration; all the energy is uniformly absorbed and radiated over the entire area making the temperature increment a minimum. For present applications, the temperature of operation is unnoticeable to the human hand; as brightness and power loading are increased, a slight rise in temperature may be expected.

Commercial availability of the new lighting is at present limited to two types which can be utilized for 1) Visual recognition by dark adapted eyes, 2) Decorative lighting effects for normal interiors, and 3) Luminous panels not handicapped by a third dimension, by heat, or by poor uniformity.

One type presents a green luminosity at 0.1 footlambert (the brightness of a white object in full moonlight) when the lamp is connected direct to the usual 120 volt, 60 cycle circuit; the second, a green luminosity not over 2.0 footlamberts when a 500 volt step-up transformer is made part of the circuit. Such transformers would be about the size of a pack of cigarettes for panels a foot or two square. Colored light at two footlamberts brightness would be quite noticeable in any interior lighted up to 5 or 8 footcandles—thus including most rooms in the home, amusement places, lobbies of certain buildings, and similar areas where lighting for critical vision is either not required or provided only in localized areas. The primary difference between these commercially

available panelites lies in the thickness and character of the dielectric used since, as with any condenser, there must be voltage breakdown protection for surges and line fluctuations.

The spectrophotometric curve of the green panelite shows a rather saturated color peaking at 5200 angstroms. If, instead of standard 60 cycle circuits, energy can be supplied at higher frequencies to a green panelite, the brightness of the lamp would increase appreciably (about 12 fold at 3000 cycles) and the color would shift somewhat to the blue. This shift is on the order of 200 angstroms from the 5200 A° peak. While it is not anticipated that there will be many applications at such high frequencies, it can be noted that 400 cycles is standard for many airplanes and that frequency conversion equipment is practical enough to be considered for

Fig. 1

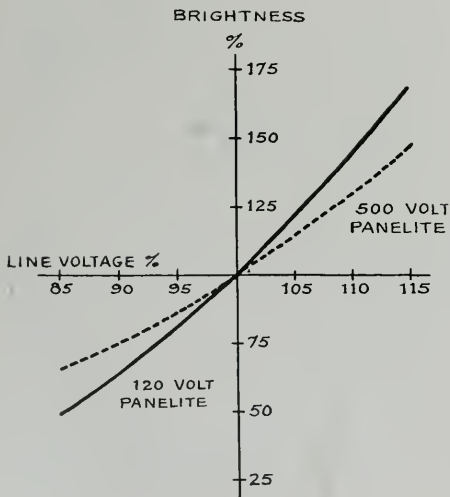
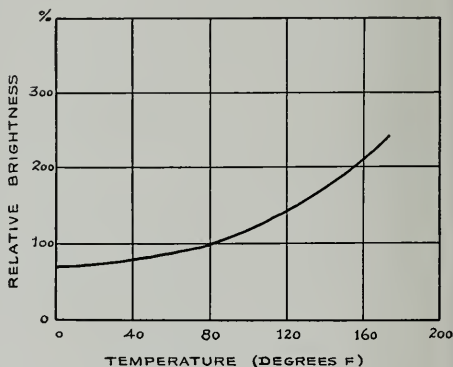

Fig. 2



limited lighting applications. Brightnesses around 25 footlamberts, especially in color, are readily visible in almost any artificially lighted interior.

Besides green, a golden yellow, a soft blue, and a daylight white have been developed, and will be made commercially available soon. The yellow peaks at about 5800 angstroms with an overall range between 4800 and 6800; the blue at 4700 angstroms with a range strongest in the adjacent green part of the spectrum. While not the only procedure, one successful white has been the result of combining the yellow and blue described above with the composite spectral curve showing their respective peaks.

While lamp brightness varies appreciably as voltage is increased toward extreme values, the effect within probable commercial range is slight. For low brightness panelites, a 1% variation in line voltage between 100 and 130 produces about a 3% variation in light output. For the medium

brightness panels, the variation is somewhat less although this may depend as much on the transformer design as it does on the lamp. (See Figure 1).

Electro-luminescent lamps are currently being designed for operating ranges between  $-20^{\circ}\text{F}$  and  $+175^{\circ}\text{F}$ . This is not necessarily a limiting factor; if applications arise which require a broader range, there is every reason to feel that satisfactory results can be achieved with proper dielectric and phosphor control. An indication of light output variation with temperature is shown in Figure 2.

No rating on life has thus far been established but it is expected to be measured in years. Unless breakdown occurs, prevented largely by adequate design and evident only by minute black spots on the lamp face, life seems indefinite. Nevertheless, there is probably a chemical as well as other phenomena which affect brightness in service, and therefore, practical ratings may be set at 1 to 5

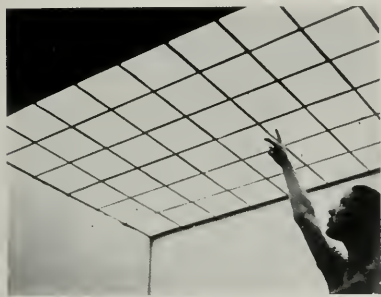

**LUMINOUS CEILING:**  $\frac{1}{8}$  in. thick and 6 ft. wide, consisting of squares. Has brightness of  $2\frac{1}{2}$  ft. lamberts. Small, inexpensive transformer brings house current to 50 volts and entire panel uses less current than 75-watt incandescent bulb.

years. Moisture, of course, tends to accelerate chemical processes and can be a factor leading to electric breakdown so an anti-humidity coating over the entire lamp will add to its overall performance.

The electrical characteristics of the electro-luminescent lamp are quite interesting. It possesses a leading power factor—in some cases as much as 80 degrees leading (10% power factor). Very few operating devices on electrical power lines are in this category. Taken alone it is not particularly an advantage; however, when assessed against all the motors, transformers, fluorescent lamps and other devices which have a lagging power factor, the electro-luminescent lamp

may be considered the dream lamp of the future for all electric power transmission engineers.

A small clock face ( $3\frac{1}{2}$ " diameter) for 120 volt operation would be rated about  $1/50$ th of a watt. Thus, operating continuously, it would not consume more than 2 or 3c in power per year. The current rating for such a lamp—at 0.1 footcandle—is about 0.5 milliamperes. A larger clock face (15" diameter) for 500 volt operation would operate at about 18 milliamperes. In general, it might be said that each square foot of 120 volt panelite would be rated at 8 milliamperes; each square foot of 500 volt panelite at 15 milliamperes. This is not necessarily a straight line relationship since there may be edge effects and some changes in those relations because of the inductive and resistive elements of the transformer. Nevertheless, they are indicative of the power requirements for present applications. The capacitance of the lamp increases proportionally as its area increases assuming no change in details of lamp design—the small clock face noted above being about .01 microfarad, the larger one about .20 microfarad.

The application of this new light source is still in its early stages. Many of the details given above are illustrative only, correct for the product as now being made but subject to change and refinement, depending on variations between phosphors, between dielectrics, even between the types of glass being used. In any case, as more of these lamps are put into daily use, an interesting new path of lighting progress seems assured.

## **PAINTING AND DECORATING CONTRACTORS OFFER IDEA**

The Washington State Council of Painting and Decorating Contractors of America, Olympia, recently called attention to the "many different ways the painting specifications are written" which results in "more or less misunderstanding and confusion" and suggested consideration be given to a "more uniform painting specification" in the construction industry.

The Contractors also point out that various government agencies should give more consideration to local working conditions, agreements, and regulations pertaining to certain methods of painting and thereby eliminate, or at least equalize, spray and manual painting.

Consideration should be given specifications which include under painting, and other items as mill and back priming, dry wall taping, waterproofing, pipes, radiators and other mechanical painting, sand blasting when preparatory to painting, roof painting with aluminum for heat reflection purposes, and structural steel and bituminous painting.

general photographic overhaul operation. A large fire proof vault is provided for protection of both company and customer owned equipment.

The stock and shipping facilities are located in the east area of the new building and have been scientifically planned to save time and steps. Two sliding doors open onto the loading dock which is of truck height and the same level as the building floor to minimize heavy lifting and rehandling of shipments.

In order to make the most efficient use of every bit of floor space, the heating and ventilating equipment is located in a mezzanine space. Two thermostatically controlled stainless steel furnaces provide comfortable living conditions in the gallery and office areas and ideal temperatures and humidity for the service, stock and shipping units.

On the exterior of the building the word "Graflex" is spelled out in three foot letters, outlined in white neon tubing across the Cole avenue facade and a similar spell-out wall sign has been located for identification on the Waring avenue side of the building. The building is set off by appropriate landscaping while the loading and parking areas are enclosed by a high steel-wire fence giving the entire project a beautiful appearance as integral part of the surrounding area.

#### **MODEL EMERGENCY BUILDING CODE ORDINANCE APPROVED BY GOVERNMENT**

Approval of a proposed model emergency building code ordinance which will permit local building officials to authorize the use of alternate materials and techniques during the present national emergency, when certain required materials are in short supply, has been announced by Raymond M. Foley, administrator of the Housing and Home Finance Agency.

The ordinance was written by Government officials and reviewed and unanimously approved by the HHFA's Advisory Committee on the Administration of local Building Regulations, a group composed of building officials and specialists in municipal regulations from various parts of the United States. The ordinance is being printed and will soon be ready for distribution.

The new ordinance is hailed as "an outstanding example of voluntary cooperation between local and national officials to achieve a major contribution to the national defense program" and while many existing codes provide the local building official with authority to approve alternate materials and methods under standards which will protect public health, safety, and welfare, a large number do not contain such authority, even for emergency administration in periods of short-

ages. The new ordinance is designed so that it can be adopted by any locality, with proper modifications to meet local requirements.

During the national emergencies certain critical materials are needed for defense purposes, which must get top authority. Thus, although they may be required by local building regulations, they may not be available. Yet certain construction and repair must go forward, and this emergency ordinance, according to Government officials, when locally adopted, permits local building officials to approve the use of alternate materials and techniques when such an emergency arises and shortens the supply of required materials.

It was pointed out that the ordinance contains three parts: 1) the introduction which explains the necessity for such an ordinance; 2) the Ordinance itself; and 3) a number of explanatory notes on the ordinance which point up its principles and the purpose of its provisions, and indicate which provisions need local modification to fit local needs.

The introductory material points out that the new ordinance has been prepared following several months of work on the part of building officials and government agencies as a guide and suggestion for possible action by city councils, mayors, city managers and building officials of cities throughout the nation whose local building codes do not permit the authorization by proper officials of alternate building materials and methods in times of emergency. Cities which wish to take the proper action to permit alternate actions would have to adapt the new ordinance to fit the relevant portions of state laws, municipal charters, and local building codes.

Acting Director of Research Joseph H. Orendorf indicated how the proposed ordinance might be used by localities. "If shortages become as severe as in World War II, local building officials may find it necessary to authorize use, for example, of plastic or porcelain outlet boxes instead of steel in household electrical systems. In some kinds of masonry construction, lightweight aggregates could be used. This weight reduction in turn would make it possible to use less reinforcing and structural steel. There are many opportunities for conservation of critical materials in household plumbing and heating systems and elsewhere in the house."

Formal title of the ordinance is, "An Emergency Ordinance Amending All Building, Electrical, Gas, Mechanical, Plumbing, and Related Ordinances; Authorizing the Use of Alternate or Substitute Materials and Methods during the Period of National Emergency."

(See Page 37)

# BUILDERS OF THE WEST IN THE AMERICAN TRADITION

## BARRETT AND HILP



J. Frank Barrett

### GENERAL CONTRACTORS

By B. A. STEPHENSON



Harry H. Hilp

This is the story of two San Francisco boys who grew up in the West and have "made good" in the general building construction field.

From a meager two-man enterprise that was started more than forty years ago, with very limited capital but a strong determination and willingness to work plus an undieing faith in their ability and the future, the firm of Barrett & Hilp stands today among the top organizations in the construction industry and is nationally recognized for many of its outstanding achievements.

The firm points with pride today to its ten-million dollar annual volume of business, and to its more than seven hundred employees who receive a monthly payroll in excess of \$300,000.

But let's turn back the pages of time and see a few of the factors that have been responsible for the firm of Barrett & Hilp as it stands today.

J. Frank Barrett and Harry H. Hilp first met while they were in the employ of the old time successful contracting firm of Mahoney Bros. It was about 1908 and the Mahoneys were busy rebuilding the Palace Hotel in San Francisco which had been destroyed by the earthquake and fire of 1906.

As the days came and went, Frank and Harry used to discuss and make plans over the lunch counter for combining their talents into a new construction firm, and when the firm of Barrett & Hilp was finally organized their first efforts were limited to specializing as sub-contractors in the build-



"BUILDERS OF THE WEST" . . .



Albert F.  
Roller,  
Architect

**INDUSTRIAL EXPANSION** on the West Coast includes the manufacturing plant of the Schlage Lock Company in San Francisco. The top illustration shows the front elevation of one of the more recent additions, while the lower picture shows an interior of the same building.

*Photos by Edgar N. Goldstine*



ing of cement sidewalks and a few minor concrete structures.

Success marked their activities from the very beginning and as newer and greater opportunities presented themselves Barrett & Hilp were quick to take advantage of them. Soon they were engaged in doing major construction work and notable among their earlier projects were a number of important buildings at the Panama Pacific International Exposition.

Keeping pace with the development of the firm's activities, new and enlarged offices were occupied in the Sharon Building on New Montgomery street in 1917, and with the era of the "lush twenties" Barrett & Hilp engaged in many important construction contracts including a six-story addition to Livingston Bros. Department Store, a concrete factory building for the Simmons Company, additions to Temple Emanuel, St. Mary's Hospital (all in San Francisco); the Providence Hospital in Oakland, and a large government hospital at Mare Island.

Thus Barrett & Hilp developed early in their business career a practical experience, as well as technical "know-how" peculiar to many types of construction, particularly hospital construction, which later brought them many similar contracts throughout California.

Other contracts fulfilled in the early days of their business career included a reinforced concrete under-pass in South San Francisco for the

California State Highway Commission and a group of large, sales, buildings along Auto Row on Van Ness Avenue.

The stock-market crash of 1929 and the ensuing general business depression took its toll from them, as it did all others in the construction industry. They and their organization, however, took these depression hardships in stride. In 1932 at the height of the depression Barrett & Hilp were awarded the contract for the concrete anchorages at the North and South approaches to the Golden Gate Bridge. This award, however, came only after they, with 100,000 other public spirited individuals in the Bay Region, had formed the Golden Gate Bridge and Highway District, and the district had voted and sold \$35,000,000 in bonds for construction purposes. Actual start of construction did not take place until 1933 and the work was completed in 1937. At one time, in order to keep their organization intact, they had as many as twenty-five of their foremen and lead men working with their tools on the Golden Gate Bridge contract.

The completion of the Golden Gate Bridge anchorages marked a milestone in their career. Following the economic dip of 1937 they participated in the expansion of private and public construction until the outbreak of World War II when every facility of the firm was devoted to government work. Some of the more important projects completed during this time were in the field of Prefabricated War Housing where 500 FPHA Units

**General Warehouse Company's new FEDERAL SUPPLY CENTER being built in South San Francisco. The General Warehouse Company is a subsidiary of the Parr-Richmond Industrial Corporation and the Supply Center is under the direct jurisdiction of the General Services Administration.**



WARD & BOLLES, Architects



**TOP:**—General view of the Crescent Park Residential Addition to the City of Palo Alto. Comprising some 1200 units the development required three years to complete.



**LEFT:**—Interior view showing the Living Room in a typical home.

**BOTTOM:**—Close up view of one of the individual homes . . . shows some of the construction detail.

*Photo's by Gene's Studio*



were constructed at Ft. Leonard Wood in Missouri at a cost of \$1,500,000; One thousand FPHA Units were built at Vallejo, California, at a cost of \$2,500,000; and 5000 FPHA Units were built at Norfolk, Virginia, at a cost of \$16,000,000.

War time contracts with the United States Maritime Commission included the building of twenty Concrete Ship-shaped barges and a shipyard for them at the Belair Shipyard in South San Francisco costing \$28,000,000.

The list of projects completed for the U. S. Navy during and since the War includes construction at

the Hunters Point Drydock, San Francisco, \$13,500,000; Mare Island Navy Yard at Vallejo, \$30,000,000; and the Port Chicago Ammunition Dump, \$9,000,000.

#### HOUSING

With characteristic alertness Barrett & Hilp have taken a leading part in the post-war industrial expansion throughout the West. The firm has responded to the demands of the public for better housing; to private industry for expanded industrial and commercial plant facilities; and to gov-

#### NEWEST SEARS, ROEBUCK & CO. BUILDING

Now being erected at the corner of Geary Blvd. and Masonic Ave. in San Francisco. Is one of the most modern department store buildings to be built since the war.

#### CONSTRUCTION view of right.

Artist conception of the completed structure below.

W. E. PUGH, Architect

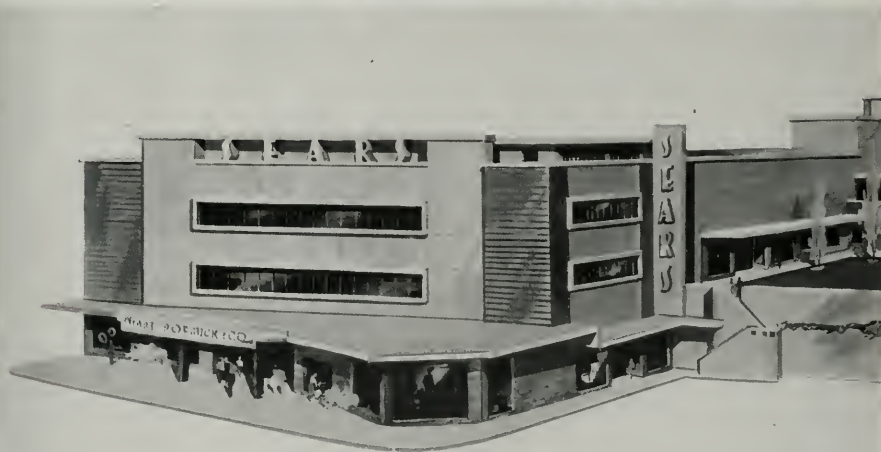



**"BUILDERS OF THE WEST"  
BARRETT & HILP**

Among the building materials manufacturers, jobbers and allied industries, the following firms (whose advertisements appear in this issue of *Architect & Engineer* magazine) have enjoyed friendly relationships with Barrett & Hilp in their progressive program of building with the west:

ACME MANUFACTURING CO., INC., Millwork  
San Francisco

ALTA ROOFING COMPANY, Roofing & Water-  
proofing, San Francisco—Los Angeles

CAPITAL CITY PAINTERS & DECORATORS,  
Painting & Decorating, Sacramento

CENTRAL ELECTRIC COMPANY, Power & Light  
Installations, San Francisco—Redwood City

ANGELO J. DANERI, Lathing & Plastering Con-  
tractor, San Francisco

DICKSONS LUMBER CO., Lumber, San Fran-  
cisco—San Rafael

DONOVAN BUILDING SPECIALTIES CO., Uni-  
versal Aluminum Windows, Berkeley

J. F. ECKER, General Painting Contractor,  
Stockton

ENGINEERED METALS, INC., Metal Doors &  
Jambs, San Francisco

FAIR MANUFACTURING COMPANY, Structural  
Steel, Ornamental Iron, San Francisco

GLADDING, McBEAN & COMPANY, "Ludowici-  
Celadan" Shingle Tile, San Francisco

P. GRASSI & CO. & AMERICAN TERRAZZO CO.,  
Pre-Cast Concrete Products, San Francisco

HAWS DRINKING FAUCET CO., Drinking  
Faucets, Equipment, Berkeley

E. M. HUNDLEY HARDWARE CO., Builders  
Hardware, San Francisco

KRAFTLE COMPANY, Tile & Brick, Niles

HARRY LEE PLUMBING & HEATING CO.,  
Plumbing & Heating, Burlingame

S. F. JOHNSON CO., Oil Burners, Oakland

MICHEL & PFEFFER IRON WORKS, INC., Aris-  
ton Metal Windows, South San Francisco

MURPHY BRO'S., Lathing & Plastering Con-  
tractors, Oakland

PACIFIC PORTLAND CEMENT CO., Golden  
Gate Stucco & Cement, San Francisco

PITTSBURGH TESTING LABORATORY, Engi-  
neers & Chemists, San Francisco

REGAL ROOFING COMPANY, Roofing, San  
Francisco

ROLANDO LUMBER CO., INC., Lumber, San  
Francisco

SCOTT COMPANY, Plumbing, Heating, Venti-  
lating, San Francisco - Oakland - Los Angeles

F. W. SPENCER & SOW, INC., Plumbing, Heat-  
ing Contractors, San Francisco

THE STANLEY WORKS, Hardware—Tools, New  
Britain, Conn.

STEEFORM CONTRACTING COMPANY, Steel  
Forms, San Francisco—Los Angeles

C. E. SWIFT ROOFING COMPANY, Roofing,  
Waterproofing, Insulation, Stockton

VERMONT MARBLE COMPANY, Marble &  
Granite Veneer, San Francisco—Los Angeles

EMIL J. WEBER, Electrical Contractor, San  
Francisco

WESTERN ASBESTOS COMPANY, Acousti-  
Celotex, San Francisco

ernmental agencies for building-up defense facil-  
ities.

Since 1947 the firm has constructed and sold ap-  
proximately 1200 houses in and around the vicinity  
of Palo Alto, California, for the most part in the  
Crescent Park Addition, and have been one of the  
leaders in the district in giving maximum value to  
both veterans and civilian purchasers with sales  
in this one project amounting to more than \$15,-  
000,000.

**INDUSTRIAL**

Barrett & Hilp have also served many of Cali-  
fornia's leading industries in the construction field

and the records show that contracts have been  
completed for the Standard Oil Company's grease  
packaging plant at Richmond, California, \$2,500,-  
000, with Wilbur D. Peugh the architect; a new  
plant was built for the Western Crown Cork and  
Seal in San Mateo County, bordering the city  
limits of San Francisco, \$1,900,000, with Albert F.  
Roller the architect; 136 housing units were fabri-  
cated and erected for the Standard Vacuum Oil  
Company in Sumatra, East Indies, at a cost of  
\$1,000,000, Skidmore, Owens & Merrill being the  
architects; a \$3,000,000 factory building for the



**ST. CATHERINE  
CHURCH**

Burlingame

This is one of the  
most recent churches  
to be built on the  
West coast.

The attractive use of  
Olive Green, Dark  
Green and Purple  
Black "Ludowici-  
Celadan" light  
weight shingle tile  
makes it one of the  
most attractive  
churches of today.

**MARTIN RIST,  
Architect**

GOLDSTINE & HEISER, Architects

**TELEVISION STUDIO KRON**

Mount San Bruno

Entrance detail of the KRON  
Television Studio erected on  
top of Mount San Bruno, San  
Mateo County.



**THE GLEASON  
LIBRARY**

One of the newer buildings on  
the campus of the University of  
San Francisco.

Other noted landmarks seen  
in the background.

MILTON PFLUEGER  
*Architect*





**CALIFORNIA FARM  
BUREAU FEDERATION  
BUILDING**

**Berkeley, Calif.**

**View of building as it was  
originally designed by archi-  
tect Jas. PlacHECK.**



**AFTER REMODEL**

**The California Farm  
Bureau Federation  
Building takes on an  
entirely new appear-  
ance.**

**Michael Goodman,  
Architect**

*Photo by  
Mason Weymouth*

**MAIMONIDES HEALTH  
CENTER**

San Francisco

Eric Mendelsohn, Architect

View at right shows glass enclosed ramp from second floor to roof, while center of building also has ample windows for sun and daylight.

View below shows South exposure with maximum provision for sun . . . immediate foreground is open-air enclosed court with ramp approach from the street.





## "BUILDERS OF THE WEST" . . .



### DWINELLE HALL

University of California campus at Berkeley.

Pouring concrete during one phase of construction.

Architects:

Weihe, Frick & Kruse

*Photo by Edgar M. Goldsine*

Masonite Corporation of Laurel, Mississippi, was built at Ukiah, California, Frank G. Lesniak, Chief Engineer; a \$2,000,000 factory building for the Pacific Paint and Varnish Company in Berkeley, Ellison & King, Structural Engineers.

A one-story warehouse containing 560,000 sq. ft. of tilt-up concrete construction was built in South San Francisco for the General Warehouse Corpo-

ration of which Fred Parr & Associates are the owners and Ward & Bolles the architects, cost \$1,500,000; Radio stations KRON-KNBC TV and FM were built on Mount San Bruno in Daly City at a cost of \$200,000, Goldsine & Heiser, architects; a new 50,000 watt transmitter station for the Columbia Broadcasting Company at Novato in Marin County, \$300,000, Arthur H. Hayes, Vice-president

### East View of the new Classroom and Office Building . . . U. C.





**DETAIL** of the new \$2,500,000 Franklin High School at Stockton which represents one of the largest high schools in the nation.

*JOSEPH LOSEKANN, Architect*

and general manager—A. N. Cormack, Chief Engineer, and Ellison & King, Structural Engineers; and at present the firm is constructing a new retail sales store for Sears Roebuck & Company at Geary and Masonic streets in San Francisco at a cost of \$2,100,000, W. D. Peugh is the architect.

#### **CHURCH—HOSPITAL**

In the classification of church and hospital structures the firm has engaged in a number of contracts representing some of the outstanding churches and hospitals in California. The St. Catherine's Church in Burlingame, Martin Rist, Architect, and Monsignor Thomas F. Cummings, Pastor,

cost \$400,000; a 100 bed Memorial Hospital was built in Santa Rosa at a cost of \$1,750,000, Frank T. Georgeson, architect; the \$1,500,000 St. John's Hospital at Oxnard, California, Frank T. Georgeson, architect; the Miamondes Health Center for the Chronic Sick at 2356 Sutter street, San Francisco, Eric Mendelsohn, architect; \$900,000; and a \$4,200,000 287 bed O'Connor Hospital for the Sisters of Charity of St. Vincent DePaul in San Jose, Santa Clara County. Sister Berenice is president of the hospital, M. Aguolo & Quick, Frank T. Georgeson were the architects and engineers, Ellison & King the Structural Engineers, and Codrington Company the Mechanical Engineers.

**General View of the Franklin High School . . . Stockton, California**





**SANTA ROSA MEMORIAL HOSPITAL**

*FRANKLIN GEORGESON, Architect  
JAMES HURLBUT, Associate Architect*

**PUBLIC HOUSING**

Considerable work has been done in the field of Public Housing and among a number of projects under construction at the present time is the Castle Gardens development at the Castle Air

Force Base near Merced, California. This consists of a \$4,500,000 project of 500 housing units under the Wherry Act. Angus McSweeney is the architect. Another Wherry Act project under construction is a 100 housing unit "Hez Manor" being constructed at McClelland Air Force Base near Sacra-

**OUR NEW HOME**



One of Spencer's most recent heating contracts—the \$3,600,000 Franklin High School, Stockton, California, largest building of its type in the United States. Other completed jobs for Barrett & Hilp: St. Ignatius Gymnasium, San Francisco and Peralta Hospital, Oakland.

**F. W. SPENCER & SON, INC.**

**PLUMBING-HEATING CONTRACTORS**

437 Potrero Avenue • San Francisco • Phone UNDERhill 1-6412

When in need of  
PRINTING  
OR  
LITHOGRAPHY  
SEE US  
•  
PUBLICATIONS  
•  
PERIODICALS  
•  
LETTERHEADS  
•  
STATIONERY  
•  
BOOKS  
•

The Architect & Engineer has been a product of our plant for over 20 years.



**MERCURY PRESS**  
942 HOWARD ST.  
YUKON 2-2200



## ... "BUILDERS OF THE WEST"

**ENTRANCE and  
INTERIOR LOBBY**

**Santa Rosa Memorial  
Hospital.**

**Information desk shown at  
right of main door. Hall di-  
rectly in front of door leads to  
hospital proper.**

*Photos by  
Edgar N. Goldsine*

mento and costing \$900,000. Angus McSweeney is also the architect for this work.

### **GOVERNMENT PROJECTS**

While a number of construction projects have been completed by the firm for the U. S. Govern-

ment, probably one of the most outstanding jobs under construction at the present time is the Parks Air Force Base near Pleasanton, California. This project comprises an indoctrination center for the Air Force and comprises a series of frame build-

## **PAINTING ON THE U. C. CLASS ROOM AND OFFICE BUILDING**

BERKELEY • CALIFORNIA

by CAPITAL CITY  
PAINTERS & DECORATORS

Gerald W. Putnam, *Owner*

Route 2, Box 2022, Sacramento, California  
Phone: HILLerest 7-5094

## **CENTRAL ELECTRIC COMPANY, INC.**

*Power and Light Installations*

610 THIRD STREET • SAN FRANCISCO  
Telephone EXbrook 2-2180

Branch Office 556 El Camino Real  
Redwood City • Emerson 6-4084

**MORE THAN FORTY YEARS OF SERVICE**

## *A good job of* **LATHING & PLASTERING**

### **DWINELLE HALL**

University of California  
Berkeley

### **MURPHY BROS. PLASTERING CONTRACTORS**

3314 School Street • Oakland

Phone: KEllog 4-3399





MASONITE CORP'N UKIAH, CALIFORNIA PLANT

## Roofing—Waterproofing INSULATION

Franklin High School, Stockton

C. E. SWIFT ROOFING CO.

2241 E. Miner Avenue  
Stockton, California

ings for use as a fully integrated indoctrination center with all of the required facilities. The design and construction supervision is by the San Francisco District Engineers, Corps of Engineers, and the construction is by the "Four Companies" representing a joint venture of Barrett & Hilp, Sponsor; the Theo. G. Meyer & Son; Chas. L. Harney, Inc., and Macco Construction Company.

The present construction program will entail an expenditure at this time of approximately \$33,000,000, and it is believed subsequent appropri-

## STRUCTURAL STEEL

Miscellaneous and Ornamental  
Iron

FAIR MANUFACTURING CO.

Since 1911

617 Bryant Street, San Francisco  
Phone: SUtter 1-5001

## PRESSED METAL DOORS AND JAMBS

In Sears-Roebuck Building  
San Francisco

Furnished by

ENGINEERED METALS, INC.  
575 Mission Street • San Francisco

## FACTORY MADE CONCRETE

PRE-CAST CONCRETE PRODUCTS

### Structural

- Beams
- Jaists
- Roof Slabs
- Wall Panels
- Floor Slabs

### Functional

- Mo-Sai Facing Slabs
- Art Marble
- Terrazzo
- Steps
- Cast Stone
- Shower Receptors
- Toilet Partitions

### Specialties

- Retaining Wall Cribbing
- Fence Posts
- Barrier Posts
- Spacer Blocks
- Curbing

P. GRASSI & CO. AND AMERICAN TERRAZZO CO.

211 South Maple Avenue

South San Francisco, California

JUNiper 4-9455



Photos by  
Don Crawford

ABOVE:—Close-up of the new Masonite Corporation's manufacturing plant at Ukiah, California

Designed by Frank G. Lesniak, C. E. Gen. Mgr. E. T. F. Wollenburg.

BELOW:—Interior view of one of the larger buildings . . . minimum obstruction to open floor space.



## MILLWORK

For many of the Barrett & Hilp Buildings shown in this Issue

Furnished by

**Acme Manufacturing Co., Inc.**

345 Bayshore Blvd., San Francisco

Telephone: VAlencia 4-8387



**DONOVAN  
UNIVERSAL  
ALUMINUM  
WINDOWS**

Franklin High School, Stockton  
Bishop Jas. T. O'Dowd School,  
Oakland

Two notable Barrett & Hilp  
Contracts equipped with  
DONOVAN WINDOWS



**DONOVAN BUILDING SPECIALTIES CO.**

Engineering • Soles • Installation

950 PARKER STREET • BERKELEY 10, CALIFORNIA

## "BUILDERS OF THE WEST" . . .

ations will become available to materially increase this amount.

### EDUCATIONAL BUILDINGS

A number of outstanding contracts have been completed and entered into involving the construction of educational buildings and in this group among the more notable is the Gleeson Memorial Library built on the campus of the University of San Francisco at a cost of \$925,000. Rev. Wm. J. Tobin, S.J., President, and Milton Pflueger was the architect. A \$2,100,000 Class-Room and Office

## Roofing and Waterproofing

CONTRACTORS

### ALTA ROOFING CO.

976 Indiana Street, San Francisco  
Phone: MISSION 7-2173

1837 West Gage St., Los Angeles  
Phone: THORNWALL 3176

Lathing and Plastering

in the

Sears, Roebuck Building

by

## Angelo J. Daneri

*Lathing and Plastering  
Contractor*

1433 FAIRFAX AVENUE

SAN FRANCISCO

Phone: ATwater 8-1582



### GRAIN ELEVATOR PLANT

For the Port of Sacramento, Sacramento Yolo Port District of West Sacramento, W. C. Stone, Port Director. Joint contractors Barrett & Hilp, Henry George & Sons.

Building was built for the University of California at the Berkeley campus of which Weihe, Frick & Kruse were the architects. The new Mercy High School was built for the Sisters of Mercy at 19th and Rossmor, San Francisco, at a cost of \$960,000, Martin Rist, architect; and the Franklin High School was built for the Stockton Board of Education in Stockton, California, at a cost of \$2,300,000. Joseph Losekann was the architect.

### MODERN POLICIES

Most of the projects mentioned in this article and particularly those which have been classified as "industrial" and "churches and hospitals," were obtained by consultation with the owner, his architects and engineers. The resulting contract on each

## PLUMBING HEATING

in St. Catherines Church  
BURLINGAME

### Harry Lee Plumbing & Heating

1345 ROLLINS ROAD • BURLINGAME

Telephone DI 3-1891



\$35,000,000 GOLDEN  
GATE BRIDGE

Longest and tallest single span suspension bridge in the world joins metropolitan San Francisco with north-bay counties. Note large concrete towers at left which serve as anchor for cables and also support the bridge deck.

## E. M. HUNDLEY HARDWARE CO.

*Specialists in*

### Builders Hardware



662 MISSION STREET      SAN FRANCISCO  
YUkon 2-3322

## REGAL ROOFING

One of our most recent jobs—St.  
Catherines Church, Burlingame

### REGAL ROOFING CO.

930 INNES AVENUE      •      SAN FRANCISCO  
Phone: VAlencia 4-3261

## STEEFORMS

FOR  
CONCRETE JOIST CONSTRUCTION  
ROUND CONCRETE COLUMNS

BEAM AND SLAB

AND FLAT SLAB

CONSTRUCTION

CONCRETE WALL FORMS

Rentals Including Installation

## STEEFORM CONTRACTING CO.

666 HARRISON ST. — SAN FRANCISCO  
833 E. GAGE AVE. — LOS ANGELES



## "BUILDERS OF THE WEST" . . .

job was usually in the form of a guaranteed maximum cost, including the contractor's fee. The entire savings resulting from the guaranteed maximum cost were usually reverted entirely back to the credit of the project owner, thus reducing the ultimate costs.

Barrett & Hilp have long advocated this type of contract and have been very successful in such operations.

Among the advantages of this type of contract

### EMIL J. WEBER

*Electrical Contractor*

258 Dorland St., San Francisco

Phone: UNderhill 1-2200

### J. F. ECKER

**General Painting Contractor**

*30 years in business*

*Specializing in Schools, Civic Buildings  
and all types of Commercial Structures  
throughout Northern California*

418 E. LAFAYETTE STREET

Stockton, California

Phone: 3-2479



**MARIN COUNTY APPROACH  
GOLDEN GATE BRIDGE**

**Showing huge concrete anchorage for suspension cables and deck of bridge.**

are: 1) From the preliminary studies a preliminary estimate is made and the owner can thus ascertain very closely the final cost of the project from such advance estimate supplied by the contractor. It thus enables the starting of the project before final plans and specifications are completed thereby eliminating a great deal of lost time; 2) It facilitates changes in design and planning before and during the construction period; 3) Through accounting procedure which is set up as a part of the contract,

(See Page 55)

### PITTSBURGH TESTING LABORATORY ENGINEERS AND CHEMISTS

Testing and Inspection of Concrete, Steel and  
Other Structural Materials

Design of Concrete Mixes

Offices in all principal cities

**651 Howard St., San Francisco 5**  
EXbrook 2-1747

## MODEL BUILDING CODE

(From Page 18)

It consists of a preamble and 12 sections: (1) Purpose; (2) Scope; (3) Amendment of Other Ordinance Provisions; (4) When Alternate or Substitute Materials and Methods Are Authorized; (5) Form of Determining, Findings of Fact; (6) Validity of Permit; (7) Records, Filings and Publication; (8) Procedural Rules and Regulations Governing Application for Permits; (9) Penalties; (10) Right of Appeal; (11) Effective Date; (12) Severability.

### LUKE AIR FORCE BASE AUXILIARY BEING READIED

The U. S. Army Corps of Engineers has contracted with the Daley Construction Company of Phoenix, Arizona, for the rehabilitation of the air field landing strips which were used during the last war as an auxiliary to Luke Field.

The job includes extending runways to provide for jet planes, as well as repairing and resurfacing the old runways.

### NEW DEAN APPOINTED FOR DAVIS CAMPUS

Dr. Herbert A. Young, professor of chemistry, has been appointed dean of the College of Letters and Science recently established on the Davis campus of the University of California.

# Save FUEL Oil!

CHANGE OVER NOW  
TO A MODERN, AUTOMATIC

## JOHNSON Oil BURNER!

If you have a wasteful, worn out burner . . . or a burner that fails to give you peak efficiency, you ought to switch over to an oil-saving Johnson Burner right now. Johnson Burners deliver more usable heat from every gallon of oil you buy. Ask your heating engineer. He knows Johnson's 48 year reputation for dependable, engineered-efficiency. You'll find a Johnson Dealer nearby.

THERE'S A  
JOHNSON BURNER  
FOR EVERY  
HEATING NEED

*Domestic  
Industrial  
Commercial*



### S. T. JOHNSON CO.

940 Arlington Ave.  
Oakland 8, California  
401 No. Broad Street  
Philadelphia 8, Pa.

# BRONZE PRODUCTS by GREENBERG

Your best and nearest source for standard and special Bronze products



STABILITY since 1854

## M. GREENBERG'S SONS

765 Folsom St. - San Francisco - Calif. - EXbrook 2-3143

Manufacturers of Fire Hydrants and Fire Protection  
Brass Goods • Industrial, Navy and Maritime  
Bronze Valves and Fittings • Plumbing and  
Hardware Brass Specialties • Bronze Plaques,  
Letters and Name Plates.

LOS ANGELES • SEATTLE • PORTLAND • SPOKANE • SALT LAKE CITY • DENVER • EL PASO • NEW YORK • HARTFORD • WASHINGTON, D. C.

# American Institute

Glenn Stanton, President  
 Kenneth E. Wischmeyer, 1st Vice-president  
 Norman J. Schlossman, 2nd Vice-president  
 Clair W. Ditchy, Secretary  
 Maurice J. Sullivan, Treasurer



# of Architects

National Headquarters —  
 1741 New York Avenue, N. W.  
 Washington 6, D. C.

Edmund R. Purves  
 Executive Secretary

#### Arizona Chapter:

Edward L. Varney, President; Ralph B. Haver, Secretary,  
 P. O. Box 786, Phoenix, Arizona.

#### Central Valley of California:

William Koblik, President; Gordon Stafford, Vice-President;  
 John W. Bomberger, Secretary; Albert E. Thomas, Treasurer,  
 Secretary's Office, P. O. Box 1943, Modesto.

#### Coast Valleys Chapter:

William F. Hempel, President; Lawrence Gentry, Vice-  
 President; Walter Strangquist, Secretary-Treasurer, Secre-  
 tary's office, 321 Channing Ave., Palo Alto.

#### Colorado Chapter:

Paul Atchison, President; James M. Hunter, Vice-President;  
 Dudley T. Smith, Secretary; Victor Hornbein, Treasurer,  
 Offices 1254 Monaco Parkway, Denver.

#### Northern California Chapter:

Francis J. McCarthy, President; Albert R. Williams, Vice-  
 President; Wendell R. Spackman, Secretary; Helen D.  
 French, Treasurer, Offices 989 Fine Street, San Francisco.

#### Oregon Chapter:

Herman Brookman, President; Donald J. Stewart, Vice-  
 President; Raymond Kermit Thompson, Secretary; Millard  
 H. Schmeer, Jr., Treasurer, Secretary's office 429 S. W. 4th  
 Avenue, Portland.

#### Pasadena Chapter (California):

Culver Heaton, President; Don Neptune, Vice President;  
 Arthur Frick, Treasurer; (Mrs.) Dorothy Gray, Secretary,  
 Directors, John N. Douglas, Boyd Geary, Roland E. Coate  
 and Burton Ramberger, Office 1041 East Green St., Pasa-  
 dena.

## ILLINOIS SOCIETY OF ARCHITECTS ELECT

The Illinois Society of Architects at its recent 54th Annual Election named the following officers and directors for the ensuing year:

F. M. Bernham, President, Chicago; Benjamin F. Olson, 1st Vice-President, Chicago; A. Reyner Eastman, 2nd Vice-President, Rockford; Edgar Martin, Treasurer, Chicago; Alfred Schimek, Secretary, La Grange; and Gerald L. Palmer, Financial Secretary, Chicago. Robert W. Loyer and

Alexander L. Levy were named directors for a three year term.

## UNIVERSITY OF DENVER SCHOOL OF ARCHITECTURE

The University of Denver, School of Architecture and Planning, recently announced their Fall Bulletin for 1951, containing information pertaining to Entrance Requirements, Basic Curriculum covering five years of study, and the Faculty.

The Bulletin is unique in that a number of student projects have been included as examples of the type of study, and a number of allied student activities in the architectural profession have been illustrated.

Complete information about the school is available from the Director of Admissions, University of Denver, Denver 10, Colorado.

## SOUTHERN CALIFORNIA CHAPTER

The regular August meeting was highlighted by a illustrated talk on the subject "How Europe is Rebuilding" by Harper Goff, internationally recognized motion picture designer, magazine illustrator, and musician extraordinary. Stanley Gould, chairman of the Legislative Committee gave a report on the activities of his committee during 1951 and announced a number of suggested plans for the ensuing year.

Robert Thomas, Chairman of the Education Committee, announced the August meeting of his group would be devoted to a discussion of N.P.A. Regulations.

NEWS NOTES: Edward Fickett, Chm., A. Q. Jones, William Ruck, Ted Criley, Jr., Hugh Gibbs, and H. C. Burge have been named a special subcommittee to study housing fees; William Wurster, Lawrence B. Perkins, and Nathaniel A. Owings,

**SPEED CONSTRUCTION**  
**WITH FIRESAFE, SAG-PROOF**  
**EASY-TO-USE**

**STRAN-STEEL**

**AVAILABLE**

**STEEL FRAMING**

**"Metal Lumber"**

**\*PROMPT DELIVERIES ON**

**STUDS · JOISTS · CHANNELS**

**IN STANDARD SIZES**

*For complete information and prompt service, phone or write*

**KRAFTILE COMPANY**

NILES, CALIFORNIA NILES 3611  
 SAN FRANCISCO 5: 50 Hawthorne St.—DOUGLES 2-3780  
 LOS ANGELES 13: 406 South Main Street—MUTUAL 7241

**East Bay Chapter:**

Harry A. Bruno, President; Chester H. Treichel, Vice-President; Ira D. Bealis, Secretary; Cecil S. Meyer, Treasurer. Secretary's office, 1444 Webster St., Oakland.

**Montana Chapter:**

E. Edward Swacrott, President (Billings); J. Van Teylingen, Vice-President (Great Falls); H. C. Cheever, Secretary-Treasurer. Secretary's office, Bozeman.

**Nevada Chapter:**

George L. F. O'Brien, President; Aloysius McDonald, Vice-President; Graham Erskine, Secretary; Edward S. Parsons, Treasurer. Offices 160 Chestnut St., Reno.

**Nevada State Board of Architects:**

L. A. Ferris, President, Reno; Walter Zick, Secretary, Las Vegas; Directors, Aloysius MacDonald, Las Vegas; Russell Mills and Edward Orsons, Reno. Office, P. O. Box 2107, Las Vegas, Nevada.

**Pasadena Chapter:**

Culver Heaton, President; Don Neptune, Vice-President; Arthur Frick, Treasurer; Mrs. Dorothy Gray, Secretary. Directors John N. Douglas, Boyd George, Roland E. Coote, and Burton Romberger. Offices 1041 E. Green St., Pasadena 1.

**San Diego Chapter:**

Jack R. Lewis, President; Louis A. Dean, Vice-President; Donald Campbell, Secretary; Victor L. Wulff, Jr., Treasurer. Directors C. J. Paderewski, G. C. Hatch. Secretary office, 1250 Prospect St., La Jolla.

**San Joaquin Chapter: (California)**

Fred L. Swartz, President, Fresno; Lloyd J. Fletcher, Vice President, Visalia; Walter Wagner, Secretary, Fresno; Robert W. Stevens, Treasurer, Fresno. Directors: Alastair Simpson, William D. Coats, William F. Baxter. Maurice J. Metz, Delegate California Council of Architects. Office, Sec. Fulton-Fresno Bldg.

**Santa Barbara Chapter (California):**

Robert I. Hoyt, President; Harold E. Burket, Vice-President;

Roy W. Cheesman, Secretary; Lutah M. Riggs, Treasurer. Address, 242 San Marcos Bldg.

**Southern California Chapter:**

John I. Landon, President; Chas. Frey, Vice-President; C. Day Woodford, Secretary; Wm. G. Balch, Treasurer. Directors, Paul O. Davis, Henry Wright, John Rex, and Kemper Nominal. Ex. Sec. Rita E. Miller. Chapter Headquarters, 3723 Wilshire Blvd., Los Angeles 5.

**Spokane Chapter:**

Harold E. Edley, President; Harry C. Weller, Vice-President 1; Kenneth D. Stormont, Vice-President 2; Victor L. Wulff, Secretary, and Carl Johnson, Treasurer. Office 1023 W. Riverside Ave., Spokane, Washington.

**Utah Chapter:**

Howell O. Cannon, President; William J. Monroe, Jr., Secretary, 3707 South 32nd West Street, Salt Lake City 7, Utah.

**Washington State Chapter:**

Paul Thiry, President; John S. Dettle, 1st Vice President; Walter H. Rothe, 2nd Vice President; Robert H. Dietz, Secretary; Lawrence G. Waldron, Treasurer. Office 714 American Building, Seattle 4.

**Tacoma Society:**

E. M. Dugan, President; P. G. Ball, Vice-President; Lyle Swedberg, Secretary-Treasurer.

**Hawaii Chapter:**

James C. Simms, President; Alfred Preis, Secretary, 1507 Kapalani Blvd., Honolulu, T. H.

**CALIFORNIA COUNCIL OF ARCHITECTS**

John L. Rex, President; Wm. Koblitz, Vice-President; Maurice J. Metz, Secretary-Treasurer. Executive Secretary office 3723 Wilshire Blvd., Los Angeles.

**OTHER ARCHITECTURAL ORGANIZATIONS**

**San Francisco Architectural Club:**

Alfred R. Kirkevold, President; Charles Dennis, Vice President; William C. Thomsen, Treasurer; Milton Bromberg, Secretary. Office 507 Howard Street.

have been appointed Awards Jury for the 1951 Honor Awards program. Henry Eggers is Chairman of the Honor Awards. Until further notice the Chapter office will be closed on Friday's.

**LOS ANGELES WOMEN'S ARCHITECTURAL LEAGUE**

The annual Home Tour sponsored by the Los Angeles Women's Architectural League, has been scheduled for two days this fall, according to an announcement by Mrs. Ted Criley, Jr.

One tour will be held on Sunday, September 16th and the other will be held on Sunday, September 23rd, and a special feature of this year's event will be that the architect will act as host at the house he designed.

Tickets for either one, or both, of the tours may be obtained from Mrs. Whiting S. Thompson, Mrs. Herman C. Light, Mrs. Henry L. Wright and Mrs. Kenneth Johnson.

**LONG BEACH ARCHITECTS DISPLAY AT ART CENTER**

A large number of architectural models, photographs, and renderings showing work done by Long Beach architects were recently on display at the Long Beach Municipal Art Center which is under the direction of Long Beach City Librarian Edwin Castagna.

The exhibit included numerous residences, schools, churches, and industrial and commercial buildings.

**NORTHERN CALIFORNIA CHAPTER**

Charles O. Matcham, A.I.A., newly elected Regional Director of the Sierra Nevada District of

The American Institute of Architects, was the guest of honor at the July meeting, which included a joint meeting of the East Bay Chapter, the Coast Valleys Chapter, and the Northern California Chapter.

Matcham discussed a number of important phases of the architectural profession and urged all present to attend the annual conference of the California Council of Architects at Hotel Coronado, October 4-6.

NEWS NOTES: Heryv P. Clark's Diamond Heights exhibit was daylighted at Macy's Department Store; Ralph Pollack luncheon of "appreciation" was success; the Junior Associates swam and barbecued as guests of Mr. and Mrs. William H. Rowe and Victor Abrahamson at the home of Mr. and Mrs. Herbert Schick in Hillsborough; Victor Abrahamson continues to meet Marjorie Trumbull each Friday on her "Exclusively Yours" KRON-TV program; Richard Clark, Clay Brick and Tile Association, spoke at recent Construction Seminar on properties of Structural Clay.

**A.I.A. PREPARING MANUAL ON MODULAR CONSTRUCTION**

The office of the Secretary for Modular Coordination of The American Institute of Architects has recently been awarded a contract by the federal Housing and Home Finance Agency to promote the use of modular construction through the preparation of a manual.

The project is under the direction of William Demarest, Jr., Secretary of Modular Coordination. The manual itself is to be directed at building

(See Page 50)



# WITH THE ENGINEERS

Structural Engineers Association of California  
Arthur W. Anderson, President; Harold P. King, Vice-president; Henry J. Degenkolb, Sec.-Treas.; Office of Sec., 405 Montgomery St., Room 1121, San Francisco.

Structural Engineers Association of Northern California  
John E. Rinne, President; John J. Gould, Vice-President; Wm. W. Brewer, Sec.; Franklin P. Ulrich, Treas.; Directors, Walter L. Dickey, Leslie W. Graham, Hyman Rosenthal, and Howard A. Schirmer.

Structural Engineers Association of Central California  
William H. Petersen, President; Walter S. Wassum, Vice President; O. T. Illerich, Sec. Treas.; Ernest D. Francis, M. A. Ewing, and Arthur A. Sauer, directors. Office O. T. Illerich, c/o Div. of Arch., Sacramento.

American Society of C. E.  
San Francisco Section  
Clement T. Wiskocil, President; John S. Longwell, Vice-president; J. G. Wright, Vice-president; H. C. Medbery, Treasurer; R. D. Dewell, Secretary. Secretary's Office, 604 Mission St., San Francisco.

Structural Engineers Association of Southern California  
Donald F. Shugart, President; Harold P. King, Vice President; Robert J. Short, sec-Treas.; Directors, William T. Wheeler, William T. Wright, Ernest C. Hillman, Jr., John Case, and John K. Minasian. Office, 202 Architects Bldg., Los Angeles 13.

Structural Engineers Association of Oregon  
R. Evan Kennedy, President; Guy H. Taylor, Vice President; James R. Griffith, Secretary-Treasurer; Directors Jerome A. McDevitt, H. Loren Thompson, and Robert L. Tidball. Offices, Portland.

Puget Sound Engineering Council (Washington)  
R. E. Kister, A. I. E. E., Chairman; E. R. McMillan, A. S. C. E., Vice Chairman; L. B. Cooper, A. S. M. E., Secretary; A. E. Nickerson, I. E. S., Treasurer. Offices, L. B. Cooper, c/o University of Washington, Seattle 5, Washington.

American Society Testing Materials Northern California District  
L. A. O'Leary, Chairman; P. V. Garin, Vice-chairman; H. P. Hoopes, Sec. Office Sec., 1550 Powell St., Emeryville, Calif.

Society of American Military Engineers—San Francisco Post  
Capt. Cushing Phillips, CEC, USN, President; Col. W. C. Baker, Jr., CE, USA, Vice President; Robert P. Cook, Secretary; Levant Brown, Treasurer. Directors: Rear Admiral L. N. Moeller, CEC, USN; Capt. H. F. Ransford, CEC, USN; Clyde Bentley; Prof. Harmer E. Davis, Lieut. Col. James D. Strong, CE, USA; and Lieut. Col. Henry M. Smalley, CE, USA.

## ELECTRICAL MAINTENANCE ENGINEERS ASSOCIATION SOUTHERN CALIFORNIA

One hundred and fifty-five members of the E. M. E. A. of Southern California were present at the July meeting to enjoy a steak dinner and a talk on Electrical Safety Orders by E. V. Muller, mem-

ber of the Division of Industrial Safety of the State of California.

Muller covered more than twenty-one changes from the old code and differences from the national electric code.

Plans were announced for a cruise through the Los Angeles-Long Beach Harbor in a glass enclosed excursion boat as the setting for the August meeting by President Jack Rohring, and Vice-president George Larson will lead members on a September field trip to round out the summer's activities.

The first woman member of the E. M. E. A. will be presented at the August meeting.

## STRUCTURAL ENGINEERS ASSOCIATION OF CALIFORNIA

Reservation cards have been mailed out for attendance at the Annual Convention in Yosemite, October 11 to 13, and it is pointed out that "first come" "first served", so shoot them back pronto.

Arthur W. Anderson, President, reports plans are progressing for a well rounded program of technical papers and entertainment. Details of the Convention program will be made available in the near future.

## STRUCTURAL ENGINEERS ASSOCIATION NORTHERN CALIFORNIA

Francis T. Letchfield, Consulting Engineer and Assistant Vice-president of the Wells Fargo Bank & Union Trust Company was the principal speaker at the regular August meeting, speaking on the subject "An Engineer's Appraisal of the Current Outlook."



Always specify

**HAWS**

for Highest Quality

Sanitary Drinking Fountains

Electric Water Coolers

Drinking Faucets, Equipment, Filters and Accessories

• A reputation for reliability since 1909. Check in Sweets or write for HAWS catalog.

**HAWS DRINKING FAUCET CO.**  
1441 FOURTH STREET (Since 1909) BERKELEY 10, CALIFORNIA  
Agents and Sales Representatives in All Principal Cities

Rumbblings from The Old Hearst Ranch indicate the annual Engineers Picnic was a "terrific success" from the standpoint of weather, scenery and customers. Credit Orman Nishkian, Stan Bernhard and everyone who "pitched-in" during the formulative era.

The Convention Committee is seeking assistance on stimulating attendance at the Yosemite meeting in October.

#### FEMINEERS

The regular luncheon meeting of the Femeiners, San Francisco-Bay Area organization of the wives of Structural Engineers, was held August 15th at the Elks Club in San Francisco.

Guest speaker was Katherine Hanrahan, attorney, who gave a very interesting talk on the subject "What Is Your Will Today".

#### ENGINEER EARTHQUAKE REPORT IS AVAILABLE

The booklet entitled "Lessons in Structural Safety Learned from the 1949 Northwest Earthquake", written by Harlan H. Edwards, chairman of the Earthquake Committee, Seattle Section of the American Society of Civil Engineers, is now available from the Pacific Fire Rating Bureau, 465 California Street, San Francisco.

Inquiries pertaining to the material should be addressed to Karl Steinbrugge at the above address.

#### UNIVERSITY OF CALIFORNIA RESEARCH ENGINEERING

The engineering department on the Berkeley campus of the University of California ranks second among the nation's land grant college and university engineering departments in the amount of funds available for engineering research during 1950-51.

The figure of \$1,187,500, of which \$55,500 came from the University appropriations while \$1,132,000 came from other sources, was exceeded only by the University of Illinois which had a research fund available of some \$1,779,273 (\$479,273 from the University's funds and \$1,300,000 from other sources).

#### NEW TRAFFIC ENGINEERING LABORATORY IS APPROVED

Construction of a Mobile Test Vehicle Laboratory for the University of California's Engineering Field Station in Richmond has been approved and the regents have awarded a contract for the construction of a 40' x 100' laboratory. The steel structure will be ready for occupancy this fall.

The new building will provide space for offices, laboratories and various types of research vehicles including truck and trailer units for determining skid resistance of pavements and road roughness, units for measuring stress on bridges and other highway structures, and soil sampling devices.

#### AMERICAN MILITARY ENGINEERS SAN FRANCISCO POST

The August meeting of the Society of American Military Engineers, San Francisco Post, held at the Officers Club at Hunters Point, heard Rear Admiral Leon S. Fiske, U.S.N. speak on the subject "The Navy in Micronesia".

Admiral Fiske, graduate of the United States Naval Academy at Annapolis, 1916, and of the Naval War College, 1935, was in command of the Cruiser Savannah and participated in the initial American landings on North Africa in November 1942, and was awarded a letter of commendation for the excellent gunfire and aviation support rendered the landing party.

During the years 1944-45, he was in charge of Service Squadron Twelve in the South Pacific and in 1948 became Deputy High Commissioner of the Trust Territory of the Pacific Islands with headquarters on Guam. In 1951 Admiral Fiske was

(See Page 43)



Always  
Specify  
**HAWS**  
for Highest  
Quality

A complete line of coolers, fountains, faucets, equipment, filters and accessories. A reputation for reliability since 1909. Check in Sweet's or write for complete HAWS catalog.

#### HAWS DRINKING FAUCET CO.

1441 FOURTH STREET (Since 1909) BERKELEY 10, CALIFORNIA  
Agents and Sales Representatives in All Principal Cities

# PRODUCER'S COUNCIL PAGE

The National Organization of Manufacturers of Quality Building Materials and Equipment  
affiliated with THE AMERICAN INSTITUTE OF ARCHITECTS

President, Arthur C. Staat  
Natural Gas Equipment, Inc.  
1150 Folsom Street

Vice-President, Fred A. Figone  
Oils Elevator Company  
1 Beach Street

Secretary, Howard Noleen  
E. F. Hauserman Company  
500 Second Street

Treasurer, A. L. West, Jr.  
Aluminum Company of America  
Russ Bldg.

Edited by Carl B. Frank, DETROIT STEEL PRODUCTS CO.

## ANNUAL CONVENTION, CALIFORNIA COUNCIL OF ARCHITECTS

The annual convention of the California Council of Architects is to be held on October 4, 5, and 6th, at the Hotel Del Coronado in Coronado, California. The convention, as usual, is jointly sponsored by the California Council of Architects and the Los Angeles and San Francisco Chapters of the Producer's Council, Inc. As a background, this convention is held in the South one year and in the North the next, with the applicable chapter of the Producer's Council taking over the required committee duties according to the location of the convention. This year, of course, the Los Angeles Chapter is furnishing the committeemen with only one representative of each committee from the San Francisco Chapter. Primarily, the Producer's Council is responsible for handling the sports activities at the convention and, accordingly, the Los Angeles committees have been hard at work on this program. There will be some very nice prizes offered for the lucky winners in the various categories.

We urgently request that every member on the Producer's Council, for whom it is possible, attend this convention as it is the wonderful opportunity to enjoy the fellowship that exists between the members of the two organizations.

### EDUCATIONAL COMMITTEE

Over a period of time in some of the previous issues, we have briefly brought to your attention the activities of our newly formed educational committee under the committee chairmanship of Professor Herbert Duncan, B.S. M.S. and P.H.D. (At this point is would seem fitting to quote the long standing joke concerning just what "B.S.", "M.S.", and "P.H.D." mean. However, as you all know, this particular gag cannot be considered as exactly printable.)

To get back to the point, we feel that at this time it might be fitting to quote to you a portion of Herb's last report to Congress as follows:

"First of all to recap what has transpired this year and later to cover what we hope to be doing for the balance of the year. We had a total of ten bi-weekly programs at the University of California with a total attendance of 450 students. At these programs we showed either one or two moving pictures manufactured by the members of the Producer's Council. At the annual Architecture Department's Awards evening, Art Staat presented to one of the graduating students a fifty dollar book order given in the name of the San Francisco Chapter of the Producer's Council for outstanding work throughout the year. This was presented at the same time that the A.I.A. made their presentations.

As to the balance of the year, we have three projects on which we are working. First of all, we plan to continue our regular bi-weekly programs at the University of California. In addition to this, we plan making our pictures available to the lectures giving a course entitled, "Architectural Mechanics". These pictures will be used as a part of the classroom instructions. Our third project is one at Stanford. Here we intend to work with Birge Clark, architect of Palo Alto, who is teaching a course in architectural materials to the students at Stanford University.

As so aptly put by Herb Duncan, I am deeply indebted to him for the majority of the material contained in this article. However, as you will note in one of the earlier paragraphs, he has been bestowed three honorary degrees in the college of hard knocks and we, therefore, can consider the debt paid.

USE QUALITY PRODUCTS



CONSULT AN ARCHITECT

## WITH THE ENGINEERS

(From Page 41)

designated by the Department of State as a member of the United States Mission to the United Nations as Special Representative of the Trust Territory of the Pacific Islands, and at present he is serving as commander of the Mare Island Vallejo Area, U. S. Naval Base, San Francisco.

## PROFESSIONAL ENGINEERS' STUDY ENGINEERING-MANAGEMENT PROBLEMS

The National Society of Professional Engineers is conducting a public relations program as a research project to establish a "clearing house" for the two-way exchange of information and ideas on current engineering-management problems.

L. L. Dresser, Society president, reports a special advisory group will screen and advise on the contents of the topics selected for research survey questionnaires dealing with subjects of current major interest. The subject selected for the first questionnaire to be released to members is, "How To Improve Engineering-Management Communication". State societies, chapters, and individual members will be given an opportunity, together with employers of engineers, to report their experience and viewpoint. Following receipt of reports the information will be compiled and results made available to those participating.

## VAUD E. LARSON APPOINTED RECLAMATION BUREAU POST

Vaud E. Larson has been appointed head of the Bureau of Reclamation's Region 3 Branch of Project Planning with offices in Boulder City, Nevada, succeeding E. G. Njelson who has been named assistant regional director also with headquarters in Boulder City.

Larson will supervise the investigations in southern California, southern Nevada, most of Arizona, and areas in southern Utah and western New Mexico. Chief projects under study at present are the Central Arizona Project, Marble Canyon Dam, Glen Canyon Dam, Palo Verde Valley diversion and a second barrel of the San Diego aqueduct.

## HOUSING INFORMATION SOUGHT BY GOVERNMENTAL SMALL HOMES AGENCY

The Small Homes Council of the University of Illinois at Urbana, Illinois, in conjunction with the Housing and Home Financing Agency of the Federal government, is seeking information in conjunction with a wood framing project study, as relates to techniques and methods of wood construction as applied to residential units.

A laboratory analysis will be conducted evaluating structural, material, labor, and other basic

essential factors and the most promising systems indicated by the analysis will be field tested to determine total design efficiency.

The Council, through its Special Research Assistant, Leroy M. Cohen, is seeking data on all known structural systems of wood framing for residential construction; also truss systems for one and one-half story houses providing living space on the upper floor. Architects, builders, and contractors are urged to communicate their experiences with the Small Homes Council.

## STUDY SHOWS UNITED STATES CAN HAVE GUNS AND HOMES

A million new homes could be built in 1952, using only 2 per cent of the nation's total production of steel, an authoritative report just released by the National Association of Home Builders shows.

The million new homes would also only use 7 per cent of the total production of copper and 1½ per cent of the nation's aluminum.

The housing goal for 1951, as set by the Government, is a maximum of 850,000 units, which is a reduction of 39 per cent from the 1950 production of new homes and apartments. The low figure being set by the Government despite the fact that



**HOLLYWOOD JUNIOR**  
COMBINATION  
SCREEN and METAL SASH DOOR  
★  
The "WEATHER-WISE"  
DOOR!!

**A VENTILATING SCREEN DOOR  
A SASH DOOR  
A PERMANENT OUTSIDE DOOR  
ALL 3 IN 1!**

Discriminating home owners and architects have chosen Hollywood Junior as the TRIPLE DOOR VALUE in the COMBINATION SCREEN and METAL SASH DOOR field! A sturdy dependable door, constructed of quality materials, HOLLYWOOD JUNIOR'S EXCLUSIVE PATENTED FEATURES have outmoded old-fashioned screen doors and other doors of its type entirely! . . . . .

**IT GUARANTEES YOU YEAR 'ROUND  
COMFORT, CONVENIENCE and ECONOMY**

WE ALSO MANUFACTURE A COMPLETE LINE OF  
SHUTTERS, C. C. DOORS, SCREENS, SCREEN DOORS, LOUVRE DOORS

**WEST COAST SCREEN CO.**  
1145 EAST 13th STREET ★ LOS ANGELES, CALIFORNIA  
AT&MG 1118

★ ★ ★ WRITE FOR FREE ILLUSTRATED LITERATURE ★ ★ ★





Chapel, Forest Lawn Memorial Park, Glendale, California

## ... IF you specify HILLYARD products

Because it's the original treatment you specify that protects those floors. And when Hillyard products are used you can be sure of the best protection possible . . . sure that months and years later your floors will be in top condition . . . a credit to you and a joy to your clients. Hillyard products for floor treatment are approved nation-wide by contractors, builders, architects and flooring manufacturers.

### ... a specialized Product for every Floor



Whatever the type floor—wood, terrazzo, cement, magnesite, tile, linoleum, asphalt tile, rubber tile, marble, cork—there's a Hillyard product ready and right for treating and maintaining that floor. And because specialized for the job at hand, Hillyard products save you and your clients unnecessary dollars.

### ... FREE Consultation Service

Hillyard maintains a staff of trained floor experts in key cities throughout the nation. The Maintaineer in your vicinity is eager to help with your floor problems. Consult him while your buildings are in the planning stage—he can show you how to save on labor time and construction costs. His advice is FREE.

**WRITE FOR** Hillyard's A.I.A. Specification File. Gives handy reference data on floor treatments. Free to architects on request. Dept. N 1-8



St. Joseph,  
Missouri

housing and the vast employment it provides is absolutely essential to the nation's welfare and economy.

The study concludes: "Rigid Government conservation measures over steel, copper and aluminum, a related to housing, would conserve relatively little material for defense purposes, in view of the small amounts used in housing".

### CAPTAIN C. REID JOHNSON NAMED DIRECTOR OF NEW SAN DIEGO OFFICE

Captain C. Reid Johnson, CEC, USN, retired, has been named director of the new San Diego office of the Los Angeles Architectural and Engineering firm of Pereira & Luckman.



CAPT. C. REID JOHNSON

In selecting Johnson as director for the San Diego office, Charles Luckman said he and his partner made the choice because of Johnson's distinguished career of more than thirty years in constructing a wide variety of war and peacetime Navy facilities.

Johnson, a native of Baltimore, Md., entered the U. S. Navy during World War I, following graduation from Cornell University with the degree of Civil Engineer and post graduate work in business administration at the University and advanced engineering at the Massachusetts Institute of Technology.

He served in a wide number of capacities and at the outbreak of World War II was Public Works Officer and Officer in Charge of Construction at the U. S. Naval Academy. During the war, Johnson was assigned some of the major construction projects undertaken by the Navy, in this country and overseas.

At the time of his retirement in June, Johnson was serving as District Public Works Officer and Officer in Charge of Construction, Eleventh Naval District, San Diego, and District Civil Engineer of the Eleventh Naval District.

### BUILDING RESEARCH ADVISORY BOARD ADVISES DEFENSE PRODUCTION

A contract has been signed between the Federal government and the National Academy of Sciences, at the request of the Defense Production Administration, for advisory services by the Building Research Advisory Board to provide for the conservation in building construction.

Howard Coonley, Director of the Conservation

Division of the Defense Production Administration, initiated the request and a committee has been appointed representing all government agencies concerned with Federal construction, both military and civilian, with James W. Follin of the General Services Administration being chosen Chairman.

The sub-committee is composed of engineers, specification writers and other technicians. William H. Scheick, executive director of the Building Research Advisory Board-National Academy of Sciences will serve as a member of this group.

The Committee has identified and endorsed as sound engineering practice four design standards: the present national standards for structural steel, reinforced concrete, street-grade lumber, and plumbing installations.

#### PHOENIX AUTHORIZES HOUSING

The Phoenix City Council recently authorized the Phoenix Housing Authority to borrow \$3,915,000 from the Public Housing Administration to finance construction of additional homes for low-income families.

The local authority will pay 2½ per cent interest on the loan.

#### DR. HAROLD M. DUDLEY SPEAKS BEFORE COMMERCIAL LABORATORIES

Dr. Harold M. Dudley, executive secretary of the Commercial Laboratories Association of America, recently addressed a group of association members at the Commercial Club in San Francisco.

Dr. Dudley outlined a number of activities of the national organization and noted trends within the industry that individual members may experience.

#### OREGONIAN APPOINTED DIRECTOR OF PABCO

Thomas C. Young, president of the Pacific Roofing Company of Portland, Oregon, has been elected a member of the Board of Directors of Pabco Products, Inc., to fill the unexpired term of the late Henry Rosenfeld.

Pacific Roofing Company was acquired by Pabco early in 1951.

#### MILITARY REQUIREMENTS FOR PLYWOOD CONSIDERED

In an effort to meet growing military requirements for plywood, the National Production Authority has ordered softwood plywood manufacturers to set aside up to thirty per cent of their production for DO rated orders, according to O. Harry Schrader, Jr., managing director of the Doug-



# A Combined

**Landcape Architecture  
and Contracting Service**

for

**Tract, Industrial and Residential  
Development**

**We can do the Complete Job for you**

- Landscape Architecture
- Finish Grading and Landscaping
- Asphalt Drives and Parking Lats

## HENRY C. SOTO CORPORATION

*Landscape Contractors*

**13000 SO. AVALON BLVD. LOS ANGELES 61, CALIF.**

Phone MEnlo 4-6617

# Eyes Right!

# RIGHT LIGHTING



● The eyes have rigid requirements in efficient lighting. Smoot-Holman certified illumination meets those requirements with unvarying quality and performance created by superior engineering and skill. Beauty, high efficiency and dependable operation are the hallmarks of the finer lighting equipment that bears the Smoot-Holman label in institutional, commercial and industrial installations.



OFFICES IN PRINCIPAL WESTERN CITIES • BRANCH AND WAREHOUSE IN SAN FRANCISCO

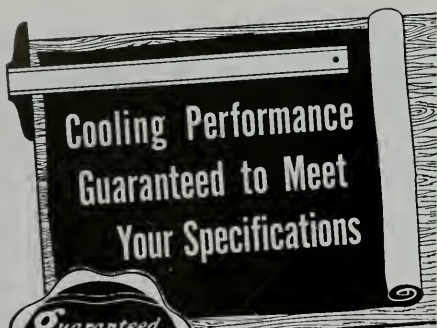

Specify Utility equipment! — The one sure way to avoid the headaches of an installation that just doesn't measure up to your specifications. You're sure with Utility because it sets the industry standard for quality and performance.

### UTILITY EVAPORATIVE AIR COOLERS AND VENTILATING EQUIPMENT FOR EVERY PURPOSE

Utility's air delivery tables are complete and authentic, derived from tests made in accordance with A.S.H.V.E. test codes. Every Utility cooler is tested in accordance with these same codes. You can meet every requirement with Utility for the line includes evaporative fan coolers, duct coolers, rotary spray washer type coolers, and blowers.



### A FULL RANGE OF UTILITY HEATING EQUIPMENT

**Floor Furnaces**—45,000 BTU/Hr. input, flat and dual; also, 60,000 BTU/Hr. input, flat and dual (both sizes, shallow-type construction). **Wall Heaters**—Single—27,500 BTU/Hr. input; Dual—35,000 BTU/Hr. input and 50,000 BTU/Hr. input. **Forced Air Furnaces**—75,000 BTU/Hr. input; 100,000 BTU/Hr. input; 125,000 BTU/Hr. input and 150,000 BTU/Hr. input. **Unit Heaters**—4 sizes. All Utility Heating Equipment is tested and approved by A.G.A.

### SEND FOR AIA ENGINEERING INFORMATION

For this complete technical data on Utility equipment, plus valuable tables, charts, installation details, write (on your letterhead) to Engineering Dept. Counsel from a Utility Engineer available without charge.

UTILITY APPLIANCE CORP.  
4851 S. Alameda Street, Los Angeles 58, California



EVAPORATIVE AIR COOLERS      GAS-FIRED FURNACES  
VENTILATING EQUIPMENT

Manufacturers of Gaffers & Sattler and Occidental Gas Ranges

las Fir Plywood Association at Tacoma, Washington.

The new set-aside order will affect September production.

West Coast plywood manufacturers produce about two-thirds of the nation's plywood and nearly all plywood used in construction.

### HAROLD SMITH ELECTED PRESIDENT SOUTHERN CALIFORNIA PRODUCERS

Harold Smith, Sales Manager for the Southern Division Hermosa Tile Sales, Gladding, McBean & Company's Los Angeles office, has been elected



HAROLD SMITH  
President

President of the Southern California Chapter of the Producers' Council, Inc., at the recent annual meeting.

The Producers' Council, Inc., is the national organization of building products manufacturers which was founded more than twenty-five years ago and has for its purpose the provision of uniform engineering and technical data to architects and builders.

The Southern California Chapter includes 43 local firms and its membership includes many Western representatives of national manufacturers.

Other officers elected for the ensuing year include: Bert Taylor, Pittsburgh Plate Glass Co., Vice-President; Richard Seaman, W. P. Fuller Co., Secretary; G. S. Younkin, Minneapolis Honeywell Regulator Co., Treasurer.

### ARIZONA HIGHWAY BUDGET GETS FINAL APPROVAL

The Arizona Highway Commission has adopted the state's \$25,275,000 highway construction budget for the 1951-52 period, with no final changes being made, following an open meeting for the purpose of hearing objections.

The budget total includes \$12,000,000 in revenue anticipated during the year from Federal Aid and state gasoline taxes, plus a carryover from last year of approximately \$13,000,000.

### WITTENBERG BECOMES PARTNER IN CONTRACTING FIRM

Carl H. Wittenberg has been made a partner in the general contracting firm of Ford J. Twaits Company with headquarters in Los Angeles, and will serve as general manager of the company.

The firm is currently engaged in the construction

tion of the 2000 car underground garage in Pershing Square in downtown Los Angeles; a 100 bed addition to the Hospital of the Good Samaritan; and a height-limit Medical Building on Wilshire Boulevard.

Wittenberg is well known in the construction industry of the West. He is a Civil Engineer.

#### WESTERN ASBESTOS CO. IS APPOINTED AGENT

Appointment of Western Asbestos Company as the approved applicators for Certain-Teed "Metro-Mix" poured-in-place Gypsum Roof Decks has been announced by Clarke E. Wayland, Vice-President in charge of sales for the firm which has its headquarters in San Francisco.

Poured-in-place gypsum roof decks are lightweight, have high insulation value, are fire resistant, and are quickly installed. They are erected on the job.

#### REDEVELOPMENT PROJECT DISPLAYED AT MACY'S

An exhibition of drawings and models of the Redevelopment Studies of the Diamond Heights district of San Francisco was recently displayed in the Macy Department Store in San Francisco and was viewed by a large number of persons.

The exhibit was sponsored by the Northern California Chapter of the American Institute of Architects in cooperation with the San Francisco Redevelopment Agency and the San Francisco Department of City Planning.

Objective of the project is to show the replanning and building-up of neglected areas as a long term investment to the community and includes a topographic model of the overall tentative plan with appropriate housing types — multi-family dwellings, step-down types; walkup apartments; elevator apartments; detached houses; row houses; and community buildings.

Among the consultants and architects taking part in the exhibit were: Roller, DeMars, Hutchison; Campbell and Wong; Skidmore, Owings & Merrill; Hertzka and Knowles; Clark and Beuttler; Wurster, Bernardi and Emmons; Angus McSweeney; Kitchen and Hunt; Vernon De Mars; Helen D. French; George Rockrise; John Funk; Ernest Born; J. Loyd Conrich; Gardner Dailey; Vincent G. Ramey; Mario Ciampi; Francis Lloyd; Mogens Mogensen; and John L. Reid.

JOHN J. GOULD, engineer, left for Europe during May. He plans to study recent developments in pre-stressed concrete and thin-shell roof structures in Germany.

## BARRETT & HILP CONTRACTORS

*Builders of the West*

918 Harrison Street • San Francisco  
Telephone DOuglas 2-0700

234 West 37th Place • Los Angeles  
Telephone ADams 3-8161



## STOP

Penetration Of  
**MOISTURE  
WIND  
DUST  
VERMIN**

EVERLASTING  
PROTECTION

## FORDERER CORNICE WORKS

*Manufacturers of*

Hollow Metal Products • Interior Metal Trim  
Elevator Fronts and Cabs  
Metal Plaster Accessories • Sanitary Metal Base  
Flat and Roll Metal Screens  
Metal Cabinets • Commercial Refrigerators

269 POTRERO AVE.

SAN FRANCISCO, CALIF.

HEMLOCK 1-4100

## Parker, Steffens & Pearce

BUILDERS

135 South Park, San Francisco

Phone: EXbrook 2-6639





**SISALATION**  
REFLECTIVE INSULATION

**COSTS 50%  
LESS THAN "BULK" or  
"BLANKET" TYPES OF INSULATION**  
... AND, IN ADDITION, ACTS AS A VAPOR-BARRIER (MEETS FHA REQUIREMENTS). COSTS LESS TO APPLY. WRITE FOR SAMPLES AND FULL INFORMATION ON ALL USES!

**The SISALKRAFT CO.**  
55 New Montgomery St. San Francisco 5, California

**JUDSON PACIFIC-MURPHY CORP.**

*Steel Fabricators  
and  
Erectors*

**REINFORCING STEEL  
STRUCTURAL STEEL  
BRIDGE CRANES**

4300 EASTSHORE HWY. Phone:  
EMERYVILLE, CALIF. OL 3-1717

**GLINTON  
CONSTRUCTION CO.**  
OF CALIFORNIA

**General Contractors**

923 FOLSOM STREET • SAN FRANCISCO  
SUtter 1-3440

**HOGAN LUMBER CO.**

*Wholesale and Retail*

**LUMBER**

---

**MILL WORK • SASH & DOORS**

---

*Office, Mill, Yard and Docks*  
**SECOND AND ALICE STREETS • OAKLAND, CALIF.**  
Telephone GLencourt 1-6861

**BOOK REVIEWS  
PAMPHLETS AND CATALOGUES**

**HEATING VENTILATING AIR CONDITIONING GUIDE 1951.**  
Vol. 29. American Society of Heating and Ventilating Engineers, New York City. Price \$7.50.

The 29th Edition represents the largest Technical Data Section to be found in the Heating Ventilating Air Conditioning Guide for 1951. Many pages of new material has been added although the arrangement of the chapters remains the same as in the preceding edition. There are fifty chapters covering seven classification sections, plus a section devoted to Modern Equipment and Manufacturers' Catalog data.

**INTER RACIAL HOUSING.** By Merton Deutsch and Mary Evans Collins. University of Minnesota Press, Publishers, Minneapolis, Minn. Price \$3.00.

Inter-racial Housing is a book giving a psychological evaluation of a social experiment. One of the most crucial strains on democracy today is the practice of racial segregation and this book offers numerous facts which throw new light on an important issue in the overall problem.

Results of study of segregated and non-segregated public housing are given, and the book offers a valuable demonstration of research techniques in social science.

Dr. Deutsch is assistant professor of psychology at the Research Center for Human Relations, New York University, and Mrs. Collins, formerly associated with the Research Center, is now a teacher in psychology at Sarah Lawrence College.

**THE PREFABRICATION OF HOUSES.** By Burnham Kelly. The Technology Press, Massachusetts Institute of Technology and John Wiley & Sons, Inc., New York City, Publishers. Price \$7.50.

The book is a collection of vital facts for everyone concerned with the financial, managerial, or technical aspects of the building industry, and covers a very wide scope of subjects. The author combines the viewpoint of the economist, the architect, the engineer, and the social historian with the result that a complete picture is given of the prefabrication industry, its history and future possibilities, its financial and managerial problems, its design and production processes, and its implication for the rest of the building industry.

The author is Director of the Albert Farwell Bemis Foundation.

**NEW CATALOGUES AVAILABLE**

*Any of the catalogues or folders described here may be obtained by forwarding your request as indicated in the coupon below to the office of the ARCHITECT & ENGINEER. Merely mark the items you want and clip or paste the coupon to your letterhead.*

**301. I. B. R. ISSUE GUIDE**

The publication of I-B-R Installation Guide No. 6 entitled "Panel Heating for Small Structures" is announced by The Institute of Boiler and Radiator Manufacturers. The Guide is intended for use in designing floor and ceiling panel heating systems for small residences utilizing forced circulation hot water. The data contained in the Guide are based on conservative averages of information found in literature published by many industry groups and individual manufacturers. Guide No. 6 includes sections on recommended installation practices, calculation and design, and heat loss factors. There are tabulations on the hourly btu requirements for areas and volume, equivalent hourly btu heat loss for various indoor minus outdoor temperature differences, pump size, pressure head developed by pump, and main sizes for iron pipe and copper tube. Also included in the Guide is a floor plan for a typical house, the boiler detail for this house, the floor box detail, floor coil installation detail, a piping plan for a floor panel system, and a piping plan for a ceiling panel system. There are also drawings illustrating the return main detail and the ceiling coil installation detail. 8/6/51.

**302. SOUND ABSORPTION DATA**

The annual bulletin of the Acoustical Materials Association for 1951, which is recognized as an unbiased source of sound absorption data on various acoustical materials, is now ready for distribution, Wallace Waterfall, Executive Secretary of the Association has announced. This bulletin is published periodically so that up-to-date information on products manufactured by Association members may be readily available. Interim

reports will be made from time to time as new materials are introduced and tested. According to Mr. Waterfall, the AMA Bulletin XIII will supersede all previous issues and is the most comprehensive bulletin yet published by the Association. It is prepared by AMA, which is an organization comprised of manufacturers of architectural acoustical materials. Purpose of the bulletin is to furnish architects, builders and others with reliable technical data on sound absorption coefficients of acoustical materials and with information on the uses of such materials. 8/3/51.

### 303. TECHNICAL NOTES ON BRICK AND TILE CONSTRUCTION.

Just released by the Structural Clay Products Institute is a new bulletin which divides structural clay facing tile into two broad types. The bulletin covers sizes and shapes, colors and finishes, uses, motor for facing tile, construction and cleaning facing tile. AIA 10-B, 4 pages illus. 6/51.

### 304. CANOPY TYPE GARAGE DOORS.

Strand Garage Door Division, which has recently introduced two types of wider garage doors for extra clearance of new cars, announces a new folder giving installation instructions for Strand's 9' x 7' Canopy-Type All-Steel Door. The folder tells in detail how to check the door opening and how to install hardware and door. It is liberally illustrated with photos and diagrams. 4 pages illus. 6/51.

### 305. INCINERATION CATALOG.

A complete catalog covering the Plibrico Incinerator is now available. The catalog covers the specifications and details of this incinerator which is used for all kinds of industrial and institutional refuse. 12 different types of incinerators are described and shown in all. A.I.A. 35-J-41, 16 pages illus. 7/30/51.

### 306. VENTILATING FANS.

A new informative manual called "A, B, C's of Ventilating Fans" has been produced by NuTone, Inc. It is designed mainly for architects, builders and wiring contractors. Plenty of illustrations and factual descriptive material point out why ventilation is important in every room of the house. Features, specifications and installation data for NuTone Ventilating Fans are presented in trade language. 8/10/51.

### 307. PHYSICS OF HEAT AND VAPOR FLOW.

The latest information on heat and vapor flow, vapor permeability, condensation, conduction and density, convection, radiation and emissivity, reflection and absorption, represents only a few of the subjects discussed in the new, revised and expanded edition of "Simplified Physics of Vapor and Thermal Insulation" which has just come off the press.

Written by Alexander Schwartz, president of Infra Insulation, Inc., the booklet is offered free by that company to engineers, architects, public officials, educators, builders, contractors, insulators and heating installers. It provides information they need every day, solves dozens of problems. Hundreds of universities and technical schools use previous editions as a text.

"Simplified Physics of Vapor and Thermal Insulation" is written in simple, easy to understand language, yet it is accurate and complete enough to gratify, and be useful to, a university professor. It is profusely illustrated with diagrams which demonstrate the laws of heat and vapor flow, and other valuable illustrative material. 56 pages illus., 8/51.

#### ARCHITECT AND ENGINEER

68 Post Street, San Francisco, Calif.

I would like to have a copy of each of the New Catalogues I have circled.

301                    302                    303                    304  
305                    306                    307

Please send to the address on my letterhead, or as I have indicated, and to my attention. (Please print your name - no literature will be sent on this coupon after September, 1951.—A. & E.)

## PACIFIC MANUFACTURING CO.

High Class Interior Finish Quality Millwork

16 Beale St., San Francisco  
Garfield 1-7755  
2215 El Camino Real, San Mateo  
S. M. 5-0687  
304 Bryant Street, Palo Alto  
P. A. 3373  
2610 The Alameda, Santa Clara  
S. C. 607 (Factory)  
6820 McKinley Avenue, Los Angeles  
THornwall 4196  
MAIN OFFICE — SANTA CLARA

## "AMERICAN - MARSH" CONDENSATION UNIT

Pumping  
Machinery  
for  
Every  
Purpose

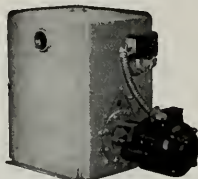

For Service  
Call  
DOuglas  
2-6794  
or  
MUtual 8322

SIMONDS MACHINERY CO.  
SAN FRANCISCO                    LOS ANGELES  
814 FOLSOM                        455 EAST 4TH

## VERMONT MARBLE COMPANY

DOMESTIC AND IMPORTED MARBLES  
GRANITE VENEER

525 MARKET STREET • SAN FRANCISCO  
Phone: SUtter 1-6747  
3522 COUNCIL STREET • LOS ANGELES  
Phone: DUknirk 2-7831

The Most Complete Line of  
STEELS and STEEL BUILDING MATERIALS  
Made by a Single Producer



See Sweet's Catalog File or write us for  
full information.

REPUBLIC STEEL CORPORATION  
GENERAL OFFICES: CLEVELAND, OHIO

DENVER, COLORADO . . . . CONTINENTAL OIL BUILDING  
LOS ANGELES, CALIF. . . . GENERAL PETROLEUM BUILDING  
SAN FRANCISCO, CALIFORNIA . . . RIALTO BUILDING  
SEATTLE, WASH. . . . WHITE-HENRY-STUART BUILDING

MEMO

Now —  
get 2% on  
savings at  
Crocker Bank



**CROCKER FIRST NATIONAL BANK**  
1 Montgomery Street S.F. FRANCISCO - 260-11th Street OAKLAND  
MEMBER FEDERAL RESERVE BANK CORPORATION

## A.I.A. ACTIVITIES

(From Page 39)

superintendents, foremen, and others actually engaged in the construction of buildings. It will be largely pictorial and promises to have a strong practical influence on the acceptance of modular methods.

A sub-committee has been appointed to study the use of modular coordination in planning by Federal agencies engaged in construction. The committee will examine reasons for and against the use of modular coordination in government planning and will be in touch with organizations sponsoring modular coordination to give them an opportunity to demonstrate reasons for its use by the Government.

### EAST BAY CHAPTER

James Anderson, chairman of the East Bay Chapter, A.I.A., Committee on Transportation has announced plans are underway for the charter of a commercial airplane to take members to the Annual Convention of the California Council of Architects in Coronado in October.

If interested contact Anderson, or Andre Morilhat, member of the committee at 461 Market Street, San Francisco.

## VALUABLE NEWS SERVICE

- BUILDING MATERIAL DEALERS
- CONTRACTORS
- ENGINEERS
- FINANCIAL INSTITUTIONS

**ARCHITECTS REPORTS** gives advance news on construction projects in Northern California, lists: name of projects, location, architect, proposed cost and other pertinent information.

**HANDY** individual slip-reports, issued daily at a total cost of only  
\$10 a month

## ARCHITECT'S REPORTS

Published Daily

The ARCHITECT and ENGINEER, Inc.

68 Post Street, San Francisco - DO 8311

### ARCHITECTS DO ADVERTISE

Headed by a large white "American Institute of Architects" on a black background, the Pasadena Chapter, A.I.A., is currently presenting a one column advertisement each Sunday in a Pasadena newspaper.

The objective of the institutional advertising is to stimulate public interest and knowledge in the advantages of use of an architect in building.

According to Burton Romberger, Chairman of the Chapter's Public Relations Committee, it is the Chapter's idea "to sell A.I.A. just as the doctors sold M. D.," and the newspaper advertisement is only a part of a well rounded program of professional promotion. Other plans include a uniform sign to be hung on the job.

### ANNUAL EXHIBIT OF SCHOOL BUILDINGS

Members of the Northern California Chapter, A.I.A., are completing plans for showing a number of projects in the Architectural Exhibit of School Buildings to be shown in San Jose, California, in October in conjunction with the annual convention of the California Association of School Administrators.

The exhibit will be held October 3, 4, and 5.





## INSULATION AND WALLBOARD—

Rockwool Insulation—	
(2") Less than 1,000 sq. ft.	\$64.00
(2") Over 1,000 sq. ft.	\$7.00
Cotton Insulation—Full thickness	
(3 1/2")	\$95.50 per M sq. ft.
Silestone Aluminum Insulation—Aluminum coated on both sides	
Tileboard—4 1/2" panel	\$9.00 per panel
Wallboard—1/2" thickness	\$5.00 per M sq. ft.
Finished Plank	\$49.00 per M sq. ft.
Ceiling Tileboard	\$49.00 per M sq. ft.

**IRON**—Cost of ornamental iron, cast iron, etc., depends on designs.

## LUMBER—

S4S No. 2 end better common	
O.P. or D.F., per M, f.b.m.	\$100.00
Rough, No. 2 common O.P. or D.F., per M, f.b.m.	100.00

## Flooring—

	Per M Delvd.
V.G.-D.F. B & Btr. 1 x 4 T & G Flooring	\$225.00
"C" end better—all	225.00
"D" end better—all	225.00
Rwd. Rustic—"A" grade, medium dry	185.00
	8 to 24 ft.

Plywood, per M sq. ft.	
1/4-inch, 4,0x8.0-515	\$170.00
1/2-inch, 4,0x8.0-515	250.00
3/4-inch, per M sq. ft.	315.00
Plywood	1 1/2¢ per ft.
Plyform	25¢ per ft.

Shingles (Rwd. not available)—

Red Cedar No. 1—\$9.50 per square; No. 2, \$7.00; No. 3, \$5.00.	
Average coat to lay shingles, \$4.00 per square.	
Cedar Shakes—1/2" x 24" in hand split tapered or split resawn, per square	\$15.25
3/4" x 24" in split resawn, per square	17.00
Average coat to lay shakes, \$8.00 per square	
Pressure Treated Lumber—Add \$35 per M to above	
Creosoted, treatment	Add \$45 per M to above

**MARBLE**—(See Dealers)

## METAL LATH EXPANDED—

Standard Diamond, 3/40, Copper Bearing, LCL, per 100 sq. yds.	\$43.50
Standard Ribbed, ditto.	\$47.50

## MILLWORK—Standard.

D. F., \$150 per 1000, R. W. Rustic 315 per 1000 (delivered).	
Double hung bow window frames, average with trim, \$12.50 end up, each.	
Complete door unit, \$15 to \$25.	
Screen doors, \$8.00 to \$12.00 each.	
Patent screen windows, \$1.25 a sq. ft.	
Cases for kitchen pantries seven ft. high, per lineal ft., upper \$9.00 to \$11.00; lower \$12.00 to \$13.00.	
Dining room cases, \$20.00 per lineal foot. Rough end finish about \$1.00 per sq. ft.	
Labor—Rough carpentry, warehouse heavy framing (average), \$75.00 per M.	
For smaller work average, \$85.00 to \$100. per 1000.	

## PAINTING—

Two-coat work	per yard	\$5.10
Three-coat work	per yard	81.50
Cold water painting	per yard	25c
Whitewashing	per yard	15c
Linseed Oil, Strictly Pure	per gal.	2.28
(Basis 7 1/2 lbs. per gal.)		
Wholesale		
Light iron drums	per gal.	\$2.28
5-gallon cans	per gal.	2.40
1-gallon cans	each	2.52
Quert cans	each	.71
Pint cans	each	.38
1/2-pint cans	each	.24
Boiled		
Pure Gum		
Light iron drums	per gal.	\$1.65
5-gallon cans	per gal.	1.76
1-gallon cans	each	1.88
Quert cans	each	.54
Pint cans	each	.31
1/2-pint cans	each	.20

## Pioneer White Lead in Oil Heavy Paste and All-Purpose (Soft-Paste)

Net Weight Packages	per 100 lbs.	List Price pgs.	Price to Painters per 100 lbs.	Pr. per pkg.
100-lb. tugs	\$28.35	\$29.25	\$27.50	\$27.50
50-lb. kegs	30.05	15.03	29.15	14.08
25-lb. kegs	30.35	7.59	28.45	7.12
5-lb. cans	33.35	1.34	31.25	1.25
1-cans	36.00	.36	33.75	.34

500 lbs. (one delivery) 3/4¢ per pound less than above.  
\*Heavy Paste only.

## Pioneer Dry White Lead—Litharge—Dry Red Lead—Red Lead in Oil

Products	per 100 lbs.	Price per 100 Pounds	100	50	25
Dry White Lead	\$26.30	\$			
Litharge	25.95	26.60	26.90		
Dry Red Lead	27.20	27.85	28.15		
Red Lead in Oil	30.65	31.30	31.60		

Pound cans, \$37 per lb.

## PATENT CHIMNEYS—

6-inch	\$2.50 lineal foot
8-inch	3.00 lineal foot
10-inch	4.00 lineal foot
12-inch	5.00 lineal foot

## PLASTER—

Neat well, per ton delivered in S. F. in paper bags, \$17.60.

## PLASTERING (Interior)—

3 Coats, metal lath end plaster	Yard	\$3.00
Knee cement on metal lath		3.50
Ceilings with 3/4" hot roll channels metal lath (lathed only)		3.00
Sealings with 3/4" hot roll channels metal lath plastered		4.50
Single partition 3/4" channel lath 1 side (lath only)		3.00
Single partition 3/4" channel lath 2 inches thick plastered		8.00
4-inch double partition 3/4" channel lath 2 sides (lath only)		5.75
4-inch double partition 3/4" channel lath 2 sides plastered		8.75
Thermex single partition; 1" channels; 2 1/2" overall partition width. Plastered both sides		7.50
Thermex double partition; 1" channels; 4 1/2" overall partition width. Plastered both sides		11.00
3 Coats over 1" Thermex nailed to one side wood studs or joists		4.50
3 Coats over 1" Thermex suspended to one side wood studs with spring sound isolation clip		5.00

Note—Channel lath controlled by limitation orders.

## PLASTERING (Exterior)—

2 coats cement finish, brick or concrete well	Yard	\$2.50
3 coats cement finish, No. 18 gauge wire mesh—\$4.00 per bbl. at yard.		3.50
Processed Lillime—\$4.15 per bbl. at yard.		
Rock or Grip Lath—3/4"=30¢ per sq. yd.		
"=29¢ per sq. yd.		
Composition Stucco—\$4.00 sq. yd. (applied).		

## PLUMBING—

From \$200.00 per fixture up according to grade, quality end runs.

## ROOFING—

"Standard" tar and gravel, 4 ply—\$11.00 per sq. for 30 sqs. or over.	
Less than 30 sqs. \$14.00 per sq.	
Tile \$40.00 to \$50.00 per square.	
No. 1 Redwood Shingles in place, 4 1/2 in. exposure, per square	\$18.25
5/2 No. 1 Cedar Shingles, 5 in. exposure, per square	14.50
5/8 x 16"—No. 1 Little Giant Cedar Shingles—5" exposure, per square	18.25

4/2 No. 1-24" Royal Cedar Shingles 7 1/2" exposure, per square	23.00
Re-coat with Gravel \$5.50 per sq.	
Asbestos Shingles \$27 to \$35 per sq. laid.	
1/2 to 3/4 x 25" Resewn Cedar Shakes, 10" Exposure	\$30.00
3/4 to 1 1/4 x 25" Resewn Cedar Shakes, 10" Exposure	\$35.00
1 x 25" Resewn Cedar Shakes, 10" Exposure	22.00

Above prices are for shales in place.

## SEWER PIPE—

C.I. 6-in. to 24-in. B. & S. Class B and heavier, per ton	\$99.50
Verified, per foot: L.C.L. F.O.B. Warehouse, San Francisco.	
Standard, 8-in.	\$.66
Standard, 12-in.	1.30
Standard, 24-in.	5.41
Clay Drain Pipe, per 1,000 L.F.	
L.C.L., F.O.B. Warehouse, San Francisco: Standard, 6-in. per M.	\$240.00
Standard, 8-in. per M.	400.00

## SHEET METAL—

Windows—Metal, \$2.50 a sq. ft.	
Fire doors (average), including hardware \$2.80 per sq. ft., size 12x12'. \$3.75 per sq. ft., size 3'x6'.	
SKYLIGHTS—(not glazed)	
Copper, \$1.25 sq. ft. (flat).	
Galvanized iron, 65¢ sq. ft. (flat).	
Vented hip skylights, \$27.50 sq. ft.	

## STEEL—STRUCTURAL—

\$220 per ton erected, when out of mill. \$270 per ton erected, when out of stock.

## STEEL REINFORCING—

\$200.00 per ton, in place.	
1/4-in. Rd. (Less than 1 ton)	\$8.40
3/8-in. Rd. (Less than 1 ton)	7.30
1/2-in. Rd. (Less than 1 ton)	7.00
5/8-in. Rd. (Less than 1 ton)	6.75
3/4-in. & 7/8-in. Rd. (Less than 1 ton)	6.65
1-in & up (Less than 1 ton)	6.60
1 ton to 5 tons, deduct 25¢.	

## STORE FRONTS (None available).

## TILE—

Ceramic Tile Floors—Commercial \$1.20 to \$1.60 per sq. ft.	
Cove Base—\$1.40 per lin. ft.	
Querry Tile Floors, 6x6" with 6" base @ \$1.35 per sq. ft.	
Tile Weincos & Floors, Residential, 4 1/4 x 4 1/4", @ \$1.65 to \$2.00 per sq. ft.	
Tile Weincos, Commercial Jobs, 4 1/4 x 4 1/4" Tile, @ \$1.50 to \$1.65 per sq. ft.	
Asphalt Tile Floor 1/2" x 1/2" x 1/2" = \$18 - .35 sq. yd. Light shades slightly higher.	
Cork Tile—\$.70 per sq. ft.	
Mosaic Floors—See dealers.	
Lino-Tile—\$1.00 per sq. ft.	
Rubber Tile—\$.55 to \$.75 per sq. ft.	
Building Tile—	
6x6x12-inches, per M	\$139.50
6x6x12-inches, per M	105.00
4x5x12-inches, per M	84.00
Hollow Tile—	
12x12x2-inches, per M	\$146.75
12x12x3-inches, per M	156.85
12x12x4-inches, per M	177.10
12x12x6-inches, per M	235.30

F.O.B. Plant

## VENETIAN BLINDS—

75¢ per square foot end up. Installation extra.

## WINDOWS—STEEL—INDUSTRIAL

Cost depends on design and quality required.

# ARCHITECT AND ENGINEER ESTIMATOR'S DIRECTORY

## Building and Construction Materials

**EXPLANATION**—Building and construction materials are shown in major classified groups for general identification purposes with names and addresses of suppliers of materials listed in detail under group classification where name first appears—main offices are shown first with branch or district offices following. The numeral appearing in listings refers to the major group classification where complete data on the dealer, or representative, may be found.

### AIR CONDITIONING 1b1

Nir Conditioning & Cooling  
UTILITY APPLIANCE CORP.  
Los Angeles 58, 4851 S. Alameda St.  
San Francisco, 1355 Market St., UN 1-4908

### ARCHITECTURAL VENEER (a)

Deremic Veneer  
PACIFIC CLAY PRODUCTS  
San Francisco: 605 Market St., GA 1-3970  
Los Angeles, Portland, Salt Lake City  
GLADDING, McBEAN & CO. \* (1)  
Porcelain Veneer  
PORCELAIN ENAMEL PUBLICITY BUREAU  
(Dept. AE-450)  
Room 601, Franklin Building, Oakland 12, California  
P. O. Box 186, East Pasadena Station, Pasadena 8, California

### Granite Veneer

VERMONT MARBLE COMPANY  
San Francisco 5: 525 Market Street, SU 1-6747  
Los Angeles 4: DU 2-7834

### Marble Veneer

VERMONT MARBLE COMPANY  
San Francisco 5: 525 Market Street, SU 1-6747  
Los Angeles 4: DU 2-7834

### BANKS-FINANCING (1b)

CROCKER FIRST NATIONAL BANK OF S. F.  
San Francisco, Post & Montgomery St's., EX 2-7700

### BRASS PRODUCTS (1a)

GREENBERG'S, M. & SONS  
San Francisco, Calif.: 765 Folsom, EXbrook 2-3143

### BRICKWORK (11)

Face Brick  
GLADDING, McBEAN & CO.  
San Francisco: Harrison at 9th Sts., UN 1-7400  
Los Angeles: 2901 Los Feliz Blvd., OL 2121  
Offices at Portland, Seattle, Spokane  
KRAFT  
Niles, California, Niles 3611  
San Francisco 5: 50 Hawthorne St., DO 2-3780  
Los Angeles 13: 406 South Main St., MU 7241  
REMILLARD-DANDINI CO.  
San Francisco: 400 Montgomery St., EX 2-4988

### BRONZE PRODUCTS (1b)

GREENBERG'S, M. & SONS  
San Francisco, Calif.: 765 Folsom, EXbrook 2-3143

### BUILDING PAPER & FELTS (2)

SISALKRAFT COMPANY  
San Francisco: 55 New Montgomery St., EX 2-3066  
Chicago, Ill.: 205 West Wacker Drive  
ANGIER PACIFIC CORP.  
San Francisco 5: 55 New Montgomery St., DO 2-4416  
Los Angeles: 7424 Sunset Boulevard

### BUILDING HARDWARE (3)

THE STANLEY WORKS  
San Francisco: Monadnock Bldg., YU 6-5914  
New Britain, Conn.

### CEMENT (c)

PACIFIC PORTLAND CEMENT  
San Francisco: 417 Montgomery St., GA 1-4100

### CONCRETE AGGREGATES (4)

Lightweight Aggregates  
AMERICAN PERLITE CORP.  
Richmond, Calif.: 26th & B Sts.—Yard 2, RI 4307

### DOORS (4a)

Hollywood Doors  
WEST COAST SCREEN CO.  
Los Angeles: 1127 E. 63rd St. AD 1-1108  
Distributors:

W. P. FULLER CO.  
Seattle, Tacoma, Portland  
NICOLAI DOOR SALES CO.  
San Francisco: 3045 19th St.  
T. M. COBB CO.

Los Angeles & San Pedro  
SOUTHWEST SASH & DOOR  
Phoenix, Arizona  
HOUSTON SASH & DOOR  
Houston, Texas

Screen Doors  
WEST COAST SCREEN CO.  
(See HOLLAND Door listing above)

### FIRE ESCAPES (5)

SOULE STEEL  
San Francisco: 1750 Army St., VA 4-4141  
Los Angeles, Calif.—LA 0911  
Portland, Ore.—BE 5155  
Seattle, Wash.—SE 3010  
MICHAEL & PEEFFER IRON WORKS, INC.  
San Francisco 3: Tenth & Harrison Sts., MA 1-5966

### FIREPLACES (5a)

Heat Circulating  
SUPERIOR FIREPLACE CO.  
Los Angeles: 1708 E. 15th St. PR 8393  
Baltimore, Md.: 601 No. Point Rd.

### FLOORS (6)

Hardwood Flooring  
HOGAN LUMBER COMPANY  
Oakland: Second and Alice Sts., GL 1-6861  
E. K. WOOD LUMBER CO.  
Los Angeles: 4710 S. Alameda St., JE 3111  
Oakland: 727 Kennedy St., KE 4-8466  
Portland: 827 Terminal Sales Building  
Floor Treatment & Maintenance  
HILLYARD SALES CO. (Western)  
470 Alabama St., San Francisco, MA. 1-7766  
Los Angeles: 923 E. 3rd, Trinity 8282  
Seattle, 3440 E. Marginal Way

### GLASS (7)

W. P. FULLER COMPANY  
San Francisco: 301 Mission St., EX 2-7151  
Los Angeles, Calif.  
Portland, Oregon

### HEATING (8)

HENDERSON FURNACE & MFG. CO.  
Sebastopol, Calif.  
S. T. JOHNSON CO.  
Oakland 8: 940 Arlington Ave., OL 2-6000  
San Francisco: 585 Potrero Ave., MA 1-2757  
Philadelphia 8, Pa.: 401 No. Broad St.  
SCOTT COMPANY  
San Francisco: 243 Minne St., YU 2-0400  
Oakland: 113 - 10th St., GL 1-1937  
San Jose, Calif.  
Los Angeles, Calif.  
ELECTROMODE CORP.  
Rochester, N. Y.

### Electric Heaters

San Francisco: 1355 Market St., KL 2-2311  
Northern California Distributors  
GENERAL ELECTRIC SUPPLY CORP.  
San Francisco: 1201 Bryant St., UN 3-4000  
Emeryville: 5400 Hollis St., OL 3-4433  
Sacramento: 1131 S. St., GI 3-9001  
Fresno: 1234 O St., Fresno 4-4746  
INCANDESCENT SUPPLY COMPANY  
Redding: 2146 Pine St., Redding 200  
THOMAS B. HUNTER (Designer)  
San Francisco: 41 Sutter St., GA 1-1164

### UTILITY APPLIANCE CORP. \* (b)

INSULATION AND WALLBOARD (9)  
LUMBER MANUFACTURING CO.  
San Francisco: 225 Industrial Ave., JU 7-1760  
SISALKRAFT COMPANY \* (2)  
WESTERN ASBESTOS COMPANY  
San Francisco: 675 Townsend St., KL 2-3868  
Oakland: 251 Fifth Avenue, GL 1-2345  
Sacramento: 1224 I Street, 2-8993  
Stockton: 1120 E. Weber Ave., 4-1863  
Fresno: 1837 Merced Street, 3-3277  
San Jose: 201 So. Market St., BA 4359-J

### IRON—Ornamental (10)

MICHEL & PEEFFER IRON WORKS, INC. \* (5)

### LANDSCAPE (11a)

Landscape Contractors  
HENRY C. SOTO CORPN.  
Los Angeles, 13000 S. Avalon Blvd. ME 4-6617

### LIGHTING FIXTURES (11)

SMOOTH-HOLMAN COMPANY  
Inglewood, Calif., OR 8-1217  
San Francisco: 55 Mississippi St., MA 1-8474

### LUMBER (12)

HOGAN LUMBER COMPANY \* (6)  
LUMBER MANUFACTURING CO. \* (9)  
E. K. WOOD LUMBER CO. \* (6)  
Shingles

SEAWALL LUMBER COMPANY  
San Francisco 24: 1995 Oakdale Ave., AT 2-8112

### MARBLE (13)

VERMONT MARBLE COMPANY  
San Francisco: 525 Market St., SU 1-6747  
Los Angeles 4: 3522 Council St., DU 2-7834

### METAL LATH EXPANDED (14)

FORDEER CORNIC WORKS  
San Francisco: 269 Potrero Ave., HE 1-4100  
SOULE STEEL \* (5)

### MILLWORK (15)

PACIFIC MANUFACTURING COMPANY  
San Francisco: 16 Beale St., GA 1-7755  
Santa Clara: 2610 The Alameda, SC 607  
Los Angeles: 6820 McKinley Ave., TH 4196  
MULLEN MANUFACTURING COMPANY  
San Francisco: 60-80 Rausch St., UN 1-5815  
LUMBER MANUFACTURING COMPANY \* (9)

### PAINTING (16)

Paint  
W. P. FULLER COMPANY \* (7)

### PLASTER (17)

Exteriors  
PACIFIC PORTLAND CEMENT COMPANY \* (4)  
Interiors—Metal Lath & Trim  
FORDEER CORNIC WORKS \* (14)

### PLASTIC CEMENT (f)

PACIFIC PORTLAND CEMENT CO.  
San Francisco: 417 Montgomery St., GA 1-4100

### PLUMBING (18)

THE SCOTT COMPANY \* (8)  
THE HALSEY TAYLOR COMPANY  
Redlands, Calif.  
Warren, Ohio  
HAWES DRINKING FAUCET COMPANY  
Berkeley 10: 1435 Fourth St., LA 5-3341  
CONTINENTAL WATER HEATER COMPANY  
Los Angeles 31: 1801 Pasadena Ave., CA 6178

**SIMONDS MACHINERY COMPANY**

San Francisco: 816 Folsom St., DO 2-6794  
 Los Angeles: 455 East 4th St., MU 8322  
**SECURITY VALVE COMPANY**  
 Los Angeles 31: 410 San Fernando Rd., CA 6191

**REPUBLIC STEEL CORP.**

San Francisco: 116 N. Montgomery St., GA 1-0977  
 Los Angeles: Edison Building  
 Seattle: White-Henry-Stuart Building  
 Salt Lake City: Walker Bank Building  
 Denver: Continental Oil Building  
**KRAFTILE COMPANY \* (1)**  
**SAN JOSE STEEL COMPANY**  
 San Jose: 195 North Thirtieth St., CO 4184

**WINDOWS STEEL (25)**

**DETROIT STEEL PRODUCTS CO. \* (20)**  
**MICHEL & PFEFFER IRON WORKS, INC**  
**SOULE STEEL COMPANY \* (5)**

**SEWER PIPE (19)**

**GLADDING, McBEAN & CO. \* (1)**  
**PACIFIC CLAY PRODUCTS**  
 San Francisco: 605 Market St., GA 1-3970  
 Los Angeles, Portland, Salt Lake City

**STEEL—REINFORCING (22)**

**REPUBLIC STEEL CORP. \* (21)**  
**HERRICK IRON WORKS \* (21)**  
**SAN JOSE STEEL CO. \* (21)**  
**COLUMBIA STEEL CO. \* (21)**

**SHEET METAL (20)**

**Windows**

**DETROIT STEEL PRODUCTS COMPANY**  
 Oakland 8: 1310 - 63rd St., OL 2-8826  
 San Francisco: Russ Building, DO 2-0890  
**MICHEL & PFEFFER IRON WORKS, INC. \* (5)**  
**SOULE STEEL COMPANY \* (5)**

**TILE (23)**

**GLADDING, McBEAN & CO. \* (1)**  
**KRAFTILE COMPANY \* (1)**  
**PACIFIC CLAY PRODUCTS**  
 San Francisco: 605 Market St., GA 1-3970  
 Los Angeles, Portland, Salt Lake City

**Fire Doors**

**DETROIT STEEL PRODUCTS COMPANY**  
**Skylights**  
**DETROIT STEEL PRODUCTS COMPANY**

**TIMBER—REINFORCING (6)**

**Trusses**  
**WEYERHAEUSER SALES CO.**  
 Tacoma, Wash.  
 St. Paul, Minn.  
 Newark, N. J.  
 Treated Timber

**STEEL—STRUCTURAL (21)**

**COLUMBIA STEEL CO.**  
 San Francisco: Russ Bldg., SU 1-2500  
 Los Angeles: 2087 E. Slauson, LA 1171  
 Portland: 2345 N. W. Nicolai, BE 7261  
 Seattle: 1331 3rd Ave. Bldg., MA 1972  
 Salt Lake City: Walker Bank Bldg., SL 3-6733

**J. H. BAXTER CO.**

San Francisco 4: 333 Montgomery St., DO 2-3883  
 Los Angeles 13: 601 West Fifth St., MI 6294

**HERRICK IRON WORKS**

Oakland: 18th & Campbell Sts., GL 1-1767  
**JUDSON PACIFIC-MURPHY CORP.**  
 Emeryville: 4300 Eastshore Highway, OL 3-1717

**WALL TILE (24)**

**GLADDING, McBEAN & CO. \* (1)**  
**KRAFTILE COMPANY \* (1)**

**TESTING LABORATORIES**

**(ENGINEERS & CHEMISTS) (27)**

**ABBOT A. HANKS, INC.**  
 San Francisco: 624 Sacramento St., GA 1-1  
**ROBERT W. HUNT COMPANY**  
 San Francisco: 251 Kearny St., EX 2-4634  
 Los Angeles: 3050 E. Slauson, JE 9131  
 Chicago, New York, Pittsburgh  
**PITTSBURGH TESTING LABORATORY**  
 San Francisco: 651 Howard St., EX 2-1747

**BUILDING TRADES WAGE (JOB SITES) NORTHERN, CENTRAL AND SOUTHERN CALIFORNIA**

ATTENTION: The following are the PREVAILING hourly rates of compensation being paid and in effect by employers by agreement between employees and their union; or as recognized and determined by the U. S. Department of Labor. (Revised to March 1, 1951.)

CRAFT	San Francisco	Alameda	Contra Costa	Frisco	Sacramento	Santa Clara	Santa Clara	Solano	Los Angeles	San Bernardino	San Diego	Santa Barbara	Kern
	\$2.50	\$2.50	\$2.50	\$2.50	\$2.50	\$2.50	\$2.50	\$2.25	\$2.25	\$2.25	\$2.25	\$2.25	\$2.25
<b>ASBESTOS WORKERS</b> .....	2.53	2.53	2.53	2.53	2.53	2.53	2.53	2.25	2.625	2.625	2.625	2.625	2.625
<b>BOILERMAKERS</b> .....	3.25**	3.15	3.15	2.85	2.75	3.00	3.00	3.20	1.75	1.75	1.75	1.75	1.75
<b>BRICKLAYERS, HODCARRIERS</b> .....	2.45	2.45	2.45	2.00	2.40	2.25	2.375	2.40	2.20	2.20	2.20	2.20	2.20
<b>CARPENTERS</b> .....	2.325	2.325	2.175	2.175	2.175	2.175	2.175	2.175	2.28	2.28	2.28	2.28	2.28
<b>CEMENT FINISHERS</b> .....	2.20	2.20	2.20	2.20	2.20	2.20	2.20	2.20	2.50	2.50	2.50	2.50	2.50
<b>ELECTRICIANS</b> .....	2.75	2.60	2.60	2.75	2.50	2.50	2.625	2.60	2.25	2.25	2.25	2.25	2.25
<b>ELEVATOR CONSTRUCTORS</b> .....	2.75	2.75	2.75	2.75	2.75	2.75	2.75	2.75	1.9875	1.9875	1.9875	1.9875	1.9875
<b>ENGINEERS: MATERIAL HOIST</b> .....	2.19	2.19	2.19	2.19	2.19	2.19	2.19	2.19	2.00	2.00	2.00	2.00	1.96
<b>GLAZIERS</b> .....	2.30	2.30	2.30	2.30	2.30	2.30	2.30	2.30	2.25	2.25	2.25	2.25	2.25
<b>IRONWORKERS: ORNAMENTAL</b> .....	2.425	2.425	2.425	2.425	2.425	2.425	2.425	2.425	2.28	2.28	2.28	2.28	2.28
<b>REFIN. RODMEN</b> .....	2.375	2.375	2.375	2.375	2.375	2.375	2.375	2.375	2.25	2.28	2.28	2.28	2.28
<b>STRUCTURAL</b> .....	2.575	2.575	2.575	2.575	2.575	2.575	2.575	2.575	2.30	2.30	2.375	2.30	2.30
<b>LABORERS: BUILDING</b> .....	1.65	1.65	1.65	1.55	1.65	1.65	1.65	1.65	1.65	1.65	1.65	1.65	1.65
<b>CONCRETE</b> .....	1.65	1.65	1.65	1.55	1.65	1.65	1.65	1.65	1.65	1.65	1.65	1.65	1.65
<b>LATHERS</b> .....	3.00	3.00*	3.00*	2.75	2.875	2.75	3.00	2.8125	2.50	2.50	2.50	2.50	2.50
<b>MARBLE SETTERS</b> .....	2.40	2.40	2.40	2.40	2.40	2.40	2.40	2.40	2.25	2.25	2.25	2.25	2.25
<b>MOSAIC &amp; TERRAZZO</b> .....	2.375	2.375	2.375	2.375	2.375	2.375	2.375	2.375	2.40	2.40	2.40	2.40	2.40
<b>PAINTERS</b> .....	2.45*	2.45	2.45	2.15	2.45	2.275	2.45	2.45	2.40	2.40	2.40	2.40	2.40
<b>PILEDRIVERS</b> .....	2.325	2.325	2.325	2.325	2.325	2.325	2.325	2.325	2.33	2.33	2.33	2.33	2.33
<b>PLASTERERS</b> .....	3.00	3.15*	3.15	2.75	3.00	3.125	3.00*	3.00*	2.50	2.75	2.50	2.50	2.50
<b>PLASTERERS, HODCARRIERS</b> .....	2.40	2.80	2.80	2.50	2.40	2.50	2.75	2.50	2.15	2.25	2.30	2.00	2.00
<b>PLUMBERS</b> .....	2.425	2.625	2.625	2.425	2.625	2.625	2.625	2.625	2.50	2.50	2.50	2.50	2.50
<b>TOOFERS</b> .....	2.50	2.50	2.50	2.50	2.375	2.50	2.50	2.50	2.25	2.00	1.90	2.00	2.00
<b>SHEET METAL WORKERS</b> .....	2.3125	2.3125	2.3125	2.40	2.50	2.375	2.3125	2.375	2.15	2.15	2.175	2.00	2.15
<b>SPRINKLER FITTERS</b> .....	2.425	2.425	2.425	2.425	2.425	2.425	2.425	2.425	2.25	2.25	2.25	2.25	2.25
<b>STEAMFITTERS</b> .....	2.425	2.425	2.425	2.425	2.425	2.425	2.425	2.425	2.50	2.50	2.50	2.50	2.50
<b>TRUCK DRIVERS—1/2 Ton or less</b> .....	1.58	1.58	1.58	1.58	1.58	1.58	1.58	1.58	2.50	2.50	2.50	2.50	2.50
<b>TILESETTERS</b> .....	2.875	2.875	2.875	2.50	2.875	2.425	2.875	2.875	2.50	2.50	2.20	2.50	2.25

\* 6 Hour Day. \*\* 7 Hour Day.

Prepared and compiled by:

CENTRAL CALIFORNIA CHARTER, ASSOCIATED GENERAL CONTRACTORS OF AMERICA, with the assistance and cooperation of secretaries of General Contractors Associations and Builders Exchanges of Northern California; and the above information for southern California is furnished by the Labor Relations Department of the Southern California Chapter, ASSOCIATED GENERAL CONTRACTORS OF AMERICA.

## BUILDERS OF THE WEST

(From Page 36)

it enables the owner to keep a close check on expenditures as the work proceeds, enables the owner to identify and segregate the cost of each item, and at the same time have the protection of the maximum set up in the contract; 4) Preliminary costs are made from preliminary studies and a final guaranteed cost is ascertained when plans are completed even though construction has already started. This final maximum guaranteed cost is the amount set up in the contract; 5) It obviates most of the arguments and misunderstandings which often arise under lump sum contracts. It thus promotes an air of general satisfaction at completion of the work between all parties concerned.

Barrett & Hilp have for several years maintained a branch office at 234 West 37th Place in Los Angeles, with John Sparolini, Vice-president, serving as Branch Manager, and the St. John's Hospital construction, as well as several other large projects, are currently being handled from the Los Angeles office under Sparolini's direction.

### BARRETT & HILP

"Frank" and "Harry" as they are affectionately known by their employees, have always maintained a close personal and harmonious relationship with every member of their staff and employee. The Barrett & Hilp organization is essentially that of a large cooperative family. This relationship is enhanced and fostered among other ways by the recent establishment of an attractive luncheon room at the home office at 918 Harrison street, San Francisco, where free lunches are served to the staff.

Frank Barrett was educated at the University of San Francisco where he now serves as a member of the Board of Regents. Harry Hilp studied engineering at the University of California.

They have both been most generous in their support of their respective institutions and are active supporters of various youth organizations

and other civic bodies. They are both well known for their harmonious family life and their adherence to their respective religious faiths.

"Frank" and "Harry" are true "Builders of the West" in every sense of the word and are honored members of that great army of pioneer builders who have developed the West in the best tradition of the American way of life and free enterprise.

### SCHOOL CHILDREN CONTINUE

#### TREE PLANTING PROJECT

School children of Oregon's coastal towns have been devoting one full day each year to the planting of the second crop of trees on the hills surrounding their communities, in a program of reforestation which began in 1945.

In the Umpqua area alone during the past six years more than 117,000 Douglas Fir, Port Orford Cedar, and Redwood have been planted on a 400 acre tract.

The project is supervised by lumber organizations and forest department officials who select the specie and planting site.

### L. A. WOMEN VOTERS BACK HOUSING

The Los Angeles League of Women Voters recently deluged members of the City Council in an effort to get the Council to reaffirm its approval of the sites selected by the Housing Authority for the new 10,000 unit low rent public housing program.

Action cited the desperate need for housing for families of low income, and resulted from decisions made by the City Planning Commission against one of the sites selected.

### ARCHITECT MOVES OFFICES

Architect Victor L. Wulff of Spokane, Washington, has moved his offices to 1526 West Riverside avenue, same city.

A site for construction of a \$500,000 Jewish Federation Center Building has been purchased at MacArthur and Van Buren in Oakland, California.

# CLASSIFIED ADVERTISING

RATE: 20c PER WORD . . . CASH WITH ORDER

MINIMUM \$5.00

**PLANNING CHURCH BUILDINGS.** Portfolio—64 oversized pages 144 cuts; floor plans, exterior and interior views; recently planned buildings costing \$30,000 upward. Largest collection plans of Protestant churches assembled. Price \$2.00 p.p. WRITE Bureau of Architecture, 300 Fourth Ave., New York 10, N. Y.

**GET THE BEST,** don't be satisfied with anything but the best. Window sash, Doors, Cabinets, etc. Town Talk Sash & Door Mill, 524 9th St., Sacramento.

**BUILDERS!** You can make more money; get information you need before it is published elsewhere; Subscribe to the daily ARCHITECTS REPORTS, only \$10.00 per month. Complete information from ARCHITECTS REPORTS, 68 Post Street, San Francisco. Phone DOuglas 2-8311.

**PHOTOGRAPHY.** For the best in construction photography, including exterior and interior, aerial, and progress views . . . you will find as many others have that it's the SKELTON STUDIO'S, 137 Harlan Place, San Francisco. Telephone YUkon 6-6321.

**WANTED:** Experienced specification writer and building estimator by San Francisco ARCHITECT. Write WE 1-6.c/o ARCHITECT & ENGINEER, 68 Post Street, S. F.

**FLOOR COVERINGS** for industrial, commercial, and residential construction. Complete lines, one of the oldest, best established organizations in the Sacramento Valley. LATTIN'S, INC., 1519 Alhambra Blvd., Sacramento.



## CONSTRUCTION CONTRACTS AWARDED AND MISCELLANEOUS PERSONNEL DATA

**GRAMMAR SCHOOL**, Chico, Butte County. Pleasant Valley Elementary School District, owner. 6 classrooms, kindergarten, administration, multi-purpose, kitchen and toilet rooms, \$237,528. ARCHITECT: Lawrence G. Thomson, Chico, frame and stucco construction. GENERAL CONTRACTOR: Wm. E. Frye, Grass Valley.

**NEW GRAMMAR SCHOOL**, Santa Rosa, Sonoma County. Bellevue Unified School District, owner. 15 classrooms, administration, all-purpose room, kitchen, and toilet rooms, \$445,527. ARCHITECT: C. A. Caultkins, Santa Rosa; frame and stucco construction. GENERAL CONTRACTOR: Wm. D. Rapp, Santa Rosa.

**CAFETERIA & KITCHEN**, Crows Landing, San Joaquin County. Benita Elementary School District, owner; \$19,850. ARCHITECT: Mayo & Johnson, Stockton. GENERAL CONTRACTOR: James Franzen, Newman.

**LOW INCOME HOUSING PROJECT**, Riverbank, Stanislaus County. Housing Authority, City of Riverbank, owner; 30 units, \$409,000. ARCHITECT: Anderson & Simonds, Oakland; 15 duplex residences, 1 story frame and stucco construction, concrete floor, steel sash or wood composition single floor, asphalt tile floors. GENERAL CONTRACTOR: Harvey & Ross, Arcadia.

**REMODEL & ADDITION TO CONVENT**, Concord, Contra Costa County. Roman Catholic Archbishop of San Francisco, owner; Queen of All Saints Convent, \$35,000. ARCHITECT: Vincent G. Roney, San Francisco. GENERAL CONTRACTOR: Wm. J. Kraus, Oakland.

**REMODEL CONVENT**, Livermore, Alameda County. Roman Catholic Church, owner; St. Michaels Parish, \$31,480. ARCHITECT: Vincent G. Roney, San Francisco. GENERAL CONTRACTOR: Anderson-Haglund Co., Oakland.

**STORE BUILDING**, Hayward, Alameda County. Thompson Realty Co., owner; unit 3, \$49,962. ENGINEER: J. Y. Young, Oakland, 1 story, reinforced concrete construction. GENERAL CONTRACTOR: Harry K. Jensen, Oakland.

**HOUSING PROJECT**, Port Chicago, Contra Costa County. Housing Authority, owner; 24 units, \$152,447. ARCHITECT: Sewall Smith, Lafayette, frame and stucco construction. GENERAL CONTRACTOR: David Zuckerman, Walnut Creek.

**HOUSING PROJECT**, Pittsburg, Contra Costa

County. Housing Authority, owner; 175 unit, \$1,297,000. ARCHITECT: Fred L. Conler & R. G. Willis & Anderson & Simonds, Oakland. GENERAL CONTRACTOR: Moore & Roberts & Elmer J. Freeby (Joint Venture), San Francisco.

**HOUSING PROJECT AND MAINTENANCE BUILDINGS**, North Richmond, Contra Costa County. Housing Authority County of Contra Costa County, owner; low income, 76 units, \$590,500. ARCHITECT: Masten & Hurd, San Francisco, 1 and 2 story frame and stucco construction. GENERAL CONTRACTOR: Pacific Coast Builders, San Francisco.

**OFFICES, SALES ROOM & WAREHOUSE**, Berkeley, Alameda County. S & W Fine Foods, Inc., owner, \$210,000. ARCHITECT: Kirby & Mulvin, San Francisco, 1 story, reinforced concrete, composition wood roof, steel sash. GENERAL CONTRACTOR: Russell A. Cullen, Inc., San Francisco.

**GRAMMAR SCHOOL ADDITION**, West Sacramento, Sacramento County. West Sacramento Elementary School District, owner; 4 classrooms, kindergarten, multi-purpose room, kitchen, \$187,650. ARCHITECT: Barovetto & Thomas, Sacramento, frame and stucco construction. GENERAL CONTRACTOR: Holdener Construction Co., Sacramento.

**GARDENLAND GRAMMAR SCHOOL ADDITION**, North Sacramento, Sacramento County. North Sacramento Elementary School District, owner; 4 classrooms, kindergarten, all-purpose room, kitchen, \$197,440. ARCHITECT: Koblik & Fisher, Sacramento, frame and stucco construction. GENERAL CONTRACTOR: Charles F. Unger, Sacramento.

**GRAMMAR SCHOOL**, Placer County. Penryn, Penryn Elementary School District, owner, 6 classrooms, office, kindergarten, toilet rooms, \$190,185. ARCHITECT: Gordon Stafford, Sacramento, frame and stucco construction. GENERAL CONTRACTOR: G. S. Herrington, Auburn.

**GRAMMAR SCHOOL**, Los Gatos, Santa Clara County. Loma Prieta Joint Elementary School District, owner, 4 classrooms, cafeteria, \$152,214. ARCHITECT: Chas. E. Butler, San Jose, frame and stucco construction. GENERAL CONTRACTOR: Morrison W. Reese, San Jose.

**CHURCH**, Colma, San Mateo County. Community Presbyterian Church, owner, \$57,125. ARCHITECT: Donald Powers Smith, San Francisco, frame and stucco construction. GENERAL CONTRACTOR: Joel Johnson & Son, San Francisco.

**LOW INCOME HOUSING PROJECT**, Newman, Stanislaus County. Housing Authority of Stanislaus County, owner 16 units, \$99,999. ARCHITECT: Donald Powers Smith, San Francisco, frame and stucco construction, 8 duplexes. GENERAL CONTRACTOR: Donald Thompson, Modesto.

**DEPARTMENT STORE BUILDING**, Fresno, Fresno County. Panama Realty Co., owner, \$599,193. ARCHITECT: Leo Roslyn Co., San Francisco, 2 story and basement, 100 x 150 reinforced concrete construction, Cast stone veneer of 1st floor, 2 elevators, air conditioning system. GENERAL CONTRACTOR: Harris Construction Co., Fresno.

**D. A. WALSH INTERMEDIATE SCHOOL**, Morgan Hill, Santa Clara County. Morgan Hill-Burnett School District, owner, 10 classrooms, administration and toilet rooms,

\$152,480. ARCHITECT: Robt. Stanton, Carmel. Frame and stucco construction. GENERAL CONTRACTOR: Geon C. Renza, Gilroy.

**BELLY AIR GRAMMAR SCHOOL**, San Bruno, San Mateo County. San Bruno Park Elementary School District, owner. 16 classrooms, kindergarten, administration, library, multi-purpose and toilet, \$512,708. ARCHITECT: Leslie C. Irwin, San Francisco. Approximately 30,000 sq. ft. frame and stucco construction. GENERAL CONTRACTOR: Wm. Horstmeier Co., San Francisco.

**PENINSULA COMMUNITY HOSPITAL**, Hillsborough, San Mateo County. Peninsula Hospital District, owner, \$3,608,757. ARCHITECT: D. D. Stone & Lou Mulloy, San Francisco, 5 story, (I) shaped, reinforced concrete construction. GENERAL CONTRACTOR: Williams & Burrows & Carl Swenson Co., Burlingame.

**NEW HIGH SCHOOL BUILDING**, South San Francisco, San Mateo County. So. San Francisco Unified School District, owner, classrooms administration, science, home economics, library, auditorium, gym, cafeteria, toilet rooms, shop, \$1,258,175. ARCHITECT: John Lyden Reid, San Francisco, 2 story, reinforced concrete & steel construction. GENERAL CONTRACTOR: Williams & Burrows, Burlingame.

**NEW HIGH AND ELEMENTARY SCHOOL BUILDING**, Downieville, Sierra County. Downieville Unified School District, owner. 6 classrooms, administration, shop, clinic, toilet room, \$170,065. ARCHITECT: Chas. F. Dean, Sacramento. Reinforced concrete frame and stucco construction. GENERAL CONTRACTOR: W. E. Frye, Grass Valley.

**MUSIC BUILDING, VALLEJO COLLEGE**, Vallejo, Solano County. Vallejo Unified School District, owner; \$163,662. ARCHITECT: Masten & Hurd, San Francisco, frame and stucco construction, concrete floor, tar and gravel roof. GENERAL CONTRACTOR: H. A. Crocker Co., San Rafael.

**HERO'S MEMORIAL BUILDING MODEL**, Carson City, Nevada. State of Nevada, owner; \$65,000. ARCHITECT: Ferris & Erskine, Reno. Interior and exterior remodel. GENERAL CONTRACTOR: Walker Boudwin Construction Co., Reno.

**CHURCH & SUNDAY SCHOOL**, Reno, Nevada. St. John's Presbyterian Church, owner; \$90,000. ARCHITECT: Ferris & Erskine, Reno, 1 story, L shaped frame and brick veneer. Owner builds.

**2 WAREHOUSE BUILDINGS**, Benicia, Solano County. Corps of Engineers, owner; \$5,560,813. ENGINEER: John A. Blume, San Francisco. Reinforced concrete and structural steel construction. GENERAL CONTRACTOR: Stolte Inc., Fred J. Early, Jr. Co. & M & K Corp., Oakland.

**2 UNION BUILDINGS**, San Jose, Santa Clara County. Warehousemen & Helpers Union Local 287. Offices, auditorium and hiring hall, \$91,450. ARCHITECT: Donnell E. Jaekle, 1 story, frame and stucco construction. GENERAL CONTRACTOR: M. L. Blanchfield, San Jose.

**BAKERY BUILDING**, San Jose, Santa Clara County. Langendorf United Bakeseries, owner; \$490,432. ARCHITECT: Donnell E. Jaekle, San Jose, 1 story, 98,000 sq. ft., reinforced concrete, structural steel frame, wood roof, steel sash. GENERAL CONTRACTOR: Lew Jones Construction Co., San Jose.

**STORE BUILDING REMODEL**, Auburn, Placer County. Austin Morris, owner; \$55,000. ARCHITECT: Cometto & Johnson, Richmond. Interior & exterior remodel. GENERAL CONTRACTOR: Cahill Bros., San Francisco.

## PANACALITE

The Standard for Perlite Aggregates  
An Engineered Product—Engineering Service

Air Classified—Sized & Graded for  
Plaster, Concrete & Stucco  
Aggregates

Listed Underwriters' Laboratories

Re-examination Service

Fire Ratings:

Non-Bearing Walls— 2 hours  
Floor and Beam— 4 hours  
Column— 2 & 3 hours  
Suspended Ceiling— 4 hours  
Others

Manufactured by

American Perlite Corporation  
26th & B Sts.—Yard 2—Richmond  
EAccon 5-1385

**NEW JUNIOR HIGH SCHOOL.** Bakersfield, Kern County. Bakersfield Board of Education, owner. 20 classrooms, administration, music rooms, shops, gym, auditorium, home-economics, arts, library, cafeteria, etc. \$699,174. ARCHITECT: Ernest L. McCoy, Bakersfield. 1 story, approximately 64,000 sq. ft., frame and stucco construction, steel sash, asphalt tile floors. GENERAL CONTRACTOR: Guy E. Hall, Bakersfield.

**DINING HALL & KITCHEN.** San Anselmo, Marin County. San Francisco Theological Seminary, owner; \$195,700. ARCHITECT: James H. Mitchell & Harold W. Hawes, San Francisco. GENERAL CONTRACTOR: Robert McCarthy Co., San Francisco.

**SUPER MARKET BUILDING.** Alameda, Alameda County. George A. Sturtevant, owner; \$80,500. DRAFTSMAN: B. V. Harry, Berkeley. 1 story and 2 story; 100 x 155, frame and stucco construction, plate glass and tile front, asphalt tile floors. GENERAL CONTRACTOR: Conrad Roth, Alameda.

**OFFICE & LOFT BUILD'NG REMODEL.** San Francisco. Coast Equipment Co., owner; \$50,000. ARCHITECT: Frank F. Ehrenthal, San Francisco; interior and exterior remodel. GENERAL CONTRACTOR: Duncan H. Mallock, Oakland.

**LOW INCOME HOUSING PROJECT.** Fresno, Fresno County. Housing Authority, County of Fresno, owner; \$532,500. ARCHITECT: Walter Wagner, Fresno. Frame and stucco construction, plywood interior. GENERAL CONTRACTOR: L. H. Hansen & Son, Fresno.

**LOW INCOME HOUSING PROJECT.** Fresno, Fresno County. Housing Authority, County of Fresno, owner; 74 units, \$518,433. ARCHITECT: Walter Wagner, Fresno. Frame and stucco construction. GENERAL CONSTRUCTION: Harris Construction Co.

**CHURCH.** Los Gatos, Santa Clara County. First Presbyterian Church, owner; 1st unit, \$125,000. ARCHITECT: Ponsford & Price, Oakland. Frame and stucco construction. SUPERINTENDENT OF CONSTRUCTION: Edward Yeco, Los Gatos.

**GRAMMAR SCHOOL ADDITION.** Livingston, Merced County. Livingston Union Elementary School District, owner. 8 classrooms, kindergarten, toilet room, \$168,350. ARCHITECT: Frank Wynkoop & Associates. Frame and stucco construction. GENERAL CONTRACTOR: Graham & Jensen, Merced.

**NEW NORTH GRAMMAR SCHOOL.** Tracy, San Joaquin County. Tracy Elementary School District, owner. 6 classrooms, administration, kindergarten, multi-purpose, toilet room, \$254,951. ARCHITECT: Elmore G. Ernst, Stockton. Frame and stucco construction. GENERAL CONTRACTOR: Shepherd & Green, Stockton.

**BREWWOOD ELEMENTARY SCHOOL.** East Palo Alto, San Mateo County. Ravenswood Elementary School District, owner. 2 kindergarten, administration, multi-purpose, kitchen and toilet room, 12 classrooms, \$447,977. ARCHITECT: Arthur D. Janssen, Menlo Park. Frame and stucco construction. GENERAL CONTRACTOR: Wells P. Goodenough, Palo Alto.

**OFFICE BUILDING.** Reno, Nevada. Isbell Construction Company, owner; \$111,000. ARCHITECT: David Vhay, Reno. 1 story, brick and frame construction. GENERAL CONTRACTOR: Wiechman & Probasco Inc., Reno.

**HOSPITAL ADDITION.** Sparks, Nevada. State of Nevada, Planning Commission,

owner; \$138,068. ARCHITECT: Edward S. Parsons, Reno. 2 story, brick and reinforced concrete construction. GENERAL CONTRACTOR: Weil Construction Co., Reno.

**WESTMORE OAKS GRAMMAR SCHOOL.** Broderick, Yolo County. Washington Elementary School District, owner. 8 classrooms, administration, kindergarten, all-purpose, kitchen, toilet room, \$281,419. ARCHITECT: Barevotto & Thomas, Sacramento. Frame and stucco construction. GENERAL CONTRACTOR: Guth & Schmidt, Sacramento.

**WASHINGTON MANOR SCHOOL.** San Lorenzo, Alameda County. San Lorenzo Elementary School District, owner. 4 classrooms, multi-purpose, kitchen and toilet rooms, \$270,978. ARCHITECTS: Schmits & Hardman, Berkeley. Frame and stucco construction. GENERAL CONTRACTOR: Induceno, Oakland.

**JUAN CARRILLO SCHOOL ADDITION.** Monterey, Monterey County. Monterey Elementary School District, owner. 12 classrooms, \$117,277. ARCHITECT: Charles E. Butner, Salinas. GENERAL CONTRACTOR: Harold C. Goyer, Monterey.

**JUNIOR HIGH SCHOOL.** Coalinga, Fresno County. Coalinga Elementary School District, owner. 12 classrooms, administration, library, \$621,500. ARCHITECT: Marsh, Smith & Powell, Fresno. GENERAL CONTRACTOR: Trewthitt, Shields & Fisher, Fresno.

**FREEZER STORAGE BUILDING.** San Francisco. Merchants Ice & Cold Storage Co.,

owner; \$450,000. MECHANICAL ENGINEER: Kenneth D. McGrew, San Francisco. 1 story and mezzanine, 137 x 275, reinforced concrete construction, ceramic veneer coping, steel sash, cork and fibre glass insulation, refrigeration equipment. GENERAL CONTRACTOR: Cahill Bros., San Francisco.

**PALM AVENUE GRAMMAR SCHOOL ADDITION.** Auburn, Placer County. Auburn Joint Elementary Union School District, owner. 7 classrooms, kindergarten, administration, multi-purpose, kitchen and toilet rooms.

**NEW GRAMMAR SCHOOL.** Saratoga, Santa Clara County. Saratoga Elementary School District, owner. 5 classrooms and toilet rooms, \$99,890. ARCHITECT: Chas. E. Butner, San Jose. Frame and stucco construction. GENERAL CONTRACTOR: Oscar H. Liebert, Sunnyvale.

**NEW CITY HALL.** Napa, Napa County. City of Napa, owner. 1st unit, \$254,229. ARCHITECT: Barovetto & Thomas, Sacramento. 1 story, reinforced concrete and concrete block construction. GENERAL CONTRACTOR: J. A. Bryant, Vallejo.

**GRAMMAR SCHOOL ADDITION.** Salida, Stanislaus County. Salida Union Elementary School District, owner. 4 classrooms, kindergarten, \$84,589. ARCHITECT: Russell DeLoppe, Berkeley. Frame and stucco construction. GENERAL CONTRACTOR: Acme Construction Co., Modesto.

## Make your new homes more livable with built-in conduit and outlets

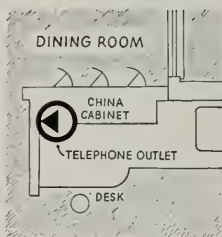

You're building extra convenience into your homes when you put concealed telephone wiring and built-in outlets in your plans. You're making it easy for your customers to add new extensions as they're needed... without boring holes or having exposed wiring.

Tiny details like these are the signs of a thoughtful builder. For built-in conduit and extra outlets will save your customers time and money later on. For free help, call your local Pacific Telephone office and ask for "Architects and Builders Service."

Put built-in telephone facilities in your plans



Pacific Telephone

## IN THE NEWS

### CONSTRUCTION COST INDEX STILL CLIMBS

According to figures recently announced by the American Appraisal Company the Construction Cost Index rose three points in June to a high of 531, representing an increase of 14 points since the first of the year.

With exception of a few material prices there were no increases since the stabilization program went into effect. Some grades and types of lumber decreased in price. Labor wage increases contributed almost entirely to the rise in the index for the first half of this year.

The index assumes normal average conditions and does not give recognition to overtime or premiums paid for materials in individual cases or under temporary abnormal conditions.

### ARCHITECT CHOSEN FOR SCHOOL WORK

Victor Galbraith, architect of Stockton, has been chosen by the Stockton Board of Education to design two new elementary school buildings for the City of Stockton.

One of the buildings will contain 8 classrooms, while the other will consist of 4 classrooms, office and library.

### NEW COUNTY OFFICE BUILDINGS SAN JOSE

The Board of Supervisors of the county of Santa Clara have started construction of Unit one of the new government Civic Center in San Jose. Of one-story, reinforced concrete construction, the first unit will cost \$430,000. Birge M. Clark and Walter Stromquist of Palo Alto are the architects.

### ARIZONA MEN FORM CONSTRUCTION FIRM

J. B. Donaldson and E. P. Morgan of Phoenix have organized the general contracting firm of Donaldson-Morgan Construction Company.

Donaldson was formerly associated with the Daum-Donaldson Construction Company, and Morgan has been a masonry contractor.

### BAY AREA HOME BUILDING IS UP

Homebuilders in the San Francisco-Oakland metropolitan area show a slight increase over the national average in the number of new non-farm dwelling units started since the first of the year, according to Max D. Kossoris, director of the Western Region of the U. S. Department of Labor's Bureau of Labor Statistics.

San Mateo county is one of the leading construction areas during the first portion of the year.

### CARPENTER WANTED BY CALIFORNIA

The State Personnel Board of the State of California is seeking a carpenter foreman for San Quentin Prison and is willing to pay up to \$395 a month to the right man.

Five year's experience, or two year's experience and completion of a carpentry apprenticeship is required, plus a civil service examination.

### NAMED PACIFIC COAST DISTRICT SALES MANAGER

S. J. Koltz, assistant district sales manager of the Tar Products Division of the Koppers Company, Inc., San Francisco, has been

named manager of Pacific Coast District Sales, and will assume his new duties in Los Angeles about September 1.

Prior to coming to the West Coast Koltz was assistant manager of the Koppers mid-west sales district division at Chicago.

### DR. W. E. ELWELL TO NEW YORK

Dr. W. E. Elwell of San Francisco has been appointed Manager of Eastern Product Development for the Oronite Chemical Company and will assume charge of the company's headquarters in New York.

He was formerly supervisor of Chemical Products for the California Research Corporation.

### NEW WEATHERPROOF JUNCTION BOXES

A new, heavy duty weatherproof junction box made of non-corrosive, cast aluminum will have been announced by the Stone Mfg. Co. of Elizabeth, New Jersey.

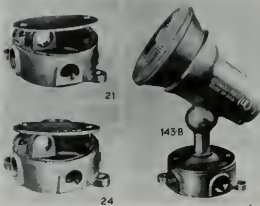

They include a variety of covers and fittings for universal use on almost any outdoor wiring or lighting job. The box has 4-hubs tapped 1/2" IPS; with or without mounting lugs; cover plate sealed with heavy cork gasket; and a separate cast aluminum cover tapped 1/2" IPS for standard lamp holders for 150-w, 200-w and 300-watt outdoor reflector bulbs.

### STRUCTURAL ENGINEER SELECTED FOR SCHOOL

Arthur Lauer, structural engineer of Sacramento, has been chosen by the Stockton Board of Education to supervise the construction of an addition to the City School and the Franklin High School.

### HOSPITAL STUDIES BEING COMPLETED

Architect Frank T. Georgeson is completing studies of the possibilities of constructing a new 4-story and 3-story basement garage wing for the St. Francis Hospital in San Francisco.

The new and modernized facilities would provide for surgery and X-ray, and would cost an estimated \$3,500,000.

### ARCHITECT CHOSEN FOR HIGH SCHOOL

The Stockton Board of Education has commissioned architect J. Upton Clowdsley of Stockton to draft plans and specifications for the construction of an addition to the Edison High School comprising a library and study hall.

### HOMEBUILDERS TO EUROPE FOR STUDY

Six of the leading home builders of America studied for Europe recently on a six week's stay of housing conditions in England, Holland, Switzerland, Italy, and France.

They will bring back results of their study for dissemination among the home building industry of the United States.

Among those making the trip is Ivan Wells, prominent Southern California home builder and resident of Beverly Hills.

### RETURNS TO UNIVERSITY OF CALIFORNIA BERKELEY

Dr. Kenneth S. Pitzer, who recently completed a two and a half year term as director of research for the nation's atomic energy enterprise, has returned to the University of California to take up his new duties as dean of the College of Chemistry.

In assuming his new post, Dr. Pitzer said every effort would be made to maintain the standards established by his recent predecessors, including the late Dr. G. N. Lewis and Drs. Wendell Latimer and Joel Hildebrand.

### WORK COMMENCED ON FOLSOM POWER PLANT

Construction work has begun on the Folsom Power Plant, located on the American River near the Folsom Dam site, with the establishment of a headquarters at the plant site by the Guy F. Atkinson Company, general contractors who have been awarded a \$1,463,721 contract for excavating.

When completed the new power plant will add 162,000 kw of hydroelectric generating capacity to the Central Valley Project of California.

### MASONIC TEMPLE ANNEX FOR RENO, NEVADA

The Masonic Temple Association of Reno, Nevada, are building an annex to the Masonic Temple at a cost of \$719,939.

The addition will contain general stores, and an Association office and Lodge rooms. Russell Mills, of Reno, is the architect.

### ARCHITECT CHOSEN

Architect Russell G. DeLappe of Berkeley, has been selected by the Toleneas Elementary School District, Solano county, to design an elementary school near Fairfield.

### SCHOOL BONDS ARE VOTED

Voters of the City of Modesto have approved a bond issue in the amount of \$1,100,000, with funds to be used in the construction of new elementary school buildings.

### NEW FARMERS MARKET FOR SACRAMENTO

Architects Rickey & Brook of Sacramento are designing a new Farmers Market building to be built in the city of Sacramento.

The building will be of 1-story, concrete and frame construction.

### NEW GIRLS COLLEGE BUILDINGS READIED

The College of Notre Dame, Belmont, is constructing a new girls college building in Belmont at a cost of \$800,000, and consisting of 1 and 2 story, administration, classrooms, cafeteria, kitchen and dormitories.

Vincent G. Roney, San Francisco, is the architect.

### NEW SHOPPING CENTER PROPOSED

Plans are underway for the construction of a 700-residence and new shopping center near Pleasanton, California, at an estimated cost of \$10,000,000.



**STATIONERY  
SCHOOL & OFFICE  
SUPPLIES**

•  
**Printing Engraving  
Announcements**

•  
**CENTER STATIONERY**

468 McAllister  
San Francisco UN 1-3703

**MULLEN MFG.  
COMPANY**

—  
**BANK, STORE AND OFFICE  
FIXTURES—CABINET WORK  
OF GUARANTEED QUALITY  
CHURCH SEATING**

—  
Office and Factory  
60-80 RAUSCH ST., Bat. 7th and 8th Sts.  
San Francisco  
Telephone UNdarhill 1-5815

**Thinking of Building?**

From our cost records and experience, an advance estimate may be made from decidedly general information. Based on our knowledge of labor and material costs, gained on current jobs, such an estimate may be helpful in determining your construction program.

ALL TYPES CONSTRUCTION  
SAN FRANCISCO • SACRAMENTO

**SWINERTON & WALBERG CO.**  
OAKLAND - LOS ANGELES - DENVER

*Fine*  
**ENGRAVINGS**



**POOR  
RICHARD**  
PHOTO ENGRAVING CO.  
320-324 COMMERCIAL STREET  
SAN FRANCISCO 11

Buildings will be of frame and stucco construction.

**MONTEREY COUNTY TO BUILD  
AGRICULTURAL BUILDING**

The Board of Supervisors of Monterey county are completing plans for the construction of a \$90,000 agricultural building in Salinas.

The building of 1-story frame and stucco construction with a shake roof is being designed by Architect Chas. E. Butler of Salinas.

**FACTORY SITE  
PURCHASED**

The Continental Can Company, San Francisco, recently announced purchase of a new factory site near Pittsburg (California) for construction of a multi-million dollar fibre shipping drum factory.

**NAVY AIRCRAFT PARKING  
AND LOADING AREA**

The U. S. Navy, Bureau of Yards and Docks, Public Works office in San Francisco, is building a \$2,044,200 addition to the aircraft parking and loading area at the Naval Air Station, Moffett Field.

**ARCHITECT SELECTED**

Harry A. Thomsen & Alec L. Wilson, Architects of San Francisco, have been selected by the State of California, Division of Architects, to design a new office building for the California State Employment Department at Sacramento.

Estimated cost of the building is \$7,000,000.

**NEW AGITAIR  
METER HERE**

A new ACITAIR meter for measuring air velocities has been announced by Air Devices, Inc. of New York.

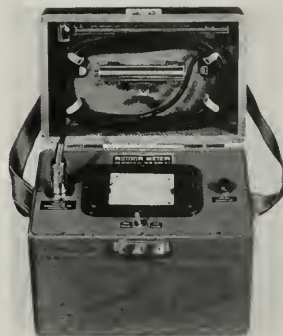

The meter is battery powered and especially designed for heating, ventilating and air conditioning engineers. Based on the hot thermopile principle, the instrument gives accurate instantaneous measurement of air velocities as low as 51pm and as high as 40001pm, with static readings from 0 to 4" wg.

**ARCHITECT SELECTED**

The Board of Supervisors for Tulare county have chosen James P. Lockett, Visalia, as architect for the county's new Juvenile Hall.

Site for the new building has been selected in the City of Visalia.

**Subscribe  
Now —**

**ARCHITECT  
and  
ENGINEER**

**\$3.00  
Per Year**

**DINWIDDIE  
CONSTRUCTION  
COMPANY**

•  
**BUILDERS**

•  
CROCKER BUILDING  
SAN FRANCISCO



**HERRICK  
IRON WORKS**  
STRUCTURAL STEEL  
REINFORCING STEEL

18TH AND CAMPBELL STS.  
OAKLAND, CALIF.  
Phone GLancourt 1-1747

Phone GARfield 1-1164

**Thomas B. Hunter**  
DESIGNER OF HEATING

AIR CONDITIONING  
VENTILATING AND WIRING  
SYSTEMS, MECHANICAL  
AND ELECTRICAL EQUIP-  
MENT OF BUILDINGS

★  
41 SUTTER STREET  
ROOM 710

San Francisco

California



**PITTSBURGH  
TESTING LABORATORY**

**ENGINEERS AND CHEMISTS**

Testing and Inspection of Concrete,  
Steel and Other Structural Materials

Design of Concrete Mixes

Offices in all principal cities

651 Howard St., San Francisco 5  
EXbrook 2-1747

**MATTOCK  
CONSTRUCTION  
COMPANY**



**BUILDERS**



604 MISSION STREET  
SAN FRANCISCO

Subscribe  
Now —

**ARCHITECT  
and  
ENGINEER**

\$3.00  
Per Year

**STOLTE INC.**

**General Contractors**



**OAKLAND • CALIFORNIA**

**Index to Advertisers**

ACME Manufacturing Co., Inc.	33
ALTA Roofing Co.	34
AMERICAN Perlite Corp.	56
ANGER Pacific Corp.	47
ARCHITECT'S Reports	50
BARRETT & Hills, Contractors	4 & 47
CAPITAL City Painters	31
CENTER Stationery	59
CENTRAL Electric	31
CLASSIFIED Advertising	55
CLAY Brick & Tile Ass'n.	3
CLINTON Construction Co.	48
CROCKER First National Bank	50
DANERI, Angelo; Lath & Plaster Contractor	34
DICKINSONS Lumber Co.	
Inside Front Cover	
DINWIDDIE Construction Co.	59
DONOVAN Building Specialties Co.	33
ECKER, J. F.; Painting Contractor	36
ELECTROMODE Corp.	*
ENGINEERED Metals, Inc.	32
FAIR Manufacturing Co.	32
FORDERER Carnice Works	47
FULLER, W. P. Co.	*
GLADDING, McBean & Co.	7
GRASSI, P. & Co. and American Terrazzo Co.	32
GREENBERG'S, M. Sons	37
HANKS, Inc.; Abbott A.	60
HAW'S Drinking Faucet Co.	40 & 41
HERRICK Iron Works	59
HILLYARD Chemical Co.	44
HOGAN Lumber Co.	48
HUNDLEY, E. M.; Hardware Co.	35
HUNT, Robert W., Co.	60
HUNTER, Thos. B., Co.	60
JOHNSON, S. V. Co.	37
JUDSON, Pacific-Murphy Corp.	48
KRAFTILE Company	38
LEE, Harry; Plumbing & Heating Co.	34
MARBLE Institute of America	*
MATTOCK Construction Co.	60
MERCURY Press	30
MICHEL & Pfeffer Iron Works	10
MULLEN Mfg. Co.	59
MURPHY Bro's.	31
PACIFIC Clay Products Co.	*
PACIFIC Manufacturing Co.	49
PACIFIC Portland Cement Co.	
Back Cover	
PACIFIC Telephone & Telegraph Co.	57
PARKER, Steffens & Pearce	47
PITTSBURGH Testing Laboratory	36 & 60
POOR Richard Engraving Co.	59
PORCELAIN Enamel Publicity Bureau, Architectural Division	2
REGAL Roofing Co.	35
REMILLARD-Dandini Co.	60
REPUBLIC Steel Corp.	49
ROLAND Lumber Co., Inc.	1
SCOTT Co.	9 & 60
SIMONDS Machinery Co.	49
SISALKRAFT Co.	48
SMOOT-Holman Co.	45
SOTO, Henry; Corp. Landscape Engineers	45
STANLEY Works, The	*
SPENCER, F. W. & Son, Inc.	30
STEELFORM Contracting Co.	35
STOLTE, Inc.	60
SWIFT, C. E. Roofing Co.	32
SWINERTON & Walberg Co.	59
U. S. BONDS	Inside Back Cover
UTILITY Appliance Corp.	46
VERMONT Marble Co.	49
WEBER, Emil J., Electrical Contractor	36
WEST Coast Screen Co.	43
WESTERN Asbestos Co.	*

\*Indicates Alternate Months

**Scott Company**

**HEATING • PLUMBING  
REFRIGERATION**



San Francisco  
Oakland  
San Jose  
Los Angeles

**ABBOTT A. HANKS, INC.  
Engineers & Chemists**

INSPECTING — TESTING — CONSULTING  
CONCRETE • STEEL • MATERIALS  
CHEMICAL AND TESTING  
LABORATORIES

• RESEARCH AND INVESTIGATION •

—  
TESTS OF STRUCTURAL MATERIALS  
DESIGN OF CONCRETE MIXES  
SHOP AND ERECTION INSPECTION OF  
STRUCTURES AND EQUIPMENT  
INVESTIGATION OF STRUCTURES  
AND MATERIALS  
TESTS AND INVESTIGATION OF  
FOUNDATION SOILS  
FIRE RESISTANCE AND INSULATION  
TESTS

624 Sacramento Street, San Francisco

**ROBERT W. HUNT CO.**

**ENGINEERS**

**INSPECTING TESTING**

**STRUCTURAL MATERIALS  
CONCRETE MIX DESIGN  
CHEMICAL ANALYSIS  
EQUIPMENT**

PRINCIPAL CITIES  
UNITED STATES • EUROPE  
SAN FRANCISCO      LOS ANGELES  
PORTLAND              SEATTLE

**REMILLARD-DANDINI Co.**

**Brick and  
Masonry Products**



400 MONTGOMERY STREET  
SAN FRANCISCO, CALIF.

# ARCHITECT AND ENGINEER

NEW PUBLIC LIBRARY

Oakland, California



MILLER & WARNECKE Architects

SEPTEMBER

1951

# FUL-COLOR

the only rubber-base paint  
you can buy in...

# any color



# you want

Now available in all the  
216 colors in Fuller's famous  
Color Control System

Only Fuller is offering a latex-base interior paint in all deep colors. Not just a few popular tones—but all the modern deep colors from which so many hundreds of shades and tints are possible. Now, the painting industry's finest color tool applies equally to Fuller's revolutionary, new rubber-base paint—Ful-Color!



## Ful-Color does everything former flat finishes couldn't do!

Ful-Color works so fast and dries so fast that a room can be used the night of the day it's painted.

Ful-Color dries to a continuous, non-porous surface that seals itself against dirt. Dirt can't get under its surface, but stays on the film where it's easy to wash clean again and again for years.

Ful-Color has no "painty" odor at all. Can be

used in a closed room with complete comfort.

Ful-Color is safe wherever you use it; never any fire hazard!

Ful-Color gives a velvet-soft, flat finish over plaster, composition walls AND woodwork. Yes, a washable flat for woodwork!

Ful-Color IS revolutionary: a faster, smoother, self-sealing, completely washable velvet-soft flat interior finish.



Ask your nearest Fuller Branch for a demonstration...

# ARCHITECT

Vol. 186 No. 3

# AND ENGINEER

ARCHITECTS' REPORTS—Published Daily

EDWIN H. WILDER  
Editor

MARK DANIELS, A.A.  
Associate Editor

J. WELLS HASTINGS  
Contributing Editor

PROF. LELAND VAUGHAN  
Landscape Architecture

JOHN A. BLUME  
Structural Engineering

MICHAEL GOODMAN  
Planning

JOHN S. BOLLES, A.A.  
Book Reviews



## COVER PICTURE:

Adjacent to beautiful Lake Merritt in downtown Oakland, the City has recently constructed a new City Library, designed by the architectural firm of MILLER & WARNECKE, and constructed by Stolte, Inc., general contractors.

The view shown here is from the "Lake" side. For complete details see Page 20.

ARCHITECT & ENGINEER  
is indexed regularly by  
ENGINEERING INDEX, INC.

## Contents for

# SEPTEMBER

EDITORIAL NOTES . . . . .	4
JOINT INFORMATION COMMITTEE American Institute of Architects and The Producers Council, Inc.	8
NEWS & COMMENT ON ART . . . . .	9
AMERICA NEEDS PRACTICAL, Not Pretty Schools . . . . .	11
CONTRACTORS' COSTS HAVE RISEN Far More Than Is Generally Recognized —Proposed Tax Legislation By GEORGE C. KOSS, Koss Construction Company, Des Moines, Iowa	11
AIR CONDITIONING Principles and Objectives (Part I) . . . . . By H. L. WOLLMAN, Research Engineer	12
SOLVE CONSTRUCTION PROBLEMS BEFORE BUILDING—Not After By CHARLES E. BALLEISEN, Supervisor Mechanical Laboratory, Southwest Research Institute, San Antonio, Texas	17
RECENTLY COMPLETED PUBLIC LIBRARY, Oakland, California . . . . . CHESTER H. MILLER & CARL I. WARNECKE, Architects STOLTE, INC., General Contractor	20
ANNUAL CONVENTION—Structural Engineers Association of California— Yosemite Park . . . . .	24
A.I.A. ACTIVITIES . . . . .	26
WITH THE ENGINEERS . . . . .	28
PRODUCERS COUNCIL PAGE . . . . . Edited by CARL B. FRANK, Detroit Steel Products	30
BOOK REVIEWS, Pamphlets and Catalogues . . . . .	36
ESTIMATOR'S GUIDE, Building and Construction Materials . . . . .	39
ESTIMATOR'S DIRECTORY, Building and Construction Materials . . . . .	41
BUILDING TRADES WAGE SCALES, Northern, Central & Southern California . . . . .	42
CLASSIFIED ADVERTISING . . . . .	43
CONSTRUCTION CONTRACTS AWARDED, General Data . . . . .	44
IN THE NEWS . . . . .	46
INDEX TO ADVERTISERS . . . . .	48

ARCHITECT AND ENGINEER (Established 1905) is published on the 15th of the month by The Architect and Engineer, Inc., 68 Post St., San Francisco 4; Telephone EXbrook 2-7182. President, E. P. Kierulff; Vice-President and Manager, L. B. Penhorwood; Treasurer, E. N. Kierulff.

Los Angeles Office: Wentworth F. Green, 439 So. Western Ave., Los Angeles 5; Telephone DUunkirk 7-8135.

Entered as second class matter, November 2, 1905, at the Post Office in San Francisco, California, under the Act of March 3, 1879. Subscriptions United States and Pan America, \$3.00 a year; \$5.00 two years; foreign countries \$5.00 a year; single copy 50c. ARCHITECTS' REPORTS are published daily from this office, Vernon S. Yallop, Manager, Telephone DOuglas 2-8311.





# EDITORIAL NOTES

## SAVINGS ARE ESSENTIAL

One aspect of our national stabilization policy that has been quite seriously neglected is the stimulation of individual interest in a voluntary savings program.

Any successful anti-inflationary policy requires a universal effort to maintain the local communities as a whole from attempting to buy more goods and services than are readily available.

In this effort the government has a definite responsibility to economize in its own expenditures, to keep taxes as low as possible, and to conduct its functions on the same sound basis as does the individual.

The action of private individuals can not determine the ultimate success or failure of our generally accepted way-of-life, it will take the combined effort of private individual and government to maintain us as a "free" society.

*There is no hazard that human intelligence cannot rise to—each individual is the Architect of his own future.*

## STIMULATED HOUSING SHORTAGE

Defense housing, public or private, will not involve more than 50,000 to 100,000 units during 1951, and may not be much more in 1952 unless government policies are broadened.

Consequently, there is little likelihood that defense housing can occupy more than a fraction of the builders in more than a fraction of our cities. It can't be looked to as a substitute for a general building program or even as a prop for essential housing needs.

*October 7 to 13 is National Employ the Physically Handicapped Week. You can do your part in taking care of a disabled veteran or other physically handicapped person.*

## NATIONAL HOME WEEK

Practically every week of the year is set aside for the observation of some industry, product, or public service event, and it is quite natural that among the most important is the annual observation of "Home Week."

This year the National Association of Home Builders is going to recognize the efforts of real estate editors among the nation's newspapers who devote special sections to the paramount importance of the American home as a part of our American way of life. Activities of real estate editors will be reviewed by a special committee of the National Association of Home Builders and

recognition of the most outstanding will be observed at the annual convention of the organization in January, although "National Home Week" is to be observed during October.

A nationwide program designed to draw public attention to the American home, is a great opportunity for the Architectural profession to step to the front and show by thousands of outstanding examples the real value and lasting importance of architectural assistance in the planning, or remodeling, of any home.

The difference between just a "house" and a "real home" may be a few suggestions and ideas offered by a professional Architect, and in all probability most real estate editors of America's newspapers will welcome the assistance of local Architects in gathering together for presentation during "National Home Week" the best examples of a real home.

*"A London stenographer, with a year's experience, receives about \$15 a week."—Applicants for stenographic jobs in London, form line at left.*

## THE AVERAGE FAMILY

The "average family" in the United States is in a better position today to afford a home than it was prior to World War II, because family incomes have increased more rapidly during the past few years than have costs of building.

This generally improved economic factor is greater among families in the lower bracket of the income scale than it is in any other, owing to the fact that national income averages are higher due to above average increases in income and continuous employment.

The Bureau of the Census estimates that the medium income of non-farm families whose sole income is from wages or salaries, increased from \$1,431 in 1939 to \$3,577 in 1949, a gain of 150 per cent.

During the same era, the cost of building a house rose 108 per cent, which means the "average" family can afford at least twenty per cent more house than it could.

Figures show that the cost of living for the same period of time went up about seventy per cent, indicating there was more "spending money" available.

The only factor needed at this time to permit the "average" family to become a home owner is less effort on the part of Government to regulate and control the construction of new homes by independent home builders.

TO PERFECTLY EXPRESS A CUSTOM EFFECT OR IDENTICALLY  
MATCH AN ESTABLISHED COLOR SCHEME, SPECIFY

Porcelain

**ENAMEL  
VENEER**



Architect  
Wellton Becket and Associates, A. I. A.  
Contractor  
Wm. Simpson Construction Company



Combining positive brand identity with inviting cleanliness, Porcelain Enamel Veneer was utilized in this windmill, tower and canopy fascia construction. Even deep tones and delicate pastels are completely fadeproof...the vitreous surface of architectural porcelain locks color in, seals weather out. When seeking an exterior facing material for lasting trade identification and permanent beauty, specify Porcelain Enamel Veneer.



INVESTIGATE PORCELAIN ENAMEL PANELS FOR CURTAIN WALLS IN ESSENTIAL BUILDING CONSTRUCTION

*Architectural Division*

PORCELAIN ENAMEL PUBLICITY BUREAU  
P. O. BOX 186, EAST PASADENA STATION, PASADENA 8, CALIFORNIA  
ROOM 601, FRANKLIN BUILDING, OAKLAND 12, CALIFORNIA



★

★

Medal  
of  
Honor



Sergeant Charles Turner, of Boston, Massachusetts—Medal of Honor, Korea. On September 1, 1950, near Yongsan, Korea, Sergeant Turner took over an exposed turret machine gun on a tank. Despite fifty direct hits on the tank, he stayed by his gun and destroyed seven enemy machine gun nests before he was killed.

You and your family are more secure today because of what Charles Turner did for you.

Sergeant Turner died to keep America free. Won't you see that America *stays* the land of peace and promise for which he gave his life? Defending the things he fought for is *your* job, too.

One important defense job you can do *right now* is to buy United States Defense\* Bonds and buy them regularly. For it's your Defense Bonds that help keep America strong *within*. And out of America's inner strength can come power that guarantees security—for your country, for your family, for *you*.

---

Remember that when you're buying bonds for national defense, you're also building a personal reserve of cash savings. Remember, too, that if you don't save *regularly*, you generally don't save at all. Money you take

home usually is money spent. So sign up today in the Payroll Savings Plan where you work, or the Bond-A-Month Plan where you bank. For your country's security, and your own, buy U. S. Defense Bonds now!

**\*U.S. Savings Bonds are Defense Bonds - Buy them regularly!**



The U. S. Government does not pay for this advertisement. It is donated by this publication in cooperation with the Advertising Council and the Magazine Publishers of America as a public service.

OAKLAND  
PUBLIC LIBRARY

125 Fourteenth Street



STOLTE, INC.

GENERAL CONTRACTORS

OAKLAND • CALIFORNIA



# JOINT INFORMATION COMMITTEE

AMERICAN INSTITUTE OF ARCHITECTS and THE PRODUCERS COUNCIL, INC.

---

## 1951 ANNUAL CONVENTION

# CALIFORNIA COUNCIL

of

# ARCHITECTS

OCTOBER 4-5-6-7

## HOTEL DEL CORONADO

☆ Business will be mixed with pleasure as architects and their wives, members of the Producers' Council, Inc., their wives, and guests representing a number of allied interests in the Construction Industry meet at the Hotel del Coronado, Coronado, on October 4 - 5 - 6 - 7.

☆ Among the highlights of the Convention Program will be an explanation of the history and intricacies of "Palomar Observatory" by Dr. Rudolph Minkowski; Henry M. Heymann, division counsel for the Construction Controls Division of the National Production Authority will speak on the subject "Outlook for Materials"; and Carlos Contreras, internationally known architect of Mexico will speak on "From Wasteland to Profitable Enterprise".

☆ General and Business Sessions will be in charge of John Rex, A.I.A. of Los Angeles, president of the Council. Among other noted architects scheduled to appear on the program are Anson Boyd, California State Architect; Glenn Stanton, Portland, Oregon architect and national president of the American Institute of Architects; and Edmund Purves, executive secretary of the A.I.A., Washington, D. C.

---

*NOTE: This news space is being contributed by ARCHITECT & ENGINEER Magazine to the JOINT INFORMATION COMMITTEE representing the Northern California Chapter of The American Institute of Architects and the Northern California Chapter of the Producer's Council, Inc., and is available to this Committee for the purpose of bringing to the attention of leaders within the Construction Industry various phases of the Architectural profession and building materials industry procedures for general consideration and comment. Your "ideas" and any suggestions for the better pooling of thoughts along these lines should be sent to "Joint Information Committee, c/o The Architect & Engineer, 68 Post Street, San Francisco," where they will be immediately forwarded to the proper committee members.*

# NEWS AND COMMENT ON ART

## CITY OF PARIS

The Rotunda Art Gallery of the City of Paris, San Francisco, under the direction of Beatrice Judd Ryan will feature a group of caricatures by Antonio Sotomayor; Portraits and Landscapes by Moya Del Pino; and a number of Decorative Paintings by Ralph Cornell Seigle, during the month of September.

The Pictures of the Month will feature Water-colors by Ellen A. Ochi.

Advance notice of events scheduled for October, show that a special exhibit is being planned by the San Francisco Orchid Society, an affiliate of the American Orchid Society, and a special showing of Sculpture will be made by twenty west coast artists. There will also be a group of Mosaics by Louisa Jenkins.

## PORTLAND ART MUSEUM

Thomas C. Colt, Jr., director of the Portland Art Museum, West Park and Madison, announces the following schedule of exhibits which will highlight the Museum's activities during the next few months:

Starting September 5th and continuing to October 18th the famed "ITALY AT WORK" group of

more than 1500 items representing the work of hundreds of designers and craftsmen will be shown, together with the annual exhibit of DRAWINGS by OREGON ARTISTS—1951.

The Board of Trustees have purchased four new acquisitions to the permanent collections through the Ayer Fund. An Indian stone mortar from the Columbia River Region; a wooden Tlingit mask of exceptional age and quality; an etching on vellum by Picasso; and a Northwest Coast Indian Horn spoon inlaid with abalone shell.

The Saturday morning classes for Children will resume on September 22nd.

The Clovis Corinth Memorial Exhibition, featuring old master drawings from the Sulda, Manning and Scholz Collection will go on exhibition October 25; and a special group of Twenty-one Modern British Painters, Prints by Oregon Artists-1951, and Photographs by Aaron Siskin and Jerome Leibling will go on display starting November 29th.

## M. H. deYOUNG MEMORIAL MUSEUM

The M. H. deYoung Memorial Museum in Golden Gate Park, San Francisco, under the direction

## SAN FRANCISCO MUSEUM OF ART

Civic Center

STANDING and

RECLINING FIGURES

Color Lithograph

By

Henry Moore

From the Museum Collection

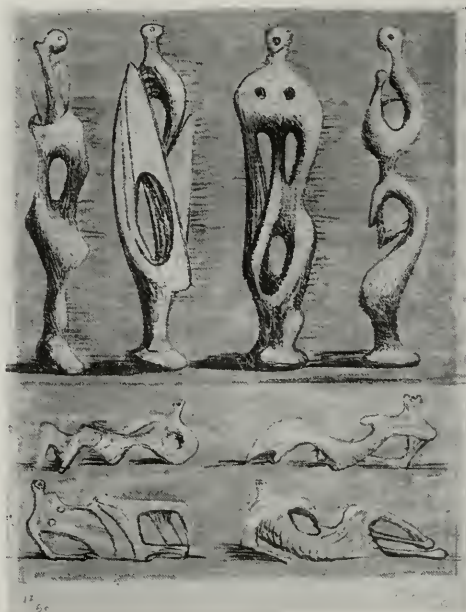

of Walter Heil, has arranged a special exhibit of Japanese art treasures representing one of the most impressive exhibitions ever assembled outside Japan.

The loan of the works was made possible by the joint efforts of the Museum and the Japanese Government, and was prepared in conjunction with the signing of the Japanese Peace Treaty in San Francisco early in September.

The Show was shipped direct from Japan accompanied by seven scholars and technical specialists who will explain details of the Oriental arts. Many items have been lent by the Japanese National Museums, temples and private owners including the Emperor.

The exhibition consists of a group of fifty-four paintings including all the forms and techniques traditionally used by the painters of Japan. Scrolls as well as folding screens. Works painted in color on silk or paper and others in monochrome, done with the brush in ink on paper. While the early paintings of the 12th and 13th centuries are mostly of religious (Buddhist) subjects, the later ones offer the greatest variety of subjects: landscapes, flower pieces, animals, figure scenes mostly taken from literature or ancient myths. Among famous individual painters are represented Sesshu 1420-1506, Monetobu 1476-1559, Sesson 1504-1584, Musho 1533-1615, Korin 1655-1716, Goshun 1752-1811, Hoitsu 1761-1828, Sesetsu 17th century, Koto 1601-1682, Hasonobu 1690-1768, Shunsho 1726-1792, Utamaro 1754-1806; the latter three also widely known for their splendid wood-block prints.

**Wood-Block Prints: Calligraphy:** 10 choice examples of ancient calligraphy will give an idea of artistic writing, so highly regarded in the countries of the Far East. There are 51 fine wood-block prints by such masters as Hiroshige, Hokusai and Harunobu.

**Sculpture:** A most important part of the exhibition! Prehistoric grave figures in terra cotta; outstanding works of Buddhist sculpture from the 8th to the 13th centuries, in bronze and wood, mostly on loan from temples; carved masks from the 6th to the 17th centuries, used in ritual dances and the Noh theatre.

**Metalwork:** "Dotaku" (bronze bells) from the Bronze Age (prior to 3rd century) rare tokens of the earliest Japanese civilization. Mirrors and other finely wrought implements from the 11th to the 17th centuries.

**Armor, Swords, and "Sword Furniture:"** Ancient examples of exceptional beauty of the craft of Japanese armorers and swordsmiths.

**Lacquer Art:** Choice works in lacquer (boxes, saddles, drums, etc.) from the 13th to the 17th cen-

tury, in the production of which the Japanese artisans particularly excelled.

**Ceramic Art:** Early pottery and porcelain, including exceptional and beautiful examples of bowls used in the traditional Japanese tea ceremony (Cha-no-yu).

**Textiles:** Precious silk fabrics, among which are very early and rare specimens from the 8th century, Shoso-in Imperial Repository at Nara; priest's robes, Noh costumes.

All of these treasures have been carefully selected so as to form a well-balanced and fully rounded image of the refined and decorative arts of the Japanese. The American public will thus have an opportunity, never before available, to see a comprehensive presentation of work by the greatest Japanese artists and to gain an appreciation for their inventiveness, refined taste and inimitable skill.

#### ROSICRUCIAN EGYPTIAN ORIENTAL MUSEUM

James C. French, curator of the Rosicrucian Egyptian, Oriental Museum and Art Gallery, Rosicrucian Park, San Jose, announces an exhibit of the painting of Lora Dormeyer for the month of September.

#### BRANDENSTEIN CERAMICS SCHOLARSHIP ANNOUNCED

Persons wishing to compete for the Agnes Brandenstein Memorial Scholarship in Ceramics for the academic year 1951-52, should submit three pieces of their work to California School of Fine Arts, 800 Chestnut street, San Francisco.

Scholarships will be awarded by the Faculty to the person whose work shows the greatest promise. The winner is entitled to free tuition and studio fees.

#### SAN FRANCISCO MUSEUM OF ART

The San Francisco Museum of Art, War Memorial Building, Civic Center, will show the following events and exhibits during September, according to Museum officials.

**Exhibitions:** "Advancing Art;" "Tradition and Experiment in Modern Sculpture;" "What Americans Are Collecting;" Portfolio No. 2, National Parks and Monuments, a group of photographs by Ansel Adams; New Works by Bay Region Painters and Sculptors; Pairs Posters; and Educational Toys.

**Events:** The Campion Festival concerts will be presented in association with the Campion Society, on the 6th, 11th, 13th, 24th and October 1st.

(See Page 32)

# AMERICA NEEDS PRACTICAL NOT PRETTY SCHOOLS

## Educator Sees Need for Designing Classrooms to Meet Pupils' Needs

America is building "too many community monuments" instead of real working classrooms that will help school children, according to Dr. Darell B. Harmon of Austin, Texas, one of the consulting educationists who spoke recently at the Stanford University's "Institute On Classroom Planning" in Palo Alto, California.

Dr. Harmon feels that "despite notable intentions of community sponsors, too many schools are not what they should be—economical and functional buildings."

"The money being put into artificial chimneys, balconies and towers to achieve a pseudo-esthetic appearance could be better spent for additional

classrooms," he said. "Heating, for example, should be based on such considerations as the number of pupils in the class and their average age. Lighting should be planned with contrast, brightness and glare the determining factors.

"A child's body may easily grow along lines of stresses brought about by poor lighting, faulty heating and other harmful environmental conditions in the classroom and in the end the body may be subject to physical and psychological damage.

"Parents and educators," he said, "have failed to realize how close is the relationship between the child's mental, psychological and social prob-

(See Page 34)

---

## PROPOSED TAX LEGISLATION

# CONTRACTORS' COSTS HAVE RISEN FAR MORE THAN IS GENERALLY RECOGNIZED

By **GEORGE C. KOSS**, Koss Construction Company  
Des Moines, Iowa

This statement is filed on behalf of members of The Associated General Contractors of America, for your consideration in conjunction with proposed tax legislation.

The Associated General Contractors of America is the nation-wide association representing more than 5,800 of the nation's leading general contractors, who execute all types of construction and

annually perform approximately eighty per cent of the volume of contract construction in the nation. There are 113 affiliated local associations throughout the United States and Alaska.

The operations of the general contractor are unlike the operations of members of any other industry in the nation. The general contractor has no inventory, depending entirely on skill and ingenuity and the various types of construction equipment to produce a profit. The general contractor's equipment must be used in all kinds of weather and under varied conditions. It is not protected from the elements and when in operation cannot be completely maintained. In this respect it differs very materially from industries where the

(See Page 35)

GEORGE C. KOSS

*EDITOR'S NOTE: Presented herewith for the information of everyone connected with the construction industry, is a statement by George C. Koss, Koss Construction Company, Des Moines, Iowa, on behalf of members of The Associated General Contractors of America, Inc., before the United States Senate Finance Committee, pertaining to proposed tax legislation.*



# AIR CONDITIONING

## PRINCIPLES and OBJECTIVES

### PART I

By H. L. WOLLMAN, Research Engineer\*

Widespread use of air conditioning in commercial establishments has become a reality. Architects, management executives and engineers are today agreed on the need for some form of atmospheric control in business premises.

Budget considerations usually limit the engineer in his efforts to provide a satisfactory environment for the performance of work and the transaction of business. It is not surprising that such economic restrictions exist, nor is it especially undesirable. There is a growing tendency, however, to impose these restrictions in a way which sometimes leads to a result which is the direct opposite of that which management intended: that of obtaining maximum value for the money expended.

Such a situation has developed around the choice between evaporative cooling and mechanical refrigeration for summer air conditioning. Management has been quick to compare the cost of installations using refrigeration with those using evaporative cooling, without recognizing the fact that evaporative cooling frequently is incapable of achieving results comparable with those of refrigeration.

It is the intent of this discussion to propose a rational system of evaluating the performance of the two types of systems on a common basis and to point out that, for comparable performance, evaporative cooling does not always provide the most economical solution.

### THERMODYNAMIC CONSIDERATIONS

In order to be able to determine the extent to which air in any given condition is able to provide a comfortable environment, it is necessary to be familiar with certain aspects of the heat-moisture-temperature relationships that exist for air. Accord-

\*EDITOR'S NOTE—Herewith is Part I of a Two-Part Research Report prepared for The Capital Company by H. L. Wollman, prominent West Coast engineer. Part I of the Report is devoted to a theoretical consideration of the subject of air conditioning in commercial establishments. Part II, which will appear in ARCHITECT & ENGINEER magazine next month, is devoted to the actual application of air conditioning principles to commercial use.

ingly, a review of some of the properties of air will be undertaken first.

### DRY AIR

Dry air is a mixture of gases, principally nitrogen and oxygen, with minor amounts of other gases. For the purpose of this discussion, it will be unnecessary to consider the behavior of air with respect to changes in pressure; only the standard barometric pressure of 29.92 inches of mercury will be considered.

If heat is added to dry air, the temperature of the air rises, and if heat is removed, the temperature falls. There is a quantitative relationship involved in this effect: the quantity of heat which must be absorbed by one pound of dry air in order to raise its temperature one degree Fahrenheit equals 0.24 British Thermal Units (Btu). Thus, to raise the temperature of one pound of dry air from 40° F. to 70° F. would require the addition of

$$(0.24) (70-40) = 7.2 \text{ Btu.}$$

Similarly, to lower the temperature of one pound

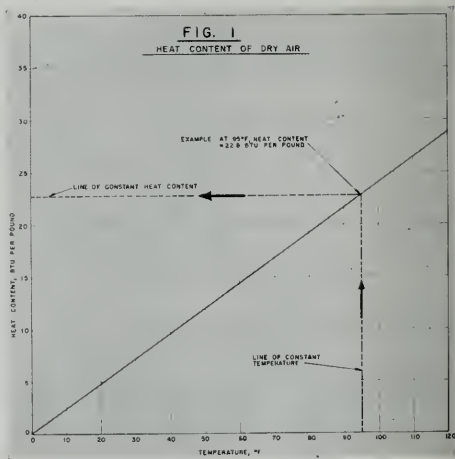

of dry air from 95° F. to 75° F. would require the removal of

$$(0.24)(95-75) = 4.8 \text{ Btu.}$$

In the first example above, it may be said that one pound of dry air at 70° F. contains 7.2 Btu more than a pound of dry air at 40° F. This concept of **heat content** is convenient and, if some temperature is selected as a datum, it is possible to assign to each temperature a particular heat content. In air conditioning work, dry air at 0° F. is arbitrarily taken as the state having zero heat content. Thus, dry air at 50° F. has a heat content of 12 Btu per pound, at 95° F. a heat content of 22.8 Btu per pound, etc.

This relationship may be tabulated or it may be shown graphically in a variety of ways. For example, a conventional chart is shown in Fig. 1. The procedure used with this type of graph is to enter the chart at the temperature under consideration, follow the line of constant temperature (vertical) to intersection with the curve and from there follow a line of constant heat content (horizontal) to the heat content scale.



The type of graphical plot used in air conditioning is shown in Fig. 2. Here the procedure is to enter at the temperature under consideration and follow an inclined line of constant heat content to the inclined heat content scale. The desirability of such a representation is not apparent when dry air alone is considered. Its utility will appear when it becomes necessary to show the heat content of both dry and moist air on the same chart.

### MOIST AIR

It is possible for air to exist in a state of mixture with water vapor. The amount of water vapor which can be mixed with one pound of air is not, however, without limit. For each temperature there

is a definite maximum weight of water vapor which can exist in mixture with air at that temperature, and as the temperature increases, so also does the amount of water vapor that can exist in mixture with air increase. In this respect water vapor and air behave in a manner analogous to sugar and liquid water.

It is a matter of everyday experience that the amount of sugar that can be dissolved in, say, a cup of cold water is limited. If a quantity of sugar slightly in excess of this maximum amount is added to the water, the excess quantity will settle out of the water regardless of how vigorously the mixture is first agitated. If now the water is raised to a higher temperature, the excess sugar will dissolve. Further addition of sugar will result in a new undissolved excess in the bottom of the cup, but still further heating will cause the new excess to be dissolved, and so on.

The behavior of air and water vapor is similar. The maximum amount of water vapor that one pound of air can hold at any temperature has been carefully determined. Air which is mixed with the maximum amount of water vapor that it can hold at any given temperature is said to be saturated at that temperature. A few of these saturation quantities are tabulated below.

### Weight of Water Vapor to Saturate One Pound of Dry Air

FIG. 3

### Weight of Water Vapor to Saturate One Pound of Air

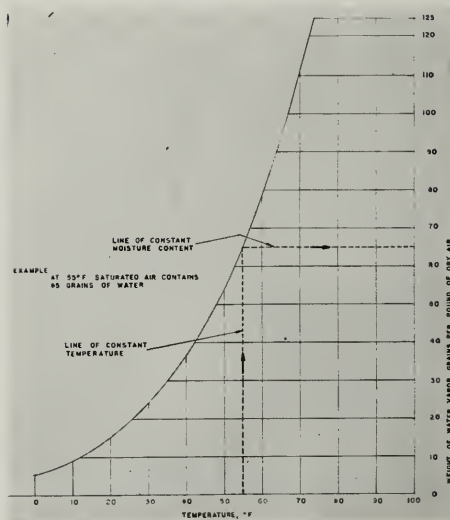

Temperature, °F.	Weight of Water Vapor, Grains
0	5.51
20	15.06
40	36.49
60	77.56
80	156.3
100	302.3
120	570.4

This relationship between temperature and the weight of water vapor required to saturate one pound of air is shown graphically in Fig. 3. The chart is entered at the temperature under consideration, the vertical line of constant temperature is followed to its intersection with the curve, from which point the horizontal line of constant moisture content is followed to the scale where the weight of water vapor is read.

Although there is an upper limit to the amount of water vapor that can be carried by air at any temperature, the amount actually carried may be anything from zero to the quantity required to saturate the air at that temperature. It is convenient to describe conditions which are intermediate between dryness and saturation in terms of a quantity known as **relative humidity**. One pound of air at, say 55° F. is saturated if it contains 65 grains of water vapor. If, at this same temperature, it contains only 50% of this amount, or 32.5 grains, it is said to have a relative humidity of 50%.

**FIG. 4**  
**Relative Humidity and Moisture Content**

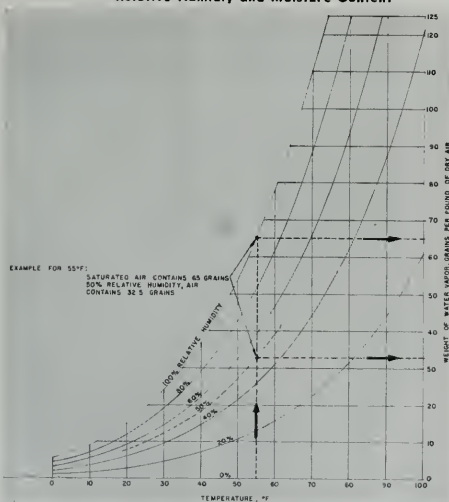

By such a procedure the moisture content of air at any temperature and any relative humidity may be calculated, and the result can be shown gra-

phically. Fig. 4 is a repetition of Fig. 3 with the addition of curves of moisture content for several relative humidities, taken at 20% increments. Under this system of notation, dry air has a relative humidity of 0% and saturated air has a relative humidity of 100%.

Any quantity of water vapor at any particular temperature contains more heat than the same weight of liquid water at that same temperature. The difference is the quantity of heat required to vaporize that quantity of water, usually called the latent heat of vaporization. The latent heat of vaporization of water varies with temperature, but in the conditions encountered in air conditioning, is in the neighborhood of 1000 Btu per pound of water. As in the case of dry air, it is possible, by choice of a suitable datum state, to assign to water in any state a definite heat content. By custom, liquid water has been assigned the value of zero heat content at 32° F.

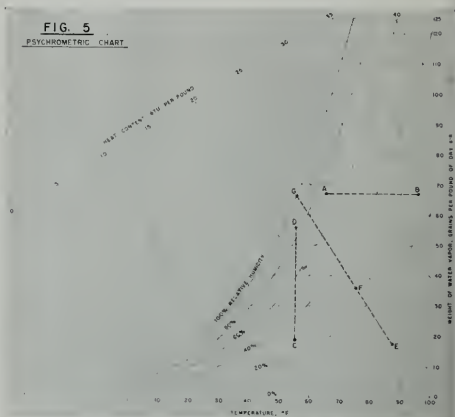

Just as the heat content of dry air depends on temperature, so also does the heat content of water vapor, and so also may it be represented on a chart similar to Fig. 2. However, it is more convenient to plot the combined heat content of mixtures of air and water vapor, taking account not only of various temperatures, but also of various amounts of water vapor which may be mixed with the air. This may be accomplished by combining Fig. 2 with Fig. 4, obtaining Fig. 5.

It will be noted that, at any fixed moisture content, changing an air-moisture mixture from a lower to a higher temperature will be accompanied by a change from a lower to a higher heat content. This may be graphically represented by going, say, along a line of constant moisture content from point A to point B on Fig. 5. Also, at any given temperature, changing from a lower moisture content to a higher moisture content will be

accompanied by a change from a lower to a higher heat content. This may be represented by going along a line of constant temperature from point C to point D. Fig. 5 shows all the heat-moisture-temperature relationships for air within the range for which it is drawn, and is known as a **psychrometric chart**. Published charts generally contain additional items of information which are shown for the convenience of the designer, but which have no bearing on the present discussion.

Examination of this chart makes readily understandable one very important property of moist air: there are an infinite number of moisture content-temperature conditions having the same heat content. Starting with an air-water mixture in any state, such as that represented by point E, it is possible simultaneously to lower the temperature (removing heat) and increase the moisture content (adding heat) in such relative proportions that the total heat content remains unchanged. In such a process the mixture passes from state E to state F and, if carried out sufficiently far, to state G, passing, meanwhile, through the infinite number of states intermediate between E and G that lie on a line of constant heat content. At state G (saturation) the process must terminate, since in this state

FIG. 6

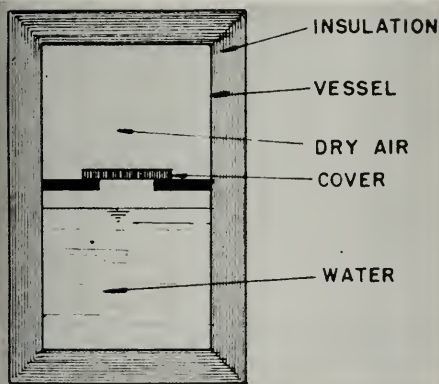

the air is mixed with the maximum amount of moisture that it can hold at this temperature and with more than it could hold at any lower temperature.

This process is sufficiently important to air conditioning to merit examination of the mechanism of its occurrence. In Fig. 6 is shown a vessel which contains a quantity of water in one chamber, a movable partition, and a quantity of dry air in the other chamber. All parts of the apparatus are at the same temperature, and the vessel is completely

FIG. 7

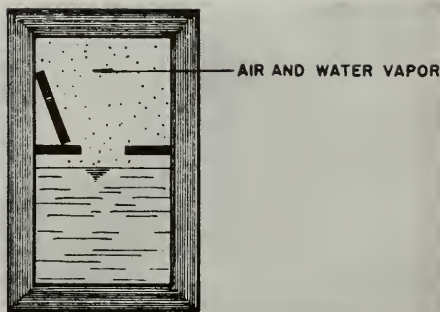

insulated, so that no heat can enter or escape from the system. If the partition is moved to allow contact between the air and water (Fig. 7), part of the water will vaporize into the air until the air is saturated. Heat is required to vaporize this quantity of water and, since no heat can pass through the insulation, the heat required must be supplied jointly by the air and the remaining, unvaporized water. In order to give up heat, these two materials must experience a fall in temperature. In short, in allowing water to vaporize into air, both the air and the water have been cooled.

If such a process is operated for the purpose of obtaining cool air, the equipment is known as an evaporative cooler. If the purpose is to obtain cool water, the apparatus is a cooling tower or other similar device. The use of cool air for human comfort is well-known; the use of the cooling tower principle—the practice of cooling a body by evaporating water from its surface, will be discussed later. One further point should be noted: In the experiment just described, had the air initially contained some moisture, the amount of water subsequently vaporized into it would have been less, and the amount of cooling of both air and residual liquid would have been less. Had the air been initially saturated, no further vaporization would have been possible, and therefore no cooling whatever would have been possible.

#### PHYSIOLOGICAL CONSIDERATIONS

The human organism can survive variation of its own temperature over a comparatively narrow range. Few clinical thermometers have a scale graduated below 90° F. or above 108° F.; many have much shorter scales. The body is, however, capable of withstanding much wider variation in the temperature of its environment, with the assistance of an involuntary regulatory system which it possesses. The range is further extended by voluntary variation of the amount of insulation with which it may be clothed.



accompanied by a change from a lower to a higher heat content. This may be represented by going along a line of constant temperature from point C to point D. Fig. 5 shows all the heat-moisture-temperature relationships for air within the range for which it is drawn, and is known as a **psychrometric chart**. Published charts generally contain additional items of information which are shown for the convenience of the designer, but which have no bearing on the present discussion.

Examination of this chart makes readily understandable one very important property of moist air: there are an infinite number of moisture content-temperature conditions having the same heat content. Starting with an air-water mixture in any state, such as that represented by point E, it is possible simultaneously to lower the temperature (removing heat) and increase the moisture content (adding heat) in such relative proportions that the total heat content remains unchanged. In such a process the mixture passes from state E to state F, and, if carried out sufficiently far, to state G, passing, meanwhile, through the infinite number of states intermediate between E and G that lie on the line of constant heat content. At state G (saturation) the process must terminate, since in this state

FIG. 6

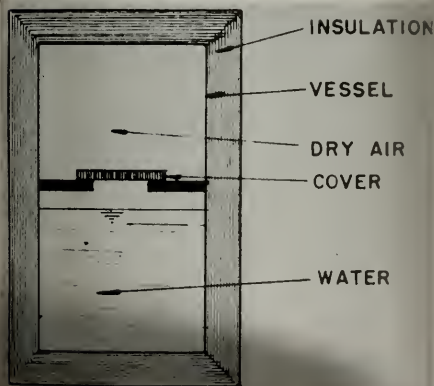

the air is mixed with the moisture that it can hold with more than its capacity at that temperature.

This process of conditioning to a desired state of its occurrence can be moved on to a higher level of conditioning by the use of a laboratory apparatus which is com-

paratus a  
l is com

## IN PROBLEMS

work is completed. The thick Method casts and then raises it. The few lifting removed on each eliminated. Use of



Scale model slab representing original model scientific conditions.



Laboratory studies enable construction of novel and economical designs by

## PHYSIOLOGICAL

The human body temperature range. Few studies

The chemical and physical processes associated with life liberate heat within the body, and the rate of heat liberation is dependent on the degree of activity of the body. In order that the body may remain at constant temperature in spite of internal heat gain, it is necessary that it lose heat to its environment and, further, that the rate of heat loss be in rather close balance with the rate of internal heat gain at any given moment. The involuntary regulatory system of the body controls body temperature by varying the rate of heat dissipation from the body to its environment in such a manner as to match the imposed rate of internal heat gain. Before examining the operation of this system, it may be noted that if the imposed load exceeds the ability of the body to lose heat, the load itself is reduced through a reduction in body activity. The result of such action, familiar to many people as sluggishness, becomes, in extreme cases, complete prostration, a state in which body activities not essential for survival are suspended.

Normally, however, the body is able to adjust its heat losses to the needs of the moment. This is accomplished chiefly by three separate mechanisms, all acting simultaneously. First, the body may emit heat to its surroundings by direct radiation, much as a lamp emits light. Although the energy radiated by the body is not visible, it is of the same nature as visible light, and is subject to the same laws. The most important single variable which influences this method of losing heat is the temperature difference between the body and its surroundings. The greater the amount by which the body temperature exceeds that of its surroundings, the greater is its ability to lose heat by radiation. If the surroundings are at body temperature, no heat is lost by radiation and, if the surroundings are warmer than the body, the body **gains** heat from the surroundings, thus increasing the load on other means of heat dissipation. Since the temperature of the human body varies only slightly, the rate of heat loss (or gain) by radiation is substantially controlled by the temperature of the surroundings.

Second, the body may lose heat by convection. If air whose temperature is lower than that of the body is brought in contact with the body, a thin layer of air will be warmed by direct contact. If the air is in motion, this warmed layer is continuously removed from contact, and is continuously replaced by a fresh supply of cooler air. If the rate of air flow is constant, the principal variable which affects the rate of heat transfer is, again, temperature difference. And since, again, the body temperature is nearly constant, heat transfer by convection is substantially controlled by surrounding air temperature. If the air is warmer than the body, the body is **heated** rather than cooled by convec-

tion, further adding to the cooling which must be accomplished by other means.

The third mechanism by which the body dissipates heat is by vaporization of water from its surface. It will be recalled from the discussion of the cooling tower principle that it is possible to remove heat from a body by allowing water to be evaporated from its surface. If this is performed without the addition of heat, the temperature of the body must fall. If heat is added, the temperature of the heat source (body) may fall a lesser amount, or it may remain constant, or it may rise, depending on the balance between heat supply and availability of water for vaporization and/or the ability of the atmosphere to receive the water vapor offered to it. In the case of the human body under favorable conditions, the amount of water made available for vaporization is just sufficient to maintain the body at a stable temperature condition.

This ability of the body to adjust the rate of evaporation of water from its surface is a very effective tool of the involuntary regulatory system, especially since evaporation is the **only means** available by which the body can reject heat to an environment **warmer than itself**. In attempting to assess the importance of this effect, it is worthwhile to review the results of measurements which have been made of the means by which the body loses heat under various conditions. Fig. 8 is based on test results published by the American Society of Heating and Ventilating Engineers (ASHVE), for persons seated at rest and dressed in customary indoor winter clothing. The upper curve shows the total bodily heat dissipation, the width of the upper band shows the heat loss by evaporation and the width of the lower band shows the heat loss by radiation and convection combined.

Fig. 8 strikingly shows the response of the organism to changing conditions. At 50° F. the heat loss by radiation and conduction is higher than the total loss at more moderate temperatures. To this is added the minimal evaporative loss, which further increases the total heat dissipation. Under these conditions, persons feel uncomfortably cold. As the temperature rises, radiant and convective losses decrease, and evaporation loss remains minimal, until the total loss approaches the neighborhood of 400 Btu per hour. At about 68° F., evaporation loss assumes control and through its own variation, holds the total heat loss substantially constant, despite the inexorable decrease in radiation and convection losses, until about 98° F. is reached. At this temperature, radiant and convective losses approach zero, and evaporation is carrying the entire load of heat dissipation. As the temperature rises beyond the point, radiation and convection **heat** the body instead of cooling it, but

(See Page 33)



New Mechanical Laboratory showing Research Engineer A. V. Engle using a testing device to determine the hardness of a machine part produced in the Southwest Research Institute's shops. At left is shown instrument used in conjunction with strain gages for measuring changes as small as .00002-inch and (right) is a machine which determines the resistance of various metals to compact loading.

# SOLVE CONSTRUCTION PROBLEMS BEFORE BUILDING — NOT AFTER

By **CHARLES E. BALLEISEN**, Supervisor

**Mechanical Laboratory, Southwest Research Institute  
San Antonio, Texas**

The birds and the bees are famous for their abilities as construction engineers. The infallibly perfect regularity of the honeycomb has been repeated endlessly since before the birth of mankind. So, the fabrication of birds' nests annually calls forth their ability to select, place, and arrange their building materials.

From these illustrations, we might draw the conclusions that building construction is an instinctive art and one that does not require careful technical analysis. Obviously, nothing is farther from the truth. These workers, building identical structures by instinct and habit, have not progressed one whit in all history.

Commercial building construction today requires careful and individual analysis of many items such as soils, foundation structures, construction materials, construction methods, power and service equipment, and hardware. Handbook and catalog data on these items rapidly become obsolete and must be checked and revised. The variation of requirements from one building to another makes it necessary to design each one separately in order to obtain maximum use of site and space, maximum convenience and utility, and maximum economy both of construction and of operation. Dwellings constructed in larger numbers at one site can repeatedly use a single plan.

## SOLVE CONSTRUCTION PROBLEMS . . .

When changes and individuality require as much expensive and skilled effort as they do in this field, it is natural to stick close to tried and accepted designs; to use them again and again; and to incorporate repeated groups, elements, or modules wherever possible.

In perhaps no other field of human endeavor are error and mediocrity more costly. A building is inherently a large, visible, and expensive structure. It is built for years of service and cannot be readily pulled down nor made over if it does not meet the specifications to which it was built.

With these problems and these penalties, it is not surprising that, as a whole, construction technology progresses slowly. Experimentation is a dangerous and expensive process and is not undertaken lightly. For some elements, it is possible to construct trial units and to evaluate them before incorporating them into the final structure. Because of their size, this is naturally an expensive operation, and all possible data should be obtained from such a model whenever possible.

Laboratory tests and the technics of modern science must be utilized to their fullest extent. These methods have for many years been applied to

materials. Composition, strength, and resistance to weathering and corrosive agents can be determined readily.

The study of soils has recently received extensive laboratory consideration. Careful work by such competent investigators as Casagrande, Puri, Taylor, and Terzaghi has revealed many new and interesting factors, but much work yet remains to be done in this field. The various minerals entering into the composition of soil, their distribution into particle sizes, and the presence or absence of vegetable matter or other intrusions make each foundation analysis problem an individual one. The basic universal building blocks on which a general solution to the problem can be laid have not yet been isolated.

Advance in construction technics is measured by the size of the steps which the designer can take with confidence. Small steps, involving little advance over existing practices, can be made frequently and with little risk. Large steps require deep intuition, thoro knowledge of theory, or must be justified by experiment if they are to be undertaken without excessive risk.

Laboratory experiments, either of full scale ele-



Synthetic, scaled loading of model building units produces stresses corresponding to selected environmental conditions.



ments or of small scale models, are used frequently. The variety of tests of this type which are available precludes more than a brief notice of any one of them here. Analog models, leading to solution of the mathematical analyses of stress and strain, or scale models, based on actual construction elements, may be used. Altho scale models of wood, steel, and similar structures have been used in the past, only recently have small scale models of reinforced concrete been developed. These latter are particularly useful in that they permit study of a complete structure and can be readily handled in a laboratory without requiring large equipment.

Construction methods themselves can be improved by laboratory evaluation. Indeed, the pioneer of time and labor-saving methods, Frank Gilbreth, was originally trained as a bricklayer and made some of his most important observations in that field. The building industry is presently handicapped by the excessive use of hand methods and small units. Studies of methods, costs, skills, and energy requirements often succeed in obtaining greater efficiency. Typical of these is an analysis made of concrete slab construction. When these elements are used for upper floors and roofs, it is necessary to place timber supports and forms for the concrete at each level. This forest of timbers

must also be removed after the work is completed. The recently-developed Youtz-Slick Method casts each slab on the ground level and then raises it vertically to its final position. Only the few lifting elements must be installed and removed on each job. Forms are almost entirely eliminated. Use of

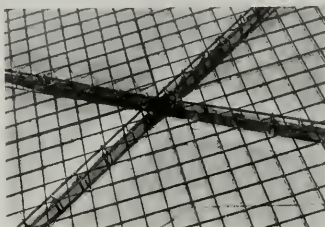

Reinforcing steel for one-twelfth scale model of reinforced concrete building slab reproduces all the intricacy of the original. Model was constructed under rigid scientific conditions in RSI laboratories.

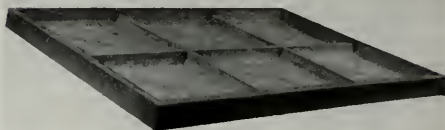

Lower surface of one-twelfth scale reference floor slab and integral strengthening beams.

(See Page 34)

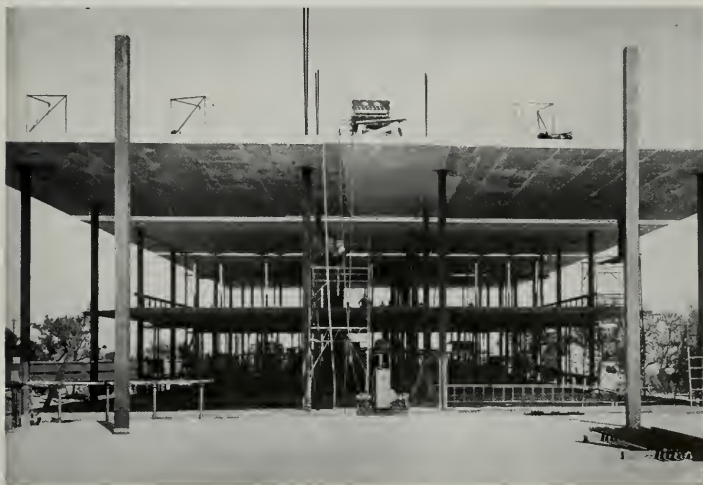

Laboratory studies enable construction of novel and economical buildings by the Liff Slab building method developed with the assistance of SRI Engineering Mechanics Department.



View of the New Library as seen from Lake Merritt.

RECENTLY COMPLETED  
PUBLIC LIBRARY

OAKLAND, CALIFORNIA

CHESTER H. MILLER and CARL I. WARNECKE  
Architects

STOLTE, INC. — General Contractor

Another unit of the City of Oakland's "planned for the future, as well as the present" governmental buildings has been completed with the recent acceptance by City officials of the new Main Library Building, which was planned and designed by the firm of Miller and Warnecke, A.I.A., Architects, and constructed with funds derived from a Library Bond Issue voted upon and approved by the people of Oakland in 1945.

Some time elapsed between approval of the Bond Issue and actual construction, however, with the awarding of a contract to Stolte, Inc., Oakland general contractor on November 17, 1948, ground was immediately broken in a public ceremony and work progressed according to the two-year time limit allotted for actual construction.

The total cost of the library building, including the newest of modern furniture, furnishings, and equipment amounted to \$1,500,000, which costs were within the initial budget estimate established by the Architects at the time the Bond Issue was

considered, and this in spite of the fact that the period of time between approval of the Bond Issue and completion of the building represented an era of considerable price variations in the construction industry. Through cooperation of the Architect and the general contractor, economies were effected in a number of instances to compensate for increases in labor and material costs.

The new Library Building is located on the "key" block of Oakland's new Civic Center, which is bounded by 13th, 14th, Oak and Madison streets in downtown Oakland and near Lake Merritt. The Main Entrance is from 14th street and faces towards the North.

The building is of simple but impressive, contemporary, modern design, three-stories in height and of steel and reinforced concrete construction and fire resistant. Design of the structure is such that an entire additional floor can be added at any time in the future that more space may be needed, thus providing for future growth and expansion of

**MAIN ENTRANCE**

Entrance to the main library portion of the building is on the 14th Street side and faces North.

Simplicity in design is maintained throughout the entire structure.

*Photos by  
Rondel Partridge*



## PUBLIC LIBRARY . . .

the facilities of the Library to meet population growth of the City.

The first, or ground floor, houses the Children's Reading Room and junior department with separate outside entrances on the east or Oak street frontage. Access to a large meeting or assembly room which may be used for special events or community purposes, is gained through a sunken garden court on the West or Madison street frontage.

The balance of the main ground floor is occupied by the usual Library Departments such as the Branch, Order, Catalog, Maintenance and repair, shipping and receiving departments, garage for library automobiles, a spacious driveway which leads from the rear or 13th street frontage to the service entrance. All other space on this floor is devoted to steel stack book storage units.

The second, or main floor, is approached by means of wide entrance stairs and garden terraces and the main front entrance leads directly into the central hall and vestibule where are located the

receiving and charging counters and the catalog files of the library service to the public.

The large, spacious, well lighted Adult Reading and Reference Rooms which among the most frequently used by the public, are located on this main floor and are immediately available from the Central Hall.

The books and reading areas are divided into a departmentalized library for convenience of the users and for simplicity in library function, and include such works on "Science and Industry", "Sociology", "Religion and Philosophy", "History, Travel and Biography"; in addition provision has been made for a large space to be devoted to a General Reference Room, another area has been planned to accommodate a wide variety of Maps, and special facilities have been made available for a California Room which contains material pertaining to the State of California.

The third floor has been designed by the architects to serve as the Art and Picture Department; the Music Department; the Newspaper and peri-

Portion of the Main Floor area . . . showing the Central Hall arrangement.





odical Room; the Teen-age Room; and here also is located the various Main Library Administrative and Business Offices.

The exterior and interior of the new Library Building are modern in all respects. Rooms and book storage areas are illuminated with fluorescent electric fixtures; the building is completely steam heated and air conditioned to provide proper temperatures indoors irrespective of what outside weather conditions might be; and general use of a policy of simple and straight forward design, color and decorations has been used throughout. Two fully automatic, electric, self-leveling passenger elevators serve the building. One of these is located in the Central Hall entrance and serves the public, and the other elevator is located in the closed stacks to serve Library em-

ployees and may be used for a number of other utility purposes. Provision has also been made for two fully automatic electric book lifts in the closed stack areas which serve to simplify the handling of books and material from one floor to another.

Light gray steel and light blonde oak wood furniture, with easy chairs and bright colored upholstery, has been provided by the Library Board.

The new Library Building has more than three times more square foot floor space than was contained in the old building which was built in 1902 as a gift from the Carnegie Corporation, and will be used in the future as a West Oakland Branch Library.

**READING  
ROOM**

**Designed for  
convenience of  
public's use and for  
minimum of  
maintenance by  
library personnel.**





THE  
AHWAHNEE

Convention  
Headquarters

# Annual Structural Engineers YOSEMITE PARK



ARTHUR W. ANDERSON  
President SEAC

## TECHNICAL PROGRAM

Thursday, 2:30-4:30 P.M., October 11

- (a) Report on Test Program on Diagonally Sheathed Wood Diaphragms.  
George H. Atherton, Mechanical Engineer, Oregon Forest Products  
Laboratory
- (b) Report on Test Program on Plywood Sheathed Diaphragms.  
David Countryman, Civil Engineer, Douglas Fir Plywood Association
- (c) Discussion of Current Status of Wood Diaphragms Design.  
Research Committees

Great  
Lounge



# Convention Association of California

OCTOBER 11-12-13, 1951

**Friday, 10:30-12:00 A.M., October 12**

- (a) Advances in the Art of Making Concrete  
Prof. R. E. Davis, University of California
- (b) Observations on Structural Engineering in Europe  
John J. Gould, Consulting Engineer, San Francisco

**Friday, 2:30-4:30 P.M., October 12**

- (a) Report on Steel Research Program  
Column Research Council of the Engineering Foundation
- (b) Structural Welding  
Thos. H. Nicoll, Welding Engineer,  
The Lincoln Electric Company
- (c) Design and Construction of the University of  
Washington Stadium  
Elmer Gunnette, District Engineer, Seattle  
American Institute of Steel Construction

**Saturday, 9-10 A.M., October 13**

- (a) BUSINESS MEETING, with report of President;  
Committee Reports
- (b) TRIP to O'Shaughnessy Dam, leaves at 10:30 a.m.  
Box lunch served

**Saturday, 7:45 P.M.**

- (a) ANNUAL BANQUET AND DINNER DANCE

**SOCIAL PROGRAM**

The program includes: Cocktail parties—movies—bridge—canasta—pitch and putt for the ladies—square dancing and just dancing—a golf tournament—a trip to O'Shaughnessy Dam. Always available: Valley trips—horseback riding—hiking—tennis—a visit to the museum.

**CLOTHES**

Sport clothes are in order. For the men it is informal dress at all times. Frontier dress is in order for the square dancing. For the ladies: Informal afternoon dresses for bridge, etc.; evening, dinner, or afternoon dresses for the banquet Saturday night. Your wardrobe should anticipate pleasantly mild fall weather with evenings usually cool.

**TRANSPORTATION**

The best way to go to Yosemite is by automobile. It is possible to go by a Southern Pacific train to Merced and bus into the Valley. The schedule will be furnished upon request. The Merced to Yosemite road will be under control. The Big Oak Flat road and the road from Fresno will not be impaired.

# American Institute



# of Architects

Glenn Stanton, President  
Kenneth E. Wischmeyer, 1st Vice-president  
Norman J. Schlossman, 2nd Vice-president  
Clair W. Ditchy, Secretary  
Maurice J. Sullivan, Treasurer

National Headquarters —  
1741 New York Avenue, N. W.  
Washington 6, D. C.  
Edmund R. Purves  
Executive Secretary

#### Arizona Chapter:

Edward L. Vorney, President; Ralph B. Hover, Secretary,  
P. O. Box 786, Phoenix, Arizona.

#### Central Valley of California:

William Koblik, President; Gordon Stafford, Vice-President;  
John W. Bomberger, Secretary; Albert B. Thomas, Treasurer,  
Secretary's Offices P. O. Box 1943, Modesto.

#### Coast Valleys Chapter:

William F. Hempel, President; Lawrence Gentry, Vice-  
President; Walter Stromquist, Secretary-Treasurer. Secre-  
tary's office, 321 Channing Ave., Palo Alto.

#### Colorado Chapter:

Paul Atchison, President; James M. Hunter, Vice-President;  
Dudley T. Smith, Secretary; Victor Hornbein, Treasurer.  
Offices 1254 Monaco Parkway, Denver.

#### Northern California Chapter:

Francis J. McCarthy, President; Albert R. Williams, Vice-  
President; Wendell R. Spackman, Secretary; Helen D.  
French, Treasurer. Offices 369 Pine Street, San Francisco.

#### Oregon Chapter:

Herman Brookman, President; Donald J. Stewart, Vice-  
President; Raymond Kermit Thompson, Secretary; Millard  
H. Schmeier, Jr., Treasurer. Secretary's office 429 S. W. 4th  
Avenue, Portland.

#### Pasadena Chapter (California):

Calver Heaton, President; Don Neptune, Vice President;  
Arthur Frick, Treasurer; (Mrs.) Dorothy Gray, Secretary.  
Directors, John N. Douglas, Boyd Georgi, Roland E. Coote  
and Burton Romberger. Office 1041 East Green St., Pasade-  
na.

## WALTER D. BLISS, ARCHITECT RETIRES FROM PRACTICE

After fifty years of practice Walter D. Bliss, San Francisco architect, has announced his retirement. The original firm of Bliss and Faville executed many of San Francisco's outstanding buildings including the St. Francis Hotel, Southern Pacific Building, Matson Building and the State Building. Since 1948 the firm has been known as Bliss & Hurt, Trudell & Berger.

With the retirement of Walter D. Bliss, the firm has been reorganized and will continue practice as architects and engineers under the new firm name of Hurt, Trudell & Berger. Offices of the firm will be maintained at 883 Mission Street, San Francisco.

## NORTHWEST REGIONAL A.I.A. MEETING IN OREGON

A Regional Meeting of the A.I.A. has been set for three days starting on September 30th at Columbia Gorge, Oregon, sponsored by the Institute members with the Board of Directors as honored guests.

Advance indications point to a well attended conference.

## PRODUCERS COUNCIL SOUTHERN CALIFORNIA CHAPTER

The Annual A.I.A.-Producers' Council Outing and Picnic was held at the Oakmont Country Club in Glendale on September 11. Following the annual ball game, was a cocktail party and the annual dinner which was highlighted by entertainment of a number of television stars. Jack Warnock, American Radiator Company, served as Chairman of the committee.

The California Council of Architects Convention will be on October 4, 5 and 6 at the Hotel Del Coronado, Coronado, California. Walter Stayer is chairman of the committee in charge of the entertainment. An active program has been arranged. Sports include golf, swimming, sailing, tennis, cards and special events. The Sportsman's Dinner again will be a high-light of the convention. Other parties and dances have been arranged. Top-flight speakers will be presented for the business sessions of the convention. Entertainment will be sponsored by the Producers' Council.

Remember it's

**KRAFTILE**

for **GLAZED STRUCTURAL WALL UNITS**

**PATIO TILE**

**SWIMMING POOL OVERFLOW**

**GUTTER**

**QUARRY TILE**

**FACE AND ROMAN BRICK**

**ACID BRICK**

**BRICKETTES**

**MINWAX TILE & CONCRETE**

**FLOOR FINISH**

**STRAN-STEEL FRAMING**

**QUONSET BUILDINGS**

**IN STANDARD SIZES**

For complete information and prompt service, phone or write

**KRAFTILE COMPANY**

NILES, CALIFORNIA

NILES 3611

SAN FRANCISCO 5: 50 Hawthorne St.—DOUGLAS 2-3780

LOS ANGELES 13: 406 South Main Street—MUTUAL 7241



**Envi Bay Chapter:**

Harry A. Bruno, President; Chester H. Treichel, Vice-President; Ira D. Beals, Secretary; Cecil S. Moyer, Treasurer. Secretary's office, 1444 Webster St., Oakland.

**Montana Chapter:**

E. Edward Sowcroft, President (Billings); J. Van Teylingen, Vice-President (Great Falls); H. C. Cheever, Secretary-Treasurer, Secretary office, Bozeman.

**Nevada Chapter:**

George L. F. O'Brien, President; Aloysius McDonald, Vice-President; Graham Erskine, Secretary; Edward S. Parsons, Treasurer, Offices 160 Chestnut St., Reno.

**Nevada State Board of Architects:**

L. A. Ferris, President, Reno; Walter Zick, Secretary, Las Vegas; Directors, Aloysius MacDonald, Las Vegas; Russell Mills and Edward Parsons, Reno, Office, P. O. Box 2107, Las Vegas, Nevada.

**Pasadena Chapter:**

Culver Heaton, President; Don Neptune, Vice-President; Arthur Frick, Treasurer; Mrs. Dorothy Gray, Secretary. Directors John N. Douglas, Boyd Georgi, Roland E. Coate, and Burton Romberger. Offices 1041 E. Green St., Pasadena 1.

**San Diego Chapter:**

Jack R. Lewis, President; Louis A. Dean, Vice-President; Donald Campbell, Secretary; Victor L. Wulff, Jr., Treasurer. Directors C. J. Paderewski, G. C. Hatch. Secretary office, 1250 Prospect St., La Jolla.

**San Joaquin Chapter: (California)**

Fred L. Swartz, President, Fresno; Lloyd J. Fletcher, Vice President, Visalia; Walter Wagner, Secretary, Fresno; Robert W. Stevens, Treasurer, Fresno. Directors: Alanstain Simpson, William D. Coats, William F. Baxter, Maurice J. Metz, Delegate California Council of Architects, Office, Sec. Fulton-Fresno Bldg.

**Santa Barbara Chapter (California):**

Robert I. Hoyt, President; Harold E. Burket, Vice-President; Roy W. Chessman, Secretary; Lutah M. Riggs, Treasurer. Address, 242 San Marcos Bldg.

**Southern California Chapter:**

John J. London, President; Chos. Frey, Vice-President; C.

Day Woodford, Secretary; Wm. G. Balch, Treasurer. Directors, Paul O. Davis, Henry Wright, John Rex, and Kemper Nomland. Ex. Sec. Rita E. Miller. Chapter Headquarters, 3723 Wilshire Blvd., Los Angeles 5.

**Spokane Chapter:**

Richard H. Eddy, President; Harry C. Weller, Vice-President 1; Kenneth D. Stormet, Vice-President 2; Victor L. Wulff, Secretary, and Carl Johnson, Treasurer. Office 1023 W. Riverside Ave., Spokane, Washington.

**Utah Chapter:**

Howell O. Cannon, President; William J. Monroe, Jr., Secretary, 2107 South 32nd West Street, Salt Lake City 7, Utah. Chairman on State Chapter:

Paul Thiry, President; John S. Dettle, 1st Vice President; Walter H. Rothe, 2nd Vice President; Robert H. Dietz, Secretary; Lawrence G. Waldron, Treasurer, Office 714 American Building, Seattle 4.

**Tacoma Society:**

E. W. Duggan, President; P. G. Ball, Vice-President; Lyle Swedberg, Secretary-Treasurer.

**Hawaii Chapter:**

James C. Simms, President; Alfred Priel, Secretary, 1507 Kapiolani Blvd., Honolulu, T. H.

**CALIFORNIA COUNCIL OF ARCHITECTS**

John L. Rex, President; Wm. Koblik, Vice-President; Maurice J. Metz, Secretary-Treasurer. Executive Secretary office 3723 Wilshire Blvd., Los Angeles.

**ALLIED ARCHITECTURAL ORGANIZATIONS**

San Francisco Architectural Club: Alfred T. Kakevid, President; Charles Dennis, Vice President; William C. Thieleman, Treasurer; Milton Bromberg, Secretary, Office 507 Howard Street.

**Producers' Council—Southern California Chapter:**

Harold F. Smith, President, Gladding, McBean & Co.; Bert Taylor, Vice-Pres., Pittsburgh Plate Glass Co.; Richard Seaman, Sec., W. P. Fuller Co.; Clay Sander, Treas., Minneapolis-Honeywell.

Producers' Council—Northern California Chapter (See Special Page)

Malcolm Lowe, Chairman of the Joint A.I.A.-Producers' Council Information Committee states that the Producers' Council will again sponsor a series of lectures to the architectural students of U. S. C. and Cal. Poly. The lectures, to be given by members of the Producers' Council, will follow the actual construction of to the completed job.

## CALIFORNIA COUNCIL OF ARCHITECTS

The Annual Convention of the California Council of Architects will be held at the Hotel Del Coronado in Coronado on October 4, 5 and 6, with a full schedule of technical discussions devoted to the subject of architecture and allied activities.



**JOHN REX**  
President

John Rex, President of the Council, reports a number of outstanding speakers will appear on the business program, and that advance registrations at the Hotel indicate the attendance will

be well above the average.

Walter Steyer, Chairman of the Entertainment Committee has arranged an active program of sports, including golf, swimming, sailing, tennis, cards, and dancing to occupy the attention of delegates while not attending the technical sessions.

Steyer indicates a number of "surprises" are in store for the architects this year, with special events of entertainment being sponsored by the Producers' Council.

## WASHINGTON STATE CHAPTER

Fall meetings were resumed on September 6th, with the Executive Board, Ways & Means Committee and the Program Committee reporting on a number of important summertime activities and coming events.

Reports were made on current policies of state officials and governmental bodies in relation to architectural fees on state work wherein to date the matter has been arbitrarily viewed in terms unsatisfactory to the architectural profession.

New Members: James C. Gardiner, Lloyd J. Lovegren, Francis H. G. Fassett, and Harry D. Gohnour have been elected Corporate Members.

The Architects Bowling League began its fifth season on September 5th with twelve teams expected to participate in the games which are held weekly during the winter season. The A.I.A. is also sponsoring a team in the Seattle Construction Council League.

## CALIFORNIA STATE HIGHWAY FIELD JOBS ARE AVAILABLE

The California State Personnel Board is seeking qualified Highway Field Office Assistants to fill positions in the Division of Highways field offices.

Applicants must have two years of experience in timekeeping, cost or financial record keeping in connection with maintenance or construction operations.

# WITH THE ENGINEERS

## Structural Engineers Association of California

Arthur W. Anderson, President; Harold P. King, Vice-President; Henry J. Degenkolb, Sec.-Treas.; Office of Sec., 405 Montgomery St., Room 1121, San Francisco.

## Structural Engineers Association of Northern California

John E. Rinne, President; John J. Gauld, Vice-President; Wm. W. Brewer, Sec.; Franklin P. Ulrich, Treas.; Directors, Walter L. Dickey, Leslie W. Graham, Hyman Rosenthal, and Howard A. Schirmer.

## Structural Engineers Association of Central California

William H. Petersen, President; Walter S. Wassum, Vice President; O. T. Illerich, Sec. Treas.; Ernest D. Francis, M. A. Ewing, and Arthur A. Sauer, directors. Office O. T. Illerich, c/o Div. of Arch., Sacramento.

## American Society of C. E.

### San Francisco Section

Clement T. Wiszkocil, President; John S. Langwell, Vice-president; J. G. Wright, Vice-president; H. C. Medbery, Treasurer; R. D. Dewell, Secretary. Secretary's Office, 604 Mission St., San Francisco.

## Structural Engineers Association of Southern California

Donald F. Shugart, President; Harold P. King, Vice President; Robert J. Short, sec-Treas.; Directors, William T. Wheeler, William T. Wright, Ernest C. Hillman, Jr., John Cose, and John K. Minasian. Office, 202 Architects Bldg., Los Angeles 13.

## Structural Engineers Association of Oregon

R. Evan Kennedy, President; Guy H. Taylor, Vice President; James R. Griffith, Secretary-Treasurer; Directors Jerome A. McDevitt, H. Loren Thompson, and Robert L. Tidball. Offices, Portland.

## Puget Sound Engineering Council (Washington)

R. E. Kister, A. I. E. E., Chairman; E. R. McMillan, A. S. C. E., Vice Chairman; L. B. Cooper, A. S. M. E., Secretary; A. E. Nickerson, I. E. S., Treasurer. Offices, L. B. Cooper, c/o University of Washington, Seattle 5, Washington.

## American Society Testing Materials

### Northern California District

L. A. O'Leary, Chairman; P. V. Garin, Vice-chairman; H. P. Hoopes, Sec. Office Sec., 1550 Powell St., Emeryville, Calif.

## Society of American Military

### Engineers—San Francisco Post

Capt. Cushing Phillips, CEC, USN, President; Col. W. C. Baker, Jr., CE, USA, Vice President; Robert P. Cook, Secretary; Levant Brown, Treasurer. Directors: Rear Admiral L. N. Moeller, CEC, USN; Capt. H. F. Ramstord, CEC, USN; Clyde Bently; Prof. Harmer E. Davis, Lieut. Col. James D. Strong, CE, USA; and Lieut. Col. Henry M. Smalley, CE, USA.

## STRUCTURAL ENGINEERS ASSOCIATION NORTHERN CALIFORNIA

The September meeting, held in the Hotel Leamington, Oakland, was devoted to a discussion of

"Trends in Highway Transport" with Harmer E. Davis, Director of the Institute of Transportation and Traffic Engineering at the University of California, principal speaker.

Davis discussed highway design and financing, the adequacy of present highways, and probable future designs.

George J. Kerekes has been appointed by A.C.I. to the A.C.I. Technical Committee 314 for "investigation of Rigid Frame Bridges." His term will expire in 1953.

New members: Jack S. Nolan, Benjamin S. Persons, Junior Member; and Percy West, Affiliate.

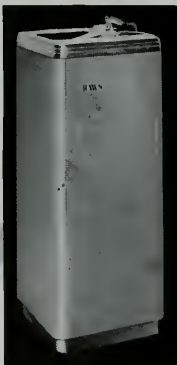

Always  
Specify  
**HAWS**  
for Highest  
Quality

- Sanitary Drinking Fountains • Electric Water Coolers • Drinking Faucets, Equipment, Filters and Accessories.

A reputation for reliability since 1909. Check in Sweet's or write for complete HAWS catalog.

**HAWS DRINKING FAUCET CO.**  
1441 FOURTH STREET (Since 1909) BERKELEY 10, CALIFORNIA  
Agents and Sales Representatives in All Principal Cities

## STRUCTURAL ENGINEERS ASSOCIATION SOUTHERN CALIFORNIA

The regular monthly meeting of the Structural Engineers Association of Southern California was held on September 5 at the Alexandria Hotel in Los Angeles. The program for the evening consisted of the showing of two very interesting sound films.

The first film was shown by Frank Davies of the Raymond Concrete Pile Company. The picture gave a very complete description of the placing of cast-in-place concrete piles and the different types of these piles that are in use today. It also showed the many structures throughout the United States that have been constructed on cast-in-place piles. At the completion of the film, Davies was available to answer the questions that were asked by the membership.

The second film was on the highlights of the football games that were played during 1950 by the Los Angeles Rams. This film proved to be very interesting.

Three new members were introduced during the business portion of the meeting. Alfred Scheiner, Associate member; Norman Pederson, Associate member; and James Ruthroff, Junior member.

At the close of the meeting president Donald Shugart reminded everyone to try to attend the annual Structural Engineers Association convention to be held this year at Yosemite on October 11, 12 and 13.

#### CONVENTION COMMITTEE OF THE STRUCTURAL ENGINEERS ASSOCIATION OF CALIFORNIA PLAN YOSEMITE MEETING



Henry J. Degenkolb, secretary-treasurer (left to right) of the SEAC; C. R. Graff, Convention Chairman; Jesse Rosenwald, State Director SEAC for Northern California; and Arthur W. Anderson, President of the State Structural Engineers Association of California, plan details of the annual SEAC Convention which will be held in Yosemite Park on October 11-12-13.

#### SOCIETY OF AMERICAN MILITARY ENGINEERS — San Francisco Post

The regular September meeting was held in the Officers Club at the Presidio of San Francisco, with Rear Admiral J. F. Jelley, Jr. (CE) USN, the principal speaker.

The October meeting, scheduled for the Officers Club, will hear Norman C. Raab outline the results of studies and plans for a bridge to span San Francisco Bay at Richmond-San Rafael.

Raab is serving as project design engineer for the Division of San Francisco Bay Toll Crossings in connection with studies and plans for the Richmond-San Rafael bridge. He previously was engaged in the studies made for the parallel bridge, the southern crossing, and alterations to the present San Francisco-Oakland Bay bridge to increase

its traffic carrying capacity. His previous work has involved other studies for the Division of Highways as well as supervision of the preparation of contract drawings for the Bridge Department of that body. Since 1942 he has served on the National Advisory Committee on Long Span Suspension Bridges sponsored by the U. S. Bureau of Public Roads, and originally established to investigate the Tacoma Narrows bridge failure. His technical activities also include membership on the Advisory Committee on Bridge Testing Program, Institute of Transportation and Traffic Engineering, University of California studying loading effects on actual bridge structures and the Joint Committee on the Design of Highway Bridges, as a representative of this Society. This latter committee is making investigations with particular emphasis on live loadings for long span structures.

The above subject is particularly appropriate at this time because funds have now been appropriated for the contract plans, specifications and financing of the structure.

#### FEMINEERS

The September meeting was held September 19 in the Elks Club, San Francisco, with a lecture and demonstration on plastics being given by Theo.

(See Page 31)



Always  
Specify  
***HAWS***  
for Highest Quality

A complete line of fountains, electric water coolers, faucets, filters and accessories. • Individual or multiple installations. • A reputation for reliability since 1909. • Check in Sweet's or write for complete HAWS catalog.

**HAWS DRINKING FAUCET CO.**  
1441 FOURTH STREET (Since 1909) BERKELEY 10, CALIFORNIA  
Agents and Sales Representatives in All Principal Cities

# PRODUCER'S COUNCIL PAGE

The National Organization of Manufacturers of Quality Building Materials and Equipment  
affiliated with THE AMERICAN INSTITUTE OF ARCHITECTS

President, Arthur C. Staat  
Natural Gas Equipment, Inc.  
1150 Folsom Street

Vice-President, Fred A. Fignone  
Otis Elevator Company  
1 Beech Street

Secretary, Howard Nelsen  
E. F. Houseman Company  
500 Second Street

Treasurer, A. L. West, Jr.  
Aluminum Company of America  
Russ Bldg.

Edited by Carl B. Frank, DETROIT STEEL PRODUCTS CO.

## PROPOSED CHANGE IN CHAPTER FISCAL YEAR

For some time now there has been quite a bit of discussion concerning the dates of our chapter fiscal year in that our year has started on January 1st with the election of the new officers, and this, of course, conflicts with both our own national and the A.I.A. schedules. The schedule did, however, correspond with that of the Northern California Chapter of the American Institute of Architects until the last year when the Northern California Chapter changed their fiscal year to match the National A.I.A. schedules which is from July 1st to June 30th. As a result of their change, we have an overlapping of executives in all our joint activities such as the Joint Information Committee. This actually would mean that our newly elected officers and committeemen would work with the A.I.A. committeemen for only 6 months and then have to start with their new men. As a result our work is slowed up for at least a month during the transition period.

To take care of the required change, we now have a ballot before the entire membership on this matter, and we are in hopes that we will be able to announce the results at the September 26th National Presidents' Meeting in Washington, D. C. We feel sure that the ballot will carry, in view of the conflicting terms of office now existing between the A.I.A., our chapter, and the national chapters of both the A.I.A. and the Producer's Council.

## CHAPTER MEETING

Our September meeting was conducted jointly by the W. P. Fuller Company and the Pittsburg Plate Glass Company, in which a technicolor motion picture covering the process from raw materials to finished product of plate and window glass was shown.

Nick Zavalishin also presented new ideas in paint, and Mr. A. B. Oswald presented some of

the new trends in wall paper and floor coverings.

Our October meeting, which will be held on the 15th so as not to conflict with the California Council of Architect's Convention will be conducted jointly by the Wakefield Brass Company and the P. G. & E. Company. The general theme of that meeting will have to deal with lighting and will be conducted by Mr. Ted Bateman of the Wakefield Brass Company.

## NATIONAL PRESIDENTS' MEETING

As mentioned previously, the National Presidents' Meeting for chapter presidents will be held on September 26, 27 and 28 in Washington, D. C., and, of course, we will be represented at that meeting by our President Art Staat of Natural Gas and Equipment Company. Art is leaving on September 10th so as to combine his vacation along with the Presidents' Meeting. We also understand that Art will pick up a new car on his way East, so, all in all, it should be quite a trip for our boy.

## DON LYON LEAVES LOCAL CHAPTER

We wish to take this opportunity to extend our congratulations to Don Lyon who has recently been promoted by the Libbey-Owen-Ford Glass Company. Don is taking over the National Sales Manager's job for their textile division of the Fiberglass portion of their business. We are given to understand that this is a new division and will offer a complete line of new products to the industry. To quote Don, "The products are so new that he will attend a series of sales meetings throughout the East and then return to his new headquarters in Toledo, Ohio, to find out just what he has to sell."

We are sure of one thing and that is that this is a bit of exaggeration on Don's part. However, it must be a complete line of **new** products.

Don has been very active in the affairs of the Council, and we will certainly miss his help in our future activities.



USE QUALITY PRODUCTS

CONSULT AN ARCHITECT



## ARTHUR C. STAAT ATTENDS PRODUCERS COUNCIL CONFAB

Arthur C. Staat, President of the Northern California Chapter of the Producers' Council, Inc., will be among the West Coast members of the organization attending the National President's Meeting in Washington, D. C., on September 26, 27 and 28.



ARTHUR C. STAAT  
San Francisco

Staat has been very active in the Pacific Coast activities of the Producers' Council, national organization of the manufacturers of building materials, and will take a number of important subjects East for consideration of the national group.

It is understood Staat will combine the trip with pleasure and will make the return by automobile, picking up a new car at the factory.

## ANNUAL APPRENTICESHIP GRADUATION EXERCISES

Annual apprenticeship graduation exercises were observed in the San Francisco Civic Auditorium on September 20th with J. L. Hogg, chairman of the sponsoring San Francisco Labor-Management Apprenticeship Committee serving as chairman of the event.

More than 5000 apprentices were formally joined with the ranks of various skilled tradesmen by the exercises.

## WITH THE ENGINEERS

(From Page 29)

V. Malanni, co-owner and director of the San Francisco Plastics Company.

The fall Fiesta was held the latter part of September in the Mill Valley Golf Club with a full evening of entertainment being devoted to community singing directed by Mrs. Byron Nishkian; showing of Coronado Convention slides by Henry J. Degenkolb, and dancing.

## ILLUMINATING ENGINEERS SELECT NEW OFFICERS

The Illuminating Engineers Society, with headquarters in New York City, have announced the election of new officers to serve during the ensuing year.

Elected to the Presidency is Samuel G. Hibben, Westinghouse Electric Corp., and a Fellow of the Illuminating Engineering Society; A. H. Manwar-

ing of the Philadelphia Electrical & Mfg. Co., vice-president; Treasurer, R. F. Hartenstein of the Ohio Edison Co.; and C. C. Keller of the Holophane Co., New York, general secretary.

Directors include G. W. Beals, The Miller Co., Meriden, Conn., and J. S. Schuchert, Duquesne Light Company, Pittsburgh, Pa.

The Illuminating Engineering Society is a nationwide technical organization founded in 1906 for the advancement and dissemination of knowledge in the lighting field. Membership comprises 7500 illuminating engineers and lighting specialists.

## PRECAST STRUCTURAL (TILT-UP) CONCRETE

A course in "Tilt-up" concrete construction is being presented at the University of San Francisco, starting October 2.

The course will include flat casting, site fabrication, motor crane erection and joinery.

## NAMED IDAHO HIGHWAY ENGINEER

Earle V. Miller, formerly of the Arizona State Highway Department, has been named the new State Highway Engineer for Idaho.

**HOLLYWOOD JUNIOR**  
COMBINATION  
SCREEN and METAL SASH DOOR  
★  
The "WEATHER-WISE"  
DOOR!!

**A VENTILATING SCREEN DOOR  
A SASH DOOR  
A PERMANENT OUTSIDE DOOR  
ALL 3 IN 1!**

Discriminating home owners and architects have chosen Hollywood Junior as the TRIPLE DOOR VALUE in the COMBINATION SCREEN and METAL SASH DOOR field! A sturdy dependable door, constructed of quality materials, HOLLYWOOD JUNIOR'S EXCLUSIVE PATENTED FEATURES have outmoded old-fashioned screen doors and other doors of its type entirely! . . . . .

**IT GUARANTEES YOU YEAR 'ROUND COMFORT, CONVENIENCE and ECONOMY**

WE ALSO MANUFACTURE A COMPLETE LINE OF  
SHUTTERS, C. C. DOORS, SCREENS, SCREEN DOORS, LOUVER DOORS

**WEST COAST SCREEN CO.**  
1145 EAST 42ND STREET ★ L.S. ANGELES, CALIFORNIA  
A-1485-1118

★ ★ ★ WRITE FOR FREE ILLUSTRATED LITERATURE ★ ★ ★

## NEWS AND COMMENT ON ART

(From Page 10)

Lectures will feature "Modern Sculpture" by Barbara Fitzwilliams; "What Americans Are Collecting" by Anneliese Hoyer; "Advancing French Art" by Barbara Fitzwilliams; "Educational Toys" by Anneliese Hoyer; and "Bay Region Artists" by Allon Schoener. Gallery tours will be conducted each Sunday at 2:30 p.m., and the Children's Art Classes will be resumed on Saturday mornings beginning September 15 h.

### CITY OF PARIS

The Rotunda Art Gallery of the City of Paris, San Francisco, under the direction of Beatrice Judd Ryan, will present a group of Paintings by the Santa Fe, New Mexico, Women Artists; a number of Paintings by Jean McReynolds; and Scenes of Alaska by Lieutenant Commander Wilson F. Erskine, during September.

The Pictures of the Month, shown in the little rotunda gallery, have been selected from the recent summer annual print exhibition.

### CALIFORNIA SCHOOL OF FINE ARTS

The California School of Fine Arts, 800 Chestnut street, San Francisco, opened its Fall Term

on September 10th, with enrollments for the 18-week semester representing one of the largest in recent years.

Ernest K. Mundt, director, points out that the school, one of the oldest art schools in the west, offers a three-year course of study in the departments of Painting, Sculpture, Graphic Arts; Design for Commerce and Industry; and Photography. The program this year includes day and night classes.

### LES BISHOP ACQUIRES MANUFACTURING PLANT

Les Bishop, long identified with the building supply industry on the Pacific Coast, has acquired ownership of the J. E. Burkheimer Manufacturing Company of California with general offices in Oakland.

The firm will carry the name L. K. Bishop & Company.

### DON W. LYON PROMOTED TO NEW JOB IN TOLEDO

Don W. Lyon, district manager of the Libbey-Owens-Ford Glass Company, with headquarters in San Francisco, has been promoted by his com-

pany to the newly created position of National Sales Manager of the textile division of the Fiberglass division of the firm's business.

Offices of the newly developed sales division will be centered in Toledo, Ohio, where Lyon will make his headquarters.



DON W. LYON  
Promoted

Don Lyon is well known throughout the construction industry of

the Pacific Coast where he has taken an active part in the affairs of the Producers' Council, Inc., serving as chairman of a number of committees and also as president of the Northern California Chapter.

## PLANNING COMPACTNESS AND CONVENIENCE ?

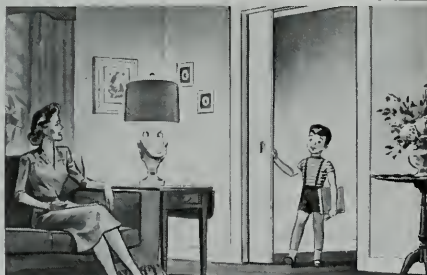

## STANLEY Residential

### SLIDING DOOR HARDWARE

Sliding Doors Pay Extra Dividends in smart appearance, easy, effortless operation, and more freedom for furnishings. Leading architects and engineers are emphasizing these advantages in the trend to lightweight interior doors where compactness and convenience are important.

Wide Range of Applications—single or multiple doors—is matched by modern Stanley design . . . V-shaped track for minimum friction . . . quick and easy adjustment with a screw driver without removing trim. Complete plans are packed with each set. The Stanley Works, New Britain, Connecticut.

STANLEY

Send for Comprehensive Folder

HARDWARE • TOOLS • ELECTRIC TOOLS • STEEL STRAPPING • STEEL

### STANDARD OIL EXPANDS

Plans for a \$1,500,000 expansion of facilities for production of synthetic detergent materials has been announced by the Standard Oil Company of California. The additional facilities will be added to the Richmond refinery.

FARM FAMILIES have about 21 per cent more money to spend on living than the average U. S. family—\$3,247 against \$2,599.

## AIR CONDITIONING Principles and Objectives

(From Page 16)

the added load appears to be beyond the capacity of the evaporative mechanism. Evaporation remains substantially constant, but total heat loss decreases, indicating a lowered level of bodily activity.

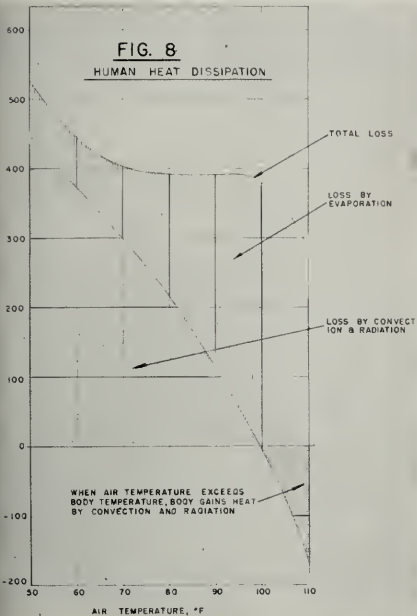

The information shown is for the low rate of body activity mentioned and for an atmosphere of 45% relative humidity. Had the bodily activity been greater, not only would the total heat production have been higher, but also the proportion of that heat rejected by evaporation would have been higher. As the moisture content of air increases, the ability of the air to receive additional moisture is impaired, and consequently, the ability of the air to take part in the process by which the body cools itself by evaporation is decreased. At any one air temperature, increasing the moisture content of air increases the quantity of air required for cooling the body, for, as the quantity of moisture carried away per pound of air decreases, the number of pounds of air must increase. If the air flow rate is insufficient to properly cool the body, physical activity must be curtailed, otherwise body temperature must inevitably rise.

(To be continued next month)

Another famous western brand

The West's accepted brand of quality in lighting equipment! Look for this mark of excellence in meeting your lighting needs. Smoot-Holman Illumination is distinguished by outstanding design, superior construction and economical performance in commercial, industrial and institutional uses

ILLUMINATION EQUIPMENT  
**SMOOT-HOLMAN**  
INGLEWOOD, CALIFORNIA  
MADE IN U.S.A.

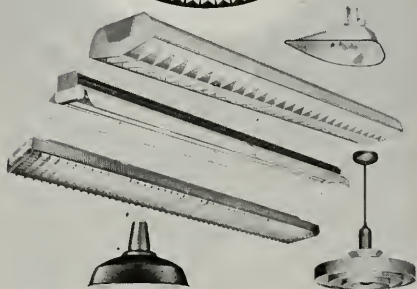

SMOOT-HOLMAN COMPANY Inglewood, Calif. Offices in Principal Western Cities • Branch and Warehouse in San Francisco



## A Combined

Landscape Architecture  
and Contracting Service

for

Tract, Industrial and Residential  
Development  
We can do the Complete Job for you

- Landscape Architecture
- Finish Grading and Landscaping
- Asphalt Drives and Parking Lots

**HENRY C. SOTO CORPORATION**  
*Landscape Contractors*

13000 SO. AVALON BLVD. LOS ANGELES 61, CALIF.  
Phone MEnlo 4-6617

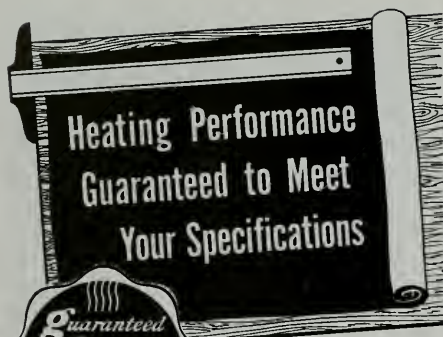

Specify Utility equipment!—The one sure way to avoid the headaches of an installation that just doesn't measure up to your specifications. You're sure with Utility because it sets the industry standard for quality and performance.

#### A FULL RANGE OF UTILITY HEATING EQUIPMENT

**Floor Furnaces**—45,000 BTU/Hr. input, flat and dual; also, 60,000 BTU/Hr. input, flat and dual (both sizes, shallow-type construction). **Wall Heaters**—Single—27,500 BTU/Hr. input; Dual—35,000 BTU/Hr. input and 50,000 BTU/Hr. input. **Forced Air Furnaces**—75,000 BTU/Hr. input; 100,000 BTU/Hr. input; 125,000 BTU/Hr. input and 150,000 BTU/Hr. input. **Unit Heaters**—4 sizes. All Utility Heating Equipment is tested and approved by A.G.A.



#### UTILITY EVAPORATIVE AIR COOLERS AND VENTILATING EQUIPMENT FOR EVERY PURPOSE

Utility's air delivery tables are complete and authentic, derived from tests made in accordance with A.S.H.V.E. test codes. Every Utility cooler is tested in accordance with these same codes. You can meet every requirement with Utility. The line includes evaporative coolers, both Fan and Blower types... sizes to meet all requirements.

#### SEND FOR AIA ENGINEERING INFORMATION

For this complete technical data on Utility equipment, plus valuable tables, charts, installation details, write (on your letterhead) to Engineering Dept. Counsel from a Utility Engineer available without charge.

UTILITY APPLIANCE CORP.  
4851 S. Alameda Street, Los Angeles 58, California



EVAPORATIVE AIR COOLERS      GAS-FIRED FURNACES  
VENTILATING EQUIPMENT

Manufacturers of Gaffers & Sattler and Occidental Gas Ranges

#### WALTER B. SIEGEL APPOINTED BY SOULE' STEEL COMPANY

Walter B. Siegel has been appointed general personnel and industrial relations manager for the Soule' Steel Company, San Francisco, according to an announcement by Edw. L. Soule', President of the firm.

Siegel, a University of California graduate in Law, will have charge of the company's plants in San Francisco, Portland, and Los Angeles.

#### AMERICA NEEDS SCHOOLS

(From Page 11)

lems. "Upset the balance of one and you upset them all."

"Ten, twenty and fifty years from now, curriculums in the schoolroom will have changed and kept pace with conditions, but the schoolhouses now being built will keep affecting the well-being of our children for many generations."

Dr. Harmon, former director of the Division of School Health for the Texas State Department of Health, and now serving as visiting professor in Education at Stanford, has directed studies of more than 160,000 school children. These studies demonstrated the effects of improper lighting (both daylight and artificial), faulty heating, seating, decorating and the arrangements of classrooms on the pupils' health, development and learning capacity. From these studies he has worked out the principles of the "co-ordinated classroom," in school-room planning. During the past three years the results of his studies have been reflected in the design of over three-quarter of a billion dollars of new schools from Alaska to Florida, from Ontario to Texas.

#### CONSTRUCTION PROBLEMS

(From Page 19)

this method on several projects has definitely proved its economy.

Altho the Youtz-Slick Method pertains to a study of a general construction method, the same type of analysis and investigation has reaped profits on smaller unit operations. Studies have been made to determine the effect of moisture in brick (when laid) on the subsequent rate of moisture penetration through the wall; on the development of improved cements and adhesives; on the use of removable partitions, and many others.

Small units can be given functional tests before installation to determine whether they will be satisfactory after repeated use. Hardware elements are particularly adaptable to this method of checking. Surfacing materials may be subjected to tests to determine their resistance to atmospheric attack, either natural or that caused by special agents introduced by industrial plants near the structure.



Light-resistance can also be determined under natural sunlight or under accelerated conditions of extra intensity.

In summation, research laboratories offer many methods by which an architect or other designer may satisfy himself in advance as to the performance of a new or unusual element or procedure. The methods of attacking the problem range through many fields — analyzing the steps involved in construction developing new methods or materials to simplify these steps; analyzing the design requirements of existing building elements; inventing new elements for better performance; and establishing the performance of these new elements in advance of their actual installation and use.

## CONTRACTORS' COSTS

(From Page 11)

machinery and equipment is well housed and completely maintained. To eliminate the undue hardship of the general contractor, the following changes in the existing and proposed tax laws are respectfully requested:

1. To permit a contractor to treat as a net operating loss, subject to the carry-back and carry-over provisions of Section 122 (b) of the Internal Revenue Code, an amount representing the excess of the replacement cost of equipment used in the trade or business over the original cost of the same type of equipment actually replaced in the year it becomes fully depreciated, or prior thereto.

A provision of this kind is urgently needed to enable many general contractors now operating in the field of construction to continue in business. The existing, as well as the proposed, rates of tax and the abnormal appreciation in the cost of construction equipment have created a condition that only legislative relief can alleviate. The impact is particularly severe on general contractors operating in the heavy and highway construction fields, where large stocks of construction equipment are necessary to their operations. This is true regardless of whether the general contractor operates as a corporation or as an individual. The life of the equipment used in the operation is short, and a certain portion of the equipment must be replaced every year. Because of this, the high rates of tax, and the abnormal appreciation in the cost of this equipment, the problem facing the general contractor is where to get the money necessary to replace the old equipment with new. It is self-evident that it must come either from borrowings or from past earnings or future charges.

(See Page 38)



**STOP**  
Penetration Of  
**MOISTURE**  
**WIND**  
**DUST**  
**VERMIN**  
EVERLASTING  
PROTECTION

Quality Products Since 1895  
**ANGIER PACIFIC CORPORATION**  
55 NEW MONTGOMERY ST. 7124 SUNSET BOULEVARD  
SAN FRANCISCO 5, CALIF. LOS ANGELES 41, CALIF.  
A complete line of Angier products available  
from your building material dealer

## FORDERER CORNICE WORKS

Manufacturers of

Hollow Metal Products • Interior Metal Trim  
Elevator Fronts and Cabs  
Metal Plaster Accessories • Sanitary Metal Base  
Flat and Roll Metal Screens  
Metal Cabinets • Commercial Refrigerators

269 POTRERO AVE.

SAN FRANCISCO, CALIF.

HEMLOCK 1-4100

## Parker, Steffens & Pearce

BUILDERS

135 South Park, San Francisco

Phone: EXbrook 2-6639

## BARRETT & HILP

CONTRACTORS

*Builders of the West*

918 Harrison Street • San Francisco  
Telephone DOuglas 2-0700

234 West 37th Place • Los Angeles  
Telephone ADams 3-8161

## JUDSON PACIFIC-MURPHY CORP.

Steel Fabricators  
and  
Erectors

REINFORCING STEEL  
STRUCTURAL STEEL  
BRIDGE CRANES

4300 EASTSHORE HWY.  
EMERYVILLE, CALIF.

Phone:  
OL 3-1717

## CLINTON CONSTRUCTION CO. OF CALIFORNIA

General Contractors

923 FOLSOM STREET • SAN FRANCISCO

Sutter 1-3440

## HOGAN LUMBER CO.

Wholesale and Retail

LUMBER

MILL WORK • SASH & DOORS

Office, Mill, Yard and Docks  
SECOND AND ALICE STREETS • OAKLAND, CALIF.  
Telephone Glencourt 1-6861



**SISALKRAFT**  
REINFORCED BUILDING PAPER

**PROTECTIVE  
BUILDING PAPER ...**  
WATERPROOF, REINFORCED ... USED  
AS SHEATHING PAPER, PROVIDES LIFE-LONG  
PROTECTION FROM ENTRY OF WIND, DUST AND  
MOISTURE. IDEAL FOR STUCCO-BACK, OVER  
SUBFILL, CONCRETE CURING, UNDER FLOORING,  
etc. Write for samples and complete data.

The SISALKRAFT CO.

55 New Montgomery St. San Francisco 3, California

## BOOK REVIEWS PAMPHLETS AND CATALOGUES

**FIRE RESISTANCE OF NON-LOAD-BEARING EXTERIOR WALLS.**  
Building Research Advisory Board, Publisher. Washington,  
D. C. Price \$3.50.

A publication representing the proceedings of a research correlation conference of the Building Research Advisory Board, Division of Engineering and Industrial Research, of the National Research Council.

It covers a number of technical discussions generated by new developments in the construction of multi-storied buildings.

**HOSPITALS—Integrated Design (Second Edition Completely Revised).** Progressive Architecture Library. Reinhold Publishing Corporation, New York City, N. Y. Price \$15.00.

In revising this book the authors made every effort to integrate the latest information on hospital design with the latest information on hospital needs and related facilities.

Architectural consideration such as planning for function, economy, orientation, lighting, details and finishes, and structural methods are discussed against a background of the problems peculiar to the hospital, the budget, furniture and equipment, mechanical plant and services. Attention is also given to location and space requirements of the complex parts of the modern hospital.

The text is closely illustrated with over 500 plans and photographs.

**FUNDAMENTALS OF PERSPECTIVE (Enlarged Second Edition).**

By Theodore De Fostels, A.I.A. Published by Reinhold Publishing Corporation, New York City, Price \$5.00.

Theodore De Fostels, widely known author of Fundamentals of Perspective, has presented a revised edition of the simple and easily understandable method of showing the order in which the lines of perspective are drawn.

A system of using Colors, Numbers, and Arrows makes it possible to eliminate much of the text which normally is found in books on perspective necessary to explain the construction of the drawings.

**SWEDEN BUILDS.** By G. E. Kidder Smith, A.I.A. Published by Albert Bonnier, New York and Stockholm.

Sweden Builds is a presentation of the country's modern architecture and land policy, with an explanation of the background and development of today's programs.

The book contains a large number of photographs by the Author and deals with Sweden's architectural inheritance and contemporary architecture.

**U. S. INDUSTRIAL DESIGN, 1951.** Edited by the Society of Industrial Designers. Published by Studio-Crowell, New York City, Price \$10.00.

The book presents U. S. Industrial Design as a process and a continuing force in the American economy.

Designers of a wide range of subject describe their product and work and each item or product is shown in photograph.

The book is a splendid presentation and of great interest to industrialists and engineers, students, and anyone interested in modern industrial design.

**THE WORK OF OSCAR NIEMEYER.** By Stamo Papadaki. Published by Reinhold Publishing Corporation, New York City, Price \$8.50.

Oscar Niemeyer is a young Brazilian architect who became known in the United States after his design for the Brazilian Pavilion at the 1939 New York World's Fair, and for his work as a design consultant for the United Nations Headquarters at the East River site in New York.

He also has conceived a number of outstanding types of buildings, such as week-end houses, schools, and churches, and industrial buildings which present unique structural and design solutions.

The reader will quickly see how other major arts, painting, sculpture and mosaic find an organic place in Niemeyer's work.

**CONTEMPORARY STRUCTURE IN ARCHITECTURE.** By Leonard Michaels, M.A., A.R.I.B.A. Published by Reinhold Publishing Corporation, New York City, Price \$8.50.

The author has provided 259 photographs and 75 drawings to illustrate the structural methods presently available to the architect and engineer.

The book is world wide in scope and every major structural system has been carefully analyzed and compared with other systems. The first portion of the book considers the skeleton frame whether it be steel, reinforced concrete, wood or some other material. Various methods of joining in relation to single-story and multi-story frames, plus horizontal infilling for the collection of loads on a horizontal plane are discussed by the Author.

The second section of the book is devoted to structure in architectural design and the relationship of structure to plan, section and massing, and design of contemporary buildings.

## NEW CATALOGUES AVAILABLE

Any of the catalogues or folders described here may be obtained by forwarding your request as indicated in the coupon below to the office of the ARCHITECT & ENGINEER. Merely mark the items you want and clip or paste the coupon to your letterhead.

**308. SCAFFOLD JACK.** Wilson-Albrecht Co., Inc., national manufacturers of WACO sectional steel scaffolding, have issued a two-color "visual sales" type booklet on use of the WACO Scaffold Jack. Refer to form KP1B; 8 pages illus., 8/27/51.

**309. BUILT-IN GAS COOKING UNITS.** To aid architects, contractors, designers, and home builders in the planning of new kitchens using sectionalized built-in gas cooking units, the Chambers Corporation, range manufacturer, has made available a colorful four-page specification brochure. The brochure represents the first effort by Chambers, in cooperation with the American Institute of Architects, to provide in concise, illustrative fashion, some of the answers to the current demand for functional cooking equipment in kitchen design. AIA 35-C-11 illus., 7/18/51.

**310. DAMPER AND SHUTTER BROCHURE.** Dampers and shutters for heating, air conditioning, ventilating and industrial applications, locomotives, buses, trucks and transit vehicles are described in a unique brochure recently issued by the Minneapolis-Honeywell Regulator Company. The booklet, fully illustrated, also describes the company's line of motor operating units that accurately position dampers in response to temperature or pressure controllers. illus., 8/51.

**311. TABLES OF MULTIPLE STEEL LENGTHS.** To help steel users get the most out of available steels, Tables of Multiple Lengths, Designed to help minimize waste in cutting steel, the tables in the booklet can be used to determine the exact size of any given number of lengths that can be cut from a longer length. Here is an example of how the tables work: Suppose a steel user orders 15-foot bars that he later cuts into 3-foot lengths. If a mill should roll, say, a 69-foot bar, only four 15-foot usable lengths could be cut from it. However, if multiple lengths of 3-foot units had been ordered, 23 usable 3-foot units could be cut from the same 69-foot bar. The tables are compiled on the basis of dead lengths and make no allowance for loss of material in recutting. 72 pages illus., 8/51.

**312. ALUMINUM DOORS AND FRAMES.** Trulline Company has just released a brochure covering complete installation details and specifications for aluminum doors and windows as manufactured by its plant. The three types of frames are carefully detailed under classifications A, B and C. 4 pages illus., 8/51.

**313. STAINLESS STEELS.** A new data and handbook on the stainless steels has been published by Allegheny Ludlum Steel Corporation and is now available for free distribution to users of the heat and corrosion resistant metals. In order to fill the growing needs of fabricators and design engineers for more complete on-the-job reference data, material contained in previous handbooks has been completely rewritten and categorized and much additional information has been added. In its 120 pages the cloth-bound volume discusses approximately 40 different types of Allegheny Metal stainless steel and covers each type from standpoints of analyses, fabrication, heat treatment and special conditions of service. 7/2/51.

### ARCHITECT AND ENGINEER

68 Post Street, San Francisco, Calif.

I would like to have a copy of each of the New Catalogues I have circled.

308	309	310
311	312	313

Please send to the address on my letterhead, or as I have indicated, and to my attention. (Please print your name — no literature will be sent on this coupon after October, 1951.—A. & E.)

## "AMERICAN - MARSH"

CONDENSATION UNIT

Pumping  
Machinery  
for  
Every  
Purpose

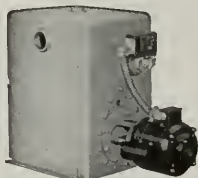

For Service  
Call  
DOuglas  
2-6794  
or  
MUtual 8322

**SIMONDS MACHINERY CO.**  
SAN FRANCISCO 816 FOLSOM  
LOS ANGELES 495 EAST 4TH

## VERMONT MARBLE COMPANY

DOMESTIC AND IMPORTED MARBLES  
GRANITE VENEER

525 MARKET STREET • SAN FRANCISCO

Phone: SUHer 1-6747

3522 COUNCIL STREET • LOS ANGELES

Phone: DUUnirk 2-7831

The Most Complete Line of  
STEELS and STEEL BUILDING MATERIALS  
Made by a Single Producer



See Sweet's Catalog File or write us for  
full information.

### REPUBLIC STEEL CORPORATION

GENERAL OFFICES: CLEVELAND, OHIO

DENVER, COLORADO . . . CONTINENTAL OIL BUILDING  
LOS ANGELES, CALIF. . . GENERAL PETROLEUM BUILDING  
SAN FRANCISCO, CALIFORNIA . . . RIALTO BUILDING  
SEATTLE, WASH. . . . . WHITE-HENRY-STUART BUILDING

## PACIFIC MANUFACTURING CO.

High Class Interior Finish Quality  
Millwork

16 Beale St., San Francisco  
Garfield 1-7755

2215 El Camina Real, San Mateo  
S. M. 5-0687

304 Bryant Street, Palo Alto  
P. A. 3373

2610 The Alameda, Santa Clara  
S. C. 607 (Factory)

6820 McKinley Avenue, Los Angeles  
THornwall 4196

MAIN OFFICE — SANTA CLARA

## CONTRACTORS' COSTS

(From Page 35)

What this critical situation means in dollars may be seen in the following assumed example:

A contractor, this year, is confronted with the necessity of purchasing a new tractor to replace the same type of tractor that is no longer able to perform the work required. He finds that this particular type of tractor, for instance, a large crawler equipped with bulldozer, that was purchased in 1945 at a cost of \$10,000 now costs \$19,400. This means that the contractor, in order to remain in business and own the same type of equipment this year that he owned in 1945, must expend an additional \$9,400, or practically two times the original cost, for the same type of tractor. Actually, the contractor must replace more than one piece of equipment each year, so instead of merely being faced with the purchase of one tractor, he is actually faced with the purchase of several other similar pieces of equipment that likewise have practically doubled in cost. It is not uncommon for the small contractor to be faced in a particular year with replacement of equipment originally costing as much as \$50,000, which today will cost approximately \$100,000. This means that a contractor must double his original capital investment.

The smaller contractor, in the main, to secure the additional amount necessary for him to remain in business, must either borrow the money out of future earnings or out of retained profits. Due to the high rates of tax, as proposed, there is small possibility of future profits or retained earnings.

For instance, a contractor operating as an individual (married) who finds it necessary to replace equipment requiring an **additional** expenditure of \$50,000 over the original cost of the equipment, must earn in excess of \$150,000 to merely leave him in the same position, with similar equipment, that he had when the original equipment was purchased. (Table I.)

A contractor operating as a corporation, subject only to the combined normal tax and surtax of 52 per cent as proposed in the new tax bill, must earn in excess of \$100,000 to assure his operation with similar type equipment now as at the time the original equipment was purchased. (Table II.)

A contractor, operating as a corporation, with excess profits tax credit so low that it is subject to the proposed ceiling rate of 70 per cent, must earn, before taxes, to merely cover the **additional** cost of new equipment in the amount of \$50,000, in excess of \$125,000. (Table III.)

Examples of the appreciation in cost of a few of the items of equipment commonly used by general contractors are:

	1945	1950
D-8 Tractor with Bulldozer.....	\$10,105	\$19,401
No. 12 Motor Patrol.....	6,916	13,461
20 Ton Motor Crane.....	15,090	27,671
2 Yd. Shovel.....	25,000	51,595

The hardship now confronting general contractors is comparable to situations that have confronted members of other industries in past years. Congress in the past recognized the then existing abnormal conditions and enacted legislation to alleviate the condition, in order to safeguard the right of members of the affected industries to continue in business.

2. To permit a general contractor a carry-back and carry-forward of all unused depreciation allowances on equipment.

This suggested provision in the tax laws is needed because of the uncertain conditions under which general contractors operate. There is no guarantee of a continuity of work in this industry. It does not necessarily follow that a general contractor that has a profitable operation this year will have work the following year. It is, therefore, important that the right of carry-back and carry-forward of the unused depreciation allowances be written into the tax law to permit the general

(See Page 43)

## VALUABLE NEWS SERVICE

- BUILDING MATERIAL DEALERS
- CONTRACTORS
- ENGINEERS
- FINANCIAL INSTITUTIONS

**ARCHITECTS REPORTS** gives advance news on construction projects in Northern California, lists: name of projects, location, architect, proposed cost and other pertinent information.

**HANDY** individual slip-reports, issued daily at a total cost of only

\$10 a month

## ARCHITECT'S REPORTS

Published Daily

The ARCHITECT and ENGINEER, Inc.

68 Post Street, San Francisco - DO 8311



# ESTIMATOR'S GUIDE

## BUILDING AND CONSTRUCTION MATERIALS

PRICES GIVEN ARE FIGURING PRICES AND ARE MADE UP FROM AVERAGE QUOTATIONS FURNISHED BY MATERIAL HOUSES TO SAN FRANCISCO CONTRACTORS. 3% SALES TAX ON ALL MATERIALS BUT NOT LABOR

All prices and wages quoted are for San Francisco and the Bay District. There may be slight fluctuation of prices in the interior and southern part of the state. Freight charge, at least, must be added in figuring country work.

**BONDS—Performance or Performance plus Labor and Material Bond(s), \$10 per \$1000 on contract price. Labor & Material Bond(s) only, \$5.00 per \$1000 on contract price.**

**BRICKWORK—MASONRY—**

Common Brick—Per 1 M laid—\$100.00 up (according to class of work).  
Face Brick—Per 1 M laid—\$200.00 end up (according to class of work).  
Brick Steps—\$3.00 and up.  
Common Brick Veneer on Frame Bldgs.—Approx. \$1.20 and up (according to class of work).  
Face Brick Veneer on Frame Bldgs.—Approx. \$2.00 end up (according to class of work).  
Common Brick—\$36.00 per M—trucked lots, delivered.  
Face Brick—\$81.00 to \$106.00 per M, trucked lots, delivered.

**Glazed Structural Units—**  
Clear Glazed—  
2 x 6 x 12 Furring ..... \$1.60 per sq. ft.  
4 x 6 x 12 Partition ..... 1.90 per sq. ft.  
4 x 6 x 12 Double Faced  
Partition ..... 2.25 per sq. ft.  
For colored glaze add ..... .30 per sq. ft.  
Mantels, Fire Brick—\$105.00 per M—F.O.B. Pittsburgh.

Fire Brick—Per M—\$111.00 to \$147.00.  
Carving—Approx. \$10.00 per M.  
Paving—\$75.00.

**Building Tiles—**  
8 1/2 x 12 inches, per M ..... \$139.50  
6 1/2 x 12 inches, per M ..... 105.00  
4 1/2 x 12 inches, per M ..... 84.00

**Hollow Tile—**  
12x12x8 inches, per M ..... \$146.75  
12x12x4 inches, per M ..... 156.85  
12x12x4 inches, per M ..... 177.10  
12x12x6 inches, per M ..... 235.30  
F.O.B. Plant

**BUILDING PAPER & FELTS**

1 ply per 1000 ft. roll ..... \$5.30  
2 ply per 1000 ft. roll ..... 7.80  
3 ply per 1000 ft. roll ..... 9.70  
Brownskin, Standard 500 ft. roll ..... 6.85  
Sikalrest, reinforced, 36 in. by 500 ft. roll ..... 7.00

**Sheathing Papers—**  
Asphalt sheathing, 15-lb. roll ..... \$2.00  
" " " " 30-lb. roll ..... 2.79  
Dampcourse, 21 1/2-in. roll ..... 2.15  
Blue Plasterboard, 60-lb. roll ..... 2.90

**Felt Papers—**  
Deadening felt, 3/4-lb., 50-ft. roll ..... \$3.23  
Deadening felt, 1-lb., ..... 3.79  
Asphalt roofing, 15-lbs. ..... 2.00  
Asphalt roofing, 30-lbs. ..... 2.79

**Roofing Papers—**  
Asphalt Flg., 15 lb. ..... \$2.09  
Standard Grade, 108 ft. roll, Light ..... 1.87  
" " " " " " " " Smooth Surface, Medium ..... 2.18  
" " " " " " " " Heavy ..... 2.56  
" " " " " " " " M. S. Extra Heavy ..... 2.96

**BUILDING HARDWARE—**

Sash cord com. No. 7 ..... \$2.65 per 100 ft.  
Sash cord com. No. 8 ..... 3.00 per 100 ft.  
Sash cord spool No. 7 ..... 3.65 per 100 ft.  
Sash cord spool No. 8 ..... 3.35 per 100 ft.  
Sash weight, cast iron, \$100.00 ton ..... \$11.80  
1-Ton tons, per 100 lbs. .... \$3.75  
Less than 1-ton tons, per 100 lbs. .... \$4.75  
Nails, per keg, basic ..... \$1.80  
8-in. spikes ..... 11.80  
Rim Knob lock sets ..... 1.80  
Butts, dull brass plated on steel, 3/16 x 3/2 ..... .76

**CONCRETE AGGREGATES—**

The following prices net to Contractors unless otherwise shown. Carload lots only.

	Bunker per ton	Del'd per ton
Gravel, all sizes	\$2.44	\$2.90
Top Sand	2.38	3.13
Concrete Mix	2.38	3.06
Crushed Rock, 1/4" to 3/4"	2.38	2.90
Crushed Rock, 3/4" to 1 1/2"	2.38	2.90
Roofing Gravel	2.81	2.90
River Sand	2.50	3.00
Sand—		
Lepis (Nos. 2 & 4)	3.56	3.94
Olympic (Nos. 1 & 2)	3.56	3.88

Common (all brands, paper sacks), carload lots, \$3.55 per bbl. f.o.b. car; delivered \$3.60.  
Per Sack, small quantity (paper) ..... \$1.05  
Carload lots, in bulk per bbl. .... 2.79  
Cash discount on carload lots, 10c a bbl., 10th Prov., less than carload lots \$4.00 per bbl. f.o.b. warehouse or delivered.  
Cash discount 2% on L.C.L.

Trinity White { 1 to 100 sects, \$3.13 sect  
warehouse or del.; \$5.54  
Medusa White { sect carload lots.

**CONCRETE READY-MIX—**

1-2-4 mix, to 10 yards\* ..... \$12.00  
10 to 100\* yards ..... 11.00  
100 to 500 yards ..... 10.50  
Over 500 yards, 10.30  
\* Delivered to site.

**CONCRETE BLOCKS—**

	Haydite	Ba-salt
4 1/2x8 1/2-inches each	\$.17	\$.18
6 1/2x8 1/2-inches, each	.22	.25
8 1/2x8 1/2-inches, each	.26	.26
12 1/2x8 1/2-inches, each	.34	.39
12 1/2x24-inches, each	—	.60

Haydite Aggregates—  
3/4-inch to 3/8-inch, per cu. yd. .... \$7.25  
3/8-inch to 1/4-inch, per cu. yd. .... 7.25  
No. 6 to 0-inch, per cu. yd. .... 7.25

**DAMP-PROOFING and Waterproofing—**

Two-coat work, \$9.00 per square.  
Membrane waterproofing—4 layers of set-ureted felt, \$10.00 per square.  
Hot coating work, \$5.00 per square.  
Medusa Waterproofing, \$3.50 per lb. San Francisco Warehouse.

Trico-seal concrete waterproofing, 60c a cubic yd. and up.

**ELECTRIC WIRING—\$15 to \$20 per outlet for conduit work (including switches).**  
Knob and tube average \$6.00 per outlet.

**ELEVATORS—**

Prices vary according to capacity, speed and type. Consult elevator companies. Average cost of installing a slow speed automatic passenger elevator in small four story apartment building, including entrance doors, about \$9,500.00.

**EXCAVATION—**

Send, \$1.00; clay or shale, \$1.50 per yard. Trucks, \$30 to \$45 per day.  
Above figures are an average without water. Steam shovel work in large quantities, less; hard material, such as rock, will run considerably more.

**FIRE ESCAPES—**

Ten-foot galvanized iron balcony, with stairs, \$250 installed on new buildings; \$300 on old buildings.

**FLOORS—**

Asphalt Tile, 1/8 in. gauge 18c to 35c per sq. ft.  
Composition Floors, such as Mege-sine, 50c per square foot.  
Linoleum, standard gauge, sq. yd. .... \$2.75  
Mestipeve—\$1.50 per sq. yd.  
Battlefish Linoleum—1/8"—\$3.00 sq. yd.  
Terezo Floors—\$1.50 per sq. ft.  
Terezo Steps—\$2.50 per lin. ft.  
Mastic Wax Coat—according to type—20c to 35c.

**Hardwood Flooring—**

**Oak Flooring—T & G—Unfin.—**  
Clear Old, White ..... 1425 \$405 \$ 1  
Clear Old, Red ..... 405 380 \$ 5  
Select Old, Red or White ..... 350 340  
Clear Pine, Red or White ..... 355 340 335 315  
Select Pine, Red or White ..... 340 330 325 300  
#1 Common, Red or White 315 310 305 280  
#2 Common, Red or White 305

**Refinished Oak Flooring—**

	Prime	Standard
1/2 x 2	\$367.00	\$359.00
1/2 x 2 1/2	380.00	370.00
1 1/2 x 2 1/2	390.00	381.00
1 1/2 x 3 1/2	375.00	355.00
1 1/2 x 3 3/4	395.00	375.00
1 1/2 x 2 1/4 & 3/4 Ranch Plank	415.00	

**Unfinished Maple Flooring—**

1 1/2 x 2 1/4 First Grade	\$390.00
1 1/2 x 2 1/4 2nd Grade	365.00
1 1/2 x 2 1/4 2nd & 3rd Grade	375.00
1 1/2 x 2 1/4 3rd Grade	240.00
1 1/2 x 3 1/4 & Btr. Jtd. EM	380.00
1 1/2 x 3 1/2 2nd & 3rd Jtd. EM	390.00
33/32 x 2 1/4 First Grade	400.00
33/32 x 2 1/4 2nd Grade	360.00
33/32 x 2 1/4 3rd Grade	320.00

Floor Layer Wage \$2.50 hr.

**GLASS—**

Single Strength Window Glass, \$ .30 per sq ft.  
Double Strength Window Glass, .45 per sq ft.  
Plate Glass, 1/4 polished to 75, 1.60 per sq ft.  
75 to 100, 1.74 per sq ft.  
1/4 in. Polished Wire Plate Glass, 2.35 per sq ft.  
1/4 in. Rgh. Wire Glass, .71 per sq ft.  
1/4 in. Polished Wire Plate Glass, 2.00 per sq ft.  
1/4 in. Rgh. Wire Glass, .64 per sq ft.  
1/2 in. Obscure Glass, .40 per sq ft.  
3/8 in. Obscure Glass, .44 per sq ft.  
1/2 in. Heat Absorbing Obscure, .58 per sq ft.  
1/4 in. Heat Absorbing Wire, .86 per sq ft.  
Glazing of above additional \$1.15 to .30 per sq ft.  
Glass Blocks, set in place, 3.50 per sq ft.

**HEATING—**

Average, \$3.50 to \$4.00 per sq. ft. of radiation, according to conditions.  
Warm air (gravity) average \$64 per register.  
Forced air average \$91 per register.

## INSULATION AND WALLBOARD—

4-oz. cell insulation—	
(2") Less than 1,000 sq. ft.	\$64.00
(2") Over 1,000 sq. ft.	\$9.00
Cotton Insulation—Full thickness	
(3 1/2")	\$75.50 per M sq. ft.
Insulation Aluminum Insulation—Aluminum coated on both sides.	\$23.50 per M sq. ft.
1-1/2-in. x 4-ft. panels	\$9.00 per panel
Wallboard—1/2" thickness	\$55.00 per M sq. ft.
Fire-rated Plyk	\$69.00 per M sq. ft.
Ceiling Tileboard	\$67.00 per M sq. ft.

**IRON**—Cost of ornamental iron, cast iron, etc. depends on designs.

## LUMBER—

S4S No. 2 and better common O.P. or D.F., per M. f.b.m.	\$100.00
Rough, No. 2, common O.P. or D.F., per M. f.b.m.	100.00

## Flooring—

Per M Delivd.	
V.G.-D.F. 8 & Str. 1 x 4 T & G Flooring	\$225.00
"C" and better—all	225.00
"D" and better—all	225.00
Rwd. Rustic—"A" grade, medium dry, 8 to 24 ft.	185.00
Plywood, per M sq. ft.	
1/4-inch, 4.0x8.0-515	\$170.00
1/2-inch, 4.0x8.0-515	250.00
3/4-inch, per M sq. ft.	315.00
Plyscrod	111 1/2¢ per sq. ft.
Flyform	25¢ per sq. ft.

Shingles (Rwd. not available)—	
Red Cedar No. 1—\$9.50 per square; No. 2, \$7.00; No. 3, \$5.00.	
Average cost to lay shingles, \$6.00 per square.	
Cedar Shakes—1/2" to 3/4" x 24/26 in. hand split tapered or split resawn, per square	\$15.25
3/4" to 1 1/4" x 24/26 in. split resawn, per square	17.00
Average cost to lay shakes, \$8.00 per square	
Pressure Treated Lumber—	
Walmalized	Add \$35 per M to above
Crossed.	Add \$45 per M to above
8-lb. treatment.	Add \$45 per M to above

## MARBLE—(See Dealers)

## METAL LATH EXPANDED—

Standard Diamond, 3, 40, Copper Bearing, LCL, per 100 sq. yds.	\$43.50
Standard Ribbed, ditto.	\$47.50

## MILLWORK—Standard.

D. F. \$150 per 1000, R. W. Rustic \$175 per 1000 (delivered).	
Double hung box window frames, average with trim, \$12.50 and up, each.	
Complete door unit, \$15 to \$25.	
Screen doors, \$8.00 to \$12.00 each.	
Patent screen windows, \$1.25 a sq. ft.	
Cases for kitchen pantries seven ft. high, per lineal ft., upper \$9.00 to \$11.00; lower \$12.00 to \$13.00.	
Dining room cases, \$20.00 per lineal foot. Rough and finish about \$1.00 per sq. ft.	
Labor—Rough carpentry, warehouse heavy framing (average), \$75.00 per M.	
For smaller work average, \$85.00 to \$100. per 1000.	

## PAINTING—

Two-coat work	per yard	85c
Three-coat work	per yard	\$1.10
Cold water painting	per yard	25c
Whitewashing	per yard	15c
Linseed Oil, Strictly Pure	Wholesale	
(Basis 7 1/2 lbs. per gal.)	Rew. Balled	
Light iron drums	per gal.	\$2.28
5-gallon cans	per gal.	2.40
1-gallon cans	each	2.52
Quart cans	each	.71
Pint cans	each	.38
1/2-pint cans	each	.24
Turpentine	Pure Gum	
(Basis, 7.2 lbs. per gal.)	Spirits	
Light iron drums	per gal.	\$1.65
5-gallon cans	per gal.	1.76
1-gallon cans	each	1.88
Quart cans	each	.54
Pint cans	each	.31
1/2-pint cans	each	.20

## Pioneer White Lead in Oil Heavy Paste and All Purpose (Soft-Paste)

Net Weight	List Price	Price to Painters
per 100 lbs.	per 100 lbs.	per 100 lbs.
100-lb. kegs	\$28.35	\$27.50
50-lb. cans	30.05	15.03
25-lb. cans	30.35	7.59
5-lb. cans	33.35	1.34
1-lb. cans	36.00	.36
500 lbs. (one delivery)	3/4¢	per pound less than above.

## Pioneer Dry White Lead—Litharge—Dry Red Lead—Red Lead in Oil

Price to Painters—Price Per 100 Pounds	
Products	100 lbs.
Dry White Lead	256.30
Litharge	25.95
Dry Red Lead	27.20
Red Lead in Oil	30.65
Found cts., \$37 per lb.	

## PATENT CHIMNEYS—

6-inch	\$2.50 lineal foot
8-inch	3.00 lineal foot
10-inch	4.00 lineal foot
12-inch	5.00 lineal foot

## PLASTER—

Neat wall per ton delivered in S. F. in paper bags, \$17.60.

## PLASTERING (Interior)—

3 Coats, metal lath and plaster	Yard	\$3.00
Keene cement on metal lath		3.50
Ceilings with 3/4" hot roll channels metal lath (lathed only)		3.00
Ceilings with 3/4" hot roll channels metal lath plastered		4.50
Single partition 3/4" channel lath 1 side (lath only)		3.00
Single partition 3/4" channel lath 2 inches thick plastered		3.00
4-inch double partition 3/4" channel lath 2 sides (lath only)		5.75
4-inch double partition 3/4" channel lath 2 sides plastered		6.75
Thermex single partition; 1" channels; 2 1/2" overall partition width, Plastered both sides		7.50
Thermex double partition; 1" channels; 4 1/4" overall partition width, Plastered both sides		11.00
3 Coats over 1" Thermex nailed to one side wood studs or joists		4.50
3 Coats over 1" Thermex suspended to one side wood studs with spring sound isolation clip		5.00
Note—Channel lath controlled by limitation orders.		

## PLASTERING (Exterior)—

2 coats cement finish, brick or concrete wall	Yard	\$2.50
3 coats cement finish, No. 18 gauge wire mesh		3.50
Line—\$4.00 per bbl. at yard.		
Processed LIME—\$4.15 per bbl. at yard.		
Rock or Grip Lath—3/4"—30¢ per sq. yd.		
"	1/2"—29¢ per sq. yd.	
Composition Stucco—\$4.00 sq. yard (applied).		

## PLUMBING—

From \$200.00 per fixture up, according to grade, quality and runs.

## ROOFING—

"Standard" tar and gravel, 4 ply—\$11.00 per sq. for 30 sqs. or over.	
Less than 30 sqs. \$14.00 per sq.	
Tile \$40.00 to \$50.00 per square.	
No. 1 Redwood Shingles in place, 4 1/2 in. exposure, per square	\$18.25
5/2 No. 1 Cedar Shingles, 5 in. exposure, per square	14.50
5/8 x 1/4—No. 1 Little Giant Cedar Shingles, 5" exposure, per square.	18.25

4/2 No. 1-24" Royal Cedar Shingles	23.00
7/2" exposure, per square	
Re-coat with Gravel \$5.50 per sq.	
Asbestos Shingles, \$27 to \$35 per sq. laid.	
1/2 to 3/4 x 25" Resawn Cedar Shakes, 10" Exposure	\$30.00
3/4 to 1 1/4 x 25" Resawn Cedar Shakes, 10" Exposure	\$35.00
1 x 25" Resawn Cedar Shakes, 10" Exposure	22.00
Above prices are for shakes in place.	

## SEWER PIPE—

C.I. 6-in. to 24-in. B. & S. Class B and heavier, per ton	\$99.50
Vitrified, per foot: L.C.L. F.O.B. Warehouse, San Francisco.	
Standard, 8-in.	.66
Standard, 12-in.	1.30
Standard, 24-in.	5.41
Clay Drain Pipe, per 1,000 L.F. L.C.L., F.O.B. Warehouse, San Francisco:	
Standard, 6-in. per M.	\$240.00
Standard, 8-in. per M.	400.00

## SHEET METAL—

Windows—Metal, \$2.50 a sq. ft.	
Fire doors (average), including hardware \$2.80 per sq. ft., size 12'x12', \$3.75 per sq. ft., size 3'x6'.	

## SKYLIGHTS—(not glazed)

Copper, \$1.25 sq. ft. (flat).	
Galvanized iron, 65¢ sq. ft. (flat).	
Vented hip skylights, \$1.50 sq. ft.	

## STEEL—STRUCTURAL—

\$220 per ton erected, when out of mill.	
\$270 per ton erected, when out of stock.	

## STEEL REINFORCING—

\$200.00 per ton, in place.	
1/4-in. Rd. (Less than 1 ton)	\$8.40
3/8-in. Rd. (Less than 1 ton)	7.30
1/2-in. Rd. (Less than 1 ton)	7.00
5/8-in. Rd. (Less than 1 ton)	6.75
3/4-in. & 7/8-in. Rd. (Less than 1 ton)	6.65
1-in. & up (Less than 1 ton)	6.60
1 ton to 5 tons, deduct 25c.	

## STORE FRONTS (None available)

## TILE—

Ceramic Tile Floors—Commercial \$1.20 to \$1.60 per sq. ft.	
Cove Base—\$1.40 per lin. ft.	
Quarry Tile Floors, 6x6" with 6" base @ \$1.35 per sq. ft.	
Tile Waincots & Floors, Residential, 4 1/4 x 4 1/4", \$1.65 to \$2.00 per sq. ft.	
Tile Waincots, Commercial Jobs, 4 1/4 x 4 1/4", @ \$1.50 to \$1.65 per sq. ft.	
Asphalt Tile Floor 1/2" sq. ft. \$ .18 - .35 sq. yd.	
Light shades square yd.	
Cork Tile—\$.70 per sq. ft.	
Mosaic Floors—see dealers	
Lino-Tile—\$1.00 per sq. ft.	
Rubber Tile—\$.55 to \$.75 per sq. ft.	
Building Tile—	
8x5 1/2 x 12-inches, per M	\$139.50
4x5 1/2 x 12-inches, per M	158.85
4x5 1/2 x 12-inches, per M	177.10
12x12x6-inches, per M	235.30
F.O.B. Plant	

## VENETIAN BLINDS—

75c per square foot and up. Installation extra.

## WINDOWS—STEEL—INDUSTRIAL

Cost depends on design and quality required.

# ARCHITECT AND ENGINEER ESTIMATOR'S DIRECTORY

## Building and Construction Materials

EXPLANATION—Building and construction materials are shown in major classified groups for general identification purposes with names and addresses of suppliers of materials listed in detail under group classification where name first appears—main offices are shown first with branch or district offices following. The numeral appearing in listings refers to the major group classification where complete data on the dealer, or representative, may be found.

### AIR CONDITIONING (1b)

Air Conditioning & Cooling  
UTILITY APPLIANCE CORP.  
Los Angeles 58, 4851 S. Alameda St.  
San Francisco, 1355 Market St., UN 1-4908

### ARCHITECTURAL VENEER (a)

Ceramic Veneer  
PACIFIC CLAY PRODUCTS  
San Francisco: 605 Market St., GA 1-3970  
Los Angeles, Portland, Salt Lake City  
GLASSING, McBEAN & CO. \*(1)  
Porcelain Veneer

### PORCELAIN ENAMEL PUBLICITY BUREAU

(Dept. AE-450)  
Room 601, Franklin Building, Oakland 12, California  
P. O. Box 186, East Pasadena Station, Pasadena 8,  
California

### Granite Veneer

VERMONT MARBLE COMPANY  
San Francisco 5: 525 Market Street, SU 1-6747  
Los Angeles 4: DU 2-7834

### Marble Veneer

VERMONT MARBLE COMPANY  
San Francisco 5: 525 Market Street, SU 1-6747  
Los Angeles 4: DU 2-7834

### BANKS-FINANCING (1b)

CROCKER FIRST NATIONAL BANK OF S. F.  
San Francisco, Post & Montgomery Sts., EX 2-7700

### BRASS PRODUCTS (1a)

GREENBERG'S, M. & SONS  
San Francisco, Calif.: 765 Folsom, EXbrook 2-3143

### BRICKWORK (1)

Face Brick  
GLADDING, McBEAN & CO.  
San Francisco: Harrison at 9th Sts., UN 1-7400  
Los Angeles: 2901 Los Feliz Blvd., OL 2121  
Offices at Portland, Seattle, Spokane  
KRAFTILE

Nilas, California, Nilas 3611  
San Francisco 5: 50 Hawthorne St., DO 2-3780  
Los Angeles 13: 406 South Main St., MU 7241  
REMILLARD-DANDINI CO.  
San Francisco: 400 Montgomery St., EX 2-4988

### BRONZE PRODUCTS (1b)

GREENBERG'S M. & SONS  
San Francisco, Calif.: 765 Folsom, EXbrook 2-3143

### BUILDING PAPER & FELTS (2)

SISALKRAFT COMPANY  
San Francisco: 55 New Montgomery St., EX 2-3066  
Chicago, Ill.: 205 West Wacker Drive  
ANGIER PACIFIC CORP.  
San Francisco 5: 55 New Montgomery St., DO 2-4416  
Los Angeles: 7424 Sunset Boulevard

### BUILDING HARDWARE (3)

THE STANLEY WORKS  
San Francisco: Monednock Bldg., YU 6-5914  
New Britain, Conn.

### CEMENT (c)

PACIFIC PORTLAND CEMENT  
San Francisco: 417 Montgomery St., GA 1-4100

### CONCRETE AGGREGATES (4)

Lightweight Aggregates  
AMERICAN PERLITE CORP.  
Richmond, Calif.: 26th & B Sts.—Yard 2, RI 4307

### DOORS (4a)

Hollywood Doors  
WEST COAST SCREEN CO.  
Los Angeles: 1127 E. 63rd St. AD 1-1108  
Distributors:

W. P. FULLER CO.  
Seattle, Tacoma, Portland  
NICOLAI DOOR SALES CO.  
San Francisco: 3045 19th St.  
T. M. COBB CO.

Los Angeles & San Pedro  
SOUTHWEST SASH & DOOR  
Phoenix, Arizona  
HOUSTON SASH & DOOR  
Houston, Texas

### Screen Doors

WEST COAST SCREEN CO.  
(See Hollywood Door listing above)

### FIRE ESCAPES (5)

SOULE STEEL  
San Francisco: 1750 Army St., VA 4-4141  
Los Angeles, Calif.—LA 0911  
Portland, Ore.—BE 5155  
Seattle, Wash.—SE 3010  
MICHAEL & PFEFFER IRON WORKS, INC.  
San Francisco 3: Tenth & Harrison Sts.,  
LA 1-5966

### FIRE PLACES (5a)

Heat Circulating  
SUPERIOR FIREPLACE CO.  
Los Angeles: 1708 E. 15th St. PR 8393  
Baltimore, Md.: 601 No. Point Rd.

### FLOORS (6)

Hardwood Flooring  
HOGAN LUMBER COMPANY  
Oakland: Second and Alice Sts., GL 1-6861  
E. K. WOOD LUMBER CO.  
Los Angeles: 4710 S. Alameda St., JE 3111  
Oakland: 727 Kennedy St., KE 4-8466  
Portland: 827 Terminal Sales Building  
Floor Treatment & Maintenance  
HILLYARD SALES CO. (Western)  
470 Alabama St., San Francisco, MA 1-7766  
Los Angeles, 923 E. 3rd, Trinity 8282  
Seattle, 3440 E. Marginal Way

### GLASS (7)

W. P. FULLER COMPANY  
San Francisco: 301 Mission St., EX 2-7151  
Los Angeles, Calif.  
Portland, Oregon

### HEATING (8)

HENDERSON FURNACE & MFG. CO.  
Sebastopol, Calif.  
S. T. JOHNSON CO.  
Oakland 8: 940 Arlington Ave., OL 2-6000  
San Francisco: 585 Potrero Ave., MA 1-2757  
Philadelphia 8, Pa.: 401 No. Broad St.  
SCOTT COMPANY  
San Francisco: 243 Minna St., YU 2-0400  
Oakland: 113 - 10th St., GL 1-1937  
San Jose, Calif.  
Los Angeles, Calif.

### Electric Heaters

ELECTROMODE CORP.  
Rochester, N. Y.  
San Francisco: 1355 Market St., KL 2-2311  
Northern California Distributors  
GENERAL ELECTRIC SUPPLY CORP.  
San Francisco: 1201 Bryant St., UN 3-4000  
Emeryville: 5400 Hollis St., OL 3-4433  
Sacramento: 1131 S St., GI 3-9001  
Fresno: 1234 O St., Fresno 4-4746  
INCANDESCENT SUPPLY COMPANY  
Redding: 2146 Pine St., Redding 200  
THOMAS B. HUNTER (Designer)  
San Francisco: 41 Sutter St., GA 1-1164

### UTILITY APPLIANCE CORP. \*(b)

INSULATION AND WALLBOARD (9)  
LUMBER MANUFACTURING CO.  
San Francisco: 225 Industrial Ave., JU 7-1760  
SISALKRAFT COMPANY \*(2)  
WESTERN ASBESTOS COMPANY  
San Francisco: 675 Townsend St., KL 2-3868  
Oakland: 251 Fifth Avenue, GL 1-2345  
Sacramento: 1224 I Street, 2-8993  
Stockton: 1120 E. Weber Ave., 4-1863  
Fresno: 1837 Marced Street, 3-3277  
San Jose: 201 So. Market St., BA 4359-J

### IRON—Ornamental (10)

MICHEL & PFEFFER IRON WORKS, INC. \*(5)

### LANDSCAPE (11a)

Landscape Contractors  
HENRY C. SOTO CORPN.  
Los Angeles, 13000 S. Avalon Blvd. ME 4-6617

### LIGHTING FIXTURES (11)

SMOOTH-HOLMAN COMPANY  
Inglewood, Calif., OR 8-1217  
San Francisco: 55 Mississippi St., MA 1-8474

### LUMBER (12)

HOGAN LUMBER COMPANY \*(6)  
LUMBER MANUFACTURING CO. \*(9)  
E. K. WOOD LUMBER CO. \*(6)

### Shingles

SEAWALL LUMBER COMPANY  
San Francisco 24: 1995 Oakdale Ave., AT 2-8112

### MARBLE (13)

VERMONT MARBLE COMPANY  
San Francisco: 525 Market St., SU 1-6747  
Los Angeles 4: 3522 Council St., DU 2-7834

### METAL LATH EXPANDED (14)

FORDERER CORNICE WORKS  
San Francisco: 269 Potrero Ave., HE 1-4100  
SOULE STEEL \*(5)

### MILLWORK (15)

PACIFIC MANUFACTURING COMPANY  
San Francisco: 16 Beale St., GA 1-7755  
Santa Clara: 2610 The Alameda, SC 607  
Los Angeles: 6820 McKinley Ave., TH 4196  
MULLEN MANUFACTURING COMPANY  
San Francisco: 60-80 Rausch St., UN 1-5815  
LUMBER MANUFACTURING COMPANY \*(9)

### PAINTING (16)

Paint  
W. P. FULLER COMPANY \*(7)

### PLASTER (17)

Exteriors  
PACIFIC PORTLAND CEMENT COMPANY \*(4)  
Interiors—Metal Lath & Trim  
FORDERER CORNICE WORKS \*(14)

### PLASTIC CEMENT (f)

PACIFIC PORTLAND CEMENT CO.  
San Francisco: 417 Montgomery St., GA 1-4100

### PLUMBING (18)

THE SCOTT COMPANY \*(8)  
THE HALSEY TAYLOR COMPANY  
Redlands, Calif.  
Warren, Ohio  
HAWES DRINKING FAUCET COMPANY  
Berkeley 10: 1435 Fourth St., LA 5-3341  
CONTINENTAL WATER HEATER COMPANY  
Los Angeles 31: 1801 Pasadena Ave., CA 6178

## SIMONDS MACHINERY COMPANY

San Francisco: 816 Folsom St., DO 2-6794

Los Angeles: 455 East 4th St., MU 8322

## SECURITY VALVE COMPANY

Los Angeles 31: 410 San Fernando Rd., CA 6191

## REPUBLIC STEEL CORP.

San Francisco: 116 N. Montgomery St., GA 1-0977

Los Angeles: Edison Building

Seattle: White-Henry-Stuart Building

Salt Lake City: Walker Bank Building

Denver: Continental Oil Building

KRAFTILE COMPANY \*(1)

SAN JOSE STEEL COMPANY

San Jose: 195 North Thirtieth St., CO 4184

## WINDOWS STEEL 125)

DETROIT STEEL PRODUCTS CO. \*(20)

MICHEL &amp; PFEFFER IRON WORKS, INC. \*(5)

SOULE STEEL COMPANY \*(5)

## SEWER PIPE (19)

GLADDING, McBEAN &amp; CO. \*(1)

PACIFIC FLAY PRODUCTS

San Francisco: 605 Market St., GA 1-3970

Los Angeles, Portland, Salt Lake City

## STEEL—REINFORCING (22)

REPUBLIC STEEL CORP. \*(21)

HERRICK IRON WORKS \*(21)

SAN JOSE STEEL CO. \*(21)

COLUMBIA STEEL CO. \*(21)

## SHEET METAL (20)

## Windows

DETROIT STEEL PRODUCTS COMPANY

Oakland 8: 1310 - 63rd St., OL 2-8826

San Francisco: Russ Building, DO 2-0890

MICHEL &amp; PFEFFER IRON WORKS, INC. \*(5)

SOULE STEEL COMPANY \*(5)

## TILE (23)

GLADDING, McBEAN &amp; CO. \*(1)

KRAFTILE COMPANY \*(1)

PACIFIC FLAY PRODUCTS

San Francisco: 605 Market St., GA 1-3970

Los Angeles, Portland, Salt Lake City

## FIRE DOORS

DETROIT STEEL PRODUCTS COMPANY

## Skylights

DETROIT STEEL PRODUCTS COMPANY

## TIMBER—REINFORCING (b)

## Trusses

WEYERHAEUSER SALES CO.

Tacoma, Wash.

St. Paul, Minn.

Newark, N. J.

Treated Timber

## STEEL—STRUCTURAL (21)

COLUMBIA STEEL CO.

San Francisco: Russ Bldg., SU 1-2500

Los Angeles: 2087 E. Slauson, LA 1171

Portland: 2345 N. W. Nicolai, BE 7261

Seattle: 1331 3rd Ave. Bldg., MA 1972

Salt Lake City: Walker Bank Bldg., SL 3-6733

J. H. BAXTER CO.

San Francisco 4: 333 Montgomery St., DO 2-3883

Los Angeles 13: 601 West Fifth St., MI 6294

## WALL TILE (24)

GLADDING, McBEAN &amp; CO. \*(1)

KRAFTILE COMPANY \*(1)

## HERRICK IRON WORKS

Oakland: 18th &amp; Campbell Sts., GL 1-1767

JUDSON PACIFIC-MURPHY CORP.

Emeryville: 4300 Eastshore Highway, OL 3-1717

## GENERAL CONTRACTORS (26)

BARRETT &amp; HILP

San Francisco: 918 Harrison St., DO 2-0700

Los Angeles: 234 W. 37th Place, AD 3-8161

DINWIDDIE CONSTRUCTION COMPANY

San Francisco: Crocker Building, YU 6-2718

CLINTON CONSTRUCTION COMPANY

San Francisco: 923 Folsom St., SU 1-3440

MATCOCK CONSTRUCTION COMPANY

San Francisco: 604 Mission St., GA 1-5516

PARKER, STEFFENS &amp; PEARCE

San Francisco: 135 So. Park, EX 2-6639

STOLTE, INC.

Oakland: 8451 San Leandro Blvd., TR 2-1064

SWINERTON &amp; WALBERG COMPANY

San Francisco: 225 Bush St., GA 1-2980

Oakland: 1723 Webster St., HI 4-4322

Los Angeles, Sacramento, Denver

P. J. WALKER COMPANY

San Francisco: 391 Sutter St., YU 6-5916

Los Angeles: 714 W. Olympic Blvd., RI 7-5521

## TESTING LABORATORIES

(ENGINEERS &amp; CHEMISTS) (27)

ABBOT A. HANKS, INC.

San Francisco: 624 Sacramento St., GA 1-1697

ROBERT W. HUNT COMPANY

San Francisco: 251 Kearny St., EX 2-4634

Los Angeles: 3050 E. Slauson, JE 9131

Chicago, New York, Pittsburgh

PITTSBURGH TESTING LABORATORY

San Francisco: 651 Howard St., EX 2-1747

## BUILDING TRADES WAGE (JOB SITES) NORTHERN, CENTRAL AND SOUTHERN CALIFORNIA

ATTENTION: The following are the PREVAILING hourly rates of compensation being paid and in effect by employers by agreement between employers and their union; or as recognized and determined by the U. S. Department of Labor. (Revised to March 1, 1951.)

CRAFT	NORTHERN CALIFORNIA										CENTRAL CALIFORNIA			SOUTHERN CALIFORNIA		
	San Francisco	Alameda	Contra Costa	Fresno	Sacramento	San Joaquin	Santa Clara	Solano	Los Angeles	San Bernardino	San Diego	Santa Barbara	Kern			
ASBESTOS WORKERS	\$2.50	\$2.50	\$2.50	\$2.50	\$2.50	\$2.50	\$2.50	\$2.50	\$2.25	\$2.25	\$2.25	\$2.25	\$2.25			
BOILERMAKERS	2.53	2.53	2.53	2.53	2.53	2.53	2.53	2.53	2.25	2.25	2.25	2.25	2.25			
BRICKLAYERS	3.25**	3.15*	3.15	2.85	3.25	3.00	3.00	3.25	2.625	2.625	2.625	2.625	2.625			
BRICKLAYERS, HODCARRIERS	2.45	2.45	2.45	2.00	2.40	2.25	2.375	2.40	2.20	2.20	2.20	2.20	2.20			
CARPENTERS	2.325	2.325	2.175	2.175	2.175	2.175	2.175	2.175	2.28	2.28	2.28	2.28	2.28			
CEMENT FINISHERS	2.20	2.20	2.20	2.20	2.20	2.20	2.20	2.20	2.50	2.50	2.50	2.50	2.50			
ELECTRICIANS	2.75	2.40	2.40	2.75	2.50	2.50	2.625	2.60	2.25	2.25	2.25	2.25	2.25			
ELEVATOR CONSTRUCTORS	2.75	2.75	2.75	2.75	2.75	2.75	2.75	2.75	2.25	2.25	2.25	2.25	2.25			
ENGINEERS: MATERIAL HOIST	2.19	2.19	2.19	2.19	2.19	2.19	2.19	2.19	1.9875	1.9875	1.9875	1.9875	1.9875			
GLAZIERS	2.30	2.30	2.30	2.30	2.30	2.30	2.30	2.30	2.30	2.30	2.30	2.30	2.30			
IRONWORKERS: ORNAMENTAL	2.425	2.425	2.425	2.425	2.425	2.425	2.425	2.425	2.255	2.255	2.255	2.255	2.255			
REINF. RODMEN	2.375	2.375	2.375	2.375	2.375	2.375	2.375	2.375	2.28	2.28	2.28	2.28	2.28			
STRUCTURAL CONCRETE	2.575	2.575	2.575	2.575	2.575	2.575	2.575	2.575	2.30	2.30	2.375	2.30	2.30			
LABORERS: BUILDING	1.65	1.65	1.65	1.55	1.65	1.65	1.65	1.65	1.65	1.65	1.65	1.65	1.65			
LATHERS	1.65	1.65	1.65	1.55	1.65	1.65	1.65	1.65	1.65	1.65	1.65	1.65	1.65			
MARBLE SETTERS	3.00	3.00*	3.00*	2.75	2.875	2.75	3.00	2.8125	2.50	2.50	2.50	2.50	2.50			
MOSAIC & TERRAZZO	2.375	2.375	2.375	2.375	2.375	2.375	2.375	2.375	2.40	2.40	2.40	2.40	2.40			
PAINTERS	2.45**	2.45	2.45	2.15	2.45	2.275	2.45	2.45	2.72	2.72	2.72	2.72	2.72			
PILEDRIVERS	2.325	2.325	2.325	2.325	2.325	2.325	2.325	2.325	2.33	2.33	2.33	2.33	2.33			
PLASTERERS	3.00	3.15**	3.15	2.75	3.00	3.00	3.125	3.00*	2.50	2.75	2.50	2.50	2.50			
PLASTERERS, HODCARRIERS	2.60	2.80	2.80	2.50	2.40	2.50	2.75	2.50	2.15	2.25	2.30	2.00	2.00			
PLUMBERS	2.425	2.625	2.625	2.425	2.625	2.625	2.625	2.625	2.50	2.50	2.50	2.50	2.50			
ROOFERS	2.50	2.50	2.50	2.50	2.375	2.50	2.50	2.50	2.25	2.00	1.90	2.00	2.00			
SHEET METAL WORKERS	2.3125	2.3125	2.3125	2.40	2.50	2.375	2.3125	2.375	2.15	2.15	2.175	2.00	2.15			
SPRINKLER FITTERS	2.625	2.625	2.625	2.625	2.625	2.625	2.625	2.625	2.25	2.25	2.25	2.25	2.25			
STEAMFITTERS	2.675	2.675	2.675	2.625	2.625	2.625	2.625	2.625	2.50	2.50	2.50	2.50	2.50			
TRUCK DRIVERS—1/2 Ton or less	1.58	1.58	1.58	1.58	1.58	1.58	1.58	1.58	1.58	1.58	1.58	1.58	1.58			
TILESETTERS	2.875	2.875	2.875	2.50	2.875	2.425	2.875	2.875	2.50	2.50	2.70	2.50	2.25			

\* 4 Hour Day. \*\* 7 Hour Day.

Prepared and compiled by:

CENTRAL CALIFORNIA CHAPTER, ASSOCIATED GENERAL CONTRACTORS OF AMERICA, with the assistance and cooperation of secretaries of General Contractors Associations and Builders Exchanges of Northern California; and the above information for southern California is furnished by the Labor Relations Department of the Southern California Chapter, ASSOCIATED GENERAL CONTRACTORS OF AMERICA.



## CONTRACTORS' COSTS

(From Page 38)

contractor to recoup the original investment in his equipment, which, in a small degree, will merely offset the hazards involved in the general contractor's operation.

3. That section 3475 of the Internal Revenue Code with reference to transportation of property tax be amended as follows:

The tax imposed under this section shall not apply to the use of motor vehicles by contractors in the movement of earth, rock, or other excavated material within the boundaries of or incidental to a construction project.

The purpose of this amendment is to bring to an end the confusion that now exists throughout the

highway and heavy divisions of the general contracting industry. It likewise would permit uniformity with reference to administrative rulings and would eliminate conflicting court decisions. An example of how confused this situation is reflected in an administrative ruling with reference to the movement of excavated material. Under this ruling the general contractor is permitted to use a bulldozer to push the excavated material to the desired location without being subject to the transportation of property tax. However, if a power shovel is used to pick up the excavated material and deposit it in an owner-trucker's truck and the truck then dumps the material in the same location where it was pushed by the bulldozer, it is ruled to be transportation of property and subject to tax.

TABLE I

Married Couple with no dependents:

Net Income	Amount of Tax		Taxpayer allowed to keep New Bill
	Present Law	Proposed New Bill	
25,000	6,724	7,565	17,435
50,000	19,592	22,041	27,959
100,000	52,776	59,373	40,627
500,000	403,548	433,161	66,839
1,000,000	858,548	900,000	100,000

TABLE II

Corporation subject only to combined normal tax and surtax:

Net Income subject to normal tax and surtax	Amount of Tax			Taxpayer would be permitted to keep
	Pre-1950	Present	Proposed	
25,000	5,750	6,250	7,500	17,500
50,000	19,000	18,000	20,500	29,500
100,000	38,000	41,500	46,500	53,500
200,000	76,000	88,500	98,500	101,500
500,000	190,000	229,500	254,500	245,500
1,000,000	380,000	464,500	514,500	485,500

TABLE III

Corporation subject to ceiling rate:

Net Income subject to ceiling rate	Amount of Tax			Taxpayer would be permitted to keep
	Pre-1950 Subject only to normal tax	Present 62%	Proposed 70%	
1st 25,000	9,500	15,500	17,500	17,500
Next 25,000	19,000	31,000	35,000	7,500
" 50,000	38,000	62,000	70,000	15,000
" 100,000	76,000	124,000	140,000	30,000
" 200,000	190,000	310,000	350,000	60,000
" 500,000	380,000	620,000	700,000	150,000
" 1,000,000				300,000

# CLASSIFIED ADVERTISING

RATE: 20c PER WORD . . . CASH WITH ORDER

MINIMUM \$5.00

**PLANNING CHURCH BUILDINGS.** Portfolio—64 oversized pages 144 cuts; floor plans, exterior and interior views; recently planned buildings costing \$30,000 upward. Largest collection plans of Protestant churches assembled. Price \$2.00 p.p. WRITE Bureau of Architecture, 300 Fourth Ave., New York 10, N. Y.

**BUILDERS!** You can make more money; get information you need before it is published elsewhere; Subscribe to the daily ARCHITECTS REPORTS, only \$10.00 per month. Complete information from ARCHITECTS REPORTS, 68 Post Street, San Francisco. Phone DOuglas 2-8311.

**WANTED:** Experienced specification writer and building estimator by San Francisco ARCHITECT. Write WE 1-6.c/o ARCHITECT & ENGINEER, 68 Post Street, S. F.

**GET THE BEST,** don't be satisfied with anything but the best. Window sash, Doors, Cabinets, etc. Town Talk Sash & Door Mill, 524 9th St., Sacramento.

**PHOTOGRAPHY.** For the best in construction photography, including exterior and interior, aerial, and progress views . . . you will find as many others have that it's the SKELTON STUDIO'S, 137 Harlan Place, San Francisco, Telephone YUKon 6-6321.

**FLOOR COVERINGS** for industrial, commercial, and residential construction. Complete lines, one of the oldest, best established organizations in the Sacramento Valley. LATTIN'S, INC., 1519 Alhambra Blvd., Sacramento.

## CONSTRUCTION CONTRACTS AWARDED AND MISCELLANEOUS PERSONNEL DATA

**GRAMMAR SCHOOL ADDITION**, Pacheco, Contra Costa County. Mr. Diablo Unified School District, owner. 2 classrooms, kindergarten, administration, toilet room, \$134,000. ARCHITECT: Reynolds & Chamberlain, Anderson & Simonds, Conter & Willis & John Lyon Peid, Oakland. GENERAL CONTRACTOR: Hancock Construction Co., Lafayette.

**BANK BUILDING**, San Jose, Santa Clara County. Ibernia Bank, owner; \$418,000. ARCHITECT: Hertzka & Knowles, San Francisco. 1 story, basement and mezzanine, reinforced concrete construction. GENERAL CONTRACTOR: Jacks & Irvine, San Francisco.

**WAREHOUSE**, Hayward, Alameda County. John C. Varni, owner; \$90,000. STRUCTURAL ENGINEER: H. M. O'Neil Co., Oakland. 1 story, 144 x 150, brick walls, wood roof. GENERAL CONTRACTOR: E. Fleener, Oakland.

**NEW HIGH SCHOOL BUILDING**, Vacaville, Solano County. Vacaville Union High School District, owner. 7 classrooms, administration, 2 science labs, 2 home economics rooms, 2 commercial rooms, gym locker, art rooms, agriculture, shop, library and toilet rooms, \$743,770. ARCHITECT: Leonard F. Starks, Sacramento. 1 story, 39,300 sq. ft., frame and stucco construction. GENERAL CONTRACTOR: Pacific Co., Oakland.

**GYMNASIUM BUILDING**, Rio Bravo, Kern County. Rio Bravo Elementary School District, owner; \$323,869. ARCHITECT: Metcalf & Persons, Bakersfield. 1 story, 15,000 sq. ft., reinforced concrete and structural steel roof trusses. GENERAL CONTRACTOR: Guy E. Hall, Bakersfield.

**TURKEY EVISCERATING PLANT**, Modesto, Stanislaus County. Turkey Growers Association, owner; \$80,000. ARCHITECT: G. N. Hilburn, Modesto. 1 story concrete block construction, plastered interior, plumbing and electrical work, refrigeration equipment. GENERAL CONTRACTOR: Wieland Bros., Modesto.

**NEW GRAMMAR SCHOOL**, Terra Bella, Tulare County. Terra Bella Unified Elementary School District, owner. 9 classrooms, \$321,400. ARCHITECT: Horn & Mortland, Fresno. Frame and stucco construction. GENERAL CONTRACTOR: John H. Deeter, Bakersfield.

**SHOPPING CENTER**, Los Altos, Santa Clara County. Los Altos Rancho Wilder Co., owner; \$200,000. ARCHITECT: Lawrence

W. Gentry, Los Altos. Frame construction, redwood and brick veneer exterior. GENERAL CONTRACTOR: The Wilder Co., Los Altos.

**AUTO SALES & SERVICE BUILDING**, San Francisco. Deas Motor Co., owner; \$165,350. ARCHITECT: Hertzka & Knowles, San Francisco. 1 story, reinforced concrete construction. GENERAL CONTRACTOR: Jacks & Irvine, San Francisco.

**NEW GRAMMAR SCHOOL**, Graton, Sonoma County. Oak Grove Elementary School District, owner. 3 classrooms, administration, kitchen, kindergarten, multi-purpose, toilet rooms, \$271,000. ARCHITECT: J. Clarence Felciano, Santa Rosa. Frame and stucco construction. GENERAL CONTRACTOR: C. S. Phillips, Petaluma.

**GRAMMAR SCHOOL**, Penngrove, Sonoma County. Liberty Elementary School District, owner. 3 classrooms, toilet room, \$75,412. ARCHITECT: C. A. Coulkins, Santa Rosa. Frame and stucco construction. GENERAL CONTRACTOR: Walter L. Olson.

**NEW McCLYMONDS HIGH SCHOOL**, Oakland, Alameda County. Oakland Board of Education, owner. 42 classrooms, administration, science room, auditorium, cafeteria, library, shops, remodel gymnasium, \$2,564,370. ARCHITECT: W. G. Carlett & A. W. Anderson, Oakland. 1, 2 and 3 story, reinforced concrete construction. Some structural steel, steel and wood sash, asphalt tile and linoleum floors, 162,000 sq. ft. GENERAL CONTRACTOR: John E. Branagh & Son, Piedmont.

**SOUTH PRIMARY ADDITION**, Corcoran, Kings County. Corcoran Elementary School District, owner. 2 kindergarten, 10 classrooms, administration, cafeteria, \$574,766. ARCHITECT: H. L. Gogerty, Los Angeles. Frame and stucco construction. GENERAL CONTRACTOR: R. Pederson & Sons, Fresno.

**STORE BUILDING**, San Francisco. Stoneson Development Corp., owner; \$464,000. ARCHITECT: Wilton Beckett & Assoc., Los Angeles. 2 story, class 3, reinforced concrete and frame construction. GENERAL CONTRACTOR: McDonald, Young & Nelson, San Francisco.

**ELEMENTARY SCHOOL ADDITION**, Woodville, Tulare County. Woodville Elementary School District, owner. Classrooms, toilet rooms; \$225,194. ARCHITECT: Robert C. Kaestner, Visalia. Frame and stucco construction. GENERAL CONTRACTOR: David Chamberlin, Forterville.

**NEW FRANK A. HOMAN SCHOOL**, Fresno, Fresno County. Fresno Board of Education, owner. 12 classrooms, kitchen, 2 kindergartens, administration, all-purpose, toilet rooms, stage, \$367,614. ARCHITECT: Walter Wagner, Fresno. Frame and stucco construction. GENERAL CONTRACTOR: Larson-Ratte Construction Co., Fresno.

**NEW GIRLS COLLEGE BUILDING**, Belmont, San Mateo County. College of Notre Dame, owner; \$703,595. ARCHITECT: Vincent R. Raney, San Francisco. 1 and 2 story, frame and stucco construction, consists of administration, classrooms, cafeteria, kitchen and dormitories. GENERAL CONTRACTOR: Carrico & Gaultier, San Francisco.

**HOSPITAL ADDITION**, Burbank, Los Angeles County. Sisters of Charity of the House of Providence, owner; 5 story and basement, structural steel and masonry, \$1,500,000. ARCHITECT: John W. Maloney,

Seattle; steel roof trusses, built-up roofing, reinforcing steel, steel sash, plate glass, concrete and terrazzo floors, asphalt tile flooring, fire doors, air conditioning and elevators. GENERAL CONTRACTOR: Pozzo Construction Co., Los Angeles.

**GARAGE AND STORE BUILDING**, Phoenix, Arizona. City of Phoenix, owner; \$2,588,000. ARCHITECT: Milton Anderson, Los Angeles; 3 story, reinforced concrete building. GENERAL CONTRACTOR: Del E. Webb Construction Co.

**OFFICE BUILDING**, Los Angeles, Los Angeles County. State of California, owner; \$95,000. ARCHITECT: Stiles & Clements. STRUCTURAL ENGINEER: Ted H. Johnson, Los Angeles; reinforced concrete, 123x151 sq. ft., composition roofing. GENERAL CONTRACTOR: C. W. Driver, Los Angeles. **HOAG MEMORIAL HOSPITAL**, Newport Beach, Orange County. Hoag Memorial Hospital, Presbyterian Church, owner; 75 beds; \$1,096,023. ARCHITECT: Chambers & Hibbard, Los Angeles; 1 story, reinforced concrete. GENERAL CONTRACTOR: Means & Ulrich, Santa Ana.

**CHURCH ADDITION**, Los Altos, Santa Clara County. Christ Episcopal Church, owner; \$49,487. ARCHITECT: Peter Kump, San Francisco. Frame and stucco construction. GENERAL CONTRACTOR: Harris & Fieldheim, Menlo Park.

**MEDICAL BUILDING**, Pomona, Calif. Drs. Fisher & Fisher, owner; 1 story, frame, stucco and concrete wall; \$53,516.33. ARCHITECT: Smith & Williams, Pasadena; 4,300 sq. ft., composition roofing, awning type wood sash, concrete and asphalt tile covered floors, forced air heating, toilets. GENERAL CONTRACTOR: S. R. Magnusen, Pomona.

**SCHOOL BUILDINGS**, Santa Monica, Los Angeles County. Board of Education, Santa Monica; additions to the Roosevelt School; \$179,000. ARCHITECT: Joseph Estep, Santa Monica; frame and stucco construction, cafeteria, assembly room, 2 classrooms, composition roof, concrete slab, asphalt tile and hardwood floors, wood sash, metal toilet partitions, forced air heating. GENERAL CONTRACTOR: Fred S. Macomber, Los Angeles.

**OFFICE BUILDING**, Los Angeles, Los Angeles County. Southern Counties Gas Co., owner; 4 story office building; \$560,000. STRUCTURAL ENGINEER: Donald R. Warren Co., Los Angeles; 34,000 sq. ft. of floor space, reinforced concrete construction, composition roofing, concrete floors, terrazzo and asphalt tile floorings, metal sash steel studs and plaster interior partitions, elevator, air conditioning. GENERAL CONTRACTOR: R. J. Daum Construction Co., Inglewood.

**ADDITIONAL SCHOOL FACILITIES**, Santa Paula, Calif. Santa Paula Elementary School District, owner; 6 classrooms, cafeteria, and administrative unit; \$206,477. ARCHITECT: Roy C. Wilson, Santa Paula; frame and concrete construction, 14,230 sq. ft. GENERAL CONTRACTOR: G. J. Larson, Santa Paula.

**PRINTING PLANT BUILDING**, San Francisco. Louis Rossch Co., owner; \$66,000. ARCHITECT: Francis Loi Chinn, San Francisco; 1 story, reinforced concrete construction, 91x120, some structural steel. GENERAL CONTRACTOR: Elvin C. Stendell, San Francisco.

**GROUP OF ADMINISTRATION, HOSPITAL BUILDING AND SERVICE BUILDINGS**, Atascadero, San Luis Obispo County. State of California, owner; \$7,130,118. STATE ARCHITECT: Anson Boyd, Sacramento; 1 and 2 story, 407,000 sq. ft., reinforced concrete construction, composition roofing, se-

## PANACALITE

The Standard for Perlite Aggregates  
An Engineered Product—Engineering  
Service

Air Classified—Size & Graded for  
Plaster, Concrete & Stucco  
Aggregates

Listed underwriters' Laboratories  
Re-examination Service

Fire Ratings:  
Non-Bearing Walls—2 hours  
Floor and Beam—4 hours  
Column—2 & 3 hours  
Suspended Ceiling—4 hours  
Others

Manufactured by  
**American Perlite Corporation**  
26th & 5th.—Yard 2.—Richmond  
EAcoc 5-1395

curly steel sash, concrete block partitions, some steel frame, metal siding and decking consists of Ward buildings, hospital, etc. GENERAL CONTRACTOR: M & K Corp.; Fredrickson & Watson & Piombo Construction Co., San Francisco.

**MEDICAL BUILDING.** Walnut Creek, Contra Costa County. Dr. R. Foster Marks, owner; 3 suites of offices; \$65,000. PLANS BY: Louis U. McAbee, Walnut Creek; 1 story, concrete block and frame construction. GENERAL CONTRACTOR: Swinerton & Welberg, San Francisco.

**ELEMENTARY SCHOOL.** Fresno, Fresno County. Wolters Elementary School District, owner; \$476,000. ARCHITECT: Wm. Hasprung, Fresno; frame and stucco construction. GENERAL CONTRACTOR: Clarence Ward Construction Co., Fresno.

**STORAGE BUILDING ADDITION.** San Francisco. City Transfer & Storage Co., owner; \$61,598. ARCHITECT: Ward & Bolles, San Francisco; 1 story, reinforced concrete construction. GENERAL CONTRACTOR: Thomas Ellingson, San Francisco.

**GRAMMAR SCHOOL ADDITION.** Auburn, Placer County. Auburn Joint Union Elementary School, owner; kindergarten, multi-purpose, kitchen and toilet rooms; \$199,313. ARCHITECT: Chas. F. Dean, Sacramento; reinforced concrete and frame construction. GENERAL CONTRACTOR: Fred Chapek & Dorville-Golline & Kohler, Sacramento.

**GRAMMAR SCHOOL ADDITION.** Alturas, Modoc County. Alturas Elementary School District, owner; 5 classrooms, multi-purpose, kitchen, music building, and toilet rooms; \$329,500. ARCHITECT: John P. Miller, Fresno; frame and concrete construction. GENERAL CONTRACTOR: B & R Construction Co. & Gibbons & Zick, San Francisco.

**NEW SCHOOL PLANT.** Alta Loma, Los Angeles County. Alta Loma Elementary School District, owner; 8 classrooms, 30x140, \$102,520. ARCHITECT: Frick & Frick, Pasadena; frame and stucco construction, composition roof, wood awning sash, slab and asphalt tile covered floors, forced air heating, ceramic tile floors. GENERAL CONTRACTOR: Ralph C. Day, Arcadia.

**MACHINE SHOP AND STORAGE SHED.** Fresno, Fresno County. Fresno Board of Education, owner; \$68,000. ENGINEER: R. D. Welty, Fresno. GENERAL CONTRACTOR: W. E. Holt, Fresno.

**GARAGE BUILDING.** Oakland, Alameda County. Val Strough Chevrolet Co., owner; \$200,000. ENGINEER: R. A. McGuire and Anderson, Oakland; 2 story, reinforced concrete construction. GENERAL CONTRACTOR: Gruener Construction Co., Oakland.

**HOME FOR THE AGED.** Los Gatos, Santa Clara County. Sacred Heart Novitiate, owner; \$75,000. ARCHITECT: Mario J. Ciampi, San Francisco; 1 story, frame and stucco construction. GENERAL CONTRACTOR: J. C. Monk & Sons, Los Gatos.

**CLINIC BUILDING.** Compton, Los Angeles County. ARCHITECT: Francis J. Heusel, Long Beach; 1 and part 2 story, wood frame, 10,000 sq. ft., stucco and siding exterior, composition roofing, plate glass, wood floors, asphalt tile and linoleum covering, air conditioning; \$97,000. GENERAL CONTRACTOR: Julian Construction Co., Compton.

**ANDREW WILLIAMS MARKET BUILDING.** Redwood City, San Mateo County. Mayfair, lessee; \$200,000. ENGINEER: R. H. Cooley, Oakland; 1 story, 125x165, concrete block and wood roof trusses, plate glass front, asphalt tile floors. GENERAL CONTRACTOR: John J. Moore, Oakland.

**OFFICE BUILDING.** San Francisco. State Board of Harbor Commissioners, owners; \$153,000. CHIEF ENGINEER: Harry E.

Squire, San Francisco; 2 story, reinforced concrete and frame construction, wood sash and doors, metal partitions and doors, gas hot water, heating, plumbing, electric work, acoustical tile. GENERAL CONTRACTOR: Kelley & Peletz, San Francisco.

**SEQUOIA HALL REMODEL.** Palo Alto, Santa Clara County. Stanford University, owner; \$100,000. ARCHITECT: Ambrose & Spencer, San Francisco; remove 2 and 3 story and remodel 1st floor. GENERAL CONTRACTOR: Wagner & Martinez, San Francisco.

**STORE BUILDING.** Antioch, Contra Costa County. Stamm Theatres Inc., owner; \$160,000. ARCHITECT: W. D. Peugh, San Francisco; 1 story, L-shaped, 70x200 and 80x120. Reinforced concrete construction. GENERAL CONTRACTOR: Geo. Stamm, Antioch.

**NEW GRAMMAR SCHOOL.** Tiburon, Marin County. Reed Union Elementary School District, owner; 6 classrooms, offices and toilet rooms; \$116,000. ARCHITECT: John Lyon Reid, San Francisco. GENERAL CONTRACTOR: Herbert A. Crocker Co., San Rafael.

**BAKERY BUILDING.** San Jose, Santa Clara County. Langendorf United Bakeries, owner; \$450,000. ARCHITECT: Donnell E. Joekle, San Jose; 1 story, 98,000 sq. ft., reinforced concrete, structural steel, frame, wood roof, steel sash. GENERAL CONTRACTOR: Lew Jones Construction Co., San Jose.

**SUPER MARKET BUILDING.** Alameda, Alameda County. George A. Sturtevant, owner; \$80,500. ENGINEER: Bryan & Murphy, Berkeley; 1 story and 2 story, 100x155, frame and stucco construction, plate glass and tile front, asphalt tile floor. GENERAL CONTRACTOR: Conrad Roth, Alameda.

**SAKS FIFTH AVENUE STORE REMODEL.** San Francisco. Saks Fifth Avenue, owner; \$500,000. INDUSTRIAL DESIGNERS: Burke, Kober & Nicolais, Los Angeles; 8 story and basement interior remodel and marble exterior. GENERAL CONTRACTOR: Dinwiddie Construction Co., San Francisco.

**CAFETERIA BUILDING.** Hanford, Kings County. Hanford Joint Union High School District, owner; \$210,000. ARCHITECT: Horn & Mortland, Fresno. GENERAL CONTRACTOR: Flowers & Shirely, Tulare.

**DEL PASO SCHOOL ADDITION AND REMODEL.** Del Paso Heights, Sacramento County. Del Paso Heights Elementary School District, owner; 7 classrooms, 2 kindergarten, toilet rooms and alterations; \$274,455; 4 classrooms, administration, multi-purpose, kitchen and toilet; \$161,693. ARCHITECT: Clarence C. Cuff, Sacramento; frame and stucco construction. GENERAL CONTRACTOR: United Construction Co., Sacramento.

**OFFICE AND FACTORY BUILDING.** Pasadena, Los Angeles County. Capitol Company, owner; \$245,900. ARCHITECT AND ENGINEER: Albert C. Martin & Assoc., Los Angeles. GENERAL CONTRACTOR: Wm. C. Crowell, Pasadena.

**CHURCH.** Rivera, Calif. Roman Catholic Archbishop of Los Angeles, owner; \$83,700. CIVIL ENGINEER: Laurence D. Viole, North Hollywood. GENERAL CONTRACTOR: Kemp Bros., Los Angeles.

**GARAGE.** San Francisco. Bothin Real Estate Co., owner; \$125,000. ARCHITECT: Ward & Bolles, San Francisco; reinforced concrete construction. GENERAL CONTRACTOR: Mattock Construction Co.

## All homes—large or small—need extra outlets, concealed wiring

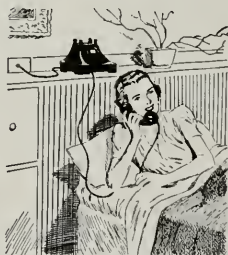

All home owners may want to add extra telephone extensions sometime in the future—in the living room, bedroom, kitchen—wherever they're needed. That's why it's so important to include built-in conduit and outlets in your plans. The cost is small, but the convenience is great.

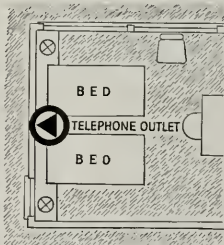

Wires won't be exposed when you install concealed raceways during construction. And your customer's telephone needs will be taken care of—for now and the future. For free help in planning, call your local Pacific Telephone office and ask for "Architects and Builders Service."

Put built-in telephone facilities in your plans



Pacific Telephone



## IN THE NEWS

### ARCHITECT SELECTED FOR ARMY PROJECT

Architect Robert Stanton of Carmel has been chosen by the Corps of Engineers, U. S. Army, to draft plans and specifications for a motor repair shop and several other utility buildings at Fort Ord in Monterey county.

### COTTON COMPRESS BUILDING FRESNO

The Producers Cotton Oil Company of Fresno is starting construction of a new cotton compress and warehouse building.

The one-story, 180 ft. x 1340 ft., reinforced concrete building will cost an estimated \$500,000. Barrett & Hilp, San Francisco, are the contractors.

### ARCHITECT CHOSEN FOR BARRACKS JOB

The architectural firm of Weihe, Frick and Kruse of San Francisco has been selected by the Corps of Engineers, U. S. Army, to draft plans and specifications for the construction of new Barracks Buildings, together with incidental buildings at Fort Ord in Monterey county.

### NEW HOSPITAL FOR SAN FRANCISCO

The Permanente Foundation Hospital in Oakland is completing plans and working drawings for the construction of a 210-bed Permanente Hospital building in San Francisco.

Site of the Hospital is at Geary, O'Farrell,

Lyons & St. Joseph avenue, and the building will comprise a 6-story reinforced concrete building to cost some \$2,300,000.

Wolff & Phillips of Portland, Oregon, are the architects.

### UNITED AIR PLANS

#### BASE IMPROVEMENTS

Officials of the United Air Lines contemplate making considerable improvements at the company's maintenance base at the San Francisco Municipal Airport in the immediate future.

Included in present plans is a 135' x 125' Hangar; a 135' x 150' Overhaul Shop; a 60,000 sq. ft. Warehouse, and additional paving of the plant and shop area covering 60,000 sq. ft.

### NEW HIGH SCHOOL AT SPARKS, NEVADA

The High School District of Sparks, Nevada, are pushing plans for the construction of a new High School comprising a structural steel frame building of reinforced brick walls and concrete floors covered with asphalt tile.

DeLongchamps will exceed \$650,000.

DeLongchamps & O'Brien of Reno are the architects.

### AIR FORCE BASE TO EXPAND

Plans have been announced for the expansion of facilities at the McClellan Air Force Base near Sacramento to include a high horsepower engine testing laboratory.

Cost of the construction is estimated at \$2,117,000.

### VALLEJO HOUSING PROJECT STARTS

E. Teixeira & Sons, builders, have started construction of 75 new residences in the Grantland Meadows and Winslow Terrace districts of Vallejo, California.

The houses will cost about \$8,000 each and will be frame and stucco construction.

### NEW PAPER PLANT FOR SAN LEANDRO

The Crown Zellerbach Corporation of San Francisco will construct a new paper processing plant on West Avenue in San Leandro at a cost of \$2,000,000.

Albert C. Martin & Associates of Los Angeles are the architects and are drafting plans and specifications for a 1-story reinforced concrete and structural steel building which will contain 300,000 sq. ft.

### NEW HOSPITAL FOR EUREKA

The Sisters of St. Joseph, Orange, California, announced recently plans for the construction of a 75-bed St. Joseph's Hospital in Eureka, California.

To cost \$1,250,000 the new hospital will comprise a 4-story reinforced concrete building. Plans and specifications are being prepared by Frank T. Georgeson, architect of Stockton.

### HAUSERMAN COMPANY IN NEW S. F. OFFICES

The E. F. Hauserman Company of Cleveland, Ohio, have opened offices at 31 Geary Street, San Francisco, according to a recent announcement.

### NAMED TO BOARD OF PRODUCERS COUNCIL

Fred M. Hauserman, president of the E. F. Hauserman Company, Cleveland, Ohio, has been elected to the executive committee of the Producers' Council, Inc. He has

been a member of the Council's board of directors since 1949.

The Producers' Council, with headquarters in Washington, D. C., is an association of manufacturers of building products and is affiliated with the American Institute of Architects.

### NEW AIRPORT BUILDING AT WILLOWS CALIFORNIA

The Board of Supervisors of Glenn county have approved funds for the construction of a new administration building at the Willows Airport.

The building of frame and stucco construction is being designed by architect Albert W. Kohl of San Mateo.

### GLENN ANNE DAM BIDS CALLED BY BUREAU

The Bureau of Reclamation engineering center in Denver, Colorado, has called for bids for the construction of the Glenn Anne Dam in Santa Barbara county, California, a unit of the Cochuma Project.

Situated four miles northwest of the town of Goleta the Dam will be 250 ft. long and 102 ft. high and will contain some 500 acre-feet.

### ARCHITECT CHOSEN FOR NEW CHURCH

Architect Arnold S. Constable of Sausalito (California) has been selected by the Lutheran Church to draft plans and specifications for the construction of a new church building in the Talmalpais Valley area of Marin county.

### SOLAR HOUSES IN COLORADO

A 3000 home housing development is underway in Colorado Springs featuring a new "solar house" and sponsored by Howard M. Sloan of Chicago and E. W. Hayes of Colorado Springs.

### PILOT PLANT AT BOULDER CITY

The F. C. Torkelson Company of Salt Lake City is building a \$600,000 manganese pilot plant at Boulder City, according to J. F. East, Jr., regional director of the U. A. Bureau of Mines in Denver.

The plant will demonstrate processes for treating ore from Artillery Peak, Arizona, and other large low grade manganese deposits. It will have a capacity of 50 tons per day.

### KANSAS CITY PLANT MOVING TO TUCSON

Howard Plastics, Inc., is moving its Kansas City plant to Tucson, Arizona. T. W. Keller, company president stated recently.

The firm manufactures plastic bags for fresh and frozen fruits and vegetables.

### NEW ENGINEERING FIRM ESTABLISHED

G. E. Spurling, Phoenix civil engineer, recently announced the opening of his new firm, the Spurling Engineering Company.

The firm will specialize in laying out subdivision designs and plats, property surveys, and the making of plans and specifications for utilities and street improvements.

### CHEWING GUM PLANT FOR SANTA CRUZ

The William Wrigley, Jr., Company of Chicago, is completing plans for the construction of a new Chewing Gum Factory at Santa Cruz, California.

The plant, to cost \$1,250,000, will consist of 1 and 2-story buildings of reinforced

## ACOUSTI CELOTEX

Sound Conditioning  
... combines the  
correct materials and  
25 years experience  
in every type, size  
and technique of  
acoustical installation

Acoustical Contractors

## WESTERN ASBESTOS COMPANY

San Francisco: 675 Townsend, KL2-3868  
Oakland: 251 Fifth Avenue, GL 1-2945  
Sacramento: 1224 Eye Street, GI 2-8991  
Stockton: 733 So. Van Buren St., 4-1863  
Fresno: 434 "P" Street, 2-1600  
San Jose: 460 Park Avenue, CY 3-1317



## MULLEN MFG. COMPANY

BANK, STORE AND OFFICE  
FIXTURES—CABINET WORK  
OF GUARANTEED QUALITY  
CHURCH SEATING

Office and Factory  
46-80 RAUSCH ST., Bet. 7th and 8th Sts.  
San Francisco  
Telephone UNDERhill 1-5815

### Thinking of Building?

From our cost records and experience, an advance estimate may be made from decidedly general information. Based on our knowledge of labor and material costs, gained on current jobs, such an estimate may be helpful in determining your construction program.

ALL TYPES CONSTRUCTION  
SAN FRANCISCO - SACRAMENTO

SWINERTON & WALBERG CO.  
OAKLAND - LOS ANGELES - DENVER

STATIONERY  
SCHOOL & OFFICE  
SUPPLIES

Printing Engraving  
Announcements

CENTER STATIONERY  
468 McAllister

San Francisco UN 1-3703

*Fine*  
**ENGRAVINGS**



**POOR  
RICHARD**  
PHOTO ENGRAVING CO.  
322-324 COMMERCIAL STREET  
SAN FRANCISCO, CALIF.

concrete and structural steel and will contain 147,000 sq. ft.

Victor L. Charm of Chicago is the architect, with Nelsan P. Rice of Los Angeles serving as associate architect in direct supervision of the work.

### MAYNARD N. FRANKLIN ASSOCIATED WITH SMITH

Maynard N. Franklin has been named vice president of the newly organized firm of Smith-Franklin Co., Inc., according to an announcement by H. C. Smith, president of the firm and previously head of the H. C. Smith Company.

The Company maintains headquarters in Los Angeles and specializes in engineering, and industrial and commercial construction. At present they are engaged in a number of large projects in Southern California.

### NEW BUILT-IN KITCHEN PRODUCT

Made with adjustable sleeves to fit various wall thicknesses, a new Built-In Kitchen Ventilator has been announced by the Lig Electric Ventilating Company, Chicago, Illinois.



The new model LC10 delivers 500 C.F.M. capacity and has many features including a grille held in place by a thumb screw for ease in cleaning; one piece outside and inside sleeves of steel; door of steel with oversized hinge; and wide flange on outside sleeve for easy weather-tight installation. Specifications, ratings and dimensional drawings are available.

### APPOINTED WEST COAST MANAGER

Harry W. Hughes has been appointed new West Coast Manager of the Brainerd Steel Company with offices in San Francisco.

The new offices and plant facilities will serve California, Oregon, Washington, Arizona, and Nevada.

Hughes, an engineering officer in the U. S. Navy during World War II, comes to the Coast from Dearborn, Michigan.

### THOMPSON REELECTED PRESIDENT GLASS GROUP

Harry I. Thompson, president of the Thompson Glass & Paint Co., Los Angeles, has been renamed president of the Flat Glass Jobbers Association at their annual meeting in San Francisco.

He was chosen to head the organization which comprises some 350 flat glass jobbers from all parts of the nation, following a year in which "there have been tremendous changes in our industry" and during which time he served as president.

### SKYSCRAPER FOR ARMY

A 252-unit, 22 story, twin towers apartment is under construction for the U. S. Army in Chicago.

## DINWIDDIE CONSTRUCTION COMPANY

•  
**BUILDERS**  
•

CROCKER BUILDING  
SAN FRANCISCO



**HERRICK  
IRON WORKS**  
STRUCTURAL STEEL  
REINFORCING STEEL

18TH AND CAMPBELL STS.  
OAKLAND, CALIF.  
Phone Glencourt 1-1747

Phone GARfield 1-1144

**Thomas B. Hunter**  
DESIGNER OF HEATING

AIR CONDITIONING  
VENTILATING AND WIRING  
SYSTEMS, MECHANICAL  
AND ELECTRICAL EQUIP-  
MENT OF BUILDINGS

★  
41 SUTTER STREET  
ROOM 710

San Francisco California

Subscribe  
Now —

**ARCHITECT  
and  
ENGINEER**

\$3.00  
Per Year

**MATTOCK  
CONSTRUCTION  
COMPANY**

★  
**BUILDERS**

★  
604 MISSION STREET  
SAN FRANCISCO

Subscribe  
Now —

**ARCHITECT  
and  
ENGINEER**

\$3.00  
Per Year

**STOLTE INC.**

*General Contractors*



**OAKLAND • CALIFORNIA**

**PITTSBURGH  
TESTING LABORATORY**

**ENGINEERS AND CHEMISTS**

Testing and Inspection of Concrete,  
Steel and Other Structural Materials

Design of Concrete Mixes

Offices in all principal cities

651 Howard St., San Francisco 5  
EXbrook 2-1747

**Index to Advertisers**

AMERICAN Perlite Corp.....	44
ANGER Pacific Corp.....	35
ARCHITECTS Reports .....	38
BARRETT & HILP, Contractors.....	35
CLASSIFIED Advertising .....	43
CENTER Stationery .....	47
CLAY Brick & Tile Association.....	1
CLINTON Construction Company.....	36
DINWIDDIE Construction Co.....	47
ELECTROMODE Corpn. ....	*
FULLER, W. P. Co.....Inside Front Cover	
FORDERER Carnice Works.....	35
GLADDING McBean & Company.....	*
GREENBERG'S, M. Sans.....	*
HANKS, Inc., Abbott A.....	48
HAWS Drinking Faucet Co.....	28-29
HERRICK Iron Works.....	47
HILLYARD Chemical Co.....	*
HOGAN Lumber Co.....	36
HUNT, Robert W., Company.....	48
HUNTER, Thos. B.....	47
JOHNSON, S. T. Co.....	*
JUDSON, Pacific-Murphy Corp.....	36
KRAFTLE Company .....	26
MARBLE Institute of America.....	2
MATTOCK Construction Co.....	48
MICHEL & Pfeiffer Iron Works.....	*
MULLEN Mfg. Co.....	47
PACIFIC Clay Products Co.....	*
PACIFIC Manufacturing Company.....	37
PACIFIC Portland Cement Company .....	Back Cover
PACIFIC Telephone & Telegraph Co.	45
PARKER, Steffens & Pearce.....	35
PITTSBURGH Testing Laboratory.....	48
POOR Richard Engraving Co.....	47
PORCELAIN Enamel (Architectural Division) Publicity Bureau.....	5
REMILLARD-Dandini Co. ....	48
REPUBLIC Steel Corporation.....	37
SCOTT Co. ....	48
SIMONDS Machinery Company.....	37
SISALKRAFT Company .....	36
SMOOT-Holman Company .....	33
SOTO, Henry C., Corpn., Landscape Engineers .....	33
STANLEY Works, The.....	32
STOLTE, Inc. ....	7 & 48
SUPERIOR Fireplace Co. ....	*
SWINERTON & Walberg Co.....	47
U. S. Bonds .....	6
UTILITY Appliances Corp'n.....	34
VERMONT Marble Company.....	37
WEST Coast Screen Co.....	31
WESTERN Asbestos Company.....	46

\*Indicates Alternate Months

**ABBOT A. HANKS, INC.  
Engineers & Chemists**

INSPECTING — TESTING — CONSULTING  
CONCRETE — STEEL — MATERIALS  
CHEMICAL AND TESTING  
LABORATORIES  
• RESEARCH AND INVESTIGATION •

—  
TESTS OF STRUCTURAL MATERIALS  
DESIGN OF CONCRETE MIXES  
SHOP AND ERECTION INSPECTION OF  
STRUCTURES AND EQUIPMENT  
INVESTIGATION OF STRUCTURES  
AND MATERIALS  
TESTS AND INVESTIGATION OF  
FOUNDATION SOILS  
FIRE RESISTANCE AND INSULATION  
TESTS

—  
624 Sacramento Street, San Francisco

**ROBERT W. HUNT CO.**

**ENGINEERS  
INSPECTING TESTING**

**STRUCTURAL MATERIALS  
CONCRETE MIX DESIGN  
CHEMICAL ANALYSIS  
EQUIPMENT**

PRINCIPAL CITIES  
UNITED STATES • EUROPE  
SAN FRANCISCO LOS ANGELES  
PORTLAND SEATTLE

**REMILLARD-DANDINI Co.**

**Brick and  
Masonry Products**

★

400 MONTGOMERY STREET  
SAN FRANCISCO, CALIF.

**Scott Company**

**HEATING • PLUMBING  
REFRIGERATION**

★

San Francisco  
Oakland  
San Jose  
Los Angeles

# ARCHITECT AND ENGINEER

RANCH TYPE HOME . . . MR. & MRS. W. F. SANFORD, Los Altos, California



ROBERT S. KITCHEN and FRANK B. HUNT, Architects

**OCTOBER**

**1951**

# How Colorful Clay Brick *Enhances* School Architecture

An excellent example of modern school architecture utilizing Clay Brick is the Antioch, California High School. Ernest J. Kump, A. I. A., Architect. Wallace D. Harkins, Contractor.

Clay Brick's color and texture give this classroom warmth and interest.



PHOTOS BY ROGER STURTEVANT



*Inside or Outside*  
**A CLAY BRICK WALL  
BEST FINISH OF ALL**

**WARM, FRIENDLY COLOR**—Clay Brick's built-in color and texture make it a top choice in building materials wherever economy and beauty must be combined.

**MAINTENANCE COST... ZERO**—Clay Brick walls never need painting or refinishing. Unlike most materials that need periodic refurbishing, Clay Brick's texture and color become more appealing with the years.

**IMMUNITY TO VANDALISM**—Clay Brick walls have a rugged surface that even school children, careless and rough as they are, find difficult to mar.

**FLEXIBILITY**—Clay Brick's small modular scale makes it easy to combine effectively with other construction materials.

## **CLAY BRICK & TILE ASSOCIATION**

OF NORTHERN CALIFORNIA

55 NEW MONTGOMERY STREET • SAN FRANCISCO

Kraftile Company  
Remillard Dandini

L. P. McNear Brick Co.  
San Jose Brick & Tile

Port Costa Brick Works  
Stockton Brick & Tile Co.

United Materials & Richmond Brick Company



# ARCHITECT

Vol. 187

No. 1

# AND ENGINEER

ARCHITECTS' REPORTS—Published Daily

EDWIN H. WILDER

Editor

MARK DANIELS, A.I.A.

Associate Editor

J. WELLS HASTINGS

Contributing Editor

PROF. LELAND VAUGHAN

Landscape Architecture

JOHN A. BLUME

Structural Engineering

MICHAEL GOODMAN

Planning

JOHN S. BOLLES, A.I.A.

Book Reviews



## COVER PICTURE

### RANCH TYPE HOME

Los Altos,  
California

In the design of this two bedroom, "ranch-type" home for Mr. and Mrs. W. F. Sanford at Los Altos, California, Architects Robert S. Kitchen and Frank B. Hunt have captured the full opportunities of a home in an atmosphere of typical, western, out-door living.

For details, floor plan and additional pictures, see Page 10.

ARCHITECT & ENGINEER  
is indexed regularly by  
ENGINEERING INDEX, INC.

## Contents for

# OCTOBER

EDITORIAL NOTES	2
JOINT INFORMATION COMMITTEE American Institute of Architects and The Producers Councils, Inc.	6
CIVIL DEFENSE ORDINANCE PROVIDES BOMB SHELTERS FOR CITY OF LOS ANGELES	9
RANCH TYPE HOUSE, Los Altos, California Designed for Mr. and Mrs. W. F. Sanford ROBERT S. KITCHEN and FRANK B. HUNT, Architects. By MARCIA LEE	10
EVOLUTION OF THE STRENGTHENED CORE "DESIGN" FOR BLAST RESISTANT BUILDINGS By ELLERY HUSTED & G. L. SCHUYLER, Washington, D. C.	16
INTERNATIONAL MINERALS & CHEMICAL CORPORATION, San Francisco FRANCIS JOSEPH McCARTHY, A.I.A., Architect; OSCAR PRESCO & SONS, Builder; ECKBO, ROYSTON & WILLIAMS, Landscape Architects	18
AIR CONDITIONING Principles and Objectives (Part II) By H. L. WOLLMAN, Research Engineer	22
A.I.A. ACTIVITIES	26
WITH THE ENGINEERS	28
PRODUCERS COUNCIL PAGE Edited by CARL B. FRANK, Detroit Steel Products	30
BOOK REVIEWS, Pamphlets and Catalogues	36
ESTIMATOR'S GUIDE, Building and Construction Materials	39
ESTIMATOR'S DIRECTORY, Building and Construction Materials	41
BUILDING TRADES WAGE SCALES, Northern, Central & Southern California	42
CLASSIFIED ADVERTISING	43
CONSTRUCTION CONTRACTS AWARDED, General Data	44
IN THE NEWS	46
INDEX TO ADVERTISERS	48

ARCHITECT AND ENGINEER (Established 1905) is published on the 15th of the month by The Architect and Engineer, Inc., 68 Post St., San Francisco 4; Telephone EXbrook 2-7182. President, K. P. Kierulff; Vice-President and Manager, L. B. Penhorwood; Treasurer, E. N. Kierulff.

Los Angeles Office: Wentworth F. Green, 439 So. Western Ave., Los Angeles 5; Telephone DUnkirk 7-8135.

Entered as second class matter, November 2, 1905, at the Post Office in San Francisco, California, under the Act of March 3, 1879. Subscriptions United States and Pan America, \$3.00 a year; \$5.00 two years; foreign countries \$5.00 a year; single copy 50c. ARCHITECTS' REPORTS are published daily from this office, Vernon S. Yallop, Manager, Telephone DOuglas 2-8311.



# EDITORIAL NOTES

## OVER SPENDING

Whenever a reduction in any part of a governmental budget is suggested, someone will quickly arise to claim that great damage to the city, state or nation will result.

It should be quite clear, however, that the costs of not reducing a budget wherever possible will result in a greater use of civilian output by government, and the more the government takes the less we shall have for use in our homes and businesses.

A man can work either on a government public works project or a private home building project; he can not do both at the same time. The more manpower, materials and productive capacity the government uses, the less we shall be able to use privately.

In fact the net cost will be more than the shift of output from private to government use. For if we fail to economize in government spending, we shall have higher taxes, which will retard total production, or more inflation, with all its evil consequences.

\* \* \*

*More than 50,000 new homes have been started in the Dallas, Texas, Metropolitan area since the end of World War II.*

## LIVING SIMPLIFIED

A few generations ago it was a common thing for a family to consist of "father", "mother" and

six, eight, ten or more children, and in many communities throughout the nation, there were great "mansions" erected containing considerably more living space than was actually required by the tenant.

The nation's economy at the time was such that large families could be maintained and provided for within the earnings of the "head of the house", and domestic labor for maintenance and conduct of the mansion was easily available from the labor market.

Both of these factors have taken considerable adjustments in the past few years.

The average family of today is less than four persons, with both the "father" and the "mother" and sometimes other members of the family, working together to develop a sufficient family income to meet present economic conditions. The dwindling supply of domestic labor and high maintenance costs precludes the possibilities of keeping a mansion in operation.

The result has been a decided "trend" in American architecture towards smaller houses containing a maximum of labor saving devices. Architects of today are being called upon to design homes of simplified living.

\* \* \*

*The general contracting industry now has the skill and capacity to handle all essential construction with speed and efficiency.*

## THE BIG RED FEATHER

October is RED FEATHER month in cities and towns all over America united RED FEATHER campaigns are in full swing. That is traditional . . . it happens every year.

But this year there is a difference. The RED FEATHER is a bigger RED FEATHER. Symbol of more than 15,000 health, recreation, and welfare services that combine their annual appeals once a year in more than 1300 local Community Chest campaigns, the RED FEATHER this year has an added assignment: the United Defense Fund.

Our mobilization for the defense of democracy demands efficiency, economy, and wise planning in health and welfare services just

as it does in industry. The United Defense Fund answers that demand, for it finances the combined strength and know-how of national health, recreation and welfare agencies working together to meet the human problems growing out of the national emergency.

Included in the United Defense Fund are: United Service Organizations, Inc., (U.S.O.); American Social Hygiene Assn.; National Recreation Assn. (emergency defense program); United Community Defense Services; American Relief for Korea (clothing, blankets and sewing materials).

When you contribute with generosity to your local united RED FEATHER campaign, you are helping to strengthen and defend our democracy.



# Medal of Honor



Lieutenant Frederick Henry of Clinton, Oklahoma—Medal of Honor for sacrificing himself to save his platoon in combat near Am-Dong, Korea, September 1, 1950. When the platoon could no longer hold its position, Lieutenant Henry ordered the men to pull back. But someone had to stay behind to provide covering fire. He chose to be that man, and was lost.

Always remember this—Lieutenant Henry offered his life for more than just a small platoon in far-away Korea. It was also for America. For you.

Isn't there something you can do when this man did so much? Yes, there is. You can help keep the land he loved solid and strong and secure. You can do a job for defense . . . by buying United States Defense\* Bonds, *now!* For your bonds give your country greater strength. And a strong America is your best hope for peace and freedom—just as it was his.

Defense is your job, too. For the sake of *every* man in service, and for *yours*, start buying more United States Defense Bonds now.

Remember that when you're buying bonds for national defense, you're also building a personal reserve of cash savings. Remember, too, that if you don't save *regularly*, you generally don't save at all. Money you take

home usually is money spent. So sign up today in the Payroll Savings Plan where you work, or the Bond-A-Month Plan where you bank. For your country's security, and your own, buy U. S. Defense Bonds now!

***\*U.S. Savings Bonds are Defense Bonds - Buy them regularly!***

The U. S. Government does not pay for this advertisement. It is donated by this publication in cooperation with the Advertising Council and the Magazine Publishers of America as a public service.



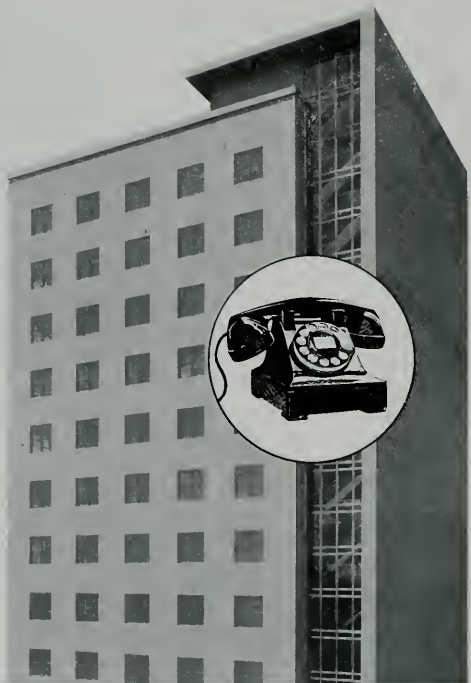

Oakland: Ariston stainless steel trim and windows on ground floor and 16-story stair well.



Watsonville: Ariston steel sash with stainless steel trim on ground floor and stair well, and stainless steel doors and entrance.



Pittsburg: Ariston steel sash.



Marysville: Ariston steel sash, stainless steel entrance and door, steel stair rail.



**Harry A. Thomsen and Aleck L. Wilson, Architects**



# GROWING WITH THE WEST



San Francisco: Ariston stainless steel trim and windows on stair well, stainless steel entrance and door, steel stairs and fire escapes.



Sanford: Ariston steel sash, steel stairs and fire escape, stainless steel entrance and doors.

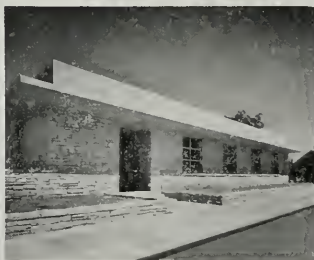

Santa Clara: Ariston steel sash, stainless steel entrance and door.



Richmond: Ariston bronze entrance and doors, miscellaneous steel and steel stairs.

California reflected the largest increase in population of any of the 48 states during the war and post-war years. This unprecedented growth in population placed tremendous demands upon the public service organizations which were required to keep pace with rapid expansion in the face of material and labor shortages.

The Pacific Telephone and Telegraph Company provides a notable example of how the responsibilities of one public service organization were efficiently discharged. Ample evidence of the foresight and organization of this firm can be found in the erection of many additional buildings to better serve the communication requirements of communities throughout the state.

In addition to the buildings illustrated, the Pacific Telephone and Telegraph Company has also completed construction on buildings in Fresno, Napa, San Jose, Colma, Mill Valley, Berkeley and Sacramento using Ariston Metal Products.



## Michel & Pfeffer Iron Works, Inc.

South Linden & Tanforan Aves.  
South San Francisco, Calif.

# JOINT INFORMATION COMMITTEE

AMERICAN INSTITUTE OF ARCHITECTS and THE PRODUCERS COUNCIL, INC.

---

At the meeting of the Joint Information Committee held in Washington, D. C., September 11th in conjunction with the meeting of the Chapter Presidents of the regional chapters of the Producers Council a resolution was passed. This resolution was arrived at after considering the results of the surveys conducted by both the A. I. A. and the Producers' Council Joint Information Committees to investigate the question of UNIFORM SPECIFICATION PROCEDURES by establishment of a specification service for the Architectural Profession.

It is not conclusive and can only be considered as one more constructive move toward the achievement of the desired UNIFORM SPECIFICATIONS and Trade Literature. The current possibility of professional misunderstandings in connection with trade literature is apparent from passage of this resolution and it should serve a very valuable purpose in bringing to the foreground action to eliminate needless concern.

Questions of finance, and referral to the Construction Specification Institute are both pointed out logically and are important at first glance. The final question of who will pay for the operation is naturally one which makes everyone look around for value received or a convenient exit. Actually it probably will call for sensible compromises somewhat in line with responsibility on the part of the Architect and the Manufacturer of Building Materials.

The Architect will get a time saving device which can readily be translated into dollar value when projected on his cost sheet and will make it possible for the individual to see his subscription to such a service as self liquidating. The Manufacturer will obtain installation protection for his products which it is difficult to otherwise obtain. The manufacturer will also be using some of the money for production of his own Trade Literature Material for integration into such a system that would have been spent for that purpose in any event. This does not appear to be an insurmountable problem. The

text of the resolution is reproduced as follows for complete examination.

RESOLVED: That The Joint Committee of The A.I.A. and The Producers' Council is of the opinion the results of the survey of A.I.A. Membership indicates, on the part of the profession, an interest in and desire for the establishing of a specification service which would be subject to continuing review.

The Committee is further of the opinion the results of the questionnaire directed to the 108 members of The Producers' Council, a representative cross-section of the producing industry, resulting in replies from 34 companies and Trade Associations, of which 27 indicated varying interest in providing material for such a service, and only 9 expressing a willingness to contribute to the underwriting of the cost of the basic specification material, suggests, although perhaps not conclusively, difficulty in obtaining, from the producing industry, all of the funds required for such underwriting and the continuing maintenance of such a service.

The Joint Committee would direct attention to the Construction Specification Institute, Inc., an organization composed, primarily, of specification writers, many of whom are members of The American Institute of Architects, and would suggest the exploring of the possibility of effecting a collaboration between The A.I.A. and this organization in the development of the proposed specification service.

The Joint Committee is further of the opinion this project should be undertaken only if it is found possible to provide and finance full time correlating technical services, with secretarial assistance, and if competent and representative Standing Committees are provided for the development, review and approval of specification material.

The Joint Committee will, if The Board of Directors of The A.I.A. so desires, give further consideration and study to the implementation of this proposed service with a view to the development of more specific recommendations with respect to the same.

---

*NOTE: This news space is being contributed by ARCHITECT & ENGINEER Magazine to the JOINT INFORMATION COMMITTEE representing the Northern California Chapter of The American Institute of Architects and the Northern California Chapter of the Producer's Council, Inc., and is available to this Committee for the purpose of bringing to the attention of leaders within the Construction Industry various phases of the Architectural profession and building materials industry procedures for general consideration and comment. Your "ideas" and any suggestions for the better pooling of thoughts along these lines should be sent to "Joint Information Committee, c/o The Architect & Engineer, 68 Post Street, San Francisco," where they will be immediately forwarded to the proper committee members.*

# NEWS AND COMMENT ON ART

## ARTISTS RECEIVE AWARDS AT CALIFORNIA STATE FAIR

Artists, and photographers from all parts of the State received awards and public plaudits at the recent California State Fair in Sacramento.

The prize winning paintings and prints were the final selection of nearly 1200 entries in the classes of Conservative Oils, Modern Oils, Water Colors, Prints, and Sculpture, and were exhibited in a unique and brilliantly colored open air art exhibition.

Winners of first-place cash awards included Howard E. Smith of Carmel, \$1,000; Lundy Siegrist of Oakland, \$1,000; Ynez Johnston of Hollywood, \$500; Leonard Edmondson of Pasadena, \$300; and Elah H. Hays of Berkeley, gold medal and \$700. Thirty-two honorable mentions were made.

In the field of Photography, fourteen were awarded prizes with Wilbur H. Wier of San Diego, winning first prize and \$100; Frank J. Heller of Bartlesville, Oklahoma, won second place and \$50; and J. Wallace Galloway of Edmonton, Alberta, Canada, won third prize and \$25.

Jack Zajac, Scripps College, Claremont, won a scholarship of \$750 and a cash award of \$125 for his oil painting, "Japanese Boy," in the college art contest. Forty-three cash premiums were awarded in this class; private art school, junior-senior, and freshman-sophomore.

## MILLS COLLEGE ART GALLERY

The Mills College Art Gallery, MacArthur Blvd., Oakland, under the direction of Sidney M. Kaplan, will present a group of Stage Designs by Arch Lauterer during October.

A number of recent acquisitions to the Art Gallery will also be on display.

## SAN FRANCISCO MUSEUM OF ART

The San Francisco Museum of Art, War Memorial Building, Civic Center, will offer the following exhibits and events during the month of October:

EXHIBITIONS: "Portfolio No. 2—National Parks and Monuments," photographs by Ansel Adams; Educational Toys; New Works by Bay Region Painters and Sculptors; Paris Exhibition Posters; Latin American Art — Sculpture, Watercolors, Drawings, and Prints; Modern Buildings for Schools and Colleges; Rental Gallery; New Homes in San Francisco; and a Review of Collections.

EVENTS: The final concert of the Camion Festival will be given October 1st; Children's Concerts

will be given October 20, 27 and November 3; and the Griller Quartet will be presented October 25.

Special lectures will be given Sundays at 3:15 p.m. and on Wednesday evenings at 8:15, with a special Lecture Series on Monday evenings at 8 o'clock starting October 22 with the subject being "The Art of Today." Gallery tours will be conducted each Sunday at 2:30 p.m., and the art classes for Children on Saturday mornings and "Adventures in Drawing and Painting" classes on Friday evenings will complete the Museum's schedule.

## ARCHITECTURAL EXHIBITION PRELIMINARY SUBMISSION

The deadline for preliminary submission of architectural work for the 1952 Gold Medal show sponsored each year by the Architectural League of New York has been announced for the second week in November.

Architects desiring to enter work in this show should communicate with Miss Anna Clarke, executive secretary, Architectural League, 115 E. 40th Street, New York 16.

Selected work from the Architectural Exhibition which is to be shown in New York from January 14 to February 7, will be shown in the final architectural exhibit at the American Institute of Architects annual national convention in New York City in June.

## CITY OF PARIS

The Rotunda Art Gallery of the City of Paris, San Francisco, under the direction of Beatrice Judd Ryan, will feature Sculpture in a variety of Mediums representing twenty-three artists of the Pacific Coast, and a display of Mosaics by Louisa Jenkins, during the month of October.

A special exhibit by the San Francisco Orchid Society, an affiliate of the American Orchid Society, will be held from October 30 to November 3.

## HARVARD SCHOLARSHIP IN LANDSCAPE DEPARTMENT

The Department of Landscape Architecture of the Graduate School of Design, Harvard University, is offering a scholarship for the academic year 1952-53, carrying a stipend of six hundred dollars, which is the equivalent of the tuition for one year.

Complete information may be obtained by writing Lester A. Collins, Department of Landscape Architecture, Harvard University, Cambridge 38, Mass.

## **SOUTHERN CALIFORNIA CHAPTER—A.I.A.**

Alexander J. Stoddard, superintendent of Los Angeles schools, addressed the September meeting on the subject, "Our City's Educational Program," and pointed out a number of problems confronting the city in the planning of school facilities for the future.

National Honor Award Certificates were presented to members Allison and Ribble, Raphael Soriano, Richard J. Neutra, and Maynard Lyndon.

New Members recently welcomed into the Chapter include Stanley Meston, Dion Neutra, Romeo A. Rodriguez, and George F. Schreiber, Jr.

## **NORTHERN CALIFORNIA CHAPTER—A.I.A.**

Three State Senators, ten State Assemblymen, and a host of prominent Bay Area civic leaders and officials, joined with Chapter members on September 25 in San Francisco to honor National A.I.A. Award Winners for 1951 and to get better acquainted with the architectural profession.

Chapter members receiving the Awards were: Francis Joseph McCarthy, Wurster, Bernardi & Emmons, and Anshen & Allen.

## **SOCIETY OF AMERICAN MILITARY ENGINEERS—San Francisco Post**

Rear Admiral J. F. Jelley, CEC, USN, spoke at the September meeting in the Presidio Officers Club, San Francisco, on the subject, "Navy Civil Engineers."

Admiral Jelley, Chief of the Bureau of Yards and Docks, Navy Department, was appointed to the Civil Engineer Corps, U. S. Navy, in 1927, following his graduation from Annapolis. Subsequently he has held a wide variety of posts and his comments on the matter of civil engineers as applied to the U. S. Navy were extremely interesting.

## **BUILDING REMODEL FOR TV**

The old Eagles Hall on Golden Gate Avenue in San Francisco is being remodeled and will serve as the Radio and Television building for American Broadcasting Company activities in San Francisco. The building is four stories in height.

W. L. Pereira and Chas. Luckman of Los Angeles are the architects, and Wm. Simpson Construction, L. A., is the general contractor.

## **ALASKA ACTIVITIES IN ARMY CONSTRUCTION UP**

The recent lull in Corps of Engineers, U. S. Army construction in Alaska was broken with the awarding of two large contracts and spirited bidding on another.

Col. L. E. Seeman, Alaska District Engineer,

announced that Peter Kiewit Sons of Seattle have been awarded a \$8,493,313 contract for the construction of outside utilities at Ladd Air Force Base, and the Kuney Johnson Company was given a \$1,069,000 contract for construction of Alaskan Communications Facilities at Fairbanks.

Six contractors are competing for the award for the construction of Tower Footings at Elmendorf Air Force Base and at Ft. Richardson.

## **COUNTY OFFICE BUILDING**

Architect Harry J. Devine of Sacramento has been commissioned by the Board of Supervisors of Sutter county to draw plans for the construction of a new County Office Building in Yuba City.

## **ARCHITECT SELECTED**

Leslie C. Irwin, San Francisco, and Frank Wynkoop & Associates of San Francisco, have been selected by the South San Francisco Unified School District to draw plans for the new El Rancho and Sunshine Garden schools to be built in South San Francisco.

## **BUILDERS FORM COOP WITH ARCHITECTS**

Architects and builders in the Los Angeles area are engaged in a program of collaborative effort designed to aid home design and construction.

George D. Riddle, Glendale architect and member of the Glendale City Planning Commission represents the A.I.A. on the program while Sid Brittain, Montrose, member of the firm of Cunningham & Brittain, Long Beach builders represents the NAHB.

Riddle and Brittain have scheduled a series of fall meetings between architects and builders to study ways and means of aiding housing design throughout southern California.

## **CALIFORNIA STYLE HOMES TO BE BUILT IN TEL AVIV**

Douglas Brandt, president of the Israel American National Construction Corp. of Los Angeles, left recently for Israel with plans to build the first California modern-designed homes in Ramat Can and Tel Aviv.

The homes are to be built in a tract of 1000 homes, of a basic master plan, with variations in street facades to result from changes in materials, textures, colors and design treatment.

Craig Ellwood of Los Angeles is the architect.



# CIVIL DEFENSE ORDINANCE PROVIDES BOMB SHELTERS FOR CITY OF LOS ANGELES

Under the direction of G. E. Morris, superintendent of the Department of Building and Safety, a group of the department's engineers headed by D. C. Butz, senior structural engineer, have undertaken an extensive program designed to locate and designate adequate shelter in the event of an atomic bomb attack.

The program is provided for by passage of the Los Angeles Civil Defense Ordinance and superintendent Morris, in making his preliminary report says:

"Existing knowledge of the hazards of atomic attack indicates that shelters must necessarily provide protection against blast, nuclear radiation and heat, as well as such secondary effects as collapse of buildings, flying debris and fire.

"In the interest of effecting the greatest economy, the first consideration in Los Angeles has been to utilize existing buildings as shelters, with structural or architectural alterations to be entirely avoided.

## **Prior Preparation**

"Fortunately, this city has led the nation in pioneering earth-quake - resistant building design. Since 1933, the Los Angeles Building Code has required that new buildings be designed to resist lateral forces due to earthquakes, with the result that we now have a great many major-size structures that would afford considerable protection from the shock waves of an atomic blast. Consequently, it is now possible to effect enormous savings in money, time and strategic materials and to provide more efficient shelter than in the majority of cities in the United States, where no such requirements have been incorporated into local building codes.

"The department's program has been divided into five steps:

"(1) Estimates of building and transient population in key areas.

"(2) Determination of potential shelters in number sufficient to accommodate estimated population.

"(3) Careful evaluation of buildings by examination of plans and by visual means on the site.

"(4) Dissemination of information to building owners and managers.

"(5) Posting of exterior and interior signs to clearly indicate location of shelters.

## **Evaluation Steps**

"Step 3 has probably provoked greatest interest. For purposes of evaluation, two U. S. government publications have been utilized to great degree. They are 'The Effects of Atomic Weapons' and 'Shelter From Atomic Attack in Existing Buildings.'

"Despite gaps in existing knowledge, photographs are available of reinforced concrete and steel frame buildings in Hiroshima and Nagasaki with lower floors and basements intact despite almost complete devastation of the surrounding area. And, though the possible ramifications to the problem are admittedly numerous, it is certain that reinforced concrete and steel frame and concrete buildings offer the greatest degree of resistance to bomb blast, and may in addition suffer extensive damage without complete collapse.

"Accordingly, Type I buildings, preferably those designated for seismic forces have been given priority for investigation. Plans on file in City Hall have been studied to determine design, live loads, anchorage of exterior walls and construction of interior partitions.

## **Other Items**

"Other factors contributing to lateral resistance such as shape of building, continuity of frame and degree of protection afforded by surrounding buildings have been evaluated. In general, basements and lower floor areas have been chosen for shelter areas because of their inherently greater lateral resistance and because lower floors are usually designed for greater loads than upper. This is in accordance with Federal civil defense recommendations.

"Besides the structural stability of the building, it is necessary that the shelter area be of incombustible fire resistant construction; that it have more than one exit in case one becomes blocked; that adequate toilet facilities are available, and

(See Page 35)



RELATION OF HOUSE WINGS TO TERRACE AND GARDEN

# RANCH-TYPE HOUSE

LOS ALTOS, CALIFORNIA

Designed For Mr. and Mrs. W. F. Sanford

ROBERT S. KITCHEN and FRANK B. HUNT, Architects

By **MARCIA LEE**

**SITE:** Level valley floor, nestled among rolling wooded hill country near the city of Los Altos, California.

**PROBLEM:** To provide a two-bedroom "ranch-type" house, sentimental in appearance but functional and easy to maintain, for a couple with grown children, who want to enjoy to the fullest their garden and countryside vistas.

**PLAN:** A one-story house angled to frame the rear terrace and garden on two sides and a driveway court and garden in the front. All major living spaces open out through walls and doors of glass onto the out-door living area in the rear.

## . . . RANCH-TYPE HOUSE

To take full advantage of country vistas without sacrifice of privacy, the house turns its back to the public road—but a very handsome, hospitable back it is. The turn-off from the road leads into a circular driveway, its hub a bower of flowers and a shade tree-to-be. At one section of the circle, adjacent to the covered entrance porch, the drive expands into an area for parking, and midway around is access to the two-car garage. A planting area flanks the house, following the line of the driveway from entrance porch to garage. For protection in wet weather, a covered breezeway connects the garage with the utility wing of the house. This breezeway is backed with a decorative cello-glass wall fitted with redwood shelves for potted flowers which screens the service yard from view.

The sloping roof is shingled with cedar and the siding is redwood board and batten. Exterior trim is redwood brown; the sash and doors, oak leaf

green; wood soffits and rafters, grayed yellow, and the posts and beams, warm gray.

The front door opens into an entry, separated from the driveway garden court on the east by a plate glass wall which splits an outdoor-indoor planting bed. The west wall of the entry is a sliding glass door opening onto the rear garden. This entry sets the theme for the outdoor-indoor living arrangement that is carried throughout the house.

Opposite the entrance door, to the north, is a handsome screen of patterned glass which walls off the dining room behind. Rounding the south corner of the entry, where it opens onto the living room, is a combination coat closet and telephone room, and a compact bar—complete with sink, counter space, cupboards, adjustable glass shelves and indirect lighting—concealed entirely, when not in use, by "blind doors" set in the red-

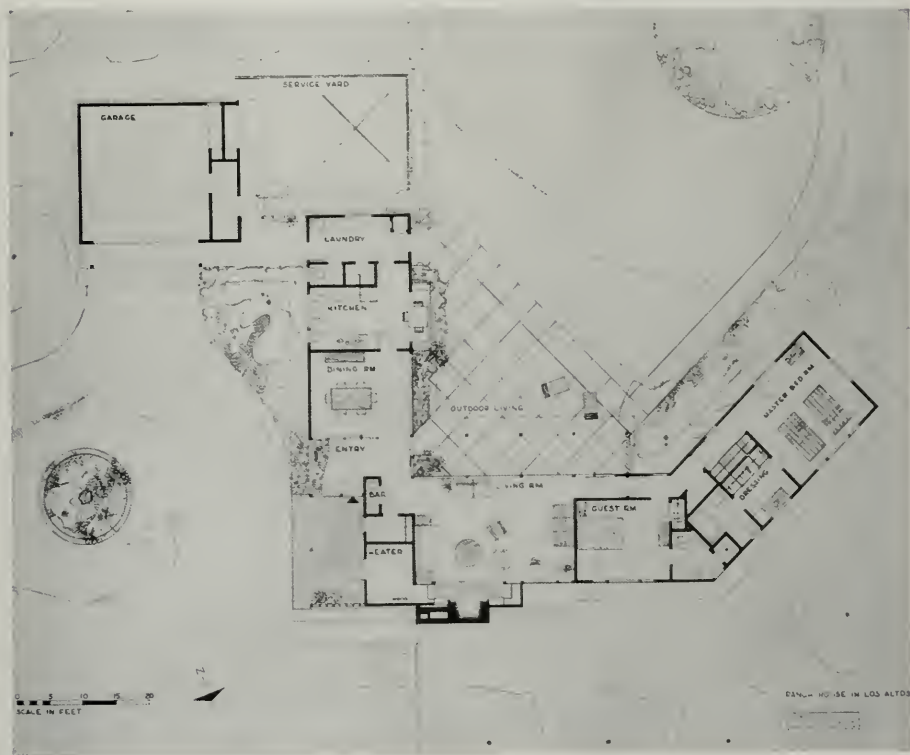

## RANCH-TYPE HOUSE . . .



### FRONT VIEWS OF THE NEW HOME

As seen from the city's roadway  
that approaches the attractive  
home site.

ABOVE: Portion of planting area off the drive-way court and opposite the garages. Large window is in dining room, kitchen window may be seen at extreme left.

BELOW: Left side of home showing drive-way court that serves the main street entrance. Two-garage area is at extreme left.





wood wall. The location of this bar is a pertinent example of the functional operation . . . it is but a step from the bar to living room, dining room or outdoor living area.

In the rear, or living side of the house, the architects have angled the wings of the structure to frame the outdoor living area on two sides. Adjoining the glass enclosed breakfast bay on one side of the garden is the floor-to-ceiling plate glass window of the dining room. Next to this is the sliding glass door which forms one wall of the entry, and at right angles to the entry stretches the glass wall of the living room. Thus, we have a continuous wall of glass and a fusion of outdoors with all the major living areas. There is a door to the terrace from the bedroom wing adjoining the living room and another from the laundry room in the utility wing of the house.

The terrace is paved with common red brick laid in sand between 2" x 4" redwood dividing strips. A redwood louver screen provides privacy for the bedroom wing, and a grapestakes fence hides the service yard opposite.

A covered porch, adjacent to the glass wall of the living room and extending its full length, protects the room from the hot sun, and deep roof overhand protects the dining, utility and bedroom wings.

An especially interesting feature of the inside plan is the free-flowing, continuous line of passage from one end of the house to the other bor-



**Celloglass wall screening the service yard and bordering the covered passageway from the garage to the utility wing of the house.**

dering the outdoor living space. There is a door from the laundry to the kitchen and from kitchen to dining room, but there is continuous open passage from dining room through entry and living room to the door of the bedroom wing.

Special feature of the master bedroom is the dressing room, with built-in dressing table and cupboard space, located between the bedroom and master bath. The extra-large closet is partitioned—half for the Mr., with entrance from the



**View of the Out-door living area from the living room**

## RANCH-TYPE HOUSE . . .



ENTRY—Partition hides dining room.

### BUILT-IN BAR

Is situated conveniently in relation to living, dining and outdoor living space.

### LIVING ROOM

Fireplace is surrounded by book-shelves, both are set-back from room.



*All photos by  
Allyson Painter*

bedroom proper, and half for the Mrs., with entrance from the dressing room.

A built-in linen closet occupies the wall space between the master bedroom and guest room, and a small door provides access to the linen shelves from the master bath. For cost-cutting efficiency, the baths of guest room and master bedroom are located back-to-back.

Among the interior rooms, the living area in particular expresses the melding of "functional" and "sentimental." The large fireplace escapes the starkness of strictly functional lines by being recessed in an alcove lined with book shelves. But the indirect fluorescent lighting recessed above and the removable shelves, all of which are adjustable on metal shelf standards are strictly functional . . . as are the removable shelves designed for record albums, and the corner wood box which is filled directly from the wood storage space in the heater room through an opening in the wall. Functional, too, is the inclusion of the flue from the water heater and furnace in the fireplace chimney. The glass wall on the terrace side is fitted with indirect lighting above, and a large window at one end of the fireplace wall admits still another view of the countryside. Exposed Douglas Fir roof beams are 2" x 6", tongue and groove sheathing augments the sense of spaciousness and the



The Dressing Room—

Separates the "Master Bedroom" and bath.

"U"  
Shaped  
Working  
Space  
in  
Kitchen



## RANCH-TYPE HOUSE . . .

"natural" feeling. Practically speaking, this treatment reduces costs considerably by eliminating ceiling finishing expense.

Kitchen working space is arranged in a U shape, with a built-in electric range and oven (there is space for a future oven below) at one end. Fluorescent strip lighting recessed in the underside of the cupboard provides special lighting for this area and a ventilating fan concealed in the cupboard draws cooking odors directly from over the range.

The counter top of the range is stainless steel and the counter space extending the rest of the way around the "U" is gray vinyl plastic. Space below and above the counter is lined with cupboards. The refrigerator stands at the end of the counter space directly opposite the range. High windows above the sink at the base of the "U"

admit light and a pleasant view of the driveway court.

The laundry room doubles as passage way both from the garage breezeway and outdoor living area to the kitchen. Opening off the laundry is a small bathroom on one side and a generous-sized canned food storage room adjacent to it.

Floors, which are only a few inches above the grade of the site, are waxed concrete with integral color. The concrete is exposed in the entry, laundry and baths, and all other rooms are carpeted. The kitchen floor is gray asphalt tile.

Interior walls are plasterboard with the exception of the east wall of the living room which is finished with 1" x 10" redwood shiplap extending on through the entry and along the exterior wall of the entrance porch.

---

# EVOLUTION of the "STRENGTHENED CORE" DESIGN FOR BLAST-RESISTANT BUILDINGS

By **ELLERY HUSTED & G. L. SCHUYLER**  
Consultants to Federal Civil Defense Administration  
Washington, D. C.

Since the end of World War II there has been considerable talk about the desirability of "dispersion" of important new facilities to be built in critical areas. Nevertheless an average of 18 billion dollars a year for the past four years has gone into new industrial buildings **without any consideration of dispersing them.** The idealist's hope for a thoroughly de-urbanized United States so scattered as to be almost indestructible by A-bomb warfare seems unlikely to be realized in our time. Meanwhile, important buildings will continue to be built in critical areas where a better than ordinary degree of blast resistance seems called for.

### Strategic Bombing Survey

When American architects and engineers of the Strategic Bombing Survey first viewed the devastation at Hiroshima and Nagasaki, they were

struck with the ability of reinforced concrete and heavy steel structures to withstand atomic blast. Close to Ground Zero such structures remained standing in a waste of ashes. In most cases, however, their **interiors** had been gutted through effects of fire and blast, operating via the exterior openings. Blast had flung glass, plaster, and equipment in all directions. Fire had consumed all combustible contents. Analysis of these Japanese buildings indicated that, while they had survived **as structures**, they had failed **as shelters**, owing to the vulnerability of their window openings.

In considering designs for new U. S. buildings that might survive under A-bomb attack, it was naturally at first assumed that similar buildings, designed without windows, would be best to preserve their occupants and their contents — at least



in the absence of "fire-storm", a phenomenon unlikely to occur in the downtown areas of our larger cities.

### A-Bomb Design

First design for U. S. A-bomb resistant buildings, therefore, took the form of reinforced concrete framed structures without windows. It was early recognized that since buildings under A-bomb blast must be subjected to very high pressure, it would be impracticable to design them for response limited to their **elastic range**. It would be sufficient if a blasted building absorbed energy by **plastic deformation** to a point just short of its ultimate yield point. As long as it saved the lives of its occupants, unsightly distortion of the structure would be acceptable. Built-in safety factors required by current building codes to insure "return to normal" reaction of members would for economic reasons have to be abandoned in the atomic age.

With blast denied entry through wall openings, the horizontal impulsive loading on a wall is somewhat increased; but such increase in loading is by no means proportional to the increase in wall area produced by the elimination of openings. The additional weight of the windowless wall will increase its dynamic resistance, and omission of apertures will add greatly to the structural strength of the wall. From the purely struc-

If a framed, windowless building is to be destroyed by a horizontal blast load, this can occur only if the walls shear off along a horizontal section just above the foundation; and such walls can be made amply strong, provided they do not dish in and collapse as diaphragms. Against such dishing action the floors and the floor frames will

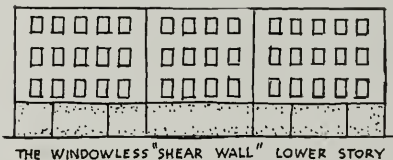

THE WINDOWLESS "SHEAR WALL" LOWER STORY

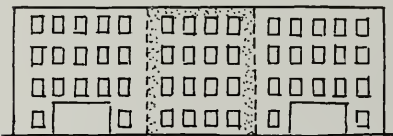

THE INTERIOR "STRENGTHENED CORE" WITH WINDOWS

ture serve as horizontal beams transmitting loads from the front wall to the side walls and resisting the dishing and the caving in of all exterior walls.

No attempt will be made here to refine or elaborate this over-simplified description of the framed, windowless structure's behavior under blast; but perhaps enough has been said to indicate a preference for something more like "monocoque" construction. In this type of design the frame is lightened, the floors are made only slightly stronger than required by their normal live loads, and the reduced internal strength is transferred to the exterior walls and roof. Such a "shear wall" structure is in effect, an extremely simple, rugged box designed to resist rupture, sliding, and overturning. Because of the simpler form-work required, a building of this type is the cheapest structure for its strength. In retrospect it seems that it should have been recognized as preferable to the conventional framed structure.

### Design

But granting the structural superiority of such a building, who will want to live in a windowless concrete box? It is true that solid walls cost less and need less upkeep than walls with windows, that modern illuminating and air conditioning make windows unnecessary, that windowless structures may be entirely satisfactory aesthetically.

There is, nevertheless, great consumer resistance to windowless buildings of many types. Hos-

(See Page 32)

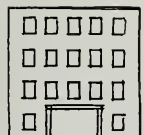

JAPANESE EARTH-QUAKE RESISTANT

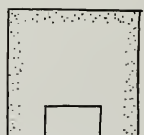

U.S. WINDOWLESS "SHEAR WALL" TYPE

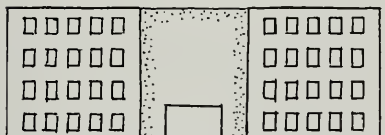

THE WINDOWLESS "SHEAR WALL" CENTRAL WING

tural point of view, a reinforced concrete, windowless, framed structure (with a good heavy roof) is the ideal building to resist blast.

### Behavior of Building

Analysis of the probable behavior of such a building suggested that, going still farther, a logical next step would be to strengthen the exterior walls and roof and correspondingly lighten the internal frame.



Entrance—main office area at right

**Owner:**

INTERNATIONAL MINERALS &  
CHEMICAL CORPORATION,  
San Francisco

**Architect:**

FRANCIS JOSEPH McCARTHY, A.I.A.

**Builder:**

OSCAR PRESCO & SONS

**Landscape Architect:**

ECKBO, ROYSTON and WILLIAMS

General offices . . . curtains at right may be drawn for area separation



These new offices are to serve as the general sales offices on the West Coast for the "Accent" products division of the International Minerals and Chemical Corporation.

The architect was requested to provide adequate facilities within a limited area for a suitable private office for an executive office manager; a general office for transaction of routine business including activities of a secretary-receptionist; and accommodations for two salesmen.

To accomplish an economical and quickly adjustable rearrangement of the general office space when desired, an alcove area that could be curtained off during con-



Reverse side of Mural partition, provides display and storage space.

General office area, with built in cabinets at rear. Main entrance at left of this space. Conference room at extreme rear-left.





ference sessions, or could be utilized for the special use of executives and other visiting officials, was provided.

A large conference room, sales meeting room, and general utility use room has been provided immediately adjacent to the office area. This room may also be used for special exhibits or merchandise displays if so desired.

Much of the space used for storage of office supplies, advertising pamphlets, small merchandise samples, and miscellaneous items, has been provided in the form of built-in cabinets. The reverse side of the large Mural partition which separates the office area from the entrance, for example, is equipped

(See Page 35)

Close up of Mural panel partition.

Floor plan of new office areas.

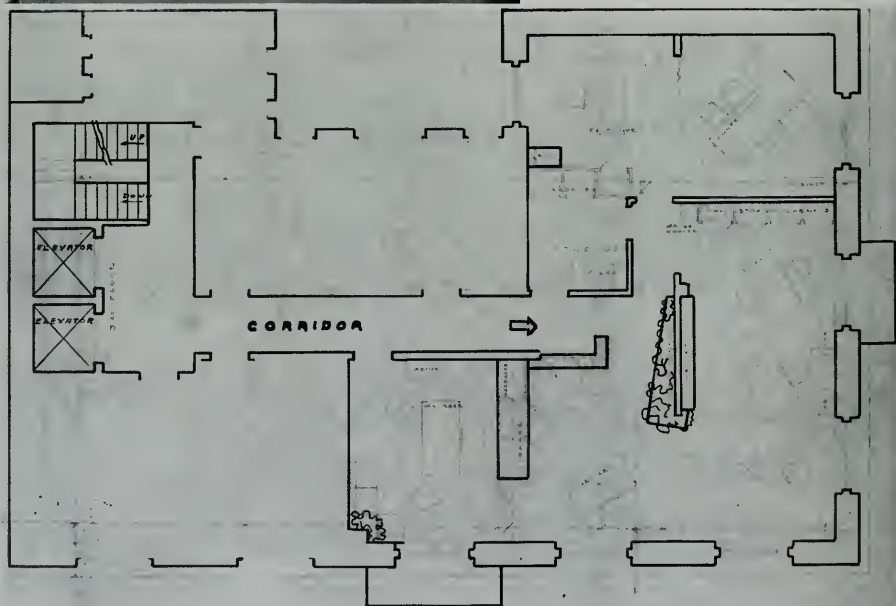

FLOOR PLAN

FRONT ST.



Interior view of the new offices looking towards the private office. The main entrance is at the right. Indirect overhead lighting, with built-in spots, provide ample work light at all times.



The executive manager's office.

*Photos by  
Roger Sturtevant*



# AIR CONDITIONING

## PRINCIPLES and OBJECTIVES

### PART II

By H. L. WOLLMAN, Research Engineer\*

Attempts to specify economically optimum environmental conditions for any particular activity encounter formidable difficulties. If cost were not a factor, the choice would be for atmospheric conditions so favorable that the activity of the occupants would be limited by other considerations long before heat dissipation became a problem. Or, if the choice lay only between ideal conditions and those leading to complete prostration, the cost of providing ideal conditions would be considered an inescapable expense of doing business, and the matter would rest there.

There is, however, a continuous gradation from intolerable conditions to the best that technology can achieve and, generally speaking, increasing cost accompanies improving conditions. It is possible to state, for any given case, how the cost of air conditioning will vary with the air conditions provided. If it were possible to provide some means of judging how the working effectiveness of persons varies with these same air conditions, management would be able to relate costs to prospective returns, and so would be able to specify air conditioning on a rational basis.

Unfortunately, no practically useful quantitative relationship between atmospheric conditions and personal effectiveness has ever been established. It is obvious that extreme conditions, bordering on the limits of human tolerance, are not conducive to personal efficiency, nor even to good health, but for the more moderate range of conditions within which it is usually necessary to make a choice, a numerical scale of values is lacking.

At the present time the only practical measure of the relative desirability of different air conditions is one of comfort. Although comfort has been

found to be more readily measurable than personal effectiveness it is, nevertheless, a most difficult entity to evaluate in a quantitative way. Because of this difficulty, investigators have resorted to a statistical approach to the problem, and have reported their findings in statistical form. Instead of attempting to determine what "degree of comfort" is experienced by any one person under any particular set of conditions, investigators have determined how large a fraction of a group of subjects is "comfortable" under those conditions.

Before discussing the details of the relationship between comfort and environmental conditions, it is in order to examine critically the validity of the comfort criterion. Casual consideration might indicate that the extent to which an environment provides for the comfort of the individual is not necessarily a measure of the extent to which it promotes the effectiveness of that individual. The word "comfort" frequently is mentally associated with luxuriousness and enjoyment, rather than with productivity and efficiency. Nevertheless, the influence of comfort, perhaps more properly described as satisfactory adjustment between individual and environment, on human accomplishment is real.

The fact that it is real is so well appreciated that a distinct branch of engineering has been developed to study the problem and apply the lessons so learned. Among the applications in use today are many for the non-pleasurable occupation of operating military aircraft, such as, for example, ventilated clothing and pulsating seat cushions for mitigating the rigors of extended confinement in an adverse environment. The office worker or bank teller who is expected to perform rapidly and accurately a long series of exacting transactions, while maintaining a poised bearing which will reflect creditably on his employer, is not less a prisoner of his environment, and is not less in need of comfort.

\* EDITORS NOTE:—Part I of this article, devoted to a theoretical consideration of the subject of air conditioning in commercial buildings appeared in the September, 1931 issue of ARCHITECT & ENGINEER magazine. Part II is the concluding portion of a special report prepared by the author H. L. Wollman, Research Engineer, for The Capital Company of San Francisco.



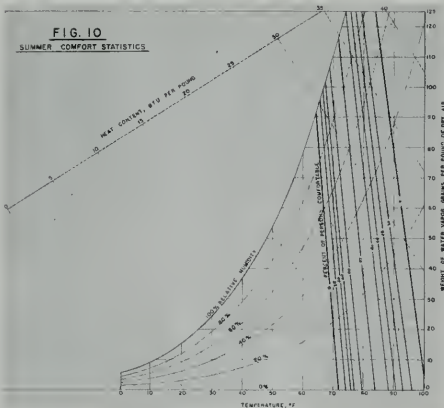

represent conditions satisfying 80% of the subjects and succeeding lines on both sides go down to zero by 20% steps. Beyond the outermost lines, the remaining conditions are all states which are comfortable for no one.

With such information at hand, it is possible to set air conditioning design objectives. However, in the absence of a known numerical relationship between comfort and personal effectiveness, the setting of such objectives is not a technological problem, but is more properly in the domain of management. If, for example, it is the opinion of management that a particular business can satisfactorily be operated under conditions which are comfortable for only 10% of the persons so occupied, design objectives should be established in accordance with that opinion. If, on the other hand, it is desired to satisfy the maximum possible number of persons, then designers should be so instructed. In any case, the choice is entirely arbitrary, and can be guided only by management's evaluation of the effect of environmental conditions on the success of the enterprise. In this respect air conditioning is in the same position as all other physical appointments in business premises; the degree of refinement or excellence is arbitrarily dictated by the judgment of management.

The ASHVE has, however, suggested a standard of minimum recommended design conditions. In doing this, it has defined a range of acceptable atmospheric conditions, and the region on the psychrometric chart which covers this range has been named the **comfort zone**. The summer comfort zone, while not rigorously defined in this way, is in effect bounded on the cold side by conditions

under which none of the subjects studied was perfectly comfortable, and the only ones who were at all comfortable (30%) were in the "comfortable-but-cool" category. On the warm side, the conditions allowed essentially none of the subjects to be perfectly comfortable but permitted some (50%) to be in the "comfortable-but-warm" classification. With respect to humidity, the comfort zone is bounded on the two remaining sides by the 70% and 30% relative humidity curves. These humidity limits are not determined by heat balance, but by other physiological considerations. In extremely dry atmospheres, for example, rapid drying of the membranes lining the respiratory passages leads to discomfort, regardless of overall heat balance. In very moist atmospheres, an oppressive sensation of moisture and stickiness of the skin is experienced, especially under slight momentary exertion. For these and other reasons, the humidity limits cited have been imposed on the comfort zone. The comfort zone, and other provisions of the ASHVE "Code of Minimum Requirements for Comfort Air Conditioning" are widely accepted and used by competent and reputable engineers in the air conditioning field. Fig. 11 shows the summer comfort zone.

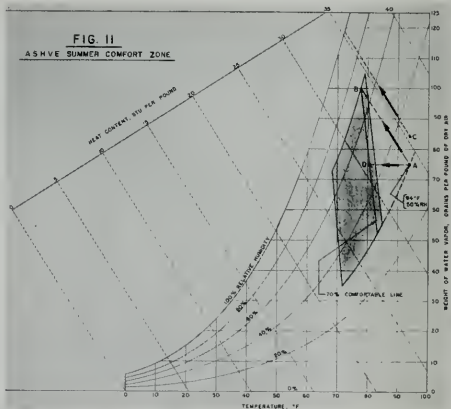

## METHODS AND EQUIPMENT

After design objectives have been established, it is necessary to select the means of accomplishing these objectives. In the selection of equipment for cooling air, it is frequently necessary to choose between devices using the evaporative cooling principle and those using mechanical refrigeration. For a given reduction in air temperature, evaporative cooling installations are frequently lower in first cost and usually lower in operating



cost than mechanical refrigerators. For equivalent penetration into the comfort zone, however, it is by no means a foregone conclusion that this economic relationship invariably holds. There are some climatic conditions which are unfavorable to the economic use of evaporative cooling and some, indeed, which make its use a technological impossibility. An example will illustrate this situation.

**The following idealized example employs a gross oversimplification of design procedures. Real installations behave in a much more complex manner, and for reasons which are beyond the scope of this discussion. The method used here, although presenting a fair comparison, is not suitable for actual design.**

Consider a climatic condition in which the air is at 94° F. and 30% relative humidity. It is desired to employ evaporative cooling to bring the air within the comfort zone and to a condition which will be comfortable to 70% of the persons concerned. Fig. 11 shows the stipulated climatic condition at point "A", and the stipulated line along which 70% of subjects would be comfortable. Evaporative cooling can lower the air temperature along a line of constant heat content, and such a line, "AB" from point "A" intersects the 70% "equal-comfort" line at the boundary of the comfort zone. Ideally, then, the required operation is just possible. From point "C", at this same temperature, but with higher humidity, a line of constant heat content would fail to intersect the stipulated comfort line within the comfort zone (in fact, for the point shown, would fail entirely to pass through the comfort zone) and the required operation would be technologically impossible.

Returning to the possible case, there are other paths from point "A" to the required comfort line. With mechanical refrigeration, it is possible to cool air without adding to its moisture content or even, if desired, to reduce the moisture content. Cooling at constant moisture content is shown as path "AD". So far as personal sensation of warmth is concerned, point "D" is as desirable as point "B" and from other comfort considerations, point "D" is superior.

There are circumstances in which it may be cheaper to follow path "AD" with refrigeration than

to follow path "AB" with evaporative cooling. Many factors influence these costs: volume of air to be circulated, size and power requirements of blowers, size of ductwork, space requirements, relative costs of ductwork and compressors (a relationship which varies with time) and many others. Only a careful appraisal of each situation by a skilled practitioner in the air conditioning field should be relied on to furnish a basis on which to make a decision. Just as it is management's function to define quantitatively the performance objectives for any installation, so is it the function of technology to show how these objectives may most economically be realized.

### SUMMARY AND CONCLUSION

It has been shown that temperature alone is not a satisfactory measure of the ability of air to provide a comfortable environment; the influence of humidity is extremely important. This is so because the human organism relies heavily on vaporization of moisture from its surface to maintain itself in a stable temperature condition and because the presence of moisture in the air critically influences the ability of the body to vaporize water. Further, evaporation is virtually the only mechanism of heat loss over which the body can exercise significant control; while comfort is not impossible with limited evaporation, control to meet continuing variation in need is impossible without wide latitude in vaporizing opportunity.

Reduction of air temperature by evaporative cooling is always accompanied by an increase in moisture load and a decrease in the capacity of the air to receive moisture. Whether this humidification is sufficient to make realization of comfortable conditions an impossibility will depend on the particular conditions involved, and cannot be determined without examination of those conditions. Even where comfort conditions may be achieved with evaporative cooling, mechanical refrigeration may yield equivalent conditions at lower cost.

It is recommended that management specify its desired end result in terms of the percentage of persons to be kept comfortable, and leave to technology the determination of the means of achieving that result most economically.

(Conclusion)

# American Institute



# of Architects

Glenn Stanton, President  
Kenneth E. Wischmeyer, 1st Vice-president  
Norman J. Schlossman, 2nd Vice-president  
Clair W. Ditchy, Secretary  
Maurice J. Sullivan, Treasurer

National Headquarters —  
1741 New York Avenue, N. W.  
Washington 6, D. C.  
Edmund R. Purves  
Executive Secretary

Arizona Chapter:  
Edward L. Varney, President; Ralph B. Haver, Secretary,  
P. O. Box 786, Phoenix, Arizona.

Central Valley of California:  
William Kobilie, President; Gordon Stafford, Vice-President;  
John W. Bomberger, Secretary; Albert B. Thomas, Treasurer.  
Secretary's Offices P. O. Box 1943, Modesto.

Coast Valleys Chapter:  
William F. Hempel, President; Lawrence Gentry, Vice-  
President; Walter Stromquist, Secretary-Treasurer. Secre-  
tary's office, 321 Channing Ave., Palo Alto.

Colorado Chapter:  
Paul Atchison, President; James M. Hunter, Vice-President;  
Dudley T. Smith, Secretary; Victor Hornbein, Treasurer.  
Offices 1254 Monaco Parkway, Denver.

Northern California Chapter:

Francis J. McCarthy, President; Albert R. Williams, Vice-  
President; Wendell R. Spackman, Secretary; Helen D.  
French, Treasurer. Offices 369 Pine Street, San Francisco.

Oregon Chapter:

Herman Brockman, President; Donald J. Stewart, Vice-  
President; Raymond Kermit Thompson, Secretary; Millard  
H. Schmeer, Jr., Treasurer. Secretary's office 429 S. W. 4th  
Avenue, Portland.

Pasadena Chapter (California):

Culver Heaton, President; Don Neptune, Vice President;  
Arthur Frick, Treasurer; (Mrs.) Dorothy Gray, Secretary.  
Directors, John N. Douglas, Boyd Georgi, Roland E. Coate  
and Burton Romberger. Office 1041 East Green St., Pasa-  
dena.

## A.I.A. JOIN BUILDERS GROUPS IN CONSERVATION

A way to serve building materials in short supply because of defense requirements has been offered a group of government agencies by the American Institute of Architects, the Producers' Council and the National Association of Home Builders.

In a recent letter sent the Defense Production Administration's Conservation Division and to the principal federal agencies concerned with building, the advantages of modular coordination were

outlined by Glenn Stanton, A. Naughton Lake, and W. P. Alkinson, respective presidents of the three building groups. The communication pointed out the savings in materials that could be made if the wastage of materials in the construction process itself were eliminated.

A program that would require a systematic correlation of the dimensions of buildings and the unit sizes of the building products going into them would create more efficiency and less extravagance, the experts said. They cited a congressional declaration in the Housing Act of 1948 in support of modular coordination, and the preparation of instructional manuals by the Housing and Home Finance Agency that enable architects and engineers to practice the new economic method of dimensioning, as systematized under the American Standards Association.

The call to endorse the principle of modular coordination and direct its application to the fullest extent in today's construction programs was sent to the U. S. Army Engineers, Navy Bureau of Yards and Docks, Department of the Air Force, Bureau of Standards, Housing and Home Finance Agency, Munitions Board, Public Buildings Service, Veterans Administration, and Public Housing Administration.

**SPEED CONSTRUCTION**  
**WITH FIRESAFE, SAG-PROOF**  
**EASY-TO-USE**

**STRAN-STEEL**

**NAILABLE**  
**STEEL FRAMING**  
**"Metal Lumber"**

\*PROMPT DELIVERIES ON  
**STUDS • JOISTS • CHANNELS**  
IN STANDARD SIZES

For complete information and prompt service, phone or write

**KRAFTILE COMPANY**

NILES, CALIFORNIA NILES 3611  
SAN FRANCISCO 51: 30 Hawthorne St.—DOUGLAS 2-3780  
LOS ANGELES 13: 406 South Main Street—MUTUAL 7241

## U. S. ARCHITECTS TO AID WEST GERMANY BUILDING

A major German effort to revitalize the nation's architecture and building methods, and at the same time to solve one of Germany's prime needs, adequate housing for workers, will be aided by five American architects and housing experts.

The housing projects, 5,000 low-cost worker's housing units in 14 cities, is being planned as a demonstration to prove the value of modern design, organization and methods in building good housing at moderate cost, and it is expected the

#### East Bay Chapter:

Harry A. Bruner, President; Chester H. Treichel, Vice-President; Ira D. Beale, Secretary; Cecil S. Moyer, Treasurer. Secretary's office, 1444 Webster St., Oakland.

#### Montana Chapter:

E. Edward Sawcrott, President (Billings); J. Van Teylingen, Vice-President (Great Falls); H. C. Cheever, Secretary-Treasurer. Secretary office, Bozeman.

#### Nevada Chapter:

George L. F. O'Brien, President; Aloysius McDonald, Vice-President; Graham Erskine, Secretary; Edward S. Parsons, Treasurer. Offices 160 Chestnut St., Reno.

#### Nevada State Board of Architects:

L. A. Ferris, President, Reno; Walter Zick, Secretary, Las Vegas; Directors, Aloysius McDonald, Los Vegas; Russell Mill and Edward Corsons, Reno. Office, P. O. Box 2107, Las Vegas, Nevada.

#### Pasadena Chapter:

Calver Heaton, President; Don Nephew, Vice-President; Arthur Frick, Treasurer; Mrs. Dorothy Gray, Secretary. Directors John N. Douglas, Bayd Georq, Roland E. Coate, and Burton Romberger. Offices 1041 E. Green St., Pasadena 1.

#### San Diego Chapter:

Jack R. Lewis, President; Louis A. Dean, Vice-President; Donald Campbell, Secretary; Victor L. Wallf, Jr., Treasurer. Directors C. J. Paderewski, G. C. Hatch. Secretary office, 1250 Prospect St., La Jolla.

#### San Joaquin Chapter: (California)

Fred L. Swartz, President, Fresno; Lloyd J. Fletcher, Vice President, Visalia; Walter Wagner, Secretary, Fresno; Robert W. Stevens, Treasurer, Fresno. Directors: Alastair Simpson, William D. Coats, William F. Baxter, Maurice I. Metz, Delegate California Council of Architects. Office, Sec. Fulton-Fresno Bldg.

#### Santa Barbara Chapter (California):

Robert I. Hoyt, President; Harold E. Burket, Vice-President; Roy W. Cheesman, Secretary; Lutha M. Riggs, Treasurer. Address, 242 San Marcos Bldg.

#### Southern California Chapter:

John London, President; Chas. Frey, Vice-President; C.

Day Woodford, Secretary; Wm. G. Balch, Treasurer. Directors, Paul O. Davis, Henry Wright, John Rex, and Kamper Nordland. Ex. Sec. Rita E. Miller. Chapter Headquarters, 3723 Wilshire Blvd., Los Angeles 5.

#### Spokane Chapter:

Richard H. Eddy, President; Harry C. Waller, Vice-President 1; Kenneth D. Stormen, Vice-President 2; Victor L. Wallf, Secretary, and Carl Johnson, Treasurer. Office 1023 W. Riverside Ave., Spokane, Washington.

#### Utah Chapter:

Howell O. Cannon, President; William J. Monroe, Jr., Secretary, 3707 South 32nd West Street, Salt Lake City 7, Utah.

#### Washington State Chapter:

Paul Thiry, President; John S. Dettle, 1st Vice President; Walter H. Rothe, 2nd Vice President; Robert H. Dietz, Secretary; Lawrence G. Waldron, Treasurer. Office 714 American Building, Seattle 4.

#### Toconia Society:

E. M. Dugan, President; P. G. Ball, Vice-President; Lyle Swedberg, Secretary-Treasurer.

#### Hawaii Chapter:

James C. Simms, President; Alfred Preis, Secretary, 1507 Kapiolani Blvd., Honolulu, T. H.

#### CALIFORNIA COUNCIL OF ARCHITECTS

John L. Rex, President; Wm. Koblik, Vice-President; Maurice I. Metz, Secretary-Treasurer. Executive Secretary office 3723 Wilshire Blvd., Los Angeles.

#### ALLIED ARCHITECTURAL ORGANIZATIONS

##### San Francisco Architectural Club:

Allied T. Kirkevoild, President; Charles Dennis, Vice President; William C. Thieleman, Treasurer; Milton Bromberg, Secretary. Office 507 Howard Street.

##### Producers' Council—Southern California Chapter:

Harold F. Smith, President; Gladding, McBean & Co.; Bert Taylor, Vice-Pres., Pittsburgh Plate Glass Co.; Richard Seaman, Sec., W. P. Fuller Co.; Clay Sizer, Treas., Minneapolis Honeywell.

Producers' Council—Northern California Chapter (See Special Page)

project will have an influence on housing throughout Europe.

Another aim of the program is to give progressive German architects a chance for the free expression of their ideas, which were stifled during the Nazi era of "monumental" architecture.

The American experts, sponsored by the Economic Cooperation Administration, will be headed by Dr. Walter F. Bogner, Boston architect and senior professor of architecture at Harvard University's School of Design. Other members of the "team" will include Mack A. Arnold of Greensboro, N. C., Bernard K. G. Wagner of Washington, D. C., William K. Wittausch of Washington, D. C., and Donald Monson, Detroit.

## NEUTRA LECTURES IN LOS ANGELES

Richard Neutra, Portland architect, gave an illustrated lecture on Public Housing at the Landau Gallery in Los Angeles recently. The lecture was open to the public.

## WINS BEST HOMES FOR FAMILY LIVING NATIONAL CONTEST

Jere Strizek, home builder of Sacramento (Calif.) has been awarded first place in a national contest sponsored by Parents' Magazine for the "Best Homes for Family Living" built during 1950.

Purpose of the competition is to "bring to the attention of the homebuying public the outstanding work of the nation's leading builders." The awards are made by districts and provide homes for an American family with two or more children.

The jury of award included Richard Bennett,

A.I.A.; Leonard Haeger, A.I.A.; William H. Scheick, A.I.A.; and Mrs. Maxine Livingston, editor.

**HOLLYWOOD JUNIOR**  
COMBINATION  
SCREEN and METAL SASH DOOR  
★  
The "WEATHER-WISE"  
DOOR!!

**A VENTILATING SCREEN DOOR  
A SASH DOOR  
A PERMANENT OUTSIDE DOOR  
ALL 3 IN 1!**

Discriminating home owners and architects have chosen Hollywood Junior as the TRIPLE DOOR VALUE in the COMBINATION SCREEN and METAL SASH DOOR field! A sturdy dependable door, constructed of quality materials, HOLLYWOOD JUNIOR'S EXCLUSIVE PATENTED FEATURES have outmoded old-fashioned screen doors and other doors of its type entirely! . . . . .

**IT GUARANTEES YOU YEAR 'ROUND  
COMFORT, CONVENIENCE and ECONOMY**

WE ALSO MANUFACTURE A COMPLETE LINE OF  
SHUTTERS, C. C. DOORS, SCREENS, SCREEN DOORS, LOUVER DOORS

**WEST COAST SCREEN CO.**  
1145 EAST 63rd STREET ★ LOS ANGELES, CALIFORNIA  
ADAMS 11338

★ ★ WRITE FOR FREE ILLUSTRATED LITERATURE ★ ★ ★

# WITH THE ENGINEERS

Structural Engineers Association of California  
Arthur W. Anderson, President; Harold P. King, Vice-president; Henry J. Deegenkolt, Sec.-Treas.; Office of Sec., 405 Montgomery St., Room 1121, San Francisco.

Structural Engineers Association of Northern California  
John E. Rinne, President; John J. Gould, Vice-President; Wm. W. Brewer, Sec.; Franklin P. Ulrich, Treas.; Directors, Walter L. Dickey, Leslie W. Graham, Hyman Rosenthal, and Howard A. Schirmer.

Structural Engineers Association of Central California  
William H. Petersen, President; Walter S. Wassum, Vice President; O. T. Illich, Sec. Treas.; Ernest D. Francis, M. A. Ewing, and Arthur A. Sauer, directors. Office O. T. Illich, c/o Div. of Arch., Sacramento.

American Society of C. E.  
San Francisco Section  
Clement T. Wiskocil, President; John S. Longwell, Vice-president; J. G. Wright, Vice-president; H. C. Medbery, Treasurer; R. D. Dewell, Secretary. Secretary's Office, 604 Mission St., San Francisco.

Structural Engineers Association of Southern California  
Donald F. Shugart, President; Harold P. King, Vice President; Robert J. Short, sec.-Treas.; Directors, William T. Wheeler, William T. Wright, Ernest C. Hillman, Jr., John Case, and John K. Minasian. Office, 202 Architects Bldg., Los Angeles 13.

Structural Engineers Association of Oregon  
R. Evan Kennedy, President; Guy H. Taylor, Vice President; James R. Griffith, Secretary-Treasurer; Directors Jerome A. McDevitt, H. Laren Thompson, and Robert L. Tidball. Offices, Portland.

Puget Sound Engineering Council (Washington)  
R. E. Kister, A. I. E. E., Chairman; E. R. McMillan, A. S. C. E., Vice Chairman; L. B. Copper, A. S. M. E., Secretary; A. E. Nickerson, I. E. S., Treasurer. Offices, L. B. Cooper, c/o University of Washington, Seattle 5, Washington.

American Society Testing Materials  
Northern California District  
L. A. O'Leary, Chairman; P. V. Garin, Vice-chairman; H. P. Hoopes, Sec. Office Sec., 1550 Powell St., Emeryville, Calif.

Society of American Military Engineers—San Francisco Post  
Capt. Cushing Phillips, CEC, USN, President; Col. W. C. Baker, Jr., CE, USA, Vice President; Robert P. Cook, Secretary; Levant Brown, Treasurer. Directors: Rear Admiral L. N. Moeller, CEC, USN; Capt. H. F. Ransford, CEC, USN; Clyde Bentley; Prof. Harmer E. Davis, Lieut. Col. James D. Strong, CE, USA; and Lieut. Col. Henry M. Smalley, CE, USA.

## ANNUAL ENGINEERING CONFERENCE IN TEXAS

The second annual National Conference on Coastal Engineering will be held at Houston, Texas, in November, according to an announce-

ment by Dr. Harold Vagtborg, president of Southwest Research Institute, San Antonio, Texas.

The conference is being co-sponsored by the Texas A. & M. Research Foundation, the University of Houston, the Rice Institute, the University of California, and the Houston Branch, Texas Section of the American Society of Civil Engineers.

The first conference was held last year in Long Beach, California, under the initiation of Dean M. P. O'Brien of the University of California.

Always specify  
**HAWS**  
for Highest Quality



**HAWS** Electric Water Coolers easily adapt to remote installations of **HAWS** Drinking Fountains... thus serving several locations.

• A COMPLETE LINE of coolers, fountains, faucets, equipment, filters and accessories. • A reputation for reliability since 1909. • Check in Sweets, or write for complete **HAWS** catalog.

**HAWS DRINKING FAUCET CO.**  
1441 FOURTH STREET (Since 1909) BERKELEY 10, CALIFORNIA  
Agents and Sales Representatives in All Principal Cities

## SIKORSKY RECEIVES GUGGENHEIM MEDAL

Igor Ivan Sikorsky has been awarded the Daniel Guggenheim Medal and certificate for 1951 "for a lifetime of outstanding contributions to aeronautics, including pioneering with multi-engine airplanes, flying boats, amphibians, and helicopters."

The Guggenheim Medal was created for the purpose of honoring persons who make notable achievements in the advancement of aeronautics. Provision for the Medal was made in 1928 by the gift of a fund from the Daniel Guggenheim Fund for the Promotion of Aeronautics. Selection of the medalist each year is made by a Board including all former recipients of this Medal who reside in the United States, and representatives of The American Society of Mechanical Engineers, the Society of Automotive Engineers, and the Institute of Aeronautical Sciences.

Dr. Sikorsky has been honored by several colleges and universities, and is a member of numerous scientific and professional societies, and the author of several well received books.



## STRUCTURAL ENGINEERS ASSOCIATION OF NORTHERN CALIFORNIA

A panel of experts spoke on the subject of "Fire and Earthquake Insurance — Their Relation to the Structural Engineers", at the regular October meeting in the Engineers' Club in San Francisco. Appearing on the program were Al Gilbert, general manager of the Pacific Rating Bureau; Robert Stevenson, manager Northern California, Nevada, and Alaska; Marshall Rouse, Schedule Department; and Karl V. Steinbrugge, earthquake department. Harold Engle, consulting engineer, served as moderator.

Final plans for the SEAC annual convention in Yosemite were announced, with indications pointing to an excellent attendance.

## SOCIETY OF AMERICAN MILITARY ENGINEERS — SEATTLE POST

"Chief Joseph Dam on the Columbia River" was the principal topic of discussion at a recent meeting of the Seattle Post of the Society of American Military Engineers held in The American Legion Club, Seattle.

Among those taking part in the discussions were Col. J. P. Buehler, District Engineer, Seattle District, Corps of Engineers; R. F. Bracelin, Civil Engineer, Seattle District; and M. F. Thomas, Electrical Engineer, Seattle District.

## RALPH PRIESTLEY RESIGNS CALIFORNIA POLYTECHNIC

Ralph Priestley, dean of the college of engineering, California State Polytechnic College at San Luis Obispo, has resigned to accept a position as an associate with the architectural firm of Kirby & Mulvin of San Francisco.

Prior to last March, Priestley was head of the Cal Poly architectural engineering department.

## AMERICAN SOCIETY FOR METALS PUGET SOUND CHAPTER

The first meeting of the new season under new officers, E. T. Carlson, Chairman; B. D. Mills, Jr., Vice-Chairman; and C. R. Lundy, Secretary-Treasurer was held in Seattle with Prof. J. A. Finley of the University of Washington Metallurgical Engineering Department leading a technical discussion on the subject of "Forming of Non-Ferrous Metals".

The discussion represented the first in a series of lectures on the formability of aluminum, magnesium and titanium alloys.

Prof. Finley devoted his discussion to the fac-

tors involved in forming aluminum, magnesium, and titanium alloys and the properties required to utilize these alloys.

Two of the factors involved in deep drawing or other methods of forming non-ferrous metals are grain size and annealing. Neither coarse grain nor dead soft material is desirable because it may lead to undesirable local deformation. Fine grain structures act as a barrier to plastic elongation and tends to minimize localized deformation.

The crystalline system in which metals solidify is another factor involved in forming operations. Metals are plastically deformed only along certain planes called slip planes. Aluminum is face centered cubic, which lends to good ductility. Aluminum can be modified by additions of copper to give precipitation hardening alloys. Copper is also face centered cubic, but because of difference in the size of the cube, it tends to distort the crystal lattice. By adding metals that solidify in a different crystalline system, such as the close-packed hexagonal system, greater distortion of the crystal lattice is attained while basically retaining the face centered cubic structure. This gives the alloy greater strength at a sacrifice of ductility and formability.

(See Page 31)



Always specify **HAWS**

FOR HIGHEST QUALITY

- Sanitary Drinking Fountains
- Electric Water Coolers
- Drinking Faucets, Equipment, Filters and Accessories

A reputation for reliability since 1909.  
Check in Sweet's or write for HAWS catalog.

**HAWS DRINKING FAUCET CO.**

1441 FOURTH STREET (Since 1909) BERKELEY 10, CALIFORNIA  
Agents and Sales Representatives in All Principal Cities

# PRODUCER'S COUNCIL PAGE

The National Organization of Manufacturers of Quality Building Materials and Equipment  
affiliated with THE AMERICAN INSTITUTE OF ARCHITECTS

President, Arthur C. Staat  
Natural Gas Equipment, Inc.  
1150 Folsom Street

Vice-President, Fred A. Figone  
Otis Elevator Company  
1 Beach Street

Secretary, Howard Noleen  
E. F. Hauserman Company  
500 Second Street

Treasurer, A. L. West, Jr.  
Aluminum Company of America  
Russ Bldg.

Edited by Carl B. Frank, DETROIT STEEL PRODUCTS CO.

## October Meeting

We mentioned in our last article that our October meeting would be held on the 15th and would be conducted jointly by the Wakefield Brass Company and the P. G. & E. Company. The general theme of the meeting will be on lighting and the program will be conducted by Mr. Ted Bateman of the Wakefield Brass Company. We bring this again to your attention, as this meeting is to be held at the Athens Club in Oakland with the majority of the invited guests from the East Bay A. I. A. It is the general policy of the chapter to hold one meeting a year in the East Bay, and based on the enthusiastic turn out that we always get from the architects, we feel sorry that we cannot have more than one meeting a year for them.

## How to Figure Metal Weights in Filing CMP Requirements

In discussing the problem with various members of the local chapter, we find that there is considerable confusion concerning just what materials have to be listed by weight under NPA's new construction regulations M-4A, Direction 1, etc., and we think perhaps that the following article quoted from our National "Council News" would be of assistance to the readers.

"One of the more puzzling problems arising from NPA's new construction regulations (M-4A, Direction 1, etc.) centered on the question of which products are to be counted in using the self-certification plan for smaller buildings and in showing required quantities of Class A products on Form CMP-4C.

"NPA has refused to issue an official list of the Class A building products whose weights must be computed, but unofficially they agree that the following list covers all products involved:

**"Steel:** nails, reinforcing bars, sheet metal for flashing and termite shields, all steel pipe and tubing, flat sheet metal for roofing, structural steel (not permitted in residential construction when self-allotment plan is used).

**"Copper:** tubing and pipe, flashing and termite shields, electric wire and cable (copper content only).

**"Aluminum:** permitted only in industrial construction.

"However, there are some exceptions: In computing the weight of steel pipe, weight of couplings must be included if they come with the pipe, not if they are bought separately; only flat steel sheets must be counted now; wire mesh need not be counted now.

"All other building materials are considered Class B products until further notice. In using Form CMP-4C, weights of Class A products must be listed individually, but only dollar values need be shown for Class B products."

As an example of the above, certain steel items such as windows, doors, floor and roof panels, wall panels, etc., are not considered Class A products. On the other hand, structural steel shapes and reinforcing bars are generally Class A products and must be computed by weight.

## Between and Between

At this writing our own chapter news is a scarce item as the National Presidents Meeting in Washington, D. C. is winding up on the 28th with the Architect's Convention starting the first part of October.

We hope that next month's issue will give you a full report of the chapter members' activities in these two important portions of our continual program.



USE QUALITY PRODUCTS

CONSULT AN ARCHITECT

## WITH THE ENGINEERS

(From Page 29)

Magnesium solidifies in a close packed hexagonal system. Only the basal planes in the hexagonal system are slip planes at room temperatures. By heating magnesium alloys to 300-400 F. the face planes also become slip planes so that greater ductility and formability is attained. As with aluminum, any alloying additions that distort the symmetry of crystal lattice adds to the strength of the resulting alloy.

Titanium also solidifies in the close packed hexagonal system and is characterized by rapid work hardening, similar to that experienced with magnesium.

Although titanium is the fourth most abundant metal, it has not been used to a great extent to date because of the difficulty and expense of producing it from its natural forms. It has a strong affinity for oxygen, nitrogen, and carbon, which have the embrittling effect. Additions of manganese and aluminum produce alloys with tensile strengths of 180,000 psi.

Generally speaking, in order for a light alloy to replace a heavier alloy, the ratio of the tensile strengths must be at least equal to the ratio of the specific gravities. For example, steel has a specific gravity of approximately 7.9 and titanium has a specific gravity of about 4.5. Therefore, in order for titanium to replace a steel with a tensile strength of 210,000 psi, the titanium must have a tensile strength of about 120,000 psi.

A certificate was awarded C. R. Jackson for his service as past chairman of the Puget Sound Chapter, and it was announced that Harry Evans has been appointed a member of the Metallurgical Advisory Committee on substitute steels by Walter Jominy, president of the American Society for Metals.

## STRUCTURAL CLAY PRODUCTS INSTITUTE CONVENTION

Effects of government defense regulations on the future of the brick and tile industry will be the main topic for consideration at the annual convention of the Structural Clay Products Institute at its annual convention in White Sulphur Springs, West Virginia, on October 29-31.

Speakers from the Office of Price Stabilization, the National Production Authority, and the United States Chamber of Commerce will discuss the operations of the industry under government controls.

Other guest speakers will include William Nelson, of the Mason Contractors Association; Edward H. Gavin, editor; Harry Bates, president of the Bricklayers, Masons and Plasterers' International Union, and Ralph Walker, architect and immediate past president of the A.I.A.

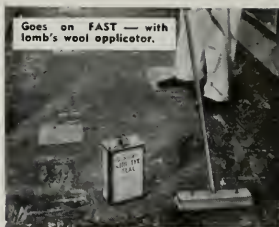

Goes on FAST — with lomb's wool applicator.

it's **new**

it's *Here*

# HIL-TEX

**HILLYARD'S Sensational Seal!**

## TAKES THE GUESS AND WORK OUT OF RESILIENT FLOOR CARE!

**At last!** A seal to ease maintenance, prolong life of asphalt tile, rubber tile, all floors of a porous or semi-porous nature (including terrazzo and cement, with the exception of wood). HIL-TEX fills pores and hair cracks to provide a smooth even surface, preparing a bond between the floor and the surface treatment.

**HIL-TEX has been thoroughly tested 'ON THE FLOOR' IN HOSPITALS, SCHOOLS, INSTITUTIONS, INDUSTRIAL AND COMMERCIAL BUILDINGS!**

**The Low Cost Protection You've Been Wanting for Floors**

- one coat takes the place of many expensive finish coats.
- complete protection against water, dirt, grease.
- tremendous coverage (1,500 sq. ft. on some floors).
- brings to life colors which have become dull or faded. Won't soften or bleed colors. Saves maintenance time.
- resists deterioration from spillage of alcohol, gasoline, mineral spirits, paraffin oil.
- is not harmed by acid or alkaline salts (present in certain floorings), stoves, off obsolescence of floor, or ozone or fading action.
- HIL-TEX is highly resistant to ozone or fading action of Ultra Violet Light.
- "anti-slip" coefficient of friction 50% greater than minimum insurance requirements (non-flammable) (U.S.)

**SAFETY MEN APPROVE IT . . .** with an "anti-slip" coefficient of friction 50% greater than minimum insurance requirements (non-flammable) (U.S.)

**FLOORING CONTRACTORS RECOMMEND IT . . .** contains no solvents, caustic, acids, other ingredients to injure or wear out sensitive surfaces.

**MAINTENANCE MEN PRAISE IT . . .** keeps floors in A-1 condition at all times with only half the work.

**ARCHITECTS SPECIFY IT . . .** for floors of greater beauty at a minimum cost to clients.

**RUBBER FLOORING MANUFACTURERS ASSOCIATION ENDORSE IT . . .**

*On Your Staff Not your payroll!*

*See for Yourself What HIL-TEX can do!*

SEE OUR CATALOG IN SWEET'S



MAIL THIS COUPON! FREE DEMONSTRATION!

Hillyard Chemical Company Dept. N 1-10  
St. Joseph, Missouri

Please arrange for a FREE HIL-TEX demonstration on a..... floor.

Send me all the facts about HIL-TEX.

Name.....Title.....

Institution.....

Address.....State.....

City.....State.....

**HILLYARD**

HANDLE WITH CARE!

HILLYARD CHEMICAL CO.  
St. Joseph, Mo.

# More **HEAT** from **Less** **Oil**

## **J** You get more for your money with a modern, automatic **JOHNSON BURNER**

You'll like the fuel-savings that a Johnson Burner will give you. And you'll like its quiet, carefree dependability. If you are still using old-style, wasteful equipment, let your Heating Engineer show you what a difference an automatic Johnson Burner can make in your fuel and service bills.

There's a Johnson Burner for every heating need . . . all precision-built to last . . . all engineered to maximum efficiency . . . all backed by a

48-year record of leadership. See the Johnson Burner dealer near you.



### **S. T. JOHNSON CO.**

940 Arlington Ave.  
Oakland 8, California

401 No. Broad Street  
Philadelphia 8, Pa.

### **PARKHURST SPEAKS BEFORE CHEMICAL INDUSTRY MEET**

G. L. Parkhurst, vice-president of the Standard Oil Company of California, presented a paper entitled "Resources for Chemical Industry — The Far West" at the American Chemical Society Symposium recently held in New York City.

The importance of the chemical industry in the west and the great developments within the industry were highlighted by Parkhurst's remarks.

### **STRENGTHENED CORE DESIGN**

(From Page 17)

pitals in a city liable to attack by A-bombs should be designed to survive and function after an attack, and should obviously be made blast-resistant. At Hiroshima, when the city was confronted with its greatest catastrophe, only 10% of its medical facilities and personnel were left to meet the crisis.

However, doctors do not like hospitals without windows. And in all honesty, hospitals (or any other buildings) with windows can be made adequately safe through a variety of not too costly adaptation.

#### **The Windowless Wing**

One solution, if the building has several wings,



**Your best and nearest source for standard and special Bronze products**



STABILITY since 1854

## **M. GREENBERG'S SONS**

765 Folsom St • San Francisco • Calif • EXbrook 2-3143

Manufacturers of Fire Hydrants and Fire Protection  
Brass Goods • Industrial, Navy and Maritime  
Bronze Valves and Fittings • Plumbing and  
Hardware Brass Specialties • Bronze Plaques,  
Letters and Name Plates.

LOS ANGELES • SEATTLE • PORTLAND • SPOKANE • SALT LAKE CITY • DENVER • EL PASO • NEW YORK • HARTFORD • WASHINGTON, D. C.



is to construct one of the wings without windows, using shear-wall design, and in that wing concentrate as far as possible the essential utilities and facilities, the stairs and elevators. In this windowless wing, the occupants of the other normally lighted and ventilated wings on each floor can take shelter as soon as they have warning.

#### The Windowless Story

A variation of the same conception is to construct the lower story (or stories) without windows. With this arrangement, the occupants of upper stories can descend to the strong windowless portion to take shelter; and such shelter area is also accessible to people on the street.

#### The Strengthened Core

The foregoing designs are more acceptable to most people than completely windowless box-like buildings, but a still better solution seems available in a design which retains the normal quota of windows on the exterior, but provides a blast-resistant interior "core" constructed of heavy shear

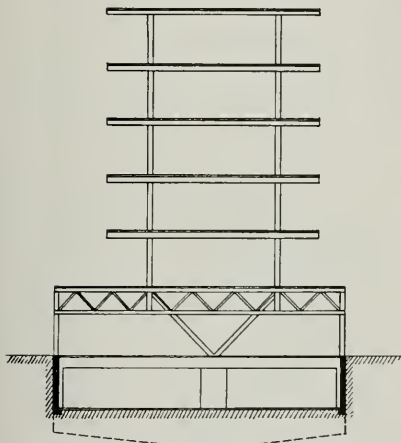

Section Design

walls, just as in naval construction it is usual to give a battleship heavily armored "vitals" surrounded by lighter parts. This seems about as far as it is possible to develop a conventional blast-resistant design for a building with normal fenestration.

In these types of buildings, the windows are retained at the cost of considerable blast damage to the inside of the normally constructed portions outside the "core". Such damage should not, however, be invited by use of exterior curtain walls (which may disintegrate into missiles). Reinforced concrete panels, (which may hold up well in spite

The trend is to **QUALITY**  
in lighting equipment



MEANS  
TOP  
QUALITY  
ALWAYS!



SMOOT-HOLMAN COMPANY Inglewood, Calif. Offices in Principal Western Cities • Branch and Warehouse in San Francisco



## A Combined

Landscape Architecture  
and Contracting Service

for

Tract, Industrial and Residential  
Development

We can do the Complete Job for you

- Landscape Architecture
- Finish Grading and Landscaping
- Asphalt Drives and Parking Lots

**HENRY C. SOTO CORPORATION**  
*Landscape Contractors*

13000 SO. AYALON BLVD. LOS ANGELES 61, CALIF.  
Phone MEIno 4-6617



Specify Utility equipment!—The one sure way to avoid the headaches of an installation that just doesn't measure up to your specifications. You're sure with Utility because it sets the industry standard for quality and performance.

#### A FULL RANGE OF UTILITY HEATING EQUIPMENT

**Floor Furnaces**—45,000 BTU/Hr. input, flat and dual; also, 60,000 BTU/Hr. input, flat and dual (both sizes, shallow-type construction). **Wall Heaters**—Single—27,500 BTU/Hr. input; Dual—35,000 BTU/Hr. input and 50,000 BTU/Hr. input. **Forced Air Furnaces**—70,000 BTU/Hr. input to 150,000 BTU/Hr. input. **Unit Heaters**—65,000 BTU/Hr. input to 225,000 BTU/Hr. input. All Utility Heating Equipment is tested and approved by A.G.A.



#### UTILITY EVAPORATIVE AIR COOLERS AND VENTILATING EQUIPMENT FOR EVERY PURPOSE

Utility's air delivery tables are complete and authentic, derived from tests made in accordance with A.S.H.V.E. test codes. Every Utility cooler is tested in accordance with these same codes. You can meet every requirement with Utility. The line includes evaporative coolers, both Fan and Blower types... sizes to meet all requirements.

#### SEND FOR AIA ENGINEERING INFORMATION

For this complete technical data on Utility equipment, plus valuable tables, charts, installation details, write (on your letterhead) to Engineering Dept. Counsel from a Utility Engineer available without charge.

UTILITY APPLIANCE CORP.  
4851 S. Alameda Street, Los Angeles 58, California



EVAPORATIVE AIR COOLERS GAS-FIRED FURNACES  
VENTILATING EQUIPMENT

Manufacturers of Gaffers & Sattler and Occidental Gas Ranges

of the entering blast), should replace curtain walls in all cases.

At openings into the strong shear-wall portion of the building, blast-resistant doors or baffle arrangements may be used for excluding flying debris.

In order to facilitate the emergency rehabilitation of the conventionally constructed portions and make them quickly re-usable after an attack, wood "nailing strips" provided around window openings might be useful for attaching materials to keep out the weather where glass has been blown in; or, if money is available, some sort of "safety" window might initially be provided.

Another solution is to provide in-swinging casements in all openings designed to open automatically under blast pressures not strong enough to make flying glass a hazard.

Under guidance of the Federal Civil Defense Administration, a few government hospitals in critical cities are being designed incorporating some of the design principles rather sketchily outlined above. Other "essential facilities" in critical areas may be expected to follow the lead.

Thus for the atom age there seems to be emerging a design of building combining a normal exterior, providing light and air to outside rooms with a blast-resistant interior of heavy shear-wall and

ARTHUR FROELICH, A. I. A., ARCHITECT  
PARDEE CONSTRUCTION CO.,  
BUILDER



This dramatic tartan tower of Porcelain Enamel heralds patrons to McDaniel's Shop 'N Save, North Canon Drive, Beverly Hills. Whenever you seek a custom effect—a clean, sleek exterior—specify this year-ahead product that stands alone... and stands for life...

#### PORCELAIN ENAMEL VENEER

Write, today, for fact-filled brochure!



roof construction, designed for plastic yield, within which the building's occupants and its essential facilities may be given a good degree of protection from damage by atom bombs.

## INTERNATIONALS CHEMICALS

(From Page 20)

with merchandise display shelves and built-in storage space. Spacious cabinets at the back of the general office provide storage space, with one of the units containing a wash basin; others are used for office records, files, and supplies. The face of these cabinets are pressed cork and are used to display samples of advertisements, pictures of products, pamphlets, and other types of promotional material.

The wall-partition which separates the secretary-receptionist's work space from the executive manager's private office, is also constructed so that it contains built-in storage space.

Indirect overhead lighting with spot-light beams for additional light in desired areas is provided. Office equipment, or desks, are placed in the super-lighted spots, thus adequate lighting is provided without depending upon normal daylight conditions.

Acoustic tile ceilings are used throughout the offices and wall-to-wall carpets have been installed in the private office and general office space. Asphalt tile floors are used in the storage room and hall. Gray plaster walls, gray with salt and pepper tape venetian blinds, and special upholstered furniture and fabrics complete the furnishings.

## BOMB SHELTERS

(From Page 9)

that suspended ceilings and overhead fixtures are at a minimum. Large amounts of glass in windows, partitions and showcases are a hazard and have been avoided.

### Other Requirements

"The shelter area must lend itself to the orderly movement of large groups; that is, it must be located in a building that is either open at all times or maintained with attendants on a 24-hour basis. Rooms containing boiler, heavy equipment and hazardous piping such as ammonia piping have been avoided.

"Co-operation by building owners and managers has been splendid. Recognition that this is a community problem has been widespread and this recognition has resulted in a desire to shelter tenants, customers and the public that may be in the immediate vicinity. Only mutual benefit can result from such a planned and orderly movement in the event of a disaster."

## FORDERER CORNICE WORKS

Manufacturers of

Hollow Metal Products • Interior Metal Trim  
Elevator Fronts and Cabs  
Metal Plaster Accessories • Sanitary Metal Base  
Flat and Roll Metal Screens  
Metal Cabinets • Commercial Refrigerators

269 POTRERO AVE.

SAN FRANCISCO, CALIF.

HEMLOCK 1-4100

## Parker, Steffens & Pearce

BUILDERS

135 South Park, San Francisco

Phone: EXbrook 2-6639

## BARRETT & HILP

CONTRACTORS

*Builders of the West*

918 Harrison Street • San Francisco  
Telephone DOuglas 2-0700

234 West 37th Place • Los Angeles  
Telephone ADams 3-8161

**Brown's**  
STANDARD

The resilient building paper creped to S-T-R-E-T-C-H

Quality Products Since 1895

**ANGIER PACIFIC CORPORATION**  
18 NEW MONTGOMERY ST. 7424 SUNSET BOULEVARD  
SAN FRANCISCO 5, CALIF. LOS ANGELES 48, CALIF.

A complete line of Angier products available from your building material dealer.

## STOP

Penetration Of  
**MOISTURE**  
**WIND**  
**DUST**  
**VERMIN**

EVERLASTING  
PROTECTION

**CLINTON  
CONSTRUCTION CO.**  
OF CALIFORNIA

**General Contractors**

923 FOLSOM STREET • SAN FRANCISCO

SUtter 1-3440

**HOGAN LUMBER CO.**

Wholesale and Retail

**LUMBER**

MILL WORK • SASH & DOORS

Office, Mill, Yard and Docks

SECOND AND ALICE STREETS • OAKLAND, CALIF.

Telephone GLencourt 1-6861



**COSTS 50%  
LESS THAN "BULK" or  
"BLANKET" TYPES OF INSULATION  
... AND, IN ADDITION, ACTS AS A VAPOR-  
BARRIER (MEETS FHA REQUIREMENTS). COSTS  
LESS TO APPLY. WRITE FOR SAMPLES AND  
FULL INFORMATION ON ALL USES!**

**The SISALKRAFT CO.**

55 New Montgomery St. San Francisco 5, California

**JUDSON PACIFIC-MURPHY CORP.**

Steel Fabricators  
and  
Erectors

REINFORCING STEEL  
STRUCTURAL STEEL  
BRIDGE CRANES

4300 EASTSHORE HWY.  
EMERYVILLE, CALIF.

Phone:  
OL 3-1717

**BOOK REVIEWS**  
PAMPHLETS AND CATALOGUES

**SIMPLIFIED MECHANICS AND STRENGTH OF MATERIALS.**  
By Harry Parker, M.S. John Wiley & Sons, Inc., Publishers.  
New York. Price \$4.00.

The author, Harry Parker, M.S., is Professor of Architectural Construction in the School of Fine Arts at the University of Pennsylvania, and in preparing this book has presented a technical discussion on the subjects of Mechanics and Strength of Materials and eighteen Chapters on various material items.

The book has been written to use as a text book in courses in mechanics and strength of materials and for the use by practical men interested in mechanics and construction.

Harry Parker, M.S., is the author and co-author of a number of other books on the subject of mechanics and materials.

**PRACTICAL ELECTRICITY AND MAGNETISM.** By Maurice Rubin, LL.B., B.S., E.E. Published by Chemical Publishing Company, Inc., New York.

Practical Electricity and Magnetism is an elementary survey of electricity and magnetism, with special emphasis on recent developments in magnetism.

The author devoted considerable time during the late War in Western Electric Company and Bell Telephone Laboratories working on magnetic problems arising in radar systems and devotes some space in his book to the subject of new metals and magnetic alloys.

The book will be of interest and value to anyone interested in electricity and magnetism—students, and engineers.

**PRACTICAL BASE BOARD HEATING.** By Charles H. Burkhardt. Plumbing and Heating Journal. Publishers, New York City. Price \$1.00.

This book is a guide to the sizing, design and installation of base board heating systems. It contains a large number of photographs, drawings, designs, and charts on the subject of heating.

**BUILDING CODE REQUIREMENTS FOR REINFORCED CONCRETE.** Published by the American Concrete Institute, Detroit, Michigan. Price 50c.

Building Code Requirements for Reinforced Concrete has been adopted as a Standard of the American Concrete Institute and allows for improved properties of new style deformed reinforcing bars; decreases the allowable bond stress in plain bars, and increases the allowable bond stresses for the new type bar.

The Code covers the proper design and construction of reinforced concrete buildings, and has been written so that it may be incorporated verbatim or adopted by reference in a general building code.

**NEW CATALOGUES AVAILABLE**

Any of the catalogues or folders described here may be obtained by forwarding your request as indicated in the coupon below to the office of the ARCHITECT & ENGINEER. Merely mark the items you want and dip or paste the coupon to your letterhead.

**314. ACOUSTICAL PLASTER**

Coralux Acoustical Plaster—a detailed brochure on Schundler Coralux Acoustical Plaster with additional information on Coralux Finish Coat. The brochure contains actual blown up photographs of acoustical surface as well as complete instructions on applying material and additional specification and performance data. 4 pages, illus., 9/18/51.

**315. VINYLIZED WALL FABRIC**

A detailed but non-technical discussion of the qualities and performance of Joanna Vinylized Wall Fabric, new plastic-cloth material developed to cut decorating costs for institutions, is contained in an illustrated brochure recently published by the



manufacturers, Joanna Western Mills Company. The booklet, available to institution executives on request, is a step-by-step presentation of the construction, application, wearing qualities and recommended uses of the vinyl-coated fabric. 8 pages, illus. 9/51.

### 316. OPEN STEEL FLOORING

An Idea-Book—"Versatile—Open Steel Flooring" has just been published by the Open Steel Flooring Institute, Inc., Pittsburgh, Pa. The book is profusely illustrated with installation photographs showing the many and varied possibilities for using steel grating. It explains types and features of open steel flooring and specifications for insuring quality open steel flooring and its proper installation. A.I.A. 14-P-21, 16 pages, illus. 9/7/51.

### 317. INVISIBLE WATER REPELLENT FOR ABOVE GRADE MASONRY

A product manual covering the properties of Silaseal, a transparent, colorless silicone-base masonry seal with water repellent qualities for above-grade exterior application has just been released by the Surface Protection Company. The manual covers all applications of Silaseal for concrete, brick, stone, cement block, stucco unglazed tile and any type of masonry. A.I.A. 25-B-3; B-E-2; 7-B-2, 4 pages with tables, 6/1/51.

### 318. GALVANIZED APARTMENT CASEMENT WINDOWS

"Fenestra Hot-Dip Galvanized Apartment Casement Windows," a new catalog by Detroit Steel Products Company, describes maintenance-free steel casements for multi-family dwelling units. These windows require no pointing, except when desired for decorative purposes, and are now being galvanized in Fenestra's own hot-dip galvanizing plant, believed to be the only plant in this country designed especially for the treatment of steel windows. Window designs, advantages, construction features, hardware and screens are discussed, and the literature also pictures available types and gives sizes of Fenestra apartment casements and complete specifications. RE 805, 4 pages illus., 1/51.

### 319. NEW CEMENT MIXER

Chain Belt Co., manufacturers of the Rex line of construction equipment, announces the publication of a new truck mixer bulletin on its Horizontal and Adjusta-Hite Moto-Mixers. This new bulletin is "loaded" with detail, "concrete" information which every operator interested in pre-mixed and truck mixed concrete will want to know. 51-29, 24 pages illus. 7/20/51.

### 320. THREE DIMENSIONAL PLANNING

"Visual" Planning Equipment Company, Inc., announces that it has a new catalog available on request. This catalog contains the "whys" of 3-dimensional planning, explains the functions and advantages of such planning in full detail, outlines and illustrates "Visua's" Repro-Templet System of producing reproduction prints. 80 pages illus., 9/5/51.

### 321. NEW SOUND TRANSMISSION DATA FOR PLASTER PARTITIONS

A new leaflet has just been released by the Perlite Institute covering the analysis of the Riverbank Acoustical Laboratories on the sound reduction decibels of perlite gypsum plaster. Tables are also included on the comparative ratios of other types of plaster and their decibel ratings. A.I.A. 21A5 & 21C1—4 pages illus., 9/51.

#### ARCHITECT AND ENGINEER

68 Post Street, San Francisco, Calif.

I would like to have a copy of each of the New Catalogues I have circled.

314	315	316	317
318	319	320	321

Please send to the address on my letterhead, or as I have indicated, and to my attention. (Please print your name — no literature will be sent on this coupon after November, 1951.—A. & E.)

## VERMONT MARBLE COMPANY

DOMESTIC AND IMPORTED MARBLES  
GRANITE VENEER

525 MARKET STREET • SAN FRANCISCO

Phone: SUtter 1-6747

3522 COUNCIL STREET • LOS ANGELES

Phone: DUckirk 2-7831

The Most Complete Line of  
STEELS and STEEL BUILDING MATERIALS  
Made by a Single Producer



See Sweet's Catalog File or write us for  
full information.

REPUBLIC STEEL CORPORATION

GENERAL OFFICES: CLEVELAND, OHIO

DENVER, COLORADO . . . . . CONTINENTAL OIL BUILDING  
LOS ANGELES, CALIF. . . . . GENERAL PETROLEUM BUILDING  
SAN FRANCISCO, CALIFORNIA . . . . . RIALTO BUILDING  
SEATTLE, WASH. . . . . WHITE-HENRY-STUART BUILDING

## PACIFIC MANUFACTURING CO.

High Class Interior Finish Quality  
Millwork

16 Beale St., San Francisco  
GARfield 1-7755

2215 El Camino Real, San Mateo  
S. M. 5-0687

304 Bryant Street, Palo Alto  
P. A. 3373

2610 The Alameda, Santa Clara  
S. C. 607 (Factory)

6820 McKinley Avenue, Los Angeles  
THornwall 4196

MAIN OFFICE — SANTA CLARA

## "AMERICAN - MARSH"

CONDENSATION UNIT

Pumping  
Machinery  
for  
Every  
Purpose

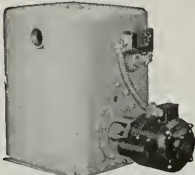

For Service  
Call  
DOuglas  
2-6794

or

MUtual 8322

SIMONDS MACHINERY CO.

SAN FRANCISCO  
816 FOLSOM

LOS ANGELES  
455 EAST 4TH

## CHAMBER OF COMMERCE SEEKS CLARIFICATION

The Chamber of Commerce of the United States has asked the Federal government for immediate clarification of its policy regarding the volume of non-defense construction that can be begun in 1952.

The Chamber's position was made known in a statement by Ralph Walker, president of the American Institute of Architects, and chairman of the Chamber sub-committee on Construction Mobilization.

Associated with Walker on the subcommittee are Carlton S. Proctor, recently nominated for the presidency of the American Society of Civil Engineers, and representatives of major divisions of the construction industry.

"Recent contacts with architects all over the country," said Walker's statement, "reveal a serious situation. While many of the large offices are busy on defense construction plans, a great many small offices are marking time. Non-defense projects of the type that make up the backbone of normal construction are not coming in because of the uncertainties of the future.

"Few laymen realize the extent of the preliminary work that must be done before new construc-

tion can get under way. Detailed materials and equipment must be ordered and manufactured, permits must be secured, and numerous other details taken care of. Empty drawing boards thus forecast unemployment next year."

The committee has asked government consideration of 1) clarification of the approximate volume of non-defense construction that can go forward in 1952, 2) a better scheduling of defense construction on the part of government, 3) greater emphasis on development and substitute of materials and methods, and 4) emergency defense agencies should make more frequent and more intensive use of the practical experience of the construction industry.

## STANDARD PROPOSED FOR PLUMBING FIXTURES

A recommended standard terminology for supply fittings for plumbing fixtures has been proposed jointly by the Enameled Cast Iron Plumbing Fixtures Association and the Vitreous China Plumbing Fixtures Association.

Purpose of the standardization is to bring about a better understanding of terminology pertaining to supply fittings and their installation in plumbing fixtures. The proposal has been widely circulated among all sanitary brass manufacturers and to all manufacturers of plumbing fixtures, and the terminology as it now stands represents the composite and unanimous recommendation of those concerned.

## STANDARD GRADE RULES FOR REDWOOD LUMBER

The California Redwood Association has announced that standard grading rules for redwood lumber now permit shipment of dressed finish in all lengths from three to twenty feet, and that standard lengths are now three to twenty feet in multiples of 1-foot or 2-feet for dressed finish and for all yard grades worked to bevel, bungalow and colonial siding, ceiling, wall boarding, drop siding, rustic, and similar patterns.

The change made to conserve lumber, extends the shipping of odd lengths, heretofore permissible only in lengths shorter than 10-feet, to the longer lengths. It also reduces the standard lengths from 6-20 feet to 3-20 feet for dressed finish for casing, and base. No change has been made for rough finish or other yard grades, rough or dressed.

CHURCHES—an interesting publication has been issued by Timber Engineering Company, Washington, D. C. dealing with the construction of "Churches" . . . many illustrations are used.

## VALUABLE NEWS SERVICE

- BUILDING MATERIAL DEALERS
- CONTRACTORS
- ENGINEERS
- FINANCIAL INSTITUTIONS

**ARCHITECTS REPORTS** gives advance news on construction projects in Northern California, lists: name of projects, location, architect, proposed cost and other pertinent information.

**HANDY** individual slip-reports, issued daily at a total cost of only

\$10 a month

## ARCHITECT'S REPORTS

Published Daily

The ARCHITECT and ENGINEER, Inc.

68 Post Street, San Francisco - DO 8311

# ESTIMATOR'S GUIDE

## BUILDING AND CONSTRUCTION MATERIALS

PRICES GIVEN ARE FIGURING PRICES AND ARE MADE UP FROM AVERAGE QUOTATIONS FURNISHED BY MATERIAL HOUSES TO SAN FRANCISCO CONTRACTORS. 3% SALES TAX ON ALL MATERIALS BUT NOT LABOR

All prices and wages quoted are for San Francisco and the Bay District. There may be slight fluctuation of prices in the interior and southern part of the state. Freight charge, at least, must be added in figuring country work.

**BONDS—Performance or Performance plus Labor and Material Bond(s), \$10 per \$1000 on contract price, Labor & Material Bond(s) only, \$5.00 per \$1000 on contract price.**

### BRICKWORK—MASONRY—

Common Brick—Per 1 M laid—\$100.00 up (according to class of work).  
Face Brick—Per 1 M laid—\$200.00 end up (according to class of work).  
Brick Steps—\$3.00 and up.  
Common Brick Veneer on Frame Bldgs.—Approx. \$1.20 and up—(according to class of work).  
Face Brick Veneer on Frame Bldgs.—Approx. \$2.00 and up (according to class of work).  
Common Brick—\$36.00 per M—truckload lots, delivered.  
Face Brick—\$81.00 to \$106.00 per M, truckload lots, delivered.

### Gleazed Structural Units—

Clear Gleazed—  
2 x 6 x 12 Furring ..... \$1.60 per sq. ft.  
4 x 6 x 12 Perflation ..... 1.90 per sq. ft.  
4 x 6 x 12 Double Faced  
Perflation ..... 2.25 per sq. ft.  
For colored glaze add .30 per sq. ft.  
Metal Fire Brick—\$105.00 per M—F.O.B. Pittsburg

Fire Brick—Per M—\$111.00 to \$147.00.

Cartage—Approx. \$10.00 per M.

Paving—\$75.00.

### Building Tile—

6 5/8 x 12-inches, per M ..... \$139.50  
6 5/8 x 12-inches, per M ..... 105.00  
4 5/8 x 12-inches, per M ..... 84.00  
**Hollow Tile—**  
12 x 12 1/2-inches, per M ..... \$146.75  
12 x 12 1/2-inches, per M ..... 156.85  
12 x 12 1/2-inches, per M ..... 177.10  
12 x 12 1/2-inches, per M ..... 235.30  
F.O.B. Plant

### BUILDING PAPER & FELTS

1 ply per 1000 ft. roll ..... \$5.30  
2 ply per 1000 ft. roll ..... 7.80  
3 ply per 1000 ft. roll ..... 9.70  
Brownkin, Standard 500 ft. roll ..... 6.85  
Sisalcraft, reinforced, 36 in. by 500 ft. roll ..... 7.00

### Sheathing Papers—

Asphalt sheathing, 15-lb. roll ..... \$2.00  
30-lb. roll ..... 2.79  
Dampcourse, 216-ft. roll ..... 2.95  
Blue Pasterboard, 60-lb. roll ..... 5.10

### Felt Papers—

Deadenning felt, 3/4-lb., 50-ft. roll ..... \$3.23  
Deadenning felt, 1-lb. .... 3.79  
Asphalt roofing, 15-lb. .... 2.00  
Asphalt roofing, 30-lb. .... 2.79

### Roofing Papers—

Asphalt Rig., 15 lb. .... \$2.09  
Standard Grade, 108-ft. roll, Light ..... 1.87  
Smooth Surface, Medium ..... 2.18  
Heavy ..... 2.56  
M. S. Extra Heavy ..... 2.96

### BUILDING HARDWARE—

Sash cord com. No. 7 ..... \$2.65 per 100 ft.  
Sash cord com. No. 8 ..... 3.00 per 100 ft.  
Sash cord spot No. 7 ..... 3.65 per 100 ft.  
Sash cord spot No. 8 ..... 3.35 per 100 ft.  
Sash weight, cast iron, \$100.00 ton ..... \$3.75  
1-ton lots, per 100 lbs. .... \$4.75  
Less than 1-ton lots, per 100 lbs. .... \$4.75  
Nails, per keg, base ..... \$11.80  
8-in. spikes ..... 11.80  
Rim Knob lock sets ..... 11.80  
Butts, dull brass plated on steel, 3/4 x 3/8 ..... .76

### CONCRETE AGGREGATES—

The following prices set to Contractors unless otherwise shown. Carload lots only.

	Bunker per ton	Del'd per ton
Gravel, all sizes	\$2.44	\$2.90
Top Sand	2.38	3.13
Concrete Mix	2.38	3.04
Crushed Rock, 1/4" to 3/4"	2.38	2.90
Crushed Rock, 3/4" to 1 1/2"	2.38	2.90
Roofing Gravel	2.81	2.90
River Sand	2.50	3.00
Sand—		
Lapis (Nos. 2 & 4)	3.56	3.94
Olympia (Nos. 1 & 2)	3.56	3.88

### Cement—

Common (all brands, paper sacks), carload lots, \$3.55 per bbl. f.o.b. car; delivered \$3.63.  
Per sack, small quantity (paper) ..... \$1.05  
Carload lots, in bulk per bbl ..... 2.79  
Cash discount on carload lots, 10c a bbl., 10th Prox., less than carload lots, 40c a bbl., 10th f.o.b. warehouse or delivered.  
Cash discount 2% on L.C.L.

Trinity White } 1 to 100 sacks, \$3.13 sack  
Madusa White } warehouse or del.; \$9.56  
bbl. carload lots.

### CONCRETE READY-MIX—

1-2-4 mix, to 10 yards\* ..... \$12.00  
10 to 100\* yards ..... 11.00  
100 to 500 yards ..... 10.50  
Over 500 yards ..... 10.30  
\* Delivered to site.

### CONCRETE BLOCKS—

	Hay-dite	Ba-salt
4 x 8 1/2-inches, each	\$17	\$18
6 x 8 1/2-inches, each	22	22.5
8 x 8 1/2-inches, each	26	26
12 x 8 1/2-inches, each	34	39
12 x 8 1/2-inches, each	40	40

**Haydite Aggregates—**  
3/4-inch to 3/8-inch, per cu. yd. .... \$7.25  
3/8-inch to 3/16-inch, per cu. yd. .... 7.25  
No. 6 to 0-inch, per cu. yd. .... 7.25

### DAMP-PROOFING and Waterproofing—

Two-coat work, \$9.00 per square.  
Membrane waterproofing—4 layers of saturated felt, \$10.00 per square.  
Hot coating work, \$5.00 per square.

Madusa Waterproofing, \$3.50 per lb. San Francisco Warehouse.

Tricosal concrete waterproofing. 60c a cubic yd. and up.

**ELECTRIC WIRING—\$15 to \$20 per outlet for conduit work (including switches).**

Knob and tube average \$6.00 per outlet.

### ELEVATORS—

Prices vary according to capacity, speed and type. Consult elevator companies. Average cost of installing a slow speed automatic passenger elevator in small four story apartment building, including entrance doors, about \$9,500.00.

### EXCAVATION—

Send, \$1.00; clay or shale, \$1.50 per yard. Trucks, \$20 to \$45 per day.

Above figures are an average without water. Steam shovel work in large quantities, less; hard material, such as rock, will run considerably more.

### FIRE ESCAPES—

Ten-foot galvanized iron balcony, with stairs, \$250 installed on new buildings; \$300 on old buildings.

### FLOORS—

Asphalt Tile, 1/8 in. gauge 18c to 35c per sq. ft.

Composition Floors, such as Magnesite, 50c per square foot.

Linoleum, standard gauge, sq. yd. .... \$2.75

Mastipave—\$1.50 per sq. yd.

BattleShip Linoleum—1/8" —\$3.00 sq. yd.

Terazzo Floors—\$1.50 per sq. ft.

Terazzo Steps—\$2.50 per lin. ft.

Mestic Wear Coat—according to type—20c to 35c.

### Hardwood Flooring—

#### Oak Flooring—T & G—Unfin.—

	1 1/2" x 2"	1 1/2" x 2 1/2"	1 1/2" x 3"	1 1/2" x 3 1/2"	1 1/2" x 4"
Clear Old, White	\$425	\$405	\$405	\$405	\$405
Clear Old, Red	405	380	380	380	380
Select Old, Red or White	355	340	355	340	355
Clear Pln., Red or White	355	340	335	315	315
Select Pln., Red or White	340	330	325	305	305
#1 Common, Red or White	315	310	305	285	285
#2 Common, Red or White	305	310	305	285	285

#### Prefinished Oak Flooring—

	Prime	Standard
1/2" x 2"	\$369.00	\$359.00
1/2" x 2 1/2"	380.00	370.00
1/2" x 3"	390.00	381.00
1/2" x 3 1/2"	375.00	355.00
1/2" x 3"	395.00	375.00
3/4" x 2 1/4" x 3/4" Ranch Plank	395.00	415.00

#### Unfinished Maple Flooring—

3/4" x 2 1/4" First Grade	\$390.00
3/4" x 2 1/4" 2nd Grade	385.00
3/4" x 2 1/4" 2nd & Btr. Grade	375.00
3/4" x 2 1/4" 3rd Grade	240.00
3/4" x 3/4" 3rd & Btr. Jtd. EM	380.00
3/4" x 3/4" 2nd & Btr. Jtd. EM	390.00
3/4" x 2 1/4" First Grade	400.00
3/4" x 2 1/4" 2nd Grade	362.00
3/4" x 2 1/4" 3rd Grade	320.00

Floor Layer Wege \$2.50 hr.

### GLASS—

Single Strength Window Glass	\$.30 per sq. ft.
Double Strength Window Glass	.45 per sq. ft.
Plate Glass, 1/4 polished to 75	1.60 per sq. ft.
75 to 100	1.74 per sq. ft.
1/4 in. Polished Wire Plate Glass	2.35 per sq. ft.
1/4 in. Rgh. Wire Glass	.71 per sq. ft.
1/4 in. Polished Wire Plate Glass	2.00 per sq. ft.
1/4 in. Rgh. Wire Glass	.64 per sq. ft.
1/8 in. Obscure Glass	.40 per sq. ft.
3/8 in. Obscure Glass	.64 per sq. ft.
1/2 in. Heat Absorbing Obscure	.58 per sq. ft.
1/4 in. Heat Absorbing Wire	.86 per sq. ft.
Glazing of above additional	\$.15 to .30 per sq. ft.
Glass Blocks, set in place	3.50 per sq. ft.

### HEATING—

Average, \$3.50 to \$4.00 per sq. ft. of radiation, according to conditions.  
Warm air (gravity) average \$64 per register.  
Forced air average \$91 per register.

### INSULATION AND WALLBOARD—

Rockwool Insulation—	
(2") Less than 1,000 sq. ft.	\$64.00
(2") Over 1,000 sq. ft.	\$9.00
Cotton Insulation—Full thickness (135")	\$95.50 per M sq. ft.
Isolation Aluminum Insulation—Aluminum coated on both sides	\$23.50 per M sq. ft.
Tileboard—4"x6" panel	\$9.00 per panel
Wallboard—1/2" thickness	\$55.00 per M sq. ft.
Finished Plank	\$69.00 per M sq. ft.
Ceiling Tileboard	\$69.00 per M sq. ft.

**IRON**—Cost of ornamental iron, cast iron, etc., depends on designs.

### LUMBER—

S4S No. 2 and better common O.P. or D.F., per M. f.b.m.	\$100.00
Rough, No. 2 common O.P. or D.F., per M. f.b.m.	100.00

### Flooring—

	Per M Delivd.
V.G., D.F. B & Btr, 1 x 4 T & G Flooring	\$225.00
"C" and better—all	225.00
"D" and better—all	225.00
Rwd. Rustic—"A" grade, medium dry, 8 to 24 ft.	185.00

Plywood, per M sq. ft.	
1/4-inch, 4.0x8.0-5'S	\$170.00
1/2-inch, 4.0x8.0-5'S	250.00
3/4-inch, per M sq. ft.	315.00
Plywood	11 1/2¢ per ft.
Pyflorm	25¢ per ft.

Shingles (Rwd. not available)—	
Red Cedar No. 1—\$9.50 per square; No. 2, \$7.00; No. 3, \$5.00.	
Average cost to lay shingles, \$6.00 per square.	
Cedar Shakes—1/2" to 3/4" x 24/26 in hand split tapered or split resawn, per square	\$15.25
3/4" to 1 1/4" x 24/26 in split resawn, per square	17.00
Average cost to lay shakes, — 8.00 per square	
Pressure Treated Lumber—	
Woimznated	Add \$35 per M to above
Crestoled.	
8-lb. treatment	Add \$45 per M to above

### MARBLE—(See Dealers)

### METAL LATH EXPANDED—

Standard Diamond, 3/40, Copper Bearing, L.C.L. per 100 sq. yds.	\$43.50
Standard Ribbed, ditto.	\$47.50

### MILLWORK—

D. F. \$150 per 1000. R. W. Rustic \$175 per 1000 (delivered).	
Double hung box window frames, average with trim, \$12.50 and up, each.	
Complete door unit, \$15 to \$25.	
Screen doors, \$8.00 to \$12.00 each.	
Patent screen windows, \$1.25 a sq. ft.	
Cases for kitchen pantries seven ft. high, per lineal ft., upper \$9.00 to \$11.00; lower \$12.00 to \$13.00.	
Dining room cases, \$20.00 per lineal foot. Rough and finish about \$1.00 per sq. ft.	
Labor—Rough carpentry, warehouse heavy framing (average), \$75.00 per M.	
For smaller work average, \$85.00 to \$100. per 1000.	

### PAINTING—

Two-coat work	per yard 85¢
Three-coat work	per yard \$1.10
Cold water painting	per yard 25¢
Whitewashing	per yard 15¢
Linseed Oil, Strictly Pure (Basis 7 1/2 lbs. per gal.)	Wholesale Raw Boiled
Light iron drums	per gal. \$2.28 \$2.34
5-gallon cans	per gal. 2.40 2.46
1-gallon cans	each 2.52 2.58
Quart cans	each .71 .72
Pint cans	each .38 .39
1/2-pint cans	each .24 .24
Turpentine	Pure Gum
(Basis 7.2 lbs. per gal.)	Spirits
Light iron drums	per gal. \$1.65
5-gallon cans	per gal. 1.70
1-gallon cans	each 1.88
Quart cans	each .54
Pint cans	each .31
1/2-pint cans	each .20

### Pioneer White Lead in Oil Heavy Paste and All Purpose (Soft-Paste)

	List Price	Price to Painters
Net Weight	per 100 lbs.	per 100 lbs.
Packages	pkgs.	pkgs.
100-lb. kegs	\$28.35	\$27.50
50-lb. kegs	30.05	28.15
25-lb. kegs	30.35	27.59
5-lb. cans	33.35	31.25
1-lb. cans*	36.00	33.75
500 lbs. (one delivery) 3/4¢ per pound less than above.		

\*Heavy Paste only.  
Pioneer Dry White Lead—Litharge—Dry Red Lead—Red Lead in Oil

	Price to Painters—Price Per 100 Pounds
	100 50 25
Products	lbs. lbs. lbs.
Dry White Lead	\$28.30 \$ \$
Litharge	25.95 26.60 26.90
Red Red Lead	27.20 27.85 28.15
Red Lead in Oil	30.85 31.30 31.60
Found cans, \$37 per lb.	

### PATENT CHIMNEYS—

6-inch	\$2.50 lineal foot
8-inch	3.00 lineal foot
10-inch	4.00 lineal foot
12-inch	5.00 lineal foot

### PLASTER—

Neat wall per ton delivered in S. F. in paper bags, \$17.60.

### PLASTERING (Interior)—

3 Coats, metal lath and plaster	33.00
Keene cement on metal lath	3.50
Ceilings with 3/4 hot roll channels metal lath (lathed only)	3.00
Seatings with 3/4 hot roll channels metal lath plastered	4.50
Single partition 3/4 channel lath 1 side (lath only)	3.00
Single partition 3/4 channel lath 2 inches plastered	8.00
4-inch double partition 3/4 channel lath 2 sides (lath only)	5.75
4-inch double partition 3/4 channel lath 2 sides plastered	8.75
Thermax single partition; 1" channels; 2 1/4" overall partition width. Plastered both sides	7.50
Thermax double partition; 1" channels; 4 1/4" overall partition width. Plastered both sides	11.00
3 Coats over 1" Thermax nailed to one side wood studs or joists	4.50
3 Coats over 1" Thermax suspended to one side wood studs with spring sound insulation clip	5.00
Note—Channel lath controlled by limitation orders.	

### PLASTERING (Exterior)—

2 coats cement finish, brick or concrete wall	per yard \$2.50
3 coats cement finish, No. 18 gauge wire mesh	3.50
Line—\$4.00 per bbl. at yard.	
Processed LLime—\$4.15 per bbl. at yard.	
Rock or Grip Lath—3/8"—30¢ per sq. yd.	
A"—20¢ per sq. yd.	
Composition Stucco—\$4.00 sq. yard (applied).	

### PLUMBING—

From \$200.00 per fixture up, according to grade, quality and runs.

### ROOFING—

"Standard" tar and gravel, 4 ply—\$11.00 per sq. for 30 sqs. or over.	
Less than 30 sqs. \$14.00 per sq.	
Tile \$40.00 to \$50.00 per square.	
No. 1 Redwood Shingles in place, 4 1/2 in. exposure, per square	\$18.25
5/2 No. 1 Cedar Shingles, 5 in. exposure, per square	14.50
5/8 x 16"—No. 1 Little Giant Cedar Shingles, 5" exposure, per square.	18.25

4/2 No. 1-24" Royal Cedar Shingles 7 1/2" exposure, per square	23.00
Re-coat with Gravel \$5.50 per sq.	
Asbestos Shingles, \$27 to \$35 per sq. laid.	
1/2 to 3/4 x 25" Resawn Cedar Shakes, 10" Exposure	\$30.00
3/4 to 1 1/4 x 25" Resawn Cedar Shakes, 10" Exposure	\$35.00
1 x 25" Resawn Cedar Shakes, 10" Exposure	22.00
Above prices are for shakes in place.	

### SEWER PIPE—

C.1, 6-in. to 24-in. B. & S. Class B and heavier, per ton	\$99.50
Vitrified, per foot: L.C.L. F.O.B. Warehouse, San Francisco.	
Standard, 8-in.	\$.66
Standard, 12-in.	1.30
Standard, 24-in.	5.41
Clay Drain Pipe, per 1,000 L.F. L.C.L., F.O.B. Warehouse, San Francisco:	
Standard, 6-in. per M.	\$240.00
Standard, 8-in. per M.	400.00

### SHEET METAL—

Windows—Metal, \$2.50 a sq. ft. Fire doors (average), including hardware \$2.80 per sq. ft., size 12'x12'. \$3.75 per sq. ft., size 3'x6'.

### SKYLIGHTS—(not glazed)

Copper, \$1.25 sq. ft. (flat).	
Galvanized iron, 65c sq. ft. (flat).	
Vented hip skylights, \$1.50 sq. ft.	

### STEEL—STRUCTURAL—

\$220 per ton erected, when out of mill. \$270 per ton erected, when out of stock.

### STEEL REINFORCING—

\$200.00 per ton, in place.	
1/2-in. Rd. (Less than 1 ton)	\$8.40
3/8-in. Rd. (Less than 1 ton)	7.30
1/2-in. Rd. (Less than 1 ton)	7.00
3/4-in. Rd. (Less than 1 ton)	6.75
1/2-in. & 3/8-in. Rd. (Less than 1 ton)	6.65
1-in & up (Less than 1 ton)	6.60
1 ton to 5 tons, deduct 25c.	

### STORE FRONTS (None available).

### TILE—

Ceramic Tile Floors—Commercial \$1.20 to \$1.60 per sq. ft.	
Cove Base—\$1.40 per lin. ft.	
Quarry Tile Floors, 6x6" with 6" base @ \$1.35 per sq. ft.	
Tile Wainscots & Floors, Residential, 4/4x4/4", @ \$1.65 to \$2.00 per sq. ft.	
Tile Wainscots, Commercial Jobs, 4/4x4/4", Tile, @ \$1.50 to \$1.65 per sq. ft.	
Asphalt Tile Floor 1/4" x 1/4" @ \$.18 - \$.35 sq. yd.	
Light grades slightly higher.	
Cork Tile—\$.70 per sq. ft.	
Mosaic Floors—See dealers	
Lino-Tile—\$1.00 per sq. ft.	
Rubber Tile—\$.55 to \$.75 per sq. ft.	

### Building Tile—

8 1/2"x12-inches, per M.	\$199.50
6 1/2"x12-inches, per M.	105.00
6 1/2"x12-inches, per M.	84.00
Hollow Tile—	
12x24-inches, per M.	\$146.75
12x24-inches, per M.	105.00
12x12-inches, per M.	177.10
12x12-inches, per M.	235.30
F.O.B. Plant	

### VENETIAN BLINDS—

75c per square foot end up. Installation extra.

### WINDOWS—STEEL—INDUSTRIAL

Cost depends on design and quality required.



# ARCHITECT AND ENGINEER ESTIMATOR'S DIRECTORY

## Building and Construction Materials

EXPLANATION—Building and construction materials are shown in major classified groups for general identification purposes with names and addresses of suppliers of materials listed in detail under group classification where name first appears—main offices are shown first with branch or district offices following. The numeral appearing in listings refers to the major group classification where complete data on the dealer, or representative, may be found.

### AIR CONDITIONING (1b)

Air Conditioning & Cooling  
UTILITY APPLIANCE CORP.  
Los Angeles 58, 4851 S. Alameda St.  
San Francisco, 1355 Market St., UN 1-4908

### ARCHITECTURAL VENEER (a)

Ceramic Veneer  
PACIFIC CLAY PRODUCTS  
San Francisco: 605 Market St., GA 1-3970  
Los Angeles, Portland, Salt Lake City  
GLADDING, McBEAN & CO. \*(1)  
Porcelain Veneer  
PORCELAIN ENAMEL PUBLICITY BUREAU  
(Dept. AE-450)  
Room 601, Franklin Building, Oakland 12, California  
P. O. Box 186, East Pasadena Station, Pasadena 8,  
California

Granite Veneer  
VERMONT MARBLE COMPANY  
San Francisco 5: 525 Market Street, SU 1-6747  
Los Angeles 4: DU 2-7834

Marble Veneer  
VERMONT MARBLE COMPANY  
San Francisco 5: 525 Market Street, SU 1-6747  
Los Angeles 4: DU 2-7834

### BANKS-FINANCING (1b)

CROCKER FIRST NATIONAL BANK OF S. F.  
San Francisco, Post & Montgomery St's., EX 2-7700

### BRASS PRODUCTS (1a)

GREENBERG'S, M. & SONS  
San Francisco, Calif.: 765 Folsom, EXbrook 2-3143

### BRICKWORK (1)

Face Brick  
GLADDING, McBEAN & CO.  
San Francisco: Harrison at 9th Sts., UN 1-7400  
Los Angeles: 2901 Los Feliz Blvd., OL 2121  
Offices at Portland, Seattle, Spokane  
KRAFTILE  
Niles, California, Niles 3611  
San Francisco 5: 50 Hawthorne St., DO 2-3780  
Los Angeles 13: 406 South Main St., MU 7241  
REMILLARD-DANDINI CO.  
San Francisco: 400 Montgomery St., EX 2-4988

### BRONZE PRODUCTS (1b)

GREENBERG'S M. & SONS  
San Francisco, Calif.: 765 Folsom, EXbrook 2-3143

### BUILDING PAPER & FELTS (2)

SISKRAFT COMPANY  
San Francisco: 55 New Montgomery St., EX 2-3066  
Chicago, Ill.: 205 West Wacker Drive  
ANGIER PACIFIC CORP.  
San Francisco 5: 55 New Montgomery St., DO 2-4416  
Los Angeles: 7424 Sunset Boulevard

### BUILDING HARDWARE (3)

THE STANLEY WORKS  
San Francisco: Monadnock Bldg., YU 6-5914  
New Britain, Conn.

### CEMENT (c)

PACIFIC PORTLAND CEMENT  
San Francisco: 417 Montgomery St., GA 1-4100

### CONCRETE AGGREGATES (4)

Lightweight Aggregates  
AMERICAN PERLITE CORP.  
Richmond, Calif.: 26th & B Sts.,—Rk 4 3707

### DOORS (1a)

Hollywood Doors  
WEST COAST SCREEN CO.  
Los Angeles: 1127 E. 63rd St. AD 1-1108  
Distributors:

W. P. FULLER CO.  
Seattle, Tacoma, Portland  
NICOLAI DOOR SALES CO.  
San Francisco: 3045 19th St.  
T. M. COBB CO.  
Los Angeles: & San Pedro  
SOUTHWEST SASH & DOOR  
Phoenix, Arizona  
HOUSTON SASH & DOOR  
Houston, Texas  
Screen Doors  
WEST COAST SCREEN CO.  
(See Hollywood Door listing above)

### FIRE ESCAPES (5)

SOULE STEEL  
San Francisco: 1750 Army St., VA 4-4141  
Los Angeles, Calif.—LA 0911  
Portland, Ore.—BE 5155  
Seattle, Wash.—SE 3010  
MICHEL & PFEFFER IRON WORKS, INC.  
South Linden and Tanforan Aves.  
South San Francisco: JU 4-8362

### FIREPLACES (5a)

Heat Circulating  
SUPERIOR FIREPLACE CO.  
Los Angeles: 1708 E. 15th St. PR 8393  
Baltimore, Md.: 601 No. Point Rd.

### FLOORS (4)

Hardwood Flooring  
HOGAN LUMBER COMPANY  
Oakland: Second and Alice Sts., GL 1-6861  
E. K. WOOD LUMBER CO.  
Los Angeles: 4710 S. Alameda St., JE 3111  
Oakland: 727 Kennedy St., KE 4-8466  
Portland: 827 Terminal Sales Building  
Floor Treatment & Maintenance  
HILLYARD SALES CO. (Western)  
470 Alabama St., San Francisco, MA. 1-7766  
Los Angeles, 923 E. 3rd, TRINITY 8282  
Seattle, 3440 E. Marginal Way

### GLASS (7)

W. P. FULLER COMPANY  
San Francisco: 301 Mission St., EX 2-7151  
Los Angeles, Calif.  
Portland, Oregon

### HEATING (8)

HENDERSON FURNACE & MFG. CO.  
Sebastopol, Calif.  
S. T. JOHNSON CO.  
Oakland 8: 940 Arlington Ave., OL 2-6000  
San Francisco: 585 Potrero Ave., MA 1-2757  
Philadelphia 8, Pa.: 401 No. Broad St.  
SCOTT COMPANY  
San Francisco: 243 Minne St., YU 2-0400  
Oakland: 113 - 10th St., GL 1-1937  
San Jose, Calif.  
Los Angeles, Calif.

### Electric Heaters

ELECTROMODE CORP.  
Rochester, N. Y.  
San Francisco: 1355 Market St., KL 2-2311  
Northern California Distributors  
GENERAL ELECTRIC SUPPLY CORP.  
San Francisco: 1201 Bryant St., UN 3-4000  
Emeryville: 5400 Hollis St., OL 3-4433  
Sacramento: 1131 S St., GI 3-9001  
Fresno: 1234 O St., Fresno 4-4746  
INCANDESCENT SUPPLY COMPANY  
Redding: 2146 Pine St., Redding 200  
THOMAS B. HUNTER (Designer)  
San Francisco: 41 Sutter St., GA 1-1164

### UTILITY APPLIANCE CORP. \*(b)

INSULATION AND WALLBOARD (9)  
LUMBER MANUFACTURING CO.  
San Francisco: 225 Industrial Ave., JU 7-1760  
SISKRAFT COMPANY \*(2)  
WESTERN ASBESTOS COMPANY  
San Francisco: 675 Townsend St., KL 2-3868  
Oakland: 251 Fifth Avenue, GL 1-2345  
Sacramento: 1224 J Street, 2-8993  
Stockton: 1120 E. Weber Ave., 4-1863  
Fresno: 1837 Merced Street, 3-3277  
San Jose: 201 So. Market St., BA 4359-J

### IRON—Ornamental (10)

MICHEL & PFEFFER IRON WORKS, INC. \*(5)

### LANDSCAPE (11a)

Landscape Contractors  
HENRY C. SOTO CORPN.  
Los Angeles, 13000 S. Avalon Blvd, ME 4-6617

### LIGHTING FIXTURES (11)

SMOOT-HOLMAN COMPANY  
Inglewood, Calif., OR 8-1217  
San Francisco: 55 Mississippi St., MA 1-8474

### LUMBER (12)

HOGAN LUMBER COMPANY \*(6)  
LUMBER MANUFACTURING CO. \*(9)  
E. K. WOOD LUMBER CO \*(6)  
Shingles

SIDEWALL LUMBER COMPANY  
San Francisco 24: 1995 Oakdale Ave., AT 2-8112

### MARBLE (13)

VERMONT MARBLE COMPANY  
San Francisco: 525 Market St., SU 1-6747  
Los Angeles 4: 3522 Council St., DU 2-7834

### METAL LATH EXPANDED (14)

FORDERER CORNICE WORKS  
San Francisco: 269 Potrero Ave., HE 1-4100  
SOULE STEEL \*(5)

### MILLWORK (15)

PACIFIC MANUFACTURING COMPANY  
San Francisco: 16 Beale St., GA 1-7755  
Santa Clara: 2620 The Alameda, SC 607  
Los Angeles: 6810 McKinley Ave., TH 4196  
MULLEN MANUFACTURING COMPANY  
San Francisco: 60-80 Rausch St., UN 1-5815  
LUMBER MANUFACTURING COMPANY \*(9)

### PAINTING (16)

Paint  
W. P. FULLER COMPANY \*(7)

### PLASTER (17)

Exteriors  
PACIFIC PORTLAND CEMENT COMPANY \*(4)  
Interiors—Metal Lath & Trim  
FORDERER CORNICE WORKS \*(14)

### PLASTIC CEMENT (4)

PACIFIC PORTLAND CEMENT CO.  
San Francisco: 417 Montgomery St., GA 1-4100

### PLUMBING (18)

THE SCOTT COMPANY \*(8)  
THE HALSEY TAYLOR COMPANY  
Redlands, Calif.  
Warren, Ohio  
HAWES DRINKING FAUCET COMPANY  
Berkeley 10: 1435 Fourth St., LA 5-3341  
CONTINENTAL WATER HEATER COMPANY  
Los Angeles 31: 1801 Pasadena Ave., CA 6178

**SIMONDS MACHINERY COMPANY**

San Francisco: 816 Folsom St., DO 2-6794

Los Angeles: 455 East 4th St., MU 8322

**SECURITY VALVE COMPANY**

Los Angeles 31: 410 San Fernando Rd., CA 6191

**REPUBLIC STEEL CORP.**

San Francisco: 116 N. Montgomery St., GA 1-0977

Los Angeles: Edison Building

Seattle: White-Henry-Stuart Building

Salt Lake City: Walker Bank Building

Denver: Continental Oil Building

KRAFTILE COMPANY \* (1)

SAN JOSE STEEL COMPANY

San Jose: 195 North Thirtieth St., CO 4184

**WINDOWS STEEL (25)**

DETROIT STEEL PRODUCTS CO. \* (20)

MICHEL & PFEFFER IRON WORKS, INC. \* (5)

SOULE STEEL COMPANY \* (5)

**SEWER PIPE (19)**

GLADDING, McBEAN & CO. \* (1)

PACIFIC CLAY PRODUCTS

San Francisco: 605 Market St., GA 1-3970

Los Angeles, Portland, Salt Lake City

**SHEET METAL (20)**

Windows

DETROIT STEEL PRODUCTS COMPANY

Oakland 8: 1310 - 63rd St., OL 2-8826

San Francisco: Russ Building, DO 2-0890

MICHEL & PFEFFER IRON WORKS, INC. \* (5)

SOULE STEEL COMPANY \* (5)

Fire Doors

DETROIT STEEL PRODUCTS COMPANY

Skylights

DETROIT STEEL PRODUCTS COMPANY

**STEEL—STRUCTURAL (21)**

COLUMBIA STEEL CO.

San Francisco: Russ Bldg., SU 1-2500

Los Angeles: 2087 E. Slauson, LA 1171

Portland: 2345 N. W. Nicolai, BE 7261

Seattle: 1331 3rd Ave. Bldg., MA 1972

Salt Lake City: Walker Bank Bldg., SL 3-6733

HERRICK IRON WORKS

Oakland: 18th & Campbell Sts., GL 1-1767

JUDSON PACIFIC-MURPHY CORP.

Emeryville: 4300 Eastshore Highway, OL 3-1717

**STEEL—REINFORCING (22)**

REPUBLIC STEEL CORP. \* (21)

HERRICK IRON WORKS \* (21)

SAN JOSE STEEL CO. \* (21)

COLUMBIA STEEL CO. \* (21)

**TILE (23)**

GLADDING, McBEAN & CO. \* (1)

KRAFTILE COMPANY \* (1)

PACIFIC CLAY PRODUCTS

San Francisco: 605 Market St., GA 1-3970

Los Angeles, Portland, Salt Lake City

**TIMBER—REINFORCING (6)**

Trusses

WEYERHAEUSER SALES CO.

Tacoma, Wash.

St. Paul, Minn.

Newark, N. J.

Treated Timber

J. H. BAXTER CO.

San Francisco 4: 333 Montgomery St., DO 2-3883

Los Angeles 13: 601 West Fifth St., MI 6294

**WALL TILE (24)**

GLADDING, McBEAN & CO. \* (1)

KRAFTILE COMPANY \* (1)

**GENERAL CONTRACTORS (126)**

BARRETT & HILP

San Francisco: 918 Harrison St., DO 2-0700

Los Angeles: 234 W. 37th Place, AD 3-8161

DINWIDDIE CONSTRUCTION COMPANY

San Francisco: Crocker Building, YU 6-2718

CLINTON CONSTRUCTION COMPANY

San Francisco: 923 Folsom St., SU 1-3440

MATTOCK CONSTRUCTION COMPANY

San Francisco: 604 Mission St., GA 1-5516

PARKER, STEFFENS & PEARCE

San Francisco: 135 So. Park, EX 2-6639

STOLTE, INC.

Oakland: 8451 San Leandro Blvd., TR 2-1064

SWINERTON & WALBERG COMPANY

San Francisco: 225 Bush St., GA 1-2980

Oakland: 1723 Webster St., HI 4-4322

Los Angeles, Sacramento, Denver

P. J. WALKER COMPANY

San Francisco: 391 Sutter St., YU 6-5916

Los Angeles: 714 W. Olympic Blvd., RI 7-5521

**TESTING LABORATORIES**

(ENGINEERS & CHEMISTS) (27)

ABBOT A. HANKS, INC.

San Francisco: 624 Sacramento St., GA 1-1697

ROBERT W. HUNT COMPANY

San Francisco: 251 Kearny St., EX 2-4634

Los Angeles: 3050 E. Slauson, JE 9131

Chicago, New York, Pittsburgh

PITTSBURGH TESTING LABORATORY

San Francisco: 651 Howard St., EX 2-1747

**BUILDING TRADES WAGE (JOB SITES) NORTHERN, CENTRAL AND SOUTHERN CALIFORNIA**

ATTENTION: The following are the PREVAILING hourly rates of compensation being paid and in effect by employers by agreement between employees and their union; or as recognized and determined by the U. S. Department of Labor. (Revised to March 1, 1951.)

CRAFT	San Francisco	Alameda	Contra Costa	Fresno	Sacramento	San Joaquin	Santa Clara	Solano	Los Angeles	San Bernardino	San Diego	Santa Barbara	Kern
ASBESTOS WORKERS.....	\$2.50	\$2.50	\$1.50	\$2.50	\$2.50	\$2.50	\$2.50	\$2.50	\$1.25	2.25	\$1.25	\$2.25	\$2.25
BOILERMAKERS.....	2.53	2.53	2.53	2.53	2.53	2.53	2.53	2.53	2.25	2.25	2.25	2.25	2.25
BRICKLAYERS.....	3.25**	3.15*	3.15	2.85	3.25	3.00	3.00	3.25	2.425	2.625	2.625	2.625	2.625
BRICKLAYERS, HODCARRIERS.....	2.45	2.45	2.45	2.00	2.40	2.25	2.375	2.40	1.75	1.75	1.75	1.75	1.75
CARPENTERS.....	2.325	2.325	2.175	2.175	2.175	2.175	2.175	2.175	2.20	2.20	2.20	2.20	2.20
CEMENT FINISHERS.....	2.20	2.20	2.20	2.20	2.20	2.20	2.20	2.20	2.28	2.28	2.28	2.28	2.28
ELECTRICIANS.....	2.75	2.60	2.40	2.75	2.50	2.50	2.625	2.40	2.50	2.50	2.50	2.50	2.50
ELEVATOR CONSTRUCTORS.....	2.375	2.375	2.375	2.375	2.375	2.375	2.375	2.375	2.28	2.28	2.28	2.28	2.28
ENGINEERS: MATERIAL HOIST.....	2.19	2.19	2.19	2.19	2.19	2.19	2.19	2.19	1.9875	1.9875	1.9875	1.9875	1.9875
GLAZIERS.....	2.30	2.30	2.30	2.30	2.30	2.08	2.30	2.30	2.00	2.00	2.00	2.00	1.96
IRON WORKERS: ORNAMENTAL.....	2.425	2.425	2.425	2.425	2.425	2.425	2.425	2.425	2.255	2.255	2.255	2.255	2.255
REINF. RODMEN.....	2.375	2.375	2.375	2.375	2.375	2.375	2.375	2.375	2.28	2.28	2.28	2.28	2.28
STRUCTURAL.....	2.575	2.575	2.575	2.575	2.575	2.575	2.575	2.575	2.30	2.30	2.2375	2.30	2.30
LABORERS: BUILDING.....	1.65	1.65	1.65	1.55	1.65	1.65	1.55	1.65	1.65	1.65	1.65	1.65	1.65
CONCRETE.....	1.65	1.65	1.65	1.55	1.65	1.65	1.55	1.65	1.65	1.65	1.65	1.65	1.65
LATHERS.....	3.00	3.00*	3.00*	2.75	2.875	2.75	3.00	2.8125	2.50	2.50	2.50	2.50	2.50
MARBLE SETTERS.....	2.40	2.40	2.40	2.40	2.40	2.40	2.40	2.40	2.25	2.25	2.25	2.25	2.25
MOSAIC & TERRAZZO.....	2.375	2.375	2.375	2.375	2.375	2.375	2.375	2.375	2.40	2.40	2.40	2.40	2.40
PAINTERS.....	2.45	2.45	2.45	2.15	2.45	2.275	2.45	2.45	2.22	2.22	2.22	2.22	2.22
PAINTERS.....	2.325	2.325	2.325	2.325	2.325	2.325	2.325	2.325	2.33	2.33	2.33	2.33	2.33
PILEDRIVERS.....	3.00	3.15**	3.15	2.75	3.00	3.00	3.125	3.00*	2.50	2.75	2.50	2.50	2.50
PLASTERERS.....	2.40	2.80	2.80	2.50	2.40	2.50	2.75	2.50	2.15	2.25	2.30	2.00	2.00
PLASTERERS, HODCARRIERS.....	2.425	2.425	2.425	2.425	2.425	2.425	2.425	2.425	2.50	2.50	2.50	2.50	2.50
PLUMBERS.....	2.50	2.50	2.50	2.50	2.75	2.50	2.50	2.50	2.25	2.00	1.90	2.00	2.00
ROOFERS.....	2.3125	2.3125	2.3125	2.40	2.50	2.375	2.3125	2.375	2.15	2.15	2.175	2.00	2.15
SHEET METAL WORKERS.....	2.625	2.625	2.625	2.625	2.625	2.625	2.625	2.625	2.25	2.25	2.25	2.25	2.25
SPRINKLER FITTERS.....	2.625	2.625	2.625	2.625	2.625	2.625	2.625	2.625	2.50	2.50	2.50	2.50	2.50
STEAMFITTERS.....	2.625	2.625	2.625	2.625	2.625	2.625	2.625	2.625	2.25	2.25	2.25	2.25	2.25
TRUCK DRIVERS—1/2 Ton or less.....	1.58	1.58	1.58	1.58	1.58	1.58	1.58	1.58	1.58	1.58	1.58	1.58	1.58
TILESETTERS.....	2.875	2.875	2.875	2.50	2.875	2.4375	2.875	2.875	2.50	2.50	2.20	2.50	2.25

\* 6 Hour Day. \*\* 7 Hour Day.

Prepared and compiled by:

CENTRAL CALIFORNIA CHAPTER, ASSOCIATED GENERAL CONTRACTORS OF AMERICA, with the assistance and cooperation of secretaries of General Contractors Associations and Builders Exchanges of Northern California; and the above information for southern California is furnished by the Labor Relations Department of the Southern California Chapter, ASSOCIATED GENERAL CONTRACTORS OF AMERICA.

## UNITED AIR LINES EXPAND WESTERN MAINTENANCE BASE

John A. Herlihy, vice president in charge of operations for United Air Lines, recently announced plans for immediate expansion of the company's maintenance base at South San Francisco.

The program will involve construction of a large hangar and maintenance dock, a new warehouse for storage of supplies and parts, and an additional shop building for engine overhaul. Forty thousand square feet of concrete parking area, and three out-door engine run-up pads will also be constructed.

When completed the new buildings will add more than 17,500 sq. ft. to present hangar areas, an increase of 10 per cent; the present warehouse area of 60,000 sq. ft. will be more than doubled; and the new engine overhaul shop will provide an additional 80,000 sq. ft. to the present area.

## BUILDERS HARDWARE CLUB ORGANIZED

A new building industry association has been formed in northern California with 150 charter members and representing the Architectural Hardware Consultants and the National Contract Hardware Association, to be known as The Builders Hardware Club.

Charles S. Smith has been named president; Vernon Garehime, vice-president; James R. Blair, secretary; and Ted Hay, treasurer.

Principal speaker at the August meeting of the new group was Edward S. Montgomery of the San Francisco Examiner who spoke on the 1950 Internal Revenue investigation of the California building industry.

## IMPROVEMENTS AT CALIFORNIA PRISON INSTITUTIONS

The Soledad and Tracy penal institutions are being enlarged in the State of California's prison enlargement program with expansion of prison

facilities to include new cell blocks, shops and administrative areas.

More than 4350 lineal feet of movable steel partitions, 185 steel doors, and 4730 square feet of steel ceiling is being installed by the E. F. Hauserman Company, particularly to divide machine shops, carpenter shops, classrooms, and other work areas, according to W. F. Hauserman, district sales manager for the firm in San Francisco.

General contractor for the work at Tracy is Johnson, Droke & Piper, Inc., Oakland, and at Soledad the general contractor is Pederson & Sons of Fresno.

## NEW FIBERGLAS OFFICES ESTABLISHED IN OREGON

L. R. Kessler, vice-president of the Owens-Corning Fiberglas Corp. and general manager of its Pacific Coast Division at Santa Clara, California, has announced the establishment of the Fiberglas Engineering and Supply Company of Oregon.

Offices of the new firm have been located in Portland under the direction of W. E. Munsey, vice-president and general manager, and will serve Oregon and southwestern Idaho. Munsey is a native of Oregon and well known among building and refrigeration men on the Pacific Coast.

## JOINS PABCO

William A. Buckman has been named assistant to H. J. Lilleston, vice-president in charge of marketing for the Pabco Products, Inc.

Buckman, a graduate of the University of Pennsylvania's Wharton School, will have his headquarters in the Pabco's San Francisco offices.

## APPOINTED TO DALLAS OFFICE

S. D. Andrews, for the past three years in the San Francisco office of the General Controls Co., of Glendale, has been appointed branch manager of the company's Dallas, Texas, office.

# CLASSIFIED ADVERTISING

RATE: 20c PER WORD . . . CASH WITH ORDER

MINIMUM \$5.00

**PLANNING CHURCH BUILDINGS.** Portfolio—64 oversized pages 144 cuts; floor plans, exterior and interior views; recently planned buildings costing \$30,000 upward. Largest collection plans of Protestant churches assembled. Price \$2.00 p.p. WRITE Bureau of Architecture, 300 Fourth Ave., New York 10, N. Y.

**GET THE BEST,** not satisfied with anything but the best. Window sash, Doors, Cabinets, etc. Town Talk Sash & Door Mill, 524 9th St., Sacramento.

**BUILDERS!** You can make more money; get information you need before it is published elsewhere; Subscribe to the daily ARCHITECTS REPORTS, only \$10.00 per month. Complete information from ARCHITECTS REPORTS, 68 Post Street, San Francisco. Phone DOuglas 2-8311.

**PHOTOGRAPHY.** For the best in construction photography, including exterior and interior, aerial, and progress views . . . you will find as many others have that it's the SKELTON STUDIO'S, 137 Harlan Place, San Francisco, Telephone YUkon 6-6321.

**WANTED:** Experienced specification writer and building estimator by San Francisco ARCHITECT. Write WE 1-6 c/o ARCHITECT & ENGINEER, 68 Post Street, S. F.

**FLOOR COVERINGS** for industrial, commercial, and residential construction. Complete lines, one of the oldest, best established organizations in the Sacramento Valley. LATTIN'S, INC., 1519 Alhambra Blvd., Sacramento.



## CONSTRUCTION CONTRACTS AWARDED AND MISCELLANEOUS PERSONNEL DATA

**NEW HIGH SCHOOL**, Sparks, Nevada. Sparks High School District, owner; \$514,239. ARCHITECT: De Longchamps & O'Brien. Brick structural steel frame, reinforced brick walls, concrete floors, slab, steel sash, glass block, asphalt tile floors. GENERAL CONTRACTOR: W. H. Wine Construction Co., Reno.

**CHINESE SCHOOL AUDITORIUM, RE-MODEL AND ADDITION**, San Francisco. Chinese Six Companies, owner; \$109,236. ARCHITECT: Stephen P. S. Lee, San Francisco; reinforced concrete and structural steel construction. GENERAL CONTRACTOR: Peter Santorio, San Francisco.

**COUNTY AGRICULTURAL BUILDING**, Salinas, Monterey County. County of Monterey, owner; \$90,546. ARCHITECT: Chas. E. Butner, Salinas; 1 story, frame and stucco construction, shake roof. GENERAL CONTRACTOR: Geo. L. Fisk, Salinas.

**BANK BUILDING**, Los Angeles. Citizens National Trust & Savings Bank, owner; \$180,000. ARCHITECT: Stiles, Clements, Los Angeles; 1 story, mezzanine and basement, reinforced concrete, 60x128 sq. ft., wood and composition roofing, plate glass and flagstone front, elevator to basement.

**OFFICE BUILDING**, Los Angeles. Engineer Service Corp., owner; 2 story; \$41,000. ARCHITECT: Hugh Gibbs, Long Beach; frame and stucco construction, composition roofing, steel sash, concrete floor, forced air heating. GENERAL CONTRACTOR: Allen Tarkin & Associates, Los Angeles.

**LAFAYETTE ELEMENTARY SCHOOL ADDITION**, Lafayette, Contra Costa County. Lafayette Elementary School District, owner; 5 classrooms, kindergarten, toilet rooms; \$264,590. ARCHITECT: Schmidts & Hardman, Berkeley; frame and stucco construction, wrought iron pipe and radiant heating. GENERAL CONTRACTOR: Marvin E. Collins, El Cerrito.

**WAREHOUSE BUILDING**, San Leandro, Alameda County. STRUCTURAL ENGINEER: J. Y. Long Co., Oakland; 1 story, 80,000 sq. ft., reinforced concrete, wood roof trusses and composition roofing. GENERAL CONTRACTOR: Van Bokkeelen-Cole Co., Oakland.

**FACTORY AND OFFICE BUILDING**, Los Angeles. Westco Distribution Co., owner; \$95,000. ARCHITECT: Ulrich Plaut, Los Angeles; reinforced concrete, tilt-up construction, 36,000 sq. ft., wood roof trusses, composition roofing, concrete slab floor, steel sash, metal doors, asphalt tile floors, acoustical ceilings. GENERAL CONTRACTOR:

Sapp Construction Co., Los Angeles.

**ADDITION TO OFFICE BUILDING**, Downey, Los Angeles County. Pacific Telephone & Telegraph Co., owner; \$114,760. ARCHITECT: Parkinson, Powelson, Briney, Bernard & Woodford, Los Angeles; 1 story reinforced masonry and frame. GENERAL CONTRACTOR: Jack Helland, Glendale.

**HOSPITAL AND FOOD SERVICE UNIT**, Carson City, Nevada. Nevada State Children's Home, owner; \$67,925. ARCHITECT: Lockhard & Casazza, Reno; 1 story, 7,000 sq. ft., wood frame, asbestos shingle siding and roof. GENERAL CONTRACTOR: Sture Svenson, Carson City.

**OFFICE, SALES ROOM & WAREHOUSE**, Eureka, Humboldt County. Tay-Holbrook Co., owner; \$59,000. ARCHITECT: Frank T. Georgeson, Eureka; 1 story, frame & stucco construction. GENERAL CONTRACTOR: Fred J. Maurer & Son, Eureka.

**POPE AVENUE ELEMENTARY SCHOOL**, Sacramento, Sacramento county. Arcade Elementary School District, owner, 7 classrooms, kindergarten, administration, kitchen & toilet rooms, \$266,767. ARCHITECT: Gordon Stafford, Sacramento, frame & stucco construction, redwood & brick veneer exterior. GENERAL CONTRACTOR: A. L. Miller, Sacramento.

**FACTORY BUILDING**, San Leandro, Alameda county. Ralph N. Brodie Co., owner, \$218,748. ARCHITECT: John B. Anthony, Oakland; 1 story, 80,000 sq. ft., reinforced concrete & steel construction. Wood roof trusses, office, 5,000 sq. ft., reinforced concrete & frame construction. GENERAL CONTRACTOR: Calif. Builders Co., Oakland.

**NEW BRET HARTE ELEMENTARY SCHOOL**, San Francisco. City & County of San Francisco, owner, 20 classrooms, administration, all purpose room, library, cafeteria & toilet rooms, \$1,223,359. ARCHITECT: Lewis Hobart & Ralph Kerr, San Francisco; 2 story, reinforced concrete construction. GENERAL CONTRACTOR: Cahill Bros., San Francisco.

**JOHNSTON SCHOOL**, Norwalk, Los Angeles county. Norwalk School District, owner, 18 classrooms, 3 kindergarten units, remedial room, administration building, oil purpose room, \$474,049.73. ARCHITECT: Kistner, Curtis & Wright, Los Angeles. GENERAL CONTRACTOR: Mark C. Walker & Son, Santa Ana.

**FACTORY BUILDING**, East Hawthorne, Los Angeles county. G. Page, owner, 2 room, industrial drug manufacturing building, \$268,000. ENGINEERS: Witherly & Novikovf, Los Angeles; 1 story, reinforced brick, 67,000 sq. ft., composition roofing, concrete floor slab, steel sash, steel rolling doors. GENERAL CONTRACTOR: Co-Ordinated Construction, Inc., Hawthorne.

**WAREHOUSE & OFFICE BUILDING**, Oxnard, Ventura county. Associated Telephone Co., owner, 1 and 2 story panelcrete warehouse, \$165,000. ARCHITECTS: McClellan, MacDonald & Markwith, Los Angeles, panelcrete warehouse & office building, 107x105 sq. ft., composition roofing, tapered steel girders, steel sash, concrete and asphalt tile floors.

**WAREHOUSE BUILDING**, San Leandro, Alameda county. San Leandro Industrial Corp., owner, \$46,700. ARCHITECT: Lloyd Gartner, San Francisco; 1 story, 12,000 sq.

ft., tilt-up reinforced concrete construction. GENERAL CONTRACTOR: Baingo Construction Co., San Leandro.

**SUNDAY SCHOOL BUILDING**, Walnut Creek, Contra Costa county. First Presbyterian Church, owner, \$100,000. ARCHITECT: Donald Hardison, Richmond, frame & stucco construction, concrete block. GENERAL CONTRACTOR: F. C. Kirkham, Walnut Creek.

**GRAMMAR SCHOOL**, Rocklin, Placer county. Rocklin Elementary School District, owner, 9 classrooms, kindergarten, offices, multi-purpose & toilet rooms, \$358,514. ARCHITECT: Gordon Stafford, Sacramento, frame & stucco construction. GENERAL CONTRACTOR: Arthur Odman, Fair Oaks.

**CHURCH**, Oakland, Alameda county. Grand Lake Lutheran Church, owner, \$100,000. ARCHITECT: John H. Christie, Orinda, frame & stucco construction. GENERAL CONTRACTOR: Hugo Miller, Jr., Oakland.

**CONVENT BUILDING**, Santa Clara, Santa Clara county. Roman Catholic Archbishop of San Francisco, owner. St. Clara Parish, \$138,181. ARCHITECT: Ryan & Lee, San Francisco; 2 story, frame & stucco construction. GENERAL CONTRACTOR: W. J. Nicholson Co., Santa Clara.

**NEW JUNIOR HIGH SCHOOL**, Corcoran, Kings county. Corcoran Union Elementary School District, owner, 18 classrooms, administration, showers & lockers & toilet rooms, \$590,000. ARCHITECT: H. L. Gogerty, Los Angeles, reinforced concrete & frame construction. GENERAL CONTRACTOR: Flowers & Shirley, Tulare.

**DRUG STORE**, Rodeo, Contra Costa county. Vincent L. Ruggeri, owner, \$50,000. DRAFTSMAN: Frank L. Velkonia, Rodeo, 1 story concrete block & frame construction. GENERAL CONTRACTOR: M. Pagni, Crockett.

**MEDICAL BUILDING**, Lynwood, Los Angeles county. Mr. & Mrs. Rollin F. Kelson, owners, \$44,000. ARCHITECTS: Presnell Associates, South Pasadena, frame & stucco, brick veneer construction, 96x101 ft., composition roofing, steel eave, wood floor & linoleum. GENERAL CONTRACTOR: Kitts & Meddock, Huntington Park.

**FEED PREPARATION UNIT**, Torrance, Los Angeles county. General Petroleum Corp., owner, \$400,000. ARCHITECTS: Parker Zehnder & Associates, Los Angeles, reinforced concrete roof, cast in place piles, 57x76 sq. ft., reinforcing steel. GENERAL CONTRACTORS: J. B. Gill Co., Long Beach.

**TELEPHONE BUILDING**, Culver City, Los Angeles county. Pacific Telephone & Telegraph Co., owner, 2 story, \$300,000. ARCHITECTS: Briney, Bernard & Woodford, Los Angeles, reinforced concrete walls, steel frame construction, composition roofing, concrete floors, asphalt tile, metal sash, 150x150 sq. ft. GENERAL CONTRACTOR: Escherich Bros., Inc., Los Angeles.

**EDUCATIONAL & SOCIAL BUILDING**, Palo Alto, Santa Clara county. First Methodist Church, owner, \$211,566. ARCHITECT: Carlton & Steiner, Berkeley, concrete brick & frame construction. GENERAL CONTRACTOR: Wells P. Goodenough, Palo Alto.

**ELEMENTARY SCHOOL**, Palo Alto, Santa Clara county. Palo Alto Unified School District, owner, 12 classrooms, 2 kindergartens, administration & toilet rooms, \$292,000. ARCHITECT: Birge M. Clark & Walter Struetsma, Palo Alto, frame & stucco construction. GENERAL CONTRACTOR: Earl W. Emley, Saratoga.

**INDIAN HOSPITAL**, Bernalillo county, New Mexico. Bureau of Indian Affairs and Bernalillo County, joint owners, 152 bed hos-

## PANACALITE

The Standard for Perlite Aggregates  
An Engineered Product—Engineering  
Service

Air Classified—Sized & Graded for  
Plaster, Concrete & Stucco  
Aggregates

Listed Underwriters' Laboratories  
Re-examination Service

Fire Ratings:  
Non-Bearing Walls—2 hours  
Floor and Beam—4 hours  
Columns—2 & 3 hours  
Suspended Ceiling—4 hours  
Others

Manufactured by  
American Perlite Corporation  
26th & 8 Sts.—Yard 2—Richmond  
BEcon 5-1285



pital, \$2,168,916. ARCHITECT: Ferguson & Stevens, Albuquerque, 2 story, reinforced concrete construction. GENERAL CONTRACTOR: Lemcke, Clough & King, Albuquerque.

**MUSIC DEPARTMENT BUILDING,** Vallejo, Contra Costa county, Vallejo Unified School District, owner, \$105,880. ARCHITECT: Jack Buchter, Orinda, reinforced concrete & frame construction. GENERAL CONTRACTOR: Carl Overea & Co., Richmond.

**SEWAGE DISPOSAL PLANT,** Mountain View, Santa Clara county, City of Mountain View, owner, \$264,346. ENGINEER: Whipple Engineering Co., Palo Alto, General CONTRACTOR: F. S. Rolandi, Jr., San Francisco.

**HIGHWAY PATROL BUILDING,** Modesto, Stanislaus county, K. Vorn & Assoc., owner, \$30,000. ARCHITECT: G. N. Hillburn, Modesto, 1 story, frame & stucco construction. GENERAL CONTRACTOR: Wieland Bros., Modesto.

**OFFICE & FACTORY BUILDING,** Los Angeles, Los Angeles county, Westco Distalting Co., owner, 1 story, \$85,000. ARCHITECT: Ulrich Platt, Los Angeles, reinforced concrete, 35,000 sq. ft., composition roofing. GENERAL CONTRACTOR: Sapp Bros. Construction Co., Los Angeles.

**DORMITORY BUILDING,** Pino Alto, Santa Cruz county, Salesian College Pino Alto, owner, \$107,000. ARCHITECT: Gene Berge & Assoc., Los Angeles, 2 story, brick & frame construction. GENERAL CONTRACTOR: T. H. Rosewall, Watsonville.

**SHOP BUILDING,** Fresno, Fresno county, Fresno Board of Education, owner, \$215,205. ARCHITECT: Robert Stanton, Carmel, frame & stucco construction. GENERAL CONTRACTOR: L. H. Hansen & Son, Fresno.

**GRAMMAR SCHOOL,** Kings City, Monterey county, Kings City Elementary School District, owner, 4 classrooms, administration, kindergarten, multi-purpose, toilet rooms, \$144,726. ARCHITECT: Wm. H. Rowe, San Francisco, frame & stucco construction. GENERAL CONTRACTOR: J. A. Barrow, Salinas.

**CHILDREN'S HOSPITAL & GUIDANCE CLINIC,** Fresno, Fresno county, Valley Children's Hospital Association, owner, 40 beds, \$496,822. ARCHITECT: William Hartup, Fresno, reinforced concrete & frame & stucco construction, metal partitions, concrete floors, steel sash, steel trusses, insulation. GENERAL CONTRACTOR: Harris Construction Co., Fresno.

**STORAGE & OFFICE BUILDING,** Whittier, Los Angeles county, Associated Telephone Co., owner, 2 stories, \$650,000. ARCHITECTS & ENGINEERS: Albert C. Martin & Assoc., Los Angeles, reinforced brick construction with built up composition roofing. GENERAL CONTRACTOR: Beyer & Abrahamson, Los Angeles.

**STORE BUILDING,** Norwalk, Los Angeles county, Pacific Mutual Life Insurance Co., owner, 2 story, \$280,000. ARCHITECTS & ENGINEERS: Stiles Clements, Los Angeles, reinforced brick construction, 30,900 sq. ft., composition roofing. GENERAL CONTRACTOR: Jackson Bros., Los Angeles.

**CHURCH BUILDING,** Los Angeles, Los Angeles county, Roman Catholic, Archbishop of Los Angeles, owner, St. Hilary Parish, \$82,296. ENGINEER: Laurence D. Viale, North Hollywood, concrete block construction, 11,000 sq. ft., composition roofing, concrete slab asphalt tile floors, steel sash, forced air heating. GENERAL CONTRACTOR: R. J. Brennan, Los Angeles.

**NEW SCHOOL PLANT,** Artesia, Los Angeles county, Bloomfield School District, owner, 17 rooms, 4 classrooms, administra-

tive unit, cafeteria, \$389,240. ARCHITECT: Kenneth S. Wing, Long Beach, frame & stucco construction, concrete slab, composition roofing, asphalt tile floors, metal toilet partitions, radiant heating. GENERAL CONTRACTOR: Albert Reingardt, Long Beach.

**RECTORY,** Alhambra, Los Angeles county, Roman Catholic, Archbishop of Los Angeles, owner, 15 rooms, 2 story, 5 bathrooms, \$60,000. ARCHITECT: J. Earl Trudeau, Alhambra, frame & stucco construction, brick trim, 6,300 sq. ft., composition roofing, hardwood & plywood floors, linoleum & cork tile. GENERAL CONTRACTOR: Ben K. Tanner & Son, Beverly Hills.

**APARTMENT BUILDING,** San Francisco, Thos. Short, owner, 4 apartments, \$84,000. ARCHITECT: W. D. Peugh, San Francisco, 4 story frame & stucco construction, redwood exterior, concrete retaining walls. GENERAL CONTRACTORS: Jacks & Irvine, San Francisco.

**ELEMENTARY SCHOOL,** Challenge, Yuba county, Yuba-Feather Union Elementary School District, owner, 6 classrooms, kindergarten, multi-purpose, kitchen, toilet rooms, \$273,000. ARCHITECT: Charles F. Dean, Sacramento, frame & stucco construction. GENERAL CONTRACTOR: C. D. Mitchem, Quincy.

**NILES ROAD ELEMENTARY SCHOOL,** Hayward, Alameda county, Hayward Elementary School District, owner, 7 classrooms, administration, kindergarten, multi-purpose, kitchen & toilet rooms, \$294,710. ARCHITECT: Anderson & Simonds, Oakland, frame & stucco construction. GENERAL CONTRACTOR: N. T. Lewis, Hayward.

**OFFICE & STORE BUILDING,** San Jose,

Santa Clara county, Tom Doyle, owner, \$72,938. STRUCTURAL ENGINEER: G. W. Cotterill, Oakland, 1 story, concrete block & frame construction. GENERAL CONTRACTOR: O. E. Anderson, San Jose.

**SHOPPING CENTER,** San Francisco, Stone-son Development Corp., owner, store, building, restaurant & store building, retail store building, \$243,800. ARCHITECT: Welton Beckett, Los Angeles, 1 story, class No. 3, reinforced concrete & frame construction. GENERAL CONTRACTOR: MacDonald, Young & Nelson, San Francisco.

**SEWAGE TREATMENT PLANT,** Antioch, Contra Costa county, City of Antioch, owner, \$492,433. ENGINEER: John S. Bates, Berkeley, reinforced concrete construction. GENERAL CONTRACTOR: Ke-Ston Construction Co. & Mundy, South Gate.

**PALMYRA SCHOOL,** Orange county, Orange elementary School District, owner, 8 classrooms, kindergarten & administrative unit, \$240,000. ARCHITECT: Paul O. Davis, Los Angeles, frame & stucco construction, composition roofing, cement & asphalt tile floors, structural steel, steel sash, radiant heating. GENERAL CONTRACTOR: C. W. Devore, Garden Grove.

**NEW SCHOOL BUILDING,** Pismo Beach, San Luis Obispo county, Pismo School District, owner, 16 classrooms, kindergarten, home economics, shops, administrative & multi-use room, \$489,936. ARCHITECT & ENGINEERS: Daniel, Mann, Johnson & Mendenhall, Los Angeles, frame & stucco construction, composition roofing, cement & asphalt tile floors, structural steel, occasional work. GENERAL CONTRACTOR: C. C. Sharps, Arroyo Grande.

## How to place telephone outlets to protect home's future beauty



You protect the beauty of home interiors by providing for extra telephone outlets in the phone. Current building practices, such as the reduction in size or omission of inside trim, make future installation of telephone facilities difficult. But concealment of facilities is assured when built-in conduit is indicated in blueprints.

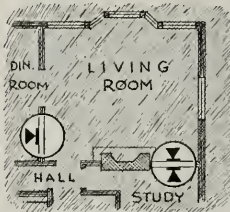

Plan for telephone service where the users will spend most of their time. Low-cost facilities for concealed wiring are easy to install, mean extra client satisfaction. New telephone can be added without running wires along the walls or floor. For free help in planning, call your local Pacific Telephone office, ask for "Architects & Builders Service."

Put built-in telephone facilities in your plans



Pacific Telephone

# IN THE NEWS

## SOUTHERN CALIFORNIA PUBLIC WORKS VOLUME

Dollar volume of public works started in southern California during July rose to a new all-time high of \$85,091,924, a rise of 34 per cent above the previous high established in June and 106 per cent higher than the total for July last year.

Featured in the volume was military, naval, and public school construction.

This brings to \$228,403,000 the volume of construction in this area for the first seven months of this year.

## FLYING TIGER LINE TO BUILD OFFICES

The Flying Tiger Line has purchased 740 feet of business property on Sherman Way in Burbank for site of a new two-story office building.

According to Fred Benninger, general manager of the airline, work on the new building will be started at once.

## ADDITIONAL WHITTIER HOMES UNDER CONSTRUCTION

A third unit of two and three bedroom homes, designed by architect Edward H. Fickett, is being constructed in the Lake Marie Rancho area of Whittier.

The interesting ranch style homes are being offered in a wide variety of floor plans, using California Redwood and floor to ceiling heavy plate glass windows the length of the living room. Ceramic tile, red cedar shingles, hardwood parquet flooring on steel reinforced substructures, and extra large wardrobe closets are other features of the homes.

## PASADENA ARCHITECT DESIGNS ANAHEIM HOMES

Marion J. Varner, architect of Pasadena, has designed a number of two and three bedroom homes for construction in Anaheim by builders Linderman & Bain of Westland Homes.

The houses will have a price range of \$12,500 to \$14,875.

## LUMBER OFFICIAL HAS RESIGNED

R. A. Colgan, Jr., has resigned as executive vice-president of the National Lumber Manufacturers Association.

He will continue to serve the group in an advisory capacity.

## LOS ANGELES ADDITIONS

There were 683 building permits issued in Los Angeles county during the month of July calling for the addition of existing building facilities at a construction cost of \$1,755,000.

## PIONEER PLASTIC FIRM PURCHASED

Lee T. Borden, president of the newly formed Sierra Electric & Manufacturing Company of Los Angeles, has announced the purchase of the McDonald Manufacturing Company, pioneer plastic and electrical firm of the West.

At the same time Borden announced the election of J. C. Prior as vice-president; and F. W. Walters as sales manager.

## TEXAS FLOOD CONTROL PROJECT GETS TENTATIVE APPROVAL

A plan to construct a dam and reservoir near Gonzales, Texas, and make channel improvements at San Antonio and Ken-

edy, has been tentatively approved by the Army Board of Engineers for Rivers and Harbors.

The project has been recommended by the Fort Worth District Engineer, and involves an expenditure of \$13,364,400.

## CONGRESS APPROVES DEFENSE PROJECTS

The United States Congress has approved a number of construction projects for the Army and Navy under provisions of the national defense.

Among those receiving allotments for construction purposes are the Stead Air Base, located a few miles north of Reno, Nevada; the Fallon (Nevada) Navy Air Landing Strip; and the Hawthorne Naval Ammunition Depot, also located in Nevada.

Total amount allocated for the three projects is in excess of \$11,300,000.

## NEW POST OFFICE BUILDING AT FRESNO

Working drawings have been completed by engineer J. R. Straley of Los Angeles, for the construction of a new post office building in Fresno which will contain 15,000 sq. ft. and will be of brick construction.

## VALLEJO HOUSING PROJECT STARTS

The Vallejo Housing Authority has been granted a building permit for the construction of a 263 single family dwelling project in Vallejo Manor.

All houses will have three bed rooms, living room, kitchen, bath and attached single car garage.

Cost of the project is estimated at \$1,972,500.

## HOSPITAL FUND CAMPAIGN

A fund raising campaign is under way in Napa to provide money for the construction of a 40-bed addition to the Parks Victoria Memorial Hospital.

Cost of the addition is estimated at \$500,000.

## PEANUT PLANT EXPANSION

Preliminary plans are underway for the expansion of the Planters Nut & Chocolate Company's plant in San Francisco at a cost of \$2,000,000.

The proposed construction calls for a 5-story and basement building containing 270,000 sq. ft. It will be an addition to the old Ferry-Morse Seed Company building at Bayshore Highway and Paul Avenue and will also involve acquisition of 6½ additional acres of land.

## LOW RENTAL HOUSING PROJECT FOR SAN FRANCISCO

The architectural firm of Ambrose & Spencer has been appointed by the San Francisco Housing Authority to draft plans for the construction of a 400-600 unit low rental housing project in the Jefferson Square area of San Francisco.

Estimated cost of the construction is \$6,000,000.

## LOS ANGELES HAS ADVISORY BOARD

The Los Angeles Home Builders Institute has appointed an Advisory Council to consult with the County Board of Supervisors on matters of land development and subdivision as an aid to future planning of new residential communities for Greater Los Angeles.

According to Clifford L. Rowson, secretary of the Institute, one of the more urgent needs at present is extension of sewer systems into new areas.

## POWER PLANT PROJECT OK

The Colkdale Irrigation District, Colkdale, California, has been granted authorization by the United States Government for the construction of a power plant including a power plant on the Stanislaus River in Colavera and Tuolumne counties.

According to Irrigation District officials the cost of the project will exceed \$7,800,000.

## ASSOCIATED GENERAL CONTRACTORS MEET

Representatives of The Associated General Contractors of America from all sections of the United States and Alaska met in Chicago early in September when the Governing and Advisory Boards convened to consider problems faced by construction firms in carrying out defense and essential civilian construction.

Special consideration was given the Controlled Materials Plan which became effective October 1, and its effect upon construction work already in progress; work under consideration; wage controls; and price controls.

## LOS ANGELES BUILDING AMONG TOP IN NATION

Los Angeles building activities this year is setting the pace for other great American cities, with the totals for the first seven months of the year reaching a total of \$173,097,815 in building permits.

This is \$40,630,000 higher than Chicago and \$72,371,000 greater than Detroit.

Los Angeles was only topped by New York in the national figures.

## FOLSOM DAM CONTRACT AWARDED EASTERN FIRM

Merritt-Chapman & Scott Corporation of New York and the Savin Construction Corp. of Hartford, Conn., were awarded the contract by the U. S. Army Corps of Engineers for the construction of the Folsom Dam on the American River at Folsom, California.

Ralph E. DeSimone, executive vice-president and general manager, announced that David Stinson will be project manager.

Cost of the 1,400 ft. long dam, which will be 340 ft. in height, will exceed \$29,444,000.

## PROMINENT AUSTRALIAN LAUDS PLUMBING INDUSTRY

S. M. Gilmore, secretary of the Victorian Employers' Federation of Melbourne, Australia, while visiting the Plumbing and Heating Industries Bureau in Chicago recently, declared, "In no country in the world has the plumbing industry attained the standard of public appreciation which it deserves. In the United States, however, the industry comes closer to it than anywhere else."

Gilmore was on his way home following attendance of the International Labor Conference in Geneva, Switzerland.

## NEW DEVELOPMENT IN PAINT FIELD

Trouble free deep color is one of the advantages of the newest development in the paint field announced by W. P. Fuller & Co.

Many architects and builders are already familiar with the easy color selector,

### Thinking of Building?

From our cost records and experience, an advance estimate may be made from decidedly general information. Based on our knowledge of labor and material costs, gained on current jobs, such an estimate may be helpful in determining your construction program.

ALL TYPES CONSTRUCTION  
SAN FRANCISCO - SACRAMENTO

**SWINERTON & WALBERG CO.**  
OAKLAND - LOS ANGELES - DENVER

### STATIONERY SCHOOL & OFFICE SUPPLIES

•  
Printing Engraving  
Announcements

### CENTER STATIONERY

468 McAllister  
San Francisco UN 1-3703

### MULLEN MFG. COMPANY

—  
BANK, STORE AND OFFICE  
FIXTURES—CABINET WORK  
OF GUARANTEED QUALITY  
CHURCH SEATING

—  
Office and Factory  
40-80 RAUSCH ST., Bet. 7th and 8th Sts.  
San Francisco  
Telephone UNdarhill 1-5815

*Fine*  
**ENGRAVINGS**  
**POOR RICHARD**  
PHOTO ENGRAVING CO.  
320-324 COMMERCIAL STREET  
SAN FRANCISCO, 11

which makes it possible for them to specify color exactly a range or more than 216 colors.

With the slogan "Ful-Color in Any Color You Want," the company announces that the latest latex paint has been incorporated into the firm's already well established Color Control system.

### PLUMBING CODE FOR LOS ANGELES COUNTY

Organized plumbing contractors throughout Los Angeles county are advocating adoption of the "national uniform plumbing code" as a minimum code for Los Angeles county.

General adoption of the code would eliminate confusion now resulting from variances in requirements of different cities and towns.

### HOME BUILDERS ATTEND MEETING

Two prominent Los Angeles builders, Milton J. Brock and Fritz B. Burns, attended a recent meeting of the executive committee of the National Association of Home Builders in Washington, D. C.

About twenty-five leading home builders from all parts of the country attended the three-day meeting, called by W. P. Atkinson, NAHB president to discuss industry problems and to confer with government housing officials.

### SOCIALIZED HOUSING BEATEN IN MISSOURI

Voters in St. Joseph, Mo., recently rejected by a vote of 2 to 1 a plan of "socialized" housing, and follows closely action taken by the Lincoln, Nebraska, city council in rejecting public housing.

It was reported that the Lincoln Public Housing Authority has been defeated three times within the past year and a half in a "socialized" housing program.

### ARCHITECT SELECTED

Architect Benj. Lippold of Fresno has been selected by the Board of the West Side Union High School District (Merced County) to draft plans for the construction of a new Band Room at the Los Banos High School.

### SEVENTY-FIVE YEARS OF DEVELOPMENT

The Chase Brass & Copper Co. recently celebrated their 75th birthday and in commemoration of the event published a very interesting edition of the "Chase News" containing a number of "old" photographs together with a diversified analysis of the firm's growth and expansion.

### NEW JUNIOR COLLEGE BUILDINGS

Preliminary drawings are in progress for the construction of new Junior College Buildings in Bakersfield, California.

The buildings are being designed by Wright, Metcalf & Parsons, architects of Bakersfield, and represent a tentative construction cost of \$4,000,000.

### TAXES VS HOUSING

Americans spent more last year on taxes, \$20½-billion, than they did on cost of housing, \$19.9-billion. This year the Government has raised taxes and at the same time reduced new home construction.

MORE than 5,000 new members have joined the National Association of Home Builders since January 1, 1951.



### HERRICK IRON WORKS STRUCTURAL STEEL REINFORCING STEEL

18TH AND CAMPBELL STS.  
OAKLAND, CALIF.  
Phone GLencourt 1-1747

Phone GARfield 1-1144

### Thomas B. Hunter DESIGNER OF HEATING

AIR CONDITIONING  
VENTILATING AND WIRING  
SYSTEMS, MECHANICAL  
AND ELECTRICAL EQUIP-  
MENT OF BUILDINGS

★  
41 SUTTER STREET  
ROOM 710  
San Francisco California

Subscribe  
Now —

### ARCHITECT and ENGINEER

\$3.00  
Per Year

### DINWIDDIE CONSTRUCTION COMPANY

### BUILDERS

•  
CROCKER BUILDING  
SAN FRANCISCO

Subscribe  
Now —

## ARCHITECT and ENGINEER

\$3.00  
Per Year

## STOLTE INC.

*General Contractors*



OAKLAND • CALIFORNIA

## PITTSBURGH TESTING LABORATORY

ENGINEERS AND CHEMISTS

Testing and Inspection of Concrete,  
Steel and Other Structural Materials

Design of Concrete Mixes

Offices in all principal cities

651 Howard St., San Francisco 5  
EXbrook 2-1747

## MATTOCK CONSTRUCTION COMPANY



**BUILDERS**



604 MISSION STREET  
SAN FRANCISCO

## Index to Advertisers

AMERICAN Perlite Corp.....	44
ANGER Pacific Corp.....	35
ARCHITECTS Reports .....	38
BARRETT & HILP, Contractors.....	35
CLASSIFIED Advertising .....	43
CENTER Stationery .....	47
CLAY Brick & Tile Association.....	Inside Front Cover
CLINTON Construction Company.....	36
DINWIDDIE Construction Co.....	47
ELECTROMODE Corp. ....	*
FULLER, W. P. Co.....	*
FORDERER Cornice Works.....	35
GLADDING McBean & Company.....	*
GREENBERG'S, M. Sons.....	32
HANKS, Inc., Abbott A.....	48
HAW'S Drinking Faucet Co.....	28-29
HERRICK Iron Works.....	47
HILLYARD Chemical Co.....	31
HOGAN Lumber Co.....	36
HUNT, Robert W., Company.....	48
HUNTER, Thos. B.....	47
JOHNSON, S. T. Co.....	32
JUDSON, Pacific-Murphy Corp.....	36
KRAFTLE Company .....	26
MARBLE Institute of America.....	*
MATTOCK Construction Co.....	48
MICHEL & Pfeiffer Iron Works.....	4 and 5
MULLEN Mfg. Co.....	47
PACIFIC Clay Products Co.....	*
PACIFIC Manufacturing Company.....	37
PACIFIC Portland Cement Company .....	Back Cover
PACIFIC Telephone & Telegraph Co. 45	
PARKER, Steffens & Pearce.....	35
PITTSBURGH Testing Laboratory.....	48
POOR Richard Engraving Co.....	47
PORCELAIN Enamel (Architectural Division) Publicity Bureau.....	34
REMILLARD-Dandini Co. ....	48
REPUBLIC Steel Corporation.....	37
SIMONDS Machinery Company.....	37
SISALKRAFT Company .....	36
SMOOTH-Holman Company .....	33
SOTO, Henry C., Corp., Landscape Engineers .....	33
STANLEY Works, The.....	*
STOLTE, Inc. ....	48
SUPERIOR Fireplace Co.....	*
SWINERTON & Walberg Co.....	47
U. S. Bonds.....	3
UTILITY Appliances Corp'n.....	34
VERMONT Marble Company.....	37
WEST Coast Screen Co.....	27
WESTERN Asbestos Company.....	*

\*Indicates Alternate Months

## ROBERT W. HUNT CO.

ENGINEERS

INSPECTING TESTING

STRUCTURAL MATERIALS  
CONCRETE MIX DESIGN  
CHEMICAL ANALYSIS  
EQUIPMENT

PRINCIPAL CITIES  
UNITED STATES • EUROPE  
SAN FRANCISCO LOS ANGELES  
PORTLAND SEATTLE

## REMILLARD-DANDINI Co.

Brick and  
Masonry Products



400 MONTGOMERY STREET  
SAN FRANCISCO, CALIF.

## Scott Company

HEATING • PLUMBING  
REFRIGERATION



San Francisco  
Oakland  
San Jose  
Los Angeles

## ABBOT A. HANKS, INC. Engineers & Chemists

INSPECTING — TESTING — CONSULTING  
CONCRETE • STEEL • MATERIALS  
CHEMICAL AND TESTING  
LABORATORIES

• RESEARCH AND INVESTIGATION •

—  
TESTS OF STRUCTURAL MATERIALS  
DESIGN OF CONCRETE MIXES  
SHOP AND ERECTION INSPECTION OF  
STRUCTURES AND EQUIPMENT  
INVESTIGATION OF STRUCTURES  
AND MATERIALS  
TESTS AND INVESTIGATION OF  
FOUNDATION SOILS  
FIRE RESISTANCE AND INSULATION  
TESTS

—  
624 Sacramento Street, San Francisco



# ARCHITECT AND ENGINEER

34 CALIFORNIA COMPANY

ARCHITECTS



MARTIN SPITZ & COMPANY, S.P.A. ARCHITECTS

NOVEMBER

1951

# Porcelain

**ENAMEL  
VENEER**

COMPLETE, from audio-visual facilities  
to floodlighted stadium, El Camino  
College encompasses every detail of  
architectural excellence.

ARCHITECTS: Marsh, Smith & Powell, A. I. A.

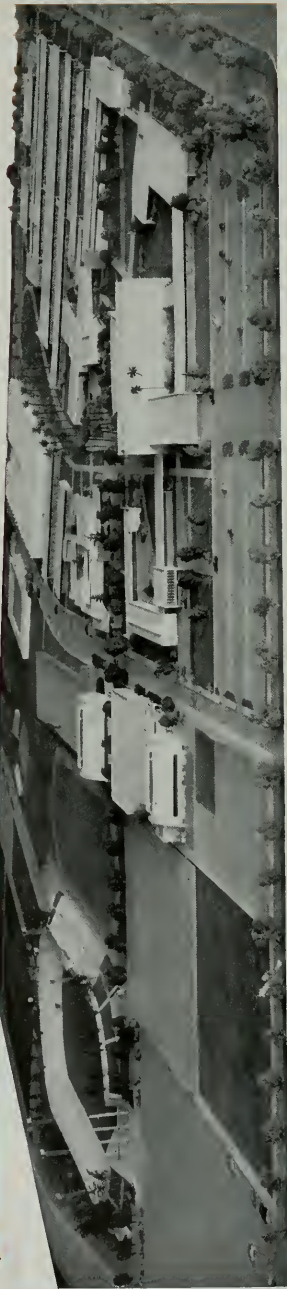

PORCELAIN ENAMEL Veneer was used on several of the present structures and has been specified for extensive use on the eleven remaining buildings of the project—many thousands of square feet! Only PORCELAIN ENAMEL offered all the advantages: Permanent protection from the elements ... fadeproof richness... vitreous luster ... fire-safety ... trim modernity... soap-and-water maintenance.

Investigate Porcelain Enamel Panels for curtain walls in essential building construction

*Architectural Division*

PORCELAIN ENAMEL PUBLICITY BUREAU  
P. O. BOX 125, EAST PASADENA STATION, PASADENA 5, CALIFORNIA  
ROOM 501, FRANKLIN BUILDING, OAKLAND 12, CALIFORNIA

# ARCHITECT

Vol. 187

No. 2

AND

# ENGINEER

ARCHITECTS' REPORTS—Published Daily

## Contents for

# NOVEMBER

EDWIN H. WILDER  
Editor

MARK DANIELS, A.I.A.  
Associate Editor

I. WELLS HASTINGS  
Contributing Editor

PROF. LELAND VAUGHAN  
Landscape Architecture

JOHN A. BLUME  
Structural Engineering

MICHAEL GOODMAN  
Planning

JOHN S. BOLLES, A.I.A.  
Book Reviews



### COVER PICTURE

#### EL CAMINO COLLEGE

The impact of extensive industrial expansion in southern California has resulted in construction of thousands of new residences.

Keeping pace with this phenomenal growth is the traditional California public school system, as is evidenced by the new El Camino College, located some ten miles southwest of Los Angeles, designed by the architectural firm of Marsh, Smith & Powell. See Page 14 for detailed story.

ARCHITECT & ENGINEER  
is indexed regularly by  
ENGINEERING INDEX, INC.

EDITORIAL NOTES . . . . .	4
JOINT INFORMATION COMMITTEE American Institute of Architects and The Producers Council, Inc. . . . .	8
NEWS & COMMENT ON ART . . . . .	9
DON'T LIFT IT ALONE, Hazards of Heavy Lifting in the Building Industry By DR. W. SCHWEISHEIMER . . . . .	11
NEW LOS ANGELES BUILDERS EXCHANGE, Architect and Builders Exchange Sponsor . . . . .	11
HOSPITAL BUILDING, West Contra Costa Hospital District, San Pablo, Calif. DOUGLAS DACRE STONE & LOU B. MULLOY, Architects PARKER, STEFFENS & PEARCE, Contractor . . . . .	12
EL CAMINO COLLEGE, From Barracks to Beauty, Southern California . . . . . By CARL G. ARFWEDSON & HOWARD H. MORGRIDGE MARSH, SMITH & POWELL, Architects . . . . .	14
CALIFORNIA COUNCIL OF ARCHITECTS, Coronado Echoes . . . . .	23
STRUCTURAL ENGINEERS ASSOCIATION, Yosemite Meeting . . . . .	24
A.I.A. ACTIVITIES . . . . .	26
WITH THE ENGINEERS . . . . .	28
PRODUCERS COUNCIL PAGE Edited by CARL B. FRANK, Detroit Steel Products . . . . .	30
BOOK REVIEWS, Pamphlets and Catalogues . . . . .	36
ESTIMATOR'S GUIDE, Building and Construction Materials . . . . .	39
ESTIMATOR'S DIRECTORY, Building and Construction Materials . . . . .	41
BUILDING TRADES WAGE SCALES, Northern, Central & Southern California . . . . .	42
CLASSIFIED ADVERTISING . . . . .	43
CONSTRUCTION CONTRACTS AWARDED, General Data . . . . .	44
IN THE NEWS . . . . .	46
INDEX TO ADVERTISERS . . . . .	48

ARCHITECT AND ENGINEER (Established 1905) is published on the 15th of the month by The Architect and Engineer, Inc., 68 Post St., San Francisco 4; Telephone EXbrook 2-7182. President, K. P. Kierulff; Vice-President and Manager, L. B. Penhorwood; Treasurer, E. N. Kierulff.

Los Angeles Office: Wentworth F. Green, 439 So. Western Ave., Los Angeles 5; Telephone DUnkirk 7-8135.

Entered as second class matter, November 2, 1905, at the Post Office in San Francisco, California, under the Act of March 3, 1879. Subscriptions United States and Pan America, \$3.00 a year; \$5.00 two years; foreign countries \$5.00 a year; single copy 50c. ARCHITECTS' REPORTS are published daily from this office, Vernon S. Yallop, Manager. Telephone DOuglas 2-8311.





# EDITORIAL NOTES

## CRITICAL MATERIALS

Is the federal administration's cry about material shortages in the construction industry "for real"?

Capable leaders in the home building industry throughout the nation point out that the curbs slapped on residential construction are the result of myths as the amount of "critical material", i.e. steel, iron, copper and aluminum used in home building, is not an "infinitesimal drop in the bucket" when measured in national production.

Specifically the 850,000 dwelling units, set as a national goal for 1951, will require 1.93% of the over-all ingot production of iron and steel, 6.25% of the production of copper, and 1.36% of the production of aluminum. In terms of 1,000,000 dwelling units percentages would increase about .25%.

Present housing restrictions will stimulate residential shortages, which in turn will be used as an argument by proponents of federal housing programs as proof that private builders have failed in their ability to meet the residential needs of the nation.

As one of the nation's most outstanding leaders in the construction industry sums up the situation, "The federal government has taken away from the general contracting industry the ability to give public bodies and private investors in construction the reasonable assurance that projects can be completed on normal schedule and at estimated costs."

\* \* \*

*"In France, landlords are so badly squeezed by rent controls that if a window is broken, it may take five to ten years rental to repair the damage."*  
—Poverty-stricken American landlords please note.

\* \* \*

## HOW MUCH? IT'S UP TO YOU!

On the basis of latest estimates, the Federal tax bill alone in the fiscal year ending 1953 will add up to almost \$700 for every man, woman and child in the United States, or in terms of family obligations our Federal taxes for that year will be \$2,460.

Assuming an additional \$20-billion will be "taken" in State or local taxes it is plain to see that the lowly taxpayer is in for a real financial pummeling unless he does something about it—and soon.

There is no fixed limit to the amount of taxes that can be assessed as the only actual limit is when the tax "take" is so great that it destroys the incentive of the people. However, economists agree that the initial level of taxation beyond

which inflationary forces come into play is 25% of the national income, and if this is true we are headed for a considerable amount of inflation as the national income for the fiscal 1953 period is estimated at \$310-billion with the tax burden estimated at \$107-billion.

You as an individual can do your part to keep the nation economically sound—1) make sure the people you elect to political office are capable and qualified, 2) do not become a party to buying or selling where sound business principles do not apply. Remember it is your fault every time taxes are upped.

\* \* \*

## 1952 HOME PRODUCTION IS MATTER OF SPECULATION

An estimated 1000 of the nation's leading home builders met in Atlantic City early this month to discuss the tremendously important subject of keeping pace with the need for new home construction and at the same time conform with the materials priorities essential to the national defense program.

These builders heard leading experts in the field of mortgage finance, government controls, building materials supply and architectural design, describe plans and programs for the conservation and control of steel, copper, aluminum and many other materials; economies of almost all building materials through re-design and use of alternate materials possibly made available through revisions in building codes; and the increasing complexities of mortgage finance and credit controls.

There is little doubt that a considerable amount of good can be derived from such a conference, and unquestionably leadership in the home construction industry, finance, and government are sincere in their desire to render an important national service, but in spite of all the theory and technical explanations the fact remains that there are numerous communities where housing shortages are creating acute economic and moral factors which can not be corrected by wishful thinking or theoretical planning.

There is little point in "saving" Europe and Asia for Europeans and Asiatics and loosing America for the Americans. It is far more important to meet the dire need of the people of this nation for adequate housing under a free enterprise system than it is to fail to recognize this and wake up some day to a complete government control of the home building industry.

The Construction Industry has a choice today . . . how about tomorrow!





**CONFER & WILLIS, A. I. A.**  
*Architects*

## Make "IDEAS CLICK with CLAY BRICK" in the Blue Cross Building • Oakland

**U**tilizing the strongest brick construction known—reinforced grouted brick masonry, the Blue Cross Hospital Service Building in Oakland has that "substantial look" so desirable in institutional buildings. Interior walls of colorful clay brick provide an ever fresh and relaxing appearance to the main foyer, conference room and the employees' penthouse lunch quarters. ★ The design is significant in its efficient and flexible use of the available gross floor area, unencumbered with numerous corridors and cubbyholes. The open office space, not now sectionalized, was designed so that partitions can be installed anywhere at a future date. All wiring and utilities can at any time conform to future partitions. ★ Efficient design and job programming resulted in a construction time of 180 days. The contract was awarded to Swinerton and Walberg, general contractor, 90 days after the building site was purchased. Harold B. Petersen, Alameda, is the mason contractor.



## **CLAY BRICK & TILE ASSOCIATION**

OF NORTHERN CALIFORNIA

**55 NEW MONTGOMERY STREET • SAN FRANCISCO**

Kroffile Company  
Remillard Dandini

L. P. McNear Brick Co.  
San Jose Brick & Tile

Part Costa Brick Works  
Stockton Brick & Tile Co.

United Materials & Richmond Brick Company

# JOINT INFORMATION COMMITTEE

AMERICAN INSTITUTE OF ARCHITECTS and THE PRODUCERS COUNCIL, INC.

---

Pictured as a whole the progress towards UNIFORM SPECIFICATION PROCEDURE and Trade Literature is continuing although it is necessary to make a round-up of several diversified areas to coordinate the action.

At the Hotel Benson in Portland, Oregon prior to the meeting of the California Council of Architects at Coronado there was a semi-annual meeting of the Board of Directors of the National A.I.A. held on September 30, October 1 and 2. A resume of the action taken at this meeting is reported as follows: A resolution was adopted regarding the proposed Card Filing Specification System (as suggested under the UNIFORM SPECIFICATION PROCEDURE program).

Resolved that the JOINT COMMITTEE of the A.I.A. and PRODUCERS' COUNCIL at the request of the Board of Directors give further consideration and study to implementation of this proposed service with a view to the development of more specific recommendations with respect to the same.

A meeting of the Joint Information Committee of the A.I.A. and Producers' Council for the National Organization has been called for November 15 at 9:30 A.M. in the Engineers Club in New York City. F. Bourn Hayne, A.I.A. will fly to New York to attend that meeting as the member from the Far West. Mr. Hayne has advised us that the agenda of this meeting is (1). 1952 Producer Literature Competition; (2). Card file and loose leaf Specification Service (a). Report of the A.I.A. Board of Directors and (b). Program of Further Consideration by the Joint Committee.

This would seem to indicate serious consideration of the UNIFORM SPECIFICATION PROCEDURE and Trade Literature programs is under way. With continued interest along this line the program will not stagnate or fall by the wayside and as pointed out locally by the drive on the part of

the Northern California Chapter of the A.I.A. supported by Joe McCarthy, A.I.A. president of the chapter, for better Public relations.

Mr. McCarthy supports the idea that the best Public Relations is not necessary publicity, but the program which provides a service based on information for the best interest of the profession whether it is on the level of the Mechanic, the Contractor or the Architect. For that reason it is thought that the UNIFORM SPECIFICATION PROCEDURE would be invaluable to the Building Trades and the best type of Public Relations for the A.I.A. For thru this type of service when it is used in the contractors office the mechanics and apprentices will be able to turn to an authority edited and accredited by the A.I.A. which will answer the installation procedure question and show the contractor that the Architect is not necessarily the impractical theorist that he is so frequently called.

If mutual confidence between these two all important groups in the Building Profession is encouraged through the development and use of UNIFORM SPECIFICATION PROCEDURES this will represent the best in Public Relations according to Joe McCarthy and everyone will surely agree with him.

The continued interest and consideration given to the UNIFORM SPECIFICATION PROCEDURE idea as shown by these activities is encouraging and may develop some definite action after thorough study. Discussion and study will serve to eradicate the problems so every meeting will add a little to the progress towards eventual adoption of a constructive plan to accomplish the objective of UNIFORM CONSTRUCTION PROCEDURES whether it is in the form of A.I.A. edited specification card files or some equally acceptable system discovered in the process of this examination.

---

*NOTE: This news space is being contributed by ARCHITECT & ENGINEER Magazine to the JOINT INFORMATION COMMITTEE representing the Northern California Chapter of The American Institute of Architects and the Northern California Chapter of the Producer's Council, Inc., and is available to this Committee for the purpose of bringing to the attention of leaders within the Construction Industry various phases of the Architectural profession and building materials industry procedures for general consideration and comment. Your "ideas" and any suggestions for the better pooling of thoughts along these lines should be sent to "Joint Information Committee, c/o The Architect & Engineer 68 Post Street, San Francisco," where they will be imme-*

# NEWS AND COMMENT ON ART

## CITY OF PARIS

The Rotunda Art Gallery of the City of Paris, San Francisco, under the direction of Beatrice Judd Ryan, will feature a Christmas Exhibit and Sale of Watercolors by Artists of the Rotunda Group during November.

A retrospective Exhibition by Jean de Botton, which will include the Coronation Pictures of King George VI will also be on exhibit from November 20 to December 13.

## PORTLAND ART MUSEUM

Thomas C. Colt, Jr., director of the Portland Art Museum, West Park and Madison, announces the following schedule of exhibits and events which will highlight the Museum's activities during November.

The Lovis Corinth Retrospective presents a sizable selection of works, including oils, watercolors, etchings, lithographs, and drawings by the German master.

An exhibition of Old Master Drawings repre-

sents drawings from three great private collections of works by masters of the 15th through the 18th centuries.

Works of thirteen Eugene painters and sculptors will be shown in the Oregon Artists' Gallery during November while the Third Annual Print Exhibition will go on display in December.

## CALIFORNIA PALACE OF THE LEGION OF HONOR

Thomas Carr Howe, Jr., director of the California Palace of the Legion of Honor, Lincoln Park, San Francisco, has announced the following special exhibits for November:

Period Pieces, an exhibition of Packaging examples of traditional package design; Contemporary American Painting and New Acquisitions of the Museum; Art by Children; Paintings by Weldon Kees; and "Liber Studiorum" by J. M. W. Turner.

The Educational Activities include classes for children, ages 4 to 15, each Saturday morning at

## M. H. DE YOUNG MEMORIAL MUSEUM

Golden Gate Park  
San Francisco

## "TREE"

drawing by JOHN W. WINKLER



10 o'clock; Painting Classes for adults each Saturday afternoon at 2 o'clock; Organ recitals each Saturday and Sunday at 3 p.m.; and free motion pictures on Saturday at 2:30 p.m.

### SAN FRANCISCO ART FESTIVAL

More than 1500 San Francisco artists took part in the Fifth Annual San Francisco Art Festival, sponsored by the Art Commission of the City and County of San Francisco, and held in the Palace of Fine Arts building.

Some 5000 art items were shown in addition to concerts, dance and drama programs, and a special "Art in Action" exhibit in ceramics. The event was attended by visitors from all parts of California and the West.

### SAN FRANCISCO MUSEUM OF ART

The San Francisco Museum of Art, War Memorial Building, Civic Center, offers the following exhibits and events for November:

**EXHIBITIONS.** A special display in the Rental Gallery; Modern Buildings for Schools and Colleges; Review of Collections; New Mexican Artists representing selections from the 38th Annual of the New Mexico Art Gallery; San Francisco Women Artists; 15th Annual Watercolor Exhibition of the San Francisco Art Association; and Woodblock Prints by Adja Yunkers.

**EVENTS.** Museum Lectures each Sunday at 3:15 p.m. and a special series "The Art of Today" each Monday at 8 o'clock; Gallery Tours are conducted Sundays at 2:30 p.m.; each Monday at 8 o'clock; Gallery Hours are conducted Friday evenings at 7:30; the Children's Art Classes each Saturday morning at 10 o'clock, and Painting Classes Friday evening at 7:30.

The Museum's television series which is being broadcast every other Sunday afternoon from 1:30 to 2 o'clock, is creating considerable interest and the program entitled "Art in Your Life" includes Pottery and Ceramics with Edith Heath, and Sculpture in Motion with Bob Winston in November. The December series is geared by the Holiday spirit and includes "Toys with a Purpose," Sunday, December 2; Art for Christmas, December 16, and Experimental Sculpture at the Sculpture Center on December 30th.

### M. H. deYOUNG MEMORIAL MUSEUM

The M. H. deYoung Memorial Museum in Golden Gate Park, San Francisco, under the di-

rection of Walter Heil, announces a special exhibit will be shown during November including the following:

Paintings and Drawings by Maxim Kopf; Paintings of The Crucifixion by Rico Lebrun; a special group of twenty-one British Paintings; "Sierra Nevadaiana," drawing and woods by John W. Winkler; and the 12th Annual Exhibition of the Society of Western Artists which includes Watercolors and Sculptures.

The 12th Annual Exhibition of The Society of Western Artists represents seven hundred entries from artists of the Pacific Coast. Sixty-eight Oils, forty-two Watercolors, and five pieces of Sculpture are shown.

Other Museum activities include Painting Classes for adults on Friday and Saturday mornings at 10:30; the Studio Workshop on Friday and Saturday afternoons, 1:30 to 4:00; classes on Painting Criticism each Friday and Saturday afternoon at 4 o'clock; and Classes for Children each Saturday morning from 10:15 to 11:30.

### ANNUAL EXHIBITION OF THE SOCIETY OF WESTERN ARTISTS

The 12th Annual Exhibition of The Society of Western Artists is being shown during November at the M. H. deYoung Memorial Museum in Golden Gate Park, San Francisco.

The Exhibition consists of sixty-eight Oil Paintings, forty-two Water-Colors, and five pieces of Sculpture selected from more than seven hundred entries. Chairman of the Jury Abel Warshawsky, noted painter of Monterey, and members Donald Teague, staff artist for the Saturday Evening Post; Alexander Fried, Art Editor of the San Francisco Examiner; and Ninfa Valve, associate curator of painting at the deYoung Museum, report the work submitted by artists in California, Oregon, Nevada and Wisconsin is outstanding in the fields of objective art.

Among artists receiving awards were Anna Elizabeth Klumpke Award for Figure Painting or Portrait, won by M. Askenazy; Oil Painting Awards 1) Benton Scott, "Place Du Tertre"; 2) Nicolai Fachin, "Barge Captain," 3) Nancy Martin, "Study of Ruby." Honorable mention: J. N. Swanson, Amadio, Joshua Meador, and N. Eric Oback.

Water color awards 1) Henel B. Dooley, "Mist of the Bay," 2) Chiura Obata, "Sea Wind, Point Lobos," and 3) Ann K. Pennington, "Virginia City Ruins." Receiving honorable mention were Rene Weaver, Noel Quinn, Ralph Hulet and Chang Shu-Chi.



## HAZARDS OF HEAVY LIFTING IN THE BUILDING INDUSTRY

# DON'T LIFT IT ALONE!

By DR. W. SCHWEISHEIMER

A construction worker was going to move a heavy sack which contained many pounds of cement. He looked around for help but everyone was tied down with another job.

He didn't feel there was time to wait for help, so he lifted the whole sack himself impatiently to "get it over with."

He felt a strange sensation, a kind of sudden pain in the groin on his right side. The pain did not disappear.

The next day he saw his doctor who found a hernia on his right side. It was probably caused or at least aggravated by the heavy lifting of the day before.

Lifting heavy loads is part of the routine job for everyone active in the building industry. Excessive strain is placed on back, shoulders, abdominal

(belly) muscles and the heart muscle. The men who carry heavy weights on the shoulder often develop bruises, and callosities at the point of friction.

Proper precautions should be taken either by providing mechanical lifting appliances where practicable, or if lifting operations are done by hand, providing suitable aids in order to reduce vertical lift as much as possible.

### How Lifting Affects the Heart

A healthy heart, well trained by long practice, will not revolt against extra-strain imposed upon it by heavy lifting. A man can be an excellent mason or painter without being athletically built. His heart may do a good job for the average kind of work while it may suffer under exaggerated strain. The heart is a muscle, it may get tired by

(See Page 38)

---

## ARCHITECTS and BUILDERS EXCHANGE SPONSOR

# NEW LOS ANGELES BUILDERS EXCHANGE

Formation of a new Los Angeles Builders Exchange, sponsored by The California Council of Architects and the California State Builders Exchange, has been announced with operations scheduled to begin about November 1.

John Rex, President of the California Council of Architects, and Walter B. Mellott, President of the California State Builders Exchange, recently invited southern California's architects, engineers, contractors and suppliers of building materials who are members of recognized construction trade or professional associations to join in the sponsorship of the new Los Angeles Builders Exchange.

William Wright, Los Angeles construction industry figure who has served in executive capacities for the past three years, has been named to manage the new Exchange and the unique plans-room service contemplated by the Exchange.

The plans-room service was originally instituted and developed by the California Council of Architects, who now feel that such a service might

better be operated by a Los Angeles Builders Exchange in cooperation with the State Builders Exchange and by limiting membership in the new organization to recognized people in the construction field who are already members of their respective trade or professional association.

Functions of the Exchange, other than the plans-room services, will include a bid depository, and exchange of information facilities among trade associations, which in no way will conflict with existing associations functions and which will be subject to careful scrutiny to the Board of Directors. The Board of Directors will be comprised of one or two members of each trade or professional association participating in the new Exchange.

Among those present at the first organization meeting were Dale Missimer, Refrigeration and Air Conditioning Contractors Association; Norman Hunter, California Council of Architects; Floyd Baker, field representative for the Painting and

(See Page 31)

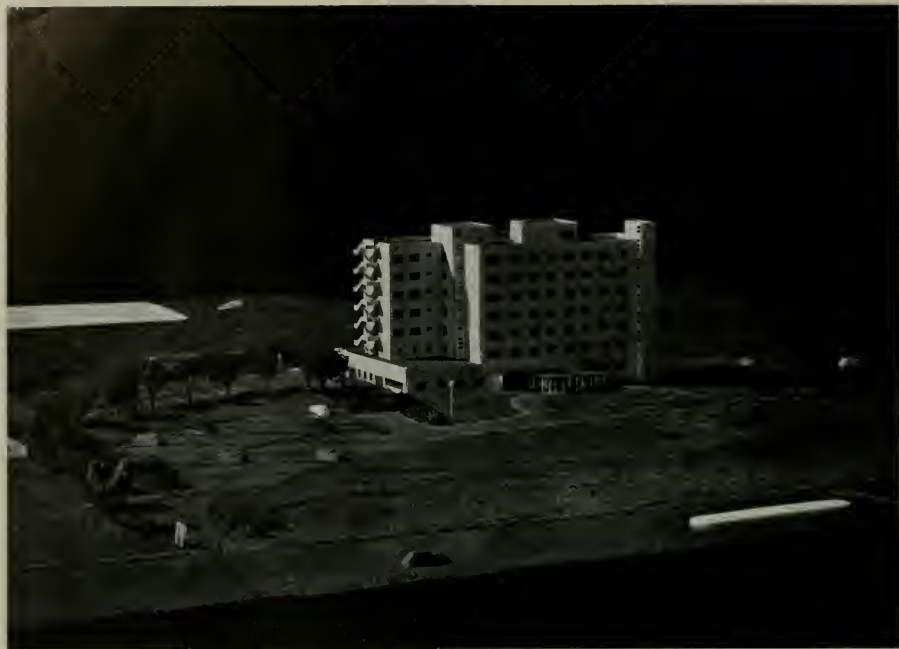

*Photos by John Black & Associates*

# HOSPITAL BUILDING

WEST CONTRA COSTA HOSPITAL DISTRICT

SAN PABLO, CALIFORNIA

**ONE HUNDER AND SIXTY FIVE BEDS**

Architects:

**DOUGLAS DACRE STONE**  
**LOU B. MULLOY**  
**S. P. MARRACCINI, Associate**

Contractor:

**PARKER,**  
**STEFFENS &**  
**PEARCE**

The original plans provided for a five story reinforced concrete structure. Later two additional stories were added, increasing the bed capacity to 165. The building will be earthquake proof. It em-

bodies the most up to date facilities for the care of patients with special nurses unit, medical, X-ray and operating facilities. Adequate parking room is provided adjacent to the main structure.





ENTRANCE TO STUDENT UNION BUILDING

FROM BARRACKS TO BEAUTY  
EL CAMINO COLLEGE  
SOUTHERN CALIFORNIA

By

CARL G. ARFWEDSON\* and HOWARD H. MORGRIDGE\*\*

ARCHITECTS  
LOS ANGELES

MARSH,  
SMITH &  
POWELL



"The astonishing growth of the public schools in California is no longer a phenomena but continues to evoke amazement in new-comers to the state. The impact of thousands of new industries established in the state during World War II and since revitalized by the Korean war has resulted in the construction of literally miles of homes, particularly in Southern California, with a result that school populations have doubled and trebled and more in the past few years.

California, the Golden State, has long led the nation in the establishment of junior colleges (although the term "junior" is being disregarded in polite educational circles because of the connotation of possible inferiority). The junior college is now referred to as a two-year institution of higher learning, or community college, some half dozen of which have been added in the southern part of the state within the past five years.

El Camino College situated at Alondra Park, some ten miles southwest of Los Angeles, is one of these newer colleges founded as a result of the tremendous population increase in the area. Established just four years ago, El Camino's enroll-

ment has, in the four years of its existence, increased from 1100 students to an enrollment this September of over 4200.

In its first year of existence El Camino College, a public school supported by local taxpayers and subsidized in some measure by the state, established its first classes in three public schools of the area while negotiations were carried on for the securing of its own campus. Faced with a need for land and without funds, since the district at that time had not become a taxing entity, negotiations were entered into with the Los Angeles County Board of Supervisors for some eighty acres of land in Alondra Park, a county park of approximately 319 acres, which lay undeveloped. Enabling bills were introduced in the State Legislature and signed by the Governor permitting the County Supervisors to transfer the park land to the school district. Under the terms of the agreement the college leased the property from the county with an option to purchase at an agreed price. The agreement also provided that if the college expended the amount of the purchase price for recreational facilities which could be used jointly by both the college and the general public the land would be deeded to the school district free and clear. After acquisition of the property, barracks type buildings were secured from the Federal Government and moved at government expense from the Santa Ana Army Air Base to the college site. These buildings, together with other

---

\* Carl G. Arjwedson is Director of Business Management of El Camino College and is one of the co-founders of this rapidly developing institution.

\*\* Howard H. Morgridge is one of the partners in the architectural firm of Marsh, Smith & Powell, Architects, one of the outstanding architectural firms on the West Coast.

#### GENERAL PLAN OF COLLEGE

Photos by Fred R. Dapprich



# EL CAMINO COLLEGE . . .

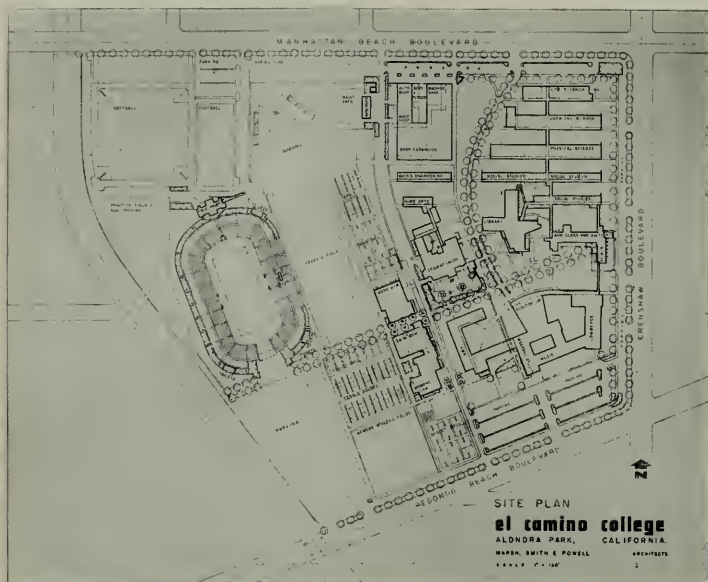

ABOVE—Site Plan of El Camino College

BELOW—Building entrance and landscaping



. . . EL CAMINO COLLEGE

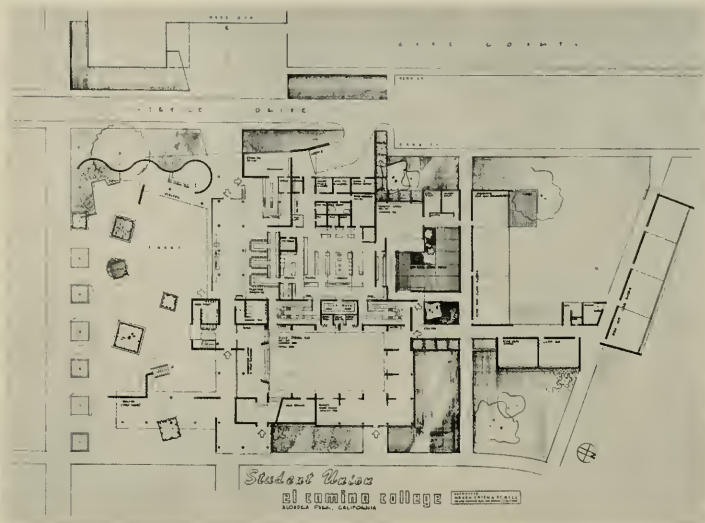

ABOVE—Site Plan Student Union

BELOW—Dining Room Student Union





**Women's  
Gymnasium  
Building**

temporary units, were erected on an area of the campus planned for later use as a parking lot.

Due to the purchase agreement with Los Angeles County the first permanent structures commenced were, necessarily, of a recreational nature. Utility lines were laid, campus streets and drives graded and paved, closely followed by a gymnasium building, concrete tennis courts, three football fields, a baseball diamond, Field House and Maintenance Shops and a stadium. This latter structure, when eventually completed, will seat between 19,000 and 20,000 persons. Upon near completion of the athletic recreational facili-

ties work was commenced on permanent academic buildings. Units so far completed include a shops building, nine classroom social science building, a new two story unit housing the administrative staff and ten classrooms. Construction is now commenced on a new life science building. Nearly \$3,500,000 has been spent to date for site improvements and building construction on the El Camino College campus which now embraces some ninety acres.

Center of the campus is dominated by a new building aptly named "Campus Center." This building being the center of student activities con-

#### **STUDENT UNION SODA FOUNTAIN AND LUNCHEON AREA**





Plan of  
LIBRARY  
BUILDING  
First Floor

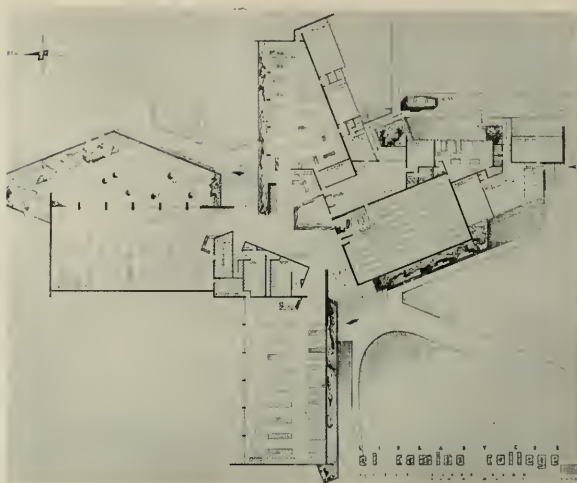

Below—One of the  
classroom and  
Administration  
Buildings

tains a large dining room with a seating capacity of 850 and auxiliary private dining rooms separated by Modern Fold doors, student association offices, student cooperative bookstore, soda fountain, student lounge and two outside dining patios. This building was built and furnished at a cost of \$500,000 and is of sufficient magnitude to provide

eating and recreational facilities for the estimated 10,000 students who will ultimately attend the college.

Master site plan of the campus and engineering of permanent buildings has been done by one of the state's leading architectural firms, Marsh, Smith and Powell, of Los Angeles. Design of build-



## EL CAMINO COLLEGE . . .

ings is contemporary modern with construction of reinforced concrete with large areas faced with architectural brick. In keeping with California's climate, lavish use of glass predominates. Bilateral lighting of classrooms has been emphasized with more extensive glass areas on north exposures. Porcelain treatment of facias has been utilized for permanency and beauty and to avoid expensive maintenance. Main entrance foyer in the new administration-classroom unit features quarry tile flooring with ceramic tile wall design depicting the master site plan of the campus.

The educational staff, headed by Dr. William H. Harless as Director, has completed a study of the future educational needs of the college. As a result of this study the Board of Trustees has inaugurated a progressive building program which, if not delayed by war shortages, calls for construction of a magnificent college library building, additional vocational shop units, vocational and avocational instruction units for women, a large auditorium and additional classroom buildings. In the El Camino program emphasis has been laid upon the building of a community college in the fullest sense. Classes are scheduled both day and evening to permit citizens served by the college to continue their education while employed in gainful occupations in industry. Laymen advisory

committees comprised of both labor and management executives have been formed to advise the college administrative staff as to the educational needs of the communities served by the college. This democratic spirit of cooperation has resulted in both a friendly atmosphere and a solid support by the citizens of their college. The institution offers not only two years of college work preparatory to university entrance at the third year level, but also a general curriculum leading to an Associate of Arts degree upon completion of the two year course. Emphasis has also been placed upon so-called "terminal courses" in vocational fields including apprentice carpenter courses, auto shop and auto, body and fender and welding, a complete course in cosmetology leading to completion of state license requirements, radio and other electronics courses, agriculture, animal husbandry and landscape architecture. Altogether over 250 courses of instruction are offered.

Enrollment estimates made in 1947 by the administrative staff headed by Founder-President Forrest G. Murdock called for a building program to house 5000 students. These sights have now been raised so that the building program as it continues will ultimately care for a student enrollment of 10,000.

As illustrated by the reproductions on these

### EXTERIOR VIEW OF ONE OF THE CLASSROOM BUILDINGS



View from interior of Administration and Classroom Building

Below—Is shown exterior of Shop Building



pages, El Camino College in California has truly grown from barracks to beauty in four short years.

\*\*A challenging opportunity was presented to the Board of Trustees, College staff, and the architects in the planning of El Camino College.

Seldom has a Junior College had an opportunity to grow from the soil, free from the inheritance of a cast-off high school plant with its inadequate site which forever paralyzes a college plan and

thwarts future growth.

El Camino College grew from a clear and level eighty acres, the extreme levelness and the adobe soil being the only obstacles the land presented. Proper surface drainage had to be developed to conquer the mud flats for there was but four feet of fall across the huge expanse. A foundation system of concrete piles had to be employed on all major buildings to protect the structures against



## EL CAMINO COLLEGE . . .

the five foot depth of adobe which heaves and swells during wet weather. A 12-inch to 18-inch layer of sand and top soil was imported to dress the grounds.

Architecturally, one of the most significant points of interest in the preparation of the plant was the stress given to first arriving at a sound and workable master plan which would inspire the conception of individual projects as money became available for their construction. The validity of the master plan has become more and more apparent during the four years of planning devoted to individual buildings.

Many times, ideas that have been projected on individual projects which were at cross purposes to the basic principals of the master plan have been rejected by the architects or the Board of Trustees because of respect and devotion to the master plan as an instrument of sound over-all planning.

The Board of Trustees has challenged our office, as architects, to produce buildings that will serve their expanding needs for years to come. The Board has thought in big terms and the rewards have been recognized already as the enrollment reaches for 5000.

The buildings are of Types I and II construction, using primarily reinforced concrete walls on the special purpose buildings with accents of Norman Ruffled brick masonry. The Classroom buildings have used light steel frames in conjunction with concrete and masonry walls. Materials have been chosen for ease of maintenance as well as beauty. Porcelain enamel fascias have been utilized on all buildings where light roof framing sections have been used in lieu of concrete. The porcelain enamel was selected because of its permanent finish and to guard against settlement cracks which might have occurred had a plastic material been used.

The first building to be designed was an increment of shops which included an auto shop, body and fender, welding, and wood shop. It was apparent that the ultimate program to be handled in vocational trades would require approximately 100,000 sq. ft. of space. In order to save ground space, this first unit of shop construction was designed to be an integral part of a future building which would comprise 2½ acres. An over-all pattern of north exposed saw-tooth skylights was used in order to light the interior shop areas. Major circulation arteries were master planned in conjunction with utility cores and rest room facilities so as to provide services for most any type of future development. The height of the building

is enough to allow the introduction of mezzanine classrooms or work areas anywhere within the building.

The Women's Gymnasium was designed to serve as a temporary facility for both men and women, permitting use as a spectator gymnasium or as an interim auditorium with stage. The Men's shower room can easily be converted to expansion for the women when the men's gymnasium has been completed. The stage area will be converted to a corrective room for the women, when an Auditorium is built. Lamella roof construction was used to give the maximum amount of head room on the playing floor with a minimum amount of volume in the building. Concrete cantilever side walls were used to take the trust of the lamella roof. This type of construction proved to be very economical.

The Campus Center building is unique in the methods employed for the serving of food. An advisory committee of professional restaurant management, wished the help of union counsel to better relate the course to the conditions pupils would meet in everyday life. The professional management advised that a variety of services be used to disburse the crowds of students and to appeal to the type of appetite and time schedule they might have. The main dining room for cafeteria service accommodates 500 people. In addition to this, a fountain and quick order grille serves approximately 40 at one time. This facility is operated 12 hours a day. There are also three types of hand-out services at different approaches to the building for serving of ice cream, soft drinks, hamburgers, etc.

The main dining room has a series of flexible sized individual rooms which can be opened completely to the main room, serving as dining expansion as well as conference and instruction spaces during the day. A student lounge is located in a slightly raised area at one end of the main dining room and also doubles as a platform for entertainment at dinners or as a band stand for student dances.

The newly completed administration and class room building is the only two-story structure on the site. The two-story design was adapted to add dignity and express the purpose of the building. The entire first floor is devoted to Administrative space where all but the basic areas have been kept as free and flexible as possible by use of metal demountable partitions. On the exterior of the building at the entrance, a pre-cast concrete motif is cast as an over-all wall pattern, a decora-

(See Page 35)



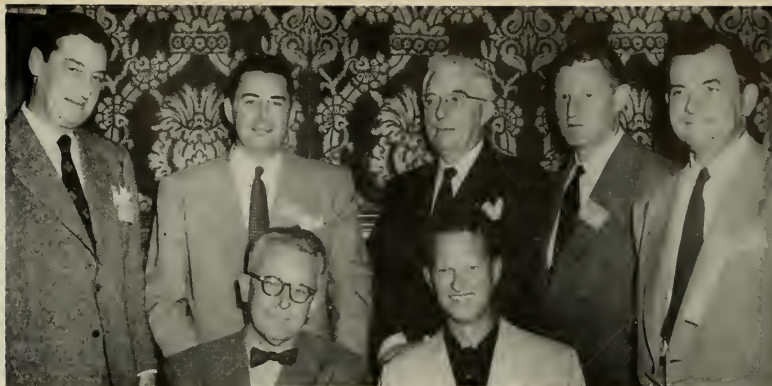

## CALIFORNIA COUNCIL OF ARCHITECTS

### Coronado Echoes

TOP—Architects F. J. (Joe) McCarthy, president Northern California Council; Kenneth W. Wischmeyer, 1st V-P, AIA; Maurice J. Sullivan, Treas., AIA; Edmund R. Purves, ex-Dir., AIA; and Jack R. Lewis, president, San Diego Chapter.

LEFT—Convention headquarters.



BOTTOM—Producers Council members (front, left to right): John Cowley, Braakman Co.; Robert D. Jones, Libbey Owens; Herbert Gallett, Westinghouse Elec.; Karl Drummond, H. H. Robertson Co.; Art Staaf, Nat. Gas Equipment; and Richard Seaman, W. F. Fuller Co. REAR (L to R): Unidentified; Robert M. Meublein, Armstrong Cork; Le Roy Frandsen, Detroit Steel; Harold Smith, Gladding, McBean; R. Eldon Sechler, Detroit Steel; Wm. Norton, Ceca Steel; and Paul Wagner, Armstrong Cork.

*Photos by Warren Hoyt, American Lumber & Treating Company, L. A.*





**STRUCTURAL ENGINEERS**—Back row, left to right: Arthur W. Anderson, Henry J. Degenkalb, Ernest C. Hillman, Jr., John E. Rinne, R. W. Binder and George Goodall, SEATED (left to right): Walter Buehler, vice-president; Donald F. Shugart, president; and Lewis K. Osborn, secretary-treasurer.

## ECHOES FROM YOSEMITE STRUCTURAL ENGINEERS ASSOCIATION MEETING

"The Best Convention Held To Date," would cover the feelings of virtually all attending the Convention at the Ahwahnee Hotel in Yosemite National Park; not only for the technical program, but also for the social festivities and general management.

Culmination was the Annual Banquet at which the 1951 president, Arthur W. Anderson of the Northern California Association, turned over the gavel to incoming President Donald F. Shugart of the Southern California Association, and as a part of this ceremony, the installation of other officers and directors took place.

In addition to the noted guest speakers State Director of Public Works and Mrs. Frank B. Durkee and State Architect and Mrs. Anson Boyd, were in attendance from Sacramento.

Business was carried on by President Anderson through various committees at three separate sessions set aside for this purpose. Technical programs took place on Thursday and Friday. The kick-off on technical programs came Thursday afternoon with an excellent discussion of wood diaphragms presented by George H. Anderson of the Oregon Forest Products Laboratory, speaking on diagonally sheathed diaphragms, and David Countryman of the Douglas Fir Plywood Association, speaking on plywood diaphragms. A session followed on Friday morning with John J. Gould, Consulting Engineer of San Francisco presenting observations on structural techniques being currently practiced in Europe. As part of this meeting Prof. J. W. Kelly of the University of California presented, in regard to concrete building construc-



### EXECUTIVES IN ACTION—

Conferring on the convention details are Walter Buehler, vice-president (left); Donald F. Shugart, president; Lewis K. Osborn, secretary-treasurer.

tion, the observations and suggestions of Prof. Raymond E. Davis, Director, Engineers' Materials Laboratory, University of California.

Technical sessions wound up Friday afternoon with a program designed to bring members of the Association up to the minute on latest advances and techniques in structural steel engineering. Prof. Bruce G. Johnston of the University of Michigan reported on the latest findings of the Column Research Council of the Engineering Foundation. This was followed by a discussion and demonstration on structural welding by Thomas H. Nicholl, Welding Engineer, Lincoln Electric Co. Elmer Gunnette, District Engineer, A.I.S.C., Seattle, Washington, followed with a report on the design and construction of the University of Washington stadium, highlighted by slides showing various stages of design and construction.

An added feature of the Convention was an excursion to the O'Shaughnessy Dam, part of the Hetch Hetchy project, on Saturday.

The social program included golf and tennis tournaments for the men; bridge, canasta, and pitch-and-put competitions for the ladies; travel and general interest movies, square dancing and ballroom dancing following the Annual Banquet.

#### NEWLY ELECTED PRESIDENT OF OREGON STRUCTURAL ENGINEERS

An the recent annual meeting of the Structural Engineers Association of Oregon, Roland S. Rose was installed as President of the organization for the ensuing year. He succeeds Evan Kennedy, who has served as President for the past year.



ROLAND S. ROSE  
President

Other officers elected and installed for the new year included Lewis Ellingwood, vice-president; R. M. Bonney, secretary-treasurer; and R. V. Gillam, R. L. Tidball and Sully Ross, Directors.

The new President, together with his business associate Miles K. Cooper, has furnished the structural design for many of the large buildings in the Northwest. Included in the list are the Equitable Building and the new Oregon State College, and the Erb Memorial Building at the University of Oregon at Eugene.

The Structural Engineers Association is composed of practicing structural engineers in the State of Oregon, even though all of the new officers are Portland men.

#### ENGINEERS ARE NEEDED FOR DEFENSE PRODUCTION PLAN

Glenn E. Brockway, Regional Director of the Defense Manpower Administration, emphasized recently that there is a shortage of engineers that is handicapping the national defense effort, particularly in the West.

The gravity of the situation is cited by Brockway as there are insufficient engineering students to meet the future requirements for highly and technically trained engineers. "In 1949 and 1950 the number of engineers graduated from our schools hit a peak of 50,000. But the U. S. Office of Education now predicts that by 1954 the number of engineers being graduated will have fallen to 17,000," Brockway declared.

Local Labor-Management committees have adopted a six point program in an effort to stimulate high school student interest in engineering.

#### ROBERT M. HAYNIE JOINS HAAS CONSTRUCTION CO.

Robert M. Haynie, well known in the construction industry, has become a general partner in the Haas Construction Company, according to a recent announcement by Edward Thompson Haas, head of the firm.

Offices of the Company are located at 391 Sutter Street in San Francisco.

### WILL OUTLAST YOUR BUILDINGS

NEW  
STANLEY  
"Full-  
Jeweled"  
ball bearing  
butt  
hinge

takes both lateral  
and vertical thrust

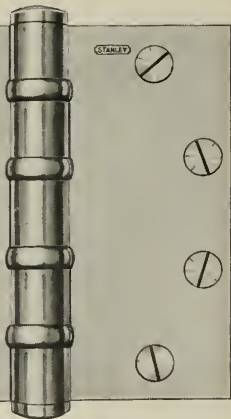

The Stanley Works  
New Britain, Connecticut

**STANLEY**

Reg. U. S. Pat. Off.

HARDWARE • TOOLS • ELECTRIC TOOLS  
STEEL STRAPPING • STEEL

# American Institute



# of Architects

Glenn Stanton, President  
Kenneth E. Wischmeyer, 1st Vice-president  
Norman J. Schlossman, 2nd Vice-president  
Clair W. Ditchy, Secretary  
Maurice J. Sullivan, Treasurer

#### Arizona Chapter:

Edward L. Varney, President; Ralph B. Haver, Secretary, P. O. Box 786, Phoenix, Arizona.  
Central Valley of California:  
William Kobilik, President; Gordon Stafford, Vice-President; John W. Bomberger, Secretary; Albert B. Thomas, Treasurer, Secretary's Offices P. O. Box 1943, Modesto.

#### Coast Valleys Chapter:

William F. Hempel, President; Lawrence Gentry, Vice-President; Walter Stromquist, Secretary-Treasurer. Secretary's office, 321 Channing Ave., Palo Alto.

#### Colorado Chapter:

Paul Aichison, President; James M. Hunter, Vice-President; Dudley T. Smith, Secretary; Victor Hornbein, Treasurer. Offices 1254 Monaco Parkway, Denver.

National Headquarters —  
1741 New York Avenue, N. W.  
Washington 6, D. C.  
Edmund R. Purves  
Executive Secretary

#### Northern California Chapter:

Francis J. McCarthy, President; Albert R. Williams, Vice-President; Wendell R. Spackman, Secretary; Helen D. French, Treasurer. Offices 369 Pine Street, San Francisco.  
Oregon Chapter:  
Herman Brockman, President; Donald J. Stewart, Vice-President; Raymond Kermit Thompson, Secretary; Millard H. Schmeier, Jr., Treasurer. Secretary's office 429 S. W. 4th Avenue, Portland.  
Pasadena Chapter (California):  
Culver Heaton, President; Don Neptune, Vice President; Arthur Frick, Treasurer; Mrs. Dorothy Gray, Secretary. Directors, John N. Douglas, Boyd George, Roland E. Coote and Burton Romberger. Office 1041 East Green St., Pasadena.

## A.I.A. PROPOSES PLAN TO DEPARTMENT OF DEFENSE

The A.I.A., through its national headquarters in Washington, D. C., has proposed a plan to the Department of Defense whereby possible bottlenecks in the huge \$5.8-billion military construction program will be eliminated.

Included in the proposals is a plan for spreading the design work to architects in non-defense areas and to smaller architectural firms. Unless such a program is carried out, it is predicted by

the A.I.A. that major delays and waste will result from failure of the Defense authorities to utilize professional resources to their fullest extent.

The military construction program is a diversified one of hospitals, schools, office buildings, laboratories, and many other building types in all parts of the United States, Alaska, Okinawa, and other overseas bases.

## ARIZONA CHAPTER A.I.A. MEETS IN PHOENIX

The Phoenix and Tucson sections, comprising the Arizona Chapter of The American Institute of Architects, held one of their two yearly meetings in Phoenix recently. The other annual meeting is usually held in Tucson.

In addition to a program of business and technical discussions relating to the practice of architecture, Ladies Night was held in the evening featuring a program of refreshments, entertainment and dancing.

## ARCHITECT EXHIBITS WORK AT LOS ANGELES ART GALLERY

Victor Gruen, Los Angeles architect, recently exhibited a number of photographs, renderings and models of his work at the Landau Gallery in Los Angeles.

He also gave an informal lecture on the subject of "Architecture" in connection with the exhibit.

## FRENCH BUILDING TEAM TO STUDY U. S. HOUSING

Twelve French government officials associated with public works programs arrived in Washington, D. C., recently for a series of conferences with private, Federal and governmental experts on community planning, housing and slum clearance.

Sponsored by the Economic Cooperation Administration's technical assistance program for

Remember it's

**KRAFTILE**

for GLAZED STRUCTURAL WALL UNITS  
PATIO TILE

SWIMMING POOL OVERFLOW  
GUTTER

QUARRY TILE  
FACE AND ROMAN BRICK

ACID BRICK  
BRICKETTES

MINWAX TILE & CONCRETE  
FLOOR FINISH

STRAN-STEEL FRAMING  
QUONSET BUILDINGS

IN STANDARD SIZES

For complete information and prompt service, phone or write

**KRAFTILE COMPANY**

NILES, CALIFORNIA NILES 3611  
SAN FRANCISCO 5: 30 Hawthorne St.—DOUGLAS 2-3780  
LOS ANGELES 13: 405 5th Main Street—MUTUAL 7241



**East Bay Chapter:**

Harry A. Bruno, President; Chester H. Treichel, Vice-President; Ira D. Beals, Secretary; Cecil S. Moyer, Treasurer. Secretary's office, 1444 Webster St., Oakland.

**Montana Chapter:**

E. Edward Sowcroft, President (Billings); J. Van Teylingen, Vice-President (Great Falls); H. C. Cheever, Secretary-Treasurer. Secretary office, Bozeman.

**Nevada Chapter:**

George L. F. O'Brien, President; Aloysius McDonald, Vice-President; Graham B. Baker, Secretary; Edward S. Parsons, Treasurer. Offices 160 Chestnut St., Reno.

**Nevada State Board of Architects:**

L. A. Ferris, President, Reno; Walter Zick, Secretary, Las Vegas; Directors, Aloysius MacDonald, Las Vegas; Russell Mills and Edward Carson, Reno. Office, P. O. Box 2107, Las Vegas, Nevada.

**Pasadena Chapter:**

Culver Heaton, President; Don Neptune, Vice-President; Arthur Frick, Treasurer; Mrs. Dorothy Gray, Secretary. Directors: John N. Douglas, Boyd Geesal, Roland E. Coate, and Burton Ramberger. Offices 1041 E. Green St., Pasadena 1.

**San Diego Chapter:**

Jack R. Lewis, President; Louis A. Dean, Vice-President; Donald Campbell, Secretary; Victor L. Wulff, Jr., Treasurer. Directors: C. J. Paderewski, G. C. Hatch. Secretary office, 1230 Prospect St., La Jolla.

**San Joaquin Chapter (California)**

Fred L. Swartz, President, Fresno; Lloyd J. Fletcher, Vice President, Visalia; Walter Wagner, Secretary, Fresno; Robert W. Stevens, Treasurer, Fresno. Directors: Alastair Simpson, William D. Coats, William F. Baxter, Maurice J. Metz, Delegate California Council of Architects. Office, Sac. Fulton-Fresno Bldg.

**Santa Barbara Chapter (California):**

Robert I. Hoyt, President; Harold E. Burket, Vice-President; Roy W. Chessman, Secretary; Lulah M. Riggs, Treasurer. Address, 242 San Marcos Bldg.

**Southern California Chapter:**

John J. Landon, President; Chas. Frey, Vice-President; C.

Dry Woodford, Secretary; Wm. G. Balch, Treasurer. Directors, Paul O. Davis, Henry Wright, John Rex, and Kemper Nomland. Ex. Sec. Rita E. Miller. Chapter Headquarters, 3723 Wilshire Blvd., Los Angeles 5.

**Spokane Chapter:**

Richard H. Eddy, President; Harry C. Weller, Vice-President; Kenneth D. Stormont, Vice-President 2; Victor L. Wulff, Secretary; and Carl Johnson, Treasurer. Office 1023 W. Riverside Ave., Spokane, Washington.

**Utah Chapter:**

Henry G. Cannon, President; William J. Monroe, Jr., Secretary, 3707 South 32nd West Street, Salt Lake City 7, Utah.

**Washington State Chapter:**

Fraul Thiry, President; John S. Delle, 1st Vice President; Walter H. Bathe, 2nd Vice President; Robert H. Dietz, Secretary; Lawrence G. Waldron, Treasurer. Office 714 American Building, Seattle 4.

**Yacoma Society:**

E. N. Dugan, President; P. G. Ball, Vice-President; Lyle Swedberg, Secretary-Treasurer.

**Hawaii Chapter:**

James C. Simms, President; Alfred Preis, Secretary, 1507 Kapiolani Blvd., Honolulu, T. H.

**CALIFORNIA COUNCIL OF ARCHITECTS**

John L. Rex, President; Wm. Kohlik, Vice-President; Maurice J. Metz, Secretary-Treasurer. Executive Secretary office 3723 Wilshire Blvd., Los Angeles.

**ALLIED ARCHITECTURAL ORGANIZATIONS****San Francisco Architectural Club:**

Alfred T. Kirkvold, President; Charles Dennis, Vice President; William C. Thiesman, Treasurer; Milton Bromberg, Secretary. Office 507 Howard Street.

**Producers' Council—Southern California Chapter:**

Harold F. Smith, President, Gladding, McBean & Co.; Bert Taylor, Vice-Pres., Pittsburgh Plate Glass Co.; Richard Seaman, Sec., W. P. Fuller Co.; Clay Smider, Treas., Minneapolis-Honeywell.

Producers' Council—Northern California Chapter (See Special Page)

Europe, the French group will meet with officials of the American Institute of Architects, the D. C. Redevelopment Land Agency, AFL and CIO, National Capital Park Planning Commission, Federal housing agencies and builders.

Their studies of American methods are part of a concerted drive by the French government and the country's building industry to alleviate a critical housing shortage. Statistics show that some 3,000,000 housing units are needed immediately, and that 240,000 units a year will be required for the next 40 years. Recent French construction has been at the rate of 67,000 dwelling units completed per year.

While in America the group will visit a number of large cities.

## ARCHITECT SPEAKS AT MEXICO'S CELEBRATION

Richard J. Neutra, Architect of Los Angeles, California, was one of the principal speakers at the recent General Congress of Science held in Mexico City in conjunction with the cuarto centennial celebration of the University of Mexico.

Neutra spoke on the subject "The Planetary Issue of Planning."

## SOUTHERN CALIFORNIA CHAPTER

J. J. Hollibaugh, representing the 52nd Assembly District, and chairman of the Los Angeles delegation of the California State Legislature, was the principal speaker at the October meeting, speaking on the subject "Architects and Legislators."

Hollibaugh has had considerable experience in

Sacramento and gave a thoroughly interesting and educational talk.

The Education Committee recently conducted a tour through the Pittsburgh Paint Factory at Torrance which was designed by Albert C. Martin and Associates.

## SAN DIEGO CHAPTER

The October meeting was devoted to a "review" of the Annual Convention of the California Council at Coronado and clearing up a number of loose ends resulting from the San Diego Chapter acting as "hosts."

Plans were laid to continue a number of activities through the year which were inaugurated with the Convention.

President Lewis called attention to the 8th International Architects Convention which has been scheduled for Mexico City in October of 1952, and while the conference is some time in the future a number of San Diego architects have already indicated their intention to attend and represent the San Diego Chapter.

## NORTHERN CALIFORNIA CHAPTER

A number of members took an active part in the 5th Annual San Francisco Art Festival exhibition in the Palace of Fine Arts Building, and the exhibits of architectural drawings, designs and renderings stimulated considerable interest among the large number of persons attending the Show.

More than thirty members were represented in the showing.

# WITH THE ENGINEERS

Structural Engineers Association of California  
 Donald F. Shugart, President; Walter A. Buehler, Vice-President; Lewis K. Osborn, Sec.-Treas.; Office c/o Kistner, Curtis & Wright, Room 203 Architects Bldg., Los Angeles. Directors Arthur W. Anderson, John E. Rinne, Henry J. Degenkolb, Lewis K. Osborn, Ernest C. Hillman, Jr., R. W. Binder, Donald F. Shugart, Walter A. Buehler, and G. E. Goodall.

Structural Engineers Association of Northern California

John E. Rinne, President; John J. Gould, Vice-President; Wm. W. Brewer, Sec.; Franklin P. Ulrich, Treas.; Directors, Walter L. Dickey, Leslie W. Graham, Hyman Rosenthal, and Howard A. Schirmer.

Structural Engineers Association of Central California

William H. Petersen, President; Walter S. Wassum, Vice President; O. T. Illerich, Sec. Treas.; Ernest D. Francis, M. A. Ewing, and Arthur A. Sauer, directors. Office O. T. Illerich, c/o Div. of Arch., Sacramento.

American Society of C. E.

San Francisco Section

Clement T. Wiskocil, President; John S. Longwell, Vice-president; I. G. Wright, Vice-president; H. C. Medbery, Treasurer; R. D. Dewell, Secretary. Secretary's Office, 604 Mission St., San Francisco.

Structural Engineers Association of

Southern California

Donald F. Shugart, President; Harold P. King, Vice President; Robert J. Shart, sec-Treas.; Directors, William T. Wheeler, William T. Wright, Ernest C. Hillman,

Jr., John Case, and John K. Minasian. Office, 202 Architects Bldg., Los Angeles 13.

Structural Engineers Association of Oregon

R. Evan Kennedy, President; Guy H. Taylor, Vice President; James R. Griffith, Secretary-Treasurer; Directors Jerome A. McDevitt, H. Loren Thompson, and Robert L. Tidball. Offices, Portland.

Puget Sound Engineering Council (Washington)

R. E. Kister, A. I. E. E., Chairman; E. R. McMillan, A. S. C. E., Vice Chairman; L. B. Cooper, A. S. M. E., Secretary; A. E. Nickerson, I. E. S., Treasurer. Offices, L. B. Cooper, c/o University of Washington, Seattle 5, Washington.

American Society Testing Materials Northern California District

L. A. O'Leary, Chairman; P. V. Garin, Vice-chairman; H. P. Hoopes, Sec. Office Sec. 1550 Powell St., Emeryville, Calif.

Society of American Military

Engineers—San Francisco Post

Capt. Cushing Phillips, CEC, USN, President; Col. W. C. Baker, Jr., CE, USA, Vice President; Robert P. Cook, Secretary; Levant Brown, Treasurer. Directors: Rear Admiral L. N. Moeller, CEC, USN; Capt. H. F. Ramsford, CEC, USN; Clyde Bently; Prof. Harmer E. Davis, Lieut. Col. James D. Strong, CE, USA; and Lieut. Col. Henry M. Smalley, CE, USA.

## RECOGNITION FOR MOST BEAUTIFUL BRIDGES

The American Institute of Steel Construction has awarded stainless steel plaques for three bridges selected as the most beautiful steel bridges opened

to traffic in the United States during 1950.

Awards were made by a jury of architects and engineers from a field of ninety-seven entries, representing twice as many entries as were considered the previous year.

The State of Washington, Department of Highways, George Stevens, Bridge Engineer, designer was awarded first place in Class I, which comprises bridges with spans of 400 feet or more. The bridge receiving the award was the Columbia River Bridge at Wenatchee, Washington.

In Class II, for bridges with spans under 400 feet, costing over \$500,000, first place went to the South Holston River Bridge on the Tennessee State Highway 34 in Sullivan County, owned by the State of Tennessee and designed by the Tennessee Valley Authority.

Class III winner was the Caldwell Avenue Bridge over the Edens Expressway in Cook County, Illinois, designed by the Cook County Highway Department, J. Edwin Quinn, architect. This class was for bridges under 400 feet costing less than \$500,000.

The jury making the selection this year included Glen Stanton, President, The American Institute of Architects, Portland, Oregon; Prof. Carlton T. Bishop, School of Engineering, Yale University, New Haven, Conn.; Rene d'Hannoncourt, Museum

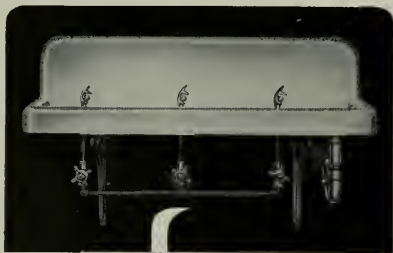

Always specify

# HAWS

for Highest Quality

Sanitary Drinking Fountains

Electric Water Coolers

Drinking Faucets, Equipment, Filters and Accessories

• A reputation for reliability since 1909. Check in Sweets or write for HAWS catalog.

**HAWS DRINKING FAUCET CO.**

1441 FOURTH STREET (Since 1909) BERKELEY 10, CALIFORNIA  
 Agents and Sales Representatives in All Principal Cities

of Modern Art, New York City; Albert Kruse, Architect, Wilmington, Del.; and Alfred Shaw, Architect, Chicago, Ill.

#### U. C. ENGINEER AIDS MEXICAN UNIVERSITY

Prof. Harold B. Gotaas, University of California at Berkeley sanitary engineer, has been called as an advisor to the University of Mexico, where he is assisting in the development of an engineering education program.

#### SOCIETY OF AMERICAN MILITARY ENGINEERS, SAN FRANCISCO POST

Col. Merlin I. Carter, Commanding Officer of Parks Air Force Base which is now under construction near Pleasanton (California) was the principal speaker at the November meeting held in the Presidio Officers Club, Presidio of San Francisco.

His subject was "The Mission of Parks Air Force Base" and because of his long and distinguished career in the U. S. Army and the U. S. Air Force, Col. Carter gave an extremely interesting picture of the Parks project.

Col. Carter began his flying training at March Field, California, following graduation from the University of Iowa, and completed his Advance School in flying at Kelly Field, Texas, in June, 1929. Since that time Col. Carter has had a varied Army and Air Force experience both in this country and abroad.

#### CALIFORNIA SEEKING MECHANICAL ENGINEERS

The State Personnel Board of the State of California is seeking mechanical engineers and will give examinations to applicants in two divisions during December.

The positions require three and five years of professional mechanical engineering experience, two years of which shall have been in design and inspection work.

Vacancies are in Los Angeles, Sacramento, and San Francisco, chiefly with the State Division of Architecture.

#### NAMED CHAIRMAN COASTAL ENGINEERING CONFERENCE

Dean A. McGee, executive vice president of the Kerr-McGee Oil Industries of Oklahoma City, has been named Chairman of the Second Annual National Conference on Coastal Engineering to be held in Houston, Texas, November 7-10.

Speakers at the conference include Attorney General Price Daniel of Texas; S. J. Buchanan of Texas A. & M.; J. W. Johnson, University of Cali-

fornia; Col. E. E. Gesler of the Beach Erosion Board, Washington, D. C.; R. O. Reid, Texas A. & M.; F. Escoffier, Mobile District, Corps of Engineers; W. A. Mussen, Southwest Research Institute, San Antonio, Texas; W. A. Price, Texas A. & M.; and A. L. Glenn of A. L. Glenn & Associates, New Orleans Municipal Airport.

#### ASTM GROUPS TO MEET ON PACIFIC COAST

Two meetings of the American Society for Testing Materials, national organization with general headquarters in Philadelphia, have been scheduled for the Pacific Coast this fall.

The first meeting, representing the Northern California District, was held in San Francisco, October 31, with the discussions devoted to the subject of "Corrosion Testing and Engineering."

The second meeting, representing the southern California District, will be held in Los Angeles on November 8, with a discussion of "Corrosion Testing and Engineering" and will represent a joint conference of several southern California groups.

#### SOUND CONTROL PROJECT AT WASHINGTON STATE COLLEGE

One of the largest sound control projects of its kind ever undertaken in the northwest, is being

(See Page 32)



Always  
Specify  
**HAW'S**  
for Highest  
Quality

A complete line of coolers, fountains, faucets, equipment, filters and accessories. A reputation for reliability since 1909. Check in Sweet's or write for complete HAW'S catalog.

#### HAW'S DRINKING FAUCET CO.

1441 FOURTH STREET (Since 1909) BERKELEY 10, CALIFORNIA  
Agents and Sales Representatives in All Principal Cities

# PRODUCER'S COUNCIL PAGE

The National Organization of Manufacturers of Quality Building Materials and Equipment  
affiliated with THE AMERICAN INSTITUTE OF ARCHITECTS

President, Arthur C. Staat  
Natural Gas Equipment, Inc.  
1150 Folsom Street

Vice-President, Fred A. Flogone  
Otis Elevator Company  
1 Beach Street

Secretary, Howard Noleen  
E. F. Hauserman Company  
500 Second Street

Treasurer, A. L. West, Jr.  
Aluminum Company of America  
Russ Bldg.

Edited by Carl B. Frank, DETROIT STEEL PRODUCTS CO.

## ANNUAL CHRISTMAS JINX

We would like to take this opportunity to remind all of you LUCKY architects and engineers that you should reserve the night of November 30th for attending the Producer's Council Annual Christmas Jinx. The Jinx will be held once again at the Claremont Hotel with cocktails served at 6:00 p.m.

We refer to you as "LUCKY" people due to the fact that you will have the opportunity to witness one of the finest dramas to hit the Pacific Coast this year. This is a play written by Bill Corlett—A.I.A., Nick Zavalishin, Jr. of W. P. Fuller Company, and Howard Noleen of the E. F. Hauserman Company. Title of the play is "BELIS A' POPPIN". This marvelous play is by, for and about the gentlemen of the building industry including both architects and engineers, and, of course, salesmen. There will be some 20 salesmen (Producers ?) and architects in the cast. If any of the characters portrayed in this drama show any resemblance to any persons living or dead, it is purely intentional.

## THE PRESIDENTS MEETING

The following is a quotation from Art Staat's recent visit to the Chapter Presidents meeting held in Washington, D. C.:

"Three days in Washington at the Producers' Council Annual Meeting and Chapter Presidents Conference furnished enough material to talk about for three months. E. Naughton Lane, because of the excellent work done this past year as President of the National Chapter, was unanimously re-elected and thus accredited to continue the program he has conceived and put into movement. His Board of Directors approved Council by-laws whereby membership dues are revised to make the financial burden of Council operation more equitable to National and Regional members. The by-laws were changed to make Associate Memberships in the Council available to many worthy organizations heretofore unable to qualify. Part of the conference was devoted to stirring up the Na-

tional Membership to a greater activity in Council affairs, particularly toward greater Chapter level participation thru instruction to local member offices in Chapter cities.

President Lane removed a great deal of mystery regarding the purpose of the Council by his forthright address entitled "The Council's Basic Objective". He said, "The real purpose of the Council is to help members sell more of the materials and equipment which they produce. The Chapters at regular intervals conduct informational and other programs which appeal to and attract Architects, Engineers, Builders, Contractors, Building Owners and Managers, . . . the very people who happen to be our best customers. Since there is no other over-all national organization of building product manufacturers offering information services of this kind, and since the service is genuinely appreciated by those who make up the audiences, the Council has come to be recognized as a thoroughly dependable, well intentioned organization, dedicated to the job of trying to help its customers."

Mr. Lane graphically outlined three major aims he intends to pursue in his second year in office. "First, we can find some way to join with the rest of the construction industry to resume our efforts to sell the public on the fact that the industry is doing an excellent job of serving the public interest. . . . If we in the industry don't tell that story, no one will and, if no one does tell it, we face trouble in the future because there are too many people shooting at us at every opportunity. Secondly, there is no over-all organization of building products manufacturers speaking on matters of over-all policy, the Council should get itself in position to assume that role. I don't mean political activity. I do mean advising the public, the rest of the industry, and administrative agencies of the government, on matters affecting the welfare of the industry. When we sit back and say nothing,

(See Opposite Page)

USE QUALITY PRODUCTS



CONSULT AN ARCHITECT



defense officials can't help get the impression we aren't much concerned over the situation. Finally, we need to place funds and staff assistance at the disposal of the Chairman of our Joint Committees to develop facts and figures "so necessary to the presentation of the Building Industry's cause.

As the convention developed, Mr. Lane's first and second aims were filled when a panel discussion "How Can Manufacturers Serve Construction Industry Most Effectively" brought James P. Edmunds, Jr., FAIA; Norman Mason, National Retail Lumber Dealers Association; W. P. Atkinson, National Association of Home Builders, and H. C. Turner, Jr., Associated General Contractors, together on the platform. Each in turn told Mr. Lane, the Moderator, some of the particular problems confronting his respective segment of the Industry, and each in turn expressed confidence that through the Joint Informational Committees, set up with Producers' Council for each organization, a way has at last been made to consolidate ideas, opinions, and action for the benefit of all. The enthusiasm of these four leaders promises much for carrying out a long range program of solidifying our industry into a coordinated unit rather than a disjointed group of individualists.

The Chapter Presidents Conference was in progress all through the Annual Meeting. Besides witnessing the National Chapter and officers at work, hearing the worthwhile addresses and panel discussions, the Presidents compared notes, discussed phases of Chapter operation, and received instruction for future activities. Quite naturally "shop talk" has little news value, so aside from a feeling that future activities of the San Francisco Chapter will be better than ever because of the many new ideas assimilated in Washington, there is little to tell about the Presidents activities.

A keynote thought remains above all others, we of Producers' Council want you, our industry affiliates, to tell us how Manufacturers can serve the Construction Industry most effectively."

### **BUILDING INDEX RISES FIVE POINTS RECENTLY**

A rise of five points during the third quarter to a new high of 536 has been reported by the American Appraisal Company in the construction cost index.

Increased labor wages accounted for four points while increased freight rates represented one point.

The index is based upon a detailed analysis of materials and labor required for representative types of industrial building structure repriced monthly in accordance with prevailing wage scales and labor performance for the various

building trades, and quotations for construction materials in 30 key cities in the United States.

The index assumes normal average conditions and does not recognize overtime or premiums paid for materials in individual cases or under abnormal conditions.

## **LOS ANGELES BUILDERS EXCHANGE**

(From Page 11)

Decorating Contractors Association; Horace Allison, Heating, Piping and Air Conditioning Association; I. E. Brown, Associated General Contractors; William Colhoun, Roofing and Plastering Association; Warren Penn, National Electrical Contractors Association Clifford Monk, Painting and Decorating Council of Los Angeles; Robert Richardson, secretary of the Painting Contractors Association; J. W. Millerburg, Building Contractors Association of California and Carl F. Krantz, executive manager of the Construction Industries Home Show and Exposition of Los Angeles.



**HOLLYWOOD JUNIOR  
COMBINATION  
SCREEN and METAL SASH DOOR  
★  
The "WEATHER-WISE"  
DOOR!!**

**A VENTILATING SCREEN DOOR  
A SASH DOOR  
A PERMANENT OUTSIDE DOOR  
ALL 3 IN 1!**

Discriminating home owners and architects have chosen Hollywood Junior as the TRIPLE DOOR VALUE in the COMBINATION SCREEN and METAL SASH DOOR Field! A sturdy dependable door, constructed of quality materials, HOLLYWOOD JUNIOR'S EXCLUSIVE PATENTED FEATURES have outmoded old-fashioned screen doors and other doors of its type entirely!

**IT GUARANTEES YOU YEAR 'ROUND  
COMFORT, CONVENIENCE and ECONOMY**

WE ALSO MANUFACTURE A COMPLETE LINE OF  
SHUTTERS, C. C. DOORS, SCREENS, SCREEN DOORS, LOUVRE DOORS

**WEST COAST SCREEN CO.**  
1145 EAST 23rd STREET LOS ANGELES, CALIFORNIA  
ADAMS 11138

★ WRITE FOR FREE ILLUSTRATED LITERATURE ★



# Gift Subscription For Christmas 1952

AS a service to its readers GIFT SUBSCRIPTIONS to ARCHITECT & ENGINEER magazine are available for this year's Christmas giving.

REGULAR SUBSCRIPTION Rate will apply:

United States and Pan America

\$3.00 a year; two years \$5.00

Foreign Countries \$5.00 a year

PLEASE SEND ARCHITECT & ENGINEER  
AS A GIFT To:

name..... occupation.....

address..... city..... zone..... state.....

Sign my gift card: From.....

name..... occupation.....

address..... city..... zone..... state.....

Sign my gift card: From.....

name..... occupation.....

address..... city..... zone..... state.....

Sign my gift card: From.....

Your Name.....

address..... city..... zone..... state.....

Enclosed is my check for.....

## WITH THE ENGINEERS

(From Page 29)

completed at Washington State College in Pullman, where the latest developments in noise abatement have been utilized in reconversion of Bohler Gymnasium.

More than thirty-five thousand feet of acoustical tile have been employed in the reconstruction, and H. H. Ewing, superintendent of construction for Noise Control of Spokane, Inc., calls it "one of the biggest jobs of its kind in noise control in one room that the Northwest has ever known."

It is reported that a former nine second reverberation in the empty gymnasium has been cut to two and a half seconds. While the work was still going on workmen would be addressed thirty feet without raising the voice.

The ceiling of Bohler Gymnasium was lowered thirty feet in order to accomplish better lighting and acoustical facilities, and seventy-four new speakers are used in the public address system. It is expected this change will triple the effectiveness of the gymnasium.

### ELECTRICAL MAINTENANCE ENGINEERS OF SOUTHERN CALIFORNIA MEET

Industrial leaders from all parts of southern California were given an insight into the problems of their plant maintenance men recently when the Electrical Maintenance Engineers Association of Southern California held a "bosses' night" in Los Angeles.

More than 200 employers and members exchanged ideas and heard an address by Wm. O. Kyte of the General Electric Company on the subject "How Our Business System Operates."

### YOUNG ARCHITECT CARRIES ON FAMILY TRADITIONS

"Architects all," that is the case of the Clarence Cullimore, junior and senior, of Bakersfield, California.



CLARENCE CULLIMORE, JR.  
Architect

The younger Cullimore, Clarence, Jr., is receiving congratulations on his being certified by the State of California to practice architecture together with a number of young men who have successfully passed the state examinations given by the State of California to practice architecture together with a number of other young men who have successfully passed the state examinations given by the State Board of Architectural Examiners.

Clarence, Jr., was graduated from the College of Architecture at the University of Southern California in 1949 and now resides with his wife and their son, Clarence III, in the City of San Mateo, although he is presently employed in one of the long established architectural offices in San Francisco.

Clarence Cullimore, Sr., a Fellow of The American Institute of Architecture, and a well known architect throughout the West, resides in Bakersfield, California, where he maintains offices for the practice of Architecture.

#### ELECTED NEW OFFICER AMERICAN SOCIETY FOR TESTING MATERIALS

Dr. Harold L. Maxwell, supervisor of General Consultants, E. I. du Pont de Nemours & Company, has been elected a Vice-President of the American Society for Testing Materials by the Board of Directors, to fill a vacancy that existed in the Board.

#### PRODUCERS' COUNCIL RE-ELECTS A. LAUGHTON LANE PRESIDENT

A. Laughton Lane, vice president of the Monarch Metal Weatherstrip Corporation, was re-elected president of the Producers' Council, Inc., at the annual meeting of the organization recently held in Washington, D. C.



A. LAUGHTON LANE  
Producers' Council President

Among the speakers taking part in the meetings were W. P. Atkinson, president of the National Association of Home Builders; James Edmunds, Jr., Fellow of The American Institute of Architects; H. C. Turner, Jr., president of the Turner Construction Company and Director of the Associated General Contractors of America; and Norman Mason, past president of the National Retail Lumber Dealers of America.

The Producers' Council, Inc., is the national organization of leading building material manufacturers and is officially affiliated with The American Institute of Architects.

#### EASTERN FIRM TO DESIGN THE DALLES BRIDGE PLAZA

The New York engineering firm of Teller & Cooper, Inc., has been engaged by the Tudor Engineering Company of San Francisco, designers of the new \$2,500,000 steel cantilever bridge now being constructed across the Columbia River near The Dalles, Oregon, to design and build the toll plaza facilities.



# A Combined

**Landscape Architecture  
and Contracting Service**

for

**Tract, Industrial and Residential  
Development**

**We can do the Complete Job for you**

- Landscape Architecture
- Finish Grading and Landscaping
- Asphalt Drives and Parking Lots

## HENRY C. SOTO CORPORATION

*Landscape Contractors*

13000 SO. AVALON BLVD. LOS ANGELES 61, CALIF.  
Phone MElo 4-6617

### Notes on Quality LIGHTING:

Here in the West the installation assuring maximum lighting efficiency with minimum service and maintenance is, by every standard of comparison, SMOOT-HOLMAN. The hallmark of quality in better buildings is the presence of SMOOT-HOLMAN equipment.



The New D-P Seal-Lux, pictured above, is a vapor-light fluorescent luminaire built for high efficiency and rugged service life under the most exacting conditions.



- 1 Constellation Slimline fluorescent
- 2 D-P Line-Light
- 3 Collegiate Slimline fluorescent
- 4 Educator incandescent
- 5 Rite Standard Dome Reflector
- 6 The Master Floodlight
- 7 Hit Ceiling Light



SMOOT-HOLMAN COMPANY Incorporated, Calif. Offices in Principal Western Cities - Branch and Warehouse in San Francisco





Specify Utility equipment!—The one sure way to avoid the headaches of an installation that just doesn't measure up to your specifications. You're sure with Utility because it sets the industry standard for quality and performance.

#### UTILITY EVAPORATIVE AIR COOLERS AND VENTILATING EQUIPMENT FOR EVERY PURPOSE

Utility's air delivery tables are complete and authentic, derived from tests made in accordance with A.S.H.V.E. test codes. Every Utility cooler is tested in accordance with these same codes. You can meet every requirement with Utility for the line includes evaporative fan coolers, duct coolers, rotary spray washer type coolers, and blowers.



#### A FULL RANGE OF UTILITY HEATING EQUIPMENT

**Floor Furnaces**—45,000 BTU/Hr. input, flat and dual; also, 60,000 BTU/Hr. input, flat and dual (both sizes, shallow-type construction). **Wall Heaters**—Single—27,500 BTU/Hr. input; Dual—35,000 BTU/Hr. input and 50,000 BTU/Hr. input. **Forced Air Furnaces**—70,000 BTU/Hr. input to 150,000 BTU/Hr. input. **Unit Heaters**—65,000 BTU/Hr. input to 225,000 BTU/Hr. input. All Utility Heating Equipment is tested and approved by A.G.A.

#### SEND FOR AIA ENGINEERING INFORMATION

For this complete technical data on Utility equipment, plus valuable tables, charts, installation details, write (on your letterhead) to Engineering Dept. Counsel from a Utility Engineer available without charge.

UTILITY APPLIANCE CORP.  
4851 S. Alameda Street, Los Angeles 58, California



EVAPORATIVE AIR COOLERS      GAS-FIRED FURNACES  
VENTILATING EQUIPMENT

Manufacturers of Gaffers & Sattler and Occidental Gas Ranges

An unusual toll plaza will be used which will also include offices for the bridge administration. Toll registration precision mechanism will operate in two traffic lanes, with registration treadles, counters, remote recorders, overhead illuminated toll indicators, and toll receipt printers.

The main span of the bridge is 1,088 ft. with 22 approach spans, and a minimum clearance above low water of 75 ft.

#### CHARLES W. LANGE NAMED TECHNICAL CONSULTANT

Charles W. Lange, formerly associated with the U. S. Engineers offices in San Francisco as specification writer, has been appointed technical consultant, draftsman and field representative for the Woodwork Institute of California, according to a recent announcement by Larry Woodson, president of the Institute.



CHARLES W. LANGE  
"Tech-Archonomist"

A graduate Architectural Engineer of Carnegie Institute of Technology, Lange has had a wide experience in the practice of architecture in the East and in California, as well as engaging for a time in general contracting in the construction of speculative homes.

The addition of Lange to the Woodwork Institute of California staff is the direct result of a comprehensive survey of architects and contractors by the Institute to determine the type of assistance in standards of workmanship, materials, and specifications that the Institute might offer, and points out Russell Bjorn, managing director of the Institute, "Lange will be available for mutual assistance to the millwork people and to members of our organization."

Lange is a member of the Society of Military Engineers, Commonwealth Club of California, and the World Affairs Council of Northern California.

#### SOUTHWEST RESEARCH INSTITUTE EXPANDS PHYSICS DEPARTMENT

Increased demand for research in the fields of physics, electronics and instrumentation has caused the Southwest Research Institute of San Antonio, Texas, to expand its Physics Department, according to Dr. Paul Erlandson.

Recent staff additions include Robert W. Annis, senior research physicist, from Champaign, Ill.; James C. Axtell, research physicist from Texas City; Bascom F. Batts, research engineer with post graduate studies at Harvard University and the



Massachusetts Institute of Technology; William W. Bradshaw, research physicist, University of Texas; Graydon E. Buss, instrument technician; William C. Coombs, supervisor of Measurements Laboratory; Dr. Charles A. Culver, senior physicist; Malon H. Dickerson, chemical physicist; George A. Ferguson, electrical technician; Felix N. Kusenberger, electronics engineer; John P. O'Mears, research physicist; Richard E. Pabst, electrical engineer; and M. John Prucha, Jr., electronics engineer.

**ATTENDS CONFERENCE ON AGED CALLED BY GOVERNOR WARREN**

Architect John Lindsay of the firm of Palmer, Krisel & Lindsay, Los Angeles, was chosen by Governor Earl Warren of California recently to serve as a member of a Governor's Conference to determine the needs of the aged.

The conference was held in Sacramento.

**EL CAMINO COLLEGE**

(From Page 22)

tive symbol which is being used on other buildings in the same manner and as a theme for tile patterns at drinking fountain panels and in other various ways. Just outside the central lobby space in the interior court is a decorative pool which is a focal accent terminating the main east-west campus walk which extend to the football stadium.

The stadium and athletic facilities in conjunction therewith are very complete. The stadium is an earthfill, with concrete risers for an ultimate capacity of 20,000. It is especially good as a spectator stadium inasmuch as the track facilities are on the outside, thus enabling the seats to be much closer to the playing field. The back side of the earth compaction has 3000 seats for track events and the stadium Press Box works both ways, either for the track and field events or for football. The stadium lighting system is a high intensity system adequate for the games that are being televised this season. A field house was constructed at the north end of the stadium as a shower and locker room for the major sports and for visiting teams and officials. The building and its fence controls were so designed that one-half of the building may be used during summers as a public recreation center without permitting access to the stadium or to the other parts of the field house building.

A new Life-Sciences Building is now under construction and the plans have been completed for a Library Building. The Library, located in almost the exact center of the Campus, has developed as the hub of the design from which the two major axes have been resolved.

**Parker, Steffens & Pearce**

**BUILDERS**

**135 South Park, San Francisco**

**Phone: EXbrook 2-6639**

**BARRETT & HILP**

**CONTRACTORS**

*Builders of the West*

918 Harrison Street • San Francisco  
Telephone DOuglas 2-0700

234 West 37th Place • Los Angeles  
Telephone ADams 3-8161



Quality Products Since 1895  
**ANGIER PACIFIC CORPORATION**  
15 NEW MONTGOMERY ST. 7434 SUNSET BOULEVARD  
SAN FRANCISCO 9, CALIF. LOS ANGELES 44, CALIF.  
A complete line of Angier products available from your building material dealer

**STOP**

**Penetration Of  
MOISTURE  
WIND  
DUST  
VERMIN**

**EVERLASTING  
PROTECTION**

**FORDERER CORNICE WORKS**

*Manufacturers of*

Hollow Metal Products • Interior Metal Trim  
Elevator Fronts and Cabs  
Metal Plaster Accessories • Sanitary Metal Base  
Flat and Roll Metal Screens  
Metal Cabinets • Commercial Refrigerators

**269 POTRERO AVE.**

**SAN FRANCISCO, CALIF.**

**HEMLOCK 1-4100**

# HOGAN LUMBER CO.

Wholesale and Retail

## LUMBER

MILL WORK • SASH & DOORS

Office, Mill, Yard and Docks

SECOND AND ALICE STREETS • OAKLAND, CALIF.

Telephone GLencourt 1-6861



**PROTECTIVE BUILDING PAPER... WATERPROOF, REINFORCED... USED AS SHEATHING PAPER, PROVIDES LIFE-LONG PROTECTION FROM ENTRY OF WIND, DUST AND MOISTURE. IDEAL FOR STUCCO-BACK, OVER SUBFILL, CONCRETE CURING, UNDER FLOORING, etc. Write for samples and complete data.**

**The SISALKRAFT CO.**

55 New Montgomery St. San Francisco 5, California

# JUDSON PACIFIC-MURPHY CORP.

Steel Fabricators  
and  
Erectors

REINFORCING STEEL  
STRUCTURAL STEEL  
BRIDGE CRANES

4300 EASTSHORE HWY.  
EMERYVILLE, CALIF.

Phone:  
OL 3-1717

# CLINTON CONSTRUCTION CO. OF CALIFORNIA

General Contractors

923 FOLSOM STREET • SAN FRANCISCO

SUffer 1-3440

## BOOK REVIEWS PAMPHLETS AND CATALOGUES

**ACI (American Concrete Institute) STANDARDS 1951.** American Concrete Institute, Detroit, Michigan. Price \$3.00.

ACI Standards 1951 is a compilation of all current American Concrete Institute Standards except the Detailing Manual, and contains the newly revised "Building Code" and "Specifications for Concrete Pavements and Bases" and a new standard on pneumatically-placed mortar.

Contains authoritative and useful information on application of portland cement paint, winter concreting methods, requirements for precast floor units, form silos, design of concrete mixes, specifications for cast stone, metal supports for reinforcements, and measuring, mixing and placing concrete.

A handy reference for the architect, engineer, and concrete technician.

**SHOPPING CENTERS—Design and Operation.** By Geoffrey Baker and Bruno Funaro. Reinhold Publishing Corp., New York City. Price \$12.00.

Sixty-three neighborhood, community, and regional shopping centers are minutely described and illustrated in the largest single section of this book from the Progressive Architecture Library. The all important subject of parking has been analyzed and in addition a section has been devoted to the subject of market analysis.

The book contains more than 470 illustrations.

Subject matter covers information on site, pedestrian circulation, freight handling, reflections on glass, lighting, signs, and every other problem involved in the design and operation of a successful center. An ideal book for architects, engineers, designers, and city planners.

**ARCHITECTURAL STANDARDS—Fourth Edition.** By Charles George Ramsey, A.I.A., and Harold Reeve Sleeper, F.A.I.A. John Wiley & Sons, Inc., New York. Price \$10.00.

The Fourth Edition demonstrates why Architectural Graphic Standards is frequently referred to as "The Architect's Bible." It contains 368 entirely new plates and a revision of many of the old ones; it is 80% larger than the previous edition, and the Index has been expanded to cover over 11,000 references.

The book is designed to give architects, builders, draftsmen, civil engineers, and others interested in building, the standard facts, and data they need to deal with every type and every phase of building. The material is arranged in sequence of building, including materials, fixtures, fittings, devices, equipment, appliances, accessories, utensils, furnishings, apparatus, machinery, supplies and structural material.

## NEW CATALOGUES AVAILABLE

Any of the catalogues or folders described here may be obtained by forwarding your request as indicated in the coupon below to the office of the ARCHITECT & ENGINEER. Merely mark the items you want and clip or paste the coupon to your letterhead.

### 322. AIR CONDITIONING EQUIPMENT

Westinghouse Sturtevant has just published a 16-page, condensed full-line catalog describing air conditioning, air handling, and air cleaning equipment in considerable detail. The catalog is divided into three major sections: 1) air conditioning equipment, 2) air handling apparatus, and 3) electronic air cleaning equipment. 11/51.

### 323. PAINT-ANCHORING PHOSPHATE TREATMENT FOR METALS

A new 8-page booklet describing Anchorite 100, a paint-anchoring corrosion-resistant phosphate treatment for metals, has been released by Octagon Process, Inc. Attractively printed in two colors, the booklet describes in detail the common causes of paint failure and how they can be prevented. It also gives methods of application, immersion and spraying, of the treatment. The catalog is well illustrated and points out the method is one of the few pre-painting treatments meeting specifications for Class C (Type II) finish in U. S. Army Specifications No. 57-02C, as well as JAN-C-490, Grade 1. 11/51.

### 324. EXPANDED SHALE AGGREGATES

A new brochure entitled "Featherlite Facts" has been issued by the Featherlite Corporation outlining in technical detail uses of expanded shale aggregates in Monolithic construction.

Emphasis is placed on use of the material in construction of the Republic National Bank Building in Dallas, Texas, and photographs and charts show workability, mixing, wearing surface, fire resistant, permanency, and uniformity. Brochure also illustrates commercial, industrial and residential examples of expanded shale aggregate uses. 11/51.

### 325. HAND TRUCKS DESCRIBED

A twelve page Condensed Truck Catalog (Form 508-B) has just been released by the Howe Scale Company containing specifications and illustrations for the complete line of two and four wheel hand trucks, trailer trucks, baggage wagons, platform skids, dollies, lift jack systems, wheels, casters, and "Molded-on-Rubber Tread Wheels." The catalog is extensively illustrated and contains a great deal of detailed information. 11/51.

### 326. EXPANDED METAL MESHES

Profusely illustrated and telling the story of the manufacturer of Expanded Metal and its uses in considerable detail, a new Catalog has just been published by the Penn Metal Company, Inc. Geared to the theme "How to make a little metal go a long way" the catalog shows a great many examples of uses for metal meshes and suggests many more. Emphasis is placed on the advantages of "Expanded Metal" in saving steel and other critical metals while at the same time accomplishing the purpose of providing saving in weight, allowing for free passage of light and air, accomplishing interesting and attractive decorative effects, and permitting flexibility of construction not possible with solid sheet. 11/51.

### 327. RADIANT SUNSHINE COMFORT

Electricglas Radiant Heat that is radiant sunshine comfort for every heating purpose is the title of a new Catalog No. EL-16 just issued by the Appleman Art Glass Works. Stressing simplicity, with beauty, economy and high flexibility the catalog contains a number of illustrations and specifications showing a variety of applications for heating homes, commercial buildings and factories. A number of installations are shown to demonstrate placement of tempered glass panel units to meet specific heating needs. 11/51.

### 328. FLAT SLAB CONSTRUCTION—SMOOTH CEILINGS

A new illustrated brochure descriptive of theory, application and benefits of the Smooth Ceiling System of Flat Slab Construction has just been published and is available to Architects, Engineers, and Contractors. It describes installations made in office buildings, industrial buildings, hospitals, schools, garages and dormitories. Tables based upon standard building code formulae are provided to assist building designers in selecting slab thickness. 11/51.

### 329. MODERN KITCHENS—IN STEEL

The Supermatic Products Corporation have just issued a pamphlet on "Columbia Kitchens"—Steel Kitchen Cabinets, AIA File No. 35-C-12, containing numerous photographs and renderings on various installations including apartment, cabin, and the all purpose Kitchen. To assist designers in determining the proper style for the specific use, the pamphlet includes a number of dimensional details for cabinets of every purpose. 11/51.

#### ARCHITECT AND ENGINEER

68 Post Street, San Francisco, Calif.

I would like to have a copy of each of the New Catalogues I have circled.

322	323	324	325
326	327	328	329

Please send to the address on my letterhead, or as I have indicated, and to my attention. (Please print your name — no literature will be sent on this coupon after December, 1951.—A. & E.)

### TILE COMPANY OPENS SALT LAKE OFFICES

The Mosaic Tile Company of Hollywood, has opened new offices in Salt Lake City, Utah, with Emmett Burley, formerly of the Atlanta office in charge.

Thomas B. Jordan, West Coast manager says the new facilities occupy some 2500 sq. ft. of space.

## The Most Complete Line of STEELS and STEEL BUILDING MATERIALS Made by a Single Producer



See Sweet's Catalog File or write us for full information.

### REPUBLIC STEEL CORPORATION

GENERAL OFFICES: CLEVELAND, OHIO

DENVER, COLORADO . . . . . CONTINENTAL OIL BUILDING  
LOS ANGELES, CALIF. . . . . GENERAL PETROLEUM BUILDING  
SAN FRANCISCO, CALIFORNIA . . . . . RIALTO BUILDING  
SEATTLE, WASH. . . . . WHITE-HENRY-STUART BUILDING

## PACIFIC MANUFACTURING CO.

High Class Interior Finish Quality  
Millwork

16 Beale St., San Francisco  
GARfield 1-7755

2215 El Comina Real, San Mateo  
S. M. 5-0687

304 Bryant Street, Palo Alto  
P. A. 3373

2610 The Alameda, Santa Clara  
S. C. 607 (Factory)

6820 McKinley Avenue, Los Angeles  
THornwall 4196

MAIN OFFICE — SANTA CLARA

## "AMERICAN - MARSH"

CONDENSATION UNIT

Pumping  
Machinery  
for  
Every  
Purpose

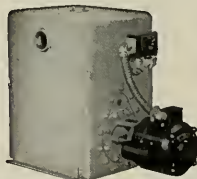

For Service  
Call  
DOuglas  
2-6794  
or  
MUtual 8322

### SIMONDS MACHINERY CO.

SAN FRANCISCO  
816 FOLSOM

LOS ANGELES  
455 EAST 4TH

## VERMONT MARBLE COMPANY

DOMESTIC AND IMPORTED MARBLES  
GRANITE VENEER

525 MARKET STREET • SAN FRANCISCO  
Phone: SUtter 1-6747

3522 COUNCIL STREET • LOS ANGELES  
Phone: DUUnkirk 2-7831

## DON'T LIFT IT ALONE

(From Page 11)

overstrain just as arm muscles or leg muscles get tired.

Experts have figured out that men should not lift loads more than 130 lbs. in weight, and women should not lift loads of more than 65 lbs. for intermittent work and 50 lbs. for continuous work. Raising a load from the feet is particularly difficult.

Repeated overstrain may produce enlargement of the heart muscle. Such enlargement caused by excess physical exertion is called Athlete's heart. Excessive exertion gives rise in a healthy man to signs of breathlessness, heart palpitation, giddiness, fatigue, also pain in the region of the heart. Such signs are the normal answer of the body to physical strain. Healthy building workers need considerable exertion before feeling of distress appears; weaker men require much less exertion.

The best advice is to avoid overexertion and to call a fellow-worker for assistance when lifting heavy loads. A building worker who feels that he has overstrained himself, better put in a few days of rest. Of all cures this is the best way to bring the heart back to normal.

### How Lifting Affects Nerves

A mason overstretched his right arm while he was carrying a heavy load, probably in connec-

tion with a brisk movement. The next day he felt a dull pain in and below the right shoulder. An important nerve had been under pressure because of the heavy load. He could not move his arm in the normal way, all arm movements were weakened. Despite different kinds of treatment the condition did not improve for quite some time.

The nerve fibres which join muscles to the brain, are mostly wrapped in a good layer of protective connecting tissue. On some places though they are more superficial, and strong pressure may hurt and injure the fibres. Traction on the arm, pull on the shoulder, or pressure on the shoulder from above by a heavy load may affect one or several nerves.

The muscles in that part of the arm may feel weak. They may lose strength. The hand and wrist may become paralyzed. A nerve going to the muscles of the shoulder is the long thoracic nerve. When it has been injured by excessive strain such as carrying a heavy sack, some time may be required for full recovery. Proper treatment and avoiding heavy lifting will restore the normal function of the nerve.

### A Cause of Backache

The onset of acute backache (lumbago) may be dramatic in its suddenness. A building worker lifts a load too heavy for him; it puts a excessive strain on his back muscles. Some of the fibres are ruptured, and he is struck with agonizing pain in the small of the back. No movement is possible, he lays down on the floor and cannot get up. Later the pain eases. He can move again. Other patients are not as fortunate, they cannot move by themselves. Particularly while working in a crouched or twisted position, a sudden movement may be sufficient to injure the back muscles.

Though lumbago is a very acute and disabling ailment, return to normalcy may be quick. There is every reason not to repeat the heavy exertion for a long time. People who have suffered from lumbago are susceptible to a recurrence for several months.

### Advantages of Material-Handling Devices

Knock knees and other leg conditions are less frequent today, due primarily to the use of mechanical devices instead of hands and arms. Many construction jobs are performed more satisfactorily by means of mechanical aid. Where this is not possible, the best means of lifting the load by hand have to be decided, taking into account whether construction of platforms, racks, benches or similar aids will reduce the amount of manual lift required.

Continuous standing at hard work and lifting heavy loads may produce weak feet and flat feet. Taxi drivers and desk workers are heavily hamp-

(See Page 43)

## VALUABLE NEWS SERVICE

- BUILDING MATERIAL DEALERS
- CONTRACTORS
- ENGINEERS
- FINANCIAL INSTITUTIONS

**ARCHITECTS REPORTS** gives advance news on construction projects in Northern California, lists: name of projects, location, architect, proposed cost and other pertinent information. **HANDY** individual slip-reports, issued daily at a total cost of only

\$10 a month

## ARCHITECT'S REPORTS

Published Daily

The ARCHITECT and ENGINEER, Inc.

68 Post Street, San Francisco - DO 8311



# ESTIMATOR'S GUIDE

## BUILDING AND CONSTRUCTION MATERIALS

PRICES GIVEN ARE FIGURING PRICES AND ARE MADE UP FROM AVERAGE QUOTATIONS FURNISHED BY MATERIAL HOUSES TO SAN FRANCISCO CONTRACTORS. 3% SALES TAX ON ALL MATERIALS BUT NOT LABOR

All prices and wages quoted are for San Francisco and the Bay District. There may be slight fluctuation of prices in the interior and southern part of the state. Freight carriage, at cost, must be added in figuring country work.

**BONDS**—Performance or Performance plus Labor and Material Bond(s), \$10 per \$1000 contract price. Labor & Material Bond(s) only, \$5.00 per \$1000 on contract price.

### BRICKWORK—MASONRY—

Common Brick—Per 1 M laid—\$100.00 up (according to class of work).  
Face Brick Per 1 M laid—\$200.00 end up (according to class of work).  
Brick Set \$3.00 and up.  
Common 1/4 Veneer on Frame Bldgs.—Approx. \$1.20 ea. up (according to class of work).  
Face Brick Veneer on Frame Bldgs.—Approx. \$2.00 ea. up (according to class of work).  
Common Clay—\$36.00 per M—truckload lots, delivered.  
Face Brick \$81.00 to \$106.00 per M, truckload lots, delivered.

**Glazed Sicular Units—**  
Clear Glazed—  
2 x 4 x 2 Furring \$1.60 per sq. ft.  
4 x 4 x 2 Part Face 1.90 per sq. ft.  
4 x 2 x 2 Double Faced  
Part Face 2.25 per sq. ft.  
For glazed glaze add .30 per sq. ft.  
Mans. For Brick \$105.00 per M—F.O.B. Pittsburgh.  
Fire Brick Per M \$111.00 to \$147.00.  
Carriage approx. \$10.00 per M.  
Facing \$5.00.  
**Building—**  
8 1/2" x 12 inches, per M. \$139.50  
6 1/2" x 12 inches, per M. 105.00  
4 1/2" x 12 inches, per M. 84.00  
**Hollow Tile—**  
12x12x7 es, per M \$146.75  
12x12x6 es, per M 156.85  
12x12x4 es, per M 177.10  
12x12x4 es, per M 235.30  
F.O.B. Plant

### BUILDING PAPER & FELTS

1 ply per 100 ft. roll. \$5.30  
2 ply per 100 ft. roll. 7.80  
3 ply per 100 ft. roll. 9.20  
Brownkin standard 500 ft. roll. 6.85  
Sisalraft reinforced, 36 in. by 500 ft. roll. 7.00  
**Sheathing Paper—**  
Asphalt Satting, 15-lb. roll. \$2.00  
30-lb. roll. 2.79  
Dampoc 216-ft. roll. 2.95  
Blue felt card, 60-lb. roll. 5.10  
**Felt Papers—**  
Deade wall, 3/4-lb., 50-ft. roll. \$3.23  
Deade wall, 1-lb. 3.79  
Asphalt impreg, 15-lbs. 7.00  
Asphalt impreg, 30-lbs. 2.79  
**Roofing Paper—**  
Asphalt R, 15 lb. \$2.09  
Sls dard, ead, 108-ft. roll, Light 1.87  
Sls dard, ead, 108-ft. roll, Medium 2.18  
Sls dard, ead, Heavy 2.56  
M. S. Extra Heavy 2.96

### BUILDING HARDWARE—

Sash cord, No. 7. \$2.65 per 100 ft.  
Sash cord, No. 8 3.00 per 100 ft.  
Sash cord, No. 7 3.85 per 100 ft.  
Sash cord, No. 8 3.35 per 100 ft.  
Sash cord, cast iron \$100.00 ton. \$3.75  
1-Ton 1/2 in. per 100 lbs. \$4.75  
Less the 1-ton lots, per 100 lbs. \$11.80  
Nails—  
8-in. 11.80  
6-in. 8.00  
Kim K. lock sets. 1.80  
Bolts, brass plated on steel, 3/2"x3/4" .76

### CONCRETE AGGREGATES—

The following prices net to Contractors unless otherwise shown. Carload lots only.

	Bunker per ton	Del'd per ton
Gravel, all sizes	\$2.44	\$2.90
Top Sand	2.38	3.13
Concrete Mix	2.38	3.06
Crushed Rock 1/4" to 3/4"	2.38	2.90
Crushed Rock 3/4" to 1 1/2"	2.38	2.90
Roofing Gravel	2.81	2.90
River Sand	2.50	3.00
Sand—		
Lapis (Nos. 2 & 4)	3.56	3.94
Olympic (Nos. 1 & 2)	3.56	3.88

Common (all brands, paper sack), carload lots, \$3.55 per bbl. f.o.b. car; delivered \$3.60.  
Per Sack, small quantity (paper) \$1.05  
Carload lots, in bulk per bbl. 2.79  
Cash discount on carload lots, 10c a bbl., 10th Prox., less than carload lots \$4.00 per bbl. f.o.b. warehouse or delivered.  
Cash discount 2% on L.C.L.  
Trinity White { 1 to 100 sets, \$3.13 sack  
warehouse or del.; \$9.56  
Medusa White { bbl. carload lots.

### CONCRETE READY-MIX—

1-2-4 mix, to 10 yards. \$12.00  
10 to 100\* yards. 11.00  
100 to 500 yards. 10.50  
Over 500 yards. 10.30  
\* Delivered to site.

### CONCRETE BLOCKS—

	Hay-salt	8a-salt
48x16 inches each	\$1.7	\$1.18
68x16 inches each	.22	.725
88x16 inches each	.26	.26
128x16 inches each	.34	.39
128x24 inches each		.60

Haydite Aggregates—  
3/4-inch to 3/8-inch, per cu. yd. \$7.25  
3/8-inch to 3/4-inch, per cu. yd. 7.25  
No. 6 to 0-inch, per cu. yd. 7.25

### DAMP-PROOFING and Waterproofing—

Two-coat work, \$9.00 per square.  
Membrane waterproofing—4 layers of saturated felt, \$10.00 per square.  
Hot coating work, \$5.00 per square.  
Medusa Waterproofing, \$3.50 per lb. San Francisco Warehouse.  
Tricoat concrete waterproofing, 60c a cubic yd. and up.

### ELECTRIC WIRING—\$15 to \$20 per outlet for conduit work (including switches).

Knob and tube average \$6.00 per outlet.

### ELEVATORS—

Prices vary according to capacity, speed and type. Consult elevator companies. Average cost of installing a slow speed automatic passenger elevator in small four story apartment building, including entrance doors, about \$9,500.00.

### EXCAVATION—

Sand, \$1.00; clay or shale, \$1.50 per yard. Trucks, \$30 to \$45 per day.

Above figures are an average without water. Steam shovel work in large quantities, less: hard material, such as rock, will run considerably more.

### FIRE ESCAPES—

Ten-foot galvanized iron balcony with stairs, \$250 installed on new buildings; \$300 on old buildings.

### FLOORS—

Asphalt tile, 1/8 in. gauge 18c to 35c per sq. ft.  
Composition Floors, such as Magnesite, 50c per square foot.  
Linoleum, standard gauge, sq. yd. \$2.75  
Mastipave—\$1.50 per sq. yd.  
Bathteship Linoleum—1/8"—\$3.00 sq. yd.  
Terazzo Floors—\$1.50 per sq. ft.  
Terazzo Steps—\$2.50 per lin. ft.  
Mastic Wear Coat—according to type—20c to 35c.

### Hardwood Flooring—

Oak Flooring—T & G—Unfin.—  
Clear Old, White. \$12 1/4 1/2 3/2 1/2  
Clear Old, Red. \$175 \$405 \$ \$  
Select Old, Red or White. 355 340  
Clear Pin, Red or White. 355 340 335 315  
Select Pin, Red or White. 340 330 325 300  
#1 Common, Red or White 315 310 305 280  
#2 Common, Red or White 305

### Refinished Oak Flooring—

	Primo	Standard
1/2 x 2	\$369.00	\$359.00
1/2 x 2 1/2	380.00	370.00
1 1/2 x 2 1/2	390.00	381.00
1 1/2 x 2 1/4	375.00	365.00
1 1/2 x 3/4	395.00	375.00
1 1/2 x 2 1/4 & 3/4 Ranch Plank		415.00

### Unfinished Maple Flooring—

1 1/2 x 2 1/4 First Grade. \$390.00  
1 1/2 x 2 1/4 2nd Grade. 365.00  
1 1/2 x 2 1/4 2nd & 8tr. Grade. 375.00  
1 1/2 x 2 1/4 3rd Grade. 240.00  
1 1/2 x 3/4 3rd & 8tr. Jrd. EM. 380.00  
1 1/2 x 3/2 2nd & 8tr. Jrd. EM. 390.00  
33/32 x 2 1/4 First Grade. 360.00  
33/32 x 2 1/4 2nd Grade. 375.00  
33/32 x 2 1/4 3rd Grade. 420.00  
Floor Layer's Wage \$2.50 hr.

### GLASS—

Single Strength Window Glass \$ .30 per sq. ft.  
Double Strength Window Glass .45 per sq. ft.  
Plate Glass, 1/4 polished to 75. 1.60 per sq. ft.  
75 to 100. 1.24 per sq. ft.  
1/4 in. Polished Wire Plate Glass 2.35 per sq. ft.  
1/4 in. Rgh. Wire Glass .71 per sq. ft.  
1/4 in. Polished Wire Plate Glass 2.00 per sq. ft.  
1/4 in. Rgh. Wire Glass .64 per sq. ft.  
1/8 in. Obscure Glass. .40 per sq. ft.  
3/8 in. Obscure Glass. .64 per sq. ft.  
1/2 in. Heat Absorbing Obscure. 58 per sq. ft.  
1/4 in. Heat Absorbing Wire. 86 per sq. ft.  
Glazing of above additional \$1.50 to 30 per sq. ft.  
Glass Blocks, set in place — 3.50 per sq. ft.

### HEATING—

Average, \$3.50 to \$4.00 per sq. ft. of radiation, according to conditions.  
Warm air (gravity) average \$64 per register.  
Forced air average \$91 per register.

## DON'T LIFT IT ALONE

(From Page 11)

overstrain just as arm muscles or leg muscles get tired.

Experts have figured out that men should not lift loads more than 130 lbs. in weight, and women should not lift loads of more than 65 lbs. for intermittent work and 50 lbs. for continuous work. Raising a load from the feet is particularly difficult.

Repeated overstrain may produce enlargement of the heart muscle. Such enlargement caused by excess physical exertion is called Athlete's heart. Excessive exertion gives rise in a healthy man to signs of breathlessness, heart palpitation, giddiness, fatigue, also pain in the region of the heart. Such signs are the normal answer of the body to physical strain. Healthy building workers need considerable exertion before feeling of distress appears; weaker men require much less exertion.

The best advice is to avoid overexertion and to call a fellow-worker for assistance when lifting heavy loads. A building worker who feels that he has overstrained himself, better put in a few days of rest. Of all cures this is the best way to bring the heart back to normal.

### How Lifting Affects Nerves

A mason overstretched his right arm while he was carrying a heavy load, probably in connec-

tion with a brisk movement. The next day he felt a dull pain in and below the right shoulder. An important nerve had been under pressure because of the heavy load. He could not move his arm in the normal way, all arm movements were weakened. Despite different kinds of treatment the condition did not improve for quite some time.

The nerve fibres which join muscles and brain, are mostly wrapped in a good layer of fat or connecting tissue. On some places though they are more superficial, and strong pressure may hurt and injure the fibres. Traction on the arm, a fall on the shoulder, or pressure on the shoulder from above by a heavy load may affect one or several nerves.

The muscles in that part of the arm then feel weak. They may lose strength. The arm or hand may become paralyzed. A nerve going to the muscles of the shoulder is the long thoracical nerve. When it has been injured by excessive strain such as carrying a heavy sack, some time may be required for full recovery. Proper treatment and avoiding heavy lifting will restore the normal function of the nerve.

### A Cause of Backache

The onset of acute backache (lumbago) may be dramatic in its suddenness. A building worker lifts a load too heavy for him; it puts an excessive strain on his back muscles. Some muscle fibers are ruptured, and he is struck with agonizing pain in the small of the back. No movement is possible, he lays down on the floor and cannot get up. Later the pain eases. He can move again. Other patients are not as fortunate, they cannot move by themselves. Particularly while working in stooped or twisted position, a sudden movement may be sufficient to injure the back muscles.

Though lumbago is a very acute and disabling ailment, return to normalcy may be quick. There is every reason not to repeat the heavy exertion for a long time. People who have suffered from lumbago are susceptible to a recurrence for several months.

### Advantages of Material-Handling Devices

Knock knees and other leg conditions are less frequent today, due primarily to the use of mechanical devices instead of hands and arms. Many construction jobs are performed more satisfactorily by means of mechanical aid. Where this is not possible, the best means of lifting the loads by hand have to be decided, taking into account whether construction of platforms, racks, benches or similar aids will reduce the amount of vertical lift required.

Continuous standing at hard work and lifting heavy loads may produce weak foot and flat foot. Taxi drivers and desk workers are hardly hamp-

(See Page 43)

## VALUABLE NEWS SERVICE

- BUILDING MATERIAL DEALERS
- CONTRACTORS
- ENGINEERS
- FINANCIAL INSTITUTIONS

**ARCHITECTS REPORTS** gives advance news on construction projects in Northern California, lists: name of projects, location, architect, proposed cost and other pertinent information.

**HANDY** individual slip-reports, issued daily at a total cost of only

\$10 a month

## ARCHITECT'S REPORTS

Published Daily

The ARCHITECT and ENGINEER, Inc.

68 Post Street, San Francisco - DO 8311

# ESTIMATOR'S GUIDE

## BUILDING AND CONSTRUCTION MATERIALS

PRICES GIVEN ARE FIGURING PRICES AND ARE MADE UP FROM AVERAGE QUOTATIONS FURNISHED BY MATERIAL HOUSES TO SAN FRANCISCO CONTRACTORS. 3% SALES TAX ON ALL MATERIALS BUT NOT LABOR

All prices and wages quoted are for San Francisco and the Bay District. There may be slight fluctuation of prices in the interior and southern part of the state. Freight cartage, at least, must be added in figuring country work.

**BONDS**—Performance or Performance plus Labor and Material Bond(s), \$10 per \$1000 on contract price. Labor & Material Bond(s) only, \$5.00 per \$1000 on contract price.

**BRICKWORK—MASONRY—**

Common Brick—Per 1 M laid—\$100.00 up (according to class of work).  
Face Brick—Per 1 M laid—\$200.00 and up (according to class of work).  
Common Brick Veneer on Frame Bldgs.—Approx. \$1.20 and up (according to class of work).  
Face Brick Veneer on Frame Bldgs.—Approx. \$2.00 and up (according to class of work).  
Common Brick—\$36.00 per M—truckload lots, delivered.  
Face Brick—\$81.00 to \$106.00 per M, truckload lots, delivered.  
**Glazed Structural Units—**  
Clear Glazed—  
2 x 6 x 12 Furring ..... \$1.60 per sq. ft.  
4 x 6 x 12 Partition ..... 1.50 per sq. ft.  
4 x 6 x 12 Double Faced .....  
Partition ..... 2.25 per sq. ft.  
Fire colored glass add ..... .30 per sq. ft.  
Metal Fire Brick—\$105.00 per M—F.O.B. Pittsburgh.  
Fire Brick—Per M—\$110.00 to \$147.00.  
Cortage—Approx. \$10.00 per M.  
Paving—\$75.00.

**Building Tile—**  
8 1/2"x12-inches, per M..... \$139.50  
6 1/2"x12-inches, per M..... 106.00  
4 1/2"x12-inches, per M..... 84.00  
**Hollow Tile—**  
12x12x2-inches, per M..... \$146.75  
12x12x3-inches, per M..... 156.85  
12x12x4-inches, per M..... 171.10  
12x12x6-inches, per M..... 235.30  
F.O.B. Plant

**BUILDING PAPER & FELTS**

1 ply per 100 ft. roll..... \$5.30  
2 ply per 100 ft. roll..... 7.80  
3 ply per 100 ft. roll..... 9.70  
Brownish, Standard 500 ft. roll..... 6.85  
Sivakraft, reinforced, 36 in. by 500 ft. roll..... 7.00

**Sheathing Papers—**  
Asphalt sheathing, 15-lb. roll..... \$2.00  
30-lb. roll..... 2.79  
Damp-proof, 216-ft. roll..... 2.95  
Blue Plasterboard, 60-lb. roll..... 5.10

**Felt Papers—**  
Deadening felt, 3/4-lb., 50-ft. roll..... \$3.23  
1-lb. felt, 50-ft. roll..... 3.79  
Asphalt roofing, 15-lb. roll..... 2.00  
Asphalt roofing, 30-lb. roll..... 2.79

**Roofing Papers—**  
Asphalt felt, 15 lb..... \$2.09  
Standard grade, 108-ft. roll, Light..... 1.87  
Smooth Surface, Medium..... 2.18  
Heavy..... 2.56  
M. S. Extra Heavy..... 2.76

**BUILDING HARDWARE—**

Sash cord com. No. 7 ..... \$2.65 per 100 ft.  
Sash cord com. No. 8 ..... 3.00 per 100 ft.  
Sash cord spot No. 7 ..... 3.65 per 100 ft.  
Sash cord spot No. 8 ..... 3.35 per 100 ft.  
Siv-ton, best iron, \$100.00 ton.....  
1-Ton lots, per 100 lbs..... \$3.75  
Siv-ton, 1-ton lots, per 100 lbs..... \$4.75  
Nails, per keg, base..... \$11.80  
8-in. spikes ..... 11.80  
Rim Knob lock set..... 11.80  
Butts, dull best plated on steel, 3/16"x3/8" ..... .76

**CONCRETE AGGREGATES—**

The following prices net to Contractors unless otherwise shown. Carload lots only.

	Bunker per ton	Del'd per ton
Gravel, all sizes.....	\$2.44	\$2.90
Top Sand.....	2.38	3.13
Concrete Mix.....	2.38	3.06
Crushed Rock, 1/2" to 3/4".....	2.38	2.90
Crushed Rock, 3/4" to 1 1/2".....	2.38	2.90
Roofing Gravel.....	2.81	2.90
River Sand.....	2.50	3.00
<b>Sand—</b>		
Lepis (Nos. 2 & 4).....	3.56	3.94
Olympic (Nos. 1 & 2).....	3.56	3.88

Cement—  
Common (all brands, paper sacks), carload lots, \$3.55 per bbl. f.o.b. car; delivered \$3.60.  
Per Sack, small quantity (paper)..... \$1.05  
Carload lots, in bulk per bbl..... 2.79  
Cash discount on carload lots, 10c or bbl, 10th Prov., less than carload lots \$4.00 per bbl. f.o.b. warehouse or delivered.  
Cash discount 2% on L.C.L.

Trinity White { 1 to 100 sacks, \$3.13 sack  
warehouse or del.; \$9.56  
Medusa White { bbl. carload lots.

**CONCRETE READY-MIX—**

1-2.4 mix, to 10 yards\*..... \$12.00  
10 to 100\* yards..... 11.00  
100 to 500 yards..... 10.50  
Over 500 yards..... 10.30

\* Delivered to site.

**CONCRETE BLOCKS—**

	Hay-dite	Basalt
48x16-inches each.....	\$.17	\$.18
68x16-inches, each.....	.22	.25
84x16-inches, each.....	.26	.26
128x16-inches, each.....	.34	.39
128x24-inches, each.....	.60	.60

**Haydite Aggregates—**  
3/4-inch to 3/8-inch, per cu. yd..... \$7.25  
3/8-inch to 1/2-inch, per cu. yd..... 7.25  
No. 6 to 0-inch, per cu. yd..... 7.25

**DAMP-PROOFING and Waterproofing—**

Two-coat work, \$9.00 per square.  
Membrane waterproofing—4 layers of saturated felt, \$10.00 per square.  
Hot coating work, \$5.00 per square.  
Medusa Waterproofing, \$3.50 per lb. San Francisco Warehouse.

Tricoat concrete waterproofing, 60c a cubic yd. and up.

**ELECTRIC WIRING—\$15 to \$20 per outlet for conduit work (including switches).  
Knob and tube average \$6.00 per outlet.**

**ELEVATORS—**

Prices vary according to capacity, speed and type. Consult elevator companies. Average cost of installing a slow speed automatic passenger elevator in small four story apartment building, including entrance doors, about \$9,500.00.

**EXCAVATION—**

Sand, \$1.00; clay or shale, \$1.50 per yard.  
Trucks, \$30 to \$45 per day.  
Above figures are an average without water. Steam shovel work in large quantities, less; hard material, such as rock, will run considerably more.

**FIRE ESCAPES—**

Ten-foot galvanized iron balcony, with stairs, \$250 installed on new buildings; \$300 on old buildings.

**FLOORS—**

Asphalt Tile, 1/8 in. gauge 18c to 35c per sq. ft.  
Composition Floors, such as Magnesia, 50c per square foot.  
Linoleum, standard gauge, sq. yd..... \$2.75  
Mastipave—\$1.50 per sq. yd.  
Battleship Linoleum—1/8"—\$3.00 sq. yd.  
Terrazo Floors—\$1.50 per sq. ft.  
Terrazo Steps—\$2.50 per sq. ft.  
Mastic Wear Coat—according to type—20c to 35c.

**Hardwood Flooring—**

**Oak Flooring—T & G—Unfin.—**  
Clear Old, White..... \$4 1/2 1/2 3/2 3/2  
Clear Old, Red..... 4 405 \$ \$  
Select Old, Red or White..... 355 340  
Clear Pin, Red or White..... 355 340 325 315  
Select Pin, Red or White..... 340 325 300 290  
#1 Common, Red or White..... 315 310 305 280  
#2 Common, Red or White..... 305

**Refinished Oak Flooring—**

	Prime	Standard
1/2 x 2.....	\$369.00	\$359.00
3/4 x 2 1/2.....	380.00	370.00
1 1/2 x 2 1/2.....	390.00	381.00
3 1/2 x 2 1/2.....	375.00	355.00
3 1/2 x 3/4.....	395.00	375.00
3 1/2 x 2 1/4 & 3/4 Ranch Plank.....	415.00	415.00

**Unfinished Maple Flooring—**

3 1/2 x 2 1/4 First Grade.....	\$390.00
3 1/2 x 2 1/4 2nd Grade.....	365.00
3 1/2 x 2 1/4 3rd Grade.....	375.00
3 1/2 x 2 1/4 3rd Grade.....	240.00
3 1/2 x 3/4 3rd & Btr. Jtd. EM.....	380.00
3 1/2 x 3/4 2nd & Btr. Jtd. EM.....	390.00
33/32 x 2 1/4 First Grade.....	400.00
33/32 x 2 1/4 2nd Grade.....	360.00
33/32 x 2 1/4 3rd Grade.....	320.00

Floor Layer Wage \$2.50 hr.

**GLASS—**

Single Strength Window Glass..... \$ .30 per sq ft.  
Double Strength Window Glass..... .45 per sq ft.  
Plate Glass, 1/4 polished to 75..... 1.60 per sq ft.  
75 to 100..... 1.74 per sq ft.  
1/4 in. Polished Wire Plate Glass..... 2.35 per sq ft.  
1/4 in. Rgh. Wire Glass..... .71 per sq ft.  
1/4 in. Polished Wire Plate Glass..... 2.00 per sq ft.  
1/4 in. Rgh. Wire Glass..... .64 per sq ft.  
1/2 in. Obscure Glass..... .40 per sq ft.  
3/8 in. Obscure Glass..... .64 per sq ft.  
1/2 in. Heat Absorbing Obscure..... .58 per sq ft.  
1/4 in. Heat Absorbing Wire..... .86 per sq ft.  
Glazing of above additional \$.15 to .30 per sq ft.  
Glass Blocks, set in place..... 3.50 per sq ft.

**HEATING—**

Average, \$3.50 to \$4.00 per sq. ft. of radiation, according to conditions.  
Warm air (gravity) average \$64 per register.  
Forced air average \$91 per register.

## INSULATION AND WALLBOARD—

Rockwool Insulation—		
(2") Less than 1,000 □ ft.	\$64.00	
(2") Over 1,000 □ ft.	\$9.00	
Carbon Insulation—Full-thickness (3%)	\$95.50 per M sq. ft.	
Sisalation Aluminum Insulation—Aluminum coated on both sides	\$73.50 per M sq. ft.	
Tileboard—4"x6" panel	\$9.00 per panel	
Tileboard—4"x4" thickness	\$55.00 per M sq. ft.	
Finished Plank	\$69.00 per M sq. ft.	
Galving Tileboard	\$69.00 per M sq. ft.	

IRON—Cost of ornamental iron, cast iron, etc., depends on designs.

## LUMBER—

\$45 No. 2 and better common O.P. or D.F. per M. f.b.m.	\$100.00
Rough, No. 2 common O.P. or D.F. per M. f.b.m.	100.00

## Flooring—

	Per M Delvd.
V.G.-D.F. 8 & 8tr. 1 x 4 T & G Flooring.	\$225.00
"C" and better—all.	225.00
"D" and better—all.	225.00
Rwd. Rustic—"A" grade, medium dry 8 to 24 ft.	185.00
Plywood, per M sq. ft.	
1/4-inch, 4,0x8-0-51S	\$170.00
1/2-inch, 4,0x8-0-51S	250.00
3/4-inch, per M sq. ft.	\$185.00
Plyscard	11 1/2¢ per ft.
Plyform	25¢ per ft.

## Shingles (Rwd. not available)—

Red Cedar No. 1—\$9.50 per square; No. 2, \$7.00; No. 3, \$5.00.	
Average cost to lay shingles, \$6.00 per square.	
Cedar Shakes—1/2" to 3/4" x 24/26 in handsplit tapered or split resawn, per square	\$15.25
3/4" to 1 1/4" x 24/26 in split resawn, per square	17.00
Average cost to lay shakes, 8.00 per square	
Pressure Treated Lumber—Add \$35 per M to above	
Creosoted,	
8-lb. treatment	Add \$45 per M to above

## MARBLE—(See Dealers)

## METAL LATH EXPANDED—

Standard Diamond, 3,40, Copper Bearing, LCL, per 100 sq. yds.	\$43.50
Standard Ribbed, ditto	\$47.50

## MILLWORK—Standard.

D. F. \$150 per 1000. R. W. Rustic \$175 per 1000 (delivered).
Double hung box window frames, average with trim, \$12.50 and up, each.
Complete door unit, \$15 to \$25.
Screen doors, \$8.00 to \$12.00 each.
Patent screen windows, \$1.25 a sq. ft.
Cases for kitchen pantries seven ft. high, per lineal ft., upper \$9.00 to \$11.00; lower \$12.00 to \$13.00.
Dining room cases, \$20.00 per lineal foot.
Rough and finish about \$1.00 per sq. ft.
Labor—Rough carpentry, warehouse heavy framing (average), \$75.00 per M.
For smaller work average, \$85.00 to \$100. per 1000.

## PAINTING—

Two-coat work	per yard 85c
Three-coat work	per yard 1.10
Cold water painting	per yard 25c
Whitewashing	per yard 15c
Linseed Oil, Strictly Pure (Basis 7 1/2 lbs. per gal.)	Raw \$2.25 Boiled \$2.34
Light iron drums	per gal. 2.40
5-gallon cans	per gal. 2.46
1-gallon cans	each 2.52
Quart cans	each 2.58
Pint cans	each .38
1/2-pint cans	each .24
Turpentine	Pure Gum
(Basis, 7 1/2 lbs. per gal.)	5 pints
Light iron drums	per gal. \$1.65
5-gallon cans	per gal. 1.76
1-gallon cans	each 1.88
Quart cans	each .54
Pint cans	each .31
1/2-pint cans	each .20

## Pioneer White Lead in Oil Heavy Paste and All-Purpose (Soft-Paste)

Net Weight Packages	List Price		Price to Painters	
	per 100 lbs.	Per 100 pgs.	Per 100 lbs.	Per 100 pgs.
100-lb. kegs	\$28.35	\$29.35	\$27.50	\$27.50
50-lb. kegs	30.05	15.03	28.15	14.08
25-lb. kegs	30.35	7.59	28.45	7.12
5-lb. cans*	33.35	1.34	31.25	1.25
1-lb. cans	36.00	.36	33.75	.34

500 lbs. (one delivery) 3/4¢ per pound less than above.  
\*Heavy Paste only.

## Pioneer Dry White Lead—Litharge—Dry Red Lead—Red Lead in Oil

Products	Price to Painters—Price Per 100 Pounds	
	100 lbs.	25 lbs.
Dry White Lead	\$26.30	\$
Litharge	25.95	26.60
Dry Red Lead	27.20	27.85
Red Lead in Oil	30.65	31.60

Paint cans, \$3.7 per lb.

## PATENT CHIMNEYS—

6-inch	\$2.50 lineal foot
8-inch	3.00 lineal foot
10-inch	4.00 lineal foot
12-inch	5.00 lineal foot

## PLASTER—

Neat wall, per ton delivered in S. F. in paper bags, \$17.60.

## PLASTERING (Interior)—

3 Coats, metal lath and plaster	Yard \$3.00
Keene cement on metal lath	3.50
Ceilings with 3/4 hot roll channels metal lath (lath only)	3.00
Seatings with 3/4 hot roll channels metal lath plastered	4.50
Single partition 3/4 channel lath 1 side (lath only)	3.00
Single partition 3/4 channel lath 2 inches thick plastered	8.00
4-inch double partition 3/4 channel lath 2 sides (lath only)	5.75
4-inch double partition 3/4 channel lath 2 sides plastered	8.75
Thermax single partition; 1" channels; 2 1/4" overall partition width. Plastered both sides	7.50
Thermax double partition; 1" channels; 4 1/2" overall partition width. Plastered both sides	11.00
3 Coats over 1" Thermax nailed to one side wood studs or joists	4.50
3 Coats over 1" Thermax suspended to one side wood studs with spring sound isolation clip	\$1.50

Note—Channel lath controlled by limitation orders.

## PLASTERING (Exterior)—

2 coats cement finish, brick or concrete wall	Yard \$2.50
3 coats cement finish, No. 18 gauge wire mesh	3.50
1 lime—\$4.00 per bbl. at yard.	
Processed LLime—\$4.15 per bbl. at yard.	
Rock or Grip Lath—3/4"=30¢ per sq. yd.	
1/2"=29¢ per sq. yd.	
Composition Stucco—\$4.00 sq. yard (applied).	

## PLUMBING—

From \$200.00 per fixture up, according to grade, quality and runs.

## ROOFING—

"Standard" tar and gravel, 4 ply—\$11.00 per sq. for 30 sqs. or over.	
Less than 30 sqs. \$14.00 per sq.	
Tile \$40.00 to \$50.00 per square.	
No. 1 Redwood Shingles in place, 4/2 in. exposure, per square	\$18.25
5/2 No. 1 Cedar Shingles, 5 in. exposure, per square	14.50
5/8 x 16"—No. 1 Little Giant Cedar Shingles, 5" exposure, per square	18.25

4/2 No. 1-24" Royal Cedar Shingles 7/2" exposure, per square	\$23.00
Re-coat with Gravel \$5.00 per sq.	
Asbestos Shingles, \$27 to \$35 per sq. laid.	
1/2 to 3/4 x 25" Resawn Cedar Shakes, 10" Exposure	\$30.00
3/4 to 1 1/4 x 25" Resawn Cedar Shakes, 10" Exposure	\$35.00
1 x 25" Resawn Cedar Shakes, 10" Exposure	22.00

Above prices are for shakes in place.

## SEWER PIPE—

C.I. 6-in. to 24-in. B. & S. Class B and heavier, per ton	\$99.50
Vitrified, per feet L.C.L. F.O.B. Warehouse, San Francisco	
Standard, 8-in.	\$ 66
Standard, 12-in.	1.30
Standard, 24-in.	5.41
Clay Drain Pipe, per 1,000 L.F. L.C.L. F.O.B. Warehouse, San Francisco	
Standard, 6-in. per M.	\$240.00
Standard, 8-in. per M.	400.00

## SHEET METAL—

Windows—Metal, \$2.50 a sq. ft.
Fire doors (average), including hardware \$2.80 per sq. ft., size 12'x12'. \$3.75 per sq. ft., size 3'x6'.

## SKYLIGHTS—(Not glazed)

Copper, \$1.25 sq. ft. (flat).
Galvanized iron, 65c sq. ft. (flat).
Vented hip skylights, \$1.50 sq. ft.

## STEEL—STRUCTURAL

\$220 per ton erected, when out of mill. \$270 per ton erected, when out of stock.

## STEEL REINFORCING—

\$200.00 per ton, in place.	
1/4-in. Rd. (Less than 1 ton)	\$8.40
3/8-in. Rd. (Less than 1 ton)	7.30
1/2-in. Rd. (Less than 1 ton)	7.00
5/8-in. Rd. (Less than 1 ton)	6.75
3/4-in. & 7/8-in. Rd. (Less than 1 ton)	6.65
1-in & up (Less than 1 ton)	6.60
1 ton to 5 tons, deduct 25c.	

## STONE FRONTS (None available).

## TILE—

Ceramic Tile Floors—Commercial \$1.20 to \$1.60 per sq. ft.	
Cove Base—\$1.40 per lin. ft.	
Quarry Tile Floors, 6x6" with 6" base @ \$1.35 per sq. ft.	
The Waincoats & Floors, Residential, 4 1/4 x 4 1/4", @ \$1.65 to \$2.00 per sq. ft.	
The Waincoats, Commercial Jobs, 4 1/4 x 4 1/4" Tile, @ \$1.50 to \$1.65 per sq. ft.	
Asphalt Tile Floor 1/2" x 1/2" @ .18 - .35 sq. yd. Light shades slightly higher.	
Cork Tile—\$ .70 per sq. ft.	
Mosaic Floor—See dealers.	
Lino-Tile—\$1.00 per sq. ft.	
Rubber Tile—\$.55 to \$.75 per sq. ft.	
Building Tile—	
8x5 1/2-inches, per M.	\$139.50
6x5 1/2-inches, per M.	105.00
4x5 1/2-inches, per M.	84.00
Hollow Tile—	
12x12-inches, per M.	\$146.75
12x12 1/2-inches, per M.	156.85
12x12 1/4-inches, per M.	177.10
12x12 1/8-inches, per M.	235.50

F.O.B. Plant

## VENETIAN BLINDS—

75c per square foot and up. Installation extra.

## WINDOWS—STEEL—INDUSTRIAL

Cost depends on design and quality required.



# ARCHITECT AND ENGINEER ESTIMATOR'S DIRECTORY

## Building and Construction Materials

EXPLANATION—Building and construction materials are shown in major classified groups for general identification purposes with names and addresses of suppliers of materials listed in detail under group classification where name first appears—main offices are shown first with branch or district offices following. The numeral appearing in listings refers to the major group classification where complete data on the dealer, or representative, may be found.

### AIR CONDITIONING (b)

Air Conditioning & Cooling  
UTILITY APPLIANCE CORP.  
Los Angeles 58, 4851 S. Alameda St.  
San Francisco, 1355 Market St., UN 1-4908

### ARCHITECTURAL VENEER (a)

Ceramic Veneer  
PACIFIC CLAY PRODUCTS  
San Francisco: 605 Market St., GA 1-3970  
Los Angeles, Portland, Salt Lake City  
GLADDING, McBEAN & CO. \*(1)  
Porcelain Veneer  
PORCELAIN ENAMEL PUBLICITY BUREAU  
(Dept. AE-450)  
Room 601, Franklin Building, Oakland 12, California  
P. O. Box 186, East Pasadena Station, Pasadena 8, California  
Granite Veneer  
VERMONT MARBLE COMPANY  
San Francisco 5: 525 Market Street, SU 1-6747  
Los Angeles 4: DU 2-7834

Marble Veneer  
VERMONT MARBLE COMPANY  
San Francisco 5: 525 Market Street, SU 1-6747  
Los Angeles 4: DU 2-7834

**BANKS-FINANCING (1b)**  
CROCKER NATIONAL BANK OF S. F.  
San Francisco, Post & Montgomery St's., EX 2-7700

**BRASS PRODUCTS (1a)**  
GREENBERG'S, M. & SONS  
San Francisco, Calif.: 765 Folsom, EXbrook 2-3143

**BRICKWORK (1)**  
Face Brick  
GLADDING, McBEAN & CO.  
San Francisco: Harrison at 9th Sts., UN 1-7400  
Los Angeles: 2901 Los Feliz Blvd., OL 2121  
Offices at Portland, Seattle, Spokane  
KRAFT  
Niles, California, Niles 3611  
San Francisco 5: 50 Hawthorne St., DO 2-3780  
Los Angeles 13: 406 South Main St., MU 7241  
REMILLARD-DANDINI CO.  
San Francisco: 400 Montgomery St., EX 2-4988

**BRONZE PRODUCTS (1b)**  
GREENBERG'S, M. & SONS  
San Francisco, Calif.: 765 Folsom, EXbrook 2-3143

**BUILDING PAPER & FELTS (2)**  
SISALKRAFT COMPANY  
San Francisco: 55 New Montgomery St., EX 2-3066  
Chicago, Ill.: 205 West Wacker Drive  
ANGIER PACIFIC CORP.  
San Francisco 5: 55 New Montgomery St., DO 2-4416  
Los Angeles: 7424 Sunset Boulevard

**BUILDING HARDWARE (3)**  
THE STANLEY WORKS  
San Francisco: Monadnock Bldg., YU 6-5914  
New Britain, Conn.

**CEMENT (c)**  
PACIFIC PORTLAND CEMENT  
San Francisco: 417 Montgomery St., GA 1-4100

**CONCRETE AGGREGATES (4)**  
Lightweight Aggregates  
AMERICAN PERLITE CORP.  
Richmond, Calif.: 26th & B Sts.—Yard 2, RI 4307

**DOORS (4a)**  
Hollywood Doors  
WEST COAST SCREEN CO.  
Los Angeles: 1127 E. 63rd St. AD 1-1108  
Distributors:

W. P. FULLER CO.  
Seattle, Tacoma, PORTLAND  
NICOLAI DOOR SALES CO.  
San Francisco: 3045 19th St.  
T. M. COBB CO.  
Los Angeles: & San Pedro  
SOUTHWEST SASH & DOOR  
Phoenix, Arizona  
HOUSTON SASH & DOOR  
Houston, Texas  
Screen Doors  
WEST COAST SCREEN CO.  
(See Hollywood Door listing above)

**FIRE ESCAPES (5)**  
SOULE STEEL  
San Francisco: 1750 Army St., VA 4-4141  
Los Angeles, Calif.—LA 0911  
Portland, Ore.—BE 5155  
Seattle, Wash.—SE 3010  
MICHEL & PFEFFER IRON WORKS, INC.  
South Linden and Tanforan Aves.  
South San Francisco: JU 4-8362

**FIREPLACES (5a)**  
Heat Circulating  
SUPERIOR FIREPLACE CO.  
Los Angeles: 1708 E. 15th St. PR 8393  
Baltimore, Md.: 601 No. Point Rd.

**FLOORS (6)**  
Hardwood Flooring  
HOGAN LUMBER COMPANY  
Oakland: Second and Alice Sts., GL 1-6861  
E. K. WOOD LUMBER CO.  
Los Angeles: 4710 S. Alameda St., JE 3111  
Oakland: 727 Kennedy St., KE 4-8466  
Portland: 827 Terminal Sales Building  
Floor Treatment & Maintenance  
HILLYARD SALES CO. (Western)  
470 Alabama St., San Francisco, MA 1-7766  
Los Angeles, 923 E. 3rd, TRINITY 8282  
Seattle: 3440 E. Marginal Way

**GLASS (7)**  
W. P. FULLER COMPANY  
San Francisco: 301 Mission St., EX 2-7151  
Los Angeles, Calif.  
Portland, Oregon

**HEATING (8)**  
HENDERSON FURNACE & MFG. CO.  
S. T. JOHNSON CO.  
Oakland 8: 940 Arlington Ave., OL 2-6000  
San Francisco: 585 Potrero Ave., MA 1-2757  
Philadelphia 8, Pa.: 401 No. Broad St.  
SCOTT COMPANY  
San Francisco: 243 Minna St., YU 2-0400  
Oakland: 113 - 10th St., GL 1-1937  
San Jose, Calif.  
Los Angeles, Calif.

Electric Heaters  
ELECTROMODE CORP.  
Rochester, N. Y.  
San Francisco: 1355 Market St., KL 2-2311  
Northern California Distributors  
GENERAL ELECTRIC SUPPLY CORP.  
San Francisco: 1201 Bryant St., UN 3-4000  
Emeryville: 5400 Hollis St., CO 4-3433  
Sacramento: 1131 S. St., GI 3-9001  
Fresno: 1234 O St., Fresno 4-4746  
INCANDESCENT SUPPLY COMPANY  
Redding: 2146 Pine St., Redding 200  
THOMAS B. HUNTER (Designer)  
San Francisco: 41 Sutter St., GA 1-1164

UTILITY APPLIANCE CORP. \*(b)  
**INSULATION AND WALLBOARD (9)**  
LUMBER MANUFACTURING CO.  
San Francisco: 225 Industrial Ave., JU 7-1760  
SISALKRAFT COMPANY \*(2)  
WESTERN ASBESTOS COMPANY  
San Francisco: 675 Townsend St., KL 2-3868  
Oakland: 251 Fifth Avenue, GL 1-2345  
Sacramento: 1224 I Street, 2-8993  
Stockton: 1120 E. Weber Ave., 4-1863  
Fresno: 1837 Merced Street, 3-3277  
San Jose: 201 So. Market St., BA 4359-J

**IRON—Ornamental (10)**  
MICHEL & PFEFFER IRON WORKS, INC. \*(5)

**LANDSCAPE (11a)**  
Landscape Contractors  
HENRY C. SOTO CORPN.  
Los Angeles, 13000 S. Avalon Blvd. ME 4-6617

**LIGHTING FIXTURES (11)**  
SMOOTH-HOLMAN COMPANY  
Inglewood, Calif., OR 8-1217  
San Francisco: 55 Mississippi St., MA 1-8474

**LUMBER (12)**  
HOGAN LUMBER COMPANY \*(6)  
LUMBER MANUFACTURING CO. \*(9)  
E. K. WOOD LUMBER CO \*(6)  
Shingles  
SIDEWALL LUMBER COMPANY  
San Francisco 24: 1995 Oakdale Ave., AT 2-8112

**MARBLE (13)**  
VERMONT MARBLE COMPANY  
San Francisco: 525 Market St., SU 1-6747  
Los Angeles 4: 3522 Council St., DU 2-7834

**METAL LATH EXPANDED (14)**  
FORDERER CORNICE WORKS  
San Francisco: 269 Potrero Ave., HE 1-4100  
SOULE STEEL \*(5)

**MILLWORK (15)**  
PACIFIC MANUFACTURING COMPANY  
San Francisco: 16 Beale St., GA 1-7755  
Santa Clara: 2610 The Alameda, SC 607  
Los Angeles: 6820 McKinley Ave., TH 4196  
MULLEN MANUFACTURING COMPANY  
San Francisco: 60-80 Rausch St., UN 1-5815  
LUMBER MANUFACTURING COMPANY \*(9)

**PAINTING (16)**  
Paint  
W. P. FULLER COMPANY \*(7)

**PLASTER (17)**  
Esteriors  
PACIFIC PORTLAND CEMENT COMPANY \*(4)  
Interiors—Metal Lath & Trim  
FORDERER CORNICE WORKS \*(14)

**PLASTER CEMENT (4)**  
PACIFIC PORTLAND CEMENT CO.  
San Francisco: 417 Montgomery St., GA 1-4100

**PLUMBING (18)**  
THE SCOTT COMPANY \*(8)  
THE HALSEY TAYLOR COMPANY  
Redlands, Calif.  
Warren, Ohio  
HAWES DRINKING FAUCET COMPANY  
Barkley 10: 1435 Fourth St., LA 5-3341  
CONTINENTAL WATER HEATER COMPANY  
Los Angeles 31: 1801 Pasadena Ave., CA 6178

## SIMONDS MACHINERY COMPANY

San Francisco: 816 Folsom St., DO 2-6794

Los Angeles: 455 East 4th St., MU 8322

## SECURITY VALVE COMPANY

Los Angeles 31: 410 San Fernando Rd., CA 6191

## REPUBLIC STEEL CORP.

San Francisco: 116 N. Montgomery St., GA 1-0977

Los Angeles: Edison Building

Seattle: White-Henry-Stuart Building

Salt Lake City: Walker Bank Building

Denver: Continental Oil Building

KRAFTILE COMPANY \*(1)

SAN JOSE STEEL COMPANY

San Jose: 195 North Thirtieth St., CO 4184

## WINDOWS STEEL (25)

DETROIT STEEL PRODUCTS CO. \*(20)

MICHEL &amp; PFEFFER IRON WORKS, INC. \*(5)

SOULE STEEL COMPANY \*(5)

## SEWER PIPE (19)

GLADDING, McBEAN &amp; CO. \*(1)

## PACIFIC CLAY PRODUCTS

San Francisco: 605 Market St., GA 1-3970

Los Angeles, Portland, Salt Lake City

## STEEL—REINFORCING (22)

REPUBLIC STEEL CORP. \*(21)

HERRICK IRON WORKS \*(21)

SAN JOSE STEEL CO. \*(21)

COLUMBIA STEEL CO. \*(21)

## GENERAL CONTRACTORS (26)

## BARRETT &amp; HILP

San Francisco: 918 Harrison St., DO 2-0700

Los Angeles: 234 W. 37th Place, AD 3-8161

## DINWIDDIE CONSTRUCTION COMPANY

San Francisco: Crocker Building, YU 6-2718

## CLINTON CONSTRUCTION COMPANY

San Francisco: 923 Folsom St., SU 1-3440

## MATTOCK CONSTRUCTION COMPANY

San Francisco: 604 Mission St., GA 1-5516

## PARKER, STEFFENS &amp; PEARCE

San Francisco: 135 So. Park, EX 2-6639

## STOLTE, INC.

Oakland: 8451 San Leandro Blvd., TR 2-1064

## SWINERTON &amp; WALBERG COMPANY

San Francisco: 225 Bush St., GA 1-2980

Oakland: 1723 Webster St., HI 4-4322

Los Angeles, Sacramento, Denver

## P. J. WALKER COMPANY

San Francisco: 391 Sutter St., YU 6-5916

Los Angeles: 714 W. Olympic Blvd., RI 7-5521

## SHEET METAL (20)

## Windows

## DETROIT STEEL PRODUCTS COMPANY

Oakland 8: 1310 - 63rd St., OL 2-8826

San Francisco: Russ Building, DO 2-0890

MICHEL &amp; PFEFFER IRON WORKS, INC. \*(5)

SOULE STEEL COMPANY \*(5)

## TILE (23)

GLADDING, McBEAN &amp; CO. \*(1)

KRAFTILE COMPANY \*(1)

PACIFIC CLAY PRODUCTS

San Francisco: 605 Market St., GA 1-3970

Los Angeles, Portland, Salt Lake City

## TIMBER—REINFORCING (1)

## Trusses

WEYERHAEUSER SALES CO.

Tacoma, Wash.

St. Paul, Minn.

Newark, N. J.

Treated Timber

## Fire Doors

## DETROIT STEEL PRODUCTS COMPANY

## Skylights

## DETROIT STEEL PRODUCTS COMPANY

## STEEL—STRUCTURAL (21)

## COLUMBIA STEEL CO.

San Francisco: Russ Bldg., SU 1-2500

Los Angeles: 2087 E. Slauson, LA 1171

Portland: 2345 N. W. Nicolai, BE 7261

Seattle: 1331 3rd Ave. Bldg., MA 1972

Salt Lake City: Walker Bank Bldg., SL 3-6733

## HERRICK IRON WORKS

Oakland: 18th &amp; Campbell Sts., GL 1-1767

## JUDSON PACIFIC-MURPHY CORP.

Emeryville: 4300 Eastshore Highway, OL 3-1717

## J. H. BAXTER CO.

San Francisco 4: 333 Montgomery St., DO 2-3883

Los Angeles 13: 601 West Fifth St., MI 6294

## WALL TILE (24)

GLADDING, McBEAN &amp; CO. \*(1)

KRAFTILE COMPANY \*(1)

## TESTING LABORATORIES

## (ENGINEERS &amp; CHEMISTS) (27)

## ABBOT A. HANKS, INC.

San Francisco: 624 Sacramento St., GA 1-1697

## ROBERT W. HUNT COMPANY

San Francisco: 251 Kearny St., EX 2-4634

Los Angeles: 3050 E. Slauson, JE 9131

Chicago, New York, Pittsburgh

## PITTSBURGH TESTING LABORATORY

San Francisco: 651 Howard St., EX 2-1747

## BUILDING TRADES WAGE (JOB SITES) NORTHERN, CENTRAL AND SOUTHERN CALIFORNIA

ATTENTION: The following are the PREVAILING hourly rates of compensation being paid and in effect by employers by agreement between employees and their union; or as recognized and determined by the U. S. Department of Labor. (Revised to March 1, 1951.)

CRAFT	San Francisco	San Francisco	Alameda	Contra Costa	Fresno	Sacramento	San Joaquin	Santa Clara	Solano	Los Angeles	Los Bernardino	San Diego	Santa Barbara	Kern
	\$2.50	\$2.50	\$2.50	\$2.50	\$2.50	\$2.50	\$2.50	\$2.50	\$2.50	\$2.25	\$2.25	\$2.25	\$2.25	\$2.25
ASBESTOS WORKERS.....	2.53	2.53	2.53	2.53	2.53	2.53	2.53	2.53	2.53	2.25	2.25	2.25	2.25	2.25
BOILERMAKERS.....	3.25**	3.15*	3.15	3.15	2.85	3.25	3.00	3.25	3.25	2.625	2.625	2.625	2.625	2.625
BRICKLAYERS, HODCARRIERS.....	2.45	2.45	2.45	2.45	2.00	2.40	2.00	2.375	2.40	1.75	1.75	1.75	1.75	1.75
CARPENTERS.....	2.325	2.325	2.175	2.175	2.175	2.175	2.175	2.175	2.175	2.20	2.20	2.20	2.20	2.20
CEMENT FINISHERS.....	2.75	2.40	2.40	2.75	2.50	2.50	2.425	2.40	2.50	2.28	2.28	2.28	2.28	2.28
ELECTRICIANS.....	2.75	2.40	2.40	2.75	2.50	2.50	2.425	2.40	2.50	2.50	2.50	2.50	2.50	2.50
ELEVATOR CONSTRUCTORS.....	2.75	2.75	2.75	2.75	2.75	2.75	2.75	2.75	2.75	2.25	2.25	2.25	2.25	2.25
ENGINEERS: MATERIAL HOIST.....	2.19	2.19	2.19	2.19	2.19	2.19	2.19	2.19	2.19	1.9875	1.9875	1.9875	1.9875	1.9875
GLAZIERS.....	2.30	2.30	2.30	2.30	2.30	2.30	2.30	2.30	2.30	2.00	2.00	2.00	2.00	1.94
IRONWORKERS: ORNAMENTAL.....	2.425	2.425	2.425	2.425	2.425	2.425	2.425	2.425	2.425	2.255	2.255	2.255	2.255	2.255
REINF. RODMEN.....	2.375	2.375	2.375	2.375	2.375	2.375	2.375	2.375	2.375	2.28	2.28	2.28	2.28	2.28
STRUCTURAL.....	2.575	2.575	2.575	2.575	2.575	2.575	2.575	2.575	2.575	2.30	2.30	2.30	2.30	2.30
LABORERS: BUILDING.....	1.65	1.65	1.65	1.55	1.65	1.65	1.55	1.65	1.65	1.65	1.65	1.65	1.65	1.65
CONCRETE.....	1.65	1.65	1.65	1.55	1.65	1.65	1.55	1.65	1.65	1.65	1.65	1.65	1.65	1.65
LATHERS.....	3.00	3.00*	3.00*	2.75	2.875	2.75	3.00	2.8125	2.50	2.50	2.50	2.50	2.50	2.50
MARBLE SETTERS.....	2.60	2.60	2.60	2.60	2.60	2.60	2.60	2.60	2.60	2.25	2.25	2.25	2.25	2.25
MOSAIC & TERRAZZO.....	2.375	2.375	2.375	2.375	2.375	2.375	2.375	2.375	2.375	2.40	2.40	2.40	2.40	2.40
PAINTERS.....	2.45**	2.45	2.45	2.15	2.45	2.275	2.45	2.45	2.45	2.22	2.22	2.22	2.22	2.22
PILEDRIVERS.....	2.325	2.325	2.325	2.325	2.325	2.325	2.325	2.325	2.325	2.33	2.33	2.33	2.33	2.33
PLASTERERS.....	1.00	3.15*	3.15	2.75	3.00	3.00	3.125	3.00*	2.50	2.50	2.50	2.50	2.50	2.50
PLASTERERS, HODCARRIERS.....	2.60	2.80	2.80	2.50	2.40	2.50	2.75	2.50	2.15	2.25	2.20	2.20	2.20	2.20
PLUMBERS.....	2.625	2.625	2.625	2.625	2.625	2.625	2.625	2.625	2.625	2.50	2.50	2.50	2.50	2.50
ROOFERS.....	2.50	2.50	2.50	2.50	2.50	2.50	2.50	2.50	2.50	2.25	2.00	1.90	2.00	2.00
SHEET METAL WORKERS.....	2.3125	2.3125	2.3125	2.40	2.50	2.375	2.3125	2.375	2.15	2.15	2.175	2.00	2.15	2.15
SPRINKLER FITTERS.....	2.625	2.625	2.625	2.625	2.625	2.625	2.625	2.625	2.625	2.25	2.25	2.25	2.25	2.25
STEAMFITTERS.....	2.625	2.625	2.625	2.625	2.625	2.625	2.625	2.625	2.625	2.50	2.50	2.50	2.50	2.50
TRUCK DRIVERS—1/2 Ton or less.....	1.58	1.58	1.58	1.58	1.58	1.58	1.58	1.58	1.58	1.58	1.58	1.58	1.58	1.58
TILESETTERS.....	2.875	2.875	2.875	2.50	2.875	2.4325	2.875	2.875	2.875	2.50	2.50	2.20	2.50	2.25

\* 6 Hour Day. \*\* 7 Hour Day.

Prepared and compiled by:

CENTRAL CALIFORNIA CHAPTER, ASSOCIATED GENERAL CONTRACTORS OF AMERICA, with the assistance and cooperation of secretaries of General Contractors Associations and Builders Exchanges of Northern California; and the above information for southern California is furnished by the Labor Relations Department of the Southern California Chapter, ASSOCIATED GENERAL CONTRACTORS OF AMERICA.

## DON'T LIFT IT ALONE

(From Page 38)

ered by flat feet. Building workers, masons, carpenters, painters are on their feet for many hours. They may suffer from pain in foot and back, cramps in the calves, and burning sensations in the soles of the feet unless something is done to relieve the trouble.

The feet carry the weight of the whole body. Additional overweight in lifting loads presses the arches down. After repeated strain they stay down, flat feet have developed. An inborn tendency to flat feet is made worse by heavy lifting. Arch supports in one form or another may bring relief. Many working people have good results with this method. There are factory-made arch supports of different size and shape, and there are individually constructed arch supports. It is advisable to provide non-slip material for the floors in those areas where lifting operations are carried out.

### Causes of Hernia

If a building worker feels unfit to perform weight lifting operations, he better be careful. People are more prone to accidents and injuries due to muscular strain when they are indisposed. Lighter work should be provided for such occasions. Experienced building workers can do much good by demonstrating the correct methods of lifting.

A hernia or rupture is a protrusion of a loop of intestine through a weak spot on the muscle wall of the abdomen. This loop cannot be seen as it is covered with skin and fat. All that could be seen in the building worker whose injury we have described, was a small lump under the skin. Normally the belly muscles are one firm wall. But sometimes there are small gaps between the muscle fibers. Here the content of the belly may press forward in the groin or just below the groin on the thigh.

A violent exertion, a sudden strain, lifting or pushing a heavy load may enlarge the gap and cause a hernia. Whoever has a natural disposition to hernia should not overexert himself. Trusses are

not always sufficient to keep the hernia back. An operation may be necessary to restore full working capacity and efficiency to a man suffering from a hernia and who, being employed in the building and construction industry, cannot avoid lifting heavy loads.

### FIRST SYNTHETIC PHENOL PLANT ON PACIFIC COAST

T. S. Peterson, president of the Standard Oil Company of California, has announced his firm will construct a \$4,000,000 synthetic phenol production plant at the company's Richmond refinery.

The new plant will utilize a recently developed synthesis process in which neither sulphuric acid nor chlorine is used, both of which are presently classified as "scarce materials."

### ENGINEERS MEET WITH INDUSTRIALISTS

Over three hundred engineers and industrialists attended an all day conference on cooperative education at the Technological Institute, Northwestern University, recently.

Faculty members of more than twenty universities exchange ideas with representatives from industry on the cooperative plan as an integral part of engineering programs of colleges and universities.

Among those appearing on the program were: Harry L. Wells, vice-president and business manager of Northwestern University; C. R. Osborn, vice-president, General Motors Corp.; Ovid W. Eshbach, Dean of the Technological Institute; R. C. Disque, Dean of Engineering, Drexel Institute of Technology, Philadelphia; P. T. Heerwagen, Electromotive Division of General Motors Corp.; W. L. Johnson, vice-president, Bell & Howell Co.; and R. H. Russell, Director of Training, Fairbanks-Morse & Company.

The cooperative program was originated by Dr. Herman Schneider at the University of Cincinnati in 1906.

## CLASSIFIED ADVERTISING

RATE: 20c PER WORD . . . CASH WITH ORDER

MINIMUM \$5.00

**PLANNING CHURCH BUILDINGS.** Portfolio—64 oversized pages 144 cuts; floor plans, exterior and interior views; recently planned buildings costing \$30,000 upward. Largest collection plans of Protestant churches assembled. Price \$2.00 p.p. WRITE Bureau of Architecture, 300 Fourth Ave., New York 10, N. Y.

**GET THE BEST,** don't be satisfied with anything but the best. Window sash, Doors, Cabinets, etc. Town Talk Sash & Door Mill, 524 9th St., Sacramento.

**BUILDERS!** You can make more money; get information you need before it is published elsewhere; Subscribe to the daily ARCHITECTS REPORTS, only \$10.00 per month. Complete information from ARCHITECTS REPORTS, 68 Post Street, San Francisco. Phone DOuglas 2-8311.

**PHOTOGRAPHY.** For the best in construction photography, including exterior and interior, aerial, and progress views . . . you will find as many others have that it's the SKELTON STUDIO'S, 137 Harlan Place, San Francisco. Telephone YUkon 6-6321.

**WANTED:** Experienced specification writer and building estimator by San Francisco ARCHITECT. Write WE 1-6-c/o ARCHITECT & ENGINEER, 68 Post Street, S. F.

**FLOOR COVERINGS** for industrial, commercial, and residential construction. Complete lines, one of the oldest, best established organizations in the Sacramento Valley. LATTIN'S, INC., 1519 Alhambra Blvd., Sacramento.



## CONSTRUCTION CONTRACTS AWARDED AND MISCELLANEOUS PERSONNEL DATA

**SCHOOL BUILDING**, Scottsdale, Arizona. Maricopa County Board of Supervisors, owner, \$182,439. ARCHITECT: Lescher & Mahoney, Phoenix. GENERAL CONTRACTOR: Homes & Son Construction Co., Phoenix.

**PERMANENT FOUNDATION HOSPITAL**, Los Angeles, Los Angeles county. Permanent Foundation, owner, 210 beds, \$1,800,000. ARCHITECTS: Wolf & Phillips, Portland, 7 story, reinforced concrete hospital, rubber tile, steel sash. GENERAL CONTRACTOR: C. L. Peck, Los Angeles.

**STUCCO CHURCH BUILDING**, Redlands, Calif. First Baptist Church of Redlands, owner, \$180,000. ARCHITECT: Frederick Kennedy, Jr., Pasadena. GENERAL CONTRACTOR: L. P. Scherer, Redlands.

**SUNDAY SCHOOL BUILDING**, Modesto, Stanislaus county. First Baptist Church, owner, \$105,625. ARCHITECT: G. N. Hilburn, Modesto, 2 story, reinforced concrete or concrete block & frame construction. GENERAL CONTRACTOR: Albert C. Carroll, Modesto.

**HOSPITAL**, Newport Beach, Los Angeles County. Hoag Memorial Hospital Presbyterian, owner, 604 rooms, \$1,096,023. ARCHITECT: H. C. Chambers, Los Angeles, reinforced concrete & structural steel, 28½ x 354 sq. ft., tile & composition roof. GENERAL CONTRACTOR: Means & Ulrich, Santa Ana.

**HORACE CURETON GRAMMAR SCHOOL**, San Jose, Santa Clara County, Alum Rock Union District, owner, 18 classrooms, 2 kindergartens, administration, multi-purpose, kitchen & toilet rooms, \$404,672. ARCHITECT: Kress & Gobson, San Jose. GENERAL CONTRACTOR: Geo. J. Laufer, San Jose.

**OFFICE AND WAREHOUSE**, Vernon, Calif. Union Carbide & Carbon Corp., owner, 1 story office & warehouse, \$265,000. ARCHITECT: McLellan, MacDonald & Markwith, Los Angeles, panelcrete walls, 240x 230 ft., wood roof, composition roofing, steel sash, concrete floor, overhead doors, concrete loading dock, toilet rooms. GENERAL CONTRACTOR: Buttress & McClellan, Inc., Los Angeles.

**SAFETY STORE**, Santa Paula, Ventura County. Bramwell Construction Co., owner, \$356,800. STRUCTURAL ENGINEER: W. M. Bostack, South Gate, reinforced brick construction, 103x200 ft., curved wood trusses, composition roofing, plate glass, concrete floors, toilets. GENERAL CONTRACTORS: Barrington & Botke, Santa Paula.

**PAPER PROCESSING PLANT**, San Leandro, Alameda County. Crown Zellerbach Corp., owner, office, factory & warehouse, \$2,000,000. ARCHITECT: Albert C. Martin & Assoc., Los Angeles, 1 story, 300,000 sq. ft., reinforced concrete & structural steel & transite construction. GENERAL CONTRACTOR: Swinerton & Walberg, Oakland.

**CIPRANI GRAMMAR SCHOOL**, Belmont, San Mateo County. Belmont Elementary School District, owner, 6 classrooms, kindergarten, office & toilet rooms, \$207,100. ARCHITECT: Panstrud & Price, Oakland, frame & stucco construction, some concrete block. GENERAL CONTRACTOR: Wilfred H. May, Belmont.

**AUTO SALES & SERVICE BUILDING**, Los Angeles, Los Angeles County. Geo. W. Vaughan, owner, auto sales & 2 service buildings, \$100,000. ARCHITECT: Paul O. Davis, Los Angeles. STRUCTURAL ENGINEER: Brandow & Johnston, Los Angeles, cement block & brick construction, structural steel reinforcing, composition roofing, cement & asphalt tile floors, steel sash, tile toilets, plate glass, glass doors. GENERAL CONTRACTOR: C. L. Peck, Los Angeles.

**SIX STUCCO DWELLINGS**, Ventura, Ventura County. Janss Investment Corp., owner, \$82,840. ARCHITECT: Kenneth H. Hess, Ventura, 6 rooms, shake roof, 1700 sq. ft. GENERAL CONTRACTOR: Trent Meredith, Oxnard.

**PARK VIEW SCHOOL**, Lancaster, Los Angeles County. Lancaster Elementary School District, owner, 9 classrooms, kindergarten, shop, homemaking, arts & crafts & science rooms, \$514,942. ARCHITECT: H. L. Gogerty, Los Angeles, reinforced concrete construction, structural steel work, composition roofing, insulation, cement & asphalt tile floors, metal lath partitions. GENERAL CONTRACTOR: C. E. DeWitt, San Fernando.

**PARK MEAD ELEMENTARY SCHOOL ADDITION**, Walnut Creek, Contra Costa County. Walnut Creek Elementary School District, owner, 10 classrooms, administration, library, nursery room, kitchen, multi-purpose & toilet rooms, \$334,900. ARCHITECT: Schmidts & Hordman, Berkeley, frame & stucco construction. GENERAL CONTRACTOR: Frank Payne & Son, Orinda.

**POLICE STATION & FIRE STATION**, Mt. View, Santa Clara County. City of Mt. View, owner, 1 story & 2 story, \$157,709. ARCHITECT: Higgin & Root, San Jose, reinforced concrete & frame construction. GENERAL CONTRACTOR: Morris Daley (Police Station), Burlingame; Lew Jones Construction Co., San Jose (Fire Station).

**SHOWROOM & GARAGE ADDITION & REMODEL**, Palo Alto, Santa Clara County. Geo. S. Raddlerford, owner, \$162,000. ARCHITECT: Harold S. Ahnfeldt, Palo Alto, 1 story, reinforced concrete & brick construction, wood roof trusses, plate glass front. GENERAL CONTRACTOR: E. A. Hathaway & Co., San Jose.

**ELEMENTARY SCHOOL**, Pinedale, Fresno County. Pinedale Elementary School District, owner, 18 classrooms, 2 kindergartens, administration & toilet rooms, \$496,859. ARCHITECT: Swartz & Hyberg, Fresno, frame & stucco construction. GENERAL CONTRACTOR: Lewis C. Nelson, Selma.

**ANDREW WILLIAMS MARKET**, Concord, Contra Costa County. ENGINEER: R. H.

Cooley, Oakland, 1 story, 125x185, concrete block & wood roof trusses. GENERAL CONTRACTOR: John J. Moore Co., Oakland.

**TEMPORARY BUILDINGS**, Martinez, Contra Costa County. Contra Costa Junior College, owner, 10 prefabricated buildings, \$126,178. ARCHITECT: Jake Buchter, Orinda, erecting & completing, 10 prefabricated buildings furnished by the district. GENERAL CONTRACTOR: Robert L. Wilson, San Francisco.

**OFFICE BUILDING**, Santa Barbara, Santa Barbara County. Title Insurance & Trust Co., owner, 1 story & basement office building, \$200,000. ARCHITECT: Parkinson, Powelson, Briney, Bernard & Woodford, Los Angeles, reinforced concrete construction, 62x109, masonry work, tile & composition roof, wood roof construction, structural steel work, steel sash, concrete & asphalt tile floors. GENERAL CONTRACTOR: P. J. Walker Co., Los Angeles.

**OFFICE DRUG STORE & MARKET BUILDING**, Los Angeles, Los Angeles County. Thrifty Drug Stores Co., owner, 1 story & mezzanine, \$1,000,000. ARCHITECT: Albert C. Martin & Assoc., Los Angeles, reinforced concrete & brick office, 105,000 sq. ft., concrete & wood truss roof construction, steel sash, concrete floor, asphalt tile. GENERAL CONTRACTOR: Wm. Simpson Construction Co., Los Angeles.

**RECTORY**, San Carlos, San Mateo County. Roman Catholic Archbishop of San Francisco, owner, St. Charles Parish, \$89,950. ARCHITECT: Blanchard & Maher, San Francisco, 2 story, frame & stucco construction. GENERAL CONTRACTOR: Carrico & Gauthier, San Francisco.

**HOSPITAL BUILDING**, Fresno, Fresno County. Valley Childrens Hospital Assoc., owner; child guidance clinic building, 40 beds, \$496,822. ARCHITECT: Wm. Hostrup, Fresno. Reinforced concrete construction, 18,900 sq. ft. Frame & Stucco construction. GENERAL CONTRACTOR: Harris Construction Co., Fresno.

**OFFICE BUILDING**, Provo, Utah. Pacific States Cast Iron Pipe Co., owner, 1 story, \$500,000. ENGINEER: E. L. Allen, Irwin, Utah. Reinforced brick construction, 20,500 sq. ft. GENERAL CONTRACTOR: Ryberg and Garff, Salt Lake City.

**CARMEL PLAYHOUSE THEATRE**, Carmel, Monterey County. Carmel Playhouse Inc., owner; \$93,000. DRAFTSMAN: Hugh W. Comstock Assoc., Carmel. Reinforced concrete, concrete block, structural steel construction. Laminated wood arches. GENERAL CONTRACTOR: Carmel Construction Co., Carmel.

**MARKET BUILDING**, Mountain View, Santa Clara County. ARCHITECT: Donnell E. Jaekle, San Jose, 1 story, 120x170, reinforced concrete construction, wood roof, trusses, plate glass front. GENERAL CONTRACTOR: Lew Jones Construction Co., San Jose.

**CHRISTIAN SCIENCE CHURCH**, Los Angeles, Los Angeles County. Fourteenth Church of Christ Scientist, owner; church building, \$125,000. ARCHITECT: Paul R. Hunter, Los Angeles. Frame & Stucco construction, shingle tile roofing, cement slab floor, asphalt tile, steel and wood sash. GENERAL CONTRACTOR: Don S. Ely, Los Angeles.

**PRINTING PLANT**, Sacramento, Sacramento County. State of California, owner; pressroom, bindery, composing room, office and warehouse, \$333,253. ARCHITECT: Wurster, Bernard & Emmons, San Francisco. STRUCTURAL ENGINEER: A. V. Saff, San Francisco. 1 story and part mezzanine, steel frame construction. CONTRACTOR: (Steel) Bethlehem Pacific Steel Corp.

## PANACALITE

The Standard for Perlite Aggregates  
An Engineered Product—Engineering  
Service

Air Classified—Sized & Graded for  
Plaster, Concrete & Stucco  
Aggregates

Listed Underwriters' Laboratories  
Re-examination Service

Fire Ratings:  
Non-Bearing Walls—2 hours  
Floor and Beam—4 hours  
Columns—2 & 3 hours  
Suspended Ceiling—4 hours  
Others

Manufactured by

**American Perlite Corporation**  
26th & B Sts.—Yard 2—Richmond  
Beacon 5-1385



**HOSPITAL BUILDING.** San Pablo, Contra Costa County, West Contra Costa Hospital, Richmond, owner, 100 beds, \$2,884,178. ARCHITECT: D. D. Stone & Loy Mulloy, San Francisco, 4-story and basement, reinforced concrete, steel sash, 3-elevators, asphalt tile and terrazo floors. CONTRACTOR: Parker, Steffens & Pearce, San Francisco.

**RETAIL STORE BUILDING.** San Francisco, San Francisco County, Stoneson Development Corp., owner, 1-story, class II, reinforced concrete and frame construction, \$225,000. ARCHITECT: Welton Becket, Los Angeles. GENERAL CONTRACTOR: MacDonald, Young & Nelson, San Francisco.

**56 RESIDENCES.** Van Nuys, Los Angeles County, Geo. J. Heltzer, owner. Wood frame dwellings, \$1,160,000. ENGINEER: W. G. Chandler, Los Angeles. Stucco and siding exterior, wood shingle roofing, cement and hardwood floors, gas wall heaters, tile baths and drainboards, cabinet work, sheet metal, electrical work, and garages.

**MARKET BUILDING.** San Jose, Santa Clara County, Derrera Bros., owner, 1-story, \$78,433. DRAFTSMAN: Vincent Arena, San Jose. Concrete and wood construction with wood roof trusses. CONTRACTOR: Kelly Seger, San Jose.

**PALMYRA SCHOOL.** Garden Grove, Orange County, Orange Elementary School District, owner, 8-Classroom, kindergarten and administration unit, \$240,000. ARCHITECT: Paul O. Davis, Los Angeles. Frame and stucco construction, composition roofing, cement and asphalt tile floors, structural steel, steel sash, heating and ventilating. CONTRACTOR: C. W. Devare, Garden Grove.

**WAREHOUSE BUILDING.** San Jose, Santa Clara County, Calif. Prune Growers Association, owners, 1-story, reinforced concrete, wood roof trusses, \$206,000. ARCHITECT: Donnell E. Jockle, San Jose. CONTRACTOR: Lew Jones Construction Co., San Jose.

**WAREHOUSE AND SHOP BUILDING.** Signal Hill, Los Angeles County, Associated Telephone Co., Long Beach, owner. Metal frame and stucco, \$450,000. ENGINEER: Maurice Sasso, Los Angeles. CONTRACTOR: Contracting Engineers, Los Angeles.

**SHOPPING CENTER.** Greenbrae, Marin County, Schultz Co., Greenbrae, owner. Super market and four stores, \$181,000. ARCHITECT: Gruen & Krummeck, Los Angeles. 1-story containing 20,200 sq. ft.

**APARTMENT BUILDING.** Las Vegas, Nevada, 2-story, 100-room concrete block apartment building on Highway 91, \$350,000. CONTRACTOR: Mecham Construction Co., Las Vegas.

**ELEMENTARY SCHOOL.** Aromas, Monterey County, Aromas Union Elementary School District, owner, 6-classroom, administration, teachers rooms, multi-purpose, kitchen, toilet rooms, \$193,659. ARCHITECT: Schmidts & Hardman, Berkeley. Prefabricated frame construction, plaster and brick veneer. CONTRACTOR: G. W. Davis, Watsonville.

**FIRE STATION.** Santa Ana, Orange County, City of Santa Ana, owner, Three story reinforced concrete, 18,500 sq. ft., steel sash, steel door frames, composition roof, fluorescent lighting, automatic sliding doors, hot water heating, forced air ventilation, \$286,750. ARCHITECT, Associated Architects (Everett E. Parks & Gates W. Burrows), Santa Ana. CONTRACTOR, South Coast Construction Co., Newport Beach.

**STORE BUILDING.** San Jose, Santa Clara County, Dr. M. Lifschitz, owner, 1-story, reinforced concrete and frame construction, \$42,145. ARCHITECT: Leonard Tivol, San

Francisco. CONTRACTOR: Herman H. Friedman, San Francisco.

**ROSES ROAD SCHOOL.** San Gabriel, Los Angeles County, San Gabriel School District, owner, 1-story, frame and stucco, administration unit, kindergarten, 3-classrooms, utility rooms, and multi-purpose building, \$456,930. ARCHITECT: Kistner, Curtis & Wright, Los Angeles. CONTRACTOR: Crown Construction Co., Los Angeles.

**HIGH SCHOOL ADDITION.** Turlock, Stanislaus County, Turlock High School District, owner, 3-classrooms, home making building, frame and stucco construction, \$124,813. ARCHITECT: Mayo & Johnson, Stockton. CONTRACTOR: R. M. Carter, Turlock.

**PARISH HALL.** Stockton, San Joaquin County, Roman Catholic Archbishop, San Francisco, owner, 1-story reinforced concrete and frame construction, \$153,751. ARCHITECT: Willam Smith, San Francisco. CONTRACTOR: Nomellini Construction Co., Stockton.

**ELEMENTARY SCHOOL ADDITION.** Hanford, Kings County, Hanford Elementary School District, owner, 4-classroom, kindergarten, multi-purpose, kitchen, frame and stucco construction, steel sash, radiant heating, \$165,443. ARCHITECT: Horn & Morland, Fresno. CONTRACTOR: Midstate Construction Co., Fresno.

**OFFICE BUILDING.** Palo Alto, Santa Clara County, Sequia Insurance Co., San Jose, owner, 1-story, frame and stucco construction, \$50,000. ARCHITECT: Ralph Wyckoff, San Jose. CONTRACTOR: B. E. & C. J. Tamey, San Jose.

**CHURCH AND SUNDAY SCHOOL.** Redwood City, San Mateo County, St. Peter's Episcopal Church, Redwood City, owner.

Concrete and frame construction, \$100,000. ARCHITECT: Kingsford Jones, Menlo Park. CONTRACTOR: Howard J. White, Inc., Palo Alto.

**LAS LOMAS HIGH SCHOOL.** Walnut Creek, Contra Costa County, Acalanes Union High School District, Lafayette, owner, Administration unit, library, 4-classrooms, and site development including boys athletic field, grading and sprinkler system, \$189,580. ARCHITECT: Kump & Associates, San Francisco. CONTRACTOR: Wm. Horstmeier (Buildings) San Francisco, and A. F. Stewart (Site Development) Berkeley.

**APARTMENT BUILDING REMODEL.** Oakland, Alameda County, Clement & Eugenia Arnaud, Oakland, owner. Rebuilt as result of recent fire, \$100,000. CONTRACTOR: Louis Rubenstein, Oakland.

**MILLES GRAMMAR SCHOOL.** Benicia, Solano County, Benicia Unified School District, owner, 11-classrooms, offices, and toilet rooms, frame and stucco construction, \$307,000. ARCHITECT: Geo. C. Sellon, Sacramento. CONTRACTOR: A. F. Stewart, Berkeley.

**MEDICAL BUILDING ADDITION.** Richmond, Contra Costa County, Richmond Medical Center, Oakland, owner, 1-story frame and stucco construction, \$42,000. DRAFTSMAN: Wm. L. Duquette, Richmond, CONTRACTOR: Carl Overea & Co., Richmond.

**PITTSBURG HEIGHTS SCHOOL.** Pittsburg, Contra Costa County, Pittsburg Unified School District, Pittsburg, owner, 10-classrooms, administration unit, 2-kindergartens, library, toilets, concrete and frame construction, \$453,894. ARCHITECT: A. A. & A. McK. Canin, San Francisco. CONTRACTOR: California Builders Co., Oakland.

## Why built-in conduits and extra outlets win client satisfaction



Owners of new homes often need telephone extensions later on...in a bedroom, den or kitchen. When you plan built-in conduit and extra outlets for popular rooms, you're giving a service your client will appreciate. Then he can add extensions and not mar beauty of interiors through exposed wiring.

It's inexpensive to install facilities for concealed wiring during construction...the price of a few pieces of tubing. And your client's needs will be taken care of-for now and the future. For free help in planning, call your local Pacific Telephone office today and ask for "Architects and Builders Service."

Put built-in telephone facilities in your plans



Pacific Telephone

## IN THE NEWS

### SCHOOL BONDS ARE VOTED IN PLACERVILLE

Voters of the Placerville Union Elementary School District have approved the issuance of bonds for the construction of a new Grammar School in Placerville.

Raymond R. Franceschi, of Sacramento, is the architect.

### SOAP FACTORY FOR SACRAMENTO

Neil H. McElroy, president of the Procter & Gamble Manufacturing Company, announces his firm has been granted a N. P. A. permit for the construction of a new soap factory building in Sacramento at a cost of \$2,689,980.

The construction will consist of a six story processing building, a two story production building and a single story warehouse.

### WORK AWARDED AT ATASCADERO

The State of California, Division of Architecture, has awarded some \$9,476,647 in contracts for new construction at the Atascadero State Hospital in San Luis Obispo county.

The work consists of plumbing, heating, air conditioning, refrigeration, and electrical work.

### SLIGHT RISE IN BUILDING COSTS

Frank W. Cortright, vice-president of the

National Association of Home Builders, Washington, D. C., predicts that home building costs will rise at least 5% next year.

Higher prices for steel, transportation, fuel, and building labor will reflect higher construction costs, is the opinion of Cortright.

### STAU APPOINTED SALES MANAGER

E. H. Stau, of New Brighton, Pa., and formerly general manager of the Cherry River Company, has been appointed Sales Manager of a newly created Pacific Division of the Townsend Company.

He will have charge of the company's operations in the thirteen Pacific Slope states, as well as supervise construction of the firm's new manufacturing plant which is being erected on a 15-acre tract near Santa Ana, California.

### ARCHITECT SELECTED

Architects Bolton White and Jack Hermann of San Francisco, have been selected by the First Congregational Church of Palo Alto to draft plans for the construction of a new Church and Sunday School in Palo Alto.

The new church is to be built at the corner of Embarcadero and Louri Road.

### LIERD E. GRANT APPOINTED LOS ANGELES BRANCH MGR.

Lierd E. Grant has been appointed manager of the Los Angeles branch of the Howe Scale Company, according to Richard F. Straw, vice president in charge of sales.

Grant will supervise sales and service activities in southern California, Arizona, western New Mexico, and the El Paso region of Texas. He will also continue as manager of the San Francisco branch of which William J. Tukey has just been named Assistant Branch Manager.

### ATTEND HOME BUILDERS MEET

Milton J. Brock, president of the Los Angeles Home Builders Institute; Fritz B. Burns, Arthur A. Bellevue, Al Burgbacher, F. E. Cooney, and K. Sande Semmes, directors, attended a recent meeting of the National Association of Home Builders in Atlantic City.

Leading representatives of all segments of the housing industry as well as top government officials from Washington were present, to consider current problems of mortgage, finance, credit controls, supply and distribution of critical materials.

### ARCHITECT SELECTED

Architect John Lyon Reid, A.I.A., San Francisco has been commissioned by the San Mateo Union High School District to design a new High School for the Hillside District of San Mateo.

The new school which is to be located on the Alameda de las Pulgas will cost \$4,000,000.

### SCHOOL BONDS ARE APPROVED

Voters of Modesto recently approved a school bond issue of \$1,000,000 with funds to be used in making much needed additions to seven elementary schools throughout the city.

Some 35-class rooms will be added to the present schools with designs being

supervised by the architectural firm of Swartz & Hyberg, A.I.A., of Fresno.

### RE-ELECTED CHAIRMAN HOUSING AUTHORITY

Nicola Giulit, chairman of the Los Angeles City Housing Commission has been re-elected chairman for the ensuing year and will serve his fourteenth year on the Commission.

Giulit recently returned from an extended trip to Europe where he studied the reconstruction of war devastated areas.

Commissioner Lloyd Mashburn was re-elected to his seventh term as Vice-Chairman.

### SEMI-HEAVY DUTY LOCKS

Designed to meet the specific need in industrial and residential fields where a semi-heavy duty lock will do the job of an expensive heavy-duty unit, the new "Chalender 800" series introduced by Hollymaded Hardware Mfg. Co. of Los Angeles, has met the approval of critics attending the recent Chicago Hardware Convention.

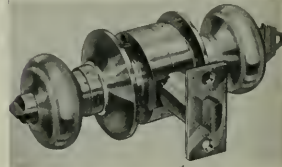

The complete Hollymaded line comprises 19 functional latch-sets and lock-sets, with the newest item representing a lifetime, non-rustable aluminum housing, encasing steel retractor housing, 16-gauge steel ribbed release cam, 16-gauge heavy steel sleeve spindle and a 12-gauge heavy steel retractor.

### ARCHITECT SELECTED

The architectural firm of Mayo & Johnson of Stockton has been selected by the Stockton Board of Education to draw plans for a new West Side High School to be constructed at a cost of \$1,800,000.

### NEW HOMES CONCRETE CONFERENCE

In cooperation with the Los Angeles Chapter, General Contractors of America, the Portland Cement Association and southern California members of the American Concrete Institute, and the University of California Extension, engineering division, a conference on practical concrete problems was held in Los Angeles recently.

Among those appearing on the program were: M. Erick, consulting engineer; C. A. McMahon, construction superintendent; J. T. Helseley, concrete technologist; C. D. Walls, contractor; and S. Hobbs, field engineer, Portland Cement Association; and J. W. Kelly, professor of civil engineering, University of California at Berkeley.

### POWERS ELECTED HOME SHOW PRESIDENT

J. A. Powers has been elected president of the Construction Industries Exposition and Home Show which will be held in Los Angeles during 1952. He succeeds Earl T. Heitschmidt, A.I.A., Architect, member of the California State Board of Architectural

## ACOUSTI CELOTEX

Sound Conditioning  
... combines the  
correct materials and  
25 years experience  
in every type, size  
and technique of  
acoustical installation

Acoustical Contractors

## WESTERN ASBESTOS COMPANY

San Francisco: 675 Townsend, KL 2-3668  
Oakland: 251 Fifth Avenue, GL 1-2345  
Sacramento: 1224 Eye Street, GI 2-8991  
Sacramento: 733 So. Van Buren St., 4-1863  
Fresno: 434 "P" Street, 2-1600  
San Jose: 460 Park Avenue, CY 3-1317

**STATIONERY  
SCHOOL & OFFICE  
SUPPLIES**

•  
**Printing Engraving  
Announcements**

•  
**CENTER STATIONERY**

**468 McAllister  
San Francisco UN 1-3703**

**MULLEN MFG.  
COMPANY**

—  
**BANK, STORE AND OFFICE  
FIXTURES—CABINET WORK  
OF GUARANTEED QUALITY  
CHURCH SEATING**

—  
**Office and Factory  
60-80 RAUSCH ST., 8th, 7th and 8th Sts.  
San Francisco  
Telephone UNderhill 1-5815**

**Thinking of Building?**

From our cost records and experience, an advance estimate may be made from decidedly general information. Based on our knowledge of labor and material costs, gained on current jobs, such an estimate may be helpful in determining your construction program.

**ALL TYPES CONSTRUCTION  
SAN FRANCISCO - SACRAMENTO  
SWINERTON & WALBERG CO.  
OAKLAND - LOS ANGELES - DENVER**

*Fine*  
**ENGRAVINGS**



**POOR  
RICHARD**

**PHOTO ENGRAVING CO.**  
320-324 COMMERCIAL STREET  
SAN FRANCISCO, 13

Examiners, under whose direction the event was accorded the "outstanding achievement" award of the Los Angeles Chamber of Commerce.

Powers, recently appointed a member of the LA Building and Safety Commission, is head of the J. A. Powers Mason Contractors Company and has served as a member of the Home Show Board of Directors for six years.

Others elected to the new Board included Frank Hess, Vern R. Huck, Dale J. Missimer, Donald E. Reed, Howard Dyer, and Joe Herman.

**OPENS TUCSON  
OFFICES**

The Gates Company of Los Angeles has recently opened offices in Tucson, Arizona, where assistance will be given in site development, basic planning, building, interior decorating and landscaping.

Frederick Gates, designer and builder, and Annette Gates, decorator and landscape consultant, comprise the firm.

**STATEMENT OF THE OWNERSHIP, MANAGEMENT, AND CIRCULATION REQUIRED BY THE ACT OF CONGRESS OF AUGUST 24, 1912, AS AMENDED BY THE ACTS OF MARCH 3, 1933, AND JULY 2, 1946 (Title 39, United States Code, Section 233)**

Of Architect and Engineer, published monthly at San Francisco, Calif., for Oct. 1, 1951.

1. The names and addresses of the publisher, editor, managing editor, and business managers are:

Publisher, The Architect and Engineer, 68 Post St., San Francisco, Calif.

Editor, Edwin H. Wilder, 68 Post St., San Francisco, Calif.

Managing Editor, None.

Business Manager, L. B. Penhorwood, 68 Post St., San Francisco, Calif.

2. The owner is: (If owned by a corporation, its name and address must be stated and also immediately thereunder the names and addresses of stockholders owning or holding 1 per cent or more of total amount of stock. If not owned by a corporation, the names and addresses of the individual owners must be given. If owned by a partnership or other unincorporated firm, its name and address, as well as that of each individual member, must be given.)

The Architect and Engineer, Inc., 68 Post St., San Francisco, Calif.

K. P. Kierulff, 68 Post St., San Francisco, Calif.

E. N. Kierulff, 68 Post St., San Francisco, Calif.

L. B. Penhorwood, 68 Post St., San Francisco, Calif.

F. W. Jones, 1153 McKinley Ave., Oakland, Calif.

V. S. Yallop, 68 Post St., San Francisco, Calif.

E. J. Cardinal, 942 Howard St., San Francisco, Calif.

Sewall Smith, Lafayette, Calif.

3. The known bondholders, mortgagees, and other security holders owning or holding 1 per cent or more of total amount of bonds, mortgages, or other securities are: (If there are none, so state.)

None.

4. Paragraphs 2 and 3 include, in cases where the stockholder or security holder appears upon the books of the company as trustee or in any other fiduciary relation, the name of the person or corporation for whom such trustee is acting; also the statements in the two paragraphs show the affiant's full knowledge and belief as to the circumstances and conditions under which stockholders and security holders who do not appear upon the books of the company as trustees hold stock and securities in a capacity other than that of a bona fide owner.

5. The average number of copies of each issue of this publication sold or distributed, through the mails or otherwise, to paid subscribers during the 12 months preceding the date shown above was: (This information is required from daily, weekly, semiweekly, and triweekly newspapers only.)

L. B. Penhorwood, Business Mgr.

Sworn to and subscribed before me this 18th day of September, 1951.

IRENE CRESPI  
Notary Public in and for the City and County of San Francisco, State of California.

(My commission expires Jan. 3, 1955)

Phone GARfield 1-1164

**Thomas B. Hunter**

**DESIGNER OF HEATING**

**AIR CONDITIONING  
VENTILATING AND WIRING  
SYSTEMS, MECHANICAL  
AND ELECTRICAL EQUIP-  
MENT OF BUILDINGS**



**41 SUTTER STREET  
ROOM 710**

San Francisco

California

**Subscribe  
Now —**

**ARCHITECT  
and  
ENGINEER**

**\$3.00  
Per Year**

**DINWIDDIE  
CONSTRUCTION  
COMPANY**

•  
**BUILDERS**

•  
CROCKER BUILDING  
SAN FRANCISCO



**HERRICK  
IRON WORKS**

**STRUCTURAL STEEL  
REINFORCING STEEL**

1878 AND CAMPBELL STS.

OAKLAND, CALIF.

Phone GLencourt 1-1767

# STOLTE INC.

*General Contractors*



**OAKLAND • CALIFORNIA**

## PITTSBURGH TESTING LABORATORY

**ENGINEERS AND CHEMISTS**

Testing and Inspection of Concrete,  
Steel and Other Structural Materials

Design of Concrete Mixes

Offices in all principal cities

651 Howard St., San Francisco 5  
EXbrook 2-1747

## MATTOCK CONSTRUCTION COMPANY



**BUILDERS**



604 MISSION STREET  
SAN FRANCISCO

Subscribe  
Now —

**ARCHITECT  
and  
ENGINEER**

**\$3.00  
Per Year**

## Index to Advertisers

AMERICAN Perlite Corpn.....	44
ANGIER Pacific Corp.....	35
ARCHITECTS Reports .....	38
BARRETT & HILP, Contractors.....	35
CALIFORNIA Metal Enameling Co..	1
CLASSIFIED Advertising .....	43
CENTER Stationery .....	47
CLAY Brick & Tile Association.....	7
CLINTON Construction Company.....	36
DINWIDDIE Construction Co.....	47
ELECTROMODE Corpn. ....	*
FULLER, W. P. Co.....	*
FORDERER Cornice Works.....	35
GLADDING McBean & Company.....	*
GREENBERG'S, M. Sons.....	*
HANKS, Inc., Abbott A.....	48
HAWS Drinking Faucet Co.....	28-29
HERRICK Iron Works.....	47
HILLYARD Chemical Co.....	*
HOGAN Lumber Co.....	36
HUNT, Robert W., Company.....	48
HUNTER, Thos. B.....	47
JOHNSON, S. T. Co.....	*
JUDSON, Pacific-Murphy Corp.....	36
KRAFTILE Company .....	26
MARBLE Institute of America.....	2
MATTOCK Construction Co.....	48
MICHEL & Piefier Iron Works.....	*
MULLEN Mfg. Co.....	47
PACIFIC Clay Products Co.....	*
PACIFIC Manufacturing Co.....	37
PACIFIC Portland Cement Company .....	Back Cover
PACIFIC Telephone & Telegraph Co.	45
PARKER, Steffens & Pearce.....	6 and 35
PITTSBURGH Testing Laboratory.....	48
POOR Richard Engraving Co.....	47
PORCELAIN Enamel (Architectural Division) Publicity Bureau.....	Inside Front Cover
REMILLARD-Dandini Co. ....	48
REPUBLIC Steel Corporation.....	37
SIMONDS Machinery Company.....	37
SISALKRAFT Company .....	36
SMOOTH-Holtman, Company .....	33
SOTO, Henry C., Corpn., Landscape Engineers .....	33
STANLEY Works, The.....	25
STOLTE, Inc. ....	48
SUPERIOR Fireplace Co.....	*
SWINERTON & Walberg Co.....	47
U. S. Bonds.....	5
UTILITY Appliances Corp'n.....	34
VERMONT Marble Company.....	37
WEST Coast Screen Co.....	31
WESTERN Asbestos Company.....	46

\*Indicates Alternate Months

## REMILLARD-DANDINI Co.

**Brick and  
Masonry Products**



400 MONTGOMERY STREET  
SAN FRANCISCO, CALIF.

## Scott Company

**HEATING • PLUMBING  
REFRIGERATION**



**San Francisco  
Oakland  
San Jose  
Los Angeles**

## ABBOT A. HANKS, INC. Engineers & Chemists

INSPECTING — TESTING — CONSULTING  
CONCRETE • STEEL • MATERIALS  
CHEMICAL AND TESTING  
LABORATORIES  
• RESEARCH AND INVESTIGATION •

TESTS OF STRUCTURAL MATERIALS  
DESIGN OF CONCRETE MIXES  
SHOP AND ERECTION INSPECTION OF  
STRUCTURES AND EQUIPMENT  
INVESTIGATION OF STRUCTURES  
AND MATERIALS  
TESTS AND INVESTIGATION OF  
FOUNDATION SOILS  
FIRE RESISTANCE AND INSULATION  
TESTS

624 Sacramento Street, San Francisco

## ROBERT W. HUNT CO.

**ENGINEERS  
INSPECTING TESTING**

**STRUCTURAL MATERIALS  
CONCRETE MIX DESIGN  
CHEMICAL ANALYSIS  
EQUIPMENT**

PRINCIPAL CITIES  
UNITED STATES • EUROPE  
SAN FRANCISCO LOS ANGELES  
PORTLAND SEATTLE



# ARCHITECT AND ENGINEER



DECEMBER

1951

# Medal of Honor



Sergeant Travis Watkins,  
Gladeview, Tex.—Medal of Honor

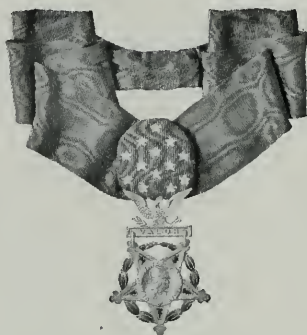

Private First Class Melvin Brown,  
Mahaffey, Pa.—Medal of Honor

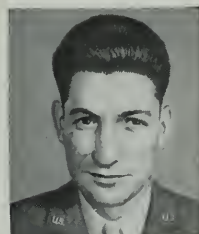

Lieutenant Frederick Hears,  
Clinton, Okla.—Medal of Honor



Major General William F. Dean,  
Berkeley, Calif.—Medal of Honor



Sergeant Charles Tutner,  
Boston, Mass.—Medal of Honor

This is the season when you think of stars. The one over Bethlehem. The ones on Christmas trees.

But this year remember another star, too—the one on the Medal of Honor. And make a place in your heart for the brave, good men who've won it. Men who, oftener than not, made the final, greatest sacrifice—so that the stars on your Christmas tree, and the stars in your country's flag, might forever shine undimmed.

Right now—today—is the time to do something

important for these men who died for you.

You can, by helping to defend the country they defended so far "above and beyond the call of duty."

One of the best ways you can make defense your job, too, is to buy more . . . and more . . . and more United States Defense Bonds. For your bonds help strengthen America. And if you make this nation strong enough you'll create, and keep, the peace for which men died.

*Buy Defense Bonds through the Payroll Savings Plan where you work or the Bond-A-Month Plan where you bank. Start today!*

## Peace is for the strong...Buy U. S. Defense Bonds



*The U. S. Government does not pay for this advertisement. It is donated by this publication in cooperation with the Advertising Council and the Magazine Publishers of America as a public service.*

# ARCHITECT

Vol. 187

No. 3

AND

# ENGINEER

ARCHITECTS' REPORTS—Published Daily

**EDWIN H. WILDER**  
Editor

**MARK DANIELS, A.I.A.**  
Associate Editor

**J. WELLS HASTINGS**  
Contributing Editor

**PROF. LELAND VAUGHAN**  
Landscape Architecture

**JOHN A. BLUME**  
Structural Engineering

**MICHAEL GOODMAN**  
Planning

**JOHN S. BOLLES, A.I.A.**  
Book Reviews



## COVER PICTURE

### CHRISTMAS

This Nativity medallion shows Joseph and Mary with the Christ Child (the letter identified by the tri-radiant nimbus used only with Our Lord).

The locale of the stable is shown by the animal heads.

*(This medallion was used in a window designed and executed by The Cummings Studios of San Francisco, and made available by them for publication here.)*

ARCHITECT & ENGINEER  
is indexed regularly by  
ENGINEERING INDEX, INC.

## Contents for

# DECEMBER

EDITORIAL NOTES . . . . .	3
JOINT INFORMATION COMMITTEE American Institute of Architects and The Producers' Council, Inc. . . . .	6
NEWS & COMMENT ON ART . . . . .	7
DEFENSE CONSTRUCTION IN ALASKA By GIL PEARSON, Technical Information Officer, Alaska District, Corps of Engineers, U. S. Army . . . . .	9
CLEARANCE OF BUILDINGS ADJACENT TO RAILROAD TRACKS By C. E. MILNE, Transportation Supervisor, California Public Utilities Commission . . . . .	9
YAKIMA'S NEW CITY HALL Is Model of Efficiency, Yakima, Washington . . . . . By ARTHUR W. PRIAULX JOHN W. MALONEY, Architect. JOHN SELLEN, Contractor . . . . .	10
UNITED GEOPHYSICAL COMPANY PLANT, Pasadena, California . . . . . ROLAND E. COATE, Architect. P. J. WALKER COMPANY, Contractor . . . . .	15
MID-WILSHIRE MEDICAL BUILDING, Beverly Hills, California . . . . . VICTOR GRUEN, Architect. WAALE-CAMPLAN COMPANY, Contractor . . . . .	16
WESTERN TIMBER RESOURCES ARE AMPLE FOR EXPANDED PRODUCTION . . . . .	21
A.I.A. ACTIVITIES . . . . .	24
WITH THE ENGINEERS . . . . .	26
PRODUCERS' COUNCIL PAGE Edited by CARL B. FRANK, Detroit Steel Products . . . . .	28
BOOK REVIEWS, Pamphlets and Catalogues . . . . .	34
ESTIMATOR'S GUIDE, Building and Construction Materials . . . . .	37
ESTIMATOR'S DIRECTORY, Building and Construction Materials . . . . .	39
BUILDING TRADES WAGE SCALES, Northern, Central & Southern California . . . . .	40
CLASSIFIED ADVERTISING . . . . .	41
CONSTRUCTION CONTRACTS AWARDED, General Data . . . . .	42
IN THE NEWS . . . . .	44
INDEX TO ADVERTISERS . . . . .	46
INDEX TO ARTICLES & ILLUSTRATIONS, Vol. 184 to 187, 1951 . . . . .	47

ARCHITECT AND ENGINEER (Established 1905) is published on the 15th of the month by The Architect and Engineer, Inc., 68 Post St., San Francisco 4; Telephone EXbrook 2-7182. President, K. P. Kierulff; Vice-President and Manager, L. B. Penhorwood; Treasurer, E. N. Kierulff.

Los Angeles Office: Wentworth F. Green, 439 So. Western Ave., Los Angeles 5; Telephone DUnkirk 7-8135.

Entered as second class matter, November 2, 1905, at the Post Office in San Francisco, California, under the Act of March 3, 1879. Subscriptions United States and Pan America, \$3.00 a year; \$5.00 two years; foreign countries \$5.00 a year; single copy 50c. ARCHITECTS' REPORTS are published daily from this office, Vernon S. Yallop, Manager. Telephone DOuglas 2-8311.





1951

He has not served who gathers gold,  
Nor has he served whose life is sold  
In selfish battles he has won,  
Or deeds of skill that he has done;  
But he has served who now and then  
Has helped along his fellowmen.

—*Author Unknown*

Season's  
Greetings





*One of a series of outstanding creations by Northern California Architects utilizing Colorful Clay Brick.*

*Appleton & Wolfard, A. I. A.*  
utilize **CLAY BRICK**  
to achieve an  
**ARCHITECTURAL**  
**MASTERPIECE**



*SAN FRANCISCO'S PARKSIDE LIBRARY*  
*acclaimed for Inspiring Atmosphere . . . . Functional Perfection*

Simplicity combines with the colorful tones of Clay Brick to achieve the restful and dramatic effect desired. Economical lasting beauty is assured by Clay Brick's resistance to marring. Both indoors and outdoors its interesting texture provides that "substantial look" without sacrificing flexibility.



## **CLAY BRICK & TILE ASSOCIATION**

OF NORTHERN CALIFORNIA

**55 NEW MONTGOMERY STREET · SAN FRANCISCO**

Kroffle Company  
Remillard Dandini

L. P. McNear Brick Co.  
San Jose Brick & Tile

Port Costa Brick Works  
Stockton Brick & Tile Co.

United Materials & Richmond Brick Company

# JOINT INFORMATION COMMITTEE

AMERICAN INSTITUTE OF ARCHITECTS and THE PRODUCERS COUNCIL, INC.

---

At a meeting of the Joint Information Committee of the A.I.A. and Producers' Council held in New York on November 15 eighteen members conducted a two hour discussion which terminated in approval of the first concrete step toward setting up Uniform Specifications Procedures.

F. B. Hayne, A.I.A. of the Northern California Chapter, reports that eighteen members were present for this meeting who were architects: Lessing W. Williams of N. Y., co-chairman; Harold D. Houf of the U. S. Navy; M. Edwin Green of Harrisburg, Pa.; D. Kenneth Sargent of N. Y.; and F. B. Hayne of San Francisco. Producers Council members: Harry C. Plummer of Washington, D. C., co-chairman; Charles Nocar of Cleveland; F. J. Plimpton of N. Y.; Clyde Kelley of Detroit; Tyler S. Rogers of Toledo. Theodore I. Coe of the A.I.A. acted as secretary. Others present included Walter Taylor of the A.I.A.; Charles Mortenson of the Producers' Council; Joseph H. Orendorff, acting director of research, H. & H. F. A.; Leonard G. Haeger, from the National Association of Home Builders; C. E. Silling, A.I.A. director and on committee on Expansion of research facilities; H. M. Lawrence, assistant secretary, ASA Project A62; and William Demarest, Jr., A.I.A. secretary for Modular Coordination.

A plan was approved for the Institute to adopt a loose leaf system for model master specifications, providing sufficient money can be raised to finance the project. The system approved calls for the Institute to prepare master specifications for each of the 41 divisions in its materials file and a renewal of such specifications when they become out of date. The editing, upon request, and the payment of a fee of manufacturers' literature according to A.I.A. standard is also a part of the program.

A resolution was adopted that the Joint Com-

mittee recommend to the Board that all profit derived from the materials exhibit at the annual A.I.A. conventions be turned over to the Education and Research Department of the Institute to help finance the writing of such specifications as well as to carry on the campaign to promote modular coordination. Walter Taylor, Director of Education and Research and Charles Mortensen, Managing Director of the Producers' Council, were appointed to interview members of the Specifications Institute, in order to ascertain the costs on such a project.

Tyler S. Rogers, Director of Technical Publications for Owens-Corning Fibre Glass Corp., Producers' Council, presented the report on the Specifications plan using largely the material which was suggested by Bourn Hayne, A.I.A. in the articles which were published in the Architect and Engineer starting in the November 1950 issue.

In the course of the discussion F. Bourn Hayne pointed out the value of the service from a public relations standpoint with the building trades. Uniform Specifications as accredited by the A.I.A. will create in the minds of the mechanics and apprentices the value of the architect in helping him build the structure. This constant referral to aids created by the A.I.A. according to Hayne will encourage the contractor and his men to use the knowledge of the architect and present new opportunities to the profession for accomplishing their aims through this type of public relations which is most constructive.

The first definite move has now been made toward establishing Uniform Specifications Procedures which has been the concern of architects and the members of the Producers' Council for many years. Continued interest and activity will develop a system which is not only utilitarian, but beneficial to the industry from the long range view.

---

*NOTE: This news space is being contributed by ARCHITECT & ENGINEER Magazine to the JOINT INFORMATION COMMITTEE representing the Northern California Chapter of The American Institute of Architects and the Northern California Chapter of the Producer's Council, Inc. and is available to this Committee for the purpose of bringing to the attention of leaders within the Construction Industry various phases of the Architectural profession and building materials industry procedures for general consideration and comment. Your "ideas" and any suggestions for the better pooling of thoughts along these lines should be sent to "Joint Information Committee, c/o The Architect & Engineer, 68 Post Street, San Francisco," where they will be im-*

# NEWS AND COMMENT ON ART

## SAN FRANCISCO MUSEUM OF ART

The San Francisco Museum of Art, War Memorial Building, Civic Center, announces a special group of exhibitions for December and the Christmas Holidays, with the Museum closing at 5 p.m. on Monday, December 24th and December 31:

**EXHIBITIONS**—New Mexican Artists; San Francisco Women Artists; 15th Annual Watercolor Exhibition of the San Francisco Art Association; Woodblock Prints by Adja Yunkers; Albert M. Bender Collection; Christmas Decorations; Art for Christmas; Permanent and Loan Collections; Contemporary Textiles; and Prints from the Albert M. Bender Collection.

**SPECIAL EVENTS**—The Sunday afternoon Lecture Series will include "Watercolor Exhibition" by Barbara Fitzwilliams; "Woodblocks by Yunkers" by Anneliese Hoyer; and "Permanent Collection" by Barbara Fitzwilliams. The "Art of Today" Monday evening series will include Rodin, and The 19th Century and Its Arts.

Gallery Tours are conducted each Sunday at 2 p.m. The Sketch Club, Friday's; Painting Classes, Fridays; and the Children's Classes, Saturday mornings, will close the middle of the month and reopen on January 4 and 5.

## WINNERS OF THE SAN FRANCISCO ART ASSOCIATION WATERCOLOR ANNUAL

Winners of the 15th Annual Watercolor exhibition, recently shown at the San Francisco Museum of Art, War Memorial Building, Civic Center, have been announced as follows:

Robert S. Neuman, Oakland, "Conscienceless Machine" was awarded the Art Association's \$100 Purchase Prize; Karl Kasten, Lafayette (Calif.), "Bovine Skull and Vase" and William Dole of Santa Barbara, "Commercial Building" received the Artists' Council Prizes of \$75 each; Phyllis Houser, San Francisco won a \$50 Art Association Prize for her watercolor "Landscape" and Herbert Abraham, San Francisco, tempera "Orange", and Leonard Edmondson, Pasadena, gouache "Experi-

## SAN FRANCISCO MUSEUM OF ART

War Memorial Building  
Civic Center



### SPACE FIGURE—1937

Oil. 52 x 38¼ in.

by

JEAN HELJON (1904—)

—French—

From the Albert M. Bender Collection of the  
San Francisco Museum of Art.

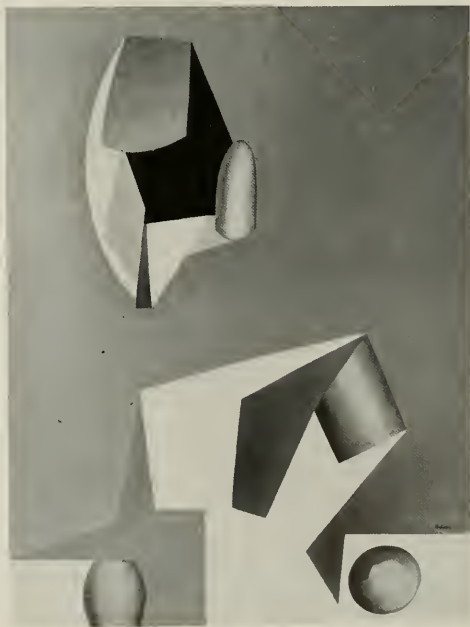

## NEWS AND COMMENT ON ART . . .

ence of Meaning" each won \$50 prizes.

Jorge Goya of Eugene, Oregon, and Ynez Johnston of Los Angeles received Honorable Mention.

---

### PORTLAND ART MUSEUM

Thomas C. Colt, Jr., director of the Portland Art Museum, West Park and Madison, announces the following schedule of exhibits and events which will highlight the Museum's activities during December.

**EXHIBITIONS** — Twenty-one modern British painters, organized by the British Council in conjunction with the Vancouver Art Gallery, will offer a group of recent British paintings; Two young photographers who have begun to receive national recognition will show a number of Photographs, Aaron Siskind and Jerome Liebling; Print Annual, now in its third year and open to all Oregon artists; Biblical Etchings by Rembrandt; and Christmas Paintings by children.

"The Wave" an oil by Gustave Courbet, has been presented to the Museum by Melissa Loeding Martinson in memory of her father Dr. Charles F. Loeding.

---

### ALBERT M. BENDER COLLECTION SHOWN AT SF MUSEUM OF ART

A special exhibition of selections from the Albert M. Bender Collection will be shown at the San Francisco Museum of Art, Civic Center, during December and the first part of January.

The collection is particularly important in its representation of the works of Bay Region artists, and also contains a large group of Latin-American paintings, prints and drawings in addition to work of other foreign artists.

---

### AMERICAN ACADEMY OF ARTS

Six distinguished Americans have been elected to membership in the American Academy of Arts and Letters it has been announced by Paul Manship, president.

With a life membership limited to 50, election to the Academy is an honor designated each nominee as a creative artist whose works are most likely to achieve a permanent place in American culture.

The newly elected members are Frank Lloyd Wright, architect of the modern school; Thomas Mann, novelist, Pulitzer and Nobel prize winner; Douglas Moore, composer and recipient of the 1951 Pulitzer Prize in Music; Carl Mills, internationally famous sculptor whose works are in almost every major European city; Pearl S. Buck, novelist and

first American woman to receive the Nobel Prize for Literature; and Leonard Bacon, poet, Pulitzer Prize winner and 1951 recipient of the Cervantes Medal of the Hispanic Institute.

The election of Pearl Buck brings to two the number of women who are members of the Academy at this time, the other being Anna Hunnington, sculptor.

---

### CITY OF PARIS

The Rotunda Art Gallery of the City of Paris, San Francisco, under the direction of Beatrice Judd Ryan, will feature an exhibit by Jean De Botton during the Christmas holiday season.

Comprising approximately sixty-six subjects the exhibition offers a wide variety of painting.

Jean De Botton was awarded "le Grand Prix du Dessin" in Paris in 1928 and became a member of the jury of the Salon d'Automne. In 1932 he was appointed "Chef d'Atelier" and lecturer of the "Academie Montmartre".

He has just returned from the East Coast where the portraits of the Court of St. James were exhibited for the first time in America at the Art Association of Newport.

---

### MILLS ART GALLERY

The Mills Art Museum, Mills College at Oakland, is currently exhibiting a group of paintings, watercolors and drawings, by William Dole, Leonid Kissil, and Leona Pierce.

---

### GENERAL CONVENTION OF SCARAB FRATERNITY

The Washington State College Chapter of SCARAB National Architectural Professional Fraternity was recently host to the 32nd Annual Convention of the Fraternity, with business sessions held at the Orton Room of the E.O. Holland Library.

Registration started on November 18th at the Pullman Golf Club House, followed by a luncheon at which Dr. W. A. Pearl, Acting President of the College, and Stanley A. Smith, Chairman of the Department of Architectural Engineering welcomed delegates Robert F. Smith, University of Kansas, National Secretary-Treasurer responded.

Speakers on the program included Dean Sidney Little of the University of Oregon School of Architecture; Paul Thiry, F. A. I. A., Architect of Seattle; James Berkey, Chief of Community Development, the Bureau of Reclamation at Ephrata, Washington; F. A. Naramore, F.A.I.A., Architect of Seattle; Glenn Stanton, F.A.I.A., Architect, Portland, Ore-

(See Page 33)



# DEFENSE CONSTRUCTION IN ALASKA

By GIL PEARSON

Technical Information Officer, Alaska District,  
Corps of Engineers, U. S. Army

When the Prospectus of Construction to be accomplished in the Alaskan Command during 1952-1953 appeared recently, it was at once apparent that the great number and variety of new projects listed will call for a wide acceptance of the bidding challenge by many contractors in order to bring about success for the program.

Listing some 96 new jobs with estimated approximate cost of 170 millions, the Prospectus points up that contracts for these new projects will be awarded on the basis of open competitive bidding and that any firm so desiring will receive the formal Notice to Prospective Bidders which details proposals and requirements as they are scheduled.

At present, defense construction work in Alaska supervised by the U. S. Arm Corps of Engineers is proceeding on 114 contracts which were let

during 1951 at a total cost of 190 millions. When the seasonal peak for 1951 was reached in August, 9000 men were employed by 87 contractors. To plan and engineer the vast array of Alaskan Command construction, an estimated 1,800 engineers and architects are employed.

In general, the system used in developing planning for these works involves the combination of design by the on-the-ground Corps of Engineers' staff with that of the architect-engineer. Some 142 sets of plans including repetitives were so accomplished during the past twelve months. The local Alaska District Engineer staff, working closely with the various Command staffs, determines from functional needs, the space requirements, room arrangement, necessary equipment, and, therefore, just what is to go into the form of de-

(See Page 30)

---

## CLEARANCE OF BUILDINGS ADJACENT TO RAILROAD TRACKS

By C. E. MILNE, Transportation Supervisor  
California Public Utilities Commission

It might be well for architects, engineers, and contractors to remember when designing, or constructing buildings and other structures adjacent to railroad tracks that the California Public Utilities Commission, formerly the Railroad Commission, promulgated a clearance order effective January 1, 1913 to regulate the matter of side and overhead clearance of buildings and other structures adjacent to railroad tracks. Since that date this clearance order has been revised, constantly keeping abreast of the trend of railroad equipment being built wider and higher.

The present order, designated as General Order No. 26-D, became effective February 1, 1948.

The Transportation-Operations Supervisors staff of the Public Utilities Commission is charged with the responsibility of regulating these clearance

matters and in the course of its inspections is finding entirely too many violations.

Buildings and structures are constantly being erected adjacent to railroad tracks, additions are being made to existing buildings, fixtures such as fire escapes, signs, air conditioning equipment, side and overhead pipes, are being attached to the face of buildings, all encroaching inside the mentioned clearance provided by law. These impairments create a hazard to railroad trainmen and yardmen resulting in fatalities or serious injury to this class of employee.

Railroad employees are required to work around the clock in all types of weather and while engaged in their work have little opportunity, especially at night, to observe an impairment from a

(See Page 31)



*Photos by Art Forde and Fred Garter*

# YAKIMA'S NEW CITY HALL

## IS MODEL OF EFFICIENCY

### YAKIMA, WASHINGTON

Architect: JOHN W. MALONEY

Contractor: JOHN SELLEN

**By ARTHUR W. PRIAULX**

How to combine all the functions of a city hall in one structure and then add the complex building requirements of a modern jail was the problem confronting Architect John W. Maloney when he designed the Yakima, Washington, city office building and jail.

Just completed, the \$1,000,000 structure is a tribute to Architect Maloney's ingenuity and soundness as a designer.

The Yakima City Building occupies a full city block and reaches four stories on the jail side and two stories on the city office end. So well arranged is the building that the usually obnoxious noises and racket from the jail is not heard in the city offices.

Maloney has put every square foot of space in the four floors and full basement to work. Probably the most distinctive feature of the building

is the manner in which he has eliminated the old hallway principle of serving offices and substituted a bank-type counter arrangement facing a common lobby.

Customers enter the building through an imposing office-like building entrance. All the principal offices of the city; water commissioner, treasurer, city clerk, face on an open arcade areaway. Each of these offices open in a full room length counter onto the main lobby of the building. In this manner a customer of the city may stop at the water commissioner's counter, transact his business and then move on to treasurer, city clerk or commissioner counters which open onto the main lobby. It is identical with the arrangement of a modern bank and greatly simplifies the ordinary citizen's problems in doing business with his city.

Maloney had a complicated problem in designing the building because of the complete dissimilarity between the needs of a jail and an office building. For all practical purposes there are two buildings. The entrance of the office building is on one street and callers in this two-story, compact

and completely utilitarian building have no means of knowing that a four-story jail building adjoins.

The building is reinforced concrete throughout with Roman brick facing and copings of Indiana limestone. Rainbow granite has been used for decorative effect in the main entrance which is served by tempered, double glass doors at the outside and also a pair separating the vestibule from the lobby entrance.

Entrance to the police offices and jail is from the opposite side of the building. One feature of this part of the structure is a motorized set of doors through which police cars may enter. The doors are controlled by the booking sergeant and the covered garage area will serve two cars. Elevators take prisoners to the proper floor after booking.

Another feature of the building which makes it flexible enough to serve the complex and varied needs of the city and its many functions is the arrangement of collapsible metal walls which can break a larger meeting room up into a number of smaller rooms.

The design of the lower-floor offices has been

**FIRST FLOOR PLAN—**

Featured in this portion of the building is the "open space bank type" area serving various city offices from the main lobby.

Center corridor serves other city activities.

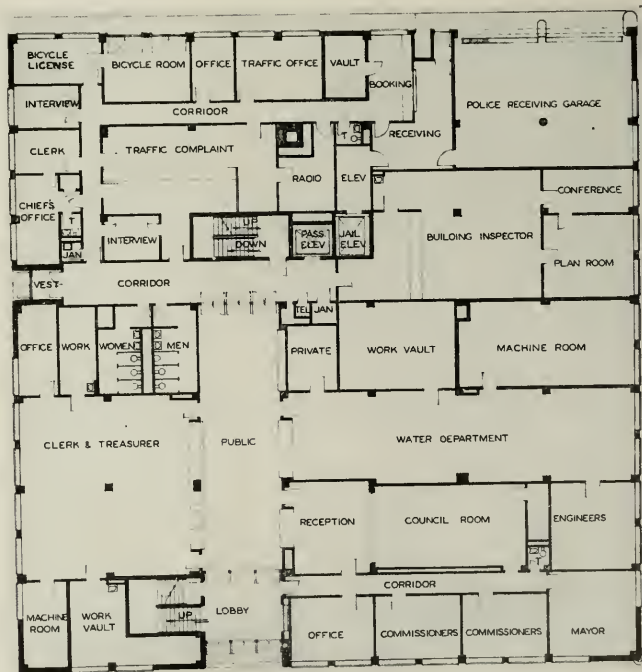

# YAKIMA CITY HALL . . .



## ENTRANCE—

This entrance is all business and adds dignity to a well-designed structure. Full glass doors enter small lobby and others open into unique central arcade in building fram which open mast of ground floor offices.

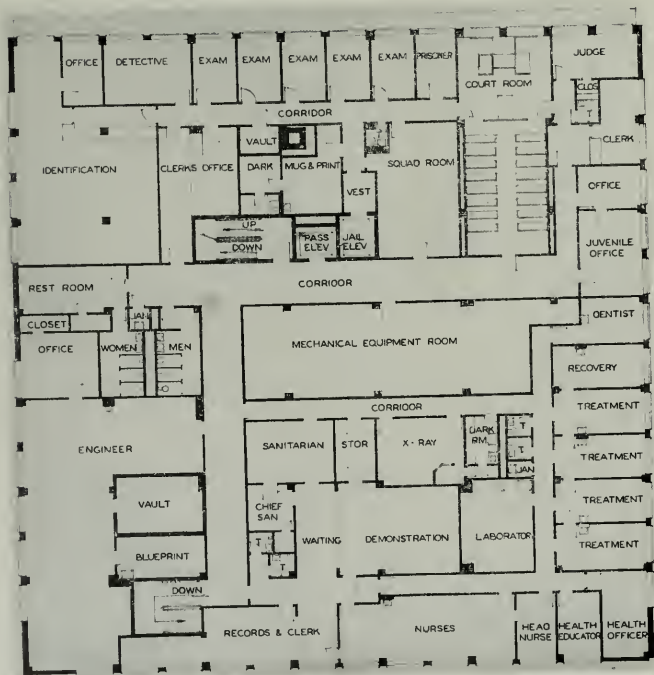

## SECOND FLOOR PLAN—

Follows general service arrangement of Main floor in that major functions of city's business activities are separated into distinct and separate locations.



**UNUSUAL FEATURE—**

Attractive and distinctive feature is this time saving, bank-type entrance to each office on the ground floor.

Counters face on a central arcade, thus citizens may move from one major city office to another in this one central lobby.

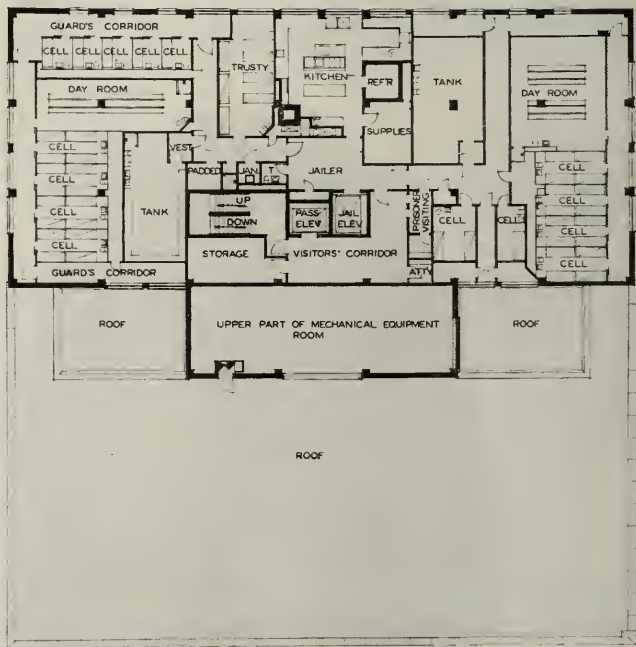

**THIRD FLOOR PLAN—**

The third floor contains facilities of the "Jail" proper together with newest features of a modern police department.

Arrangement is such that this area of building is independent of any other portion—day or night.

# YAKIMA CITY HALL . . .



planned to eliminate cross traffic completely. All offices which have frequent contact with the general public and where a large share of the city's inhabitants call at regular intervals have been located to open off the convenient ground-floor lobby arcade and are easily accessible to the public. In addition to the city clerk, treasurer and water department, the mayor and commissioner's offices and the council room are located on the main floor. Rooms for machine operators and work vaults are also on this floor.

On the second floor of the city office building are located the city engineer's offices, drafting rooms and blue print rooms. And occupying about two-thirds of the space is the city-county health department. Here are offices for the nurse, health officer, health educator, treatment rooms, laboratory, X-ray and sanitarian rooms. A stairway serves this floor, opening off the lobby at the entrance.

In the jail and police end of the building a similar plan has been worked out to eliminate cross traffic and unnecessary traffic by the public.

Police receiving, traffic complaint, chief's office, radio room, bicycle license room and several small interview rooms occupy the first floor along with the closed garage.

(See Page 41)

**ABOVE**—To give each room a maximum utility, multi-purpose role, the architect provided collapsible walls which serve to break large meeting room into several smaller ones.

**BELOW** — The Fourth Floor is a continuation of the modern facilities of the police department located directly beneath on the Third Floor.

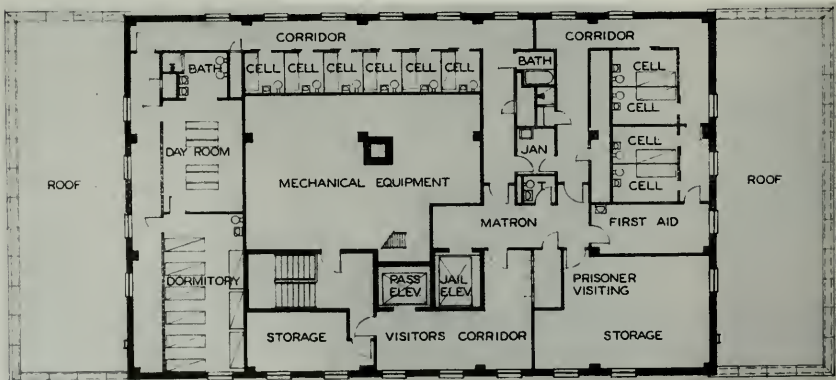



# UNITED GEOPHYSICAL CO. PLANT

PASADENA, CALIFORNIA

Architect: ROLAND E. COATE

Contractor: P. J. WALKER COMPANY

Cost: \$750,000.00

United Geophysical Company's new, modern \$750,000 plant at Pasadena, provides the industry with an outstanding building of contemporary architecture, extremely simple in concept and at the same time with extensive facilities devoted exclusively to geophysical purposes.

The building is designed in keeping with the organization's function, so that work is flowing from one division to another in natural progression of functions. A South American feeling is achieved by using white roofs with covered walkways between the buildings. Construction is of reinforced over-size brick masonry with a sprinkling system installed in the ceiling. A new plastic material is also used to give added color and attractiveness and casts a cheerful glow.

The building is supported by decorative beams and girders which give a functional aspect to the design. Wide eave overhangs protect the walls and windows and cast shadows from the hot sun.

Each of the company's five divisions—Research and Development, Engineering and Supply, Operations, Interpretation and Computation, and Finance—is housed in separate buildings with a park-like setting extending around the various units, creating quiet, attractive atmosphere.

The feeling of being contemporary modern with functional design has been carried out by the interior decorator, M. A. Glutt, who has striven for simplicity in all interiors. This feeling which starts with built-in seats in the lobby and large conference rooms with pastels, greyed-down and richly colored which give the rooms an expanded

feeling. Decorative maps, along traditional lines, are a part of the decorative scheme of the conference rooms.

The quiet, informal atmosphere has been continued throughout the grounds which have been landscaped by Thomas D. Church and Associates, landscape architects, and includes cheerfully colored covered walkways, cool-shaded trees and semi tropical planting.

The plant area is divided into small courts, the central one in which faces the entrance and has a pool and fountain surrounded by a grass panel. The landscape architect has striven to produce cool shaded areas for the benefit of employees as well as guests. Trees will be largely full-size olives, Brazilian peppers, evergreen pears and California alders, grouped to provide an informal atmosphere. The area outside the cafeteria is largely paving, with an arbor of evergreen elms over it, and may be used for outdoor eating.

The long alley between the buildings, which is partially covered with an arbor, will be used for color, which will include many varieties of azaleas and camellias, ferns, begonias and some semi-tropical plants. The area is laid out with an eye to ease of maintenance and a quiet, informal atmosphere, with shade, color and the play of water.

The new building avoids the usual bottleneck encountered in development work by equipping both the Research Division and the Engineering Division with their own laboratories. Maximum efficiency and flexibility have been provided by

(See Page 33)



*Photo by Harry H. Baskerville, Jr.*

MID-WILSHIRE  
MEDICAL BUILDING  
BEVERLY HILLS, LOS ANGELES

Architect: VICTOR GRUEN, A.I.A.

Contractor: WAALE-CAMPLAN CO.

Received HONOR AWARD given by the Southern California Chapter of The American Institute of Architects for five year architectural design competition—1951



The Mid-Wilshire Medical Building, located on Los Angeles' Wilshire Boulevard between the Miracle Mile and Beverly Hills, and recently completed, was designed by Victor Gruen, Architect, A.I.A. It has received wide attention during its entire development stage, since it features several new and significant engineering and architectural solutions.

The problem presented to the architect was to design a medical office building to accommodate approximately 60 tenants on an inside 57 by 167 foot lot. Adequate parking was of extreme importance and the building was to be completely air conditioned. At the same time a very tight budget had to be adhered to.

To solve these problems ingenuity was exercised in every phase of the planning. Extensive studies were made to determine the most economical type of construction commensurate with the building's requirements. An analysis of late Los Angeles City Building Code revisions showed that the new type 2 construction with 2 hour fire rated exterior wall could be used on a building of 6 stories, the size building necessary to accommodate the 60 tenants.

Edgaro Contini, engineer in charge of structural design for the project, was convinced that the considerable reduction of dead loads made possible by the elimination of heavy exterior walls would justify the use of structural steel framing which, ordinarily, on the west coast does not com-

**STRUCTURAL  
STEEL**

Striking view of seven floors of steel in place for installation of facing and interior construction.

Portion of brick wall is in place at left.

*Photo by  
George Hayashida*

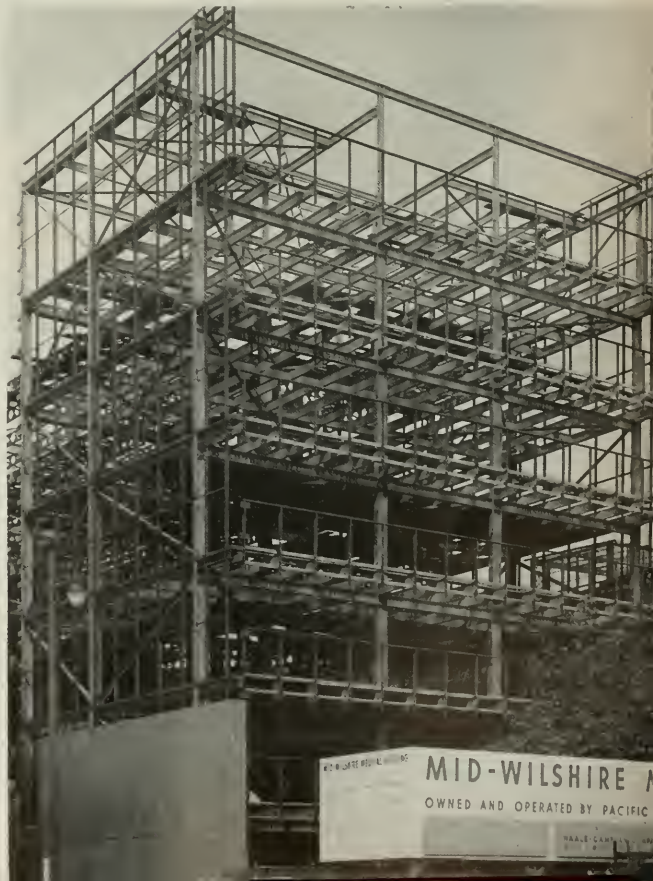



**TYPICAL  
CORRIDOR**

Showing natural high-window lighting supplemented by overhead indirect lights.

Asphalt tile used on floor to minimize noise.

*Photo by  
Harry H. Baskerville, Jr.*

pete favorably with the most advanced type of reinforced concrete construction for a building of this height. Contini found that, by developing the lightest type of floor construction (metal deck with

2" lightweight aggregate concrete topping supported by open web junior joists); by taking full advantage of rigid frame design; by designing the main wing of the building on the double cantilever

*Photo by Emiel Becky*

**Placement of steel for floor support**



principle; and by using welding for all rigid connections but maintaining conventional riveting for all standard connections, an extremely light and economical structure could be obtained. In spite of fairly large column spacing (25'-6" by 25' in the main wing), structural steel for the average floor framing (including girders, beams, joists and columns) weighs less than 9½ lbs. per sq. ft.

The structural scheme proved successful, representing a 25% savings in tonnage (and an almost proportional cost savings) over conventional structural steel framing. Erection of the structural steel framing was completed 5 weeks ahead of schedule.

The building consists of two distinct portions. The front wing (extending for the full lot width of 57 feet) consists of four-column six story rigid frames providing stability against transverse horizontal forces. The two solid walls at the sides contain a vertical cross bracing that stiffens the whole structure longitudinally. The main wing of the building, set back from the side property lines to provide for continuous fenestration, is 42 feet wide and is framed by two-column rigid frames spaced at 25'-6" on center. Between the frames span 18" deep Junior Open Web joists spaced at 4'-7" on center.

The rigid frames consist of 2-18" wide flange

**FIRST FLOOR PLAN—**

General entrance from Wilshire Boulevard includes automobile driveway, serving 24-car parking area and ramp to basement parking.

Lobby entrance serves store, elevators and stairway to upper floors.

**BASEMENT PLAN—**

Is designed to provide for 34-car parking, also utility quarters for building maintenance and service, etc.

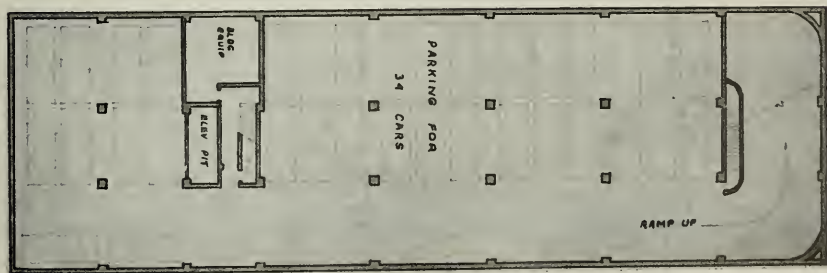

# MID-WILSHIRE MEDICAL . . .



## DOCTOR'S CONSULTATION ROOM

Exterior louvers provide for light control in conjunction with use of specialized equipment.

Simplicity in design is stressed.

*Photo by  
Harry H. Baskerville, Jr.*

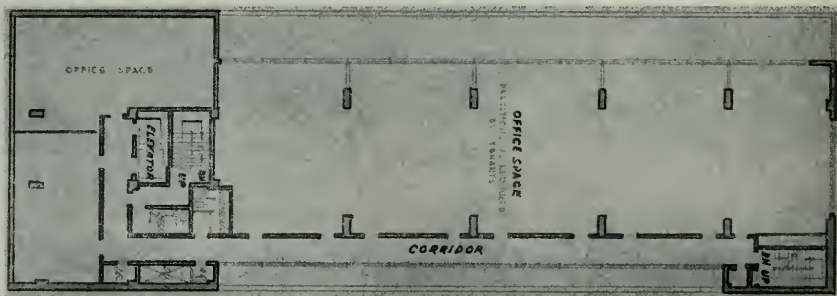

PLAN of  
Upper  
Floors

VIEW  
OF THE  
WILSHIRE  
BOULEVARD  
ENTRANCE





columns spaced at 25' on center and of double channel horizontal beams cantilevering 8'-6" from column center lines on both sides.

Thus, no column interrupts the wall framing, greatly simplifying wall construction details and allowing for complete flexibility in partitioning of the office space. Furthermore, the cantilever action thus obtained reduces considerably the maximum design moment for the main girders. The frames extend from roof to second floor where they are picked up by special trusses which transfer the vertical reaction from both columns to one center point and balance the whole structure against unsymmetrical or horizontal loads by means of two end supports at property lines (See section).

All rigid connections were designed for full continuity and are developed entirely by means of welding. At the front wing, which is framed in a conventional column and beam system, a typical detail for full continuity was used. At the rear wing, which is framed with double channels and center column (a very practical type of framing which, besides other advantages, allows for direct run of utility pipes and stacks in line with the column) rigidly was developed by means of field welds of channel webs to column flanges, supplemented by field welds of channel flanges to column stiffener plates shop welded to column flanges and web. These plates, protruding 1½" beyond the column flange edges, also provide seats for erection of the channel girders which are held tight against the column flanges by means of four temporary bolts.

The trusses at second floor level are of shop riveted construction with double channel top cord, double angle bottom cord and diagonals. Chan-

nels and angles are kept approximately 13" back to back. This allows the vertical columns from above and the diagonal struts to be sandwiched in between for ease of connection. Top and bottom cords are laced to obtain adequate lateral stability.

Some special problems were encountered in the foundation design. The great difference of loads between the center columns and the side columns prevented the use of standard spread footings, because of the possibility of differential settlement which may overstress the basement concrete frames and the continuous trusses above. The footings were, therefore, designed as inverted cantilever concrete beams, anchored at the ends into the basement walls, which in turn are reinforced as continuous longitudinal beams to distribute differential reactions.

The exterior walls are conceived and detailed as a supported thin skin. In the front wing of the building they consist of two inch thick pre-cast concrete panels with integral crushed stone facing. They are anchored to a light (4" channel) steel framing which spans from floor to floor at the solid side walls or cantilevers from the floor joists at the front elevation, where the stone facing forms continuous bands of window parapets. At the inside face of the 4" channels, plaster on metal lath is applied thus creating an air space for insulation. At the main wing of the building, where continuous strip windows span the full length of the wing at each floor, the parapets are obtained by cantilevering 3½" standard expanded steel studs welded to the exterior floor joists, which are properly cross braced for lateral stability. One inch cement plaster is applied at the exterior surface and vermiculite plaster at the interior.

## WESTERN TIMBER RESOURCES ARE AMPLE FOR EXPANDED PRODUCTION

An authoritative forecast that west coast forest resources are ample to support a healthy plywood industry throughout the foreseeable future was predicted by Dr. O. Harry Schrader, Jr., managing director of the Douglas Fir Plywood Association, at the recent meeting of the Western Forestry and Conservation Association in Portland, Oregon.

A former associate professor of forest products at the University of Washington, Schrader, drew his analysis of raw material for plywood from state and forest agencies and other timber data sources, including a plywood industry survey

which is "probably the first careful assessment of timber ownership on the part of plywood operators" ever made.

West coast plywood industry could expect a probable 1.5 billion board feet of high quality "peeler" logs from an estimated annual timber cut of more than 10 billion board feet in the three state area of Washington, Oregon and California. This is sufficient to maintain panel production for the next ten years at an annual rate of at least 3 billion square feet, well above the current record of 2.7 billion square feet. While emphasizing that vol-

ume plywood production is going to continue indefinitely, Schrader was less specific beyond the next decade, pointing out that there are many current developments which will extend raw material supply and play increasingly important roles in the long term picture.

#### INCREASED TIMBER UTILIZATION

These include growing integration of forest industries operations, continuing progress toward sustained yield forestry, new products and new production techniques making more efficient utilization of raw materials, increased utilization of leftovers, use of western tree species other than Douglas Fir and increased timber imports.

"It is significant," Schrader pointed out, "that during the past year fifty wood chippers have been installed in plywood plants to produce chips as raw material for pulp mills. These machines can produce 1,000 tons of pulp per day from what was formerly a left-over wood used only as fuel or burned."

Typical of how new products can extend raw materials is the industry's new combination panel in which a hardboard surface is bonded to a lower grade plywood backbone to produce a panel suitable for cabinets, table tops and concrete forms. Such a development "permits usage of lower grade peeler and saw logs and may

have a significant effect upon log requirements of the future."

#### TIMBER SUPPLIES

Dr. Schrader's survey shows an estimated 37 per cent of industry logs consumed in plywood plants are currently being withdrawn from company owned lands, another 18 per cent of logs used by plywood plants come from purchase of government and private timber holdings. The remaining 45 per cent is purchased on the open log market which is supplied from both public and private lands.

Historically, plywood manufacturers have been considered a "have not industry" insofar as timber ownership is concerned, however, in the past 10 years there has been a strong surge for timber acquisition between panel makers and now these manufacturers in the aggregate own about 25 billion feet of standing timber, and the panel makers, both new operators and old, continue to expend their raw material resources daily.

In tabulating timber resources, it has been pointed out that in Oregon, Washington and California, there are today 246 billion board feet of harvestable old-growth Douglas Fir timber. Of this, 70 billion feet is considered of quality suitable for plywood manufacture.

"At production of 3 billion feet of plywood a



# BRONZE PRODUCTS

by GREENBERG

Your best and nearest source for standard and special Bronze products



STABILITY since 1854

M. GREENBERG'S SONS

765 Folsom St • San Francisco • Calif • EXbrook 2-3143

Manufacturers of Fire Hydrants and Fire Protection  
Brass Goods • Industrial, Navy and Maritime  
Bronze Valves and Fittings • Plumbing and  
Hardware Brass Specialties • Bronze Plaques,  
Letters and Name Plates.

LOS ANGELES • SEATTLE • PORTLAND • SPOKANE • SALT LAKE CITY • DENVER • EL PASO • NEW YORK • HARTFORD • WASHINGTON, D. C.

year, and assuming the plywood industry obtains all peeler logs harvested each year," Schrader concluded, "a purely statistical analysis would indicate a life expectancy of the plywood industry of 40 years." Although there is competition among segments of the forest industries for available peeler logs, improvement in manufacturing techniques simultaneously tends to expand overall supply by making practicable the use of smaller and lower grade logs. Thus greater utilization of raw material and development of new products will assure production indefinitely.

#### "FOR NOW AND FOREVER" SOUND COLOR FILM BY GLADDING, McBEAN

A new 16-mm sound-color motion picture "For Now and Forever" has been announced by the Hermosa Tile department of Gladding, McBean & Co., and following a special preview recently at the Town House in Los Angeles, the film is available for immediate bookings by schools, club groups, architectural, engineering and building trades organizations.

The first motion picture produced by any tile manufacturer, it tells the story of the Wilson family, typical American's with typical home remodeling problems, who solve their needs with clay tile in an amusing, entertaining and educational manner.

Portions of the film were made in the Los Angeles plant of Gladding, McBean & Company and show actual examples of pressing, firing and glazing of tile. The color photography reveals to advantage the use of colorful tile by the skilled architect, tile contractor, painter and constructor.

#### U.C.L.A. INSTALLS LARGE SUN FURNACE

High temperature research on the Los Angeles campus of the University of California is possible through installation of a unique student built solar furnace.

A 24-inch Navy searchlight has been converted into a solar furnace capable of reaching temperatures of at least 6000 degrees Fahrenheit.

Today's era of jet engines, rockets and atomic power have brought high temperature experiments to a new important scientific position.

#### JUNIOR ESTIMATOR EXAM BY STATE OF CALIFORNIA

A California civil service examination will be held in January for positions as junior estimator of building construction. Requirements are two years architectural or engineering experience, including estimating and cost accounting. College graduates who have majored in architecture or engineering may also file for the examination. Applications will be accepted until December 29.



Chapel, Forest Lawn Memorial Park, Glendale, California

### ... IF you specify HILLYARD products

Because it's the original treatment you specify that protects those floors. And when Hillyard products are used you can be sure of the best protection possible . . . sure that months and years later your floors will be in top condition . . . a credit to you and a joy to your clients. Hillyard products for floor treatment are approved nation-wide by contractors, builders, architects and flooring manufacturers.

### ... a specialized Product for every Floor



Whatever the type floor—wood, terrazzo, cement, magnesite, tile, linoleum, asphalt tile, rubber tile, marble, cork—there's a Hillyard product ready and right for treating and maintaining that floor. And because specialized for the job at hand, Hillyard products save you and your clients unnecessary dollars.

### ... FREE Consultation Service

Hillyard maintains a staff of trained floor experts in key cities throughout the nation. The Maintaineer in your vicinity is eager to help with your floor problems. Consult him while your buildings are in the planning stage—he can show you how to save on labor time and construction costs. His advice is FREE.

WRITE For Hillyard's A.I.A. Specification File. Gives handy reference data on floor treatments. Free to architects on request.

Dept. N-8



St. Joseph, Missouri



# American Institute



# of Architects

Glenn Stanton, President  
Kenneth E. Wischmeyer, 1st Vice-president  
Norman J. Schlossman, 2nd Vice-president  
Clair W. Ditchy, Secretary  
Maurice J. Sullivan, Treasurer

Arizona Chapter:  
Edward L. Varney, President; Ralph B. Haver, Secretary,  
P. O. Box 786, Phoenix, Arizona.  
Central Valley of California:  
William Koblik, President; Gordon Stafford, Vice-President;  
John W. Bomberger, Secretary; Albert B. Thomas, Treasurer,  
Secretary's Offices P. O. Box 1943, Modesto.  
Coast Valleys Chapter:  
William F. Hempel, President; Lawrence Gentry, Vice-  
President; Walter Stromquist, Secretary-Treasurer. Sec-  
retary's office, 321 Channing Ave., Palo Alto.  
Colorado Chapter:  
Paul Atchinson, President; James M. Hunter, Vice-President;  
Dudley T. Smith, Secretary; Victor Hornbein, Treas.; 1659  
Grant St., Denver, Colorado.

National Headquarters —  
1741 New York Avenue, N. W.  
Washington 6, D. C.  
Edmund R. Purves  
Executive Secretary

Northern California Chapter:  
Francis J. McCarthy, President; Albert R. Williams, Vice-  
President; Wendell R. Spackman, Secretary; Helen D.  
French, Treasurer. Offices 369 Fine Street, San Francisco.  
Oregon Chapter:  
Herman Brookman, President; Donald J. Stewart, Vice-  
President; Raymond Kermit Thompson, Secretary; Millard  
H. Schmeer, Jr., Treasurer. Secretary's office 429 S. W. 4th  
Avenue, Portland.  
Pasadena Chapter (California):  
Culver Heaton, President; Dan Neptune, Vice President;  
Arthur Frick, Treasurer; Mrs. Dorothy Gray, Secretary.  
Directors, John N. Douglas, Boyd George, Roland E. Coate  
and Burton Romberger. Office 1041 East Green St., Pas-  
adena.

## SAN DIEGO CHAPTER

"Right out of the Laboratory" was the theme of the November meeting and featured a practical discussion of construction problems.

Phil Helsley, engineer and owner-manager of the San Diego Testing Laboratory and Jim P. Slater, Chief of the Division of Sanitation for the San Diego City-County Health Department discussed the subject "Percolation Test Methods for San Diego County Soils". The two talks were followed by a short questions and answers period.

A short film "The Precastructural System" which Eero Saarinen calls "the most terrific thing that has happened in construction methods, was presented by Q. Rust through cooperation of the Portland Cement Association.

## WINS ARCHITECTURAL SCHOLARSHIP

Jack L. Hollstien of Stockton, senior student at the California State Polytechnic College, San Luis Obispo, has been awarded a scholarship in the architectural engineering department.

The scholarship is awarded each year by the Women's League of the Coast Valleys Chapter of The American Institute of Architects, and is given for general scholarship standing, general ability at architectural design, ability to coordinate planning, structure and aesthetics, personality, general initiative and participation in extra curricular activities.

## YAKIMA ARCHITECTS

The Central Washington Architectural Society recently heard an explanation of the city's planning problems which was presented by Gene Renard. He exhibited charts to show the city's population growth, land use, and traffic problems. "One of the problems," according to the speaker, "is what to do with the railroad which bisects the town and thereby presents grade separation, under-pass, over-pass, and grade problems."

City officials, being well aware of the situation, are giving considerable thought to a solution.

## SOUTHERN CALIFORNIA CHAPTER

Oscar Trippet, president, Los Angeles Chamber of Commerce, was the speaker at the November meeting which was devoted to Progress in Architecture. Taking as his subject "The Value of Good Architecture and Good Community Planning," as related to the cultural and economic development of our city, Trippet emphasized the importance of

**SPEED CONSTRUCTION  
WITH FIRESAFE, SAG-PROOF  
EASY-TO-USE**

**STRAN-  
STEEL**



**AVAILABLE  
STEEL FRAMING  
"Metal Lumber"**

**\*PROMPT DELIVERIES ON  
STUDS • JOISTS • CHANNELS  
IN STANDARD SIZES**

For complete information and prompt service, phone or write

**KRAFTILE COMPANY**

NILES, CALIFORNIA NILES 3411  
SAN FRANCISCO 5: 50 Hawthorne St.—DOUGLAS 2-3786  
LOS ANGELES 13: 456 South Main Street—MUTUAL 7241



#### East Bay Chapter:

Harry A. Bruno, President; Chester H. Treichel, Vice-President; Ira D. Beals, Secretary; Cecil S. Moyer, Treasurer. Secretary's office, 1444 Webster St., Oakland.

#### Montana Chapter:

E. Edward Scowcroft, President (Billings); J. Van Teylingen, Vice-President (Great Falls); H. C. Cheever, Secretary, Treasurer. Secretary office, Bozeman.

#### Nevada Chapter:

George L. F. O'Brien, President; Aloysius McDonald, Vice-President; Graham Erskine, Secretary; Edward S. Parsons, Treasurer. Offices 169 Chestnut St., Reno.

#### Nevada State Board of Architects:

L. A. Ferris, President, Reno; Walter Zick, Secretary, Las Vegas; Directors, Aloysius Macdonald, Las Vegas; Russell Mills and Edward Orsons, Reno. Office, P. O. Box 2107, Las Vegas, Nevada.

#### Pasadena Chapter:

Culver Heaton, President; Don Neptune, Vice-President; Arthur Frick, Treasurer; Mrs. Dorothy Gray, Secretary. Directors John N. Douglas, Boyd George, Roland E. Coate, and Burton Remberger. Offices 1041 E. Green St., Pasadena 1.

#### San Diego Chapter:

Jack R. Lewis, President; Louis A. Dana, Vice-President; Donald Campbell, Secretary; Victor L. Wulff, Jr., Treasurer. Directors C. J. Padewski, G. C. Hatch. Secretary office, 1230 Prospect St., La Jolla.

#### San Joaquin Chapter: (California)

Fred L. Swartz, President; Fresno; Lloyd J. Fletcher, Vice President; Visalia; Walter Wagner, Secretary, Fresno; Robert W. Stevens, Treasurer, Fresno. Directors: Alastair Simpson, William D. Coats, William F. Baxter, Maurice J. Metz, Deleage California Council of Architects. Office, Sec. Fulton-Fresno Bldg.

#### Santa Barbara Chapter: (California)

Robert I. Hoyt, President; Harold E. Burkot, Vice-President; Roy W. Cheesman, Secretary; Lulah M. Riggs, Treasurer. Address, 242 San Marcos Bldg.

#### Southern California Chapter:

John J. Landon, President; Chas. Frey, Vice-President; C.

Day Woodford, Secretary; Wm. G. Balch, Treasurer. Directors, Paul O. Davis, Henry Wright, John Rex, and Kemper Nomland. Ex. Sec. Rita E. Miller. Chapter Headquarters, 3723 Wilshire Blvd., Los Angeles 5.

#### Spokane Chapter:

B. K. Rusli, President; Victor L. Wulff, 1st Vice-President; Philip Keene, 2nd Vice-President; Laurence G. Ewanoff, Secretary, and Carroll Martell, Treasurer. Office 515 American Legion Bldg., Spokane, Washington.

#### Utah Chapter:

Howell O. Cannon, President; William J. Monroe, Jr., Secretary, 3707 South 32nd West Street, Salt Lake City 7. Utah Washington State Chapter:

Poul Thury, President; John S. Delle, 1st Vice-President; Walter H. Roth, 2nd Vice-President; Robert H. Dietz, Secretary; Lawrence G. Waldron, Treasurer; and Alice Gressor, Executive Secretary, 430 Central Building, Seattle 4.

#### Tacoma Society:

E. H. Dupon, President; P. G. Ball, Vice-President; Lyle Swedberg, Secretary-Treasurer.

#### Hawaii Chapter:

James C. Simms, President; Alfred Pres, Secretary, 1507 Kapiolani Blvd., Honolulu, T. H.

#### CALIFORNIA COUNCIL OF ARCHITECTS

John L. Rex, President; Wm. Kohlik, Vice-President; Maurice J. Metz, Secretary-Treasurer. Executive Secretary office 3723 Wilshire Blvd., Los Angeles.

#### ALLIED ARCHITECTURAL ORGANIZATIONS

##### San Francisco Architectural Club:

Alfred T. Kirkevoid, President, Charles Dennis, Vice President; William C. Thielman, Treasurer; Milton Bromberg, Secretary. Office 507 Howard Street.

##### Producers' Council—Southern California Chapter:

Harold F. Smith, President, Gladding, McBean & Co.; Bert Taylor, Vice-Pres., Pittsburgh Plate Glass Co.; Richard Seaman, Sec., W. F. Fuller Co.; Clay Snider, Treas., Minneapolis-Honeywell.

Producers' Council—Northern California Chapter (See Special Page)

architecture as it is practiced in Southern California and pointed out that "California architecture" is setting a pace and standard for many other sections of the nation.

Winners of the Honor Award Competition were also announced and examples of the winning buildings were on exhibit, with certificates being awarded to architects, owners, and contractors. Report of the jury of this year's award was made by William W. Wurster, Dean, College of Architecture, University of California and Chairman of the Honor Awards Program jury.

### TACOMA ARCHITECTURAL ACTIVITIES

The architects of the Tacoma area are meeting regularly every two weeks under a new stimulated professional program, with meetings being held in the University-Union Club at noon.

Virgil Bergh of the plumbing and heating firm of Bergh-Griggs, was a recent speaker on the subject of plumbing.

### WASHINGTON STATE CHAPTER

Members heard Congressman Henry M. Jackson, an observer at the recent atomic tests in Nevada, speak on the subject "Can We Defend Ourselves Against Atomic Weapons" at a recent meeting. A dynamic speaker, Congressman Jackson gave "eye witness, first hand" information on this vital subject.

With the passing of Charles H. Alden has come a great loss to the Washington State Chapter and to the architectural profession as a whole. His friendly counsel, his life-long devotion to architecture and the A.I.A., the contributions he made to

Seattle and the Pacific Northwest, will make him long remembered. He began his career in architecture in 1899, opened his own offices in Seattle and was elected Fellow of the A.I.A. in 1913. He

(See Page 32)



LOUIS PURSEL, A. I. A., ARCHITECT

FREDERICK CONSTRUCTION CO., CONTRACTOR

### Fresh, colorful, fade-proof beauty of PORCELAIN ENAMEL VENEER

... provides any building a cleaner, more welcoming entrance. Other advantages include limitless flexibility in fabrication, fire-safety, strength and durability.

★ Write, today, for details ...



# WITH THE ENGINEERS

## Structural Engineers Association of California

Donald F. Shugart, President; Walter A. Buehler, Vice-President; Lewis K. Osborn, Sec.-Treas.; Office c/o Kistner, Curtis & Wright, Room 203 Architects Bldg., Los Angeles. Directors Arthur W. Anderson, John E. Rinne, Henry J. Degenkob, Lewis K. Osborn, Ernest C. Hillman, Jr., R. W. Binder, Donald F. Shugart, Walter A. Buehler, and G. E. Goodall.

## Structural Engineers Association of Northern California

John E. Rinne, President; John J. Gould, Vice-President; Wm. W. Brewer, Sec., Franklin P. Ulrich, Treas.; Directors, Walter L. Dickey, Leslie W. Graham, Hyman Rosenthal, and Howard A. Schirmer.

## Structural Engineers Association of Central California

William H. Petersen, President; Walter S. Wassum, Vice President; O. T. Illerich, Sec. Treas.; Ernest D. Francis, M. A. Ewing, and Arthur A. Sauer, directors. Office O. T. Illerich, c/o Div. of Arch., Sacramento.

## American Society of C. E. San Francisco Section

Clement T. Wiskocil, President; John S. Longwell, Vice-president; J. G. Wright, Vice-president; H. C. Medbery, Treasurer; R. D. Dewell, Secretary. Secretary's Office, 604 Mission St., San Francisco.

## Structural Engineers Association of Southern California

Harold P. King, President; Ben Benioff, Vice President; Chas. Corbit, Jr., Sec.-Treas.; Don Wilts, Ex.-Sec. Office., 1700 So. Main St., Los Angeles.

## Structural Engineers Association of Oregon

R. Evan Kennedy, President; Guy H. Taylor, Vice President; James R. Griffith, Secretary-Treasurer; Directors Jerome A. McDevitt, H. Loren Thompson, and Robert L. Tidball, Offices, Portland.

## Puget Sound Engineering Council (Washington)

R. E. Kister, A. I. E. E., Chairman; E. R. McMillan, A. S. C. E., Vice Chairman; L. B. Cooper, A. S. M. E., Secretary; A. E. Nickerson, I. E. S., Treasurer. Offices, L. B. Cooper, c/o University of Washington, Seattle 5, Washington.

## American Society Testing Materials Northern California District

L. A. O'Leary, Chairman; P. V. Garin, Vice-chairman; H. P. Hoopes, Sec. Office Sec., 1550 Powell St., Emeryville, Calif.

## Society of American Military Engineers—San Francisco Post

Capt. Cushing Phillips, CEC, USN, President; Col. W. C. Baker, Jr., CE, USA, Vice President; Robert P. Cook, Secretary; Levant Brown, Treasurer. Directors: Rear Admiral L. N. Moeller, CEC, USN; Capt. H. F. Ranford, CEC, USN; Clyde Bentley; Prof. Harmer E. Davis, Lieut. Col. James D. Strong, CE, USA; and Lieut. Col. Henry M. Smalley, CE, USA.

## STRUCTURAL ENGINEERS ASSOCIATION OF NORTHERN CALIFORNIA

T. Y. Lin, Associate Professor, Institute of Transportation and Traffic Engineering at the University

of California, was the principal speaker at the December meeting held in The Engineers' Club, San Francisco.

Prof. Lin's subject was "Progress of Studies on San Leandro Creek Bridge" and a number of illustrative slides accompanied the discussion. It is believed that findings on the San Leandro Creek Bridge project may lead to economy not only in bridge but also in building design. Composite action between steel girders and concrete slabs was established in the full scale tests and actual distribution of loads between girders was measured.

Consistent data proved the reliability of electronic devices for the testing of actual structures, reported Prof. Lin.

## PROFESSOR HYDE HONORED BY ENGINEERING SOCIETY

Charles Gilman Hyde, professor of sanitary engineering, emeritus, on the Berkeley campus of the University of California, has been made an honorary member of the American Society of Civil Engineers, the first University of California faculty member to be thus honored.

Professor Hyde received the honor at the society's annual convention held recently in New York City. The distinguished engineer, who has combined engineering teaching and consulting work in a long career of public service, taught civil, hydraulic and sanitary engineering subjects at the University of California for 39 years.

Born at Norwich, Connecticut, he was educated



Always  
Specify

**HAWS**  
for Highest  
Quality

• Sanitary Drinking Fountains • Electric Water Coolers • Drinking Faucets, Equipment, Filters and Accessories.

A reputation for reliability since 1909.  
Check in Sweet's or write for complete HAWS catalog.

## HAWS DRINKING FAUCET CO.

1441 FOURTH STREET (Since 1909) BERKELEY 10, CALIFORNIA  
Agents and Sales Representatives in All Principal Cities

at Norwich Academy and at Massachusetts Institute of Technology, from which he received the B.S. degree in sanitary engineering in 1896. Prior to coming to California in 1905, he served four years in the engineering department of the Massachusetts State Board of Health; two years in Philadelphia on water purification investigations; and three years in Harrisburg, Pennsylvania, on water purification experiments and the design and construction of water treatment works.

During his 46 years in California, Professor Hyde has been actively concerned with a number of water supply, sewage, and environmental control problems and projects in the Pacific Coast area. He is author and cocauthor of numerous publications in his field. In 1949 he was awarded the honorary degree of doctor of laws by the University of California.

#### STRUCTURAL ENGINEERS ASSOCIATION OF SOUTHERN CALIFORNIA

In keeping with the fall season emphasis on sports and football in particular, Al Santoro, sports editor of the Los Angeles Examiner, spoke recently before members on the subject "Your Present Day Football," giving many interesting sidelights on the game of football as seen through the eyes and professional association of a leading sports writer on the nation.

The December meeting featured C. Henning Vagtborg, president of Vagtborg Lift Slab Corp., speaking on the subject "Youtz-Slick" Lift Slab. His comment was well illustrated with a film showing actual installations.

President Shugart gave a report on the Association's activities for the year and numerous committee reports were presented.

Harold P. King was named president for the ensuing year at the annual election. Other officers named included: Ben Benioff, vice president; Chas. Corbit, Jr., secretary-treasurer; and Joseph Shefflet and Henry M. Layne were named members of the board of directors.

New members. Recent new members include: Maurice P. Klick and Holland R. Vaughn, Allied; Harvey T. Brandt, Associate; and Donald Kendall and Clinton Hale, Junior.

#### STRUCTURAL ENGINEERS ASSOCIATION OF NORTHERN CALIFORNIA

The December meeting combined annual committee reports, report of the election committee, and a technical discussion of "Progress of Studies on San Leandro Creek Bridge" by T. Y. Lin, Associate professor, Institute of Transportation and Traffic Engineering at the University of California, Berkeley.

New members: Edmund P. Burke and Thomas H. Peterson; Paul A. Elsner, Affiliate member.

#### SOCIETY OF AMERICAN MILITARY ENGINEERS SAN FRANCISCO POST

Howard G. Vesper was the principal speaker at the December meeting at the Presidio Officers Club, Presidio of San Francisco, taking as his subject "Petroleum and the National Emergency."

Vesper, a graduate of the California Institute of Technology in 1922 in chemical engineering, became associated with the Standard Oil Company immediately following graduation and has been with the firm since. With a wide variety of experience in various phases of his company's operation, the speaker gave an interesting and educational analysis of the present day situation confronting the oil industry and the nation.

#### WILLIAM H. POPERT ON EXTENDED EASTERN TRIP

William H. Popert, active member of the Northern California Structural Engineers Association is on an extended trip throughout the East.

He plans on combining a certain amount of "rest" and "relaxation" while away from the San Francisco Bay area.

#### SF FEMINEERS

At the November meeting of the Femineers Association (See Page 29)



Always  
Specify  
**HAWS**  
for Highest Quality

A complete line of fountains, electric water coolers, faucets, filters and accessories. • Individual or multiple installations. • A reputation for reliability since 1909. • Check in Sweet's or write for complete HAWS catalog.

#### HAWS DRINKING FAUCET CO.

1441 FOURTH STREET (Since 1909) BERKELEY 10, CALIFORNIA  
Agents and Sales Representatives in All Principal Cities

# PRODUCER'S COUNCIL PAGE

The National Organization of Manufacturers of Quality Building Materials and Equipment  
affiliated with THE AMERICAN INSTITUTE OF ARCHITECTS

President, Arthur C. Staat  
Natural Gas Equipment, Inc.  
1150 Folsom Street

Vice-President, Fred A. Figone  
Otis Elevator Company  
1 Beach Street

Secretary, Howard Noleen  
E. F. Hauserman Company  
500 Second Street

Treasurer, A. L. West, Jr.  
Aluminum Company of America  
Russ Bldg.

Edited by Carl B. Frank, DETROIT STEEL PRODUCTS CO.



**ANNUAL CHRISTMAS PARTY—Cast of Play "Bells A Poppin'." left to right, Art Staat, Herb Kaewert, Paul O'Daffer, Bill Daniels, Len Tivol, John Cowley, Dick Peterman, Lloyd Cramer, Wendell Spackman, Tam Ried, Brey Fogle, Clyde Cornell, Herb Duncan, Al West, and George Conely.**

## ANNUAL CHRISTMAS JINX

On Friday night, November 30, our Annual Christmas Jinx was held at the Claremont Hotel and resulted in a howling success due to the efforts of George Conely of Johns-Manville who was general chairman and his committee-men as follows: Bill Daniels, arrangements; Ray Brown, invitations; Howie Noleen, program; John Cowley, tickets.

The early returns show that the total attendance was in the neighborhood of 408, the majority of which were architect and engineer guests.

Our play "Bells a Poppin'" written by Bill Corlett, Wayne Hertzka, George Conely, Nick Zavalishin, and Howard Noleen was presented and turned out to be a real success story of a salesman's entanglements with the architect and engineer trade. I might say one of the high spots in the play was the props, I said "props."

## CHANGE IN FISCAL YEAR

Some few issues back we mentioned that there was a proposed change in the chapter fiscal year in order to comply with the fiscal year of the A.I.A., and that change has been voted upon

and gone into effect. With this in mind, we will carry over our present officers into next year. Our new elections will be held some time about June, and thus bring our schedules in conformity with the A.I.A.'s. The only change in the current offices is that Mr. Fred Figone of Otis Elevator Company is taking a year's leave of absence and Al West of the Aluminum Corporation of America who was our secretary has been moved up to take Fred's place, and Lloyd Cramer of Westinghouse Electric unanimously voted in office to succeed Al in the job of secretary.

## COMING YEAR'S ACTIVITIES

We are looking forward to a very interesting schedule for next year's meetings. At the early part of the year, one of the traveling shows from National Chapter Headquarters will be shown with the date to be announced. Before Fred left, he lined up programs well into October of the coming year, and I am sure that the companies involved are going to make their best effort in order to offer even more interesting programs than those previously presented.

USE QUALITY PRODUCTS



CONSULT AN ARCHITECT



## WITH THE ENGINEERS

(From Page 27)

ciation of the San Francisco Bay Area, Mrs. A. C. Horner was elected president for the 1952 year. Other officers named included Mrs. E. F. McKeon, vice president; Mrs. H. J. Degenkolb, secretary; and Mrs. L. W. Graham, treasurer.

Meetings of the group are held each month, with the December meeting scheduled for the Olympic Club, Lakeside, in charge of Mrs. A. B. Smith, Jr.

## DON WILTSE NAMED SECRETARY ENGINEERS ASSOCIATION

Don Wiltse has been named executive secretary of the Structural Engineers Association of Southern California, according to a recent announcement by Donald F. Shugart, president.

Offices for the organization will be opened at 1700 South Main Street, Los Angeles, with Wiltse in charge.

## CARNEGIE INSTITUTE CHOSEN FOR WESTINGHOUSE FELLOWSHIPS

Between twenty and forty fellowships, each valued at \$250, will be awarded to secondary school science teachers who will participate in a special six weeks' summer program at Carnegie Institute of Technology, made available by the Westinghouse Electric Corp. and marking their second annual program for secondary school teachers.

A. C. Monteith, vice president of Westinghouse and chairman of the Westinghouse Educational Foundation, announced the program will start on June 30, 1952 and will extend through August 8.

## AMERICAN SOCIETY FOR TESTING MATERIALS ESTABLISH AWARD

The American Society for Testing Materials has announced the establishment of an annual H. W. Gillett Memorial Lecture. The purpose of this lecture, which is being sponsored in cooperation with Battelle Memorial Institute, is to commemorate Horace W. Gillett, one of America's leading technologists, the first Director of Battelle in Columbus, Ohio, and an active worker for many years in ASTM.

The first memorial lecture will be delivered at the 50th Anniversary Meeting of ASTM in New York in June, 1952, and will be devoted to a subject pertaining to the development, testing, evaluation, and application of metals.

## FORM GENERAL CONTRACTING PARTNERSHIP

Formation of the firm of Rothschild, Raffin & Weirick in the general contracting field has been announced with the opening of offices of the new firm at 274 Brannan Street in San Francisco.

Robert B. Rothschild, Jr., a licensed engineer;

Bennett L. Raffin, a licensed engineer; and L. Don Weirick, construction supervisor comprise the personnel of the new firm.

## ABBOT A. HANKS OBSERVES EIGHTY-FIFTH ANNIVERSARY

The pioneer San Francisco firm of Abbot A. Hanks, Inc., is celebrating its 85th anniversary this year, according to Herbert D. Imrie, company president.

The firm is well known throughout the west for its work in engineering, assaying, chemistry, metallurgy, and in consulting, testing and inspecting of ores, minerals, metals, metal products, cement, aggregates, steel and building materials.

## NAMED DIRECTOR OF COMMERCIAL RESEARCH FOR STANLEY COMPANY

R. W. Chamberlain, vice president in charge of sales for The Stanley Works, New Britain, Conn., recently announced the appointment of George E. Breen as director of commercial research at The Stanley Works.

Breen is a former faculty member of New York University and Western Reserve University and graduated from Yale University, 1932, and from Harvard Business School.

**HOLLYWOOD JUNIOR**  
COMBINATION  
SCREEN and METAL SASH DOOR  
★  
The "WEATHER-WISE"  
DOOR!!

**A VENTILATING SCREEN DOOR  
A SASH DOOR  
A PERMANENT OUTSIDE DOOR  
ALL 3 IN 1!**

Discriminating home owners and architects have chosen Hollywood Junior as the TRIPLE DOOR VALUE in the COMBINATION SCREEN and METAL SASH DOOR field! A sturdy dependable door, constructed of quality materials, HOLLYWOOD JUNIOR'S EXCLUSIVE PATENTED FEATURES have outmoded old-fashioned screen doors and other doors of its type entirely!

**IT GUARANTEES YOU YEAR 'ROUND COMFORT, CONVENIENCE AND ECONOMY**

WE ALSO MANUFACTURE A COMPLETE LINE OF SHUTTERS, C. C. DOORS, SCREENS, SCREEN DOORS, LOUVRE DOORS

**WEST COAST SCREEN CO.**  
1145 EAST 53rd STREET \* LOS ANGELES, CALIFORNIA  
ALWAYS 1118

★ ★ WRITE FOR FREE ILLUSTRATED LITERATURE ★ ★



# Gift Subscription For Christmas 1952

**A**S a service to its readers GIFT SUBSCRIPTIONS to ARCHITECT & ENGINEER magazine are available for this year's Christmas giving.

REGULAR SUBSCRIPTION Rate will apply:

United States and Pan America

\$3.00 a year: two years \$5.00

Foreign Countries \$5.00 a year

PLEASE SEND ARCHITECT & ENGINEER  
AS A GIFT To:

name..... occupation.....

address..... city..... zone..... state.....

Sign my gift card: From.....

name..... occupation.....

address..... city..... zone..... state.....

Sign my gift card: From.....

name..... occupation.....

address..... city..... zone..... state.....

Sign my gift card: From.....

Your Name.....

address..... city..... zone..... state.....

Enclosed is my check for.....

The Commercial Research Department which Breen will head at The Stanley Works is a centralized staff organization that will make available to all divisions of the company various types of research services and marketing information.

## DEFENSE CONSTRUCTION—ALASKA

(From Page 9)

finite line drawings and general criteria.

### FACILITIES

Facilities of the Alaska District to support work include approximately 1,500 pieces of government owned standard construction equipment and housing and messing at the large centers. Commercial facilities available to contractors are: year around docking at Seward and from April to November at Anchorage; local commercial plants and materials to support building construction, but with limited stock on hand; and water, air, railroad, and truck transportation.

Specifications for all work is in four parts. Part I, in general, is a brief description of the job. Part II covers general conditions normal for construction under government contracts. Part III covers special conditions regarding commencement and completion of work, drawings, inspection, payments, and other details applicable to the particular work described. Part IV covers technical specifications.

Government finance facilities are adequate to assure prompt payment of partial payment estimates. Partial payments are made as the work progresses at the end of each calendar month or as soon thereafter as is practicable.

### THE PROJECTS

Types of construction under the current program run the gamut from Alaska's largest building—a composite 6-story Army city under one roof at the Port of Whittier, through reinforced concrete barracks and service buildings and frame family quarters. In addition, all types of utility lines, water and sewage disposal plants, and asphalt paving jobs common to military ports are included in the Alaska Command program.

There is currently under contract about 1/4 billion dollars for construction, designs, and services. The projects scheduled for the 1952-1953 season expected to total about 170 million dollars additional, include:

Vehicle repair shops, gasoline stations, administration buildings, warm storage plants, Post Engineer facilities, telephone exchanges, indoor training facilities, refrigerated warehouses, maintenance shops, a bakery, port facilities, a laundry and dry cleaning plant, ammunition storage, a hospital, water and sewage treatment plants, theaters, ordnance and artillery shops, an Arctic train-

ing school, commissaries, a locomotive shop, a cold storage plant, barracks, bachelor quarters, family housing, central power and heating plants, bulk liquid fuel systems, utilities (including water, sewer, steam and electric lines), communication systems, fire stations, and many others.

With all these projects yet to be opened for bidding, there are obviously many opportunities for the contractor in defense construction in Alaska. The competitive bid system used in the public interest provides equal challenge to and fair practice for all contractors on one of the greatest construction programs in history.

Colonel Lyle E. Seeman, the Alaska District Engineer, Corps of Engineers, U. S. Army, invites contractor consideration of this tremendous market. Illuminating details and a thorough presentation of current and programmed projects appear in the 1952-1953 Prospectus of Construction.

## CLEARANCE OF BUILDINGS

(From Page 9)

moving train in time to prevent being struck. Aside from such employees being killed or injured, law suits follow such accidents and, of course, the responsible parties are sued under such circumstances.

As an example of some of the violations which we have recently noted are: a large battery manufacturing concern during the past year constructed a two-story building for a distance of 81 feet along the tail end of their spur track with a clearance of only 7'3" from the center line. This clearance should have been 8'6". The approximate cost of the building was \$100,000. This building is so constructed that it can only be altered at great expense and neither is there available space to move the tracks.

Therefore, the railroad company was obliged to stop service in advance of the impaired structure permitting no service to the building.

A public warehouse concern recently constructed a concrete retaining wall adjacent to its track with a clearance of only 5'3". This clearance should have been 8'6". The cost of the retaining wall amounted to \$1500. When the owner was notified of the impairment he held the contractor responsible and the final result, after an expensive lawsuit, found the contractor assuming the expense of relocating the wall.

In another instance, a large canning plant had installed on its loading platform a complicated system of can loading machinery with a clearance of only 7'6" from the center line of the track, where again it should have been 8'6". As the relocation of the machinery would be extremely expensive the industry negotiated with the railroad to move

## Notes on Quality LIGHTING:

Here in the West the installation assuring maximum lighting efficiency with minimum service and maintenance is, by every standard of comparison, SMOOT-HOLMAN. The hallmark of quality in better buildings is the presence of SMOOT-HOLMAN equipment.



The New D-P Seal-Lux, pictured above, is a vapor-light fluorescent luminaire built for high efficiency and rugged service life under the most exacting conditions.



- 1 Constellation Slimline fluorescent
- 2 D-P Line-Light
- 3 Collegiate Slimline fluorescent
- 4 Educator incandescent
- 5 PLM Standard Dome Reflector
- 6 The Master Floodlight
- 7 LH Ceiling light

SMOOT-HOLMAN COMPANY Lightwood, Calif. Offices in Principal Western Cities - Branch and Warehouse in San Francisco

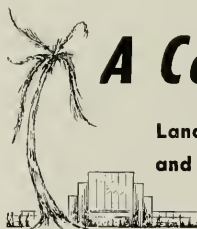

## A Combined

Landscape Architecture  
and Contracting Service

for

Tract, Industrial and Residential  
Development  
We can do the Complete Job for you

- Landscape Architecture
- Finish Grading and Landscaping
- Asphalt Drives and Parking Lots

**HENRY C. SOTO CORPORATION**  
*Landscape Contractors*

13000 SO. AVALON BLVD. LOS ANGELES 61, CALIF.  
Phone MEnlo 4-6617



Specify Utility equipment!—The one sure way to avoid the headaches of an installation that just doesn't measure up to your specifications. You're sure with Utility because it sets the industry standard for quality and performance.

#### A FULL RANGE OF UTILITY HEATING EQUIPMENT

**Floor Furnaces**—45,000 BTU/Hr. input, flat and dual; also, 60,000 BTU/Hr. input, flat and dual (both sizes, shallow-type construction). **Wall Heaters**:—Single—27,500 BTU/Hr. input; Dual—35,000 BTU/Hr. input and 50,000 BTU/Hr. input. **Forced Air Furnaces**—70,000 BTU/Hr. input to 150,000 BTU/Hr. input. **Unit Heaters**—65,000 BTU/Hr. input to 225,000 BTU/Hr. input. All Utility Heating Equipment is tested and approved by A.G.A.



#### UTILITY EVAPORATIVE AIR COOLERS AND VENTILATING EQUIPMENT FOR EVERY PURPOSE

Utility's air delivery tables are complete and authentic, derived from tests made in accordance with A.S.H.V.E. test codes. Every Utility cooler is tested in accordance with these same codes. You can meet every requirement with Utility. The line includes evaporative coolers, both Fan and Blower types... sizes to meet all requirements.

#### SEND FOR AIA ENGINEERING INFORMATION

For this complete technical data on Utility equipment, plus valuable tables, charts, installation details, write (on your letterhead) to Engineering Dept. Counsel from a Utility Engineer available without charge.

UTILITY APPLIANCE CORP.  
4851 S. Alameda Street, Los Angeles 58, California



EVAPORATIVE AIR COOLERS      GAS-FIRED FURNACES  
VENTILATING EQUIPMENT

Manufacturers of Gaffers & Sattler and Occidental Gas Ranges

the track away from the platform, which in this case was possible, the industry paying the cost of such track relocation amounting to \$900.

In our files we have thousands of such instances.

To avoid this needless expense a better way would be for the architect, builder or contractor contemplating construction of any kind adjacent to a railroad track to contact the Engineering Department of the railroad involved which maintains engineers who are available to explain the current clearance orders or to offer suggestions to any problems of construction.

In addition, all architects, engineers, contractors and builders should have a copy of the Public Utilities Commission clearance order which may be secured from the Secretary of the Commission at the State Building in San Francisco, or the Mirror Building in Los Angeles.

It is further pointed out that several of the states adjacent to California have railroad clearance orders and builders or others contemplating work in these states should familiarize themselves with these regulations.

#### A.I.A. ACTIVITIES

(From Page 25)

served his country during war time, and took an active part in a number of civic activities.

New members: Harry Lockland, Corporate, and Kenneth L. Hargreaves, Associate; James H. Blair, Jr., Associate.

#### NORTHERN CALIFORNIA CHAPTER

The relationship of the arts to architecture was the theme of a recent meeting with Alfred Frankenstein, art critic of the San Francisco Chronicle; Dr. Walter Horn, Art department of the University of California, and Alexander Fried, Art critic of the San Francisco Examiner taking part in the program.

There was also a general discussion of the proposed San Francisco City Charter amendment which would provide that a certain percentage of public projects costs be allocated to the enrichment of the projects through the use of such of the arts as sculpturing, murals, and landscaping.

#### OPENS ARCHITECTURAL OFFICE IN SAN JOSE, CALIFORNIA

Announcement has been made of the formation and opening of offices in San Jose, California, for the firm of Evans and Lincoln, John M. Evans, architect.

The new firm is comprised of John M. Evans, A.I.A., architect, and Harry A. Lincoln, and will follow a general practice of architecture.



## NEWS AND COMMENT ON ART

(From Page 8)

gon, and president of The American Institute of Architects.

Delegates to the four day convention represented students from the University of Illinois, Washington University at St. Louis, Pennsylvania State College; University of Kansas, University of Southern California, University of Virginia, University of Cincinnati, and Alabama Polytechnic Institute.

## UNITED GEOPHYSICAL

(From Page 15)

the architects design which provides movable walls in the research and engineering divisions.

The Research Division, responsible for the fundamental research and development, is well outfitted with an extensive library. Special facilities include new and unique measuring instruments, a model test hole, electrically shielded rooms, a high pressure test chamber, and research trucks.

The Engineering and Supply Division is especially outfitted to take equipment the research group has developed and furnishes the production engineering, finished design, manufacturing and procurement facilities. All mechanical engineering and electrical engineering is done in the Development Engineering Department. The Construction Department makes the electronic equipment, cameras, seismometers, galvanometers and all recording instruments. Custom built seismometers are constructed in a shop devoted entirely to this purpose. A complete machine shop is set up for making instruments, and an installation shop is maintained to outfit trucks with custom bodies and specialized geophysical equipment.

The service department which handles procurement and furnishes field crews with automotive and geophysical equipment occupies a large section of this division's building. The purchasing and supply groups have ample facilities for securing all of the supplies, and for making arrangements for customs, shipping, packing, labeling, and processing for docks, trains, or airports.

## CALIFORNIA SEEKING HIGH GRADE HOUSING OFFICIAL

The State of California is looking for a high grade housing official to take over the newly created position of Deputy Chief, Division of Housing.

The Division of Housing has over-all supervision of the state's housing needs and building and operating practices and carries on its program largely in cooperation with local communities.

In addition to his administrative responsibility for inspection, regulation and enforcement, the new official will have an important cooperative,

(See Page 36)

## BARRETT & HILP CONTRACTORS

*Builders of the West*

918 Harrison Street • San Francisco  
Telephone DOuglas 2-0700

234 West 37th Place • Los Angeles  
Telephone ADams 3-8161



### STOP

Penetration Of  
**MOISTURE  
WIND  
DUST  
VERMIN**

EVERLASTING  
PROTECTION

## FORDERER CORNICE WORKS

*Manufacturers of*

Hollow Metal Products • Interior Metal Trim  
Elevator Fronts and Cabs  
Metal Plaster Accessories • Sanitary Metal Base  
Flat and Roll Metal Screens  
Metal Cabinets • Commercial Refrigerators

269 POTRERO AVE.

SAN FRANCISCO, CALIF.

HEMLOCK 1-4100

## Parker, Steffens & Pearce BUILDERS

135 South Park, San Francisco

Phone: EXbrook 2-6639



**SISALATION**  
REFLECTIVE INSULATION

**COSTS 50%  
LESS THAN "BULK" or  
"BLANKET" TYPES OF INSULATION  
... AND, IN ADDITION, ACTS AS A VAPOR-  
BARRIER (MEETS FHA REQUIREMENTS). COSTS  
LESS TO APPLY. WRITE FOR SAMPLES AND  
FULL INFORMATION ON ALL USES!**

**The SISALKRAFT CO.**  
55 New Montgomery St. San Francisco 5, California

**JUDSON PACIFIC - MURPHY CORP.**

*Steel Fabricators  
and  
Erectors*

**REINFORCING STEEL  
STRUCTURAL STEEL  
BRIDGE CRANES**

4300 EASTSHORE HWY. Phone:  
EMERYVILLE, CALIF. OL 3-1717

**CLINTON  
CONSTRUCTION CO.**  
OF CALIFORNIA

**General Contractors**

923 FOLSOM STREET • SAN FRANCISCO

SUtter 1-3440

**HOGAN LUMBER CO.**

*Wholesale and Retail*

**LUMBER**

---

**MILL WORK • SASH & DOORS**

---

*Office, Mill, Yard and Docks*  
SECOND AND ALICE STREETS • OAKLAND, CALIF.  
Telephone GLencourt 1-6861

**BOOK REVIEWS  
PAMPHLETS AND CATALOGUES**

**ESSENTIALS IN PROBLEM SOLVING.** By Zuce Kogan. 724 Sheridan Road, Chicago, Ill.

A book designed by the author to teach others "a method of doing things." "When one tries to learn a trade or put to practical use something he has learned in school, his first attempts are usually clumsy. Gradually, he learns not only how to do things, but the best ways of doing them," declares the author in his introduction to the book.

The material has been written and prepared for the practical man who must "take the bull by the horns and produce results quickly" and efficiently.

**CATHEDRALS—And How They Were Built.** By D. H. S. Cranage. Published by Cambridge University Press, 32 E. 57th. New York. Price \$2.50.

The builders of the great cathedrals and churches of medieval Europe, in whatever style they worked, were not only glorifying God, exercising their craft as masons and carvers, creating works of art; they were also solving according to their ability problems inherent to the nature of their task and in the materials to hand.

Dr. Cranage offers in this book a clear account, without necessary technicalities, of certain major principles in gothic and romanesque. There is a chapter on the dome, exemplified by Santa Sophia and St. Paul. Throughout the book word and picture go together as the general principles in the text are illustrated in detail.

**AN APPROACH TO DESIGN.** By Norman T. Newton. Published by Addison-Wesley Press, Inc., Cambridge, Mass. Price \$3.50.

The book has grown out of a series of talks and discussions with students entering the classes in architecture, landscape architecture and city planning at the Harvard School of Design. Material has been compiled since 1946 and represents a phase supplemental to the technical work of drafting room courses in problem solving as it is designed to encourage each individual student, whatever his profession, to develop within himself, consciously and to his own satisfaction, an attitude toward the unified field of design that would serve him as a broad and soundly flexible basis for creative work.

**NEW CATALOGUES AVAILABLE**

*Any of the catalogues or folders described here may be obtained by forwarding your request as indicated in the coupon below to the office of the ARCHITECT & ENGINEER. Merely mark the items you want and clip or paste the coupon to your letterhead.*

**330. MAGNESIA INSULATION.** Eighty-five per cent Magnesia insulation and other insulating products are described in a new two-color bulletin just released by Ehret Magnesia Manufacturing Company. The bulletin presents characteristics and advantages of Ehret Thermalite 85% Magnesia Insulation for covering pipe, fittings and equipment. Tables include recommended insulation thicknesses for various temperature ranges. The copy summarizes recommended application procedure. 4h, 8 pages illus., 9/51.

**331. RUBBERFLEX SEALED HANDLE FLUSH VALVE.** An illustrated brochure is available on the Coyne & Delaney Flush valves which now all feature the "Rubberflex" sealed handle unit. The "Rubberflex" unit has been fatigue-tested in the laboratory and commercially for over two years and the danger of sticking and leaking handles has been reduced to a practical minimum. A.I.A. 29-H-21, 4 pages illus., 10/51.

**332. METHOD FOR SETTING FLOOR BRICK.** How to install floor brick and heavy tile to produce a floor with exceptional durability is the subject of a new four-page illustrated bulletin published by The Master Builders Co. Discussing the importance of narrow, tight joints in obtaining long life where corrosive conditions exist, this bulletin tells how floors with joints down to 1/8" can be installed by using a readily flowable, non-shrink mortar produced with Embeco. In addition to presenting information and data of interest to both those who install, and use, floor brick and heavy tile floors, the bulletin gives complete specifications. A page showing job pictures is devoted to "Suggestions for Using Embeco to Set Floor Brick and tile." E 27, 4 pages, illus., 11/51.

**333. PRE-FABRICATED STEEL PARKING STRUCTURE.** A new type Multi-Deck steel parking structure completely pre-labrated on six basic modular parts is described in a brochure just released by the Hollingsworth Multi-Deck Corp. The brochure illustrates the usages of this type parking structure which can be disassembled if needed and can be built up to four stories in height. 12 pages, illus., 11/51.

**334. HELPFUL GYM MARKING CHARTS.** Attracting welcome response from hundreds of architects, coaches, and physical education directors, is Hillyard's new AIA date file 25-G. This new chart accurately blue prints standard court markings for basket ball, volley ball, and every gym activity. Planned as a practical work-guide, Hillyard Chemical Company has designed it in regulation 11"x8 1/2" easy-to-file architectural style. The folder cover is an actual blueprint diagram of a gym with standard court markings scaled to size for "on sight" reference. Measurements include those for junior high school age, high school age and college age. The back cover pictures the six procedure steps for doing the job correctly, in the easiest, most economical manner. A.I.A. 25-G, 11/51.

**335. LOAD BEARING BRICK OR TILE WALLS.** The Structural Clay Products Institute has issued a bulletin showing how brick and structural tile can be used in many buildings to eliminate completely the use of critical metals or to reduce their use to a very minimum, it was announced by C. Forrest Tefft, president of the institute. "Load-bearing brick or tile walls can be used to eliminate entirely the use of structural steel in buildings of three stories or less," Mr. Tefft said. "Reinforced brick masonry walls will permit the construction of buildings of greater height and still make possible sizable savings in the use of structural steel." DPA 121, 8 pages illus. 9/51.

**336. RADIANT AND ACOUSTICAL CEILING.** Architectural Products Division of the Burgess-Manning Company announced that it has available for free distribution a new bulletin on Burgess-Manning Ceiling, which incorporates radiant heating and cooling with acoustical control. The bulletin describes the latest developments of this ceiling and explains the principles of radiant heating, the ceiling components, its performance, typical specifications, installation data, applications. AIA 17-A, 8 pages illus. 9/51.

**337. PRE-CAST UNI-BOND COMPOSITION SLEEPERS.** A complete file size specification and job installation set of instruction sheets has just been released on Pre-Cast Uni-Bond Composition Sleepers by the LeRoy Olson Co. Descriptions of the different uses of these composition floor sleepers and their uses in different types of subflooring as an engineered floor base for nailing on cement blocks is covered. This system is outlined for use in spring floors with ventilation. AIA 23-D, 27 pages, illus. 8/27/51.

#### ARCHITECT AND ENGINEER

68 Post Street, San Francisco, Calif.

I would like to have a copy of each of the New Catalogues I have circled.

330	331	332	333
334	335	336	337

Please send to the address on my letterhead, or as I have indicated, and to my attention. (Please print your name — no literature will be sent on this coupon after January, 1952.—A. & E.)

#### D. R. WAUGH APPOINTED GENERAL SALES MANAGER

D. R. Waugh has been named General Sales Staff Manager of Columbia Steel Company, according to a recent announcement by Marcus J. Aurelius, company vice president.

A graduate of the University of Illinois, Waugh started his business career in 1933 as sales representative of the Franklin County Coal Company in Wisconsin, and following a variety of sales positions joined the Columbia Steel Company in 1949 in the sales department.

## PACIFIC MANUFACTURING CO.

High Class Interior Finish Quality  
Millwork

16 Beale St., San Francisco  
GARfield 1-7755

2215 El Camino Real, San Mateo  
S. M. 5-0687

304 Bryant Street, Palo Alto  
P. A. 3373

2610 The Alameda, Santa Clara  
S. C. 607 (Factory)

6820 McKinley Avenue, Los Angeles  
THornwall 4196

MAIN OFFICE — SANTA CLARA

## "AMERICAN - MARSH" CONDENSATION UNIT

Pumping  
Machinery  
for  
Every  
Purpose

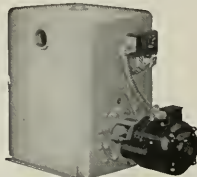

For Service  
Call  
DOUGLAS  
2-6794  
or  
MUtual 8322

**SIMONDS MACHINERY CO.**  
SAN FRANCISCO 816 FOLSOM  
LOS ANGELES 455 EAST 4TH

## VERMONT MARBLE COMPANY

DOMESTIC AND IMPORTED MARBLES  
GRANITE VENEER

525 MARKET STREET • SAN FRANCISCO

Phone: SUtter 1-6747

3522 COUNCIL STREET • LOS ANGELES

Phone: DUkirk 2-7831

The Most Complete Line of  
STEELS and STEEL BUILDING MATERIALS  
Made by a Single Producer



See Sweet's Catalog File or write us for  
full information.

### REPUBLIC STEEL CORPORATION

GENERAL OFFICES: CLEVELAND, OHIO

DENVER, COLORADO . . . CONTINENTAL OIL BUILDING  
LOS ANGELES, CALIF. . . GENERAL PETROLEUM BUILDING  
SAN FRANCISCO, CALIFORNIA . . . RIALTO BUILDING  
SEATTLE, WASH. . . . . WHITE-HENRY-STUART BUILDING

liaison role. The new deputy chief will be a civil service employee, examinations will be given early in January.

### FRANK T. SHEETS DIES SUDDENLY IN CHICAGO

Frank T. Sheets, 61, president of the Portland Cement Association since 1937 and nationally known highway engineer, died suddenly early in November at a Chicago hospital.

Prior to joining the Association Sheets served as chief highway engineer and superintendent of highways for the state of Illinois. He also served as president of the American Association of State Highway Officials; president of the Central Illinois section of the American Society of Civil Engineers and an official delegate from the United States to the Pan-American Highway Congress at Rio de Janeiro in 1929.

### MILITARY PUBLIC WORKS PROGRAM UNDER REVIEW

A re-valuation of the military construction program of the Department of Defense to determine items of greatest urgency and effect maximum economy has been undertaken by the military departments.

The review was made necessary by the passage of the \$3,890,296,392 Military Public Works Appropriation Act of 1952, which allocates among the military services the following amounts: Army, \$1,000,000,000; Navy, \$819,096,392; and the Air Force, \$3,890,296,392.

The program reviews are expected to result in the postponement of some items at many of the stations where construction was planned, rather than the elimination of entire station programs.

### ELECTED PRESIDENT CALIFORNIA MANUFACTURERS ASSOCIATION

William A. DeRidder, Chairman of the Board of General Metals Corporation, has been elected president of the California Manufacturers' Association.

His wide experience and familiarity with the problems of West Coast manufacturing assures the Association of outstanding leadership during the coming year.

Other officers elected were Ralph M. Hoffman, vice-president; Dr. Robert Cutter, treasurer, and George S. Wheaton, secretary.

### NEW PLASTIC ARMORED METAL TUBING DEVELOPED

Samuel Moore & Company, manufacturers of Dekoron plastic armored metal tubing, has announced the addition of square, triangular, oval and streamlined shapes to their standard line of round tubing.

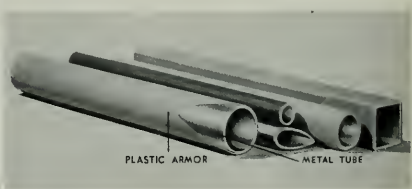

Made in a large variety of sizes, colors, and finishes, the new tubing can be used in industrial and consumer applications, such as furniture, appliances, garment rails, crowd control rails, grab rails and stanchions in transit vehicles, sporting goods, automotive parts, industrial instrument lines and electrical conduit. It will not crack, chip, peel or flake, and resists corrosion from salt air, moisture, oils, acids, and alkalis.

### CRITICAL DEFENSE HOUSING

The areas adjacent to Colorado Springs, Colo., and Tucson, Ariz., as well as the cities themselves have been designated critical defense housing areas by the Defense Production Administration.

## VALUABLE NEWS SERVICE

- BUILDING MATERIAL DEALERS
- CONTRACTORS
- ENGINEERS
- FINANCIAL INSTITUTIONS

**ARCHITECTS REPORTS** gives advance news on construction projects in Northern California, lists: name of projects, location, architect, proposed cost and other pertinent information.

**HANDY** individual slip-reports, issued daily at a total cost of only

\$10 a month

## ARCHITECT'S REPORTS

Published Daily

The ARCHITECT and ENGINEER, Inc.

68 Post Street, San Francisco - DO 8311



# ESTIMATOR'S GUIDE

## BUILDING AND CONSTRUCTION MATERIALS

PRICES GIVEN ARE FIGURING PRICES AND ARE MADE UP FROM AVERAGE QUOTATIONS FURNISHED BY MATERIAL HOUSES TO SAN FRANCISCO CONTRACTORS. 3% SALES TAX ON ALL MATERIALS BUT NOT LABOR

All prices and wages quoted are for San Francisco and the Bay District. There may be slight fluctuation of prices in the interior and southern part of the state. Freight cartage, at least, must be added in figuring country work.

**BONDS—Performance or Performance plus Labor and Material Bond(s), \$10 per \$1000 on contract price. Labor & Material Bond(s) only, \$5.00 per \$1000 on contract price.**

### BRICKWORK—MASONRY—

Common Brick—Per 1 M laid—\$100.00 up (according to class of work).  
Face Brick—Per 1 M laid—\$200.00 and up (according to class of work).  
Brick Steps—\$3.00 and up.  
Common Brick Veneer on Frame Bldgs.—Approx. \$1.20 and up—(according to class of work).  
Face Brick Veneer on Frame Bldgs.—Approx. \$2.00 and up (according to class of work).  
Common Brick—\$36.00 per M—truckload lots, delivered.  
Face Brick—\$81.00 to \$106.00 per M, truckload lots, delivered.

### Glazed Structural Units—

Clear Glazed—  
2 x 6 x 12 Furring ..... \$1.60 per sq. ft.  
4 x 6 x 12 Partition ..... 1.90 per sq. ft.  
4 x 6 x 12 Double Faced Partition ..... 2.25 per sq. ft.  
For colored glaze add ..... .30 per sq. ft.

Market Fire Brick—\$105.00 per M—F.O.B. Pittsburgh.  
Fire Brick—Per M—\$111.00 to \$147.00.  
Cartage—Approx. \$10.00 per M.

### Paving—\$75.00.

**Building Tile—**  
8x8x12-inches, per M ..... \$139.50  
6x5x12-inches, per M ..... 105.00  
4x2x12-inches, per M ..... 84.00

**Hollow Tile—**  
12x12x2-inches, per M ..... \$146.75  
12x12x3-inches, per M ..... 156.85  
12x12x4-inches, per M ..... 177.10  
12x12x6-inches, per M ..... 235.30  
F.O.B. Plant

### BUILDING PAPER & FELTS

1 ply per 1000 ft. roll ..... \$5.30  
2 ply per 1000 ft. roll ..... 7.20  
3 ply per 1000 ft. roll ..... 9.70  
Brownkin, Standard 500 ft. roll ..... 6.85  
Sisalcraft, reinforced, 36 in. by 500 ft. roll ..... 7.00

### Sheathing Papers—

Asphalt sheathing, 15-lb. roll ..... \$2.00  
30-lb. roll ..... 2.79  
Dampcourse, 216-ft. roll ..... 2.95  
Blue Plysterboard, 60-lb. roll ..... 5.10

### Felt Papers—

Deadenng felt, 3/4-lb., 50-ft. roll ..... \$3.23  
Deadenng felt, 1-lb., ..... 3.79  
Asphalt roofing, 15-lbs. ..... 2.20  
Asphalt roofing, 30-lbs. ..... 2.79

### Roofing Papers—

Asphalt Flg., 15 lb. ..... \$2.09  
Standard Grade, 108-ft. roll, Light ..... 1.27  
Smooth Surface, Medium ..... 2.18  
Heavy ..... 2.56  
M. S. Extra Heavy ..... 2.96

### BUILDING HARDWARE—

3x8 cord com. No. 7 ..... \$2.65 per 100 ft.  
3x8 cord com. No. 8 ..... 3.90 per 100 ft.  
3x8 cord spot No. 7 ..... 3.65 per 100 ft.  
3x8 cord spot No. 8 ..... 3.35 per 100 ft.  
Sash weights, cast iron, \$100.00 ton ..... \$3.75  
1-Ton lots, per 100 lbs. ..... \$3.75  
Less than 1-ton lots, per 100 lbs. ..... \$4.75  
Nails, per keg, base ..... 11.80  
8-in. spikes ..... 11.80  
Rim knob lock sets ..... 1.80  
Butts, dull brass plated on steel, 3/8x3/4 ..... .76

### CONCRETE AGGREGATES—

The following prices net to Contractors unless otherwise shown. Carload lots only.

	Bunker per ton	Del'd per ton
Gravel, all sizes	\$2.44	\$2.90
Top Sand	2.38	3.13
Concrete Mix	2.38	3.06
Crushed Rock, 1/2" to 3/4"	2.38	2.90
Crushed Rock, 3/4" to 1 1/2"	2.38	2.90
Roofing Gravel	2.81	2.90
River Sand	2.50	3.00
Sand—		
Lapis (Nos. 2 & 4)	3.56	3.94
Olympia (Nos. 1 & 2)	3.56	3.88

### Cement—

Common (all brands, paper sacks), carload lots, \$3.55 per bbl. f.o.b. car; delivered \$3.60.  
Per Sack, small quantity (paper) ..... \$1.05  
Carload lots, in bulk per bbl ..... 2.79  
Cash discount on carload lots, 10c a bbl. 10th Prox. less than carload lots \$4.00 per bbl. f.o.b. warehouse or delivered.  
Cash discount 2% on L.C.L.  
Trinity White } 1 to 100 sacks, \$3.13 sack  
Medusa White } warehouse or del.; \$9.55  
bbl. carload lots.

### CONCRETE READY-MIX—

1-2-4 mix, to 10 yards ..... \$12.00  
10 to 100' yards ..... 11.00  
100 to 500 yards ..... 10.50  
Over 500 yards ..... 10.30  
\* Delivered to site.

### CONCRETE BLOCKS—

	Hay-dite	Bo-salt
4x8x16-inches each	\$.17	\$.18
6x8x16-inches, each	\$.22	\$.25
8x8x16-inches, each	\$.26	\$.36
12x8x16-inches, each	\$.34	\$.39
12x8x24-inches, each	—	.40

### Haydite Aggregates—

3/4-inch to 3/8-inch, per cu. yd. .... \$7.25  
3/8-inch to 3/16-inch, per cu. yd. .... 7.25  
No. 6 to 0-inch, per cu. yd. .... 7.25

### DAMP-PROOFING and Waterproofing—

Two-coat work, \$9.00 per square.  
Membrane waterproofing—4 layers of saturated felt, \$10.00 per square.  
Hot coating work, \$5.00 per square.  
Medusa Waterproofing, \$3.50 per lb. San Francisco Warehouse.

Tricoat concrete waterproofing, 60c a cubic yd. and up.

### ELECTRIC WIRING—\$15 to \$20 per outlet for conduit work (including switches).

Knob and tube average \$6.00 per outlet.

### ELEVATORS—

Prices vary according to capacity, speed and type. Consult elevator companies. Average cost of installing a slow speed automatic passenger elevator in small four story apartment building, including entrance doors, about \$9,500.00.

### EXCAVATION—

Sand, \$1.00; clay or shale, \$1.50 per yard. Trucks, \$30 to \$45 per day.

Above figures are an average without water. Steam shovel work in large quantities, less; hard material, such as rock, will run considerably more.

### FIRE ESCAPES—

Ten-foot galvanized iron balcony, with stairs, \$250 installed on new buildings; \$300 on old buildings.

### FLOORS—

Asphalt Tile, 1/8 in. gauge 18c to 35c per sq. ft.

Composition Floors, such as Magnesite, 40c-\$1.25 per sq. ft.

Linoleum, standard gauge, sq. yd. .... \$2.75  
Mastipave—\$1.50 per sq. yd.

Battleship Linoleum—1/8"—\$3.00 sq. yd.

Terazzo Floors—\$1.50 per sq. ft.

Terazzo Steps—\$2.50 per lin. ft.

Mastic Wear Coat—according to type—20c to 35c.

### Hardwood Flooring—

Oak Flooring—T & G—Unfin.—

	1 1/2 x 2 1/4	1 1/2 x 2 1/2	1 1/2 x 2 3/4	1 1/2 x 3
Clear Old, White	\$425	\$405	\$385	\$365
Clear Old, Red	405	380	355	330
Select Old, Red or White	355	340	325	315
Clear Fin., Red or White	355	340	330	325
Select Fin., Red or White	340	330	325	320
#1 Common, Red or White	315	310	305	290
#2 Common, Red or White	305	300	295	280

### Prerefined Oak Flooring—

	Prime	Standard
1/2 x 2	\$349.00	\$359.00
1/2 x 2 1/4	380.00	370.00
1/2 x 2 1/2	390.00	381.00
1/2 x 2 3/4	375.00	355.00
3/4 x 3/4	395.00	375.00
1/2 x 2 1/4 & 3/4 Ranch Plank	—	415.00

### Unfinished Maple Flooring—

1/2 x 2/4 First Grade	\$390.00
1/2 x 2/4 2nd Grade	365.00
1/2 x 2/4 2nd & 8tr. Grade	375.00
1/2 x 2/4 3rd Grade	240.00
1/2 x 3/4 3rd & Btr. Jtd. EM.	380.00
1/2 x 3/4 2nd & Btr. Jtd. EM.	390.00
3/8 3/2 x 2/4 First Grade	400.00
3/8 3/2 x 2/4 2nd Grade	360.00
3/8 3/2 x 2/4 3rd Grade	320.00
Floor Layer' Wage \$2.50 hr.	

### GLASS—

Single Strength Window Glass ..... \$ .30 per sq. ft.  
Double Strength Window Glass ..... 45¢ per sq. ft.  
Plate Glass, 1/4 polished to 75 ..... 1.60 per sq. ft.  
75 to 100 ..... 1.74 per sq. ft.  
1/4 in. Polished Wire Glass ..... 2.35 per sq. ft.  
1/4 in. Rgh. Wire Glass ..... .71 per sq. ft.  
1/4 in. Polished Wire Plate Glass ..... 2.00 per sq. ft.  
1/4 in. Rgh. Wire Glass ..... .44 per sq. ft.  
1/8 in. Obscure Glass ..... .40 per sq. ft.  
3/8 in. Obscure Glass ..... .44 per sq. ft.  
1/8 in. Heat Absorbing Obscure ..... .58 per sq. ft.  
1/4 in. Heat Absorbing Wire ..... .85 per sq. ft.  
Glazing of above additional \$1.5 to .30 per sq. ft.  
Glass Blocks, set in place ..... 3.50 per sq. ft.

### HEATING—

Average, \$3.50 to \$4.00 per sq. ft. of radiation, according to conditions.  
Warm air (gravity) average \$64 per register.  
Forced air average \$91 per register.

## INSULATION AND WALLBOARD—

Rockwool Insulation—	
(2") Less than 1,000 sq ft.....	\$64.00
(2") Over 1,000 sq ft.....	\$9.00
Cotton Insulation—Full thickness	
(3 1/2").....	\$95.50 per M sq. ft.
Sisalation Aluminum Insulation—Aluminum coated on both sides.....	\$73.50 per M sq. ft.
Tileboard—4 1/2" panel.....	\$9.00 per panel
Wallboard—1/2" thickness.....	\$95.00 per M sq. ft.
Finished Plank.....	\$69.00 per M sq. ft.
Coined Tileboard.....	\$67.00 per M sq. ft.

**IRON**—Cost of ornamental iron, cast iron, etc., depends on designs.

## LUMBER—

S4S No. 2 and better common	
O.P. or D.F., per M. f. b. m.....	\$100.00
Rough, No. 2 common O.P. or	
D.F., per M. f. b. m.....	100.00

## Flooring—

	Per M Delvd.
V.G.-D.F. 8 & 8tr. 1 x 4 T & G Flooring.....	\$225.00
"C" and better—all.....	225.00
"D" and better—all.....	225.00
Rwd. Rustic—"A" grade, medium dry.....	185.00
8 to 24 ft.	

Plywood, per M sq. ft.	
1/2-inch, 4,000-515.....	\$170.00
3/4-inch, 4,000-515.....	250.00
5/8-inch, per M sq. ft.....	315.00
Plywood.....	11 1/2¢ per ft.
Plyform.....	25¢ per ft.

Shingles (Rwd. not available)—	
Red Cedar No. 1—\$9.50 per square; No. 2, \$7.00;	
No. 3, \$5.00.	
Average cost to lay shingles, \$6.00 per square.	
Cedar Shakes—1/2" to 3/4" x 24/26 in. handsplit	
topered or split resawn, per square.....	\$15.25
3/4" to 1 1/4" x 24/26 in. split resawn,	
per square.....	17.00
Average cost to lay shakes—8.00 per square	
<b>Pressure Treated Lumber—</b>	
Wolmanized.....	Add \$35 per M to above
Crested.....	
8-lb. treatment.....	Add \$45 per M to above

**MARBLE**—(See Dealers)

## METAL LATH EXPANDED—

Standard Diamond, 3/40, Copper	
Bearing, LCL, per 100 sq. yds.....	\$43.50
Standard Ribbed, ditto.....	\$47.50

## MILLWORK—Standard.

D. F. \$150 per 1000. R. W. Rustic \$175	
per 1000 (delivered).	
Double hung bow window frames, average	
with trim, \$12.50 and up, each.	
Complete door unit, \$15 to \$25.	
Screen doors, \$8.00 to \$12.00 each.	
Patent screen windows, \$1.25 a sq. ft.	
Cases for kitchen pantries seven ft. high,	
per lineal ft., upper \$9.00 to \$11.00;	
lower \$12.00 to \$13.00.	
Dining room cases, \$20.00 per lineal foot.	
Rough and finish about \$1.00 per sq. ft.	
Labor—Rough carpentry, warehouse heavy	
framing (average), \$75.00 per M.	
For smaller work average, \$85.00 to \$100,	
per 1000.	

## PAINTING—

Two-coat work.....	per yerd 85c
Three-coat work.....	per yerd \$1.10
Cold water painting.....	per yerd 25c
Whitewash no.....	per yerd 15c
Linseed Oil, Strictly Pure.....	Wholesale
(Basis 7 1/2 lbs. per gal.).....	Raw \$3.44
Light iron drums.....	per gal. \$2.28
5-gallon cans.....	per gal. 2.40
1-gallon cans.....	each 2.52
Quart cans.....	each .72
Pint cans.....	each .38
1/2-pint cans.....	each .24
Turpentine.....	Pure Gum
(Basis, 7.2 lbs. per gal.).....	Spirits
Light iron drums.....	per gal. \$1.65
5-gallon cans.....	per gal. 1.76
1-gallon cans.....	each 1.88
Quart cans.....	each .54
Pint cans.....	each .31
1/2-pint cans.....	each .20

Pioneer White Lead in Oil Heavy Paste and		
All-Purpose (Soft-Paste)		
Net Weight per 100 lbs.	List Price	Price to Painters
Packed.....	per 100 lbs.	pkgs.
100-lb. kegs.....	\$28.35	\$29.35
50-lb. kegs.....	30.05	15.03
25-lb. kegs.....	30.35	7.59
5-lb. cans.....	31.35	1.34
1-lb. cans.....	36.00	.36
500 lbs. (one delivery).....	per pound less than	
above.....	above only.	

## Pioneer Dry White Lead—Litharge—Dry Red Lead

—Red Lead in Oil		
Price to Painters—Price per 100 Pounds		
Products	100 lbs.	50 lbs.
Dry White Lead.....	\$26.30	\$5.00
Litharge.....	25.95	26.60
Dry Red Lead.....	27.20	27.85
Red Lead in Oil.....	30.65	31.30
Pound cans, \$37 per lb.		

## PATENT CHIMNEYS—

6-inch.....	\$2.50 lineal foot
8-inch.....	3.00 lineal foot
10-inch.....	4.00 lineal foot
12-inch.....	5.00 lineal foot

## PLASTER—

Neat wall, per ton delivered in S. F. in paper bags, \$17.60.

## PLASTERING (Interior)—

3 Coats, metal lath and plaster.....	Yerd	\$3.00
Keene cement on metal lath.....	3.50	
Ceilings with 3/4 hot roll channels metal lath		
(lath only).....	3.00	
Ceilings with 3/4 hot roll channels metal lath		
plastered.....	4.50	
Single partition 3/4 channel lath 1 side (lath		
only).....	3.00	
Single partition 3/4 channel lath 2 inches		
thick plastered.....	8.00	
4-inch double partition 3/4 channel lath 2		
sides (lath only).....	5.75	
4-inch double partition 3/4 channel lath 2		
sides plastered.....	8.75	
Thermax single partition; 1" channels; 2 1/4"		
overall partition width. Plastered both		
sides.....	7.50	
Thermax double partition; 1" channels; 4 1/4"		
overall partition width. Plastered both		
sides.....	11.00	
3 Coats over 1" Thermax nailed to one side		
wood studs or joists.....	4.50	
3 Coats over 1" Thermax suspended to one		
side wood studs with spring sound isolation		
clip.....	5.00	
Note—Channel lath controlled by limitation		
orders.		

## PLASTERING (Exterior)—

2 coats cement finish, brick or concrete.....	Yerd	\$2.50
3 coats cement finish, No. 18 gauge wire		
mesh.....	3.50	
Lime—\$4.00 per bbl. at yard		
Processed LLime—\$4.15 per bbl. at yard.		
Rock or Grip Lath—3/8"—\$30¢ per sq. yd.		
Stucco—29¢ per sq. yd.		
Composition Stucco—\$4.00 sq. yard (ap-		
plied).		

## PLUMBING—

From \$200.00 per fixture up, according to grade, quality and runs.

## ROOFING—

"Standard" tar and gravel, 4 ply—\$11.00	
per sq. for 30 sqs. or over.	
Less than 30 sqs. \$14.00 per sq.	
Tile \$40.00 to \$50.00 per square.	
No. 1 Redwood Shingles in place,	
4/2 in. exposure, per square.....	\$18.25
5/2 No. 1 Cedar Shingles, 5 in. ex-	
posure, per square.....	14.50
5/8 x 16"—No. 1 Little Giant Cedar	
Shingles, 5" exposure, per square.....	18.25

4/2 No. 1-24" Royal Cedar Shingles	
7/2" exposure, per square.....	23.00
Re-coat with Gravel \$5.50 per sq.	
Asbestos Shingles, \$27 to \$35 per sq. laid.	
1/2 to 3/4 x 25" Resawn Cedar Shakes	
10" Exposure.....	\$30.00
3/4 to 1 1/4 x 25" Resawn Cedar Shakes.	
10" Exposure.....	\$35.00
1 x 25" Resawn Cedar Shakes.	
10" Exposure.....	\$22.00
Above prices are for shakes in place.	

## SEWER PIPE—

C.I. 6-in. to 24-in. B. & S. Class B	
and heavier, per foot.....	\$99.50
Vitrified, per foot: L.C.L. F.O.B. Ware-	
house, San Francisco,	
Standard, 8-in.....	\$6.66
Standard, 12-in.....	1.30
Standard, 24-in.....	5.41
Clay Drain Pipe, per 1,000 L.F.	
L.C.L., F.O.B. Warehouse, San Francisco:	
Standard, 6-in. per M.....	\$240.00
Standard, 8-in. per M.....	400.00

## SHEET METAL—

Windows—Metal, \$2.50 a sq. ft.	
Fire doors (average), including hardware	
\$2.80 per sq. ft., size 12x12'. \$3.75 per	
sq. ft., size 3'x6'.	

## SKYLIGHTS—(not glazed)

Copper, \$1.25 sq. ft. (flat).	
Galvanized iron, 65c sq. ft. (flat).	
Vented hip skylights, \$1.50 sq. ft.	

## STEEL—STRUCTURAL—

\$220 per ton erected, when out of mill. \$270 per ton erected, when out of stock.

## STEEL REINFORCING—

\$200.00 per ton, in place.	
1/4-in. Rd. (Less than 1 ton).....	\$8.40
3/8-in. Rd. (Less than 1 ton).....	7.30
1/2-in. Rd. (Less than 1 ton).....	7.00
5/8-in. Rd. (Less than 1 ton).....	6.75
3/4-in. & 7/8-in. Rd. (Less than 1 ton).....	6.65
1-in & up (Less than 1 ton).....	6.60
1 ton to 5 tons, deduct 25c.	

## STORE FRONTS (None available).

## TILE—

Ceramic Tile Floors—Commercial \$1.20 to \$1.60	
per sq. ft.	
Cove Base—\$1.40 per lin. ft.	
Quarry Tile Floors, 6x6" with 6" base @ \$1.35	
per sq. ft.	
Tile Wainscots & Floors, Residential, 4 1/4x4 1/4", @	
\$1.65 to \$2.00 per sq. ft.	
Tile Wainscots, Commercial Jobs, 4 1/4x4 1/4" Tile,	
@ \$1.50 to \$1.65 per sq. ft.	
Asphalt Tile Floor 1/2" 8x8" @ .18 - .35 sq. yd.	
Light shades slightly higher.	
Cork Tile—\$ .70 per sq. ft.	
Mosaic Floors—See dealers.	
Lino-Tile—\$1.00 per sq. ft.	
Rubber Tile—\$ .55 to \$ .75 per sq. ft.	
Building Tile—	
8 1/2x12-inches, per M.....	\$139.50
6 1/2x12-inches, per M.....	105.00
4 1/2x12-inches, per M.....	84.00
Hollow Tile—	
12x12x2-inches, per M.....	146.75
12x12x3-inches, per M.....	156.85
12x12x4-inches, per M.....	177.10
12x12x6-inches, per M.....	235.30
F.O.B. Plant	

## VENETIAN BLINDS—

75c per square foot and up. Installation extra.

## WINDOWS—STEEL—INDUSTRIAL

Cost depends on design and quality required.

# ARCHITECT AND ENGINEER ESTIMATOR'S DIRECTORY

## Building and Construction Materials

EXPLANATION—Building and construction materials are shown in major classified groups for general identification purposes with names and addresses of suppliers of materials listed in detail under group classification where name first appears—main offices are shown first with branch or district offices following. The numeral appearing in listings refers to the major group classification where complete data on the dealer, or representative, may be found.

### AIR CONDITIONING (b)

Air Conditioning & Cooling  
UTILITY APPLIANCE CORP.  
Los Angeles 58, 4851 S. Alameda St.  
San Francisco, 1355 Market St., UN 1-4908

### ARCHITECTURAL VENEER (a)

Ceramic Veneer  
PACIFIC CLAY PRODUCTS  
San Francisco: 605 Market St., GA 1-3970  
Los Angeles, Portland, Salt Lake City  
GLADDING, McBEAN & CO. \*(1)  
Porcelain Veneer  
PORCELAIN ENAMEL PUBLICITY BUREAU  
(Dept. AE-450)  
Room 601, Franklin Building, Oakland 12, California  
P. O. Box 186, East Pasadena Station, Pasadena 8,  
California

Granite Veneer  
VERMONT MARBLE COMPANY  
San Francisco 5: 525 Market Street, SU 1-6747  
Los Angeles 4: DU 2-7834  
Marble Veneer  
VERMONT MARBLE COMPANY  
San Francisco 5: 525 Market Street, SU 1-6747  
Los Angeles 4: DU 2-7834

BANKS-FINANCING (1b)  
CROCKER FIRST NATIONAL BANK OF S. F.  
San Francisco, Post & Montgomery St's., EX 2-7700

BRASS PRODUCTS (1a)  
GREENBERG'S, M. & SONS  
San Francisco, Calif.: 765 Folsom, EXbrook 2-3143

BRICKWORK (11)  
Face Brick  
GLADDING, McBEAN & CO.  
San Francisco: Harrison at 9th Sts., UN 1-7400  
Los Angeles: 2901 Los Feliz Blvd., OL 2121  
Offices at Portland, Seattle, Spokane  
KRAFTILE  
Niles, California, Niles 3611  
San Francisco 5: 50 Hawthorne St., DO 2-3780  
Los Angeles: 131 406 South Main St., MU 7241  
REMILLARD-DANDINI CO.  
San Francisco: 400 Montgomery St., EX 2-4988

BRONZE PRODUCTS (1b)  
GREENBERG'S, M. & SONS  
San Francisco, Calif.: 765 Folsom, EXbrook 2-3143

BUILDING PAPER & FELTS (2)  
SISALKRAFT COMPANY  
San Francisco: 55 New Montgomery St., EX 2-3066  
Chicago, Ill.: 205 West Wacker Drive  
ANGIER PACIFIC CORP.  
San Francisco 5: 55 New Montgomery St., DO 2-4416  
Los Angeles: 7424 Sunset Boulevard

BUILDING HARDWARE (3)  
THE STANLEY WORKS  
San Francisco: Monadnock Bldg., YU 6-8914  
New Britain, Conn.

CEMENT (c)  
PACIFIC PORTLAND CEMENT  
San Francisco: 417 Montgomery St., GA 1-4100

CONCRETE AGGREGATES (4)  
Lightweight Aggregates  
AMERICAN PERLITE CORP.  
Richmond, Calif.: 26th & B Sts.—Yard 2, RI 4307

DOORS (4a)  
Hollywood Doors  
WEST COAST SCREEN CO.  
Los Angeles: 1127 E. 63rd St. AD 1-1108  
Distributors:

W. P. FULLER CO.  
Seattle, Tacoma, Portland  
NICOLAI DOOR SALES CO.  
San Francisco: 3045 19th St.  
T. M. COBB CO.  
Los Angeles & San Pedro  
SOUTHWEST SASH & DOOR  
Phoenix, Arizona  
HOUSTON SASH & DOOR  
Houston, Texas

Screen Doors  
WEST COAST SCREEN CO.  
(See Hollywood Door listing above)

FIRE ESCAPES (5)  
SOULE STEEL  
San Francisco: 1750 Army St., VA 4-4141  
Los Angeles, Calif.—LA 0911  
Portland, Ore.—BE 5155  
Seattle, Wash.—SE 3010  
MICHEL & PFEFFER IRON WORKS, INC.  
South Linden and Tantoran Aves.  
South San Francisco: JU 4-8362

FIREPLACES (5a)  
Heat Circulating  
SUPERIOR FIREPLACE CO.  
Los Angeles: 1708 E. 15th St., PR 8393  
Baltimore, Md.: 601 No. Point Rd.

FLOORS (6d)  
Hardwood Flooring  
HOGAN LUMBER COMPANY  
Oakland: Second and Alice Sts., GL 1-6861  
E. K. WOOD LUMBER CO.  
Los Angeles: 4710 S. Alameda St., JE 3111  
Oakland: 727 Kennedy St., KE 4-8466  
Portland: 827 Terminal Sales Building

Floor Treatment & Maintenance  
HILLYARD SALES CO. (Western)  
470 Alabama St., San Francisco, MA. 1-7766  
Los Angeles, 923 E. 3rd, Trinity 8282  
Seattle, 3440 E. Marginal Way  
Diversified (Magnesite, asphalt tile, composition, etc.)  
LeROY OLSON CO.  
San Francisco 10: 3070 - 17th St., HE 1-0188

Sleepers (composition)  
LeROY OLSON CO.

GLASS (7)  
W. P. FULLER COMPANY  
San Francisco: 301 Mission St., EX 2-7151  
Los Angeles, Calif.  
Portland, Oregon

HEATING (8)  
HENDERSON FURNACE & MFG. CO.  
Sebastopol, Calif.  
S. T. JOHNSON CO.  
Oakland 8: 940 Arlington Ave., OL 2-6000  
San Francisco: 585 Potrero Ave., MA 1-2757  
Philadelphia 8, Pa.: 401 No. Broad St.

SCOTT COMPANY  
San Francisco: 243 Minna St., YU 2-0400  
Oakland: 113 - 10th St., GL 1-1937  
San Jose, Calif.  
Los Angeles, Calif.  
Electric Heaters

ELECTROMODE CORP.  
Rochester, N. Y.  
San Francisco: 1355 Market St., KL 2-2311  
Northern California Distributors  
GENERAL ELECTRIC SUPPLY CORP.  
San Francisco: 1201 Bryant St., MA 1-3400  
Emeryville: 5400 Hollis St., OL 3-4433

Sacramento: 1131 S St., GI 3-9001  
Fresno: 1234 O St., Fresno 4-4746  
INCANDESCENT SUPPLY COMPANY  
Redding: 2146 Pine St., Redding 200

THOMAS B. HUNTER (Designer)  
San Francisco: 41 Sutter St., GA 1-1164  
UTILITY APPLIANCE CORP. \*(b)

INSULATION AND WALLBOARD (9)  
LUMBER MANUFACTURING CO.  
San Francisco: 225 Industrial Ave., JU 7-1760  
SISALKRAFT COMPANY \*(2)  
WESTERN ASBESTOS COMPANY  
San Francisco: 675 Townsend St., KL 2-3868  
Oakland: 251 Fifth Avenue, GL 1-2345  
Sacramento: 1244 I Street, 2-8993  
Stockton: 1120 E. Weber Ave., 4-1863  
Fresno: 1837 Marced Street, 3-3277  
San Jose: 201 So. Market St., BA 4359-J

IRON—Ornamental (10)  
MICHEL & PFEFFER IRON WORKS, INC. \*(5)

LANDSCAPE (11a)  
Landscape Contractors  
HENRY C. SOTO CORPN.  
Los Angeles, 13000 S. Avalon Blvd., ME 4-6617

LIGHTING FIXTURES (11)  
SMOOT-HOLMAN COMPANY  
Inglewood, Calif. OR 8-1217  
San Francisco: 55 Mississippi St., MA 1-8474

LUMBER (12)  
HOGAN LUMBER COMPANY \*(6)  
LUMBER MANUFACTURING CO. \*(9)  
E. K. WOOD LUMBER CO \*(6)

Shingles  
SIDEWALL LUMBER COMPANY  
San Francisco 24: 1995 Oakdale Ave., AT 8-1112

MARBLE (13)  
VERMONT MARBLE COMPANY  
San Francisco: 525 Market St., SU 1-6747  
Los Angeles 4: 3522 Council St., DU 2-7834

METAL LATH EXPANDED (14)  
FORDERER CORNICE WORKS  
San Francisco: 269 Potrero Ave., HE 1-4100  
SOULE STEEL \*(5)

MILLWORK (15)  
PACIFIC MANUFACTURING COMPANY  
San Francisco: 16 Beale St., GA 1-7755  
Santa Clara: 2610 The Alameda, SC 607  
Los Angeles: 6820 McKinley Ave., TH 4196  
MULLEN MANUFACTURING COMPANY  
San Francisco: 60-80 Rausch St., UN 1-5815  
LUMBER MANUFACTURING COMPANY \*(9)

PAINTING (16)  
Paint  
W. P. FULLER COMPANY \*(7)

PLASTER (17)  
Exteriors  
PACIFIC PORTLAND CEMENT COMPANY \*(4)  
Interiors—Metal Lath & Trim  
FORDERER CORNICE WORKS \*(14)

PLASTER CEMENT (f)  
PACIFIC PORTLAND CEMENT CO.  
San Francisco: 417 Montgomery St., GA 1-4100

PLUMBING (18)  
THE SCOTT COMPANY \*(8)  
THE HALSEY TAYLOR COMPANY

Redlands, Calif.  
Warren, Ohio  
HAWKS DRINKING FAUCET COMPANY  
Bartley 10: 1435 Fourth St., LA 5-3341  
CONTINENTAL WATER HEATER COMPANY  
Los Angeles 31: 1801 Pasadena Ave., CA 6178  
SIMONDS MACHINERY COMPANY  
San Francisco: 816 Folsom St., DO 2-6794  
Los Angeles: 455 East 4th St., MU 8322  
SECURITY VALVE COMPANY  
Los Angeles 31: 410 San Fernando Rd., CA 6191

REPUBLIC STEEL CORP.  
San Francisco: 116 N. Montgomery St., GA 1-0977  
Los Angeles: Edison Building  
Seattle: White-Henry-Stuart Building  
Salt Lake City: Walker Bank Building  
Denver: Continental Oil Building  
KRAFFLE COMPANY \* (1)  
SAN JOSE STEEL COMPANY  
San Jose: 195 North Thirtieth St., CO 4184

WINDOWS STEEL (25)  
DETROIT STEEL PRODUCTS CO. \* (20)  
MICHEL & PFEFFER IRON WORKS, INC. \* (5)  
SOULE STEEL COMPANY \* (5)

**SEWER PIPE (19)**

GLADDING, McBEAN & CO. \* (1)  
PACIFIC CLAY PRODUCTS  
San Francisco: 605 Market St., GA 1-3970  
Los Angeles, Portland, Salt Lake City

**STEEL—REINFORCING 121**

REPUBLIC STEEL CORP. \* (21)  
HERRICK IRON WORKS \* (21)  
SAN JOSE STEEL CO. \* (21)  
COLUMBIA STEEL CO. \* (21)

**SHEET METAL (20)**

W/Windows  
DETROIT STEEL PRODUCTS COMPANY  
Oakland 8: 1310 - 63rd St., OL 2-8826  
San Francisco: Russ Building, DO 2-0890  
MICHEL & PFEFFER IRON WORKS, INC. \* (5)  
SOULE STEEL COMPANY \* (5)

**TILE (23)**

GLADDING, McBEAN & CO. \* (1)  
KRAFFLE COMPANY \* (1)  
PACIFIC CLAY PRODUCTS  
San Francisco: 605 Market St., GA 1-3970  
Los Angeles, Portland, Salt Lake City

**Fire Doors**

DETROIT STEEL PRODUCTS COMPANY

**TIMBER—REINFORCING (1)**

Trusses  
WEYERHAEUSER SALES CO.  
Tacoma, Wash.  
St. Paul, Minn.  
Newark, N. J.

**Slyghts**

DETROIT STEEL PRODUCTS COMPANY

**Treated Timber**

J. H. BAXTER CO.  
San Francisco 4: 333 Montgomery St., DO 2-3883  
Los Angeles 13: 601 West Fifth St., MI 6294

**STEEL—STRUCTURAL (21)**

COLUMBIA STEEL CO.  
San Francisco: Russ Bldg., SU 1-2500  
Los Angeles: 2087 E. Broadway, LA 1171  
Portland: 2345 N. W. Nicolai, BE 7261  
Seattle: 1331 3rd Ave. Bldg., MA 1972  
Salt Lake City: Walker Bank Bldg., SL 3-6733  
HERRICK IRON WORKS  
Oakland: 18th & Campbell Sts., GL 1-1767  
JUDSON PACIFIC-MURPHY CORP.  
Emeryville: 4300 Eastshore Highway, OL 3-1717

**WALL TILE (24)**

GLADDING, McBEAN & CO. \* (1)  
KRAFFLE COMPANY \* (1)

**GENERAL CONTRACTORS (261)**

BARRETT & HILP  
San Francisco: 918 Harrison St., DO 2-0700  
Los Angeles: 234 W. 37th Place, AD 3-8161  
DINWIDDIE CONSTRUCTION COMPANY  
San Francisco: Crocker Building, YU 6-2718  
CLINTON CONSTRUCTION COMPANY  
San Francisco: 923 Folsom St., SU 1-3440  
MATCOCK CONSTRUCTION COMPANY  
San Francisco: 604 Mission St., GA 1-5516  
PARKER, STEFFENS & PEARCE  
San Francisco: 135 So. Park, EX 2-6639  
STOLTE, INC.  
Oakland: 8451 San Leandro Blvd., TR 2-1064  
SWINERTON & WALBERG COMPANY  
San Francisco: 225 Bush St., GA 1-2980  
Oakland: 1723 Webster St., HI 4-4322  
Los Angeles, Sacramento, Denver  
P. J. WALKER COMPANY  
San Francisco: 391 Sutter St., YU 6-5916  
Los Angeles: 714 W. Olympic Blvd., RI 7-5521

**TESTING LABORATORIES (ENGINEERS & CHEMISTS) (27)**

ABBOT A. HANKS, INC.  
San Francisco: 624 Sacramento St., GA 1-1697  
ROBERT W. HUNT COMPANY  
San Francisco: 251 Kearny St., EX 2-9634  
Los Angeles: 3050 E. Slauson, JE 4131  
Chicago, New York, Pittsburgh  
PITTSBURGH TESTING LABORATORY  
San Francisco: 651 Howard St., EX 2-1747

**BUILDING TRADES WAGE (JOB SITES) NORTHERN, CENTRAL AND SOUTHERN CALIFORNIA**

ATTENTION: The following are the PREVALING hourly rates of compensation being paid and in effect by employers by agreement between employees and their union; or as recognized and determined by the U. S. Department of Labor. (Revised to March 1, 1951.)

CRAFT	San Francisco	Alameda	Contra Costa	Fresno	Sacramento	San Joaquin	Santa Clara	Solano	Los Angeles	San Bernardino	San Diego	Santa Barbara	Kern
ASBESTOS WORKERS.....	\$2.50	\$2.50	\$2.50	\$2.50	\$2.50	\$2.50	\$2.50	\$2.50	\$2.25	\$2.25	\$2.25	\$2.25	\$2.25
BOILERMAKERS.....	2.53	2.53	2.53	2.53	2.53	2.53	2.53	2.53	2.25	2.25	2.25	2.25	2.25
BRICKLAYERS.....	3.25**	3.15*	3.15	2.85	3.25	3.00	3.00	3.25	2.625	2.625	2.625	2.625	2.625
BRICKLAYERS, HODCARRIERS.....	2.45	2.45	2.45	2.00	2.40	2.25	2.375	2.40	2.20	2.20	2.20	2.20	2.20
CARPENTERS.....	2.325	2.325	2.175	2.175	2.175	2.175	2.175	2.175	2.20	2.20	2.20	2.20	2.20
CEMENT FINISHERS.....	2.20	2.20	2.20	2.20	2.20	2.20	2.20	2.20	2.28	2.28	2.28	2.28	2.28
ELECTRICIANS.....	2.75	2.60	2.60	2.75	2.50	2.50	2.625	2.60	2.50	2.50	2.50	2.50	2.50
ELEVATOR CONSTRUCTORS.....	2.325	2.325	2.325	2.325	2.325	2.325	2.325	2.325	2.28	2.28	2.28	2.28	2.28
ENGINEERS: MATERIAL HOIST.....	2.75	2.75	2.75	2.75	2.75	2.75	2.75	2.75	1.9875	1.9875	1.9875	1.9875	1.9875
GLAZIERS.....	2.19	2.19	2.19	2.19	2.19	2.19	2.19	2.19	2.00	2.00	2.00	2.00	1.96
IRONWORKERS: ORNAMENTAL.....	2.425	2.425	2.425	2.425	2.425	2.425	2.425	2.425	2.25	2.25	2.25	2.25	2.25
IRONWORKERS: REINFORCING.....	2.375	2.375	2.375	2.375	2.375	2.375	2.375	2.375	2.28	2.28	2.28	2.28	2.28
IRONWORKERS: STRUCTURAL.....	2.575	2.575	2.575	2.575	2.575	2.575	2.575	2.575	2.30	2.30	2.2375	2.30	2.30
LABORERS: BUILDING.....	1.65	1.65	1.65	1.55	1.65	1.65	1.55	1.65	1.65	1.65	1.65	1.65	1.65
LABORERS: CONCRETE.....	1.65	1.65	1.65	1.55	1.65	1.65	1.55	1.65	1.65	1.65	1.65	1.65	1.65
LATHERS.....	3.00	3.00**	3.00**	2.75	2.875	2.75	3.00	2.8125	2.50	2.50	2.50	2.50	2.50
MARBLE SETTERS.....	2.60	2.60	2.60	2.60	2.60	2.60	2.60	2.60	2.25	2.25	2.25	2.25	2.25
MOSAIC & TERRAZZO.....	2.375	2.375	2.375	2.375	2.375	2.375	2.375	2.375	2.40	2.40	2.40	2.40	2.40
PAINTERS.....	2.45**	2.45	2.45	2.15	2.45	2.25	2.45	2.45	2.22	2.22	2.22	2.22	2.22
PAINTERS: PILEDRIVERS.....	2.325	2.325	2.325	2.325	2.325	2.325	2.325	2.325	2.33	2.33	2.33	2.33	2.33
PLASTERERS.....	3.00	3.15*	3.15	2.75	3.00	3.00	3.125	3.00*	2.50	2.75	2.50	2.50	2.50
PLASTERERS, HODCARRIERS.....	2.60	2.80	2.80	2.50	2.40	2.50	2.75	2.50	2.15	2.25	2.30	2.30	2.30
PLUMBERS.....	2.425	2.425	2.425	2.425	2.425	2.425	2.425	2.425	2.50	2.50	2.50	2.50	2.50
ROOFERS.....	2.50	2.50	2.50	2.50	2.375	2.50	2.50	2.50	2.25	2.25	2.00	2.00	2.00
SHEET METAL WORKERS.....	2.3125	2.3125	2.3125	2.40	2.50	2.375	2.3125	2.375	2.15	2.15	2.175	2.00	2.15
SPRINKLER FITTERS.....	2.625	2.625	2.625	2.625	2.625	2.625	2.625	2.625	2.25	2.25	2.25	2.25	2.25
STEAMFITTERS.....	2.625	2.625	2.625	2.625	2.625	2.625	2.625	2.625	2.50	2.50	2.50	2.50	2.50
TRUCK DRIVERS—1/2 Ton or less.....	1.58	1.58	1.58	1.58	1.58	1.58	1.58	1.58	1.58	1.58	1.58	1.58	1.58
TILESETTERS.....	2.875	2.875	2.875	2.50	2.875	2.4325	2.875	2.875	2.50	2.50	2.50	2.50	2.50

\* 6 Hour Day. \*\* 7 Hour Day.

Prepared and compiled by:

CENTRAL CALIFORNIA CHAPTER, ASSOCIATED GENERAL CONTRACTORS OF AMERICA, with the assistance and cooperation of secretaries of General Contractors Associations and Builders Exchanges of Northern California; and the above information for southern California is furnished by the Labor Relations Department of the Southern California Chapter, ASSOCIATED GENERAL CONTRACTORS OF AMERICA.



## YAKIMA CITY HALL

(From Page 14)

On the second floor is found the court room, judge's chambers, squad room, clerk's office, identification office and small examination rooms together with special offices for juvenile officers and others.

Third floor of the jail is given over to cells, tank, kitchen and jailer's quarters and the fourth floor is the women's division with some of the mechanical equipment of the building installed on both the third and fourth floors.

The building has asphalt tile floors and vinyl floors. In the jail cells, tank and kitchen terrazo floors have been installed because they are considered easier to keep clean and wear well under the conditions they are subjected to in these rooms.

The roof is a built-up composition-type installation. The building is hot water heated and an air conditioning system is cooled by a refrigeration-type cooling plan. Building is trimmed throughout in oak. Fluorescent lighting has been installed in all parts of the structure.

A full basement contains the heating and cooling plants and the electrical control machinery. Installed in the basement is a pistol range, a gymnasium and locker room for the police. Parking meter repair and maintenance, storage vaults and record rooms occupy the balance of this fully utilized basement area.

By placing all corrective and lodging facilities for prisoners on the third and fourth floors the architect avoided bringing city employees and customers in contact with people under duress. Every possible precaution was considered in the design to combine an escape-proof jail with one that incorporated the modern improvements in plans and care of prisoners.

You find none of the dead space and lost areas so frequent in large public buildings. A study of the floor plans discloses the care which Architect John W. Maloney has taken to utilize and put to work every bit of floor space through the four-story

structure. General contractor on the building was John Sellen, Seattle, Washington.

Architect John W. Maloney maintains offices both at Seattle and Yakima.

## APPOINTED PACIFIC COAST MANAGER OF SALES

Carl A. Ten Hoopen, Sr., assistant sales manager of the Cyclone Fence Division, U. S. Steel Corp., has been appointed Pacific Coast Manager of Sales, according to a recent announcement by Roy E. Pinniger, vice-president and general manager of Cyclone Fence.

Ten Hoopen succeeds Raymond G. Russell, who has retired following forty years service with more than thirty-eight years with Cyclone.

A native of Ohio, Ten Hoopen joined the company as a salesman in Cleveland in 1921 following graduation from the Case Institute of Technology with a B.S. degree in Mining and Metallurgical Engineering. He was appointed Sales Manager for the Central District at Cleveland in 1933 and was named Eastern District Sales Manager in 1946. In July of this year he was appointed Assistant Sales Manager and comes to the Bay Area from Newark.



CARL A. TEN HOOPEN, SR.  
Sales Manager

## EARL E. BROWN ELECTED PRESIDENT NATIONAL PLUMBING AND HEATING INDUSTRIES BUREAU

Earl E. Brown, secretary of The Chicago Faucet Company has been elected president of the Plumbing and Heating Industries Bureau at the 32nd annual meeting of the Bureau.

He succeeds Jack Cooper of Springfield, Missouri. Norman J. Radder was re-elected secretary.

# CLASSIFIED ADVERTISING

RATE: 20c PER WORD . . . CASH WITH ORDER

MINIMUM \$5.00

**PLANNING CHURCH BUILDINGS.** Part-folio—64 oversized pages 144 cuts; floor plans, exterior and interior views; recently planned buildings costing \$30,000 upward. Largest collection plans of Protestant churches assembled. Price \$2.00 p.p. WRITE Bureau of Architecture, 300 Fourth Ave., New York 10, N. Y.

**GET THE BEST,** don't be satisfied with anything but the best. Window sash, Doors, Cabinets, etc. Town Talk Sash & Door Mill, 524 9th St., Sacramento.

**BUILDERS!** You can make more money; get information you need before it is published elsewhere; Subscribe to the daily ARCHITECTS REPORTS, only \$10.00 per month. Complete information from ARCHITECTS REPORTS, 68 Post Street, San Francisco. Phone DOuglas 2-8311.

**PHOTOGRAPHY.** For the best in construction photography, including exterior and interior, aerial, and progress views . . . you will find as many others have that it's the SKELTON STUDIO'S, 137 Harlan Place, San Francisco. Telephone YUkon 6-6321.

**WANTED:** Experienced specification writer and building estimator by San Francisco ARCHITECT. Write WE 1-6. c/o ARCHITECT & ENGINEER, 68 Post Street, S. F.

**FLOOR COVERINGS** for industrial, commercial, and residential construction. Complete lines, one of the oldest, best established organizations in the Sacramento Valley. LATTIN'S, INC., 1519 Alhambra Blvd., Sacramento.

## CONSTRUCTION CONTRACTS AWARDED AND MISCELLANEOUS PERSONNEL DATA

**FIBRE SHIPPING DRUM FACTORY,** Pittsburg, Contra Costa County. Continental Can Co., Chicago, Ill. owner. 1-story, 300,000 sq. ft. office building, 2-story structural steel frame, metal deck roof, brick, steel sash, corrugated asbestos siding, tar and gravel roof, concrete floor on fill, \$2,000,000. ENGINEER: Engineering Department, owner. CONTRACTOR: Bachtel Corp., Los Angeles.

**U. S. NAVY POST GRADUATES SCHOOL,** Monterey, Monterey County. U. S. Navy, Bureau of Yards and Docks, owner. Erection of 8 government, furnished Butler-Type metal rigid frame buildings, concrete work, roads, walks, structural steel, tile, masonry, plastering, refrigeration, sheet metal, composition flooring, ventilating, plumbing, sprinkler system, laboratory furniture, \$604,800. CONTRACTOR: Haas Construction Co., San Francisco.

**OFFICE AND SERVICE GROUP BUILDINGS,** Fairfield, Solano County. Pacific Gas & Electric Co., San Francisco, owner. \$50,000. ENGINEER, owner. CONTRACTOR: C. Norman Peterson, Berkeley.

**ELEMENTARY SCHOOL BUILDING,** Hawthorne, Mineral County, Nevada. Hawthorne Elementary School District, Hawthorne, owner. Administration unit, multi-purpose unit, shop building and toilets, reinforced concrete and frame construction, \$773,014. ARCHITECT: Russell Mills, Reno. CONTRACTOR: Walker Boudwin Construction Co., Reno.

**OFFICE BUILDING,** South San Francisco, San Mateo County. General Metals Corp., San Francisco, owner. 1-story, concrete, brick, frame and stucco construction, \$27,203. ARCHITECT: Peterson & Spackman, San Francisco. CONTRACTOR: Midstate Construction Co., San Francisco.

**NAVY HOUSING PROJECT,** Sunnyvale, Santa Clara County. U. S. Navy, San Francisco, owner. 72-family dwelling units, under Title VIII, National Housing Act, \$578,535. ARCHITECT: Ned H. Abrams, Sunnyvale. CONTRACTOR: M. G. S. Investment Corp., San Jose.

**ANDREW WILLIAMS MARKET,** Concord, Contra Costa County. Mayfair-Andrew Williams Markets, Lessee. 1-story, concrete block and wood roof trusses, \$200,000. ENGINEER: R. H. Cooley, Oakland. CONTRACTOR: John J. MOORE Co., Oakland.

**APARTMENT BUILDING,** Oakland, Alameda County. R. Steffensen, owner. 8-apart-

ments, 2-story, frame and stucco construction, \$70,000. ARCHITECT: Leonard H. Ford, Walnut Creek. CONTRACTOR: Metropolitan Builders, Oakland.

**NORTH SIDE ELEMENTARY SCHOOL,** Hanford, Kings County. Hanford Elementary School District, Hanford, owner. 4-classrooms, Kindergarten, multi-purpose, kitchen, toilets, frame and stucco construction, steel sash, radiant heating, \$177,773. ARCHITECT: Horn & Mortland, Fresno and Clinton Terstron, Los Angeles. CONTRACTOR: Midstate Construction Co., Fresno.

**BEULAH REST HOME ADDITION,** Oakland, Alameda County. Beulah Rest Homes, Inc., Oakland, owner. 2-story and basement, reinforced concrete and frame construction, \$276,099. ARCHITECT: Wm. E. Schriener, Oakland. CONTRACTOR: Steadman & Powell, Oakland.

**HOSPITAL BUILDING,** Castro Valley, Alameda County. Eden Township Hospital District, owner. 118 beds, \$3,147,391. ARCHITECT, D. D. Stone Lou Mulloy, San Francisco. 5 story, reinforced concrete construction, 3 elevators, steel windows, asphalt tile and terrazzo floors. GENERAL CONTRACTOR: William & Burrows, Burlingame.

**SCHOOL BUILDINGS,** Victorville, Calif. Housing and Home Finance Agency, owner. 8 classrooms, Kindergarten, administrative unit and multi-use room, \$310,488. ARCHITECT, H. L. Cogerty, Los Angeles. Reinforced tilt-up concrete construction, composition roofing, steel sash, concrete slab and asphalt tile floors, acoustic ceilings, ceramic tile work in toilets. GENERAL CONTRACTOR: E. W. Scott, Riverside.

**JUNIOR HIGH SCHOOL,** Compton, Los Angeles County. Compton Union High School District, owner. 16 classrooms, arts and crafts unit, multi-use room, food laboratory, 4 shops, library, administrative unit, music unit, shower and locker building, \$1,099,383. ARCHITECT: Daniel, Mann, Johnson and Mendenhall, Los Angeles. Reinforced concrete construction, composition roofing, cement and asphalt tile floors. GENERAL CONTRACTOR: Brunzell Construction Co., Culver City.

**LOW REnt HOUSING PROJECT,** El Centro, Calif. Housing Authority of the City of El Centro, owner. 50 units, \$329,777. ARCHITECT, Frank C. Hyde, El Centro. Frame & stucco construction. GENERAL CONTRACTOR, J. H. Hedrick & Co., San Gabriel.

**WAREHOUSE AND SHOP BUILDINGS,** Signal Hill, Calif. Associated Telephone Company, owner. \$450,000. STRUCTURAL ENGINEER: Maurice Sasso, Los Angeles. Metal frame and granite construction. GENERAL CONTRACTOR: Contracting Engineers, Los Angeles.

**ARMY WHERRY HOUSING PROJECT,** Herlong, Lassen County. Corps. of Engineers, owner. 125 units, \$1,245,755. ARCHITECT: Ferris & Erskine, Reno. SPONSOR: Sierra Homes, Inc.

**LINCOLN ELEMENTARY SCHOOL ADDITION,** Stockton, San Joaquin County. Lincoln Elementary School District, owner. 6 classrooms, kindergarten, multi-purpose, kitchen, special use, arcades, toilet rooms \$278,800. ARCHITECT: Schmitz & Hardman, Berkeley. Frame & stucco construction. GENERAL CONTRACTOR: Nomellini Construction Co., Stockton.

**REDWOOD ELEMENTARY SCHOOL,** Castro Valley, Alameda County. Castro Valley Elementary School District, owner. 7 classrooms, administration, kindergarten, multi-purpose, kitchen, toilet rooms, \$228,386. ARCHITECT: John Warncke, San Francisco. Frame & Stucco construction. GENERAL CONTRACTOR: A. F. Stewart, Berkeley.

**STANTON ELEMENTARY SCHOOL,** Castro Valley, Alameda County. Castro Valley Elementary School District, owner. 7 classrooms, administration, kindergarten, kitchen, multi-purpose, toilet rooms, \$230,682. ARCHITECT: John Warncke, San Francisco. Frame & Stucco construction. GENERAL CONTRACTOR: Steadman & Powell, Oakland.

**ELEMENTARY SCHOOL ADDITION,** Fresno, Fresno County. Teague Elementary School District, owner. 6 classrooms, 2 kindergartens, multi-purpose, kitchen, toilet rooms, \$288,077. ARCHITECT: Franklin & Simpson, Fresno. 1 story, 16,000 sq. ft., frame and stucco construction. GENERAL CONTRACTOR: Larsen-Ratio Construction Co., Fresno.

**NEW ROBERTS ELEMENTARY SCHOOL,** Sacramento, Sacramento County. Orangevale Elementary School District, owner. Classrooms, kindergarten, administration and multi-purpose, kitchen and toilet rooms, \$371,000. ARCHITECT: Barovetto & Thomas, Sacramento. Frame and stucco construction. GENERAL CONTRACTOR: H. H. Henning, Stockton.

**PAROCHIAL SCHOOL,** Millbrae, San Mateo County. Roman Catholic Archbishop of San Francisco, owner. 8 classrooms, administration, cafeteria and toilet rooms, \$179,023. ARCHITECT: Martin J. Rist, San Francisco. Frame and stucco construction. GENERAL CONTRACTOR: O. E. Moroney, Burlingame.

**CHURCH,** San Marino, Los Angeles County. St. Edmunds Episcopal Church, owner. 1 story building, \$137,545. ARCHITECT: Austin, Field & Fry, Los Angeles. Brick and stone construction. GENERAL CONTRACTOR: Oltmans Construction Co., Los Angeles.

**HOSPITAL ADDITION,** Red Bluff, Calif. St. Elizabeth Hospital, owner. 16 beds, new kitchen, \$210,500. ARCHITECT: Albert W. Kahl, San Mateo. MECHANICAL ENGINEER: Harold Wright, San Francisco. 3 story, reinforced concrete, steel studs, metal lath, plaster partitions, air conditioning system. GENERAL CONTRACTOR: Liston Ehorn, Red Bluff.

**INDUSTRIAL BUILDING,** Tracy, San Joaquin County. State of California, owner. \$171,344. ARCHITECT: State Architect Anson Boyd, Sacramento. 1 story, 17,600 sq. ft., steel frame, concrete slab, corrugated siding above concrete walls, steel sash, composition roofing, hollow clay, tile, metal stud partitions, wood and hollow metal doors. GENERAL CONTRACTOR: W. J. Nicholson Co., Santa Clara.

**MANOR GRAMMAR SCHOOL,** Menlo Park, San Mateo County. Ravenswood Elementary School District, owner. 17 classrooms, 2 kindergartens, administration, library, homemaking, boys and girls shower and locker kitchen, shops and toilet rooms, \$1,195,020. ARCHITECT: Arthur D. Janssen, Menlo Park. Concrete block and frame construction. C. M. P. gateway. GENERAL CONTRACTOR: E. A. Hathaway & Co., San Jose.

**ALTA COFFEE ROASTING PLANT,** Bayshore City, San Mateo County. Alexander-Balart Co., owner. \$100,000. ENGINEER: Hyman Rosenthal, San Francisco. 1 story, 20,000 sq. ft., reinforced concrete and frame

## PANACALITE

The Standard for Perlite Aggregates  
An Engineered Product—Engineering  
Service

Air Classified—Stead & Graded for  
Plaster, Concrete & Stucco  
Aggregates

Listed Underwriters' Laboratories  
Re-examination Service

Fire Ratings:  
Non-Bearing Walls—2 hours  
Floor and Beam—4 hours  
Columns—2 & 3 hours  
Suspended Ceilings—4 hours  
Others

Manufactured by  
**American Perlite Corporation**  
26th & B Sts.—Yard 2—Richmond  
EAccon 5-1385

construction. GENERAL CONTRACTOR: Monson Bros., San Francisco.

**ADDITION TO FONTANA HIGH SCHOOL.** Fontana, Calif. Chaffey Union High School District, owner. Locker and shower building, cafeteria, \$311,650. ARCHITECT: Allison & Rible, Los Angeles. Reinforced concrete construction, composition roofing, cement and asphalt tile floors, insulation, steel sash, ceramic tile, metal toilet partitions. GENERAL CONTRACTOR: Dowd-Hoelzer Co., Fontana.

**RADIOMETALLURGY BUILDING AND PILE TECHNOLOGY BUILDING.** Richland, Washington. Atomic Energy Commission, owner. 1 story and basement, \$2,840,000. STRUCTURAL ENGINEER: Leland P. Rosener, San Francisco. Reinforced concrete and steel frame, movable sectional metal partitions, metal liners, exterior walls of insulated steel panel construction, basement concrete slab floor and reinforced concrete walls. GENERAL CONTRACTOR: L. H. Hoffman, Portland.

**ADDITION TO OFFICE BUILDING.** Burbank, Los Angeles County. Lockheed Aircraft Corp., owner. 3 story addition, \$100,000. ARCHITECT: Richard Neutra and Robert Alexander, Los Angeles. CONSULTING ENGINEER: Parker, Zehnder & Associates, Los Angeles. Frame and stucco construction, Caisson foundation. GENERAL CONTRACTORS: Walter Olerich, Los Angeles.

**PERMANENTE FOUNDATION HOSPITAL.** Los Angeles, Los Angeles County. Permanente Foundation Hospital, owner. 210 beds, \$1,800,000. ARCHITECTS: Wolff & Philipps, Portland. 7 story, reinforced concrete. GENERAL CONTRACTORS: C. L. Peck, Los Angeles.

**WAREHOUSE BUILDING.** Hayward, Alameda County. Hunt Food, Inc., owner. \$475,000. ARCHITECT & ENGINEER: Douglas McClellan & Assoc., Los Angeles. 1 story, 240,000 sq. ft. and 125,000 sq. ft. of exterior slab, reinforced concrete, tilt-up construction, structural steel columns and trusses, wood roof, composition roofing, steel rolling fire doors, sprinkler system. GENERAL CONTRACTOR: Swinerton & Walberg, Oakland.

**NEW ELEMENTARY SCHOOL.** Hawthorne, Nevada. Hawthorne Elementary School District, owner. 21 classrooms, administration, multi-purpose, shop, toilet rooms, \$722,988. ARCHITECT: Russell Mills, Reno. Reinforced concrete and frame construction. GENERAL CONTRACTOR: Walker Boudwin Construction Co., Reno.

**MERRITT HOSPITAL ADDITION.** Oakland, Alameda County. Samuel Merritt Hospital, owner. \$280,000. ARCHITECT: Mosten & Hurd, San Francisco. 1 story and basement, reinforced concrete construction. GENERAL CONTRACTOR: Swinerton & Walberg, San Francisco.

**NEW DEL REY WOOD SCHOOL.** Monterey, Monterey County. Monterey Elementary School District, owner. 15 classrooms, kindergarten, administration and toilet rooms, \$504,202. ARCHITECT: Robert Stanton, Carmel. Frame and stucco construction. GENERAL CONTRACTOR: F. V. Hampshire, Salinas.

**HIGH SCHOOL ADDITION.** Turlock, Stanislaus County. Turlock High School District, owner. 3 rooms, home-making building, \$124,813. ARCHITECT: Mayo & Johnson, Stockton. Frame and stucco construction, steel sash. GENERAL CONTRACTOR: R. M. Carter, Turlock.

**JUVENILE HALL ADDITION.** Visalia, Tulare County. County of Tulare, owner. \$147,900.

ARCHITECT: James P. Lockett, Visalia. **PHYSICAL EDUCATION FACILITIES.** Porterville, Tulare County. Porterville Union High School District, owner. Shower and locker building, \$438,800. ARCHITECT: Robt. C. Kaestner, Visalia. GENERAL CONTRACTOR: L. H. Hansen & Sons, Fresno.

**MATHER ELEMENTARY SCHOOL.** Mather Air Force Base, Sacramento County. U. S. Government, owner. 13 classrooms, administration, kindergarten, multi-purpose kitchen, toilet rooms, \$421,100. ARCHITECT: Charles F. Dean, Sacramento. Frame and stucco construction, 28,000 sq. ft. GENERAL CONTRACTOR: Continental Construction Co., Sacramento.

**STORE BUILDING.** Bellflower, Los Angeles County. Gerama Investment Co., owner. 2 story and balcony, \$294,064. ARCHITECT: Milton L. Anderson, Los Angeles. Reinforced brick and concrete construction, 200x100 feet, composition roofing. GENERAL CONTRACTOR: George W. Carter Co., Los Angeles.

**PAROCHIAL SCHOOL.** San Francisco. Roman Catholic Archbishop of San Francisco, owner. \$424,423. ARCHITECT: Vincent Buckley, San Francisco. 2 story, class 1-B reinforced concrete construction. GENERAL CONTRACTOR: Robert McCarthy Co., San Francisco.

**NEW INTERMEDIATE SCHOOL.** Concord, Contra Costa County. Mt. Diablo Unified School District, owner. 33 classrooms, administration, shops, art music, library, home-making, gymnasium, multi-purpose, \$677,539. ARCHITECT: Reynolds & Chamberlin, Anderson & Simonds, Conter & Willis & John Lyon Reid, Oakland. 1 story, 63,675 sq. ft., frame and stucco construction. GENERAL CONTRACTOR: Indenco, Oakland.

# FLOORS

FOR EVERY PURSE  
OR PURPOSE

HOSPITALS • COMMERCIAL BUILDINGS • WINERIES • CANNERIES • FOOD PROCESSING • INDUSTRIAL BUILDINGS • WAREHOUSES • RESTAURANTS • SCHOOLS

Territories open for Qualified Representatives

Specifications and information available on request

Free Consultation Service

**LeROY OLSON  
COMPANY**

3070 Seventeenth Street,  
San Francisco, California

## All homes—large or small—need extra outlets, concealed wiring

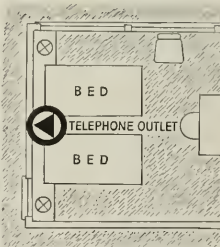

All home owners may want to add extra telephone extensions sometime in the future—in the living room, bedroom, kitchen—wherever they're needed. That's why it's so important to include built-in conduit and outlets in your plans. The cost is small, but the convenience is great.

Wires won't be exposed when you install concealed raceways during construction. And your customer's telephone needs will be taken care of—for now and the future. For free help in planning, call your local Pacific Telephone office and ask for "Architects and Builders Service."

Put built-in telephone facilities in your plans



**Pacific Telephone**



## IN THE NEWS

### MORGAN RESIGNS FHA POSITION

Beldon Morgan, housing market analyst and for 13 years deputy chief evaluator of the Los Angeles office of the Federal Housing Administration, has resigned to enter the private practice of real estate appraising.

Morgan is widely known among builders, bankers and mortgage lenders throughout Southern California for his FHA activities and leadership in the real estate appraising field.

### AMERICAN WELDING SOCIETY ELECTS

Charles H. Jennings, engineering manager of the Welding Department of the Westinghouse Corp., has been named president of the American Welding Society for 1951-52.

Among other officers chosen was Alexei P. Maroudin, Metallurgist and Materials Engineer of the Standard Oil Company of California, with offices in Los Angeles.

### ROADWAY DRAINAGE COURSE OFFERED

A short course on drainage and drainage structures for highways, roads and streets is being offered by the University of California's Institute of Transportation and Traffic Engineering.

Subjects under consideration will be elements of hydrology, flow through culverts, flow in open channels, and practical design examples.

Conferences have been scheduled for Berkeley, Dec. 14; Eureka, March 21; Fresno, Jan. 18; Marysville, Oct. 26; San Jose, April 25; Stockton, Feb. 15; San Luis Obispo, Nov. 30; Bakersfield, May 9; Bishop, June 8; El Centro, Feb. 1; Los Angeles, Mar. 7; San Bernardino, April 11; and San Diego, Jan. 3.

The course in each case will consist of a total of 12 hours of instruction given on two consecutive week ends.

### ARCHITECT SELECTED

The Sausalito Elementary School District has selected the architectural firm of Bliss & Hurt, Trudell & Berger of San Francisco to draw plans for the construction of a new Elementary School in Sausalito.

The structure will be of frame and stucco construction.

### NEW JUNIOR COLLEGE CONTRA COSTA COUNTY

Architect John C. Warnecke, San Francisco, has completed preliminary drawings for a group of occupational education buildings of the new Junior College being constructed near Pacheco in Contra Costa county.

Plans call for the construction of structural steel frame and reinforced concrete buildings at an estimated cost of \$1,200,000.

### UNIQUE ENGINEERING OPERATION BY ARMY

A unique engineering operation by the Corps of Engineers recently solved the problem of extending an airplane runway over a creek at McChord Air Force Base at Tacoma.

It consisted of diverting Clover Creek

from its regular channel, excavating a new channel and then placing twin corrugated steel culverts, each 12 ft. in dia. and 1,500 feet long, into the new channel. The culverts are 10 ft. under the pavement of the runway.

The huge culverts were fabricated on wooden skids alongside the new channel, and each 1,500 ft. pipe was rolled into the channel by four cranes working in unison. Ends of the big pipe were sealed by bulkheads to keep it afloat until permanently positioned and after being nudged into position by a bulldozer, cranes, corylls and tractors were used to bury them and complete the backfill.

### NEW PIERSON SASHLESS WINDOW

An "all glass" window now manufactured in the heart of California's Redwood Region has been announced by the Ernest Pierson Company of Eureka. The new window consists of a redwood frame and no hardware, except an ingenious pull-latch which locks the window closed or part open.



The "Pierson 20-20 Window" comes in seven fabricated redwood pieces, ready to nail together right into the wall framing; eliminates sashes, putty and weights; size 4'-0" x 3'-0" (2-panes of glass are used with one of them sliding—26" x 36", 3/16" crystal) glass panes lift out for cleaning. Packed in metal-taped bundle.

### ARIZONA AGC SPONSOR CONSTRUCTION GROUP

The Arizona Chapter of The Associated General Contractors of America is sponsoring the 496th Engineer Construction Battalion, a component of the Organized Reserve Corp.

Companies of the Unit are stationed in Parker and Phoenix.

### ARCHITECT AND ENGINEER SELECTED

The U. S. Navy, Bureau of Yards and Docks, San Francisco, recently selected the architectural and engineering firm of Sverdrup and Parcel of San Francisco, to design the first increment of development at the Naval Auxiliary landing field at Fallon, Nevada.

Cost of the work was not disclosed.

### LOS ANGELES FIRM CONSOLIDATES

The American Cyanamid Company recently consolidated its several offices and warehouse locations in Los Angeles into one newly constructed building at 2300 S. Eastern Ave.

The building is a 64,000 sq. ft., one story structure containing 44,000 sq. ft. of warehouse space and 20,000 sq. ft. of offices,

and is located on a seven acre site in the Central Manufacturing District.

Among company executives located in the building are: Sheldon Dahl, West Coast Manager in charge of sales and manufacturing of the Industrial Chemicals and Plastics and Resins Divisions; Edward Larson, Regional Manager of Lederle Laboratories Divisions; and H. L. Oak, and W. D. Walker of the Colco Chemical Division.

### FRESNO COUNTY TB HOSPITAL

A State Aid Grant of approximately \$1,000,000 has been approved for the construction of a 300-bed Fresno County Tuberculosis Hospital in Fresno.

The new hospital will be a 4-story and basement reinforced concrete building and has been designed by architects David Horn and Marshall Mortland of Fresno. Total cost of the construction is estimated at \$2,768,000.

### ARCHITECTS SELECTED

The architectural firm of Marsh, Smith & Powell of Los Angeles has been commissioned by the Anaheim Union High School Board to draw plans for the construction of two new junior high schools in Anaheim.

Funds for the construction will be derived from a bond issue of \$3,000,000 to be submitted to the voters early in 1952.

### SEATTLE FIRM IS GIVEN ALASKA JOB

Chris Berg, Inc., of Seattle has been awarded a contract to construct a crash and structural fire station at the Elielson Air Force Base at Anchorage, Alaska, at a cost of \$393,000.

Construction will be permanent type, of non-combustible materials.

### LOW INCOME HOUSING PROJECT IN OILDALE

The Kern County Housing Authority is constructing a 106 low income housing project on the Aero Vista site in Oildale, Kern County.

Of frame and stucco construction; concrete and asphalt tile floor; insulation; steel or wood sash, and roads and sidewalks, the project will cost \$1,000,000.

Ernest L. McCoy of Bakersfield is the architect.

### BEVERLY HILLS BRICK BUILDING

Architects Celoy Parsons and Carrington Lew designed a 10,000 sq. ft., one-story brick building for the Connecticut General Life Insurance Co., which is being erected in Beverly Hills and will be ready for occupancy about March 1, 1952.

Robson-Burns Co. is the general contractor.

### AIR LINES BASE ADD

United Air Lines have engaged the services of H. J. Brunier, Structural Engineer of San Francisco, in conjunction with expansion of the company's base facilities at the San Francisco Airport.

New construction will include a hangar, engine overhaul shop, an additional warehouse building and paving.

### DALLAS BUILDING TO FEATURE LIGHT AGGREGATE

The new multi-million dollar Republic

ARCHITECT AND ENGINEER



## MULLEN MFG. COMPANY

BANK, STORE AND OFFICE  
FIXTURES—CABINET WORK  
OF GUARANTEED QUALITY  
CHURCH SEATING

Office and Factory  
60-80 RAUSCH ST., Bet. 7th and 8th Sts.  
San Francisco  
Telephone UNDERhill 1-5815

### Thinking of Building?

From our cost records and experience, an advance estimate may be made from decidedly general information. Based on our knowledge of labor and material costs, gained on current jobs, such an estimate may be helpful in determining your construction program.

ALL TYPES CONSTRUCTION  
SAN FRANCISCO · SACRAMENTO  
**SWINERTON & WALBERG CO.**  
OAKLAND · LOS ANGELES · DENVER

STATIONERY  
SCHOOL & OFFICE  
SUPPLIES

Printing Engraving  
Announcements

CENTER STATIONERY  
468 McAllister  
San Francisco UN 1-3703

*Fine*  
**ENGRAVINGS**



**POOR  
RICHARD**

PHOTO ENGRAVING CO  
320-324 COMMERCIAL STREET  
SAN FRANCISCO, CALIF.

Bank Building under construction in the heart of the Dallas-Fort Worth metropolitan area, will feature the use of a new Texas produced expanded shale aggregate, according to Gill & Harrel, Dallas architectural firm.

The building, which is under construction by the J. W. Bateson Construction Company of Dallas, will contain some 20,000 yards of the leatherlite aggregate which will be used for structural concrete, fire-proofing of supporting members, and concrete fill over structural concrete.

The building is to be 40 stories in height.

### NEW PERMANENTE HOSPITAL

The architectural firm of Wolf & Phillips of Portland, Oregon, has been commissioned by the Permanente Foundation Hospital of Oakland, California, to draft plans and specifications for the construction of a new 210-bed Hospital Building in San Francisco.

Cost of the 6-story reinforced concrete building is estimated at \$2,300,000.

### A NEW FLOAT OPERATED VALVE

A new liquid control float-operated valve has been announced by the McDonnell & Miller, Inc., of Chicago, providing a large capacity for a valve of compact size.



No. 18

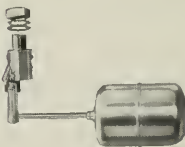

No. 118

It combines husky, non-corrosive construction with extreme simplicity of design and operation. It is available in three variations adaptable for a wide variety of operating conditions.

The valve mechanism consists of a few parts; except for the neoprene valve seat, all parts are of copper or brass. A single pin permits disassembly for inspection and cleaning.

### ARCHITECT SELECTED

Architect Geo. E. Ellinger of Oakland has been commissioned by the Irvington Elementary School District to draft plans and specifications for the construction of an addition to the Irvington Elementary School.

### NEW OFFICIAL

George M. Cox has been appointed head of the newly created legal department of the Southern California Chapter of the Associated General Contractors, with headquarters in Los Angeles.

VETERANS in 43 California counties are financing a total of 307 farms under the low-interest provisions of the State's veteran program.

Subscribe  
Now —

**ARCHITECT  
and  
ENGINEER**

**\$3.00  
Per Year**

**DINWIDDIE  
CONSTRUCTION  
COMPANY**

**BUILDERS**

CROCKER BUILDING  
SAN FRANCISCO



**HERRICK  
IRON WORKS**  
STRUCTURAL STEEL  
REINFORCING STEEL

18TH AND CAMPBELL STS.  
OAKLAND, CALIF.  
Phone GLencourt 1-1767

Phone GARfield 1-1144

**Thomas B. Hunter**  
DESIGNER OF HEATING

AIR CONDITIONING  
VENTILATING AND WIRING  
SYSTEMS, MECHANICAL  
AND ELECTRICAL EQUIP-  
MENT OF BUILDINGS

☆  
41 RUTTER STREET  
ROOM 710

San Francisco California

# STOLTE INC.

General Contractors



OAKLAND • CALIFORNIA

## PITTSBURGH TESTING LABORATORY

ENGINEERS AND CHEMISTS

Testing and Inspection of Concrete,  
Steel and Other Structural Materials

Design of Concrete Mixes

Offices in all principal cities

651 Howard St., San Francisco 5  
EXbrook 2-1747

## MATTOCK CONSTRUCTION COMPANY



BUILDERS



604 MISSION STREET  
SAN FRANCISCO

Subscribe  
Now —

ARCHITECT  
and  
ENGINEER

\$3.00  
Per Year

## Index to Advertisers

AMERICAN Perlite Corp.....	42
ANGIER Pacific Corp.....	33
ARCHITECTS Reports .....	36
BARRETT & HILP, Contractors.....	33
CALIFORNIA Metal Enameling Co..	1
CLASSIFIED Advertising .....	41
CENTER Stationery .....	45
CLAY Brick & Tile Association.....	5
CLINTON Construction Company.....	34
ELECTROMODE Corp. ....	*
FULLER, W. P. Co.....	*
FORDERER Cornice Works.....	33
GLADDING McBean & Company.....	*
GREENBERG'S, M. Sons.....	22
HANKS, Inc., Abbott A.....	46
HAWS Drinking Faucet Co.....	26-27
HEFRICK Iron Works.....	45
HILLYARD Chemical Co.....	23
HOGAN Lumber Co.....	34
HUNT, Robert W., Company.....	46
HUNTER, Thos. B.....	45
JOHNSON, S. T. Co.....	*
JUDSON, Pacific-Murphy Corp.....	34
KRAFTILE Company .....	26
MARBLE Institute of America.....	2
MATTOCK Construction Co.....	46
MICHEL & Pfeffer Iron Works.....	*
MULLEN Mfg. Co.....	45
OLSON, LeRoy Co.....	43
PACIFIC Clay Products Co.....	*
PACIFIC Manufacturing Co.....	35
PACIFIC Portland Cement Company .....	Back Cover
PACIFIC Telephone & Telegraph Co.	43
PARKER, Steffens & Pearce.....	33
PITTSBURGH Testing Laboratory.....	46
POOR Richard Engraving Co.....	45
PORCELAIN Enamel (Architectural Division) Publicity Bureau.....	25
REMILLARD-Dandini Co.....	46
REPUBLIC Steel Corporation.....	35
SCOTT Company .....	46
SIMONDS Machinery Company.....	35
SISALKRAFT Company .....	34
SMOOTH-Holman Company .....	31
SOTO, Henry C., Corp., Landscape Engineers .....	31
STANLEY Works, The.....	25
STOLTE, Inc. ....	46
SUPERIOR Fireplace Co.....	45
SWINERTON & Walberg Co.....	45
U. S. Bonds.....	Inside Front Cover
UTILITY Appliances Corp'n.....	32
VERMONT Marble Company.....	35
WEST Coast Screen Co.....	29
WESTERN Asbestos Company.....	46

\*Indicates Alternate Months

## REMILLARD-DANDINI Co.

Brick and  
Masonry Products



400 MONTGOMERY STREET  
SAN FRANCISCO, CALIF.

## Scott Company

HEATING • PLUMBING  
REFRIGERATION



San Francisco  
Oakland  
San Jose  
Los Angeles

## ABBOT A. HANKS, INC. Engineers & Chemists

INSPECTING — TESTING — CONSULTING  
CONCRETE • STEEL • MATERIALS  
CHEMICAL AND TESTING  
LABORATORIES

• RESEARCH AND INVESTIGATION •

- TESTS OF STRUCTURAL MATERIALS
- DESIGN OF CONCRETE MIXES
- SHOP AND ERECTION INSPECTION OF  
STRUCTURES AND EQUIPMENT
- INVESTIGATION OF STRUCTURES  
AND MATERIALS
- TESTS AND INVESTIGATION OF  
FOUNDATION SOILS
- FIRE RESISTANCE AND INSULATION  
TESTS

624 Sacramento Street, San Francisco

## ROBERT W. HUNT CO.

ENGINEERS  
INSPECTING TESTING

STRUCTURAL MATERIALS  
CONCRETE MIX DESIGN  
CHEMICAL ANALYSIS  
EQUIPMENT

PRINCIPAL CITIES  
UNITED STATES • EUROPE  
SAN FRANCISCO LOS ANGELES  
PORTLAND SEATTLE

# ARCHITECT and ENGINEER

## INDEX TO ARTICLES AND ILLUSTRATIONS

### VOLUMES 184 - 187, 1951

<b>A</b>		<b>G</b>	
A.I.A. Activities .....	Jan.-Dec. 28	Garage, Pershing Square Underground, L. A. Work Starts (Stiles Clements) .....	Mar. 12
A.I.A. Standard Contract Forms (Wm. S. Parker) .....	Apr. 8	Grain Elevator, Port of Sacramento.....	Aug. 34
Air Conditioning Principles and Objectives—Part 1 (H. L. Wollman) .....	Sept. 12	<b>H</b>	
Air Conditioning Principles and Objectives—Part 2 (H. L. Wollman) .....	Oct. 22	Hospital, Sequoia, Redwood City (Stone & Mulloy).....	Cover Jan. 12
Air Raid Shelters a "Must" (Ralph T. Walker) .....	Apr. 8	Hospital, Santa Barbara Tuberculosis (Chester Carjola).....	Jan. 23
Air Raid Shelters, Surveying Existing Bldgs., Portland (R. Evan Kennedy) .....	May 9	Hospital, Maimonides Health Center (Eric Mendelsohn).....	Aug. 27
Air Raid Bomb Shelters for City of Los Angeles.....	Oct. 9	Hospital, Santa Rosa Memorial (Franklin Georgeson).....	Aug. 30
Aluminum in Residence Construction (W. W. Wurster).....	Jan. 24	Hospital, West Contra Costa, San Pablo (Stone & Mulloy).....	Nov. 12
Aluminum in Commercial Construction (R. H. Macey & Co.) (W. W. Wurster).....	Jan. 25	Hotel, Community, Williston, No. Dakota.....	Feb. 16
Aluminum Lath House, Beverly Hills.....	July 22	Hotel Statler, Steel Work, Los Angeles (Holeabir, Root & Burgess).....	Cover May
Art News & Comment .....	Jan.-Dec. 9	Housing Project, Crescent Park, Palo Alto.....	Aug. 22
Atomic Energy in World Economy (Gordon Dean).....	June 9	<b>I</b>	
<b>B</b>		In The News (E. H. Wilder).....	Jan.-Dec. 46
Bank Building, First National, Portland, Industrial Branch (Morton H. Caine) (A. W. Prialux).....	Cover July 16	Industrial Districts, Growth of (R. P. Danielson).....	Apr. 5
Barrett & Hill Issue.....	Aug. 19	<b>J</b>	
Blast Resistant Bldgs., Evolution of Strengthened Core "Design" (Ellery Husted & B. L. Schuyler).....	Oct. 16	Joint Information Committee Page.....	Aug. 1950-Dec. 51 6
Bridge, Golden Gate.....	Aug. 35	<b>L</b>	
<b>C</b>		Lath House, Aluminum, Beverly Hills.....	Jul. 22
Church, St. Catherines, Burlingame (Martin Rist).....	Aug. 24	Lift, Don't Do It Alone (W. S. Schweisheimer).....	Nov. 11
Clearance of Buildings Adjacent to Railroad Tracks.....	Dec. 9	Light, Revolutionary Method of Producing— Sylvania Elec. Co.....	Aug. 13
Club, Racquet, Palm Springs (Clark & Frey).....	Cover June 16	<b>M</b>	
Conference, Standard Modular.....	Apr. 5	Medico-Dental Bldg., Portland (Morgan H. Hartford).....	Jan. 18
Construction Contract Awards .....	Jan.-Dec. 44	Medical Bldg., Health Center, Palm Springs (Clark & Frey).....	Apr. 13
Construction Industry and Defense .....	Mar. 5	Mid-Wilshire Medical Building, Beverly Hills.....	Dec. 16
Construction Problems, Solve Before Building (Chas. E. Balleisen-S. W. Research Institute).....	Sept. 17	<b>O</b>	
Convention, Structural Engrs. Assn., Yosemite.....	Sept. 24	Office Bldg., Dallas, Texas (Beryl C. Stegal).....	Jan. 22
Costs, Contractors', Have risen (Geo. C. Koss).....	Sept. 11	Office Bldg., Latham Square Addition, Oakland (Ponsford & Proce).....	July 25
<b>D</b>		Office Bldg., KRON Television Studio, Mt. San Bruno (Gildstone & Heiser).....	Aug. 25
Dam, Shaste, Unique Overflow Spillway (John E. Ryckman).....	Feb. 13	Office Bldg., Calif. Fam. Fed., Berkeley (Jas. Plachek).....	Aug. 26
Defense Construction in Alaska .....	Dec. 9	Office Bldg., Int. Minerals & Chemical Corp., S. F. (Francis J. McCarthy).....	Oct. 18
<b>E</b>		Office Bldg., L. A. Builders Exchange.....	Nov. 11
Editorial Notes (E. H. Wilder).....	Jan.-Dec. 4	Orthodontics Office, Dallas, Texas (Beryl C. Stegal).....	Jan. 22
Engineers, With The .....	Jan.-Dec. 30	<b>P</b>	
Estimators Guide .....	Jan.-Dec. 39	Painting on Hot Summer Days (Wm. S. Schweisheimer).....	July 9
Estimators Directory .....	Jan.-Dec. 41	Physical Requirements for Construction Workers (Wm. S. Schweisheimer).....	Feb. 7
Evolution of "Strengthened Core" Design.....	Oct. 16	Plumbing Systems, Noises.....	Feb. 8
Exhibit, Centennial, Engineers.....	Jan. 8	Producers Council Page.....	Jan.-Dec. 32
<b>F</b>		Public Bldg., Community Recreation, Burlingame (Oscar Thayer).....	Feb. 18
Factory Building, Kaiser Fraser Auto Bldg., Portland (Wolf & Phillips) (A. W. Prialux).....	Mar. 20	Public Bldg., Public Library, Oakland (Miller & Warnecke).....	Cover Sept. 20
Factory Building, Schlage Lock Co., S. F. (Albert F. Roller).....	Aug. 20	Puzzolan for Construction (Frank B. Anderson).....	May 23
Factory Building, General Warehouse Co., South S. F.....	Aug. 21		
Factory Building, Masonite Co., Ukiah.....	Aug. 32		
Freeways, Effect on Business and Property (F. C. Balfour).....	Jan. 7		

## R

Research, Integrated, Develops New Bldg. Method (Inst. of Inventive Research).....	May 16
Residence, Aluminum, L. A. (Wm. W. Wurster).....	Jan. 24
Residence, Woodside (Oscar Thayer).....	Feb. 15
Residence for Inside City Lot, Portland (Morgan H. Hartford).....	Feb. 20
Residence, Beach, Del Mar, Santa Cruz, Dr. R. Husband (Kitchen & Hunt).....	Cover Mar. 16
Residence, Eugene, Ore., Frank A. Tripp (Percy D. Bentley).....	Cover Apr. 15
Residence Project, Bel Vista, Palm Springs (Clark & Frey).....	Apr. 10
Residence, Woodside King E. Parker, (Clark & Beuttler).....	May 14
Residence, Rejuvenation of an Early California, Santa Rosa	June 20
Residence, Los Altos, W. F. Standford (Kitchen & Hunt).....	Cover Oct. 10

## S

Safety Code Revised in National Hospital Survey.....	Jan. 10
Safety on the Job, Fixing Responsibility (G. W. Maxon).....	Mar. 7
Scaffolding, Aluminum, Versatility of.....	Apr. 20
School, Alcananes Union High (E. J. Kump).....	Feb. 23
School, Antioch Junior High, New Calif. Style (Kump & Falk).....	June 22
School, New Elementary, McKittrick, A Dream in the Desert (Wright, Metcalf & Parsons).....	July 20
School, Frankfort High, Stockton (Jos. Losekan).....	Aug. 29
School, El Camino College (Marsh, Smith & Powell).....	Cover Nov. 14

Schools, America Needs Practical.....	Sept. 11
Store Bldg., Flower Shop, Portland (Walter Gordon).....	Cover Feb.
Store Bldg., W. & J. Sloane, Beverly Hills (Paul Williams).....	Mar. 24
Store Bldg., McMurray Foto Co., Sacramento (Gordon Stafford).....	May 10
Store Bldg., Graflex Co., Hollywood (Albert A. Schwartz).....	Aug. 16

## T

Theatre, Drive In, San Jose.....	Mar. 25
Traffic Improvement, Urban (Franklin C. Balfour).....	Jan. 7
Transonic Barrier, Crumbling (Southwest research Inst.).....	July 10

## U

United Geophysical Company Plant, Pasadena.....	Dec. 15
University of California, Dwinelle Hall.....	Aug. 28
University of California, Class Room and Office Bldg.....	Aug. 28
University of San Francisco, Gleason Library.....	Cover Aug. 28

## W

Wage Scale, Building Industry, Northern, Southern and Central California.....	Jan.-Dec. 42
Western Timber Resources are Ample for Expanded Production.....	Dec. 21

## Y

Yakima's New City Hall is Model of Efficiency.....	Dec. 10
Youtz-Slick Building Method (Southwest Research Inst.).....	May 16





