

ARCHITECT AND ENGINEER



JANUARY

1946

HOW TO SAVE CONCRETE FLOORS FROM DUST AND DISINTEGRATION



BY A SIMPLE SCRATCH TEST you can prove that untreated concrete floors *will* disintegrate!

However, by treating concrete floors with LAPIDOLITH Liquid, they *can* be thoroughly wearproofed and dustproofed... with little more effort than is required for a simple washing.

FOR PAINTING FLOORS... Cemcoat Filler and Dust-proofer in colors and transparent, a durable coating for protecting and decorating cement or wood floors!

FOR FINISHING WOOD FLOORS... Lignophol is a one-application preservative wood finish which resists moisture, molds, fungi and wood-destroying organisms... gives lasting beauty, economically!

FOR PATCHING AND RESURFACING FLOORS... Sonomend is the new, easy way to resurface rough, splintery wood floors... cracked, rutted and pitted cement floors!

FOR CLEANING FLOORS... Mag-I-san whisks away practically every type of dirt from every type of floor!

LAPIDOLITH Liquid penetrates into the concrete and chemically produces a granite-like hardness. When subjected to traffic, the treated floor is virtually immune to dusting and disintegration.

Tests have proven that LAPIDOLIZED floors remain in perfect condition for years... and floors become waterproofed and oilproofed at the same time! Countless testimonials praise its effectiveness.

A call or note to us will bring a trained floor expert to your desk. He will gladly give you his recommendations on your particular floor problem.

...

Distributors for Sonneborn Products

WESTERN ASBESTOS CO.

DISTRIBUTORS • ENGINEERS • CONTRACTORS

675 TOWNSEND STREET, SAN FRANCISCO 3, HEMLOCK 4884
LATHAM SQUARE BUILDING, OAKLAND 12, TEMPLEBAR 7474

FOR ANY FLOOR PROBLEM — CALL WESTERN ASBESTOS CO.

ARCHITECT

Vol. 164 No. 1

AND ENGINEER

ARCHITECTS' REPORTS—Published Daily
Telephone DOuglas 8311

MARK DANIELS, A.I.A.
Editor

E. H. WILDER
Editor

JOHN S. BOLLES, A.I.A.
Book Reviews

MICHAEL GOODMAN
Post-War Planning

L. H. NISHKIAN
Consulting Editor

E. N. KIERULFF*
Ass't Editor
*In the Service

Contents for



JANUARY

x720.5
A124 ¹⁶⁴
581519

COVER: VIKINGSHOLM Overlooking Emerald Bay, Lake Tahoe

ARTICLES AND MISCELLANEOUS TEXT

RUNNING FIRE	4
By MARK DANIELS	
GOOD INTERIOR LIGHTING	5
By JEAN SCOTT FRICKELTON	
NEWS AND COMMENT ON ART	6
LOS ANGELES AUTOMOBILE SERVICE STATION	8
EMBODIES NEWEST FEATURES	
THE CONSTRUCTION OUTLOOK	9
By MARDI	
A HOUSE OR MODERN LIVING	10
By HENRY H. GUTTERSON	
WESTERN MERCHANDISE MART	12
TO BUILD BIG NEW ADDITION	
YOUR NEW HOME	13
WILL BE PLANNED BY CAMERAS	
A SCOTTISH CASTLE	16
For IKE EISENHOWER	
NEW DEVELOPMENTS IN THE USE OF STEEL	18
For BUILDING CONSTRUCTION, By CARL F. BLOCK	
RESIDENCE FOR H. C. BRADLEY, JR.	19
PASADENA, CALIFORNIA	
CHINATOWN HOUSING	21
FIRST UNIT OUT FOR BIDS	
VIKINGSHOLM On Emerald Bay, Lake Tahoe, California	22
IN THE NEWS	28, 30, 35, 37, 39, 43, 46
HEADLINE NEWS & VIEWS	23
By E. H. W.	
A.I.A. ACTIVITIES	31
WITH THE ENGINEERS	32
PRODUCERS' COUNCIL PAGE	38
ESTIMATOR'S GUIDE, Building and Construction Materials	41
CLASSIFIED ADVERTISING, Wage Scales	43
BOOK REVIEWS	45
ADVERTISERS' INDEX	48

ARCHITECT AND ENGINEER (Established 1905) is published on the 15th of the month by The Architect and Engineer, Inc., 68 Post St., San Francisco 4; Telephone EXbrook 7182. President, K. P. Kierulff; Vice-President and Manager, L. B. Penhorwood; Treasurer, E. N. Kierulff.

Los Angeles Office: Wentworth F. Green, 1709 West Eighth Street.

Entered as second class matter, November 2, 1905, at the Post Office in San Francisco, California, under the Act of March 3, 1879. Subscriptions United States and Pan America, \$3.00 a year; \$5.00 two years; foreign countries \$5.00 a year; single copy 50c. ARCHITECTS' REPORTS are published daily from this office, Vernon S. Yallop, Manager.



RUNNING FIRE — by MARK DANIELS

IT IS TO LAUGH

The radio and the press have been loud in their assertions that no statements of a Jap can be depended upon; that the Japs are all liars; that the only good Jap is a Dead Jap. The American people have been taught to ignore the pledges of the Japanese people. to rule out such pledges. And yet a high court brings an officer of the Japanese navy half way around the world to give testimony in the trial of one of our own men before our own court. If none of them, or nothing they say, can be believed, why send for one on whose testimony may hang a decision for or against an American Officer? It is not a question of just what kind of evidence the Japanese officer might give, but the general feeling that the conduct of an American should not be questioned on the strength of statements made by an enemy whom we are told is inherently a liar. As well take the testimony of a murderous gangster on the conduct of a member of a police force that apprehended the gangster. It is to laugh.

ROOM UP FRONT

People don't like to be told anything, either on or off a street car. It is useless to tell them there is plenty of room 'up Front', even if there isn't. They will not believe it or even look. No, telling people there is plenty of room up front is no way to get them to go there. But there is a way.

Build a small cocktail bar on either side of the motorman's stand with the sight of the mixer screened from the motorman's sight, of course. People will pack there, and like it. They seem to like it everywhere else. If the car passes your corner without stopping, as usual, you can order another.

Unquestionably there is a crime wave developing on the Pacific Coast, but let us not be too hasty in attributing it to the breaking out of an inherent predisposition to abstract crime. It can

very well be a product of the lack of housing, not only because people who live in homes are reluctant to commit crimes, but because committing a crime is getting to be the only way you can get housed, even temporarily. Further, we should be considerate of the poor convict who might be evicted to make place for the GI in the warm, wellbuilt penitentiary.

FEAR

Some eight or nine years ago, *RUNNING FIRE* carried an item called 'Cowards'. In a way that was a misnomer as a repetition of part of it will demonstrate.

There are many kinds of cowards. They are all slaves to fear in one form or another. Want, of itself, does not make cowards of us but the fear of it does. Poor Moll Flanders prayed to be delivered from want.

As Ecclesiastes wrote, "One is afraid of a height and terror is on the road."

We fear the sea, tremble in the hurricane, are afraid of snakes, thunder, darkness, failure, poverty, loss of wealth, accident, lies and truth; while "love makes cowards of us all."

The war is over. Let us be guilty of only **RIGHT-EOUS FEAR**.

UNO AND THE WEST

The majority has ruled again. Let's take their ruling and get back to our knitting. We have offered to house them on the Pacific coast but they have chosen to be housed in the east, where they will certainly need it. Perhaps it is significant that Britain voted against a location near to Australia. Anyhow, now that the UNO has turned down our offer to house them and we have failed in our efforts to house every organization except the returning vets, which is the only one we do need, perhaps we will return to that problem and give it our undivided attention. For heaven's sake let us solve the problem of housing our own.

GOOD INTERIOR LIGHTING

By JEAN SCOTT FRICKELTON

Interior lighting, styled to decoration, appears now to be a safe and satisfactory device for creating the illusion of an ultra modern home design. The trend will no doubt carry the architect over this period when the dreamed-up building materials of wartime consumer ads are simply not yet available. And modern lighting will actually be more than an illusion of modernity—it will actually be of the postwar - 1946 variety.

Demonstrating in detail this idea was the recent displaying of the "Home of Vision" in the John Wannamaker store in New York where three separate apartments presented the most recent innovations of the lighting-styled-to-decoration theme.

Interest centered on mirrored furniture and walls, fluorescent and phosphorescent-treated wallpaper and accessories, and fluorescent lighting concealed in cornices, coves and window valances. In one living room, decorated in the modern theme, the sectional sofa was backed by a lighted ledge and faced a huge picture window. Walls and carved rug of pale green, coral accents and other features were complemented by subdued illumination from a continuous fluorescent cove of modern design.

In the silver gray modern dining room, fluorescent tubes were concealed behind cornices on opposite walls and a pin-hole spot-light recessed over the dining table dramatized the table setting.

On the spectacular side was the leisure room, where cornices concealed both fluorescent and "black light" lamps. Silver colored wallpaper in chartreuse and green had been treated with fluorescent paints, as well as other objects throughout the room, such as pillows and drapes. When irradiated by invisible "black light" the colors sprang out in bold relief and yet appeared subdued under the fluorescent lighting alone. However, there was no nonsense over the bridge corner of this room, where the table was illuminated by a direct-light recessed ceiling fixture, equipped with fluorescent tubes.

Westinghouse's Better Home Department took a hand in the fashioning of the home service center,

designing it not only with a view to saving time, steps and motion, but also to conserving building materials and construction costs.

The combination kitchen and laundry had centralized plumbing and a single electrical distribution panel to service the two rooms. Both were 100 per cent lighted by fluorescent lamps. The recessed ceiling fixture, for general illumination, was supplemented by local lighting over the work areas—above the sink and under the overhead cabinets, with shadowless lighting as the result.

Ditto in the laundry, with the addition of a special unit which popped out of the wall with the ironing board for good light while ironing. However, in the dining nook a circular incandescent fixture in the ceiling was used to conform in shape with the circular table designed for this area.

The entire preview served to demonstrate a better coordination between the lighting engineer and the architect.

It is generally agreed that the new light sources and combinations resulting from the accelerated wartime research will provide greater flexibility in applied illumination. The postwar period promises new drama, new beauty and new usefulness in light with which to live—not just to see or to see by.

In its long history as a service to mankind, lighting has developed through three evolutionary eras. There was the light with which to see, when any light—light from star or moon, fire or candle, was something to tie to in a world of darkness.

The second phase in the service of light to mankind was the light to see by. With the realization that the human being is a complex seeing machine, lighting research men began the determination of many of the measurable lighting factors that effect seeing efficiency. Then, as the problems of a new age changed from those of mere seeing to those of efficient seeing, lighting laboratories developed a science of seeing.

As a result manufacturers came to understand that when they paid workmen's wages they were

(See Page 40)

NEWS AND COMMENT ON ART

COLORCADE OF AMERICA

The Institute of Carpet Manufacturers of America, Inc., have adopted nine basic home furnishings color groups, according to Leroy A. Beers, president of the organization.

Each color group is named after a section of the United States which the color symbolizes: tan, Alamo; rose, Grand Canyon; burgundy, Adirondack; mauve, Prairie; green, Shenandoah; beige, Cape Cod; blue, Great Lakes; cedar, Santa Fe; and grey, Great Smoky.

Manufacturers of carpets and rugs, upholstery and drapery fabric, wall paper, furniture, upholstery leather, paint and lighting equipment, are included in those who are promoting color coordination through the "Colorcade of America."

EXHIBITIONS

Dr. Jermayne MacAgy, Acting Director of the California Palace of the Legion of Honor, Lincoln Park, San Francisco, has announced the following schedule of exhibitions and special events for January:

PHOTOGRAPHS OF VENEZUELA, HAITI,
TRINIDAD, AND NETHERLANDS GUIANA

By Albert Greenfield

Opening January 12

PAINTINGS BY MATTHEW BARNES

Opening January 12

SCULPTURE AND DRAWINGS BY RAYMOND
PUCCINELLI

Opening January 12

ECCLESIASTICAL SCULPTURE

Through January 6

RELIGIOUS FOLK ART OF THE SOUTHWEST

Through January 6

PHOTOGRAPHS BY GEORGE BARROWS

Through January 13

The Alma de Bretteville Spreckels Collection of Sculpture and Drawings by Auguste Rodin.

The Mildred Anna Williams Collection of Paintings, Sculpture, Tapestries and Furniture.

The Collis Potter Huntington Memorial Collection of 18th Century French Paintings, Sculpture, Tapestries, Furniture and Porcelain.

SPECIAL ANNOUNCEMENT—Entry blanks are now available for the First Spring Annual Exhibition of Painting to be held during April, 1946. Blanks may be obtained from the Museum, Bayview 5610.

SAN FRANCISCO MUSEUM OF ART JANUARY EXHIBITION CALENDAR

CALIFORNIA WATER COLOR SOCIETY—25th Annual Exhibition at the Los Angeles County Museum, to be shown here Jan. 9 to Feb. 10.

LYNN LINARES of Mexico—Paintings—Jan. 15 to Feb. 3.

ART OF THE BAY REGION—Jan. 18 to Feb. 17.

ACTIVITIES: FREE SUNDAY PROMENADE TALKS—Miss Louise Ballard and Mrs. F. V. Rohr, of the Curatorial staff. Also guest speakers—4 p.m.

CLASSES

STUDIO WORKSHOP by George Harris—Wednesdays 7 to 9 p.m. For beginners, sketching from clothed model—beginning Jan. 9.

SKETCH CLUB by George Harris—Fridays, 7 to 9 p.m.—Painting from life for advanced students—beginning Jan. 4.

SATURDAY MORNING CHILDREN'S ART SESSIONS—Ages 6 to 14. 10c for materials—Painting, Modeling and other activities, 10 to 11:30 a.m.—beginning Jan. 12.

MONDAY EVENING LECTURE COURSE—Discovering Painting, by Claire Falkenstein—6 sessions of lecture-demonstration, followed by an opportunity for personal experience and experiment, exploring the painter's point of view—Jan. 14 to Feb. 18.

FILMS

FAMOUS FILM SERIES: Tuesday nights, 8 p.m.

PASTEUR (1936)—January 15.

THE MARK OF ZORRO (1920)—January 22.

PEARLS OF THE CROWN (1938)—January 29.

KNOW YOUR WORLD SERIES: Free Saturdays, Sundays, 2:30 p.m.

CANADIAN PROGRAM—January 19 to 20:

CANADA, QUEBEC, NEW FOUNDLAND,

LAND OF THE CREE,

LAND OF EVANGELINE.

NETHERLANDS EAST INDIAN PROGRAM—January 26 to 27:

PEOPLES OF THE NETHERLANDS EAST

INDIES, TORADJA, BALI, MACASSAR,

CEREMONIES OF BALI.

SPECIAL PROGRAMS

Organ Recital by Uda Waldrop, every Saturday and Sunday at 3 p.m.

CALIFORNIA SCHOOL OF FINE ARTS

Maintained by the San Francisco Art Association EXHIBITION SURVEYS CUBISM

The development of Cubism as seen through the eyes of its eldest master will be exhibited at the California School of Fine Arts in the main gallery of the School through December to mid-January. Paintings and prints by Jacques Villon, along with a small selection of works by his celebrated brother Marcel Duchamp, have been lent for exhibition by the Yale University Art Gallery from its famous **Collection Société Anonyme**.

According to George Heard Hamilton, Curator of Modern Art at the Yale gallery, this exhibition comprises "one of the most authoritative documents for the reconstruction of the Cubist dialectic." In addition to his paintings, Villon produced a series of colored engravings after other masters which provide a somewhat wider picture of Cubist evolution. These engravings, writes Mr. Hamilton, are in no sense copies. "Although faithful in color and form to the original, each is also an interpretation, Villon's private comment on the accomplishment of others, upon Braque and Léger, Croix and Metzinger, even upon himself. In this way we understand because we can see, how a master understood as he saw, his contemporaries. Villon has thus described an entirely new activity for reproductive engraving in our time; instead of a copy, criticism; instead of passive contemplation, positive participation."

Lately Villon himself stated: "Creation and abstraction are the logical outcome of the successive renunciations which have stripped painting of all that is documentary and utilitarian." Artists and students whose vision is now preoccupied with variations of this type will be interested to see, in concentrated exhibition, step-by-step evidence of the search which has led to current discoveries.

FIRST SPRING EXHIBITION

The California Palace of the Legion of Honor, San Francisco, has announced its First Spring Annual Exhibition, consisting of original works in oil or tempera by living artists, to be held April 3 to 30, 1946.

Four cash prizes totaling \$2,000—First Prize, \$1,000; Second Prize, \$500; Third Prize, \$300, and Fourth Prize, \$200—and ten medals specially designed for the California Palace of the Legion of Honor have been announced as awards.

Conditions of entry, announced by Dr. Jermyne MacAgy, Acting Director, follow:

Each artist may submit two paintings. Painting must be framed, but frames must not have screw-eyes. No painting can exceed 4 x 4 feet, frame included.

All entries shall pass before the Jury of Selec-

tion for acceptance or rejection.

No accepted work shall be withdrawn before the close of the exhibition.

Exhibitors who wish to have their entries listed for possible sale are advised to enter low but fixed prices. The work will be listed as not for sale if no price is given in the entry blank. No commission will be taken by the Museum.

Local artists will be required to pay all delivery expense to and from the Museum, regardless of whether entries are accepted or rejected. Out-of-town artists must send paintings to the Museum express prepaid, and rejected material will be returned at the expense of the artists. Accepted work will be insured by the Museum while on exhibition and accepted out-of-town work will be insured while it is in return transit. No local entries can be submitted after March 11 and no out-of-town paintings will be received at the Museum later than March 13.

At the conclusion of the exhibition, one purchase may be made provided funds are available and provided the Jury finds a painting suitable for the Museum's permanent collection.

The Jury of Selection and Awards will include Donald Bear, Director of the Santa Barbara Museum of Art; Alfred Frankenstein, Art Critic of the San Francisco Chronicle, and Reginald Poland, Director of the Fine Arts Gallery, San Diego. Paul Verdier, President of the Board of Trustees, will assist the Jury when the awards are made. The Jury is scheduled to meet March 19, 20 and 21.

Artists wishing to participate should send to the California Palace of the Legion of Honor, Lincoln Park, San Francisco 21, California, for an entry blank.

INTERNATIONAL LIGHTING EXPOSITION

Important and timely adjunct to the International Lighting Exposition in Chicago will be a series of Lighting Conferences scheduled to start on April 26 and continuing through April 30, 1946.

Advance indications are that these conferences will draw attendance from all parts of the nation.

CONTRACTORS REPORT

A report from the Associated General Contractors of America, Market Development Committee, headed by Fred I. Rowe of Columbus, Ohio, recommends against setting up any overall system for encouraging or discouraging the immediate start of particular types of construction.

They do urge, however, that contractors use their influence to suggest what projects could be undertaken in an orderly fashion in their own communities consistent with material and labor conditions.

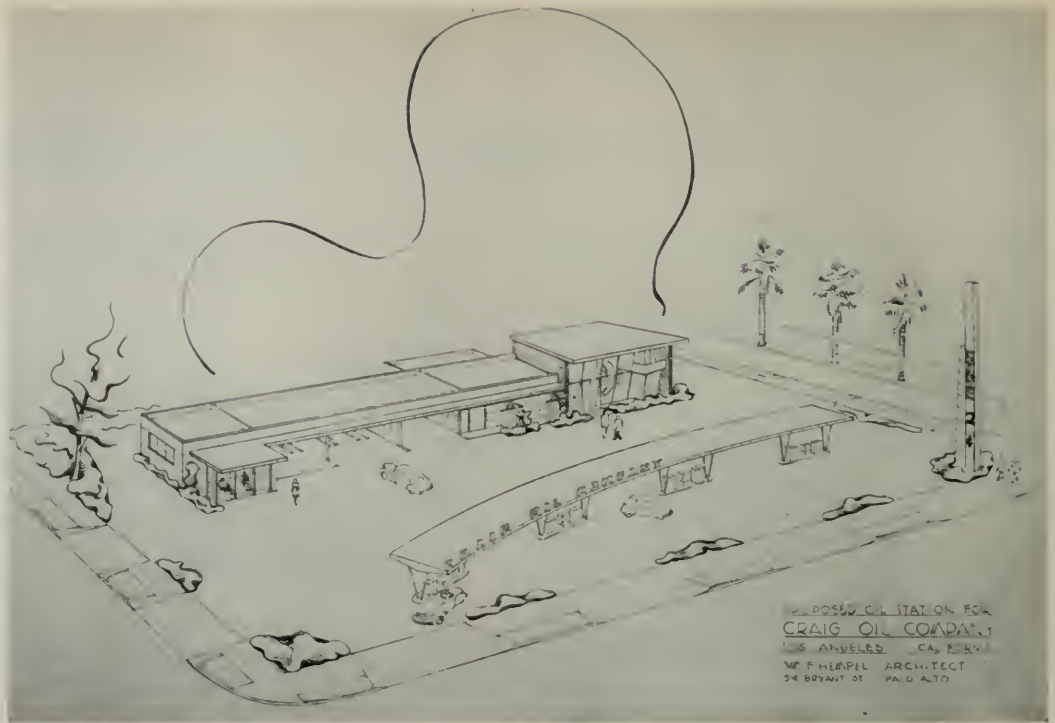

Los Angeles Automobile Service Station Embodies Newest Features

Designed by William F. Hempel
Architect, Palo Alto

In anticipation of a tremendous volume of pleasure and commercial automotive traffic throughout the Pacific Coast during the next few years, and as part of their program of continuous expansion, the Craig Oil Company, with general offices in Oakland, California, are building what is believed to be the largest automobile service station in the world in Los Angeles.

Covering an entire city block and incorporating some 50,000 square feet, the station was designed by William F. Hempel, architect, of Palo Alto, California.

To facilitate service to the public a battery of twenty-four gasoline pumps will be installed, as well as many other ultra modern features unique in the service station field, such as a newly developed vacuum device that not only cleans the car floor, but will also whisk dirt out of ash receivers, while the gasoline tank is being filled.

Behind the battery of gasoline pumps, a large structure will contain every facility for the serv-

icing of vehicles and for the comfort of patrons, presenting a complete, ultra-modern automobile service station.



John W. Craig

John W. Craig, president of the Craig Oil Company, in commenting upon his company's entering the southern California territory, said:

"There are more passenger cars registered in California than any other state, and with constantly increasing population and fine roads, this outstanding position should be even

further improved. We plan to continue our program of expansion, not only in the San Francisco-Oakland Bay Area and in Los Angeles, but elsewhere in the State as well."

Craig operated more than 100 automobile service stations in and around Erie, Pennsylvania, prior to coming to California in 1941 and opening his first station on the Coast just prior to the outbreak of the War.

Despite wartime conditions, gasoline rationing, and curtailed automobile production for civilian use, the Craig Oil Company had seven stations in operation in Oakland, Berkeley, and Alameda by V-J Day and two more were completed in November, 1945, with a tenth station under construction at the present time.

Ground was broken for the Los Angeles station on October 15, and completion of the project is expected this month.

Warren F. Fletcher, general contractor of Oakland, and the Gettins Steel Company of San Francisco were awarded the contracts amounting to approximately \$100,000.

THE CONSTRUCTION OUTLOOK

By MARDI

Just how to interpret the falling off of the residential and business awarded contracts during the period of November 12 to December 12 is difficult to determine. Invariably the business awards have been considerably larger than the residential, which is natural. But with the lamentable paucity of places in which to live and the hasty efforts to control things in some way that will free materials for residential construction, no one seems to know what will be the answer. One result might have been anticipated, and that is that the total of the business in progress of preparation would rise as the amount of awards decreased.

Also there is the fact that awards do not mean that construction has begun or that material for that construction is on hand, and so our crystal ball becomes more foggy.

In the period of November 12 to December 12 the awards ran as follows:

Residential construction	\$ 2,580,000
Business construction	\$ 9,923,000
Work in progress of preparation....	\$24,532,000

These figures show a falling off of the first two items and a material increase of the last item. Whether all three items should be in the class of the third is debatable.

In the meanwhile San Leandro has voted \$850,000 in construction; Ernest J. Kump is preparing the plans for an \$800,000 hotel in Reno; the plans for the \$4,000,000 Apparel City, prepared by J. Francis Ward and John S. Bolles, are out for bids; the Capitol Company is preparing to spend \$2,000,000 in San Francisco and an Oakland Hotel is planned for another \$2,000,000—all in excess of the above tabulation. Awarded or not, where are the materials for this amount of construction to be

found in central California? The Government's idea of placing a top limit on construction costs, as they did in the Chinatown Housing Project, based on 1940 costs, makes the situation worse. HELP! HELP!

FEDERAL PUBLIC HOUSING AIDS VETERANS ATTENDING COLLEGES

Temporary wartime family dwelling units and trailers are being transferred to colleges, universities, and municipalities by the Federal Public Housing Authority to aid in meeting the housing needs of veterans and servicemen, the agency has announced.

Costs of moving are paid by the institution.

Moving of temporary war housing is accomplished by sawing it in panels, transporting them, and reassembling the panels in the new location, a technique developed during the war program.

A project which was in the process of being converted into war housing units on V-J Day, at Eugene, Oregon, is now being completed for the use of student-veterans at the University of Oregon, while another project is being completed at La Grande, Oregon, for student-veterans at the Eastern Oregon College of Education.

Pacific Slope colleges and universities which have taken advantage of wartime dwelling units include: University of Idaho, 100 units; Montana State College, 25 units; Willamette University, Oregon, 25 units; Utah State Agricultural College, 100 units; and the Eastern Washington College of Education at Cheney, 50 units.

HOMES AND JOBS

When the National Association of Home Builders meet in annual convention in Chicago on February 25-28, their convention key note will be, "Homes and Jobs for Veterans," according to Frank W. Cortright, association executive vice president.

Other subjects scheduled for discussion include "Land Planning and Shopping Centers," "The Veteran's Place in Home Building," "More Efficient and Economical Construction Techniques, and New Materials and Equipment," "Mortgage Finance," "Cooperation Between the Building Trades Unions and Home Builders," and "Modern Sales Methods."

VETERAN ARCHITECTS

J. Warren Wright and Arthur C. Metcalf, recently with the armed forces of the United States, have formed a partnership for the practice of architecture.

Offices of the new firm are located in the Morgan Building, Bakersfield, California.



Roger Sturtevant Photos

A House for Modern Living

By HENRY H. GUTTERSON

Several years ago when two very active young career women of Berkeley, California, approached an architect, they outlined their program about as follows:

"Having chosen our professions as our number one interests, we desire to pool our means and build a home. We are sure that life will be pleasant together, and our basic ideas of home are similar. Although we shall be busy elsewhere on week days, when we come home we want a house that shall be so attractive and easily maintained that it can be made quickly and adequately to meet our needs, provide a background for our femininity and easy accommodations for our guests. It should command an inspiring view and yet be set in a garden of ample size to afford recreation and privacy."

All this was achieved and great fun was had in the process. Lots on Sterling Avenue in North Berkeley were chosen. From them a great panorama of cities, bay and hills was the fascinating foreground for an almost endless vista out the Golden Gate to the Farallones and on to China! Two small Fords were relied upon for transportation and all sense of isolation was lost in hopes of present freedom and future prospects for neighbors. In Geraldine Knight Scott, a Landscape Architect, was found one who was optimistic enough to compete with ground squirrels and other trespassers and with the fresh salt breezes from the Pacific.

So, on the rather steep western slope, there grew up a sturdy, simple, refined small house and a hardy, sun-drenched garden, with a shel-

tered patio, with lawns, and wind breaks that soon gave shelter to fruit trees and flowers, everywhere abundant.

The program of the interior included a gracious entrance hall with stairs up to the second floor and down a short flight to an ample, high ceilinged living room in the north wing, featuring the view through a glass end to the west and a library end to the east. The dining room, also commanding views and sunsets, the serving room and kitchen were put in the south wing and the patio was made accessible to hall, living room and dining room from different levels. The interiors are of soft, light green stucco and off-white enameled trim. The fireplace is of roman brick with a charming, simple over-mantel.

The garage was connected to the house at the midway landing of the main stairs, to enable the owners to reach their rooms directly. The second floor is a simple arrangement of two bedrooms with study alcoves joined by a single telephone instrument in a conversation portal between their desks. The spaces in the appropriate, high pitched roof were utilized for closets and storage.

The full-tiled bath is both gay and easy to clean! When a housekeeper is not available, the foresight as to ease of upkeep is appreciated.

The exterior is of white clapboards and vertical boarding crowned by a dark weathered, heavy, cedar shingled roof. Brick chimneys and gay potted plant shelf brightened up the color scheme even before the garden matured.

Later, to meet enlarged needs for the growing

importance of their work and the popularity of their hospitality, a wing was extended to the north to provide a study, guest room and bath and a housekeeper's room and bath. By careful adherence to the original quality requirements, this wing avoided the look of an addition, and completed an unusually charming and successful house with a special program and special distinction.

VENTURA RIVER FLOOD CONTROL

Residents and owners of property along the Ventura River watershed, Ventura county, California, recently voted \$3,400,000 bonded indebtedness for the construction of dams on Matilija Creek and Coyote Creek.

The two dams are part of a master plan of water conservation and flood control developed by the Donald R. Warren Company, engineers, of Los Angeles, and will take care of the domestic water requirements for the City of Ventura and the agricultural developments in Ojai Valley and along the Ventura River.

BUSY

A. J. "Al" Stream, recently made a vice president of the Plant Rubber and Asbestos Works, Oakland, California, has assumed supervision of the company's activities in the eleven western states.

The firm engages in heat insulation and mechanical packing.





L. J. HENDY, Architect for Capitol Company

Western Merchandise Mart To Build Big New Addition

Market at Ninth Streets, San Francisco

Vanguard of the Pacific Slope's commercial and industrial postwar expansion is construction of a new addition to the Western Merchandise Mart in San Francisco. The proposed new building is half as large again as the present building and will occupy 375 feet on Ninth Street, off Market, according to Frank K. Runyan, Mart president, who reports property rights have been acquired and construction will begin as soon as present premises can be vacated.

One of the show places of San Francisco, the present structure erected in 1937 contains over a half million square feet of floor space and represents an investment of \$3,000,000. The new addition which will give the building an "L" appearance from the air is estimated to cost in the neighborhood of two millions. Office and showroom space to become available when the addition is completed about January 1, 1947, has already been committed to home goods manufacturers, distributors, and wholesale firms throughout the nation.

Sixty thousand visits a year are made to this strictly wholesale building by retail store executives and buyers of home goods from the eleven Western states. This modern Mart houses representatives of one thousand factories, both na-

tional and Western, in furniture, radios, appliances, floor coverings, gifts, housewares, toys, decorative accessories and textile lines. These factories supply a half billion dollars worth of home goods annually to merchants in the Western area.

The Western Mart's expansion comes as an important milestone in the progress of the West. Since 1921 the population of the three Pacific Coast states of California, Oregon and Washington has increased from 5½ million to something over 12 million. These, plus the inhabitants of the eight Mountain States, comprise almost 16 million people.

According to figures of the United States Census Bureau, the per capita buying power of the nation in 1940 was \$565. In the same period, the per capita buying power of California was \$773, of Oregon \$590 and of Washington \$638 . . . the average for the eleven Western states being \$664. Last year the per capita effective buying power in the Pacific Coast states reached \$1517—the highest in the nation and over \$400 above the average.

27,232 established wholesale resources serve the 213,026 retail outlets in the eleven Western states.

YOUR NEW HOME WILL BE PLANNED BY CAMERAS

By **LALLA HUNTER**, *British Information Service*

When you want to build a house or a factory in years to come your first step will be to hire an architect who will employ an aviator to find the exact location suitable for your purpose, photograph it and give you an overall picture showing the contour of the land, neighboring buildings, woodlands, available water, gas and electric facilities.

This will be the peacetime job of one of the greatest sources of Intelligence built up during the war, the aerial camera, virtually unused for economic purposes previously.

With the fall of France came the end of almost all European sources of ground information, and the beginning of this new channel of Intelligence—the Photographic Reconnaissance Unit—a devel-

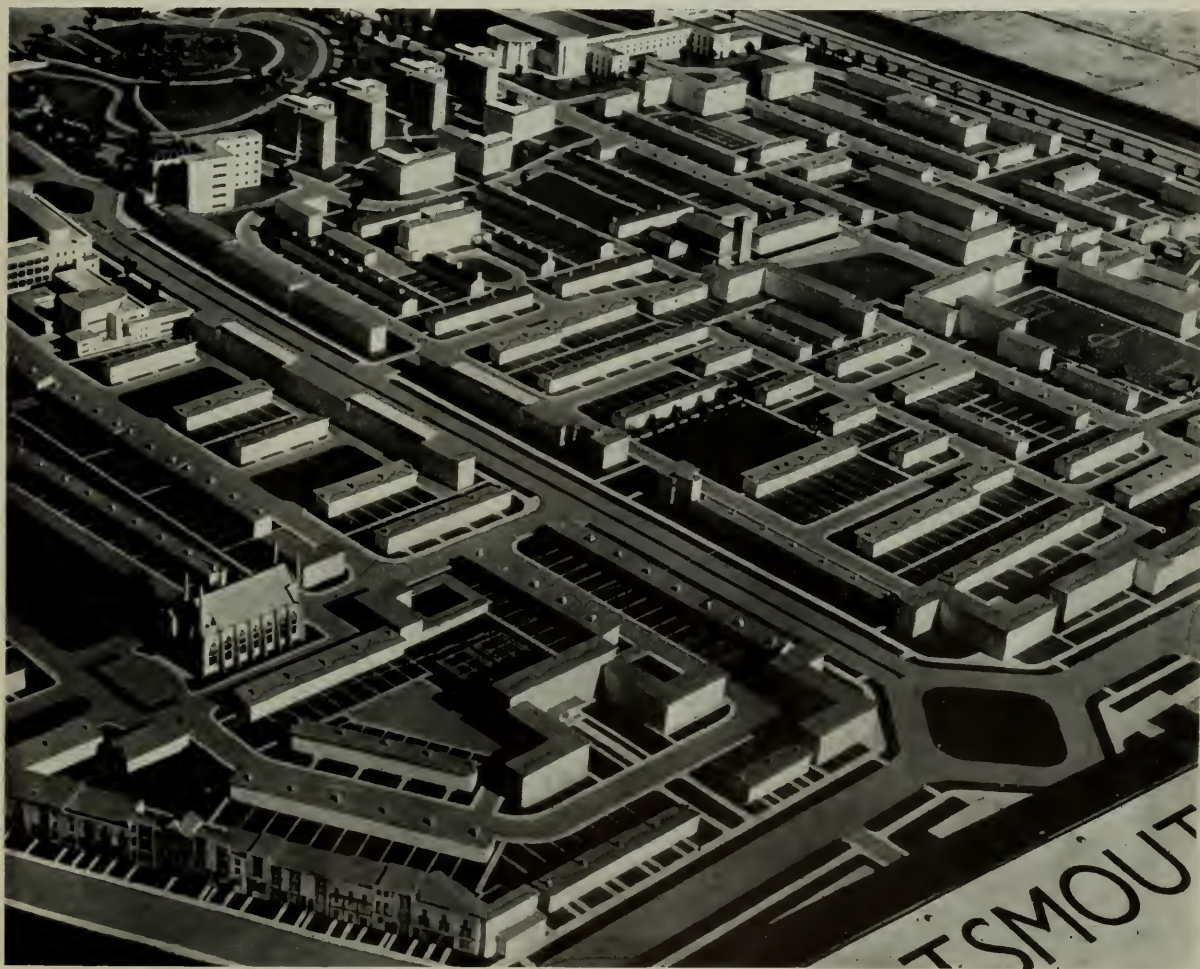

Blitzed British cities are now being photographed from the air and models made of proposed reconstruction—such as the above City of Portsmouth's model for rebuilding the center of the town.



The Cathedral

The Germans practically destroyed ancient Coventry with fire and high explosives in one of the worst raids of the war. Now Coventry goes ahead with the immense job of planning for rebuilding. As City Architect D. E. E. Gibson works on his plans, small scale models are laid out on miniature representation of the city's blitzed area.



opment destined to be a leading factor in the reconstruction of war-torn Britain.

Today, from Benson, England, the home of the famous photographic reconnaissance squadrons which "x-rayed" Germany during the war, blue-painted high-speed Spitfires and Mosquitoes, which used to flash unarmed across the Continent to photograph Nazi secrets, and Lancasters, which formerly bombed German cities and industries, are now also photographing British towns.

The camera-planes make 15 or 16 "runs" over their target towns, taking shots from heights varying from 2,500 to 25,000 feet, and providing exact topographical knowledge of the blitzed areas for the Ministry of Town and Country Planning. From these photos will be prepared the new ordnance maps of the country.

Not only will this newly developed photographic art be used for map revision and town planning, but it will be used by scientists and business houses. It will help in planning irrigation, soil classification, the construction of railways and the building of dams. Sites for new factories or hydroelectric plants will be located from the air, and archeologists will no longer tramp for miles seeking old ruins. These are easy to spot in air photos.

In other words, the shape of the world to come will be in "the negative."

Of the blitzed British cities, Bristol was the first to be "shot" by the R.A.F. and this occurred before V-E Day. Other peacetime targets on the agenda include London, Portsmouth, Coventry, Southampton, Bath, Exeter, Norwich, Canterbury, Dover, Great Yarmouth and Loewstoft.

Even before the war, and long before aerial photography came into its own, Britain, realizing that efficient mapping was essential for national development, planned a national survey of nat-

ural and economic resources of the country under the direction of the Ministry of Town and Country Planning, and the Department of Health for Scotland.

This new-style series of maps—the first national atlas of Great Britain—was exhibited recently by the Ministry in London and Edinburgh. It was described as the most comprehensive survey ever undertaken of the national life and resources of the country where "There is no comparable area in the world with so great a variety of types of land in so small a compass."

The work which has taken about two years, and probably will take two more to complete, depicts geological and physical structures, mining, industry, administrative areas, population, communications, public utility undertakings and a great variety of other information not published before.

There is a one-color topographical base map which is intended to serve as a standard underprint for the others.

This atlas used in conjunction with the new aerial photo-maps should be invaluable to town planners, educationists and research workers in many fields.

AERIAL PHOTOGRAPHS, an important source of intelligence during the war, are employed by girl cartographers in the map room of the British Ministry of Town and Country Planning—work in the new national survey.

British Official Photos





Culzean Castle Clock Tower (left). Kennedy family's coat of arms on gateway (right).

A Scottish Castle for Ike Eisenhower

As a tribute of the "esteem and gratitude" of the Scottish people, the main block of historic Culzean Castle, on the Ayrshire coast, close to the trans-atlantic airport of Prestwick, has been given to General Eisenhower for his lifetime. 160-years-old Culzean and a portion of the estate have been given to the National Trust of Scotland by Lord Ailsa and Francis Lady Ailsa. Their family, the Kennedys, will live in one wing, and General Ike's part of the main block will have a separate access and be fully furnished and permanently staffed for his use. He hopes to make use of it entertaining his British friends.



General view of Castle on Firth of Clyde



**Lord Ailsa's room
on the ground floor.**



**The main staircase,
Culzean Castle.**

New Developments in the Use of Steel for Building Construction

By **CARL F. BLOCK**

The properties of steel make it ideal for many uses in home construction. It is easily fabricated, readily available, adaptable to numerous methods of finishing and, finally, it is economical. These properties have led to experimentation with steel houses, with varying degrees of success in the past. Based on a study of the various experiments, the following four features stand out as being essential to the success of steel housing construction.

1. Public acceptance must be developed before any major changes can be made in housing design or in materials.

2. Infiltration of air must be prevented because of its effect on appearance, cost of maintenance and cleanliness. This can be solved by good design and proper fabrication.

3. Heat conductivity (through exterior walls) is of vital importance. This loss of heat directly increases costs, and the effect of condensation on interior surfaces raises the cost of maintenance. This problem has been solved by interrupting the continuity of heat conductivity through the walls and by use of insulation.

4. The direct replacement of several materials performing different functions by a steel unit performing these combined functions.

When this modern replacement practice is followed, for example, by using steel unit panel construction in place of the traditional stud, lath and plaster wall, the following advantages are secured.

1. Proper and sufficient stud strength is assured by correct design.

2. Good insulation can be easily provided.

3. Condensation difficulties are overcome by the insertion of materials having low heat conductivity.

4. A steel panel provides a flat, true interior wall ready to receive any desired type of finish.

5. Since a steel surface does not "breathe," the walls remain cleaner and consequently are easier to maintain. Likewise, they hold paint well, and as a result, retain their good appearance longer and with less attention.

6. The speed of erection and completion of steel panel construction is a decided advantage.

7. The adaptability of panel or cellular wall and floor construction to radiant heating may prove an interesting feature in the future.

8. The flexibility of steel unit design results in greater ease of building construction and simplifies building operation, storage and movement of material.

Modern steel construction is suitable for use in homes either with or without basements as may be required, so no unusual foundation problems are encountered. Steel floor units are fabricated from steel sheets formed into panels which can be bolted directly to the foundation. Over these smooth rigid panels a mastic top coating is applied and into this is set wood block flooring or linoleum. When a basement is not provided these floor panels are well insulated.

To the floor units can be attached vertical steel panels designed to provide the desired insulation and smooth wall surfaces and also the strength required to support the second floor or roof. These panels, room height and 16 inches wide, can be factory assembled into groups of three sections to give a four-foot module for easy erection. Other panel groups or modules contain window and door sections and modules with self-containing sliding doors may be available.

The exterior of one of these modern houses can be of any desired material such as brick, stone or wood. Windows having steel sections and frames, with sills made of porcelain enamel on steel or other protected metal with receptacles to collect

(See Page 34)



WHITNEY R. SMITH, Architect

Residence For H. C. BRADLEY, Jr.

This small, simple house is designed on the basis of an open and free plan ideally suited to the accommodation of a small family. The house is planned around a large central living room which opens through blanket windows upon a spacious front terrace effectively walled in from the street, insuring privacy.

An efficient kitchen serves directly into the eating section of the principal room. The larger of the two bedrooms opens out upon the living room terrace. The smaller bedroom, next to the bath, has two walls of windows.

The interior finish has been kept severely simple. Large rolling blinds fitted over the living

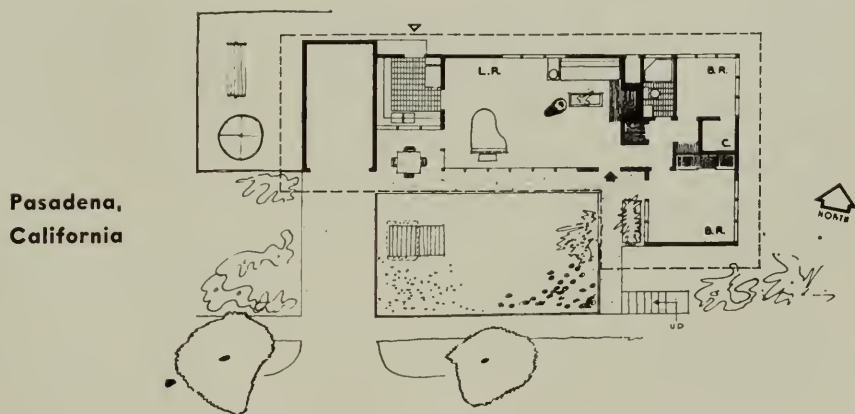

Pasadena,
California

room windows are used in place of curtains and drapes. Between the living room and garage there is a recessed living porch which can be served through one of the kitchen windows and is used as a protected outdoor dining space. The exterior is plaster and wood.

The simple uncluttered plan achieves a feeling of spaciousness that is unusual in a dwelling of this size.



Dapprich Photos

LUMBER SUPPLY LIMITED

The lumber supply in the United States seems destined to remain small for some time and price control by the OPA is expected to be continued, is the belief of R. J. Hoyle, associate professor of forest utilization, New York State College of Forestry.

Hoyle pointed out that the stock pile of green and dry lumber is at an all time low ebb and that strikes in the Pacific Northwest, labor adjustments in the South, and governmental regulations have minimized production.

The WPB estimated production for 1945 was 29½ billion board feet. However, the figure will not exceed 27 billion, thus it may be some time before there is an ample supply of lumber.

Architect Clarence Mayhew has opened offices for the practice of his profession at 127 Montgomery Street, San Francisco.

RENTALS AND THE OPA

Because 1,100,000 veteran families will be faced with no place to live, "we veterans might set ourselves up as a special group demanding special privileges," Wadsworth Likely, founder and staff member of the National American Veterans' Committee, said. He also blamed the homefront for having no solution to the housing problem after living with it for five years.

Other speakers on the Forum, discussing, "Can New Rental Housing Be Built Under OPA Regulations?" were Ivan D. Carson, Deputy Administrator for Rent, Office of Price Administration, Washington, and David Tishman, President of the Tishman Realty & Construction Company, New York, Association Secretary Thomas Jefferson Miley was Moderator.

Answering the question posed in the Forum: "Can New Rental Housing Be Built Under OPA Regulations?" Mr. Tishman replied: "On the basis of OPA performance up to this time, my answer is an emphatic no. OPA persists in maintaining a policy for new rental housing which—far from encouraging new construction—makes it impossible.

"The OPA formula ties the rents in new construction to 1943 depression-level rents, refuses to recognize that those rents are for apartments 15 to 30 years old. Take the case of a building finished in 1929. Today the rents in that building are just about one-half of what they were when it was first rented. Yet construction costs now are above those of 1929—the big boom year—to say nothing of the very substantial increase in operating costs.

"Simply stated, what OPA says is: 'Mr. Builder, a new apartment in 1929 was rented for \$100. The same apartment today brings \$50. If you wish now to build a house with that same identical type of apartment, you may charge no more than 20 per cent above the present rent, that is, \$60—regardless of the fact that your present building costs are even higher than in this boom year, 1929, and operating costs are also substantially higher.'

"What is needed is a free market for new housing accommodation. Such a market will encourage builders to begin construction at once. And at the same time not a single rent in existing housing will be increased. Why not give it a trial by applying this principle of a free-market on new construction to those buildings started within one year?"

REGIONAL COUNSEL

Leland O. Graham, for 10 years an attorney with the Department of the Interior, has been appointed Regional Counsel for the Bureau of Reclamation's Sacramento, California, office.



San Francisco,
California

Chinatown Housing First Unit Out for Bids

The Housing Authority of the City and County of San Francisco has called for bids on the first building unit of the Chinatown Housing Project. It has been a long time since the architects started on the plans, so full of enthusiasm over the possibility of building something with more than mere necessity inspiring their efforts.

Whether this is to be accomplished at last or not for the present is now up to the government and the government's decision as to whether they will allow more than their original estimated cost of 1940. At any rate, practically all the plans have been let out to reliable bidders on \$100 deposits and before the month is out the possibilities will be known.

The name, "Ping Yuen," for the project has caused considerable comment, mostly by those who are not liberal in their interpretation of an

idealistic language. In such a language there are many interpretations of words that are not specific. For instance a valley may be a vale, a garden, a sanctuary, a peaceful resting place, a tranquil place. A garden may be literally a guarded place, a play ground, a private enclosure, a private playground, a place to rest. All of these might be interpreted as a burial place, for heaven knows that a grave is a place for a long rest and is, it is hoped, tranquil. So, some have said that "Ping Yuen" means "cemetery." If so, then to retire from active work means to die, which well it may.

The selection of the name was put up to a committee of Chinese scholars in San Francisco's Chinatown. Ping Yuen was their choice after several weeks of study and they gave the meaning as "Tranquil Gardens" and until a better one is submitted so it will stand.



LENNART PALME, Architect

VIKINGSHOLM

on Emerald Bay
Lake Tahoe

By **LENNART PALME, A.I.A., Architect**

The homes of the old Norse Vikings were solid and massive in construction, and richly decorated with rhythmic, intricate carvings. A few of the Twelfth century buildings, among the oldest wooden structures in the world, remain in Norway.

When Mrs. Lora J. Knight purchased a large section of Emerald Bay at Lake Tahoe she realized that this strong, picturesque Viking architecture would be perfect in that wild poetic setting of giant trees and rugged rocky mountains. She invited me to tour my native Scandinavia with her to study the original buildings, and to discuss in museums, castles and ancient churches every detail of treatment and style.

Mrs. Knight's order was for a large, luxurious summer home with many guest chambers, ample service quarters, garages, and caretaker's cottage. Every arrangement was to be as comfortable and modernly appointed as ingenuity could provide.



Details of Main Doorway

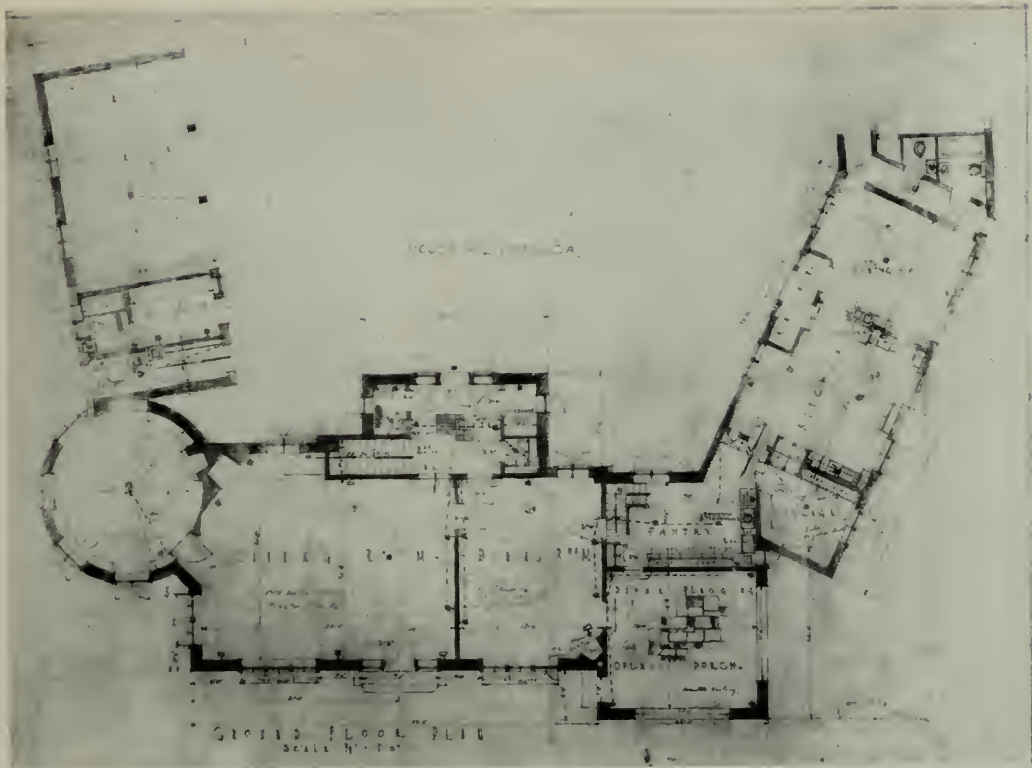

Above: Main Floor Plan

Below: Second Floor Plan

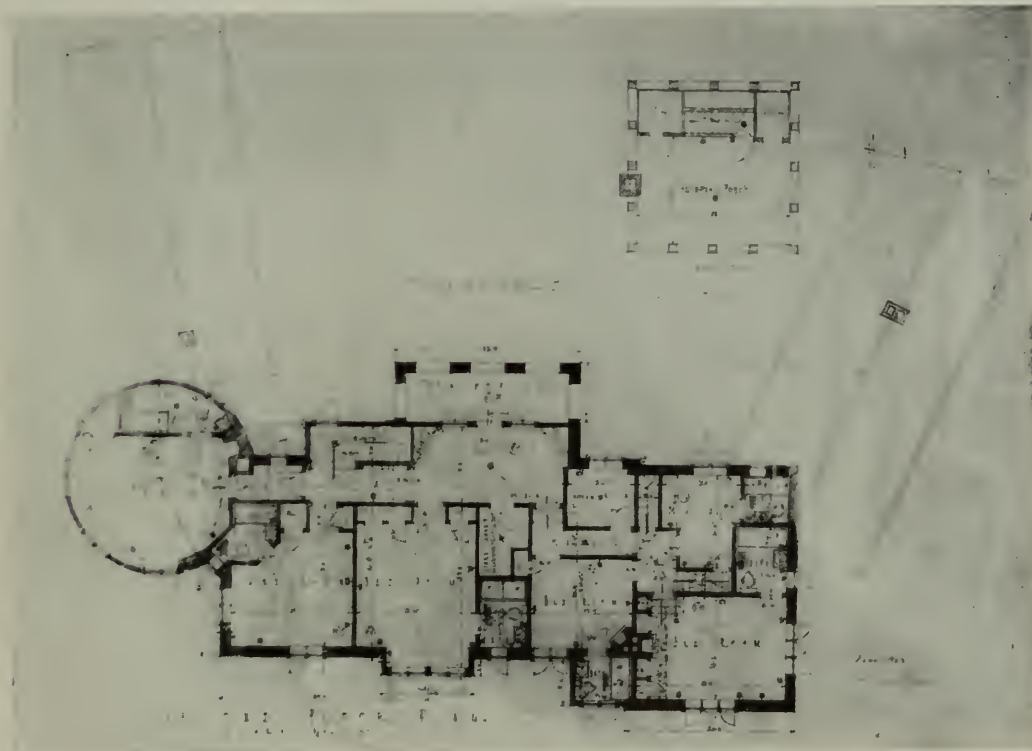



The main building facing the Bay took its inspiration from the very old primitive castles of Scandinavia. The stones for this were quarried from the hills just back of the house, which made the masonry blend harmoniously with the rocky scenery.

Grouped around a courtyard back of the main house were a series of massive wooden buildings with many of their details taken from the early heathen temples. Though these were, of course, planned as a unit to house the kitchen, maids' rooms, laundry and garages, the effect was of section added to section, perhaps through the centuries, as a need demanded.

The two side wings were low, and covered with a thick turf roof planted with native grasses and wild flowers. A sprinkling system was incorporated along the ridge pole in defiance of the endlessly blue California skies.

The old Norsemen used wood with the idea of preserving the strength and grandeur of the giants of the forests. Instead of cutting the timbers into narrow boards they used enormous hewn logs. They formed the corner posts as mighty keys for the wall timbers and joints, holding them together without spikes or bolts. The proportions of the houses suggested primarily the quality of

Shady walk alongside main house (upper), while below is entrance driveway through caretaker's house.





Distinctive Sitting and Music Room (above), and thatch-covered roof and beautiful chimney pot on wing of main building.





**Sleeping porch.
Beds are copies
of Norwegian
Queens styles of
about 800 A. D.**

Spacious dining room.



**Fireplace in corner
of dining room.**



EDITOR'S NOTE:

We can thank Mr. PALME for calling to our attention, before it is too late, the all but forgotten beauties of architecture which the talented members of our profession produced before designing was engulfed by war, and/or worse.
— Editor.

(Photographs through courtesy
of Nevada Photo's and Tavern
Studios Photo's.)

primitive Viking strength and the rich swirling carving on the wall and heavy columns borrowed their vigor from the storm-whipped trees.

All this, with timber of almost unlimited sizes from the vast Sierra forests, we tried to repeat at Vikingsholm. Two skillful Finnish carpenters were brought from the East to hew the wall boards, and for many weeks these gifted craftsmen stood at their patient task, rhythmically hewing with long, even strokes.

We only modified the construction at Vikingsholm to conform to modern ideas of comfort. Instead of solid stone walls and log construction we erected stud walls to give insulation, and room for pipes and wiring. We covered the frame with Vaporseal and asphalt paper, and to that we applied the stone work in the old Norse way, or the heavy carved or hewn planks, laid to imitate the timber construction of Scandinavia.

All the living room and bedrooms were finished with wood from a local saw mill. I had boards sawed up to three feet in width. Those boards were applied to the frame construction, waterstained, for the most part with silver gray tones, and treated with banana oil. This interior finish has stood up perfectly for seventeen years, without cracking and without any repairs. The interesting grain of the wide boards has added great interest to the house.

Vikingsholm is thoroughly modern in all its appointments. The kitchen and the numerous bathrooms are of this date and age. These we plastered and painted with enamel to avoid the cracks between wooden boards where dirt could accumulate.

As the exportation of good antiques from Scandinavia has been forbidden for many years Vikingsholm was furnished with copies of old



Looking towards Emerald Bay from main building shown below.

museum pieces selected in Sweden, and copied there by modern craftsmen. Many pieces were also made by a very excellent cabinet maker in Sacramento after my designs. On the wonderful tower sleeping porch are two beds carved with great stylistic horses' heads. The original bed, dating from about the ninth century, was that of a Norwegian queen, and was found buried in her funeral mound, together with carriages, sleighs and other belongings all richly carved. From those carvings motifs were borrowed for the decorative work at Vikingsholm.



JOINS DYNAMIC AIR ENGINEERING

The Dynamic Air Engineering company of Los Angeles, California, has appointed Elmer Lehmkuhl sales manager in charge of sales to original equipment manufacturers.



Elmer Lehmkuhl

Mr. Lehmkuhl is well known throughout the nation as an authority in heat transfer and ventilating engineering, according to Harry Glascock, president, of Dynamic Air Engineering who announced the appointment.

Lehmkuhl was formerly associated with ProPELLAIR, Inc., and the Master Electric Company of Dayton, Ohio, and has spent some time with the Cleveland Division of Dynamic Engineering.

ARCHITECTURAL EXAMINATIONS

The State Board of Architectural Examiners have again adopted the procedure of giving two written examinations a year, and have scheduled the next examination for January 14-17, 1946.

Examinations will be held simultaneously in the northern and southern sections of the State.

Applications and fees must be on file in the Board office, 907 State Building, Los Angeles, on or before December 16, 1945, when registrations will close.

Questions of past examinations may be studied at the offices of the Board in either 611 State Building, San Francisco, or 907 State Building, Los Angeles.

GYPSUM CONCRETE STANDARD

The American Standards Association has just completed revision of an important standard in the building field, covering design, construction and use of reinforced gypsum concrete.

It reaffirms many detailed definitions originally approved in 1941, but adds to it the results of four more years of study.

Copies of the new Code (A59.1-1945) are available from the Association's offices at 70 E. 45th Street, New York City 17, N. Y., for 25c per copy.

EDWARD D. CERRUTI, Jr., A. I. A., announces the opening of offices for the practice of architecture at 427 13th Street, Oakland, California.

CONSTRUCTION INDUSTRY READY

"Recent formation of the Construction Industry Advisory Council in Washington, D. C., on which nearly 100 trade and professional organizations are represented, means the nation's second largest industry for the first time is organized to meet its complex problems with unity of action and purpose," George W. Reed, chairman of the Construction and Civic Development Department of the Chamber of Commerce of the United States, declared recently.

The new council embraces virtually every important branch of the industry which represents from 10 to 15 per cent of the nation's economy.

COLUMBIA STEEL ENGINEER

Paul F. Kohlhaas, Piedmont, California, has been appointed vice-president in charge of Engineering of the Columbia Steel Company.

During the past sixteen years he has assisted in the building of iron and steel plants in England, China, Japan, Manchuria, India and many parts of the European continent.

KITCHEN VENTILATORS



Recent surveys of home building plans indicate a wide desire for installations of ventilating fans in new home construction, and to meet this fast growing demand the ILG ELECTRIC VENTILATING CO., 2850 N. Crawford Ave., Chicago, are again featuring their well-known line of fans.

Standard models include a variety of permanent, or "portable," styles in a wide range of sizes and prices.

ILG ventilators have been in home and apartment use for more than 20 years.

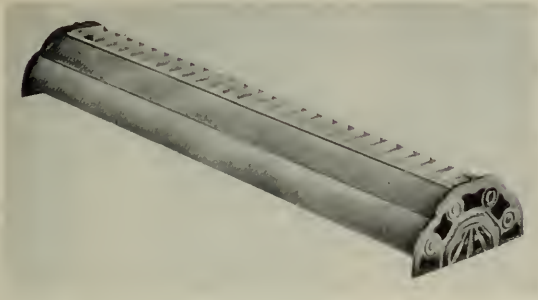

A new commercial fluorescent fixture, employing either 2 or 4 20-watt lamps, and 4 to 8 40-watt lamps in 4 or 8 foot lengths, has been announced by the JOLECO CORP'N, 2517 Baldwin Street, St. Louis 6, Missouri.

More light is achieved by positioning lamps on reflector points, while air-draft cooling is used for ventilating the fixture body.

Offers quicker installation, lower maintenance cost and high intensity of glareless illumination. Complete information and specifications upon request.

RETURNS TO WASHINGTON

Alden K. Smith, manager Western Service and Sales for the Timber Engineering Company, has been assigned to the development of the company's new Teco-Post Spindle system of construction with offices in Washington, D. C.

TECO connectors and installation tools are now being distributed in the San Francisco bay area by the TIMBER ENGINEERING COMPANY OF CALIFORNIA, 85 Second Street.

CALIFORNIA UNEMPLOYMENT INSURANCE UNAVAILABLE TO TRADE DISPUTES

As a result of the increase in the number of trade disputes and their consequent effect upon claims for California unemployment insurance, James G. Bryant, chairman of the California Employment Stabilization Commission, issued the following "clarification memorandum" recently.

"The disqualification under Section 56(a) of the Act is imposed on claimants who 'left their work because of a trade dispute.'

"A claimant who becomes unemployed because of his participation in a trade dispute with his employer either by reason of direct strike action by his union or because of his failure or refusal to cross a picket line to return to work is disqualified from receiving benefits under this section."

Where claimants are "locked-out by their employer," they may apply for compensation under the terms of the Act.

HEADLINE NEWS & VIEWS

By E. H. W.

Several outstanding American architects have been assigned the task of creating a practical low-cost home, according to Roy C. Ingersol, president, Ingersol Division, Borg-Warner Corporation, who proposes a prefabricated house to sell at \$3,000 to \$10,000.

△

Bethlehem's new booklet "Steel Facilities on the Pacific Coast" should be an incentive to many an industrial organization's promotion department.

△

Obviously America's postwar housing needs can not be measured in terms of prewar depression years, or wartime emergencies LOCAL communities are in the best position to KNOW their needs, Federal agencies should then cooperate.

△

The Victory Clothing Collection appeal for overseas relief will be made during January. Things you can spare that they can wear should be turned into your local collection agency.

△

Lieut.-General Eugene Reybold, Chief of Engineers, United States Army, has prepared and released "A Tribute to the Engineers in World War II." There is no way of measuring the great work of those serving with the "Engineers," nor their contribution to Victory.

△

"The Red Cross at the Golden Gate" is the title of a well illustrated, interesting booklet recently released by the San Francisco Chapter of the American Red Cross. Few people realize the scope of community effort represented by the Red Cross.

△

Addition of the Tacoma, Washington, Chapter brings the membership in the Associated General Contractors of America, Inc., to 92 Chapters and a total membership of more than 3,300. Quite a factor in the building industry of the nation.

△

Pabco's immediate four and one-half million dollar factory expansion project has been increased a million and a half by enlargement of the research laboratory facilities at Emeryville, California, according to R. H. Shainwald, Paraffine Company vice president.

△

The American Standards Association has approved A62.1 and A62.2 wherein building materials and equipment will be coordinated in dimension thereby effecting improvement in quality and a reduction in cost.

IN THE NEWS

NOTED LOS ANGELES ARCHITECT DIES

Donald B. Parkinson, 50, prominent architect, died in Los Angeles.

With his father, the late John P. Parkinson, he designed the City Hall, the Federal Building, the Union Station, the Memorial Coliseum and other large structures in Los Angeles.

FAIRBANKS DISTRIBUTOR

The Milwaukee Machinery Company of Portland, Oregon, has been appointed exclusive distributor for the complete line of Fairbanks-Morse Turbine Pumps, including the F-M Pomona Pump and F-M Oil Lubricated Turbine Pump, in Portland.

In Seattle, Washington, the Cascade Machinery Company has been named local distributor for F-M pumps, motors and electrical equipment.

UTILITY FLOOR FURNACE

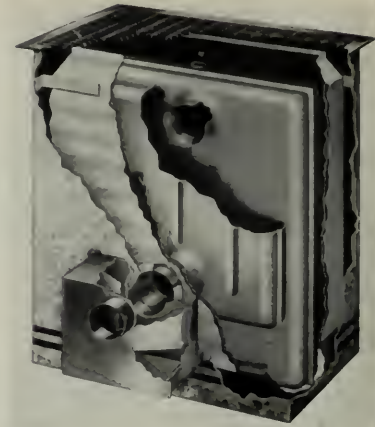

New models of the Utility Floor Furnaces, manufactured by the UTILITY APPLIANCE CORPORATION, 4851 S. Alameda, Los Angeles 11, California, have a clean, streamlined appearance, with a minimum of projecting floor grills.

Dual models have a new damper control that assures smooth operation and positive distribution of warm air. All models meet A. G. A. requirements.

NEW EXPANSION VALVE

A new thermostatic expansion valve designed for standard commercial use, such as conditioning, display cases, refrigerator boxes, and other utility uses has been perfected by the TENNEY ENGINEERING, Inc., 2 Avenue B, Newark 5, N. J.

The valve can be easily taken apart for cleaning.

This new Tenny Valve has all the advantages of a "gas charged" and "liquid charged" valve, with none of the disadvantages.

ELECTRIC CATALOG

A concise treatment of Engineered Lighting and Control Lighting is covered in an 8-page catalog just issued by the HUB ELECTRIC CO., 2221-A W. Grand Ave., Chicago 12, Illinois.

Stage lighting, exit and directional signs, indirect lighting, built-in lighting, fluorescent troffers, and switchboards are covered in the pamphlet.



Although only measured in millionths of a millimeter the mighty molecule of moisture can destroy the effectiveness of refrigeration insulation by making it wet and soggy.

BROWNSKIN VAPORSEAL installed as a protective wall between insulation and the outside warm areas eliminates the power of these moisture particles to penetrate the insulation and make it valueless. You get perfect refrigeration protection with **BROWNSKIN VAPORSEAL** because:

- 1) It is made of laminated and impregnated kraft, and sheets are bonded with asphalt to provide vapor and water proofing.
- 2) It is creped to resist stress and strain which eliminates tearing and shrinkage. **BROWNSKIN VAPORSEAL S-T-R-E-T-C-H-E-S.**
- 3) It is specially treated with bituminous compound to stop fungus growth, to resist vermin and to prevent deterioration.

If you plan a refrigeration unit of any type, assure effective and everlasting results with **BROWNSKIN VAPORSEAL**. Samples and complete product information gladly sent on request.



Quality Products Since 1895

ANGIER SALES CORPORATION

Framingham, Massachusetts

PACIFIC COAST OFFICE: 116 NEW MONTGOMERY ST., SAN FRANCISCO 5, CALIFORNIA

DISTRIBUTORS

WESTERN ASBESTOS CO., SAN FRANCISCO
LOCKWOOD WAREHOUSE CORP., SEATTLE
BUILDING SUPPLIES, INC., SPOKANE

WARREN & BAILEY CO., LOS ANGELES
MASON'S SUPPLY CO., PORTLAND
R. W. FRANK & CO., SALT LAKE CITY

A. I. A.

ACTIVITIES

AMERICAN INSTITUTE OF
ARCHITECTS



Northern California Chapter:

Andrew T. Hass, President; E. Geoffrey Bangs, Vice-President; John S. Bolles, Secretary; Hervey Parke Clark, Treasurer; 369 Pine Street, San Francisco 4.

Southern California Chapter:

Robert V. Derrah, President; Kenneth S. Wing, Vice-President; Henry L. Eggers, Secretary; Floyd Rible, Treasurer; 832 W. 5th Street, Los Angeles 13.

CALIFORNIA COUNCIL OF ARCHITECTS:

John S. Bolles, President; Robert H. Orr, Vice-President; James H. Mitchell, Secretary-Treasurer; 369 Pine Street, San Francisco 4.

The feature article of the November-December issue of the bulletin of the Northern Chapter of the A.I.A. was devoted to the bete noir of the architectural profession and building contractors—building costs. Very little can be done to get this elusive item into tangible shape, but the bulletin gives about the most reasonable resume that has yet come out. The bulletin states that the better types of speculative housing that can be readily sold on the present market run to \$6.00 per square foot. Houses designed by architects for specific conditions are running from \$7.00 to \$10.00 per square foot, although some on the peninsula have been reported as low as \$6.50. Class "C" apartment houses are estimated at from \$7.50 to \$8.00. No definite figures for hospitals and schools are yet available but it seems safe to estimate hospitals at \$7,000 to \$10,000 per bed and one-story schools at \$12.00 per square foot.

It was announced that at a later date a new issue of the Fee Schedule for Architects would be issued, an issue that is sadly and sorely wanted. At the October meeting the speaker of the night, Mr. F. K. Pinney of the Armstrong Cork Company, was introduced by J. Francis Ward of the program committee.

Mr. Temple Dick, Assistant Director for Development, FPHA Region 6, presented the case of San Francisco's predicament in facing her sudden increase in population and demand for housing accommodations. He said that the individual community's problem "cannot be met by any stopgap, blanket set of formulae."

The November meeting of the Southern California Chapter, under the Chairmanship of Sumner Spaulding, was devoted mostly to a discussion of Atomic Energy, and as might be expected, was one of the largest in the history of the chapter.

In his opening remarks Dr. William Fowler, Assistant Director of Research on Rockets and Atomic Energy at the California Institute of Technology, stated that it would be foolish to assume that countries like Denmark, Germany and Italy which had laid most of the groundwork, would be unable to develop a similar or more powerful bomb than ours. He was followed by Dr. Harry Hoijer, Anthropologist and Senior Duena of Ecuador.

GRANTED ARCHITECTS' CERTIFICATES

The California Board of Architectural Examiners granted certificates to practice architecture to the following:

Donald L. Bartels, Downey; C. Wallace Bonsall, Los Angeles; Herbert James Brownell, El Monte; Clifford Conly, Jr., San Francisco; Cecil R. Curtis, Los Angeles; Roy Mansfield D'Jeri, Los Angeles; Roy William Donley, Los Angeles; Caspar Johann Ehmcke, Los Angeles; William Loegler Faulkner, Santa Ana; Frank S. Gerner, Berkeley; Irvin Wm. Goldstine, San Francisco; John Garfield Grace, San Francisco; Henry Robert Harrison, Los Angeles; George C. Hatch, Bonita; Eugene M. Hoffman, Santee; William Hyberg, Burlingame; Frank Cannon Hyde, Long Beach; Graeme Joseph, North Hollywood; Roy A. Kazebier, Ontario; Henry David Kensit, Alameda; Mary Frances Knee, Long Beach; Guy O. Koepp, Hollywood; Roland Koerner Kuechle, Oakland.

Robert Welch Long, Berkeley; George Miles Montierth, Long Beach; Marshall Dey Mortland, Fresno; Andrew Foster Murray, Santa Monica; Harold Axel Onstad, San Francisco; Nathaniel Alexander Owings, Chicago, Ill.; Kermit Magnus Paulson, Berkeley; Lisle Frederick Richards, Santa Clara; Joseph Allen Stein, Mill Valley; Hector Varnell Tate, Los Angeles; Anthony Thormin, Los Angeles; William M. Van Fleet, Fairfax; Frederick Wallis Whittlesey, San Mateo; Karl Frederick Wieger, San Diego; Harry J. Williams, Palm Springs; Raymond Godfrey Willis, Oakland; Arthur Wolfe, Glendale; and Worley K. Wong, Oakland.

The above applicants admitted to practice are those that successfully completed the examinations which began with the written examination in June, 1945.

CLARKSON COMPANY EXPANDS

The Window Hardware Division of the Dalmo Victor Company, San Carlos, California, has been acquired by the CLARKSON COMPANY of Belmont, California.

Main offices of the Clarkson Company are located at 1700 El Camino Real, Belmont, while the general sales offices are at No. 1 Montgomery Street, San Francisco.

WITH THE ENGINEERS

ENGINEER PRESIDENT

William Adrian, prominent west coast structural engineer, was elected president of the Structural Engineers Association of Northern California at the 16th annual meeting of the organization, recently held at the Engineers Club, San Francisco.



WILLIAM ADRIAN

William M. Moore was elected director and vice president, and Mark Falk and M. V. Pregnoff were named directors.

Other officers include: Harold M. Engle, director, and Franklin P. Ulrich, secretary-treasurer.

The San Francisco section of the American Society of Civil Engineers held their meeting at the Engineers Club of December 18th. The technical program was occupied with a paper on "Experiences with Predetermined Pile Lengths," by William W. Moore, Assoc. Member of the Am. Soc. C. E. and was commented on by several members and associate members. The December bulletin of the section announces that there were 400 members and guests at a special meeting on November 27 at the P. G. & E. Auditorium, to hear Col. Franklin T. Matthias speak on "The Hanford Project and Atomic Bombs."

The new and extensive facilities at Hunters Point, until recently highly confidential, were recently visited and inspected by a hundred mem-

bers of the section. Also on November 27th the San Francisco section of the Society's Collective Bargaining Group adopted a constitution and elected permanent officers. They were: C. Martin Duke, President; Blair I. Burnson, Vice-President; Howard C. Lane, Secretary.

HONORED

Chas. H. Purcell, California Director of Public Works, received signal recognition in New York City on January 15, when he was given the award of honorary membership in the American Society of Civil Engineers.

The honor was conferred upon Mr. Purcell in recognition of his outstanding professional accomplishments.

ARMY ENGINEERS DEVELOP GYPSUM

Gypsum products in various forms initiated by U. S. Army Engineers will lend themselves to post-war building, according to the War Department.

One such product is a dry wall, self supporting, two-ply laminated gypsum board interior partition and another is a structural, light weight gypsum board surfaced on one, or both, sides with a tough, flexible sheet of asbestos fibre and cement one-eighth inch thick.

The flexibility, space saving, heat and fire resistant properties, hard smooth surface and ease of handling and application give these products broad postwar construction possibilities.

Forward strides have also been made in the production of structural gypsum base plaster and stucco materials for specialized application. It is now employed by engineers in construction of walls and ceiling finishing where smoothness and hardness are of prime importance.

ASSISTANT SECRETARY

Harrison D. Comins, Davenport, Iowa, has joined the New York City staff of the American Society of Civil Engineers and will specialize in affairs pertaining to student chapters, local sections and technical divisions.

Announcement of the appointment was made by Col. William N. Carey, secretary and executive officer, American Society of Civil Engineers.

HENRY KARBBER, prominent member of the American Society of Agricultural Engineers, has been named Field Office Superintendent for the Kern County, California, area of the U. S. Bureau of Reclamation.

DUES—Most members have paid their 1945 dues. If you are one who has not, please send in yours today and save the secretary a lot of worry.

PEPAREDNESS

The United States Steel's American Bridge Company plant at Ambridge, Pa., is experimenting with the possibility of putting America's big guns and other heavy artillery equipment in hermetically sealed containers instead of scrapping at the closing of the war.

A welded steel container resembling the Army Quonset Hut has been developed which will preserve equipment by injecting an inert gas atmosphere in place of the normal atmosphere with its corroding factors of oxygen and moisture.

Come another war a burner's torch will open the sealed-in units and, presto, an army is equipped.

LUMBER IN PRE-FABRICATION

An automatic process which eliminates the normal dimensional limitations of lumber in the pre-fabrication of almost everything made of wood, from ironing boards to houses, has been developed by the MUSKEGON MACHINE COMPANY, Inc., of Newburgh, N. Y.

Through combination of known principles, applied to automatic mass pre-fabrication, the process opens possibilities for economical mass-production of all kinds of articles from wood.

Panels ranging from 1/2 to 3 inches thick, from 10 inches to 16 feet in length, and of practically any width can be made "in one piece," automatically by feeding untrimmed lumber of any size in a machine which is an evolution of the well-known "Linderman" machine, used for many years to eliminate waste in the lumber industry.

Prime characteristic is that the machine "welds" wood together.

FORCED HOT WATER HEATING

Newest developments in radiant panel heating have strengthened the position of forced hot water as an ideal heating medium, according to an interesting, highly illustrated booklet recently issued by the BELL & GOSSETT COMPANY of Morton Grove, Illinois.

Application of this method of heating to apartment houses, commercial buildings, industrial plants, and the home is covered in the booklet.

A B & G Handbook, giving complete data on the principles, design and installation of forced hot water heating systems is available upon request of the Company direct.

California has over \$700,000,000 in its unemployment reserve fund to use as a cushion for unemployment during the postwar conversion period. Industrial and home building programs awaiting only the release of necessary construction materials will have a tremendous bearing upon any extended period of unemployment.



..and here's where we've planned telephone outlets"



Your clients will be pleased with built-in telephone facilities. Multiple outlets are conveniences that add real value to the homes you build today.

Even if only one telephone is needed now, it is wise economy to include additional outlets.

Conduit is inexpensive if installed during construction...and it provides for future telephones without tearing up floors or bringing wire in along baseboards.

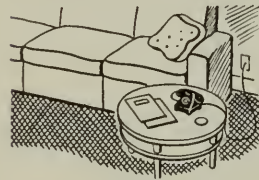

So plan built-in telephone facilities with an eye to

future needs. Our Architects' and Builders' Service will help you in every possible way at no charge.

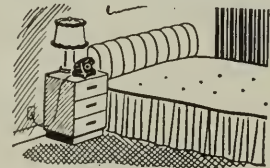

The Pacific Telephone and Telegraph Co.



NEW DEVELOPMENTS IN THE USE OF STEEL FOR BUILDING CONSTRUCTION

(From Page 18)

any moisture produced by condensation are now available. Interior wall panels for separating rooms, replacing conventional walls, can be designed and constructed to provide useful storage space, shelves and cabinets. A linen cabinet has been designed to replace a wall section and provide space for towels, cleaning tissues, toilet tissues, soaps and accessories, medicine storage or a clothes chute. A building using this new construction in River Forest, Illinois, has 281 apartments and has proved to be very economical to heat and maintain.

Flat roofs can be of normal roof construction with gravel stops of colored porcelain enamel on steel. Gable roofs can also be constructed, if desired, of light steel framework or pan construction covered with porcelain enameled steel shingles or enameled clapboard-type steel roofing sections.

Steel stairs are now available for use in homes. Bedrooms in the new steel house would be designed with two adjoining rooms with a complete cabinet between instead of a space-wasting wall. The cabinet would be divided to serve each of the bedrooms and would extend from floor to ceiling, providing space for all types of storage including the usual clothes and drawer spaces. These clothes storage spaces would have doors on piano

hinges or sliding doors. Being practically airtight, they would be ideal for moth-proof storage of blankets and winter clothing.

Bathrooms offer an opportunity for displaying the full range of colors and finishes on steel used both in the walls and ceilings. Pressed steel bathtubs, lavatories and shower stalls made of porcelain enamel on steel and furnished in colors to harmonize with the walls are now available. Medicine cabinets are now on the market manufactured of beautiful stainless or porcelain enamel on steel.

The kitchen has already responded to the story of steel. New types of cabinets will soon be available in new designs and finishes. Pressed steel sinks of stainless steel or porcelain enamel on steel with bowls and drainboards, as well as wall tile, will be available in the same material.

Radiant heat is also in prospect for the American home owner. Steel walls, floors and ceilings provide the ideal medium for applications of this type. Hot air, electrical tube, steam or hot water types of heating equipment are all equally adaptable for radiant heating. One system circulates air at 130° above a suspended ceiling. Other new systems have been developed using steel baseboard or cornice panels of a room to circulate the heating medium. In England and France large panels have been placed on walls or suspended in rooms to provide radiant heating.

Each application must be specially tailored for the job it has to do. Since steel is easily fabricated into identical sections, it lends itself readily to mass production. Straight line, one-story production structures offer industry economies and efficiency never realized before. These buildings have covered from ten to more than fifty acres, each constructed with steel frames, steel roofs and steel sidewalls, many being windowless. Exterior decorative features at the entrance or office section have made some of these buildings outstanding in appearance. Hospitals and all types of educational buildings lend themselves particularly well to the use of porcelain enamel on steel.

Interiors and equipment made of fire resisting steel will not burn. Every pound of combustible material eliminated from buildings reduces the fire hazard, thus leading a trend toward safer, more easily maintained buildings.

February will see a gala gathering of "metal" industry conferences in Cleveland, Ohio, from the 4th to 8th when the following meet: National Metal Exposition, National Metal Congress, American Society for Metals, American Industrial Radium and X-Ray Society, American Welding Society, and the American Institute of Mining and Metallurgical Engineers Iron and Steel and Institute of Metals divisions.

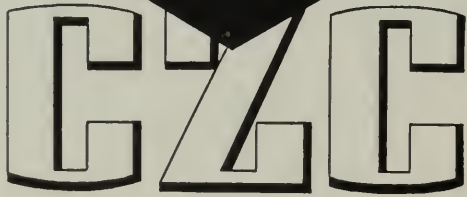
PRESSURE TREATED LUMBER
● **PROTECTS AGAINST DECAY
AND TERMITE ATTACK**

*Specify it in your home
Available through Lumber Dealers*

LOS ANGELES 601 W. 5th Street Phone Mlchigan 6294	SAN FRANCISCO 333 Montgomery Street Phone DOuglas 3883
---	--

J. H. Baxter & Co.
AGENTS FOR WEST COAST WOOD PRESERVING CO. SEATTLE, WASH.

IN THE NEWS

MIDWEST POWER CONFERENCE

After a year's lapse due to the War, the Midwest Power Conference will again be held in Chicago during April under sponsorship of the Illinois Institute of Technology

Discussions will include: Industrial war plants, hydro power, feedwater treatment, heating and air-conditioning, fuels and combustion, industrial loads supply, diesel power, and electrical developments, according to Stanton E. Winston, conference chairman.

Engineering groups participating are the Chicago Section, AICHE; Chicago Section, AIEE; Chicago Section, AIME; Chicago Section, ASME; Illinois Section, ASCE; Illinois Chapter, ASH and VE; Western Society of Engineers; and Engineers' Society of Milwaukee.

PITTSBURGH PLATE GLASS EXPANDS

Voting stock of the M. B. Suydam Company, paint and varnish manufacturers, has been acquired by the Pittsburgh Plate Glass Company.

R. S. Suydam, president, and associates will continue in their capacities.

The firm established in Pittsburg's northside district in 1832 and has a daily capacity of approximately 20,000 gallons of paints and varnishes.

CALIFORNIA EMPLOYMENT STUDY

Acting on a recommendation of the State Reconstruction & Reemployment Commission, Earl Warren, governor, recently appointed a Citizens' Advisory Committee on Production and Employment Estimate, to make a study of California employment and labor relations.

Appointed to the committee were: Stephen D. Bechtel, president, W. A. Bechtel Co., San Francisco; C. J. Haggerty, secretary California State Federation of Labor; Donald M. Nelson, president Society of Independent Motion Picture Producers, Hollywood; Mervyn Rathbone, California CIO Council; and Harry Woodhead, president Consolidated Vultee Aircraft Corporation.

BUILDING MATERIAL SUPPLIES

"Despite reconversion problems, manufacturers of most building products needed for the construction of new homes, factories, hospitals, schools, and other structures report that production has reached the 1940 rate," James W. Follin, managing director of the Producers' Council, reported.

Most shortages will be overcome by April 1, 1946, when it is expected new construction will get under way on a large scale.

DATED HOMES . . .

The degree to which homes are truly modern is measured by the convenient, satisfactory operation of their electrical facilities.

A home may be comparatively new, but it will be "dated" old-fashioned if it lacks plenty of convenience outlets, plenty of light switches properly located, and wires sufficiently large to supply all the appliances that will be used during the life of the house.

Adequate wiring costs so little and means so much to the future comfort of your clients . . . as well as to the resale or rental value of the house itself.

Don't date homes of the future by handicapping them with wiring of the past. Insist on completely Adequate Wiring in every home you plan.

NORTHERN CALIFORNIA ELECTRICAL BUREAU

1355 MARKET STREET
San Francisco 3, California

"GOODS OF THE WOODS"



E. K. WOOD LUMBER COMPANY

LOS ANGELES
SAN FRANCISCO
OAKLAND

WE MANUFACTURE OR SUPPLY

DOUGLAS FIR
REDWOOD
SUGAR PINE
PONDEROSA PINE
SASH AND DOORS
MILLWORK
MASONITE TEMPERED PLYWOOD
CONCRETE FORM PANELS
CEMENT ASBESTOS BOARD
INSULATION AND
INSULATION BOARD
INSULATION TILE AND PLANK
PLASTER BOARD
FIR-TEX INSULATION PRODUCTS
TRIPLE-SEALED GYPLAP
SISALKRAFT BUILDING PAPER
ROOFING
WOODLIFE WATER REPELLANT
BUILDERS HARDWARE

DEPENDABLE QUALITY

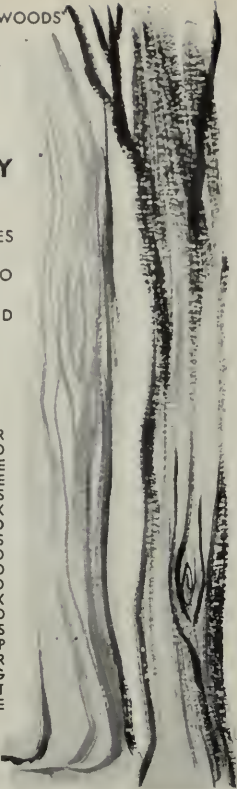

*Be sure you're getting the
finest window glass obtainable*

it costs no more to specify

PENNUERNON

Distributed by...

W · P · FULLER & CO.
PAINTS • GLASS • WALLPAPER

it's **Pennuernon**
FLATTER
flat drawn
CLEARER
WINDOW GLASS
BRIGHTER

FHA COUNTRY HOME FUNDS

Expanding its facilities the Federal Housing Administration has notified more than 13,000 banks, savings and loan associations, and other approved lending institutions that the FHA stands ready to insure financing of low priced homes located on small plots of land adjacent to the suburban areas surrounding cities.

The FHA proposes, insofar as is practicable and in keeping with the mandates of the National Housing Act, to broaden its operations in order to assist private enterprise to more nearly meet the total housing needs of the nation.

SOUTHERN CALIFORNIA CONSTRUCTION INDUSTRIES EXPOSITION COMING

The first annual Southern California Construction Industries Exposition and Home Show, sponsored by building trade associations and the Los Angeles Chamber of Commerce, has been set for July 12 to 21, inclusive.

New developments in postwar materials, designs, and processes in commercial, industrial, and public building will be emphasized.

Organizations participating in the Exposition include: Associated General Contractors of America, Southern California Chapter; Building Contractors Association of California Inc.; Contracting Plasterers Association; Heating, Pipe & Air Conditioning Contractors Association; Mason Contractors Exchange of Southern California; Merchant Plumbers Association of Los Angeles; National Association of Home Builders of the United States, Southern California Chapter; Painting and Decorating Contractors Association; Refrigeration Contractors Association; Sheet Metal Contractors Association; National Electrical Contractors Association, Los Angeles Chapter.

QUONSETS AVAILABLE

The U. S. Navy's "Quonsets" have become a civilian commodity, according to an announcement by the GREAT LAKES STEEL CORPORATION, who built 154,000 of the structures during World War II.

Of arch ribbed, Stran-Steel framework, to which sheet metal is nailed, the framework is assembled with bolts and screws, and will serve a wide variety of industrial, farm, and aviation purposes.

Sizes range from 20 by 20 by 48 feet to 40 by 40 by 100 feet, while prices have been set at from \$900 to \$3000.

M. V. PREGNOFF is instructor in Structural Engineering to a group of young architects who are preparing to take their examination to practice the profession of architecture in California.

IN THE NEWS

APPOINTED

Ben W. Creim, AIEE, was recently appointed manager of the U. S. Bureau of Reclamation's Regional Power Bureau, with headquarters in Sacramento, Calif.

Creim was formerly connected with the Modesto Irrigation District, the City of Tulare, the Bonneville Power Administration, and has just completed three years as Administrative Officer for the Navy Supervisor of Shipbuilding at Portland, Oregon.

PORTABLE GREASE UNIT

A new development in the lubrication field which totally eliminates the necessity for hand greasing operations is the portable greasing unit manufactured by PRESSURELUBE INC., 609 West 134th Street, New York City 21, N. Y.



It meets effectively every lubricating requirement, simplifies the grease job and reduces maintenance costs and is available with battery powered or gasoline driven motor.

The unit delivers up to 12,000 pounds steady, consistent pressure, and provides "on the spot" lubrication for trucks, trailers, tractors, steam shovels, airplanes, and rolling stock of all types without necessity of removing load.

RADAR

The armed services have trained more than 500,000 radar and radio technicians, operators and repairmen.



Available with or without hanger. Uses four 40 W. fluorescent lamps.

PLASCOLIER

A new shielded luminaire that is now in production by Smoot-Holman. Extremely efficient, combining minimum surface brightness, maximum diffusion, low absorption. Lightweight plastic diffuser is safe to handle, no breakage hazards. Write for Catalog Supplement No. 22.



Offices in Principal Western Cities—Branch and Warehouse in San Francisco

PRODUCERS' COUNCIL PAGE

Northern California Chapter

The National Organization of Manufacturers of Quality Building Materials and Equipment

Affiliated with the AMERICAN INSTITUTE OF ARCHITECTS



V. F. "Vic" Anderson

A year ago when we were doing a series on Past-Presidents of the Chapter who were still with us, we passed up the name of V. F. Anderson because "Vic" had been transferred by his Company, The Otis Elevator people, to their Los Angeles Office. But happily for all of us, Vic has returned to

claim his due. He is once again in the San Francisco office and a member of our Chapter. Vic's tour of duty as President of this organization occurred in 1940, following years of service to the Chapter in various capacities.

Vic started life in Duluth, Minnesota, so he cannot be blamed for going to extremes at first and migrating to Arizona and Southern California. After having engaged in civil engineering there for a number of years, he joined the Otis Elevator Co. in 1919, and he's been identified with that organization since as Construction Manager, Sales Representative, District Manager at Los Angeles, and presently as Sales Engineer of the San Francisco Zone, which comprises eight Western States.

Vic is so glad to be back he lives right smack on top of one of San Francisco's famed hills. He is married, enjoys most spectator sports, is very fond of music and, he says, "some what" addicted to the collection of a record library.

Another Jinks passed into history. More elaborate than wartime affairs, the Lake Merced party continued the tradition of fun and fellowship that has made it a red-letter day on the Architects' and Engineers' calendar.

Austin Sperry from Crane Co. after a busy lifetime of business and civic activity. Thirty seven of his forty one years of work were spent with

the Crane Co. in which organization he rose to Assistant Manager of the San Francisco Branch. Austin served the Chapter as Chairman of the Publicity Committee in 1940. Good luck Austin and happy days ahead on the vacation you so richly deserve.

We are sorry to take note here, belatedly, of the news that has just come to Chapter headquarters about the death of Fred Scott of National Lead Co. Loss of a son in World War II proved a severe shock to Fred.

We have not seen so much of Fred since his Company dropped out of the Council a year ago. He was one of our original members, had a deep love for the Chapter and regard for its purposes, and served as its President in 1936.

So Realistic as well as interesting have been the figures developed by the Producers' Council, Inc., in the availability of building materials, that the Chapter has been called upon to present them at hearings held in the Office of the State Architect in Sacramento and the Reconstruction and Reemployment Commission in San Francisco, also before a meeting of the San Francisco Planning and Housing Association, as well as the All-Day Building Industry Conference in San Francisco.

In Response to further requests for this information, Jim Follin's report to the OWMR on the situation was made available to the A.I.A. in the fourth year of our Producers' Council "Page." During the past three years through this "Page" we have become better acquainted with 35

Northern California Chapter who have reprinted it en toto in their November-December Bulletin.

Modular Moments

Question: Is the Architect compelled to use grid paper to use modular products?

Mr. Lorimer: No. Modular products are designed for easy assembly with other modular products to produce an integrated structure. The grid is



USE QUALITY PRODUCTS CONSULT AN ARCHITECT



a great convenience in so doing. However, these products can be used in exactly the same way that bricks, windows and equipment have always been assembled in conventional working drawings, and while the full benefit may not accrue therefrom, the project will certainly be no worse and properly much better in regard to elimination of cutting and fitting.

No. 4 Coming Up. February marks the first issue of our active members and a very active Architect, John Bolles.

Looking back over the last three years leads us to hazard the comment that "we ain't seen nothing yet," to compare, from the construction point of view, to the developments ahead in the next three years . . . for a starter.

IN THE NEWS

HOME ELECTRIC HEATING

The Westinghouse Electric Corporation, Emeryville, California, has acquired from the Wesix Electric Heater Company of San Francisco, the right to use certain basic principles involved in the design, construction and control of the unit type electric heater, and will engage in the manufacture of electric equipment for home heating.

Models will range from portable 1250 watt, 110-volt floor units to 4-kilowatt, 220-volt floor and wall models with built-in automatic thermostatic control.

Stuart L. Forsyth, formerly of Pittsburgh, will head the new activity as sales manager for the new "home heating section" of Westinghouse.

INDUSTRIAL DESIGNERS

James H. Blauvelt, widely known in the design and decorating industry, has been appointed Director of Client Relations for J. Gordon Lippincott & Company, New York City.

During the war Blauvelt served as consulting decorator for the Office of Civilian Defense in Washington, and prior to that headed his own design firm.

Manufacturers of plumbing and heating equipment, cast iron radiators, common brick, and cast iron soil pipe, will be materially aided in speeding up reconversion to peacetime production by a five-point program recently announced by the Smaller War Plants Corporation. Loans, engineering advice, technical advisory assistance, assistance in obtaining government owned tools and equipment, and help in obtaining manufacturing materials are included in the program.

BASALITE

LIGHTWEIGHT CONCRETE
BUILDING UNITS

CHARACTER • ECONOMY • INSULATION
FIRE-SAFE • TERMITE PROOF • PERMANENCE

BASALT ROCK CO., INC.
NAPA, CALIFORNIA

FORDERER CORNICE WORKS

Manufacturers of

Hollow Metal Products • Interior Metal Trim
Elevator Fronts and Cabs
Metal Plaster Accessories • Sanitary Metal Base
Flat and Roll Metal Screens
Metal Cabinets • Commercial Refrigerators

269 POTRERO AVE.

SAN FRANCISCO, CALIF.

HEMLOCK 4100

STRUCTURAL STEEL

For Class A Buildings,
Bridges, etc.

JUDSON PACIFIC - MURPHY CORP.

1200 SEVENTEENTH STREET
SAN FRANCISCO

Plants: San Francisco - Oakland

SISALKRAFT

REG. U. S. PAT. OFF.

"More than a building paper"

THE SISALKRAFT CO.

205 West Wacker Drive
Chicago, Ill.

55 New Montgomery Street
San Francisco, Calif.

GOOD INTERIOR LIGHTING

(From Page 5)

paying for seeing that must be accurate enough to increase production, reduce spoilage and decrease accidents. Merchants, too, discovered that seeing in stores attracted customers to merchandise and made it possible for them accurately to appraise color and quality of workmanship at the point and time of sale. From the fundamentals of science of seeing, office and drafting room men learned that efficient seeing is a necessity for many difficult and sustained seeing tasks and educators learned that better seeing meant better learning.

Out of this development came the growth of a whole new group of lighting tools and techniques, better and more efficient light sources, better design data and a wide range of new lighting equipment. Within the later years of the era of light to see by, both ends of the visible spectrum were opened wide and the laboratory fields of ultra-violet and infra-red were invaded by the practical engineers. They developed lamps with high efficiencies in white, daylight and colors and soon there were commercial lamps which could produce infra-red for heating purposes, and other sources operating in three bands of the ultra-violet spectrum. Out of these came a lamp designed to kill air-borne bacteria and germs, a second to duplicate sunlight and a third to produce fluorescent effects from many organic and inorganic substances. Under the impetus of war research the era of light to see by produced an even wider range of light sources. Lighting men began to employ 1000-watt lamps the size of a cigarette, they knew how to produce 1000-foot-candles or more for plant production, knew how to attain acceptable low brightness for blackout. They had design data, efficient reflector equipment and the installation experience with all of these sources. A science of seeing helped the lighting fraternity to join hands with the advance-thinking of the architect and both are now ready for a new lighting era—the era of light with which to live.

Thus the third evolutionary step in lighting brings us to new drama, new beauty, new usefulness in light to live with. Lighting is ready to fit in with the future promises of prefabrication, plastic automobiles, chemical fabrics, rubberless tires.

Undeniably, the trend is toward lighting with all the plus values of beauty and comfort as well as efficiency. And the lighting-styled-to-decoration theme is simply a projection of this trend. As always, there is still need for lighting to expand in its utilitarian value and fitness in order that it

(See Page 44)

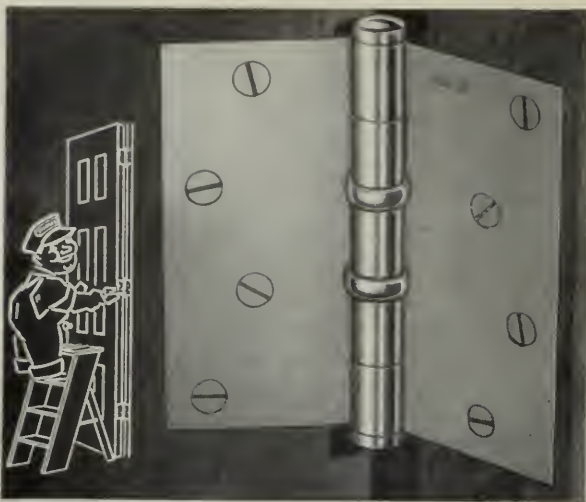

Again.. Three Hinges to a door

Postwar building calls for "three hinges to a door" — to prevent warping and to assure a permanently true-hung door. Specify Stanley Hardware for appearance, endurance and owner satisfaction.

STANLEY

THE STANLEY WORKS, NEW BRITAIN, CONNECTICUT

VALUABLE NEWS SERVICE

Building material dealers, contractors, engineers, and financial institutions find ARCHITECT'S REPORTS highly valuable in the operation of their business.

ISSUED DAILY at a total cost of \$10 per month these handy, individual slip-reports give ADVANCE news on construction projects in Northern California . . . listing name of project, location, architect, proposed cost and other pertinent information.

DON'T DELAY! SUBSCRIBE TODAY!

ARCHITECT'S REPORTS

Published Daily by

ARCHITECT and ENGINEER, Inc.

68 Post Street, San Francisco

EXbrook 7182

ESTIMATOR'S GUIDE

BUILDING AND CONSTRUCTION MATERIALS

PRICES GIVEN ARE FIGURING PRICES AND ARE MADE UP FROM AVERAGE QUOTATIONS FURNISHED BY MATERIAL HOUSES TO SAN FRANCISCO CONTRACTORS. 2½% SALES TAX ON ALL MATERIALS BUT NOT LABOR

All prices and wages quoted are for San Francisco and the Bay District. There may be slight fluctuation of prices in the interior and southern part of the state. Freight cartage, at least, must be added in figuring country work.

BONDS—Performance—\$10 per \$1000 of contract. Labor and materials, \$10 per \$1000 of contract.

BRICKWORK—

- Common Brick—Per 1M laid—\$50.00 to \$60.00 (according to class of work).
- Face Brick—Per 1M laid—\$120 to \$150 (according to class of work.)
- Brick Steps—\$1.60 per lin. ft.
- Brick Veneer on Frame Bldg.—Approx. \$1.30 per sq. ft.
- Common Brick—\$19.00 per M, truckload lots, f.o.b. job.
\$19.00 per M, less than truckload, plus cartage.
- Face Brick—\$40 to \$80 per M, truckload lots, delivered.
- Cartage—Approx. \$4.00 per M.

BUILDING PAPER—

- 1 ply per 1000 ft. roll.....\$3.50
- 2 ply per 1000 ft. roll.....5.00
- 3 ply per 1000 ft. roll.....6.25
- Brownskin, Standard, 500 ft. roll.....5.00
- Siskreft, 500 ft. roll.....5.00
- Sesh cord com. No. 7.....\$1.20 per 100 ft.
- Sash cord com. No. 8.....1.50 per 100 ft.
- Sesh cord spot No. 7.....1.90 per 100 ft.
- Sash cord spot No. 8.....2.25 per 100 ft.
- Sesh weights, cast iron, \$50.00 ton.
- Neils, \$3.42 base.
- Sesh weights, \$45.00 per ton.

CONCRETE AGGREGATES—

- The following prices net to Contractors unless otherwise shown.
- Gravel, all sizes**—
\$1.95 per ton at Bunker; delivered.....\$2.50
- | | | |
|-----------------------------|--------|--------|
| | Bunker | Del'd |
| Top Sand..... | \$1.90 | \$2.50 |
| Concrete Mix..... | 1.90 | 2.45 |
| Crushed Rock, ¼" to ¾"..... | 1.90 | 2.50 |

- Crushed Rock, ¾" to 1½"..... 1.90 2.50
- Roofing Gravel..... 2.25 2.80
- River Sand..... 2.00 2.45

Sand—

- River Sand..... 2.00 2.45
- Lapis (Nos. 2 & 4)..... 2.85 3.15
- Olympia (Nos. 1 & 2)..... 2.85 3.10
- Del Monte White......84c per sack

Cement—

- Common (all brands, paper sacks), carload lots, \$2.42 per bbl. f.o.b. car; delivered \$2.72.
- Cash discount on carload lots, 10c a bbl., 10th Prox.; less than carload lots \$3.20 per bbl. f.o.b. warehouse or delivered.
- Cash discount 2% on L.C.L.

- Atlas White } 1 to 100 sacks, \$2.50 sack
- Calaveras White } warehouse or del.; \$7.65
- Medusa White } bbl. carload lots.

Forms labor average \$350 per 1000 sq. feet.
Average cost of concrete in place, 50c per cubic foot, exclusive of forms; \$15.00 per cubic yard. With forms \$1.60 per cubic foot.

DAMP-PROOFING and Waterproofing—

- Two-coat work, \$3.50 per square.
- Membrane waterproofing—4 layers of saturated felt, \$7.00 per square.
- Hot coating work, \$2.50 per square.
- Medusa Waterproofing, \$3.50 per lb. San Francisco Warehouse.
- Tricocel waterproofing.
(See representative.)

ELECTRIC WIRING—\$12 to \$15 per outlet

for conduit work (including switches).
Knob and tube average \$3.00 per outlet.
(Available only for priority work.)

ELEVATORS—

Prices vary according to capacity, speed and type. Consult elevator companies. Average cost of installing a slow speed automatic passenger elevator in small four story apartment building, including entrance doors, about \$6500.00.

EXCAVATION—

Sand, 60 cents; clay or shale \$1 per yard.

Trucks, \$20 to \$32 per day.

Above figures are an average without water. Steam shovel work in large quantities, less; hard material, such as rock, will run considerably more.

FIRE ESCAPES—

Ten-foot galvanized iron balcony, with stairs, \$150 installed on new buildings; \$160 on old buildings.

FLOORS—

- Composition Floors, such as Magnesite, 50c per square foot.
- Linoflor—2 gages—\$1.25 to \$2.75 per sq. yd.
- Mastopave—90c to \$1.50 per sq. yd.
- Battleship Linoleum—available to Army and Navy only—1/8"—\$1.75 sq. yd.
3/8"—\$2.00 sq. yd.
- Terazzo Floors—50c to 70c per sq. ft.
- Terazzo Steps—\$1.75 per lin. ft.
- Mastic Wear Coat—according to type—20c to 35c.
- Hardwood Flooring—
Standard Mill grades not available.
Victory Oak—T & G
3/4" x 2 1/4".....\$143.25 per M. plus Cartage
1/2" x 2".....122.00 per M. plus Cartage
1/2" x 1 1/2".....113.50 per M. plus Cartage
Prefinished Standard & Better Oak Flooring
3/4" x 3 1/4".....\$180.00 per M. plus Cartage
1/2" x 2 1/2".....160.50 per M. plus Cartage
Maple Flooring
3/4" T & G Clear \$160.50 per M. plus Ctg.
2nd 153.50 per M. plus Ctg.
3rd 131.25 per M. plus Ctg.
Floor Layers' Wage, \$1.50 per hr.

GLASS—

- Single Strength Window Glass.....20c per □ ft
- Double Strength Window Glass.....30c per □ ft.
- Plate Glass, under 75 sq. ft.....\$1.00 per □ ft.
- Polished Wire Plate Glass.....1.40 per □ ft.
- Rgh. Wire Glass......34 per □ ft.
- Obscure Glass......27 per □ ft.
- Glazing of above is additional.
- Glass Blocks.....\$2.50 per □ ft. set in place

HEATING—

- Average, \$1.90 per sq. ft. of radiation, according to conditions.
- Warm air (gravity) average \$48 per register.
- Forced air, average \$68 per register.

IRON—Cost of ornamental iron, cast iron, etc., depends on design.

LUMBER—All lumber at O.P.A. ceiling prices—

No. 1 Common	\$49.00 per M
No. 2 Common	47.75 per M
Select O. P. Common	52.75 per M

Flooring—

Delvd.

V.G.-D.F. B & Btr. 1 x 4 T & G Flooring	\$80.00
C 1 x 4 T & G Flooring	75.00
D 1 x 4 T & G Flooring	65.00
D.F.-5.G. B & Btr. 1 x 4 T & G Flooring	61.00
C 1 x 4 T & G Flooring	59.00
D 1 x 4 T & G Flooring	54.00
Rwd. Plastic—"A" grade, medium dry	82.00
"B" grade, medium dry	78.50

Plywood—not available

Under \$200 Over \$200

"Plycord"— $\frac{3}{8}$ "	\$49.50	\$47.55
"Plywall"— $\frac{1}{4}$ "	45.15	43.30
3 ply— $2\frac{1}{4}$ — $\frac{1}{4}$ "	48.55	46.60
"Plyform"— $\frac{5}{8}$ "		
Unoiled	126.50	121.45
Oiled	127.90	122.75

Above prices delivered if quantity is sufficient to warrant delivery.

Shingles (Rwd. not available)—

Red Cedar No. 1—\$6.75 per square; No. 2, \$5.75; No. 3, \$4.45.

Average cost to lay shingles, \$3.00 per square.

Cedar Shakes—Tapered: $\frac{1}{2}$ " to $\frac{3}{4}$ " x 25"—\$8.95 per square.
Resawn: $\frac{3}{4}$ " to $1\frac{1}{4}$ " x 25"—\$10.65 per square.
Resawn: $\frac{3}{4}$ " to $1\frac{1}{4}$ " x 25"—\$10.65 per square.
Average cost to lay shakes, \$4.00 per square.

MILLWORK—Standard.

D. F. \$100 per 1000. R. W. Rustic \$100.00 per 1000 (delivered).

Double hung box window frames, average with trim \$6.50 and up, each.

Complete door unit, \$10.00.

Screen doors, \$3.50 each.

Patent screen windows, 25c a sq. ft.

Cases for kitchen pantries seven ft. high, per lineal ft., \$9.00 each.

Dining room cases, \$9.00 per lineal foot.

Rough and finish about 80c per sq. ft.

Labor—Rough carpentry, warehouse heavy framing (average), \$40.00 per M.

For smaller work average, \$40.00 to \$55.00 per 1000.

MARBLE—(See Dealers)

PAINTING—

Two-coat workper yard 50c

Three-coat workper yard 70c

Cold water painting.....per yard 10c

Whitewashingper yard 8c

PAINTS—

Two-coat work50c per sq. yd.

Three-coat work70c per sq. yd.

Cold water painting.....per yard 10c

Whitewashing 8c per sq. yd.

Turpentine \$1.03 per gal. in drum lots.

\$1.08 per gal. in 5-gal. containers.

Raw Linseed Oil—not available.

Boiled Linseed Oil—\$1.38 per gal. in drums. Available only to work with high priority—\$1.48 per gal. in 5-gal. containers.

Use replacement oil—\$1.86 per gal. in 1-gal. containers.

Replacement Oil—\$1.20 per gal. in drums. \$1.30 per gal. in 5-gal. containers.

A deposit of \$6.00 required on all drums.

PATENT CHIMNEYS—

6-inch\$1.20 lineal foot

8-inch 1.40 lineal foot

10-inch 2.15 lineal foot

12-inch 2.75 lineal foot

PLASTER—

Neat wall, per ton delivered in S. F. in paper bags, \$17.60.

PLASTERING (Interior)—

3 Coats, metal lath and plaster..... Yard 1.50

Keene cement on metal lath..... 1.80

Ceilings with $\frac{3}{4}$ hot roll channels metal lath (lathed only)..... 1.20

Ceilings with $\frac{3}{4}$ hot roll channels metal lath plastered 2.20

Single partition $\frac{3}{4}$ channel lath 1 side (lath only) 1.20

Single partition $\frac{3}{4}$ channel lath 2 inches thick plastered 3.20

4-inch double partition $\frac{3}{4}$ channel lath 2 sides (lath only)..... 2.20

4-inch double partition $\frac{3}{4}$ channel lath 2 sides plastered 3.85

Thermax single partition; 1" channels; $2\frac{1}{4}$ " overall partition width. Plastered both sides 3.30

Thermax double partition; 1" channels; $4\frac{3}{4}$ " overall partition width. Plastered both sides 4.40

3 coats over 1" Thermax nailed to one side wood studs or joists..... 1.65

3 coats over 1" Thermax suspended to one side wood studs with spring sound isolation clip 1.90

Note—Channel lath controlled by limitation orders.

PLASTERING (Exterior)—

2 coats cement finish, brick or concrete well Yard 1.00

3 coats cement finish, No. 18 gauge wire mesh 2.00

Lime—\$3.00 per bbl. at yard.

Processed Lime—\$3.10 bbl. at yard.

Rock or Grip Lath— $\frac{3}{8}$ "—20c per sq. yd.

$\frac{1}{2}$ "—19c per sq. yd.

Composition Stucco—\$1.80 to \$2.00 sq. yard (applied).

PLUMBING—

From \$100.00 per fixture up, according to grade, quantity and runs.

ROOFING—

"Standard" tar and gravel, 4 ply—\$8.00 per sq. for 30 sqs. or over.

Less than 30 sqs. \$9.50 per sq.

Tile, \$30.00 to \$40.00 per square.

Redwood Shingles, \$7.50 per square in place.

5/2 # 1-16" Cedar Shingles, $4\frac{1}{2}$ " Exposure\$8.00 square

5/8 x 16"—#1 Cedar Shingles, 5" Exposure\$9.00 square

4/2 # 1-24" Royal Shingles, $7\frac{1}{2}$ " Exposure\$9.50 square

Re-coat with Gravel \$4.00 per sq.

Asbestos Shingles, \$23 to \$28 per sq. laid.

1/2 x 25" Resawn Cedar Shakes, 10" Exposure\$10.50

3/4 x 25" Resawn Cedar Shakes, 10" Exposure 11.50

1 x 25" Resawn Cedar Shakes, 10" Exposure 12.50

Above prices are for shakes in place.

SHEET METAL—

Windows—Metal, \$1.75 a sq. ft.

Fire doors (average), including hardware \$2.00 per sq. ft.

SKYLIGHTS—(not glazed)

Copper, 90c sq. ft. (flat).

Galvanized iron, 40c sq. ft. (flat).

Vented hip skylights 60c sq. ft.

STEEL—STRUCTURAL—

\$150 ton (erected), this quotation is an average for comparatively small quantities. Light truss work higher. Plain beams and column work in large quantities \$140 per ton.

STEEL REINFORCING—

\$100 to \$130 ton, set.

STONE—

Granite, average, \$6.50 cu. foot in place.

Sandstone, average Blue, \$4.00. Boise, \$3.00 sq. ft. in place.

Indiana Limestone, \$2.80 per sq. ft. in place.

STORE FRONTS (None available).

TILE—

Ceramic Tile Floors—\$1.00 to \$1.25 per sq. ft.

Cove Base—\$1.10 per lin. ft.

Glazed Tile Wainscot—\$1.25 per sq. ft.

Asphalt Tile Floor $\frac{1}{8}$ " & $\frac{3}{8}$ "—\$.18 to \$.35 per sq. ft. Light shades slightly higher.

Cork Tile—\$.40 to \$.75 per sq. ft.

Mosaic Floors—see dealers.

Lino-Tile, \$.35 to \$.75 per sq. ft.

Wall Tile—

Glazed Terra Cotta Wall Units (single faced) laid in place—approximate prices:

2 x 6 x 12.....\$1.10 sq. ft.

4 x 6 x 12..... 1.25 sq. ft.

2 x 8 x 16..... 1.20 sq. ft.

4 x 8 x 16..... 1.40 sq. ft.

VENETIAN BLINDS—

40c per square foot and up. Installation extra.

WINDOWS—STEEL—

30c per square foot, \$5 for ventilators.

IN THE NEWS

TUFFY—New Tool

A handy new tool for auto mechanics, maintenance men, assembly line workers, engineers, plumbers, carpenters, and ma-

chinists is being marketed by the SWALLOW AIRPLANE CO., of Wichita, Kansas, under the name "TUFFY."



It is a triple-purpose screw driver tool with a "power-arm" arrangement that gives extra power for unlocking rusted screws, or may be used as an ordinary screw-driver by folding the "power arm" into the handle.

TUFFY is made in 5, 6, and 8-inch lengths.

MR. ALBERT WILSON is now appearing on KPO at 8:45 a.m. on a new program, "How Does Your Garden Grow?"

JOHN D. McLAUGHLIN

Electrical Engineer Consultant
 Electrical Designs
 Plans - Specifications
 Industrial Power and
 Lighting Layouts
 Airport Lighting Design
 Distribution Design
 SERVICES FOR
 ARCHITECTS AND ENGINEERS
 1641 Russ Building
 San Francisco, California
 Telephone EXbrook 5712

Swimming Pools of Distinction

Built by technicians with specialized pool construction experience.

Landon Standard Pools

A Northern California Enterprise.

(We have the Background, the Men and the Material)

Telephone 425 Old County Road
 Belmont 2312 Belmont, Calif.

1945 BUILDING TRADES WAGE SCALES (JOB SITES) NORTHERN CALIFORNIA

Six- and seven-hour day eliminated on all Government Work. A. F. L. - O. P. M. Agreement calls for eight-hour day.

NOTE: Predeterminations by the Department of Labor, as of July 1, 1944 (the wage-freezing date) have not yet been made in all of the counties listed. The wage scales shown are those being paid and in effect mostly by agreement between employees and their union.

CRAFT	San Francisco	Alameda and Contra Costa	Fresno	Marin	Sacramento	San Jose	San Mateo	Vallejo	Stockton
ASBESTOS WORKERS	1.50	1.50	1.25	1.50	1.50	1.25	1.50	1.50	1.25
BRICKLAYERS	1.87 1/2	1.87 1/2	1.75	1.87 1/2	1.75	2.00	1.79-1/8	1.75	1.50
BRICKLAYERS, HODCARRIERS	1.40	1.40	1.05	1.40	1.05	1.50	1.35	1.50	1.14
CARPENTERS	1.50	1.50	1.25	1.43 3/4	1.37 1/2	1.37 1/2	1.43 3/4	1.50	1.37 1/2
CEMENT FINISHERS	1.50	1.50	1.50	1.50	1.50	1.50	1.50	1.50	1.50
ELECTRICIANS	1.70	1.70	1.70	1.70	1.70	1.70	1.70	1.70	1.70
ELEVATOR CONSTRUCTORS	1.75 1/2	1.75 1/2	1.75 1/2	1.75 1/2	1.75 1/2	1.75 1/2	1.75 1/2	1.75 1/2	1.75 1/2
ENGINEERS: MATERIAL HOIST	1.50	1.50	1.25	1.50	1.37 1/2	1.42 1/2	1.50	1.37 1/2	1.25
PILE DRIVER	1.75	1.75	1.40	1.75	1.75	1.75	1.75	1.75	1.75
STRUCTURAL STEEL	1.75	1.75	1.40	1.75	1.75	1.75	1.75	1.75	1.60
GLASS WORKERS	1.40	1.40	1.12 1/2	1.40	1.12 1/2	1.21	1.40	1.40	1.40
IRONWORKERS: ORNAMENTAL	1.60	1.50	1.60	1.50	1.60	1.31 1/4	1.50	1.50	1.50
REINF. RODMEN	1.50	1.50	1.60	1.50	1.50	1.60	1.50	1.50	1.25
STRUCTURAL	1.75	1.75	1.75	1.75	1.75	1.75	1.75	1.75	1.37 1/2
LABORERS: BUILDING	1.00	1.00	.90	.87 1/2	.95	.90	.93 3/4	.90	.90
CONCRETE	1.00	1.00	.90	.87 1/2	.95	.90	.93 3/4	.95	1.00
LATHERS	1.75	1.75	1.50	1.75	1.60	1.75	1.75	1.75	1.75
MARBLE SETTERS	1.50	1.50	1.50	1.50	1.50	1.50	1.50	1.50	1.50
MOSAIC & TERRAZZO	1.25	1.25	1.12 1/2	1.25	1.15-5/8	1.12 1/2	1.50	1.50	1.50
PAINTERS	1.50	1.50	1.28-4/7	1.50	1.43	1.50	1.42-6/7	1.64-2/7	1.37 1/2
PILEDRIVERS	1.54	1.54	1.54	1.54	1.54	1.54	1.54	1.54	1.54
PLASTERERS	1.75	1.83 1/2	1.75	1.75	1.75	2.00	2.00	1.75	1.83-1/3
PLASTERERS' HODCARRIERS	1.50	1.60	1.40	1.50	1.18 3/4	1.50	1.75	1.50	1.50
PLUMBERS	1.70	1.70	1.53-1/8	1.70	1.68 3/4	1.62 1/2	1.70	1.70	1.50
ROOFERS	1.50	1.50	1.25	1.37 1/2	1.37 1/2	1.37 1/2	1.25	1.37 1/2	1.37 1/2
SHEET METAL WORKERS	1.50	1.50	1.50	1.50	1.50	1.50	1.50	1.50	1.50
SPRINKLER FITTERS	1.58	1.58	1.53-1/8	1.70	1.68 3/4	1.62 1/2	1.70	1.70	1.50
STEAMFITTERS	1.75	1.75	1.53-1/8	1.70	1.68 3/4	1.62 1/2	1.50	1.70	1.50
STONESETTERS (MASONS)	1.87 1/2	1.87 1/2	1.50	1.75	1.75	1.50	1.75	1.75	1.50
TILESETTERS	1.50	1.50	1.37 1/2	1.50	1.37 1/2	1.50	1.50	1.50	1.37 1/2

Prepared and compiled by

CENTRAL CALIFORNIA CHAPTER, ASSOCIATED GENERAL CONTRACTORS OF AMERICA

with the assistance and cooperation of secretaries of General Contractors Associations and Builders Exchanges of Northern California.

CLASSIFIED ADVERTISING

RATE: 8c PER WORD . . . CASH WITH ORDER

MINIMUM \$1.50 (3 Lines)

ARCHITECT'S REPORTS—A valuable advance news service giving building and construction information daily on projects in Northern California. Name, location, architect, proposed cost, etc., on individual slips. Ideal for securing new business leads. Hundreds of items, total monthly cost only \$10. Don't delay, subscribe today. ARCHITECT & ENGINEER, Room 618, 68 Post Street, San Francisco, California. Phone DOUGLAS 8311.

ARCHITECTS—A. McF. McSweeney, Architect, Room 927 Hearst Bldg., San Francisco. New offices. Desires catalogs.

ARCHITECTURAL ENGINEER: Excellent educational, professional and business experience seeks partnership in a young, growing office. Now in military service but will be discharged in 30 days. Write c/o ARCHITECT AND ENGINEER.

PHOTOGRAPHY—Keep a pictorial record of your building, or construction project. Pictures are of tremendous value to contractors, builders, engineers, architects. For Industrial-Publicity-Aerial photography, see FRED MAE, Room 721-22 Hearst Bldg., San Francisco 3, California.

PRINTING—Printers, bookbinders. See us for commercial printing. Mercury Press, 942 Howard Street, San Francisco.

**CLINTON
CONSTRUCTION CO.
OF CALIFORNIA**

General Contractors

923 FOLSOM STREET • SAN FRANCISCO
SUtter 3440

MALOTT & PETERSON

**ROOFING AND FLOORING
CONTRACTORS**

20TH AND HARRISON STREETS
SAN FRANCISCO
Phone ATwater 1600

HOGAN LUMBER CO.

Wholesale and Retail

LUMBER

MILL WORK • SASH & DOORS

Office, Mill, Yard and Docks
SECOND AND ALICE STREETS • OAKLAND, CALIF.
Telephone GLencaurt 6861

**SANTA MARIA INN
SANTA MARIA, CALIFORNIA**

FRANK J. McCOY, General Manager
FERNAND E. PIMENTEL, Manager

*On the
Coast
Highway
between
San
Francisco
and
Los
Angeles*



*American
or
European
Plan
•
Old
English
Tap
Room*

GOOD INTERIOR LIGHTING

(From Page 40)

may continue to meet practical modern needs. There is no question that the design for illumination must incorporate these characteristics before it can be truly called "light to live with."

According to Clark Baker, Lighting Counsellor for the Northern California Electrical Bureau, and nationally known authority on sight conservation, there are several designing devices in use and in blue-print stage that will attain the goal of the new era in lighting. For the maximum variety of effects in the living room lighting, the use of built-in downlights over the lounge will provide shielded illumination for reading and close visual work. Contrast relief can be provided from a trough of fluorescent lamps behind the lounge to indirectly light the room from the ceiling above.

Mr. Baker maintains that dining room lighting can be practical and yet create atmosphere by supplementing the fluorescent units in a "pocket" over the windows, by using reflector lamps to illuminate the table and a spotlight for the table centerpiece.

Today, both architect and consumer are asking for light that does not require so large or so bulky suspended fixtures. Tomorrow, the package of light must be smaller, with better results attained by using few lamps with more lumens per foot, incorporated in fixtures of better design.

"In light to live with," says Mr. Baker, "the worker has a right to expect more **accurate** seeing, the consumer has a right to expect more **comfortable** seeing, and in homes as well as stores, restaurants, theaters and schools, the consumer has a right to expect more **pleasing environment** and **great utility**. More of the light sources, the lighting techniques and the lighting controls needed to accomplish these results are becoming available every day."

BETHLEHEM EXPANDS

H. H. Fuller, president of the Bethlehem Pacific Coast Steel Corporation, recently announced the acquisition of the Pacific Coast Forge Company of Seattle, Washington.

The Pacific Coast Forge Company will be continued in operation as a part of the Bethlehem Pacific Coast Steel Corporation, according to Mr. Fuller.

PARTNERSHIP FORMED

Announcement has been made of the formation of the partnership of DRAGON, SCHMIDTS & HARDMAN for the practice of architecture.

Paul L. Dragon, Carl R. Schmidts, and B. Reede Hardman comprise the new firm which have offices at 208 Allston Way, Berkeley, California.

BOOK REVIEWS

POINTERS FOR PUBLIC LIBRARY BUILDING PLANNERS. By Russell J. Schunk. Published by AMERICAN LIBRARY ASSOCIATION, Chicago, 1945. Price \$1.25.

The contents of this excellent small addition to the Bibliography on the subject of libraries should not be limited to public libraries. As a matter of fact there is much information in this small brochure that will be of value to an architect who is confronted with the problem of any library design, small or large. Many architects are not familiar with book sizes, weights, proper shelf dimensions, stack loads, lighting and other details that enter into the design of any library, even a small one in a private residence. Besides the octavo, quarto, and folio sizes there are many shapes that must be laid flat. What they weigh and what should be the shelf sizes is explained in the booklet.

The first part of the book is devoted to what might be considered as the promoter's angle, and while the architect should be familiar with such problems, that is true only when he is working on a public library, as the title suggests. But he should know that valuable information on the small or private library will be found in the book also.

M.D.

REVERSATEMP

Based upon the reversible cycle heat pump principle a new product to keep room temperatures at constant levels has been announced by DRAYER-HANSON, 738 E. Pico Blvd., Los Angeles 21, California.

Units are available in sizes suitable to small homes or large buildings. Complete data available from manufacturer.

INDUSTRIAL SAFETY TOMORROW

The National Safety Council has just issued a 16-page pamphlet devoted to reduction of accidents in American industry.

Sponsored by industrial management associations, labor unions, civic organizations, educational institutions and insurance associations the activity advocates a continuance of safety measures which held accidents to a minimum during the war.

Reemployment of service men and women may present minor and temporary problems and assistance in solving any situation may be obtained by the individual company or plant from numerous organizations now making a study of the problem.

PACIFIC MANUFACTURING CO.

HIGH CLASS INTERIOR FINISH
QUALITY MILLWORK
142 SANSOME ST., SAN FRANCISCO
GARfield 7755
6820 MCKINLEY AVE., LOS ANGELES
THornwall 4196
BUILDERS EXCHANGE, OAKLAND

"AMERICAN - MARSH" CONDENSATION UNIT

Pumping
Machinery
for
Every
Purpose

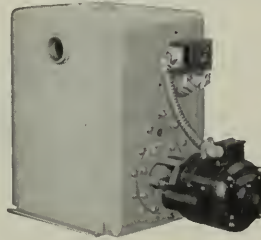

For Service
Call
DOuglas
6794
or
MUtual 8322

SIMONDS MACHINERY CO.
SAN FRANCISCO 816 FOLSOM
LOS ANGELES 455 EAST 4TH

VERMONT MARBLE COMPANY

Producers and Finishers
of
Domestic and Imported Marbles

Write for new pamphlet describing our
Marble Toilets and Showers

San Francisco and Los Angeles
San Francisco phone: SUTter 6747



The Most Complete Line of
STEELS and BUILDING MATERIALS
Made by a Single Producer



See Sweet's Catalog File or write us for
full information.

REPUBLIC STEEL CORPORATION
GENERAL OFFICES: CLEVELAND, OHIO
DENVER, COLORADO CONTINENTAL OIL BUILDING
LOS ANGELES, CALIFORNIA EDISON BUILDING
SALT LAKE CITY, UTAH WALKER BANK BUILDING
SAN FRANCISCO, CALIFORNIA RIALTO BUILDING
SEATTLE, WASH. WHITE-HENRY-STUART BUILDING

F.H.A. LOANS

TO BUY—
REMODEL—
REFINANCE



Long - term and low-cost F. H. A. loans are still available to finance the purchase of homes already built. Monthly payment F. H. A. loans for buying or refinancing homes are made by this bank for as much as 80% of the appraised value of the property with as long as 20 years to repay.

For further information call at our Real Estate Loan Department

**CROCKER FIRST
NATIONAL BANK**
OF SAN FRANCISCO
California's Oldest National Bank
ONE MONTGOMERY STREET
Member Federal Deposit Insurance Corporation

To bring out and preserve the beauty of Exterior Redwood in its natural color use

Cabots # 230 Clear

OR

to give it an old weathered driftwood grey use

**Cabots # 241
Bleaching Oil**

OR

to stain or actually dye it in a wide range of colors use

Cabots Creosote Stains

Distributed by

GUNN CARLE and CO.

20 POTRERO AVENUE
SAN FRANCISCO 3
Underhill 5480

IN THE NEWS

ASSISTANT DIRECTOR

Phil Dickinson, well-known California newspaperman and graduate civil engineer, has been named assistant regional director of the Bureau of Reclamation, with headquarters in Sacramento, California.

ALL PURPOSE PARVA-GRAPH

Accurately designed and mathematically calibrated to serve as a square, dividers, protractor, triangle, ruler, compass, french curve and mitre, a new all-pur-

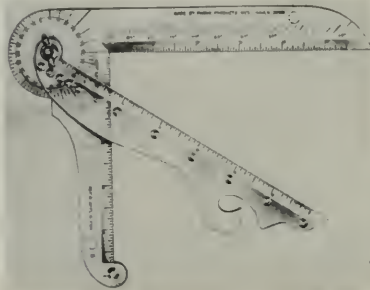

pose measuring device has been perfected by PARVA PRODUCTS COMPANY, West Haven, Connecticut.

It consists of a combination square and removable mitre, and is made of tough, transparent plastic. Designed for architects, artists, carpenters, draftsmen, engineers, mechanics and students.

ARC WELDING MANUAL

Containing many illustrations and a great amount of information, a 176-page book entitled "Lessons in Arc Welding" has just been reprinted by the LINCOLN ELECTRIC COMPANY of Cleveland, Ohio.

NAMED SALES MANAGER

William A. Damerel has been appointed sales manager of the SEAPORCEL PORCELAIN METALS Inc., Long Island, New York. He was formerly associated with the Maxim Silencer Company.

MODELS

- HOMES
- BUILDINGS
- FACTORIES
- ENGINEERING PROJECTS
- REALISTICALLY BUILT TO SCALE

EDWARD OWENS-ASSOCIATES
TECHNICAL MODEL BUILDERS
252 CLAY ST. DO. 2094 SAN FRANCISCO

KYLE FORREST

Civil Engineer

Water Supply — Sanitation

Municipal — Private
Consultations — Investigations
Reports — Designs — Valuations
Supervision — Litigation

Ground Water Work a Specialty

Hydrologic studies — wells, dewatering, underdrainage, foundations, conservation, testimony.

1504 Russ Building
San Francisco 4
YUkon 0652

Built-In Fixtures for the Post-War Home

Paramount Fixtures will fit your post-war needs . . . investigate our new kitchen ideas which make for convenience and efficiency.

Paramount Built-in Fixtures meet the most exacting requirements. Our "Deluxe," "Moderne" and "Economy" cabinet fixtures are distinctive in design and construction and may be had in stock sizes or built to order.

Catalog for the asking

Paramount
BUILT-IN FIXTURE COMPANY
5107 Broadway, Oakland, California
Phone Fledmont 8100

THE TORMEY COMPANY

GENERAL PAINTERS
AND DECORATORS

Phone UNderhill 1913

563 FULTON STREET
San Francisco

G. P. W. JENSEN & SON

Building Construction

320 Market Street, San Francisco
Phone: GARfield 2444

JOHN CASSARETTO COMPANY

—Since 1886—And Still Active—

Building Materials

READY MIX CONCRETE
ROCK - SAND - GRAVEL - LIME
CEMENT - PLASTER - MORTAR
METAL LATH - WOOD LATH
STUCCO - WIRE NETTING

Service Unexcelled

Bunkers
Sixth and Channel, San Francisco
Phones: GARfield 3758 - 3760

MULLEN MFG. COMPANY

BANK, STORE AND OFFICE
FIXTURES—CABINET WORK
OF GUARANTEED QUALITY
CHURCH SEATING

Office and Factory:
60-80 RAUSCH ST., Bet. 7th and 8th Sts.
San Francisco
Telephone UNDERhill 5815

IN THE NEWS

WAR HOUSING RE-USE

Possible re-uses of temporary housing units is being demonstrated in Washington, D. C., by the Federal Public Housing Authority and will continue until February 9th.

Units are to be sold to the public on competitive bid basis.

NEW MODEL AIRTOPIA

A single unit that gives constant year 'round temperature and humidity control together with air purification is announced by DRAYER & HANSON, Inc., 767 E. Pico Blvd., Los Angeles 21, Calif.



Especially suitable for homes, offices and small stores, AIRTOPIA was designed by Gilbert E. Clancy and is a modern application of the known principles of thermodynamics.

Units are available in various sizes, need no chimney, operates on electrical energy alone.

ELECTED DIRECTOR

Charles H. Westphalen has been elected vice president and director of the MASONITE CORPN., and will serve as general manager of the Laurel, Mississippi, plant.

Westphalen has been with the company since it was formed in 1926.



HERRICK IRON WORKS

STRUCTURAL STEEL
REINFORCING STEEL

18TH AND CAMPBELL STS.
OAKLAND, CALIF.
Phone GLencourt 1767

Phone GARfield 1164

Thomas B. Hunter

Consulting Engineer

DESIGNER OF HEATING
AIR CONDITIONING
VENTILATING AND WIRING
SYSTEMS, MECHANICAL
AND ELECTRICAL EQUIP-
MENT OF BUILDINGS

41 SUTTER STREET
ROOM 710

San Francisco California

ANDERSON & RINGROSE

General Contractors

320 Market Street, San Francisco
Phone GARfield 2245

DINWIDDIE CONSTRUCTION COMPANY

•
BUILDERS

•
CROCKER BUILDING
SAN FRANCISCO

A. F. MATTOCK CO.

Builders



212 CLARA STREET
SAN FRANCISCO

Independent Iron Works

Structural Steel
Ornamental Iron
Steel Service Stations
Steel Tanks
Standard Steel Mill Buildings
Bridges

821 Pine Street Oakland

George F. Brayer

ELECTRICAL
CONTRACTOR

166 Seventh Street
San Francisco

Phones: KLondike 2-0879
HEmlock 2646

SMITH, EMERY & CO.

Since 1904

Engineers - Chemists

Inspection, Tests, Analyses,
Research, Consultation
Structural Materials, Structures,
Equipment, Pipe, Soils

Associates

Los Angeles and Eastern Cities
Offices and Laboratories
651 Howard Street, San Francisco

Index to Advertisers

* Indicates Alternate Months

ALADDIN Heating Corp.	48	
ANDERSON, & Ringrose	47	
ANGIER Sales Corporation	30	
ARCHITECTS Reports	40	
BASALT Rock Company	39	
BAXTER & Company, J. H.	34	
BRAYER, George F.	48	
CASSERETTO, John	47	
CLARK, N., & Son	*	
CLASSIFIED ADVERTISING	43	
CLINTON Construction Company ..	44	
COLUMBIA Steel Co.	*	
COLOTYLE Corporation	*	
CROCKER First National Bank	46	
DINWIDDIE, Construction Company ..	47	
FORDERER, Cornice Works	39	
FORREST, Kyle	46	
FULLER, W. P., Co.	36	
GUNN, Carle & Company	46	
HANKS, Inc., Abbot A.	48	
HAWS Drinking Faucet Company	Back Cover	
HERRICK Iron Works	47	
HOGAN Lumber Company	44	
HUNT, Robert W., Company	48	
HUNTER, Thos. B.	47	
IMPERIAL Brass Manufacturing Co. ..	*	
INDEPENDENT Iron Works	48	
JENSEN & Son, G. P. W.	47	
JOHNSON, Company, S. T.	*	
JUDSON, Pacific-Murphy Corp.	39	
KRAFTILE Company	*	
KAWNEER Company	*	
LANDON Standard Products	43	
MALOTT & Peterson	44	
MATTOCK, A. F.	48	
McLAUGHLIN, John D.	43	
MULLEN Mfg. Co.	47	
MUELLER, Brass Co.	2	
NORTHERN California Electrical ..	Bureau	35
OWENS Corning Fiberglas Co.	*	
OWENS, Edward & Associates	46	
PACIFIC Coast Gas Association	*	
PACIFIC Manufacturing Company ..	45	
PACIFIC Portland Cement Company ..	1	
PACIFIC Telephone & Telegraph Co. ..	33	
PARAMOUNT Built-in Fixture Co.	46	
PARKER, STEFFINS & PEARCE	*	
PAYNE Furnace & Supply Co., Inc.	*	
PORTLAND Cement Association	Inside Back Cover	
REMILLARD-Dandini Co.	48	
REPUBLIC Steel Corporation	45	
SANTA Maria Inn	44	
SCOTT Co.	*	
SIMONDS Machinery Company	45	
SISALKRAFT Company	39	
SMITH, EMERY & CO.	48	
SMOOT-Holman Co.	37	
STANLEY Works, Inc., The	40	
SOULE Steel Co.	*	
TIMBER Engineering Co., Inc.	*	
TORMEY Company, The	47	
UTILITY Appliance Corp.	*	
U. S. STEEL	*	
VERMONT Marble Company	45	
WEST Electric Heater Co.	*	
WESTERN Asbestos Company	Inside Front Cover	
WOOD, E. K., Lumber Company	36	

Robert W. Hunt Company

ENGINEERS

Inspection - Tests - Consultation

Schools and Other Structures
Are Built as Designed

When Construction Materials are
Inspected at point of Manufacture
and during Erection by

ROBERT W. HUNT COMPANY

Cement, Concrete, Chemical, Metallurgical,
X-Ray and Physical Laboratories

Chicago - New York - Pittsburgh
Los Angeles - All Large Cities
San Francisco, 251 Kearny Street

REMILLARD-DANDINI Co.

Brick and
Masonry Products



633 BRYANT ST., SAN FRANCISCO
569 THIRD ST., OAKLAND

ALADDIN Heating Corp.

Specializing in
QUALITY HEATING
EQUIPMENT

2222 San Pablo Avenue
OAKLAND
TWInoaks 1022

ABBOT A. HANKS, INC. Engineers & Chemists

INSPECTING — TESTING — CONSULTING
CONCRETE • STEEL • MATERIALS
CHEMICAL AND TESTING
LABORATORIES
• RESEARCH AND INVESTIGATION •

TESTS OF STRUCTURAL MATERIALS
DESIGN OF CONCRETE MIXES
SHOP AND ERECTION INSPECTION OF
STRUCTURES AND EQUIPMENT
INVESTIGATION OF STRUCTURES
AND MATERIALS
TESTS AND INVESTIGATION OF
FOUNDATION SOILS
FIRE RESISTANCE AND INSULATION
TESTS

624 Sacramento Street, San Francisco

ARCHITECT AND ENGINEER

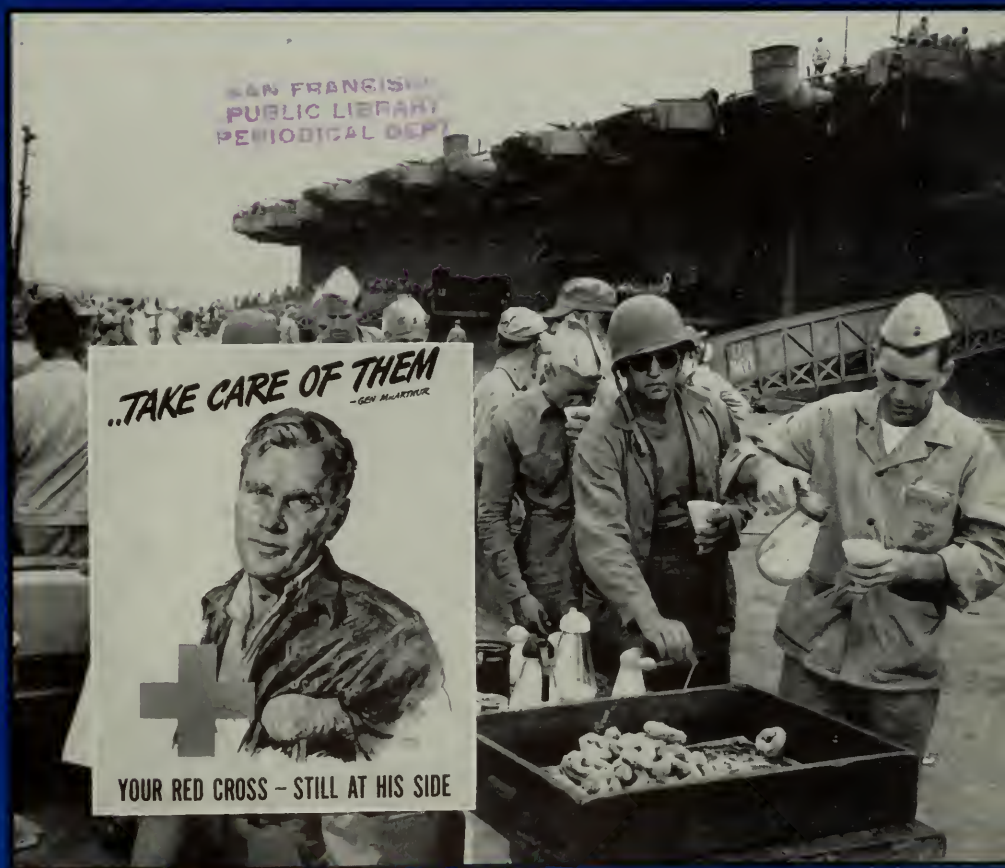

FEBRUARY

1946

DEPENDABLE



A
"PACIFIC
PRODUCT"

Produced by
PACIFIC PORTLAND
CEMENT COMPANY
San Francisco • Los Angeles
Portland

Sold by
YOUR BUILDING
MATERIALS DEALER

UNIFORM - TIME TESTED

• ARCHITECT

Vol. 164 No. 2

AND ENGINEER

ARCHITECTS' REPORTS—Published Daily

Telephone DOuglas 8311

E. H. WILDER
Editor

MARK DANIELS, A.I.A.
Associate Editor

JOHN S. BOLLES, A.I.A.
Book Reviews

MICHAEL GOODMAN
Post-War Planning

L. H. NISHKIAN
Consulting Editor

E. N. KIERULFF*
Ass't Editor
*In the Service

Contents for



FEBRUARY

COVER: SUPPORT THE AMERICAN RED CROSS 1946 FUND CAMPAIGN

Photo San Francisco Chapter

ARTICLES AND MISCELLANEOUS TEXT

RUNNING FIRE	4
By MARK DANIELS	
FLUORESCENT LIGHTING for Typical Home Settings	5
NEWS AND COMMENT ON ART	7
A COTTAGE at Carmel	9
By ANGELO HEWETSON, Architect	
CALIFORNIA'S STAKE In National Reclamation	10
By HARRY W. BASHORE, U.S.B.R. Commissioner	
SOLVING THE HOUSING PROBLEM IN ENGLAND	12
THE ROYAL INSTITUTE of British Architects	13
By C. D. SPRAGG, R.I.B.A.	
A GROUP OF SMALL HOMES, Designed by Chester H. Treichel	15
COMMERCIAL BUILDINGS IN NORTH AFRICA	16
By J. WELLS HASTINGS	
IN THE NEWS	27, 35, 37, 39, 46, 47
HEADLINE NEWS & VIEWS	28
By E. H. W.	
A. I. A. ACTIVITIES	31
WITH THE ENGINEERS	32
PRODUCERS' COUNCIL PAGE	38
ESTIMATOR'S GUIDE	41
Building and Construction Materials, Wage Scales	
CLASSIFIED ADVERTISING	43
BOOK REVIEWS	44
ADVERTISERS' INDEX	48

ARCHITECT AND ENGINEER (Established 1905) is published on the 15th of the month by The Architect and Engineer, Inc., 68 Post St., San Francisco 4; Telephone EXbrook 7182. President, K. P. Kierulff; Vice-President and Manager, L. B. Penhorwood; Treasurer, E. N. Kierulff.

Los Angeles Office: Wentworth F. Green, 1709 West Eighth Street.

Entered as second class matter, November 2, 1905, at the Post Office in San Francisco, California, under the Act of March 3, 1879. Subscriptions United States and Pan America, \$3.00 a year; \$5.00 two years; foreign countries \$5.00 a year; single copy 50c. ARCHITECTS' REPORTS are published daily from this office, Vernon S. Yallop, Manager.



RUNNING FIRE — by MARK DANIELS

It has been the policy of ARCHITECT AND ENGINEER to refrain from taking sides in any general controversy over architectural movements, but rather to present both sides as we get them from the architects.

However, in the November issue this column did point out the surprising result of a FORUM survey which showed only about 4% of the people interviewed as wanting a so-called modern house. Now, so many of the modernists of late have been claiming that the whole world has gone modern that I felt I should speak up, albeit faintly. The reply of a famous general to the German demand for surrender was a loud and thunderous "NUTS." I have not his courage but to these claims of the "Moderns" I did crawl out of my editorial fox hole long enough to emit a sotto voce "NERTS."

WHITE ELEPHANTS—Minus 4 Per Cent

By L. S. SANDERSON

It was great, good news to read in your November "Running Fire" that only 4% of today's architectural clients favored the modern style—or, flat top, peek-a-boo, glass wall, Venetian blind fox hole, summer oven, winter quick freeze, high cost flop—to be more specific.

I know a great many architects that had come to believe, after all these years of softening up by the peek-a-boo minority, that all was lost. That Americans had not only abandoned their inherited respect for rich colonial wind falls, along with the horse and buggy, but every other evidence of reason and intelligence.

Now it is joyously clear that they were entirely mistaken, minus 4%.

Accordingly, it is timely to note that there are now under construction here in Los Angeles more of those long low rambling adobes for which California is famous than there were during the last years of Pio Pico.

This makes sense. The thin over-stressed impossible facade of Nazi Germany, home of the flat top peak-a-boo, has collapsed, corner window, cantilever beam, gas pipe, and all. The fair haired immigrants from those regions, with all their noisy talk about European superiority in science, engineering and what not, are now up against a very worldly young America. An America that has not only nibbled ersatz pretzels on Under den Linden, but an America that has seen that they knock out more art in America every week than all Europe combined from Giorgione to Mussolini.

Corner window Goering had an eye for the horse and buggy stuff of the continent, but it seems that few G. I.'s swapped their pin-ups for any part of it. On the contrary, they found thousands of

European girls anxious to join up with them engage in the pleasant American enterprise growing roses under windows where window ought to be. And so the boys and girls are coming back to add onto their home towns where the folks left off, not to plow them under to rebuild a flat top slum, row on row ah la Internationale.

They want homes that are ample—solid, picturesque, and fully in harmony with the geography of their home states. Homes in which children can be reared in such an atmosphere as to cause young Californians to say to young Virginians twenty years hence, "I think every thing about your state is wonderful, but naturally I like mine the best," and mean it.

Every state in America has its own special character, climate and unique way of living. The flat top Nazified peek-a-boo could adequately serve conditions many times more varied than all Europe combined, is, to say the least, not only absurd, but really nuts, minus 4%.

Beside this scientific angle, there are other reasons for picturesque adobe homes with red tile roofs for California. California is not only a tourist mecca as always, but now a very important style conscious style center.

Californians have learned that it pays to be different and have a style of their own. They know that good styling pays real dividends when it adds value at little or no cost to production—and so far as buildings and homes are concerned, Californians know that more photographs are taken and pictures painted of Ramona's marriage place, the old Missions, Santa Barbara's Court House, and the like than of any flat top peek-a-boo on earth.

The majority of Californians like to fancy their own homes as especially attractive and a definite asset to their neighborhoods—rather than a freak and a community liability. All of which, to the wise ones, is decidedly good business especially if it becomes necessary to sell or trade. If only 4% favor this unpopular and inferior style then it is obvious such buyers will be hard to find and the estate may well consider itself the owner of a White Elephant—minus 4%—and be prepared to suffer a substantial loss.

That any architect will continue to urge unwise sound risks on a client he has been employed to protect in the future will indeed be a questionable procedure.

Anyway, young America knows, if some architect don't, that you can't make love and raise a family in a glass show case, and a residence that won't resist a shower of hail or an 80-mile breeze is just another clip joint in any language or locality.



Continuous strips of fluorescent light over the work surfaces in the kitchen illustrates important trend in postwar home fixture design.

(Sylvania Elec. Photo)

Fluorescent Lighting for Typical Home Settings

Introducing modern, fluorescent lighting styled especially for the postwar home, the Sylvania Electric Products, Inc., recently opened its Lighting Center in New York City.

The result of months of research by company engineers, stylists and architects, working with Lurelle Guild, noted design consultant, a group of rooms including the living room, bedroom, study, kitchen, and bathroom, are displayed revealing new trends in home lighting that are as decorative as they are efficient.

The Lighting Center provides a laboratory for experimenting with new residential lighting ideas and evaluates them over a sufficient period of time to make them tested before adoption for home installation.

"Our goal in room decorating and lighting," declares William F. Rooney, company executive, "is to avoid flat panels, boxlike fixtures and over-emphasis on efficiency. Instead the rooms are functional because they provide good lighting and enough of it, with a high degree of eye com-

fort, and such human factors as the way people sit and the use to which they put each room have also been taken into consideration."

Incandescent and Fluorescent Blend Successfully

One of the outstanding features of the rooms is the successful use of both fluorescent and incandescent light sources. Both are used in the living room and bedroom and the combination presents a soft, pleasing effect as well as providing adequate light for any task. New lines, crisp detail and nicety of finish mark the fluorescent fixtures. Several new materials have been used in designing them with the result that, while the lighting itself provides good seeing, the fluorescent fixtures harmonize perfectly with customary incandescent fixtures besides following the mood of the other furnishings.

Kitchen Lighting to Fit Shape of the Room

In the kitchen, where modern lighting is most in demand, continuous strips of fluorescent lamps have been mounted on the ceiling over the work surfaces. The unit follows the contour of the surfaces, with light coming down on the areas where food is prepared. The lamps create a soft, even light, with virtually no shadows throughout the entire room, and, according to Kathleen Hanway, Sylvania's Residential Lighting Consultant, this flexible type fixture will become a major appliance in postwar kitchens. A new development in illumination for the kitchen, the lighting creates a bright, cheerful atmosphere in which to work.

An additional breakfast alcove fixture, mounted on the wall, throws ample light on the table and gives a pleasant dining atmosphere to the room, when used independently.

Bathroom Light Eliminates Mirror Shadows

Ideal illumination for shaving, applying make-up and dressing is a feature of the model bathroom at the Lighting Center. Fluorescent lamps and fixtures are used throughout. The compact ceiling fixtures gives the entire bathroom a soft, cool and shadowless light which creates an atmosphere of cleanliness. Lamps on either side of the mirror provide excellent illumination for shaving or applying make-up because the long lines of light reach from the top of the head to below the chin, thus eliminating the shadows usually created under the chin. These lamps are mounted on separate outlets, but a similar arrangement is possible where only one outlet exists.

Decorative Living Room Illumination

Incorporating a number of interesting developments in residential lighting, the living room offers a variety of ideas for decorators and architects. Comfortable, home-like atmosphere and good light for reading, sewing or card-playing is the keynote. Concealed behind the window valance, fluorescent lamps make a focal point of the win-

dow by highlighting the draperies, thus giving the room its principal decorative interest. Portable incandescent lamps placed beside each seating unit furnish extra light for close work, while a decorative fluorescent ceiling fixture supplies soft general illumination over the entire room. Also, by lighting the rug and walls, the central fixture eliminates the harsh light contrast that would exist if only the incandescent lamps were used for reading or sewing. Successful blending of the two sources of light results in subtle shadows which are part of the decorative pattern, rather than sharply lighted areas and dark corners. When portable units are turned off, the fluorescent lighting on the ceiling and at the window gives a soft, attractive, conversational atmosphere to the room.

Feminine Design in Bedroom Lighting

General illumination in the studio bedroom comes from fluorescent lamps enclosed in a lacy ceiling fixture, from fluorescent lamps concealed behind the window valance and from fluorescent lamps above the bookcase. Designed especially for a college or business girl, or as a guest room, furnishings and lighting are keyed to comfort and utility. Each of the three fixtures utilizes the light reflection value of the light colored, blue and white walls and white ceiling which help redirect the light over the entire area. When only the valance light is in use the room has a pleasant, conversational atmosphere ideal for entertaining, while with any two of the fixtures turned on, there is sufficient light for studying, reading or sewing.

The lighted bookcase with fluorescent lamps above the upper and lower shelves, achieves an unusual decorative effect which could be employed in a living room, foyer or study as well as in a bedroom. Faint highlights enter the center shelf through a frosted glass panel and further drama is created through the use of different colored lamps—daylight in the lower shelf and white in the upper shelf—to change the appearance of the wood and accessories. The lower shelf fixture may be adjusted to provide extra reading light on the studio couch.

Vari-Purpose Lighting for Study

Lighting variations possible in a small area are illustrated in the study-type office at the Center. A louvered fluorescent ceiling fixture carries out the line of the conference table in the center of the room. It provides both indirect general illumination throughout and good working light on the desk itself. When special effects are desired, a shielded fluorescent strip behind the desk softly illuminates the draperies. The directional effect of sunlight is created at night by the use of another fluorescent strip placed on the ceiling in front of the glass brick window panel.

(See Page 43)

NEWS AND COMMENT ON ART



TO SAN FRANCISCO

Oil—Tom Lewis Gerstle
Mack Collection

THE SAN FRANCISCO MUSEUM OF ART sends out a questionnaire that is of the kind that should be read by everyone, so we give it verbatim here.

DO YOU KNOW, for instance, THAT:

The Museum presents six to ten exhibitions each month, about 100 to 120 annually. Of these one third are exhibitions predominantly of artists of the Bay Region. THAT:

All facets of new styles and expressions, provided they appear to have quality and are likely to have influence, are explored, so that both artists and public may study, consider and even evaluate them, and in that way actually participate in the creation of art of our time.

It has been said that most works of art wear out—not tangibly—but in their influence on the possessor, and that one should replace them for new things, expressive of changed conditions in five, ten or twenty years.

Do you think of art as having a pervading influence on your life? Or as a thing of luxury apart from practical living?

Do you buy works of art for your own home and enjoyment? If so how many per year? Do you prefer the contemporary or traditional style, the unknowns or the famous? Local artists, other Americans or foreign artists?

In answering the questionnaire the Museum urges everyone to give the questions serious thought "and your best judgment . . . , since we consider the answers valuable in helping us shape future plans."

THE NORTHWEST PRINTMAKERS' 18th ANNUAL INTERNATIONAL EXHIBITION, will be held in the Seattle, Washington, Art Museum, March 6 to April 7. Open to all artists. Entry fee \$1. For further information write Eleanor Honningfort, secretary, 713 16th Street, Seattle.

CALIFORNIA SCHOOL OF FINE ARTS ENLARGES PROGRAM

With the beginning of the new year a number of new courses have been added to the already expanding curriculum of the California School of Fine Arts.

In the Department of Commerce and Industry a number of new instructors are conducting courses in Advertising Art, Production Method and Fashion Illustrating, including Milton Cavagnero, Harry Klink, Warren Zimmer, Miss Carol Purdy, and Elmer Bischoff.

The School is offering its complete curriculum to Trainees and Veterans under the G. I. Bill of Rights. Complete information may be obtained by writing the school at 800 Chestnut Street, San Francisco 11, California.

DOROTHY NEWMAN, formerly with the de Young Memorial Museum in San Francisco's Golden Gate, has become identified with the California School of Fine Arts, 800 Chestnut Street, San Francisco 11, California.

M. H. de YOUNG MEMORIAL MUSEUM IN GOLDEN GATE PARK

The story of the care given wounded and ill American soldiers is depicted in the Abbott Collection of Army Medicine Paintings, to be on free public view at the M. H. de Young Memorial Museum, Golden Gate Park, San Francisco, through February 17.

This collection of oils, water colors and sketches shows the care and treatment given wounded soldiers from the time they left the battlefield through rehabilitation. It depicts the heroic role of Army doctors and nurses, the unselfish devotion to duty of hospital corpsmen. It shows why nearly 97 out of every 100 American soldiers who were wounded in battle and reached hospitals recovered from their wounds.

All are the works of 12 of America's best known artists: Howard Baer, Robert Benney, Peter Blume, Franklin Boggs, Francis Criss, John Steuart Curry, Ernest Fiene, Marion Greenwood, Joseph Hirsch, Fred Shane, Lawrence Beall Smith, and Manuel Tolegian.

This valuable and contemporary history of the Army Medical Department was sponsored by Abbott Laboratories of North Chicago, and presented as a gift to the War Department. After a tour of the United States, the pictures will go on permanent exhibit at Washington, D. C.

SAN FRANCISCO MUSEUM OF ART

Exhibitions and activities to be shown during February include:

EXHIBITIONS

10th ANNUAL DRAWING AND PRINT EXHIBITION of the SAN FRANCISCO ART ASSOCIATION—February 14-March 10.

Last day for Registration Cards Jan. 21. Delivery of works by Jan. 23. Reception and private preview Feb. 12, 8 to 10 P. M.

Paintings by EVERETT McNEAR—February 19 March 10.

HYMAN WARSAGER COLOR PRINTS, February 19-March 10.

ACTIVITIES and CLASSES:

CHILDRENS' SATURDAY MORNING ART SESSION, ages 6 to 14, 10 to 11:30 A. M. Painting, Clay Modeling, Block Printing, 10c charge to cover materials—to May 25.

STUDIO WORKSHOP, Evenings 7 to 9 P. M. every WEDNESDAY. SKETCH CLUB, Evenings 7 to 9 P. M., every FRIDAY conducted by GEORGE HARRIS.

DISCOVERING PAINTING, Lecture-Demonstrations, conducted by CLAIRE FALKENSTEIN—to February 18.

CONCERTS by Alexander Schneider, violinist and Ralph Kirkpatrick, Harpsichordist.

All Bach Program, Friday, February 22.

Mixed Program, Monday, February 25.

Tickets at Normandy Lane Box Office and the Museum

FILMS

KNOW YOUR WORLD SERIES: at 2:30 P. M. Saturdays and Sundays, South America, Animal Life, Africa, United States.

FAMOUS FILM SERIES: at 8 P. M. Tuesday Evenings. EAST SIDE OF HEAVEN (1938) February 5.

Madame Bovary (1937) February 12.

Forever and a Day (1943) February 19.

Maria Chapdelaine (1935) February 26.

CALIFORNIA PALACE OF THE LEGION OF HONOR

D. Jermayne MacAgy, Acting Director of the California Palace of the Legion of Honor, Lincoln Park, San Francisco, has announced the following schedule of exhibitions and special events for February:

EXHIBITIONS

THIRTEEN WATERCOLORISTS—11th Annual Exhibition, Feb. 1-28.

WATERCOLORS BY ANDREW WYETH, Feb. 5 through Mar. 4.

PHOTOGRAPHS OF VENEZUELA, HAITI, TRINIDAD AND NETHERLANDS GUIANA BY ALBERT GREENFIELD through Feb. 28.

The Alma de Bretteville Spreckels Collection of Sculpture and Drawings by Auguste Rodin.

The Mildred Anna Williams Collection of Paintings, Sculpture, Tapestries and Furniture.

The Collis Potter Huntington Memorial Collection of 18th Century French Paintings, Sculpture, Tapestries, Furniture and Porcelain.

SPECIAL PROGRAMS:

Organ Recital by Uda Waldrop, every Saturday and Sunday—3 P. M.

Organ Concert Broadcast at 3:30 P. M., Saturdays, Station KFSO.

SPECIAL ANNOUNCEMENT—Entry blanks are now available for the First Spring Annual Exhibition of Painting to be held during April 1946. Blanks may be obtained from the Museum, Bayview 5610.

MOTION PICTURE SERIES Admission Free, each Sunday at 2:30 P. M.

GREED—1924. Zazu Pitts, Gibson Gowland, Directed by Erich von Stroheim—Feb. 24.

EDUCATIONAL ACTIVITIES:

Children's Classes: Session in Painting and Drawing for children of the ages 6 through 8 and 9 through 12. Every Saturday from 10:30 to 11:45 A. M.

Class for Adults: Painting class for adults every
(See Page 40)



A Cottage at Carmel

By Angelo Hewetson, Architect

One of a group of six cottages in Carmel, Calif. The resawn red-wood exterior is creosote stained with gaily painted sash.

Two bedrooms, one is 11½ by 15 feet and the other is 11 by 13 feet.

The living room is 15 by 22 feet, and there is a dinette and kitchen and a good bathroom with shower.

This particular home has an attached garage, heavy shake roof, and a sheet rock interior.

California's Stake In National Reclamation

Excerpts From An Address by Harry W. Bashore

Commissioner U. S. Bureau of Reclamation
Before the California Water Conference, Sacramento

I want to speak to you about the plan evolved in the Department of the Interior, in cooperation with many Californians, designed to promote the best interests of your State—one which favors no special interest or locality.

The plan proposed by the Bureau of Reclamation is the only plan for the full coordinated development of the Central Valley resources which California has ever received. It is the only comprehensive plan for the conservation and use of water now before the State.

The initial stage of development, which is now under construction and involves the completion of the Shasta reservoir and power plant, the Keswick afterbay, Friant reservoir, the Delta cross channel, the Delta-Mendota canal, the Contra Costa canal and distribution system, the Friant-Kern canal, the Madera canal, the Delta steam power plant and part of an electric transmission grid, is estimated to cost between \$350,000,000 and \$400,000,000, of which more than \$160,000,000 already has been expended.

The second stage of construction, which is recommended for authorization in the present basin-wide plan will require about 15 years to complete. It involves 30 major projects totaling in cost about \$527,000,000.

The third stage of construction which will be undertaken when the projects are needed and funds become available, will involve 36 additional projects at a total cost of some \$900,000,000.

HUGE INVESTMENT

These three stages add up to an investment in California of about \$1,800,000,000. This is two and one-half times as great as all the money that has been spent by the Tennessee Valley Authority, and almost twice what has been invested by the Bureau of Reclamation in all our 17 western States in its 43 years of successful operation. I am sure that your imaginations need little stimulation

to visualize what this would mean to California while construction is underway.

Now let us take a look at what some of the benefits of this development can be. When the plan is completed about twice as much farm land in the Central Valley will be irrigated as in the past. During the period 1928 through 1934, irrigation in the valley consumed on the average 7,450,000 acre-feet of water for irrigating 2,970,000 acres. The ultimate plan calls for the use of 16,600,000 acre-feet on 6,580,000 acres.

ELECTRIC POWER

About one-third of the hydroelectric power generated will be used for pumping irrigation water. It is clear, therefore, that there is a direct connection between the cost of water delivered on the land and the cost of electric current. Unless there is low-cost power there can not be low-cost irrigation water for most of the valley, although a few especially favored areas might benefit by local conditions. The comprehensive plan includes 28 power plants at multiple-purpose reservoirs and afterbays, which would increase the capacity of hydroelectric plants in the basin by 1,697,000 kilowatts. These, together with 750,000 kilowatts in supplementary steam plants needed ultimately to firm the hydroelectric output in dry years, would aggregate 8.1 billion kilowatt-hours of firm power annually.

This places the annual benefits of full development of Central Valley resources at about \$275,000,000 yearly on an investment of about \$1,800,000,000—a return of more than 15 per cent per annum. And this does not include the income and profit taxes that would flow back in hard cash to the Treasury as a result of its outlay on wealth creating properties.

MAN-HOURS WORK

The first two stages of the program would provide about 550,000,000 man-hours of employment

at the construction sites and in manufacturing plants through the nation. Translated into men at work, this means the employment of some 18,000 men for 15 years.

COOPERATION NECESSARY

In the face of these facts it is important that all California interests unite upon a single plan that will produce maximum results for the people of California and for the Nation. If the interests of the Nation as a whole are overlooked by the people of this State, I believe I can say without qualification that you will make little progress with Congress in obtaining the funds which you so urgently need. This will be true also if you place the interests of any special group within your state above the interests of the people of California as a whole.

If business, labor, farmers, consumers are united on one plan that is comprehensive and well-conceived, I believe that you will get the necessary financial support from Congress.

This plan for full development of the Central Valley is identical in many respects with the plan developed by the State of California itself. The initial project development is virtually the same as that proposed by the state. The Bureau of Reclamation must, by law, respect the water rights of individuals, and the State laws under which the rights of individuals are protected. We have no desire to override the wishes of the people of California, and have offered the service of the Federal Government with but one purpose in view—to assist the people of California.

CASE STUDY HOME RADIOS

Lear Home Radios have been chosen as official equipment for two Case Study Houses, which have been designed by the country's leading architects and are being erected in Los Angeles.

When the Case Study House program has been completed late this year, thirteen houses will have been built, covering various types and price range.

The architects who planned these homes include William Wilson Wurster, Dean of the School of Architecture and Planning, Massachusetts Institute of Technology; Richard J. Neutra, President of the International Congress of Architecture; Eero Saarinen, who planned the City of Research and Science for General Motors; J. R. Davidson, Beverly Hills designer; Sumner Spaulding, who planned the Los Angeles Municipal Airport; Ralph Rapson, head of the Architectural Department of the Chicago Institute of Design; Charles Eames, winner of the Museum of Modern Arts award in organic design; and others.

GLENN STANTON, Portland, Oregon, Architect, was a recent business visitor in California.

RESUMES EXPORT BUSINESS

The first official postwar order for overseas shipment of blowers and fans by the UTILITY APPLIANCE CORP., of Los Angeles, marked the resumption of the firm's extensive prewar export program.



Bernard Harris, sales manager of Utility (left), and **Perry Girton**, owner of the Costa Rica Broadcasting Company and station GIPG, San Jose, Costa Rica.

Girton's firm distributes well known major appliances throughout the Central American republic, and recently placed a substantial order for UTILITY blowers and fans.

Utility also reports resumption of trade with Bruce & Company, Honolulu distributing firm, who have ordered blowers and fans for use in the Hawaiian Islands.

ANNOUNCEMENT

Owing to increasing demands for his able counsel and long outstanding professional ability, Mr. Mark Daniels, Editor of Architect and Engineer for the past year, is returning to the private practice of Architecture.

He will continue to write the popular feature, "Running Fire," which has appeared in this publication for so many years, and will also serve in an advisory editorial department capacity.

We know Mr. Daniels' many friends among Architect and Engineer readers will join with us in wishing him the continued success he so richly deserves.

Edwin H. Wilder, who has been serving as Associate Editor and is well known in the publishing industry, will assume direction of the editorial and news department.

ARCHITECT AND ENGINEER



(British Official Photo)

Solving the Housing Problem in England

To help solve one of Britain's major postwar problems, the replacement and repair of the 4,500,000 homes destroyed or damaged by German bombs, the aid of Mulberry, British portable harbors that were such a surprise to the Nazis on D-Day, has been enlisted.

A firm that designed and built portions of it is

now applying the experience gained to the housing problem.

A jig is built, slabs of concrete are placed around it and cemented in position. The jig is then removed and placed on the site of the next house.

Picture shows: Mulberry houses in various stages of completion on a golf course at Croydon, London.

The Royal Institute of British Architects

By C. D. SPRAGG, R.I.B.A.

The Royal Institute of British Architects is the central organization of architects in the whole of the British Commonwealth and now includes in its membership and in that of its 30 Allied Societies in Britain and the Dominions and Colonies almost all qualifying architects of standing.

In Britain there are no State architectural institutions, so that almost all the obligations of maintaining the welfare and status and quality of the profession fall on the R.I.B.A.

The principal obligations fulfilled by the R.I.B.A. are the organization of education, the definition and maintenance of codes of professional conduct, the provision of a large number of committees to work out the profession's policy in current affairs and conduct the Institute's business. On the R.I.B.A. too rests the fundamental duty of presenting the united voice of the profession to the people generally and the Government.

The R.I.B.A. was founded in 1834 at a time when many of the professions in England were collecting their resources and uniting their forces to meet the new and often conflicting responsibilities of the dynamic new Industrial Age. This was a time when, as today, new techniques were flooding into and challenging the traditional art of architecture.

Among leading men concerned with the R.I.B.A. at the time of its foundation were Charles Barry, Architect of the Houses of Parliament and leading Gothic revivalist, his compeer among the classicists, Charles Robert Cockerell, Architect of the Ashmolean Museum at Oxford and classical scholar whose work on the Temple of Apollo at Bassae is well known, Basevi, Decimus Burton and some of the great Victorian engineer-architects such as Charles Fowler and Rennie, Architect of Waterloo Bridge in London. The new Institute also had the active and financial support of the great architect and antiquary Sir John Soane.

The first Royal Charter was granted by King William IV in 1837 and in the same year on her accession to the throne Queen Victoria became patron. In 1842 Prince Albert, the Prince Consort, acted on one occasion as Chairman of the Council and presided at a General meeting of the Royal Institute.

In 1848 the Queen founded the Royal Gold Medal and in 1866 by her command the style of the Institute was altered to "Royal". All subsequent sovereigns have been patrons

When the Institute moved to its new premises in Portland Place in 1934 King George V, who was accompanied by Queen Mary, formally opened the new building. The present King who became patron on his accession was before that, as Duke of York, one of the Honorary Fellows.

The list of Royal Gold Medallists since its institution in 1848 includes the names of distinguished architects of every country and is a greatly prized honor. It is of interest to note that it has been awarded to a Russian architect for the first time in this present year when His Majesty was pleased to approve the recommendation of the R.I.B.A. Council that it should be conferred on Academician Victor Vesnin, the doyen of the Russian architectural profession and noted amongst other things for the design of the great Dnieper dam, which was destroyed by the Russians during their retreat before the German onslaught. Among those who received the Royal Gold Medal were Sir Edwin Lutyens and Sir Herbert Baker who were responsible for the design of the Government Buildings at New Delhi. Dr. H. V. Lanchester who has also carried out some of his finest work in India is also a Royal Gold Medallist.

The present headquarters of the R.I.B.A. were designed by Mr. Grey Wornum, the winner of a

(See Page 28)



ABOVE Fire rooms
 Stained redwood exterior
 White trim, grey stain on shingle roof
 Located on large corner lot

A GROUP OF SMALL HOMES

BELOW Five rooms
 Stained redwood exterior, white trim
 Aluminum composition roof
 large corner window in living room
 Corner fireplace serving combination living room
 and dining room
 Sheltered loggia at rear





- ABOVE**
- Seven rooms
 - Stucco and brick veneer exterior
 - Shake roof
 - Library with corner fireplace
 - Protected loggia at rear
 - Large view window at end of living room

Designed By Chester H. Treichel, Architect

- BELOW**
- Five rooms
 - Painted redwood exterior
 - Shingle roof
 - Steel sash windows
 - Large corner window
 - Terrace front and rear



Commercial Buildings In North Africa

By J. WELLS HASTINGS

The great progress made in the design of commercial buildings in North Africa in the past fifteen years can only be measured by comparing it to the past.

When I went to Algiers in 1931 the only apartment I could find was in a new building that was just being completed under the old regulations. It was an eight story building on a narrow street that was so steep that it became a stairway. One had to climb twenty-five feet of steps before arriving at the entrance. The basement apartment consisted of three large rooms which contained one sink and toilet. These rooms were occupied by a "family" of twenty-three Arabs. (This family consisted

of a head of the house with a couple of wives, many children, aunts, uncles and grandparents.) The rest of the apartments were three and four room units, accessible by an elevator that went up, but could not carry passengers down. It was shut off at night.

Suppose you wanted to get into the building after 10 p. m. The following procedure is typical: You ring the bell at the entrance and wait, you

●
**Bank of State of Morocco. Typical adaptation
of Native Architecture.**

Cadet and Brion, Architects



Bank and Office Building of the Banque Commerciale du Maroc in Casablanca, Morocco.

The ground floor is done in stone stucco on hollow tile.

Slatted rolling wood blinds are on all windows.



Another typical Moroccan Commercial Building.

The extensive Arcades serve to protect pedestrians from the heat, as well as increasing the street area.



**New Apartment House
being constructed in
Casablanca, Morocco.**

**All windows are equipped
with adjustable rolling
wood blinds for heat and
light regulation.**

**The decorations are all
done in glazed tile.**

ring a couple of times again and the "conciierge" (janitor and manager) finally wakes up and squeezes a bulb that releases the lock and opens the door. You stumble in in the dark and a light goes on. As you call out your name to the concierge for identification, you dash to the elevator in hopes that it is still running. Of course it isn't so by that time you grope your way back to the front door, for the light has gone off. After stroking the wall over a large area you find the button that lights the stair lights (one at every other floor, and dash again—this time for the stairs. You have to hurry, for the lights automatically turn off again in a couple of minutes; the theory being that those on the lower floors won't need as much light

as those at the top of the building. At each floor you punch the light button to renew the time relay.

Your apartment is at the end of a hall on a landing that is between those that have lights. You sort out your keys, big oversized keys that look as if they had been made in the middle ages. By the time you have found the right one the light has gone out again. Cautiously you feel your way along until you start falling down the stair well. At that point you know that you can find the light switch. The place is pitch dark because the only outside light for the stair well is a skylight at the top of the elevator shaft. (Stairs almost invariably wind around the elevator shaft, even in new buildings.) More wall rubbing and you find the light

Right: Bank Building of the Compagnie Algerienne in Mazagan, Morocco, is of stone and stucco exterior and of masonry construction.



Left: Is an Apartment Building with store-on-street combination in Casablanca, Morocco. Note the Mosaic columns on the ground floor.

Architect, Balois; Contractor, Bohln.

Below: Unique Casino and Moving Picture Theater of Fez, Morocco.

The entire wall back of the Arcade is done in plate glass.





SIDE ELEVATION of the bank and office building of the Compagnie Algérienne in Casablanca, Morocco.

The ground floor windows are protected by wrought iron and cast cement grille, while the decorations are in green glazed tile and warm toned mosaics. Upper stories are widened by use of the Arcade.

(Photo by Gillot)

button,—a rush to the apartment door,—a struggle with the lock, and you are safe at home! Being at home, you know where to find the box of matches and candle or kerosene lamp. You know that you will have electricity in a few months because you stood in line for two hours to file your application three weeks ago.

The entrance to the apartment faces the door to the toilet. Pleasant little feature when you want to impress guests! This is a three room apartment with balcony and the possibility of a bath. You can actually sit on the balcony if you place a chair sideways. Bed room and living room windows are French doors opening onto the balcony. These have shutters with a heavy iron bar to lock out intruders. (I've heard of burglars crawling in at the third story.)

The kitchen may be placed on a narrow light well where the sun never enters below the top floors. It has a sink with one cold water tap. You

get hot water by the kettle-on-the-stove method. There are a couple of shelves, but no cabinets in the kitchen. The gas pipe is in place, but each renter furnishes his own stove, and carts it away with him when he leaves.

The "bath" is an oversized closet with capped pipes where a four foot tub could be connected. Anyone installing a tub has the option of taking it with him when he leaves if he properly repairs all plaster, caps pipes, etc. Consequently you try to sell the tub to the next person when you leave.

When the electricity finally comes it is installed under wood battens, and you pay for the whole works including the meter. Since you can not rip out the wiring and lights easily without damaging the walls and ceilings, you try to sell that too to the next lessee when you leave.

There is no heat. After trying an electric heater and getting an \$18 bill for a month's electricity you settle for a kerosene stove, which can be carted

Right:

**One of the newer
Apartment Houses
to be found in
Tunis, Tunisia.**



**APARTMENT HOUSE interior showing
unusual stairwell.**

**All metal work is wrought iron and
stainless steel, while the center col-
umns are done in polished stucco.**

(Photo by Demure)



Above: A lovely Tunisian Apartment House. View is a side elevation showing vertical setbacks in the court which permit ample light to enter. Note the wrought iron grille in elevator shaft, and welded steel rail in the foreground.

(Photo by Demure)

Below: At Bizerte, Tunisia, is one of the popular Officers Apartment buildings which is part of a group of seven attractive buildings. This photograph was taken before the war and because of concentrated military action in the area, is probably a pile of rubble at present.



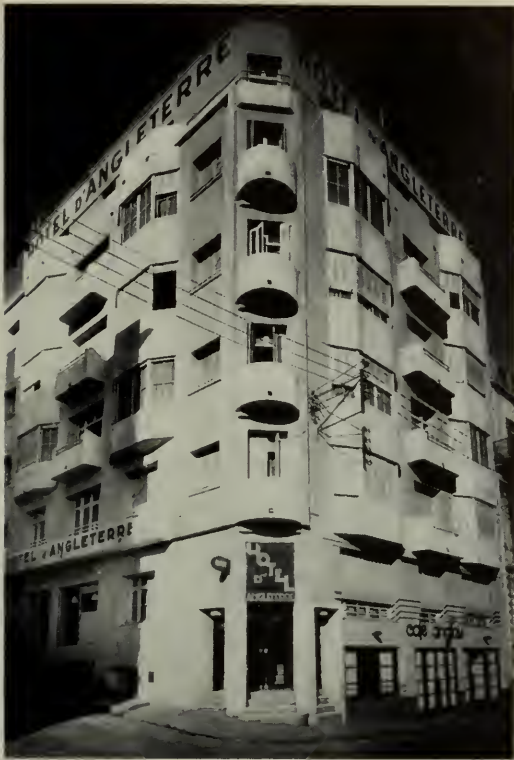

Above: The famous Hotel d'Angleterre and Cafe Anglais in Algiers, Algeria. Rene Lugan was the Architect-Engineer.

(Photo by M. de Louvencourt)

At Right: Is striking design in detail of entranceway to the Hotel d'Angleterre.



from one room to another without too much trouble. Algiers is supposed to be warm, so floors are of cement tile and walls are of masonry or tile. That is fine most of the year, but in the winter months the temperature drops to 40° F, and the place feels like a damp ice box.

There are no closets, for most people have their movable wardrobes, so you put a few nails in a door and try to hang your clothes there.

Laundries are placed on the roof. The inadequate number of tubs and lack of drying space add interest to living. You spend many an evening figuring out how to beat the gang there.

* * * *

New regulations are made; real estate men and builders wail and tear their hair, saying they can never get a return on their investment. "The price of land is too high to afford so much lost space! The cost of building will be prohibitive!"—But new buildings go up just the same, and rented before being completed. What has happened? No more narrow light wells, but large airy courts, proportioned to the height of the building. Elevators work two ways. Central heat and electricity are installed, the first included in the rent, the second metered for each apartment. Night lights are left on all night. The laundries are still on the roof but the numbers of tubs and drying space in in-



Above: "La Cite Moderne,"
new apartment building in Al-
giers, Algeria.

Decorations of precast cement
and glazed tile. Individual gar-
ages located on ground floor.
X. Salvador, Architect.

Right: Reinforced concrete
apartment building in Algiers,
Algeria.

Walls and partitions are of
hollow tile, while glass brick
wall is used for stairwells and
elevator shafts.

Note the "set-Back" required
for 10-story buildings. Garage
in basement. Charles Monta-
land, Architect. Houre Freres,
Contractors.



creased. Some places actually have closets. All have baths complete with basin, tub and toilet. The toilet, as usual, is kept separate. The kitchen and bath have hot and cold water. Balconies are made a bit wider. In some apartment buildings loggias are used instead. Some buildings even have separate laundries for each apartment. Many apartment buildings in Morocco are air conditioned.

After the new building codes went into effect many an old time apartment house had vacancies, while all new ones had waiting lists. What can we learn from this? In spite of the fact that we take bathrooms and good kitchens for granted, many of our regulations concerning space requirements are antiquated. It seems that the best investment is made when people have cheerful, sunny places to live. The high cost of land coverage resulting from the use of large light courts is compensated by less turnover and full rentals. New apartments could have indoor-outdoor living,



Left: Comination apartment house with stores on ground floor in Algiers, Algeria.

Rene Lugan, Architect. Louis Grasset, Contractor.

Below: Is another apartment house in Algiers designed by Architect Rene Lugan which is under construction. Note modernized use of balconies and metal railings.

(Photos by M. de Louvencourt)

now only obtainable in residences or penthouses, by making garden terraces or ample balconies where a few potted plants, a couple of chairs and a table could make a home atmosphere that is practically non-existent.

North African buildings are now almost always architect designed. The engineering is usually handled by a structural engineer. Investors find that a well designed building, attractive as well as practical, is worth-while. I'll admit that there are many atrocious buildings, but among new ones they are more the exception than the rule.

Just as Algerian, Tunisian, and Moroccan architects and engineers have developed an architecture characteristic of their countries, so can we develop an architecture that is representative of ours. From all I can gather at present a discouragingly large number of buildings are being erected with thought only of the present, and no thought to the future. Let's put the pressure on for better building regulations! Granted that our laws are excellent from a structural point of view, they cer-



tainly are fifty years behind the times from the point of view of livability.

Here are a few North African regulations that give us something to think about:

Larger setbacks at sides of buildings;

Larger courts, truly proportioned to the height of the building;

Building heights strictly governed by surrounding buildings and streets;

No direct view from a window to nearest obstruction closer than sixteen feet;

No indirect view closer than six feet (such as from a bow window or balcony);

Premium allowed for courts open on one side;

A master plan required for both urban and suburban areas;

A regional plan for all large cities;

Some of these requirements are partially satis-

fied by present building laws, but are certainly nowhere near ideal.

A final word on a very successful stimulus to building that was used in Algiers. Real estate taxes were frozen for a period of three years on all unimproved property. Any property that was developed during that period was granted a ten year extension of the existing tax rate, property taxes on the new building values starting only after the decade. The city did not lose anything but potential taxes, and gained immensely in increased business. Actually the law was put into effect for a year and much was done to get started under the deadline. Finding the method successful it was extended twice, with assurance that there would be no other extension after the third year. It seems that many West Coast cities would have an inducement for Eastern capital in following this plan.

COMBINED Apartment House and Automobile Sales Room and Garage Service Building in Algiers, Algeria. The concrete visors are for sun protection, while the balconies are of concrete slab with wrought iron rails for safety. Rene Lugan, Architect-Engineer.



IN THE NEWS

HOUSING SPEED-UP

Reports from 71 field offices of the FHA indicate the new priority system for scarce building materials is now in operation in all parts of the country.

The system expedites construction of new homes costing under \$10,000, with preference given World War II veterans, or builders who want to erect buildings for sale or rental where veterans will be given preference. Form "HH housing."

OXYCHLORIDE CEMENT FLOORING

Upon request of the Oxychloride Cement Association the American Standards Association have announced that it will set up a committee to develop specifications for the installation of oxychloride cement floorings.

Flooring of this type are used extensively in public buildings and offices, railroad and bus stations, and ship decking.

Specifications and methods of test for materials, and specifications covering floor installations, will be covered.

CONSTRUCTION SALES DISTRICTS

General Electric Company have revised their construction materials sales districts as part of an overall Company plan for more adequate coverage of construction materials distributors and the electrical trade, with new offices being opened in Kansas City, Mo., and Philadelphia, Pa.

J. O. Dillingham, San Francisco, is manager of the Pacific District.

NEW "RANETITE"

By combining aluminum and calcium stearic as a base, a new and improved postwar product for waterproofing stone, brick, and stucco has been developed by the RANETITE MANUFACTURING COMPANY, Inc., of Saint Louis, Missouri.

Called "Ranetite No. V Transparent Waterproofing" the product is easily applied, does not change the texture of the surface, and prevents dampness penetration.

WET SEAL GAS HOLDERS

Engineering data on welding technique, pressure, painting surface, corrosion and general dimensions of all sizes of gas holder up to 10,000,000 cu.ft., is discussed in a new 50-page Bulletin recently issued by STACEY BROS., GAS CONSTRUCTION COMPANY, Cincinnati, 16, Ohio.

The bulletin, W-45, is available upon request of the company.

OIL HEAT EXPOSITION

Under sponsorship of the Oil-Heat Institute of America, the National Oil Heat Exposition has been set for April 23-27 in Philadelphia.

It is estimated more than three thousand trade representatives will be in attendance, according to C. F. Curtain, exposition manager.

SET OF POLICIES

Declarations of policy covering a wide range of economic subjects, and designed to help the construction industry meet the difficult problems ahead, have been adopted by the membership of the Chamber of Commerce of the United States.

Voted upon by a mail referendum, the declarations do not set forth a complete presentation of Chamber policies, but do cover such subjects as Building Codes, Training of Employees, Federal Home Finance Agencies, Improvement of Housing, Subsidized and War Housing, Planning and Research, Public Works, Principles of Taxation, Termination of Wartime Controls, and Repealer Clause.

SERVES THIRD TERM

Henry B. Bryans, executive vice president and director of the Philadelphia Electric Company, was unanimously re-elected to serve a third term as president of the American Standards Association at the group's recent annual meeting in New York.

Frederick R. Lack, vice president and manager, Radio Division of Western Electric Company, Inc., was elected vice president; E. C. Crittenden, assistant director of the National Bureau of Standards, was named chairman of the Standards Council; and L. F. Adams, General Electric Company was named vice chairman of the Standards Council.

NEW ELECTRIC RANGES

Styled with chromium trim and embodying new engineering developments in the construction of surface heating units, the 1946 electric ranges by WESTINGHOUSE are now going to distributors throughout the country.

An exclusive Tel-A-Glance switch knob does away with the old control center, and indicates the heat setting to which they have been turned.

They are equipped with fast heating Corox surface units and have five heat positions.

In considering western development in the post-war era, and possibilities of industrial and commercial expansion, it might be a matter of interest to know that the Federal Government still owns approximately 50 per cent of the land west of the 100th Meridian—the 11 Western States.

HEADLINE NEWS & VIEWS

By E. H. W.

"Careful timing and scheduling of public works will do much to stabilize the construction industry and eliminate extreme fluctuations in employment for workers in the building trades," L. C. Hart, president of the Producers' Council recently declared in supporting Senator Murray's \$5 billion state and local public works reserve bill.

* * *

The OPA and the ATOM are synonymous, little is known or understood about either by the average person.

* * *

The part electricity played in the recent War is graphically told in a well illustrated booklet entitled, "Power for War," prepared and distributed by the Council of Electric Operating Companies, Washington, D. C. One glance at the record is sufficient to show the tremendous contribution of electric utility to the war effort.

* * *

Henry J. Kaiser, ship and auto builder, recently announced a "house building program" that will eclipse all existing construction records . . . surplus ships are anchored and rot in the bay, and automobiles are junked, BUT, what do you do with surplus houses of a production line vintage?

* * *

The progressive industrial standardization program of the American Standards Association, of which Henry B. Bryans, executive vice president of the Philadelphia Electric Company is president, will unquestionably result in many time and material savings in the building industry.

* * *

A voice in the wilderness of strife between labor and industry may be that of James F. Lincoln, president of the electric company in Cleveland, Ohio, which bears his name. Lincoln has a 7-point plan worth considering.

* * *

The Gerth-Pacific Advertising Agency recently issued a most commendable promotion booklet for their client, Moss Stores Incorporated, which now serve the Pacific Coast but will soon include the Pacific Coast Slope States and Hawaii.

* * *

If the line of new cabinet hardware, recently announced by THE STANLEY WORKS of New Britain, Connecticut, is any criterion of what may be expected in postwar building progress, the home and building of tomorrow is something to look forward to.

ROYAL INSTITUTE OF BRITISH ARCHITECTS

(From Page 13)

competition which was thrown open to members of the Royal Institute and its allied societies in every part of the world and which attracted some 300 entries.

For the first years of its life the Institute was almost entirely a London Society, but, as its usefulness and prestige increased, architects from throughout the British Isles joined and within a few years its position was firmly established as the one and only architectural body with authority and the power to grow.

During its first two decades the Institute's main functions were expressed in the holding of meetings, in the publication of a Journal, in the conduct of correspondence with Architectural Institutes and Academies in other countries and in formulating and maintaining a standard of professional conduct. It was not until 1855 that perhaps the greatest of all the Institute's tasks was started—the promotion, organization and control of architectural education, though in the earlier years educational matters were by no means neglected; several prizes for students were founded and the Institute's library was started which has now grown to be probably the finest collection of architectural books in the world and which has always played a progressive and large part in the education and maintenance of the competence of the profession.

In the earlier years membership was granted to architects in practice without any examination test but in 1863 the R.I.B.A. instituted a voluntary examination which by 1882 had become a compulsory test for entrants to the Associate class and now no one can enter either of the classes of Fellowship and Associateship without passing an examination, except that Associates can pass to the Fellowship after a certain number of years of practice. Throughout its history, and particularly during the last forty years, all the R.I.B.A.'s main activities have been aimed at the incorporation in its membership of all reputable architects throughout the Commonwealth, so that the Institute can be in fact as well as name the single representative organization of architects for British people everywhere. At the same time the leaders of the R.I.B.A. realized that prestige and status depend on quality as well as size; accordingly the examination tests for entrance have always been set as high as possible and are continually being raised.

In 1931 the profession achieved, largely through R.I.B.A. leadership, the State registration of the profession of architecture. We now have an Act of Parliament limiting the title "architect" to men and women who have passed an examination and a State body, the Architects' Registration Council

of the United Kingdom to maintain the Register. It is significant of the importance of the R.I.B.A. that its standards have been accepted as the statutory standards for registration. Although the Registration Council is an entirely independent body the closest harmony exists between it and the R.I.B.A. and the R.I.B.A. naturally maintains a commanding position in the affairs of the Council.

Architectural education in England is under the general guidance of a department of the R.I.B.A., the Board of Architectural Education, which inspects and guides the many independent schools. Some of these schools are faculties in Universities, such as those at Cambridge, Liverpool and London Universities, others at Leeds, Hull and elsewhere are technical colleges under the local government authorities and some are entirely independent. The best known of the last kind is the school run by the Architectural Association in London. The Institute's policy in regard to the various schools is directed solely to the assurance that their courses satisfy the general passing out requirements of the Board of Architectural Education. Each school is free to plan its system as it likes as long as this final test is satisfied.

About half of the entrants to the profession receive part-time school teaching in night classes or by correspondence classes while working as assistants in offices. These students take qualifying examinations set by the R.I.B.A. itself. Some

students take a full school training up to the Intermediate Examination held normally at the end of three years and then go into offices taking the R.I.B.A. Final Examination as their final qualifying test. The R.I.B.A. encourages as many students as possible to take the full school training, normally of five years, and scholarships are granted by the schools and by the Registration Council to enable many poorer students to do this.

In a normal peace time year about 350 students qualified each year for membership of the profession and the R.I.B.A. The total membership of the R.I.B.A. in Great Britain is made up as follows: 1,933 Fellows, 5,041 Associates, 2,681 Licentiates, 2,335 Students, and 6,909 Probationers. The first three classes only are fully qualified. The total Registered profession numbers 15,093. The larger number on the Register includes many men who were practicing as architects when the Act of Parliament establishing the Register was passed but who have passed no examination.

The R.I.B.A. Library is the largest special architectural library in the world. Its collection includes books in the whole range of architecture from historical studies to building technology and town planning and topography, aesthetics and works on the allied arts of sculpture and painting.

There are throughout Great Britain and the Dominions and Commonwealth a number of archi-



PUBLIC BUILDINGS

HOSPITALS

INDUSTRIAL BUILDINGS

Your 46 Plans call for America's Foremost Fountains!

Your plans should call for Halsey Taylor Fountains. They're America's foremost, because for years they have embodied every possible factor to promote sanitation and convenience, regardless of the type of structure in which they're installed. Health-safe automatic stream control, practical drinking mound, exclusive hygiene-promoting features! Get our latest catalog.

THE HALSEY W. TAYLOR CO., REDLANDS, CALIF.
HOME OFFICE & PLANT, WARREN, O.

HALSEY TAYLOR

DRINKING FOUNTAINS

A-1

tektural societies which are allied to the Royal Institute and which are known as "Allied Societies." These Societies are not branches of the R.I.B.A. but in some cases are nearly as old as the R.I.B.A. itself, having their own charters and independent constitutions. At the same time the closest liaison and harmony exists and they are all represented on the Institute Council. Among the nine Allied Societies overseas is the Indian Institute of Architects which has its headquarters at Bombay. The School of Architecture at the Sir J. J. School of Art, Bombay, is one of the schools recognized for exemption from the Institute's Intermediate Examination.

In forecasting the amount of public and private building to be done during the 5-year period from 1947-51, the Producers' Council assumes the cost of construction will average about 35 per cent above the level prevailing in 1940.

THE CONSTRUCTION OUTLOOK

By **MARDI**

In addition to the proposed \$2,000,000 Standard Oil project in Richmond, the Government contract for \$4,500,000 awarded at Pier No. 50, and the new Bus Depot in San Francisco for \$1,750,000, actual contracts awarded have amounted to about \$8,000,000 in Northern California in the last four weeks.

The confining of reports of residence construction to permits makes such reports of little value because the permit value is often far from the award value. Never-the-less, that the residence construction work has held its own is probably true although it has fallen off some.

The question of supply of building material is still paramount nor does it seem to be easing perceptibly. Many inquiries come in as to when owners of property may look for the time when they might be safe in letting a contract for a home. Your guess as to whether that time is near is as good as any.

Bond elections for \$3,000,000, to be spent school construction will be up this month and next but whether this is any criterion of conditions is hard to say. Materials for schools can be hard to get as well as those for houses and many GI's are still having difficulty with their small houses.

HOME CONSTRUCTION

Home construction will not attain the high rate in 1946 which was predicted during the war years as less than half the number of homes originally expected to be built during the first full year of peace will be built during 1946.

Shortage of materials and manpower and the high cost of all components needed in the hous-

ing industry will serve as restraining influences.

While only some 300,000 new dwellings in 1946 may contrast the wartime estimate of 600,000 to 1,000,000 new homes, it is predicted the demand over the next 10 years will approximate 6 to 7,000,000 homes.

"WITT COILS"

A. H. Witt, with more than twenty-five years experience in the refrigeration industry, has formed a new organization to handle the sale of commercial refrigeration coils and water coolers to be known as "WITT COILS".



A. H. "Ag" WITT

A. H. "Ag" Witt, recently sales manager of Drayer-Hanson Company of Los Angeles, is well known throughout the country, having been identified with refrigeration and air conditioning organizations in Pittsburgh, New York, and Indianapolis.

The new firm, which have offices at 767 East Pico Boulevard, Los Angeles, California, will deal through jobbers only. A unique policy in the field of refrigeration.

THE NETHERLANDS plan to build 60,000 to 70,000 houses annually beginning with 1947, according to a recent statement by the Netherlands Minister of Public Works.

January 3, 1946

Architect & Engineer
68 Post Street
San Francisco 4
California
Gentlemen:

I would like to subscribe to your magazine ARCHITECT & ENGINEER for two (2) years period starting with January 1946 issue. Enclosed with this letter is my personal check of five (\$5.00) dollars to pay for the two-year subscription.

I am now back with Michael Goodman, Architect, whom I was with before the War. I have always found your magazine most informative and interesting on Pacific Coast Architecture, so I am looking forward to some nice reading.

Sincerely,

David Alvin Lee

Enclosure:

Personal check \$5.00

A. I. A.

ACTIVITIES



AMERICAN INSTITUTE OF ARCHITECTS

Northern California Chapter:

Andrew T. Hass, President; E. Geoffrey Bangs, vice President; John S. Bolles, Secretary; Hervey Park Clark, Treasurer; 369 Pine Street, San Francisco 4.

Southern California Chapter:

Charles O. Matcham, President; Adrian Wilson, Vice-President; John Landon, Secretary; Albert C. Martin, Jr., Treasurer; Offices 3757 Wilshire Blvd., Suite 212, Phone Fltzroy 2393 or Mutual 4592. DIRECTORS, John Rex, Paul R. Hunter, and Weldon D. Becket.

CALIFORNIA COUNCIL OF ARCHITECTS:

John S. Bolles, President; Robert H. Orr, Vice-President; James H. Mitchell, Secretary-Treasurer; 369 Pine Street, San Francisco 4.

At the meeting of the Northern California Chapter of the American Institute of Architects, held at the Palace Hotel on December twenty-seventh, proposed amendments to the chapter by-laws were the principal subjects of discussion. They were four in number and called forth considerable comment and argument.

Roughly outlined they covered the making of the District Chapter a chapter in the California Council of Architects; the increasing of chapter dues from \$12.00 per annum to \$15.00 per annum; permitting letter ballots; approving advertising in the Chapter Bulletin.

All four amendments were passed with few dissenting votes and they now must be sent on to the Institute Headquarters in Washington for approval before they can be adopted by the Northern California Chapter.

WOMEN'S ARCHITECTURAL LEAGUE

The San Francisco and East Bay Women's Auxiliaries of the extinct State Association of Architects have changed their name to the Women's Architectural League.

The League is presenting a series of six lectures in the Twentieth Century Club, Berkeley, and the San Francisco Museum of Art, March 7 to April 11, entitled "The House I Want."

Sponsorship of the lectures on Architecture and Related Subjects and Problems is by the San Francisco Museum of Art and the Northern California Chapter of the American Institute of Architects.

The December issue of the Washington State Chapter did not carry on with the November issue's item, "Favorite Stories Modernized," which is a pity. But they substituted an account of a debate on the subject of the Columbia Valley Authority, one of those numerous Authorities that the press has had so much to say about recently, and

(See Page 34)



QUIET! ACTION! CAMERA!

In this laboratory, all UTILITY fan and blower designs are tested...to determine the intensity and frequency of sound waves produced. This ingenious equipment shows both the volume and pitch of sound at varying speeds...so that air coolers, forced air furnaces and fans can be operated with minimum noise. From these tests, UTILITY engineers have an accurate "picture" of the sound of air in action, for use in their development of UTILITY'S correctly designed and efficient products.



UTILITY APPLIANCE CORP.

Formerly Utility Fan Corporation

4851 S. Alameda St., Los Angeles 11, California

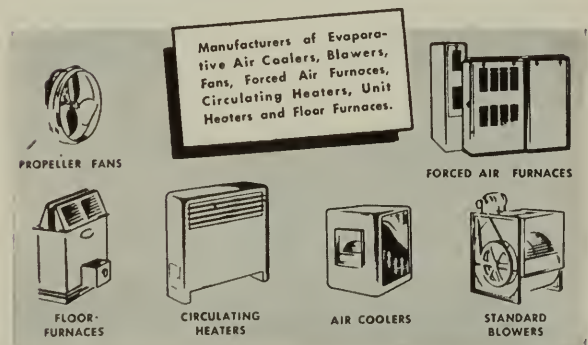

WITH THE ENGINEERS

Structural Engineers Association of
Northern California

W. Adrian, President; William W. Moore, Vice-
President; Franklin P. Ulrich, Sec.-Treas.; John A.
Blume, Ass't. Sec.-Treas.; Offices 214 Old Mint
Building, San Francisco, Phone GARfield 3890. DI-
RECTORS, H. M. Engle, Mark Falk, and M. V.
Pregnoff.

American Society of Civil Engineers
San Francisco Section

George D. Whittle, President; Theodore P. Dressler,
Jr., and Sidney T. Harding, Vice-Presidents; John E.
Rinne, Secretary-Treasurer; 225 Bush Street, San
Francisco 20.

ELECTED HONORARY MEMBER AMERICAN SOCIETY OF CIVIL ENGINEERS



CHARLES H. PURCELL

Another high honor has been bestowed upon C. H. Purcell, Director of Public Works, by the engineering profession. At its annual meeting in New York, January 14 and 15, the American Society of Civil Engineers elected Mr. Purcell an honorary member of the society.

Mr. Purcell, who has been a member of the society since 1916, was unable to attend the convention because of the press of official duties in Sacramento. In 1944, the George S. Bartlett award for outstanding contributions to highway progress was given to Mr. Purcell.

Mr. Purcell came to California as State Highway Engineer in 1928. After 15 years of service as State Highway Engineer he was appointed Director of Public Works by Governor Earl Warren on Janu-

ary 5, 1943. Prior to coming to Sacramento, he was District Engineer for the Public Roads Administration in Portland, Oregon. The district included the States of Oregon, Washington, Idaho, Montana and the Territory of Alaska.

In addition to his many duties as State Highway Engineer, he became Chief Engineer in 1933 of the \$75,000,000 San Francisco-Oakland Bay Bridge. In 1941 the President of the United States appointed him a member of the Interregional Highway Committee.

Mr. Purcell served as President of the American Association of State Highway Officials in 1938. He holds honorary degrees of Doctor of Laws from the University of California and Doctor of Engineering from the University of Nebraska.

The regular meeting of the Structural Engineers Association of Northern California was held Monday Evening January 7 at 6:15 P. M. at the Engineers Club. After the brief ceremony of inaugurating the newly elected president, Mr. W. Adrian, by past president "BUZ" Wright, the meeting was devoted to a talk on the "Problems of the City Engineer," a subject title to which the speaker raised some slight exceptions, the speaker being Mr. Ralph Wadsworth, City Engineer for San Francisco. Much of his talk was illustrated with lantern slides which added materially to his particularly succinct and well delivered talk. It is a pity that all of the residents of the city could not have heard it, for the pithy comments coupled with the pictures gave a clear idea of many puzzling situations in the city.

Among the many problems with which Mr. Wadsworth is confronted he dwelt upon transportation, free-ways, water supply, sewers, slides, and city planning. As an example of one of the things that did not turn out as had been expected, Mr. Wadsworth showed a picture of a structure, which picture the engineering department thought was just too pretty for words. The picture and the project were submitted to the San Francisco Art Commission for approval. The Commission disapproved the solution of the project. They had no jurisdiction over the picture.

On January 10 Mr. L. W. Delhi, President of the California Metal Trades Association, presided at a lunch given to members of the press at the Palace Hotel. Mr. Delhi is a clear, outspoken talker who calls a spade a spade and he gave a lucid presentation of labor in some of the strike situations. There was a large attendance of press representatives, most of whom presented pertinent questions and comments. It was the kind of a meeting that leads to a better understanding.

RALPH G. WADSWORTH, City Engineer of San Francisco, and past president of the American Society of Civil Engineers, spoke before members of the Structural Engineers Association of Northern California recently on the subject: "Engineering Problems of the City of San Francisco." He predicted postwar San Francisco will be faced with many problems requiring the highest engineering talent for satisfactory solution.

CIVIL ENGINEERS HONOR THREE MEMBERS

During the 93rd Annual meeting of the American Society of Civil Engineers, recently held in New York City, honorary memberships were conferred upon Charles F. Kettering, Vice-President of General Motors, Dr. Boris A. Bakhmeteff, professor of civil engineering at Columbia University, and Charles H. Purcell, Director of Public Works for the State of California.

John C. Stevens, Portland, Oregon, President of the Society presided at the meeting which was attended by an estimated 2,000 of the more than 20,000 members, representing 64 sectional societies throughout the country.

HEADS CIVIL ENGINEERS

W. W. Horner, St. Louis consulting engineer, has been elected president of the American Society of Civil Engineers for 1946.

Vice-presidents elected were Arthur W. Harrington, U. S. Geological Survey district engineer, Albany, N. Y.; and J. T. L. McNew, vice-president for engineering of the Agricultural and Mechanical College of Texas.

Directors included Shortridge Hardesty, New York City consulting engineer; Irving V. A. Huie, commissioner New York City Board of Water Supply; Albert Haertlein, professor of civil engineering, Harvard University; William R. Glidden, bridge engineer Virginia State Highway department; William McKinney Piatt, Durham, N. C.; and Frederick W. Panhorst, bridge engineer, State Division of highways, State of California.

L. H. NISHKIAN has been elected second vice-president of the A. S. C. E. and in two years should be its president.

NEW RECLAMATION DISTRICT

The U. S. Bureau of Reclamation, through Commissioner Michael W. Straus, has announced the establishment of the Sacramento Valley District, embracing an area in California from Knights Landing to Shasta Dam.

James K. Carr, member American Society of Civil Engineers, has been appointed district engineer and will establish headquarters at Chico, California.



"...built-in telephone outlets add real value to a home"



EVEN if only one telephone is needed immediately, it's a wise economy to plan ahead for other outlets. Conduit is inexpensive to install during building...and built-in telephone facilities add

real value to a home.

Future telephones can be added without tearing up flooring or bringing wires in along baseboards.



Your clients will appreciate

your foresight in planning with an eye to future needs. Our Architects' and Builders' Service will help you in every way possible at no cost.



The Pacific Telephone and Telegraph Company



A. I. A. ACTIVITIES

(From Page 31)

gave us a fair picture of what transpired. It was so good that we quote it partially verbatim because much of it will apply to our own problem in California.

"If you missed this you really missed a dippy of a discussion. Our Mr. Talbot Wegg was the referee and umpire or what-have-you. And Mr. Jack Cluck, Seattle Attorney, who represented the utilities of the district, was first at bat, and he let loose with both barrels outlining in a broad and general way the pro's of the situation, and when his allotted time was up we were all convinced that he was right and that the other side wouldn't have a leg to stand on. However, we soon found out, to our delight, that this was a two-sided question; for Mr. Thomas Hill came to the plate to swing for his side. And brother, did he swing! In fact, he connected several times when we didn't expect it. Mr. Hill has worked with the U. S. Bureau of Reclamation for years and brought up many good points about having to create so many new bureaus when the old ones were still making progress. When he got going on the fact that the setting up of an authority of this type was not a democratic idea, but just what we had been fighting against . . . then we were positive that Mr. Cluck would have to do

some tall clucking to convince us of anything from now on.

"Mr. Cluck was not through with his opponent; for he had worked up some steam by now and started flinging questions at Mr. Hill so fast that it looked like the end of the con's. Our Mr. Wegg had to duck several times as Mr. Cluck tossed a few eggs too close for comfort. When the referee got the contestants untangled it looked as though Mr. Hill was down and out for the count, but he swung back with some haymakers that really hurt. Mr. Cluck didn't seem to be even dazed and retorted to the questions thrown at him with some very good sportsmanship. All in all, the debate was a huge success and it looked like a victory for—well, you draw your own conclusions for we have given you all of the details of the encounter verbatim just as we heard them.

"We did not mention that the question was thrown to an open forum and some of the boys tried to get to the home plate, but could complete no home runs, because the bases were loaded by our debaters. When the game was called, Mr. Hill and Mr. Cluck were agreed on one point—and that was—we should read the bill so that we would understand all of the details that they discussed. And may we add, perhaps it would be good if our guests of the evening would read the proposed bill again—just to refresh their memories as to just what subject they were discussing."

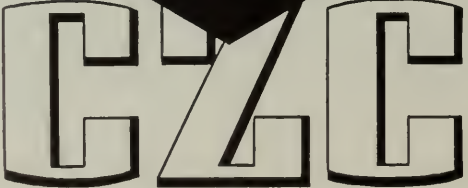
PRESSURE TREATED LUMBER
● **PROTECTS AGAINST DECAY**
AND TERMITE ATTACK

Specify it in your home
Available through Lumber Dealers

LOS ANGELES 601 W. 5th Street Phone MIchigan 6294	SAN FRANCISCO 333 Montgomery Street Phone DOuglas 3883
---	--

J. H. Baxter & Co.

AGENTS FOR WEST COAST WOOD PRESERVING CO. SEATTLE, WASH

ARCHITECTURAL EXTENSION COURSES

Evening extension courses in architectural fields are offered by the University of California Extension on the Los Angeles campus, under the direction of Dr. L. M. K. Boelter, Dean of the College of Engineering.

The new training program is endorsed by the Southern California Chapter of the American Institute of Architects, and will include such subjects as: engineering drawing, architectural drawing, architectural model making, planting and design, and structural engineering design.

NEW DATA ON BUILDING LOADS

A new American Standard giving designers data on the loads a building can carry with safety has just been approved by the American Standards Association.

Factors such as strength of floors and walls in factories, office buildings, and theatres to prevent their collapsing when occupied by machinery, desks or enthusiastic audiences; wind pressures, earthquake shocks, and winter snows are covered in the work.

The standard was developed by a widely representative committee in the building field.

IN THE NEWS

TESTING COMPANY

Operations of the U. S. Testing Company, Inc., have begun in the Rube Hoffman Company plant in Los Angeles, California.

A control testing and research laboratory will make certain the material converted by Hoffman California Fabrics maintains a certain quality.

JOHNS-MANVILLE

Personnel changes at the San Francisco offices of Johns-Manville recently include: Ervin H. Clausen, C. E., has resumed his duties as manager of the San Francisco District which includes Northern California, Nevada, Idaho, Utah and Hawaiian Islands, following military service; W. A. Deal, appointed assistant district manager; T. S. Tulien, appointed Pacific Coast staff manager, Industrial Department; M. E. Sweeney, appointed Pacific Coast Staff Manager, Building Materials Department; and L. W. Richardson, acting New England Regional Manager, has been named Pacific Regional Manager, Contract Building Materials Section.

STARS SHINE BRIGHTER

Tiny rods of "LUCITE" methyl methacrylate resin recently installed in the new rock-board ceiling of the celestial panorama of the winter heavens, world's largest mural in the main concourse of Grand Central Terminal, New York, cause the "stars" to sparkle with new and greater clarity, engineers report.

Fabricated pieces of the transparent plastic, resembling an enlarged golf tee, are used to give 60 of the brighter stars their relative celestial magnitudes when seen from any point on the station floor, 118 feet below.

It is estimated some 750,000 persons pass beneath this mural daily.

JOINS ADVERTISING AGENCY

Eugene W. Shafer has joined the San Francisco staff of WANK & WANK, Advertising Counselors, and will have charge of industrial and marketing, a field in which he is a recognized authority.

Shafer was founder of and managed the San Francisco office of the McCarty Company for ten years, entering the advertising field in 1929 from the sales division of the Pomona Pump Company.

During the War he was connected with the Navy Department.



THE QUESTION BEFORE THE HOUSE

TOMORROW'S HOME will demand more electrical conveniences—an ever expanding list of new electrical appliances and improved home lighting.

Only through adequate wiring can electrical service be used to any desired extent with satisfactory, uninterrupted and economical operation.

Therefore, the question before building any house must be, "Is completely adequate wiring specified in the plans?"

Only by foreseeing the need for electrical adequacy and by providing for it in your specifications, can you be assured of thoroughly satisfied clients.

The home that is adequately wired for all present and future needs is sure to be modern for years to come, and will be worthy of your reputation as an architect.

NORTHERN CALIFORNIA ELECTRICAL BUREAU

1355 MARKET STREET
San Francisco 3, California

*Be sure you're getting the
finest window glass obtainable*

it costs no more to specify

PENNVERNON

Distributed by...

W. P. FULLER & CO.

PAINTS • GLASS • WALLPAPER

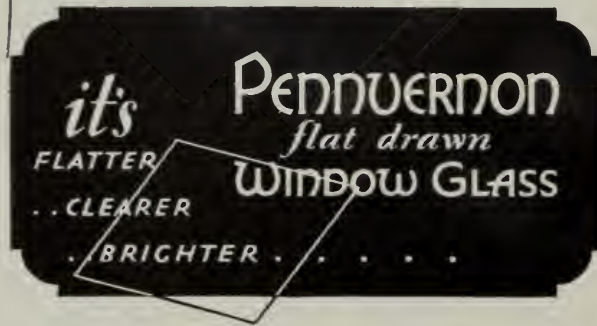

"GOODS OF THE WOODS"



E. K. WOOD LUMBER COMPANY

LOS ANGELES

SAN FRANCISCO

OAKLAND

WE MANUFACTURE OR SUPPLY

DOUGLAS FIR
REDWOOD
SUGAR PINE
PONDEROSA PINE
SASH AND DOORS
MILLWORK
MASONITE TEMPERED PRESWOOD
CONCRETE FORM PANELS
CEMENT ASBESTOS BOARD
INSULATION AND
INSULATION BOARD
INSULATION TILE AND PLANK
PLASTER BOARD
FIR-TEX INSULATION PRODUCTS
TRIPLE-SEALED GYPLAP
SISALKRAFT BUILDING PAPER
ROOFING
WOODLIFE WATER REPELLANT
BUILDERS HARDWARE

DEPENDABLE QUALITY

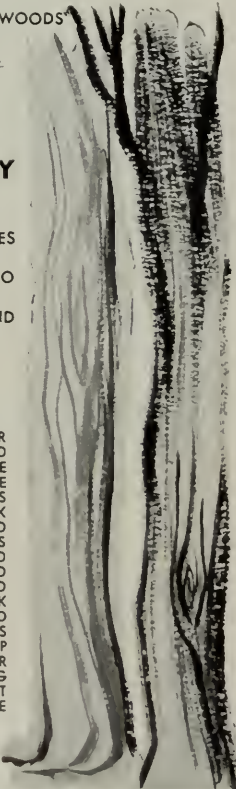

KRAFTILE DISTRIBUTOR OF FAMED "QUONSET"

Stepping out into the forefront of postwar building activities, Kraftile Company, headquartered at Niles, Calif., recently announced its appointment as distributor for Stran-Steel "packaged" steel buildings of the wartime "Quonset" type construction.

In making known the tie-up, C. W. Kraft, president of the large clay products plant, disclosed that the expansion of service is directly in line with his firm's policy to become identified more widely with national construction needs. The distributorship will supplement manufacture of numerous tile products, bricks, ceramic facing, quarry tile, and wall units, as well as the distribution of other building materials.

The "Quonset 40", of forty foot width, is typical of other models of the line, known as the "Quonset 20" and "Quonset 24". A patented nailing groove feature permits the direct nailing of inside and outside covering and building materials to the steel, oval frames. Lengths of buildings can be determined in multiples, to reach any warehousing, storage or working floor space required. Some of the advantages of the war-proved "Quonset" design are materials of fire-resistant steel which eliminate the ravages of termites and rot. The construction prevents sagging and warping.

Immediately available according to Mr. Kraft's announcement, the units provide warehousing or farm buildings at an approximate price of \$.80 per square foot, with erection costs additional at an estimated twenty-five cents per square foot of floor space, or a total of approximately \$1.35 including concrete slab.

RED CROSS GIVES

Los Angeles Chapter of the American Red Cross recently donated \$60,000 to the Housing Authority of Los Angeles.

The funds to be used for temporary housing for veterans' families.

Wilmington Hall, probably the largest hotel for war workers in America, will be converted into kitchentype apartments accommodating 300 families.

NAHB CHICAGO EXPOSITION

Among outstanding exhibits at the National Association of Home Builders Convention and Exposition in Chicago this month, is a model display of concealing telephone wires in modern home construction.

Architects and prospective home builders are shown the advantage of proper telephone conduit installation in construction.

IN THE NEWS

EXTENSION COURSE

The University Extension, University of California, will conduct a course in "Architectural Drawing—The Working Drawing" on the U. C. L. A. Campus, starting Monday, April 29, 1946. Instructor to be announced later.

LIGHTING EXPOSITION

National attention is developing in the International Lighting Exposition, scheduled for April 25-30 at Chicago.

TWO-WHEELED DOLLY



Long and heavy objects such as the dump-truck body shown below may be transported easily by this new ELWELL-PARKER ELECTRIC COMPANY, Cleveland, Ohio, product.

Made from steel plate it is approximately 15 feet long, 3 feet high, and 6 feet wide.

PADGETT IN SEATTLE

Robert C. Padgett, Jr., district representative of the General Electric Company, Portland, Oregon, has been appointed manager of appliance sales for the Company's Seattle, Washington office.

Padgett joined the Company in 1936, but has spent the past three years in the Armed forces.

OPENS OFFICE

An office for the general practice of architecture has been opened by Frederick B. Barss, Architect, in the Hansford Building, San Francisco, California.

*Better, brighter
illumination*
WITH THE
"MASTER"

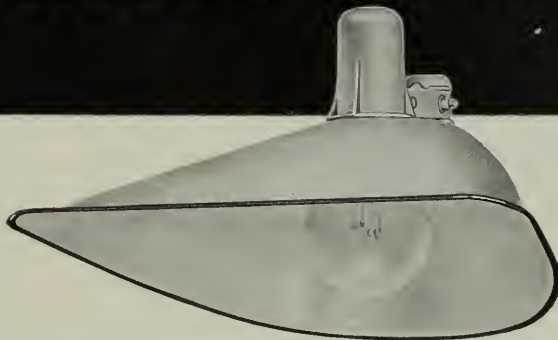

A highly efficient floodlight for use in service stations, parking lots, yards and other areas where maximum spread of light is desired. Finished in porcelain enamel, with neutral gray exterior. Supplied with mountings for wood cross-arms, 1" to 1½" pipe cross-arm or slip-over 1½" pipe mast. Takes 750/1000/1500 W. lamp.



Offices in Principal Western Cities—Branch and Warehouse in San Francisco

PRODUCERS' COUNCIL PAGE

Northern California Chapter

The National Organization of Manufacturers of Quality Building Materials and Equipment

Affiliated with the AMERICAN INSTITUTE OF ARCHITECTS

Dick Fuite returns to the chapter after an absence of several years dating back to the time when the Columbia Steel Company, with which

Dick was then associated, held membership. As local representative for the Hoffman Specialty Company he lost no time in joining up with the old gang again.



R. J. FUITE

Dick who weighed only 140 lbs. soaking wet, at that time. "Soaking wet" is used advisedly as he went out instead for something "mild" like the swimming team and water polo.

Dick's trail to San Francisco lead by way of Chicago and Seattle in a Model "A" Ford as District Representative for A. M. Byers Company in 1930.

He is married, no children, and lives in San Francisco. Other organizations are American Society of Heating and Ventilating Engineers, Society of American Military Engineers and Plumbing and Heating Club. His favorite sport is golf.

HERE THEY ARE, new officers for 1946: President, Ed. Cathcart, Johns-Manville Sales Corporation; Vice-President, Nick Nicholas, Bastian-Morley Company; Secretary, Herb Galitz, Westinghouse Electric Corporation; Treasurer, Ernie Larson, Celotex Corporation.

The Nominating Committee feels they have done themselves proud and the membership backed their judgment 100 per cent at the Annual Meeting held the evening of January 7th.

MODULAR MOMENTS

Question: What happens on a high-priced city frontage when the measurement from building line to building line is not divisible by 4 inches and the complete frontage must be used?

Mr. Lorimer: The procedure is generally to work equally in 4-inch multiples on either side of the lot center-line until the edge differential is established. This differential must obviously be less than 4 inches and is achieved by special cutting or detailing. This is no new penalty as the condition has always existed in meeting fractional dimensions, and it should be noted that even in such lot conditions, the benefits of coordination and standard products are applicable in 99 per cent of the wall.



President ED. CATHCART

A NEW DRESS for the Page at the start of our fourth year. Reports from the "Architect and Engineer" indicate many inquiries regarding the chapter and where the officers may be contacted. So here they are:



COMMITTEE ASSIGNMENTS

Program: Chairman, Nick Nicholas, Bastian-Morley Co.; Wm. Collier, Leo J. Meyberg; Paul Hershey, Armstrong Cork Co.; G. McMurdo, Crane Co. **Membership and Attendance:** Chairman, Harry Fabris, Josam Pacific Co.; Russ Feurst, Sisalkraft Co.; L. S. Barry, General Electric Co.; Ward Shafer, Pacific Gas & Electric Co. **Fellowship:** Chairman, Joe Carlson, Kraftite Co.; Frank Nugent, Certain-Teed Products Corp.; Clarence Berry, Mueller Brass Co.; "Scho" Scofield, Libbey-Owens-Ford Glass Co. **Public Relations and Technical Information:** Chairman, Ray Brown, Gladding, McBean & Co.; George Quamby, Detroit Steel Products; Ken Pinney, Armstrong Cork Co.; Vic Anderson, Otis Elevator Co.; and Chuck Kraft, Kraftite Co., who will continue to edit the PC "Page." **Building Industry Conference Board:** Representative, Past-President George Quamby; Alternate, Ken Pinney (Ken is serving this year as Vice-Chairman of the B.I.C.B.). **San Francisco Planning and Housing Assn.:** Representative, Clarence Berry. **Advisory Board:** President Ed Cathcart and Past-Presidents George Quamby, Ray Brown, and Chuck Kraft.

USE QUALITY PRODUCTS CONSULT AN ARCHITECT



IN THE NEWS

DELHI JOINS

HUNT, MIRK and COMPANY

Lee W. Delhi, nationally known welding engineer and shipbuilder, has become a member of the pioneer engineering and contracting firm of Hunt, Mirk and Company with headquarters at 141 Second Street, San Francisco.

Announcement of Mr. Delhi's new affiliation was made by Thomas J. Benney, senior member of Hunt, Mirk and Company, who said Mr. Delhi will strengthen the financial position as well as expediate the company's postwar expansion program, which will cover general contracting as well as specialized welding in order to offer a complete and integrated engineering contract service.

Mr. Delhi is president of the California Metal Trades Association, a national director of the American Welding Society, and has served two terms as Pacific Coast Region vice president of the organization.

Prior to his new affiliation, he served twenty-two years with the Western Pipe and Steel Company.

Hunt, Mirk and Company was founded in 1903 and has been active continuously in the engineering and construction of steam power plants, marine engineering and steam distribution systems, electrical construction and hydro-electric installations.

SOUNDS HOUSING KEYNOTE

Theodore Criley, A. I. A., Evald C. Moller, president State Building Contractors Association, and Robert D. Jones, Libbey-Owens-Ford Glass Company field representative, speaking on the Citizens Forum in Los Angeles recently, all agreed that "The housing shortage today can see no immediate relief until the labor and material problems are solved".

It was the fifth of a regularly scheduled "Home Builders Clinic" sponsored by the Citizens National Bank of Los Angeles.

SATISFACTORY SALES

Lawrence Ottinger, president of the United States Plywood Corporation, recently reported to stockholders that despite West Coast strikes his firm anticipates a satisfactory volume of sales and profits for the fiscal year ending April 30, 1946.

Production of the Peninsula Plywood Corporation, Port Angeles, Washington, will go one-half to U. S. Plywood in 1946, and entirely thereafter.

FORORDERER CORNICE WORKS

Manufacturers of

Hollow Metal Products • Interior Metal Trim
Elevator Fronts and Cabs
Metal Plaster Accessories • Sanitary Metal Base
Flat and Roll Metal Screens
Metal Cabinets • Commercial Refrigerators

269 POTRERO AVE.

SAN FRANCISCO, CALIF.

HEMLOCK 4100

STRUCTURAL STEEL

For Class A Buildings,
Bridges, etc.

JUDSON PACIFIC - MURPHY CORP.

1200 SEVENTEENTH STREET
SAN FRANCISCO

Plants: San Francisco - Oakland

SISALKRAFT

REG. U. S. PAT. OFF.

"More than a building paper"

THE SISALKRAFT CO.

205 West Wacker Drive
Chicago, Ill.

55 New Montgomery Street
San Francisco, Calif.

BASALITE

LIGHTWEIGHT CONCRETE
BUILDING UNITS

CHARACTER • ECONOMY • INSULATION
FIRE-SAFE • TERMITE PROOF • PERMANENCE

BASALT ROCK CO., INC.

NAPA, CALIFORNIA

NEWS AND COMMENT ON ART

(From Page 8)

Saturday from 2 to 4 P. M., under the direction of Rex Mason.

Lt. Commdr. Thomas Carr Howe, Jr., USNR, Director-on-leave of the California Palace of the Legion of Honor, in San Francisco, has been appointed Acting Chief of the Monuments Fine Arts and Archives Section, Headquarters U. S. Forces, European Theatre, at Frankfurt, Germany, according to word just received at the museum here.

The Military Government's Weekly Information Bulletin recently published an article by Lt. Commdr. Howe, entitled "Back from the Salt Mines," describing the work of evacuating art treasurers from the Alt Ausse salt mine, where the Germans had "collected" them from every occupied country.

EXHIBITION OF PHOTOGRAPHS

Sponsored by the AMERICAN INSTITUTE OF ARCHITECTS, San Francisco Chapter, and the SWEDISH CLUB OF SAN FRANCISCO, an exhibition of photographs of several hundred projects in Sweden will be held at the DE YOUNG MUSEUM in Golden Gate Park.

This exhibition should not be missed, because it shows how a people who have the eternal spark surmounts all obstacles in the preservation and continuance of their art.

CONTRACTORS ARCHITECTS ENGINEERS

Use ARCHITECT'S REPORTS to increase business . . . handy individual slips, issued DAILY containing ADVANCE news on construction projects in northern California.

Pertinent data giving name of project, location, architect, and proposed cost.

Total Cost \$10 per Month

ARCHITECT'S REPORTS

Published Daily by

ARCHITECT and ENGINEER, Inc.

68 Post Street, San Francisco

EXbrook 7182

THE MILLS COLLEGE ART GALLERY will hold an exhibition of French Masterprints from February 13 to March 10. These will be Masterprints of the 19th Century.

NEW CABINET HARDWARE BY THE STANLEY WORKS

Intended primarily for cabinets in kitchens, a new line of postwar cabinet hardware has been announced by THE STANLEY WORKS of New Britain, Conn.

Two nationally noted industrial designers were employed to style the items which have a general application throughout the home, and combine functional efficiency with beauty, durability, and easy installation.



Before the items were approved for production they were submitted to a representative group of people all over the United States for criticism and suggestions. Only those styles which met with general approval were accepted for production, thus the Company has a style-approved line of cabinet hardware.

Included are five Latch-Sets made of pressure cast rust-proof alloy finished in extra heavy chromium plate, with jewel-like plastic thumb pieces in popular colors. The latch mechanism is a self adjusting feature exclusive with STANLEY. Each set has a matching Pull for drawers or doors and may be used with the famous STANLEY No. 33 friction catch which has been popular for years.

There are also five modern designs of knob pulls and a complete line of cabinet hinges. Each item is packed in an illustrated envelope complete with all necessary parts, screws and instructions for applying.

ESTIMATOR'S GUIDE

BUILDING AND CONSTRUCTION MATERIALS

PRICES GIVEN ARE FIGURING PRICES AND ARE MADE UP FROM AVERAGE QUOTATIONS FURNISHED BY MATERIAL HOUSES TO SAN FRANCISCO CONTRACTORS. 2½% SALES TAX ON ALL MATERIALS BUT NOT LABOR

All prices and wages quoted are for San Francisco and the Bay District. There may be slight fluctuation of prices in the interior and southern part of the state. Freight certificate, at least, must be added in figuring country work.

BONDS—Performance—\$10 per \$1000 of contract. Labor and materials, \$10 per \$1000 of contract.

BRICKWORK—

Common Brick—Per 1M laid—\$50.00 to \$60.00 (according to class of work).

Face Brick—Per 1M laid—\$120 to \$150 (according to class of work.)

Brick Steps—\$1.60 per lin. ft.

Brick Veneer on Frame Bldg.—Approx. \$1.30 per sq. ft.

Common Brick—\$19.00 per M, truckload lots, f.o.b. job.

\$19.00 per M, less than truckload, plus cartage.

Face Brick—\$40 to \$80 per M, truckload lots, delivered.

Cartage—Approx. \$4.00 per M.

BUILDING PAPER—

1 ply per 1000 ft. roll.....	\$3.50
2 ply per 1000 ft. roll.....	5.00
3 ply per 1000 ft. roll.....	6.25
Brownskin, Standard, 500 ft. roll.....	5.00
Sisalkraft, 500 ft. roll.....	5.00
Sash cord com. No. 7.....	\$1.20 per 100 ft.
Sash cord com. No. 8.....	1.50 per 100 ft.
Sash cord spot No. 7.....	1.90 per 100 ft.
Sash cord spot No. 8.....	2.25 per 100 ft.
Sash weights, cast iron, \$50.00 ton.	
Nails, \$3.42 base.	
Sash weights, \$45.00 per ton.	

CONCRETE AGGREGATES—

The following prices net to Contractors unless otherwise shown.

Gravel, all sizes—		
\$1.95 per ton at Bunker; delivered	\$2.50	
	Bunker	Del'd
Top Sand	\$1.90	\$2.50
Concrete Mix	1.90	2.45
Crushed Rock, ¼" to ¾".....	1.90	2.50

Crushed Rock, ¾" to 1½".....	1.90	2.50
Roofing Gravel	2.25	2.80
River Sand	2.00	2.45

Sand—

River Sand	2.00	2.45
Lapis (Nos. 2 & 4).....	2.85	3.15
Olympia (Nos. 1 & 2).....	2.85	3.10
Del Monte White	84c per sack	

Cement—

Common (all brands, paper sacks), carload lots, \$2.42 per bbl. f.o.b. car; delivered \$2.72. Cash discount on carload lots, 10c a bbl., 10th prox.; less than carload lots \$3.20 per bbl. f.o.b. warehouse or delivered.

Cash discount 2% on L.C.L.

Atlas White } 1 to 100 sacks, \$2.50 sack
Calaveras White } warehouse or del.; \$7.65
Medusa White } bbl. carload lots.

Forms labor average \$350 per 1000 sq. feet.

Average cost of concrete in place, 50c per cubic foot, exclusive of forms; \$15.00 per cubic yard. With forms \$1.60 per cubic foot.

DAMP-PROOFING and Waterproofing—

Two-coat work, \$3.50 per square.

Membrane waterproofing—4 layers of saturated felt, \$7.00 per square.

Hot coating work, \$2.50 per square.

Medusa Waterproofing, \$3.50 per lb. San Francisco Warehouse.

Tricocel waterproofing.

(See representative.)

ELECTRIC WIRING—\$12 to \$15 per outlet for conduit work (including switches).

Knob and tube average \$3.00 per outlet. (Available only for priority work.)

ELEVATORS—

Prices vary according to capacity, speed and type. Consult elevator companies. Average cost of installing a slow speed automatic passenger elevator in small four story apartment building, including entrance doors, about \$6500.00.

EXCAVATION—

Sand, 60 cents; clay or shale \$1 per yard.

Trucks, \$20 to \$32 per day.

Above figures are an average without water. Steam shovel work in large quantities, less; hard material, such as rock, will run considerably more.

FIRE ESCAPES—

Ten-foot galvanized iron balcony, with stairs, \$150 installed on new buildings; \$160 on old buildings.

FLOORS—

Composition Floors, such as Magnesite, 50c per square foot.

Linoflor—2 gages—\$1.25 to \$2.75 per sq. yd.

Mastopave—90c to \$1.50 per sq. yd.

Battleship Linoleum—available to Army and Navy only—¼" —\$1.75 sq. yd. ⅜" —\$2.00 sq. yd.

Terazzo Floors—50c to 70c per sq. ft.

Terazzo Steps—\$1.75 per lin. ft.

Mastic Wear Coat—according to type—20c to 35c.

Hardwood Flooring—

Standard Mill grades not available.

Victory Oak—T & G

⅜" x 2¼".....\$143.25 per M. plus Cartage

½" x 2"..... 122.00 per M. plus Cartage

½" x 1½"..... 113.50 per M. plus Cartage

Prefinished Standard & Better Oak Flooring

⅜" x 3¼".....\$180.00 per M. plus Cartage

½" x 2½"..... 160.50 per M. plus Cartage

Maple Flooring

⅜" T & G Clear \$160.50 per M. plus Ctg.

2nd 153.50 per M. plus Ctg.

3rd 131.25 per M. plus Ctg.

Floor Layers' Wage, \$1.50 per hr.

GLASS—

Single Strength Window Glass.....20c per □ ft

Double Strength Window Glass.....30c per □ ft.

Plate Glass, under 75 sq. ft.....\$1.00 per □ ft.

Polished Wire Plate Glass..... 1.40 per □ ft.

Rgh. Wire Glass..... .34 per □ ft.

Obscure Glass..... .27 per □ ft.

Glazing of above is additional.

Glass Blocks.....\$2.50 per □ ft. set in place

HEATING—

Average, \$1.90 per sq. ft. of radiation, according to conditions.

Warm air (gravity) average \$48 per register.

Forced air, average \$68 per register.

IRON—Cost of ornamental iron, cast iron, etc., depends on design.

LUMBER—All lumber at O.P.A. ceiling prices—

No. 1 Common	\$49.00 per M
No. 2 Common	47.75 per M
Select O. P. Common	52.75 per M

Flooring—

	Delvd.	
V.G.-D.F. B & Btr. 1 x 4 T & G Flooring	\$80.00
C 1 x 4 T & G Flooring	75.00
D 1 x 4 T & G Flooring	65.00
D.F.-S.G. B & Btr. 1 x 4 T & G Flooring	61.00
C 1 x 4 T & G Flooring	59.00
D 1 x 4 T & G Flooring	54.00
Rwd. Plastic—"A" grade, medium dry	82.00
"B" grade, medium dry	78.50

Plywood—not available

	Under \$200	Over \$200
"Plycord"— $\frac{3}{8}$ "\$49.50	\$47.55
"Plywall"— $\frac{1}{4}$ "45.15	43.30
3 ply— $2\frac{1}{2}$ — $\frac{1}{4}$ "48.55	46.60
"Plyform"— $\frac{3}{8}$ "—		
Unoil126.50	121.45
Oiled127.90	122.75

Above prices delivered if quantity is sufficient to warrant delivery.

Shingles (Rwd, not available)—

Red Cedar No. 1—\$6.75 per square; No. 2, \$5.75; No. 3, \$4.45.
Average cost to lay shingles, \$3.00 per square.
Cedar Shakes—Tapered: $\frac{1}{2}$ " to $\frac{3}{8}$ " x 25"—\$8.95 per square.
Resawn: $\frac{3}{4}$ " to $1\frac{1}{4}$ " x 25"—\$10.65 per square.
Resawn: $\frac{3}{4}$ " to $1\frac{1}{4}$ " x 25"—\$10.65 per square.
Average cost to lay shakes, \$4.00 per square.

MILLWORK—Standard.

D. F. \$100 per 1000. R. W. Rustic \$100.00 per 1000 (delivered).
Double hung box window frames, average with trim \$6.50 and up, each.
Complete door unit, \$10.00.
Screen doors, \$3.50 each.
Patent screen windows, 25c a sq. ft.
Cases for kitchen pantries seven ft. high, per lineal ft., \$9.00 each.
Dining room cases, \$9.00 per lineal foot.
Rough and finish about 80c per sq. ft.
Labor—Rough carpentry, warehouse heavy framing (average), \$40.00 per M.
For smaller work average, \$40.00 to \$55.00 per 1000.

MARBLE—(See Dealers)

PAINTING—

Two-coat workper yard	50c
Three-coat workper yard	70c
Cold water paintingper yard	10c
Whitewashingper yard	8c

PAINTS—

Two-coat work50c per sq. yd.
Three-coat work70c per sq. yd.
Cold water paintingper yard 10c
Whitewashing8c per sq. yd.
Turpentine	\$1.03 per gal. in drum lots.
	\$1.08 per gal. in 5-gal. containers.
Raw Linseed Oil	—not available.

Boiled Linseed Oil—\$1.38 per gal. in drums. Available only to work with high priority—\$1.48 per gal. in 5-gal. containers.

Use replacement oil—\$1.86 per gal. in 1-gal. containers.

Replacement Oil—\$1.20 per gal. in drums. \$1.30 per gal. in 5-gal. containers.

A deposit of \$6.00 required on all drums.

PATENT CHIMNEYS—

6-inch\$1.20 lineal foot
8-inch1.40 lineal foot
10-inch2.15 lineal foot
12-inch2.75 lineal foot

PLASTER—

Neat wall, per ton delivered in S. F. in paper bags, \$17.60.

PLASTERING (Interior)—

	Yard
3 Coats, metal lath and plaster1.50
Keene cement on metal lath1.80
Ceilings with $\frac{3}{4}$ hot roll channels metal lath (lathed only)1.20
Ceilings with $\frac{3}{4}$ hot roll channels metal lath plastered2.20
Single partition $\frac{3}{4}$ channel lath 1 side (lath only)1.20
Single partition $\frac{3}{4}$ channel lath 2 inches thick plastered3.20
4-inch double partition $\frac{3}{4}$ channel lath 2 sides (lath only)2.20
4-inch double partition $\frac{3}{4}$ channel lath 2 sides plastered3.85
Thermax single partition; 1" channels; $2\frac{1}{4}$ " overall partition width. Plastered both sides3.30
Thermax double partition; 1" channels; $4\frac{3}{4}$ " overall partition width. Plastered both sides4.40
3 coats over 1" Thermax nailed to one side wood studs or joists1.65
3 coats over 1" Thermax suspended to one side wood studs with spring sound isolation clip1.90
Note—Channel lath controlled by limitation orders.	

PLASTERING (Exterior)—

	Yard
2 coats cement finish, brick or concrete wall\$1.00
3 coats cement finish, No. 18 gauge wire mesh2.00
Lime—\$3.00 per bbl. at yard.	
Processed Lime—\$3.10 bbl. at yard.	
Rock or Grip Lath— $\frac{3}{8}$ "—20c per sq. yd.	
$\frac{1}{2}$ "—19c per sq. yd.	

Composition Stucco—\$1.80 to \$2.00 sq. yard (applied).

PLUMBING—

From \$100.00 per fixture up, according to grade, quantity and runs.

ROOFING—

"Standard" tar and gravel, 4 ply	—\$8.00 per sq. for 30 sqs. or over.
Less than 30 sqs.	\$9.50 per sq.
Tile, \$30.00 to \$40.00 per square.	
Redwood Shingles, \$7.50 per square in place.	
$5\frac{1}{2}$ #1-16" Cedar Shingles, $4\frac{1}{2}$ " Exposure\$8.00 square

$5\frac{1}{8}$ x 16"—#1 Cedar Shingles, 5" Exposure\$9.00 square
$4\frac{1}{2}$ #1-24" Royal Shingles, $7\frac{1}{2}$ " Exposure\$9.50 square
Re-coat with Gravel	\$4.00 per sq.
Asbestos Shingles, \$23 to \$28 per sq. laid	
$1\frac{1}{2}$ x 25" Resawn Cedar Shakes, 10" Exposure\$10.50
$3\frac{1}{4}$ x 25" Resawn Cedar Shakes, 10" Exposure11.50
1 x 25" Resawn Cedar Shakes, 10" Exposure12.50
Above prices are for shakes in place.	

SHEET METAL—

Windows—Metal, \$1.75 a sq. ft.
Fire doors (average), including hardware \$2.00 per sq. ft.

SKYLIGHTS—(not glazed)

Copper, 90c sq. ft. (flat).
Galvanized iron, 40c sq. ft. (flat).
Vented hip skylights 60c sq. ft.

STEEL—STRUCTURAL—

\$150 ton (erected), this quotation is an average for comparatively small quantities. Light truss work higher. Plate beams and column work in large quantities \$140 per ton.

STEEL REINFORCING—

\$100 to \$130 ton, set.

STONE—

Granite, average, \$6.50 cu. foot in place.
Sandstone, average Blue, \$4.00. Boise \$3.00 sq. ft. in place.
Indiana Limestone, \$2.80 per sq. ft. in place.

STORE FRONTS (None available).

TILE—

Ceramic Tile Floors—\$1.00 to \$1.25 per sq. ft.
Cove Base—\$1.10 per lin. ft.
Glazed Tile Wainscot—\$1.25 per sq. ft.
Asphalt Tile Floor $\frac{1}{8}$ " & $\frac{3}{16}$ "—\$.18 to \$.35 per sq. ft. Light shades slightly higher.
Cork Tile—\$.40 to \$.75 per sq. ft.
Mosaic Floors—see dealers.
Lino-Tile, \$.35 to \$.75 per sq. ft.

Wall Tile—

Glazed Terra Cotta Wall Units (single faced laid in place—approximate prices:	
2 x 6 x 12\$1.10 sq. ft.
4 x 6 x 121.25 sq. ft.
2 x 8 x 161.20 sq. ft.
4 x 8 x 161.40 sq. ft.

VENETIAN BLINDS—

40c per square foot and up. Installation extra.

WINDOWS—STEEL—

30c per square foot, \$5 for ventilators.

FLUORESCENT LIGHTING FOR TYPICAL HOME SETTINGS

(From Page 6)

Light Is Secret of Color

The average person generally overlooks the importance of light in creating an inviting appearance throughout the home. Actually, the whole effect comes from the color tone of the illumination, for it is the light reflected from a surface that causes the color impression registered in the eye. By changing the color tone of the illumination the whole mood or atmosphere of a room can be changed.

From many unfortunate examples of conspicuous commercial installations consumers have a prejudicial attitude toward fluorescent lighting, but expect wonderful things from it. To get wonderful results, women will have to take lighting seriously. Fluorescent lighting can be a major decorative note in the home; provide the key to modernization, efficiency and usefulness, and can be the theme for individual, charming backgrounds for living.

FEDERAL HOUSING

Franklin D. Richards, Salt Lake City, Utah attorney, has been appointed assistant commissioner, Field Operations, of the Federal Housing Administration.

A newly created position, offices will be maintained in Washington, D. C.

INDUSTRIAL DESIGNER

Walter Dorwin Teague, Industrial Designer of Los Angeles and New York, recently announced the expansion of his firm to include Robert Jordan Harper, and C. Stowe Myers as partners.

In establishing West Coast offices in the Title Guarantee Building, Los Angeles, Mr. Teague formed an additional partnership which includes Eugene W. Gerbereux, James Roper Scales, and Charles M. Richards, Jr.

The two partnerships will continue to operate as a unit under the name of Walter Dorwin Teague.

1945 BUILDING TRADES WAGE SCALES (JOB SITES) NORTHERN CALIFORNIA

Six- and seven-hour day eliminated on all Government Work. A. F. L. - O. P. M. Agreement calls for eight-hour day.

NOTE: Predeterminations by the Department of Labor, as of July 1, 1944 (the wage-freezing date) have not yet been made in all of the counties listed. The wage scales shown are those being paid and in effect mostly by agreement between employees and their union.

CRAFT	San Francisco	Alameda and Contra Costa	Fresno	Marin	Sacramento	San Jose	San Mateo	Vallejo	Stockton
ASBESTOS WORKERS	1.50	1.50	1.25	1.50	1.50	1.25	1.50	1.50	1.25
BRICKLAYERS	1.87 ¹ / ₂	1.87 ¹ / ₂	1.75	1.87 ¹ / ₂	1.75	2.00	1.79-1 ¹ / ₆	1.75	1.50
BRICKLAYERS, HODCARRIERS	1.40	1.40	1.05	1.40	1.05	1.50	1.35	1.50	1.14
CARPENTERS	1.50	1.50	1.25	1.43 ³ / ₄	1.37 ¹ / ₂	1.37 ¹ / ₂	1.43 ³ / ₄	1.50	1.37 ¹ / ₂
CEMENT FINISHERS	1.50	1.50	1.50	1.50	1.50	1.50	1.50	1.50	1.50
ELECTRICIANS	1.70	1.70	1.70	1.70	1.70	1.70	1.70	1.70	1.70
ELEVATOR CONSTRUCTORS	1.75 ¹ / ₂	1.75 ¹ / ₂	1.75 ¹ / ₂	1.75 ¹ / ₂	1.75 ¹ / ₂	1.75 ¹ / ₂	1.75 ¹ / ₂	1.75 ¹ / ₂	1.75 ¹ / ₂
ENGINEERS: MATERIAL HOIST	1.50	1.50	1.25	1.50	1.37 ¹ / ₂	1.62 ¹ / ₂	1.50	1.37 ¹ / ₂	1.25
PILE DRIVER	1.75	1.75	1.60	1.75	1.75	1.75	1.75	1.75	1.75
STRUCTURAL STEEL	1.75	1.75	1.60	1.75	1.75	1.75	1.75	1.75	1.60
GLASS WORKERS	1.40	1.40	1.12 ¹ / ₂	1.40	1.12 ¹ / ₂	1.21	1.40	1.40	1.40
IRONWORKERS: ORNAMENTAL	1.60	1.50	1.60	1.50	1.60	1.31 ¹ / ₄	1.50	1.50	1.50
REINF. RODMEN	1.50	1.50	1.60	1.50	1.50	1.60	1.50	1.50	1.25
STRUCTURAL	1.75	1.75	1.75	1.75	1.75	1.75	1.75	1.75	1.37 ¹ / ₂
LABORERS: BUILDING CONCRETE	1.00	1.00	.90	.87 ¹ / ₂	.95	.90	.93 ³ / ₄	.90	.90
LATHERS	1.00	1.00	.90	.87 ¹ / ₂	.95	.90	.93 ³ / ₄	.95	1.00
MARBLE SETTERS	1.75	1.75	1.50	1.75	1.60	1.75	1.75	1.75	1.75
MOSAIC & TERRAZZO	1.50	1.50	1.50	1.50	1.50	1.50	1.50	1.50	1.50
PAINTERS	1.25	1.25	1.12 ¹ / ₂	1.25	1.15-5 ¹ / ₈	1.12 ¹ / ₂			
PAINTERS	1.50	1.50	1.28-4 ¹ / ₇	1.50	1.43	1.50	1.42-6 ¹ / ₇	1.64-2 ¹ / ₇	1.37 ¹ / ₂
PILEDRIVERS	1.54	1.54	1.54	1.54	1.54	1.54	1.54	1.54	1.54
PLASTERERS	1.75	1.83 ¹ / ₂	1.75	1.75	1.75	2.00	2.00	1.75	1.83-1 ¹ / ₃
PLASTERERS' HODCARRIERS	1.50	1.60	1.40	1.50	1.18 ³ / ₄	1.50	1.75	1.50	1.50
PLUMBERS	1.70	1.70	1.53-1 ¹ / ₈	1.70	1.68 ³ / ₄	1.62 ¹ / ₂	1.70	1.70	1.50
ROOFERS	1.50	1.50	1.25	1.37 ¹ / ₂	1.37 ¹ / ₂	1.37 ¹ / ₂	1.25	1.37 ¹ / ₂	1.37 ¹ / ₂
SHEET METAL WORKERS	1.50	1.50	1.50	1.50	1.50	1.50	1.37 ¹ / ₂	1.50	1.50
SPRINKLER FITTERS	1.58	1.58	1.53-1 ¹ / ₈	1.70	1.68 ³ / ₄	1.62 ¹ / ₂	1.70	1.70	1.50
STEAMFITTERS	1.75	1.75	1.53-1 ¹ / ₈	1.70	1.68 ³ / ₄	1.62 ¹ / ₂	1.50	1.70	1.50
STONESETTERS (MASONS)	1.87 ¹ / ₂	1.87 ¹ / ₂	1.50	1.75	1.75	1.50	1.75	1.75	1.50
TILESETTERS	1.50	1.50	1.37 ¹ / ₂	1.50	1.37 ¹ / ₂	1.50	1.50	1.50	1.37 ¹ / ₂

Prepared and compiled by

CENTRAL CALIFORNIA CHAPTER, ASSOCIATED GENERAL CONTRACTORS OF AMERICA

with the assistance and cooperation of secretaries of General Contractors Associations and Builders Exchanges of Northern California.

CLASSIFIED ADVERTISING

RATE: 8c PER WORD . . . CASH WITH ORDER

MINIMUM \$1.50 (3 Lines)

ARCHITECT'S REPORTS—A valuable advance news service giving building and construction information daily on projects in Northern California. Name, location, architect, proposed cost, etc., on individual slips. Ideal for securing new business leads. Hundreds of items, total monthly cost only \$10. Don't delay, subscribe today. ARCHITECT & ENGINEER, Room 618, 68 Post Street,

San Francisco, California. Phone DOuglas 8311.

ARCHITECTS—A. McF. McSweeney, Architect, Room 927 Hearst Bldg., San Francisco. New offices. Desires catalogs.

PHOTOGRAPHY—Keep a pictorial record of your building, or construction project.

Pictures are of tremendous value to contractors, builders, engineers, architects. For Industrial-Publicity-Aerial photography, see FRED MAE, Room 721-22 Hearst Bldg., San Francisco 3, California.

PRINTING—Printers, bookbinders. See us for commercial printing. Mercury Press, 942 Howard Street, San Francisco.

MALOTT & PETERSON

ROOFING AND FLOORING
CONTRACTORS

20TH AND HARRISON STREETS
SAN FRANCISCO
Phone ATwater 1600

HOGAN LUMBER CO.

Wholesale and Retail

LUMBER

MILL WORK • SASH & DOORS

Office, Mill, Yard and Docks
SECOND AND ALICE STREETS • OAKLAND, CALIF.
Telephone GLencourt 6861

CLINTON CONSTRUCTION CO. OF CALIFORNIA

General Contractors

923 FOLSOM STREET • SAN FRANCISCO
SUtter 3440

SANTA MARIA INN SANTA MARIA, CALIFORNIA

FRANK J. McCOY, General Manager
FERNAND E. PIMENTEL, Manager

On the
Coast
Highway
between
San
Francisco
and
Los
Angeles



American
or
European
Plan
•
Old
English
Tap
Room

BOOK REVIEWS

MAKE YOUR HOME YOUR HOBBY. By Walter J. Coppock. Published by The Antioch Press, Yellow Springs, Ohio. 92 Pages. Paper bound. \$1.50.

Mr. Coppock is a registered Engineer and a Consultant in Home Engineering, a profession which is as refreshing as is his outlook on the many problems involved in building a home. He has had long experience in the work of building houses that are to be actually used as homes, including several for himself and his attack of the problem is clear and logical. He spends little space of the aesthetic considerations but sails right into the practical phases of home building. Under "Principles of Design" he discusses roofs, floors, walls, windows and porches in a clear and logical manner that will give much needed information to anyone in planning a home. The few floor plans and pictures of houses are unusually attractive.

The title of the book is a bit misleading in that it is a sort of instruction book on the use of building blocks and paper models. It is nothing of the sort for it is full of common sense and sound advice. His suggestions for reducing building costs are particularly good.

DATA BOOK FOR CIVIL ENGINEERS — Volume 1—DESIGN. By Elwyn E. Seelye. Published by John Wiley & Sons, Inc., New York 16, N. Y. 417 pages, illustrated, 9 $\frac{3}{8}$ by 11 $\frac{3}{4}$. Price \$7.50.

Adequately to review any important technical book presents many problems but Mr. Seelye's great work not only presents problems for the reviewer but in different classes of desirable technical information that make reviewing almost like writing another book. In the first place, he is a very self confident man who will attempt to analyze the vast amount of valuable data that are brought together under covers in this amazing book. At first one might think that Mr. Seelye has gathered into his seine all professions that need technical data regardless of their professions and compiled this great book for them all, but on closer examination that thought can be ruled out because it will be found that there is more or less of a relation between all the professions that are covered in his book.

Perhaps a survey of the subjects covered will help to clarify this point which, after all, is the stumbling block of this review, if you can call it that. One of the troubles is that so many subjects are covered that the first feeling is that everything but the kitchen stove is in the book but most of the subjects are, never-the-less, related. These are

those subjects, believe it or not, that are masterfully treated . . . 1. General Structural Designing; 2. Concrete Designing; 3. Steel Structural Designs; 4. Wood Structural Design; 5. Plywood Structural Design; 6. Foundations; 7. Soils; 8. Earthwork; 9. Roads, (and here we begin to get into new fields); 10. Bridges; 11. Dams; 12. (and this is for the City Planners, both Engineers and Architects) AIRPORTS; 13. Docks and Piers; 14. Corrosion of Metals, (good for the chemists, too); 15. Athletic Fields (city planning again). Following these fifteen are seven more sections devoted mostly to Drainage, Sewerage, Water Supply and Distribution. Without a five-foot shelf of reference books a Civil Engineer or an Architect could hardly get along these days without this book. This may sound like a rubber stamp phrase of a reviewer, but take another look at the section headings just listed. Perhaps it covers more than five feet.

Allowable working stresses in many tables are not confined to those in any one code but are often listed for New York City, A. I. S. C., A. C. I. and other codes. Throughout the book examples are given, formulae are explained, graphs are shown, plans, elevations, sections and sometimes perspectives are drawn to make everything as clear and definite as possible. The work covers almost everything that is needed to engineer a design except the fundamental knowledge that is acquired in a study course, and much of that is supplied.

There are 37 pages cram full of plans and data on airports with an amazing number of detail drawings. New plans are, of course, coming out daily, but to date those shown in Mr. Seelye's book are the best. The plans of road intersections, grade crossings and overhead crossings, grade and rotary intersections, clover leaves and designs for flexible pavements should be in every city engineer's office. But why go on; "Design, Data Book for Civil Engineers" should be in the files of every architect and City Planner, as well as on the shelves of every Civil Engineer.

TIMBER DESIGN ADOPTED

Army engineers alert to note and take advantage of improved techniques in timber construction, recently issued an order declaring: "Henceforth the design for timber construction for all activities under the jurisdiction of the Chief of Engineers will be based on the criteria set forth in the National Design Specification for Stress-Grade Lumber and Its Fastenings, 1944 . . . recommended by the National Lumber Manufacturers Association, Washington, D. C., except as modified."

Modifications stated current drawings and designs would not be revised where the design stresses were greater or equal to those called for in the Specifications.

"AMERICAN - MARSH"

CONDENSATION UNIT

Pumping
Machinery
for
Every
Purpose

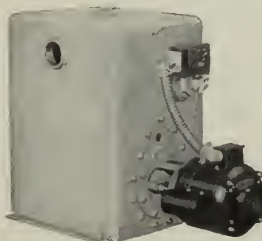

For Service
Call
DOuglas
6794
or
MUtual8322

SIMONDS MACHINERY CO.
SAN FRANCISCO 816 FOLSOM
LOS ANGELES 455 EAST 4TH

VERMONT MARBLE COMPANY

Producers and Finishers
of

Domestic and Imported Marbles

Write for new pamphlet describing our
Marble Toilets and Showers

San Francisco and Los Angeles
San Francisco phone: Sutter 6747



The Most Complete Line of
STEELS and BUILDING MATERIALS
Made by a Single Producer



See Sweet's Catalog File or write us for
full information.

REPUBLIC STEEL CORPORATION
GENERAL OFFICES: CLEVELAND, OHIO

DENVER, COLORADO CONTINENTAL OIL BUILDING
LOS ANGELES, CALIFORNIA EDISON BUILDING
SALT LAKE CITY, UTAH WALKER BANK BUILDING
SAN FRANCISCO, CALIFORNIA RIALTO BUILDING
SEATTLE, WASH. WHITE-HENRY-STUART BUILDING

PACIFIC MANUFACTURING CO.

HIGH CLASS INTERIOR FINISH
QUALITY MILLWORK

142 SANSOME ST., SAN FRANCISCO
Garfield 7755

6820 McKINLEY AVE., LOS ANGELES
THornwall 4196

BUILDERS EXCHANGE, OAKLAND

Real Estate Loans



F. H. A. loans are readily available on existing homes up to 80% of the appraised value. You can buy a home and pay for it in small monthly installments like rent. For example, a 20-year loan of \$4000 would cost about \$33.71 per month, including taxes, insurance, principal and interest.

*Come in and talk with us.
We can help you get the home you want.*

CROCKER FIRST NATIONAL BANK
OF SAN FRANCISCO
California's Oldest National Bank
ONE MONTGOMERY STREET
Member Federal Deposit Insurance Corporation

To bring out and preserve the beauty of Exterior Redwood in its natural color use

Cabots # 230 Clear
OR

to give it an old weathered driftwood grey use

Cabots # 241 Bleaching Oil
OR

to stain or actually dye it in a wide range of colors use

Cabots Creosote Stains

Distributed by

GUNN CARLE and CO.
20 POTRERO AVENUE
SAN FRANCISCO 3
Underhill 5480

IN THE NEWS

MUNICIPAL HOSPITAL

A bond election will be held in Corcoran, California, in April to approve \$70,000 for construction of a Municipal Hospital. David Horn, Fresno, Architect.

STREET LIGHT CONTROL

A new electronic "SUN SWITCH" designed to control street lighting has been announced by the RIPLEY COMPANY, Torrington, Conn.

The unit assures required illumination regardless of fluctuations in weather conditions, and is priced low to permit ample installation for any need.



Under ideal conditions of daylight the control provides a "lights on" period 25 minutes after sunset and 25 minutes before sunrise, with adjustment possible to meet specific light requirement.

BOND ELECTION

Redwood City, California, will hold an election on February 26, 1946 to determine a new grammar school building bond issue of \$600,000.

KYLE FORREST

Civil Engineer

Water Supply — Sanitation

Municipal — Private
Consultations — Investigations
Reports — Designs — Valuations
Supervision — Litigation

Ground Water Work a Specialty

Hydrologic studies — wells, dewatering, underdrainage, foundations, conservation, testimony.

1504 Russ Building
San Francisco 4
YUkon 0652

Swimming Pools of Distinction

Built by technicians with specialized pool construction experience.

Landon Standard Pools

A Northern California Enterprise.

(We have the Background, the Men and the Material)

Telephone 425 Old County Road
Belmont 2312 Belmont, Calif.

JOHN D. McLAUGHLIN

Electrical Engineer Consultant
Electrical Designs

Plans - Specifications
Industrial Power and Lighting Layouts

Airport Lighting Design
Distribution Design

SERVICES FOR
ARCHITECTS AND ENGINEERS

1641 Russ Building
San Francisco, California
Telephone EXbrook 5712

Scott Company

HEATING - - PLUMBING - - TILE



243 MINNA STREET
SAN FRANCISCO
Phone EXbrook 6741

G. P. W.
JENSEN & SON

Building Construction

320 Market Street, San Francisco

Phone: GARfield 2444

JOHN CASSARETTO
COMPANY

—Since 1886—And Still Active—

Building Materials

READY MIX CONCRETE
ROCK - SAND - GRAVEL - LIME
CEMENT - PLASTER - MORTAR
METAL LATH - WOOD LATH
STUCCO - WIRE NETTING

Service Unexcelled

Bunkers

Sixth and Channel, San Francisco

Phones: GARfield 3758 - 3760

MULLEN MFG.
COMPANY

BANK, STORE AND OFFICE
FIXTURES—CABINET WORK
OF GUARANTEED QUALITY
CHURCH SEATING

Office and Factory:

60-80 RAUSCH ST., Bet. 7th and 8th Sts.
San Francisco
Telephone UNDERhill 5815

THE TORMEY
COMPANY

GENERAL PAINTERS
AND DECORATORS

Phone UNDERhill 1913

563 FULTON STREET
San Francisco

IN THE NEWS

U. S. CHAMBER MEET

The 32nd Annual meeting of the Chamber of Commerce of the United States will be held in Atlantic City, April 30 to May 2, according to an announcement by Ralph Bradford, general manager.

It will be the first Annual Meeting since 1943, organization policies and elections have been conducted by mail.

REGAN RESISTOR

A new type CAM center-tap resistor has been developed by the Regan Engineering Company consisting of a core, machined from a solid piece of steatite, upon which is wound a helical resistance wire element.



Center and end taps are half-straps securely clamped to the core, assuring absolute mechanical rigidity independent of support by the resistance element. Brass nuts and bolts and stainless steel lock washers are used, with all parts zinc plated.

This new product is distributed by TECHTMANN INDUSTRIES, Inc., Milwaukee 2, Wis.

INDUSTRIAL GROWTH

Investment of \$83,647,000 in land, buildings and equipment, and representing new employment for some 20,090 workers, is the Los Angeles industrial picture of 1945, according to George J. O'Brien, chairman industrial development committee, Los Angeles chamber of commerce.

The activity represents 228 new factories and 334 factory expansions.

Phone GARfield 1164

Thomas B. Hunter

Consulting Engineer

DESIGNER OF HEATING
AIR CONDITIONING
VENTILATING AND WIRING
SYSTEMS, MECHANICAL
AND ELECTRICAL EQUIP-
MENT OF BUILDINGS

41 SUTTER STREET
ROOM 710

San Francisco

California

ANDERSON
&
RINGROSE

General Contractors

320 Market Street, San Francisco

Phone GARfield 2245

DINWIDDIE
CONSTRUCTION
COMPANY

BUILDERS

CROCKER BUILDING
SAN FRANCISCO



HERRICK
IRON WORKS

STRUCTURAL STEEL
REINFORCING STEEL

18TH AND CAMPBELL STS.
OAKLAND, CALIF.
Phone GLencourt 1767

Independent Iron Works

Structural Steel
Ornamental Iron
Steel Service Stations
Steel Tanks
Standard Steel Mill Buildings
Bridges

821 Pine Street Oakland

George F. Brayer

ELECTRICAL
CONTRACTOR

166 Seventh Street
San Francisco

Phones: KLondike 2-0879
HEmlock 2646

SMITH, EMERY & CO.

Since 1904

Engineers - Chemists

Inspection, Tests, Analyses,
Research, Consultation
Structural Materials, Structures,
Equipment, Pipe, Soils

Associates

Los Angeles and Eastern Cities
Offices and Laboratories
651 Howard Street, San Francisco

A. F. MATTOCK CO.

Builders



212 CLARA STREET
SAN FRANCISCO

Index to Advertisers

ALADDIN Heating Corp.	48
ANDERSON, & Ringrose	47
ANGIER Sales Corporation	*
ARCHITECTS Reports	40
BASALT Rock Company	39
BAXTER & Company, J. H.	34
CASSERETTO, John	47
CLARK, N., & Son	*
CLASSIFIED ADVERTISING	43
CLINTON Construction Company	44
COLUMBIA Steel Co.	*
COLOTYLE Corporation	*
CROCKER First National Bank	46
DINWIDDIE, Construction Company	47
FORORDERER, Cornice Works	39
FORREST, Kyle	46
FULLER, W. P., Co.	36
GUNN, Carle & Company	46
HANKS, Inc., Abbot A.	48
HAWS Drinking Faucet Company	Back Cover
HERRICK Iron Works	47
HOGAN Lumber Company	44
HUNT, Robert W., Company	48
HUNTER, Thos. B.	47
IMPERIAL Brass Manufacturing Co.	*
INDEPENDENT Iron Works	48
JENSEN & Son, G. P. W.	47
JOHNSON, Company, S. T.	*
JUDSON, Pacific-Murphy Corp.	39
KRAFTILE Company	*
KAWNEER Company	*
LONDON Standard Products	46
MALOTT & Peterson	44
MATTOCK, A. F.	48
McLAUGHLIN, John D.	46
MULLEN, Mfg. Co.	47
MUELLER Brass Co.	*
NORTHERN California Electrical Bureau	35
OWENS Corning Fiberglas Co.	*
PACIFIC Coast Gas Association	1
PACIFIC Manufacturing Company	45
PACIFIC Portland Cement Company	Inside Front Cover
PACIFIC Telephone & Telegraph Co.	33
PARAMOUNT Built-in Fixture Co.	*
PARKER, STEFFINS & PEARCE	*
PAYNE Furnace & Supply Co., Inc.	2
PORTLAND Cement Association	*
REMILLARD-Dandini Co.	48
REPUBLIC Steel Corporation	45
SANTA Maria Inn	44
SCOTT Co.	46
SIMONDS Machinery Company	39
SISALKRAFT Company	39
SMITH, Emery & Co.	48
SMOOT-Holman Co.	37
STANLEY Works, Inc., The	*
SOULE Steel Co.	*
TAYLOR Co., Halsey W.	29
TIMBER Engineering Co., Inc.	*
TORMEY Company, The	47
UTILITY Appliance Corp.	31
U. S. STEEL	*
U. S. TREASURY Dept.	Inside Back Cover
VERMONT Marble Company	45
WESIX Electric Heater Co.	*
WESTERN Asbestos Company	*
WOOD, E. K., Lumber Company	36

* Indicates Alternate Months

REMILLARD - DANDINI Co.

Brick and
Masonry Products



633 BRYANT ST., SAN FRANCISCO
569 THIRD ST., OAKLAND

A L A D D I N Heating Corp.

Specializing in

QUALITY HEATING
EQUIPMENT

2222 San Pablo Avenue
OAKLAND
TWinoaks 1022

ABBOT A. HANKS, INC. Engineers & Chemists

INSPECTING - TESTING - CONSULTING
CONCRETE • STEEL • MATERIAL
CHEMICAL AND TESTING
LABORATORIES
• RESEARCH AND INVESTIGATION

TESTS OF STRUCTURAL MATERIALS
DESIGN OF CONCRETE MIXES
SHOP AND ERECTION INSPECTION OF
STRUCTURES AND EQUIPMENT
INVESTIGATIONS OF STRUCTURES
AND MATERIALS
TESTS AND INVESTIGATION OF
FOUNDATION SOILS
FIRE RESISTANCE AND INSULATION
TESTS

624 Sacramento Street, San Francisco

Robert W. Hunt Company ENGINEERS

Inspection - Tests - Consultation

Schools and Other Structures
Are Built as Designed

When Construction Materials are
Inspected at point of Manufacture
and during Erection by

ROBERT W. HUNT COMPANY

Cement, Concrete, Chemical, Metallurgical
X-Ray and Physical Laboratories

Chicago - New York - Pittsburg
Los Angeles - All Large Cities
San Francisco, 251 Kearny Street

ARCHITECT AND ENGINEER



Featuring In This Issue

THE HOUSE I WANT . . .

Based upon Six Lectures on architecture and related subjects presented by the **Women's Architectural League**, sponsored by the **San Francisco Museum of Art**, and the **Northern California Chapter** of the **American Institute of Architects**.

	Page
MODERN LIVING — California Style	8
Gardner A. Dailey, Architect; Thomas D. Church, Landscape Architect, and Maurice Sands, Decorator	
CHOICE OF BUILDING SITE	16
John S. Bolles, Architect, and Raymond D. Smith, Realtor	
PERIOD INFLUENCE IN THE MODERN HOUSE	18
Paul R. Williams, Architect	
THE MODERN HOUSE — Trends	20
Pietro Belluschi, Architect	
CONTEMPORARY DECORATION	22
Frances Elkins, Decorator	
CONTEMPORARY DECORATION — Textiles	24
Dorothy Wright Liebes, Textile Designer	
A GARDEN TO LIVE IN	26
Edward A. Williams, Landscape Architect	
YOUR HOUSE AND THE ARCHITECT	28
William Clement Ambrose, Architect	

MARCH

1946

**The experience of over
4,000 acoustical installations
...is at your service**



*Acousti-Celotex installation — office of the
Western Pacific Railroad Co., San Francisco*



*Sound conditioning increases efficiency at
The Western Union Telegraph Co., Oakland*



*Acousti-Celotex provides quiet in these
offices, Kraft Cheese Co., San Francisco*



*Sound conditioned assembly and motor test
room, Caterpillar Tractor Co., San Leandro*



*Acousti-Celotex sound conditioning, general
office, Fairbanks Morse & Co., San Francisco*



THE great reservoir of our experience, gained in over 4,000 acoustical installations, is daily solving sound conditioning problems in all types of offices and factories.

This practical knowledge is available to you *only* through Western Asbestos Co., for our organization has analyzed, engineered and installed more sound conditioning in this area than any other firm in the acoustical field.

The combination of this experience with the world's most widely proved and used acoustical materials—Acousti-Celotex products—is your complete assurance of a job well done. The counsel and recommendations of a sales engineer are at your service, entirely without obligation.

WESTERN ASBESTOS CO.

DISTRIBUTORS • ENGINEERS • CONTRACTORS

YOUR BLOOD CAN SAVE LIVES—BE A DONOR TODAY!

• ARCHITECT

Vol. 164 No. 3

AND ENGINEER

ARCHITECTS' REPORTS—Published Daily

Telephone DOuglas 8311

E. H. WILDER
Editor

MARK DANIELS, A.I.A.
Associate Editor

JOHN S. BOLLES, A.I.A.
Book Reviews

MICHAEL GOODMAN
Post-War Planning

L. H. NISHKIAN
Consulting Editor

E. N. KIERULFF*
Ass't Editor
*In the Service



Contents for

MARCH

Cover: "THE HOUSE I WANT"—Program

EDITORIAL NOTES	2	THE HOUSE I WANT (Continued)	
DECORATIVE FIBERGLAS	3	"The Modern House Trends," featuring Pietro Belluschi, Architect	20
NEWS AND COMMENT ON ART	4	"Contemporary Decoration," featuring Mrs. Francis Elkins, Decorator	22
THE ERA OF WAR MEMORIALS	6	"Contemporary Decoration—Textiles," featuring Dorothy Wright Liebes, Textile Designer	24
By Thaddeus M. Grabow, Landscape Architect		"A Garden to Live In," featuring Edward A. Williams, Landscape Architect....	26
THE HOUSE I WANT.....	7	"Your House and the Architect," featuring William Clement Ambrose, Architect	28
Introduction by Grace L. McCann Morley, Director San Francisco Museum of Art			
"Modern Living," featuring Gardiner Dailey, Architect	8		
"The House Garden Relationship," featuring Thomas D. Church, Landscape Architect	10	IN THE NEWS	30, 33, 36, 37, 45, 46, 47
"Modern Living, California Style," featuring Maurice Sands, Decorator	12	A.I.A. ACTIVITIES	31
"Architecture Is a Fine Art," featuring John S. Bolles, Architect	14	WITH THE ENGINEERS	32
"Choice of Building Site," featuring Raymond D. Smith, Realtor	16	HEADLINE NEWS AND VIEWS	34
"Period Influence in the Modern Home," featuring Paul R. Williams, Architect	18	By E. H. W.	
		PRODUCERS' COUNCIL PAGE	38
		ESTIMATORS' GUIDE	41
		CLASSIFIED ADVERTISING AND WAGE SCALES	43
		ADVERTISERS' INDEX	48

ARCHITECT AND ENGINEER (Established 1905) is published on the 15th of the month by The Architect and Engineer, Inc., 68 Post St., San Francisco 4; Telephone EXbrook 7182. President, K. P. Kierulff; Vice-President and Manager, L. B. Penhorwood; Treasurer, E. N. Kierulff.

Los Angeles Office: Wentworth F. Green, 1709 West Eighth Street.

Entered as second class matter, November 2, 1905, at the Post Office in San Francisco, California, under the Act of March 3, 1879. Subscriptions United States and Pan America, \$3.00 a year; \$5.00 two years; foreign countries \$5.00 a year; single copy 50c. ARCHITECTS' REPORTS are published daily from this office, Vernon S. Yallop, Manager.



EDITORIAL NOTES

HOUSING AFTER WORLD WAR I

Will History Repeat Itself?

Our history over the past 185 years shows, without exception, wholesale commodity prices have increased rapidly during a war and declined drastically after. Prices rose sharply during World War I for about one and one-half years after.

One of the major drawbacks to a more rigid resumption of peacetime business and construction after World War I was the uncertainty over the future course of commodity prices and construction costs. During World War II we had much greater success in "holding the line." Commodity prices and construction costs have risen substantially but, despite the greater war effort they have advanced far less than in World War I.

Wartime federal controls on commodity prices, production of non-war goods, construction, and localized rent controls were far less effective and were in force for a much shorter time than in World War II.

The first few months after November 1918 presented a deceptive picture. There was no immediate burst of peacetime business activity. Prices were slightly downward.

The domestic and foreign demand which developed early in 1919 found industry and trade generally unprepared and with depleted inventories. There was insufficient time to fill the pipeline of distribution before the rush of postwar construction set in early in 1919. The result was a sudden rise in building material prices and construction costs on top of the substantial wartime increase. Building materials as a group showed the largest price advance among all major commodity groups—72 per cent from April 1919 to April 1920.

Shortages of building materials and labor; a decline in the efficiency of labor; and difficulties in the adjustment to peacetime construction operation are the more notable after World War I. The military and industrial construction program in World War II was largely completed before the end of the war.

*SUMMARY AND CONCLUSIONS OF NATIONAL HOUSING BULLETIN NO. 4 WHICH PRESENTS IN DETAIL THE AFTERMATH OF WORLD WAR I AND ITS REFLECTION IN PRESENT DAY CONDITIONS.—Editor.

The breakdown in transportation and the management-labor strife after World War I hampered successful transition from war to peace.

The short-lived postwar boom of less than a year was followed by a sharp recession which lasted well over a year and caused much loss of production, increased business failures and bank crashes, and widespread unemployment. Much of the same ingredients which sparked the boom of 1919 are present today and in greater force. We have had a larger and longer war, more shortage of civilian goods, and a greater reconversion problem.

The housing shortage was even more of a problem late in 1919 than immediately after the war, because of continued migration from farm to cities, returning servicemen, marriages, and the rapid pick-up in business activities.

Housing demands proved sensitive to price excesses. Residential construction contracts declined after the first half of 1919 while other types of construction continued to increase. This indicates residential builders were unable to compete with commercial and industrial construction in the scramble for scarce materials and labor.

The big general increase in rents came after the war. There was much public resentment of rent "profiteering," and wholesale evictions. Rent strikes were common.

Price confusion retarded the expansion of residential construction by at least 1 and possibly 2 years. It was not until 1922 that the residential construction average for the twenties was reached.

The inflation of construction costs in 1919-20 was only incompletely corrected in the subsequent price collapse. Building material prices in 1920 declined about as much as all commodity wholesale prices but their boom increase from the spring of 1919 to the spring of 1920 had been about three times as high as the general price rise.

This may have been responsible in part for some of the things that characterized the housing boom of the middle and late twenties; over extension of home owners, over extension of credit, and overbuilding of the "luxury" market.

Disproportionate prices and costs may have played a part in the choking off of new residential building after 1925, long before general business prosperity came to an end.



View at left: Interior of radio operations room showing Fiberglas acoustical board on walls and ceiling.

Decorative Fiberglas

Right View:

Incombustible Fiberglas decorative fabrics add glamor and fire-safety to the Iceland Restaurant on New York's famed Broadway. Canopy over bar is white Fiberglas fabric, draperies are white and plum Fiberglas, while the walls are of green Fiberglas.

Kaj Velden Studios, decorator.



NEWS AND COMMENT ON ART

MARCH EXHIBITION SCHEDULE SAN FRANCISCO MUSEUM OF ART

10th ANNUAL PRINT AND DRAWINGS EXHIBITION of THE SAN FRANCISCO ART ASSOCIATION—February 13 to March 10.

PAINTINGS BY EDWARD McNEAR, PRINTS BY HERMA N. WARSAGER, TEMPERAS BY ED GARMAN—February 13 to March 10.

VARIETIES OF ABSTRACT STYLES IN THE SAN FRANCISCO BAY REGION—March 6 to March 31.

POSADA, MEXICAN PRINTMAKER—March 19 to April 14.

TECHNIQUES OF PRINTMAKING AND THE POPULAR PRINT—March 19 to April 14.

MARCH ACTIVITIES

SPRING FLOWER ARRANGEMENT, conducted by HELEN VAN CLEAVE, Wednesdays—March 6 to 27.

FOLK DANCES presented by FOLK DANCE FEDERATION OF AMERICA—March 8 to 29.

THE HOUSE I WANT presented by THE WOMEN'S ARCHITECTURAL LEAGUE—March 2 to April 1.

Six Lectures on ARCHITECTURE and RELATED SUBJECTS—March 2 to April 1.

KNOW YOUR WORLD TRAVEL FILMS—Saturdays and Sundays—2:30 p. m.

FAMOUS FILM SERIES—Tuesdays at 8 p. m.

THE KATE NEAL KINLEY MEMORIAL FELLOWSHIP

The fifteenth annual consideration of candidates for the Kate Neal Kinley Memorial Fellowship has been announced by the Board of Trustees of the University of Illinois.

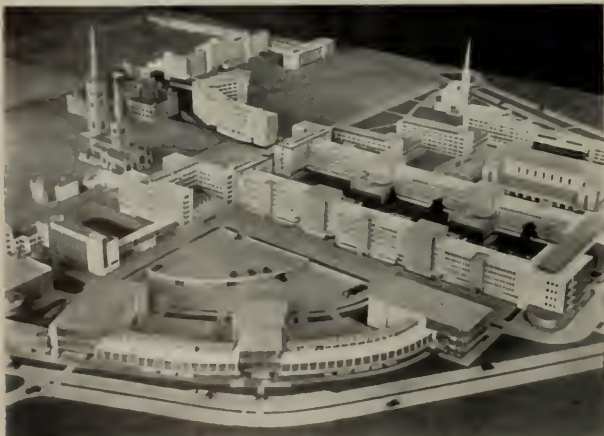

SCALE MODELS form the basis for planning the reconstruction of many war-torn British cities and communities.

The Fellowship is open to graduates of the College of Fine and Applied Arts whose principal studies have been in Music, Art, or Architecture, and yields the sum of \$1000 for a year's advanced study of the Fire Arts in America or abroad.

COMING EVENTS AT THE CALIFORNIA PALACE, LEGION OF HONOR

Dr. Jermayne MacAgy, acting director of the California Palace of the Legion of Honor, has announced the following schedule of exhibitions and special events for March:

EXHIBITIONS

WORK OF EASTMAN JOHNSON, March 1 through 24; WATERCOLORS BY WILLIAM HYDE IRWIN, March 1 through 24; WATERCOLORS BY DE HIRSH MARGULES, March 6 through 24; WARTIME PAINTINGS OF FREE CHINA BY CHANG WEN YUEN, through March 24.

The Alma de Bretteville Spreckels Collection of Sculpture by Auguste Rodin.

The Mildred Anna Williams Collection of Paintings, Sculpture, Tapestries and Furniture.

The Collis Potter Huntington Memorial Collection of 18th Century French Paintings, Sculpture, Tapestries, Furniture and Porcelain.

SPECIAL PROGRAMS

Organ Recital by Uda Waldrop, every Saturday and Sunday, 3:00 p. m. Organ Concert Broadcast at 3:30 p. m., Saturday, Station KSFO.

MOTION PICTURE SERIES (Admission Free)

End Saturday at 2:30 p. m.

THE THIN MAN, Myrna Loy, William Powell; directed by W. S. Van Dyke, 1934 (sound); March 17; MARCH OF TIME NO. 2 (1935) and CAVALCADE, directed by Frank Lloyd, 1933 (sound); March 24; THE LIFE OF EMILE ZOLA, Paul Muni; directed by William Dieterle, 1937 (sound); March 31.

EDUCATIONAL ACTIVITIES

Children's Classes: Session in Painting and Drawing for children of the ages 6 through 8 and 9 through 12. Every Saturday from 10:30 to 11:45 a. m.

Class for Adults: Painting class for adults every Saturday from 2 to 4 p. m., under the direction of Rex Mason.

CHILDREN'S CLASSES EXPANDED

Four instructors have been added to the California School of Fine Arts staff in San Francisco, in conjunction with an expanded children's program.

Virginia Roberts Templeman will teach Paint-

NEWS AND COMMENT ON ART

ing and Drawing to children of grammar and high school age; Ruth Cravath Wakefield will teach Drawing and Sculpture; a children's workshop will be conducted by David Park; and Marie Hiatt will supervise a special class for children of pre-school age.

FIRST SPRING ANNUAL EXHIBITION CALIFORNIA PALACE OF LEGION OF HONOR

The Jury of Selection for this event will meet March 19, 20 and 21, to choose the works that will be eligible to compete for the cash prizes totaling \$2,000, and for other awards offered in this Western event which is open to the public, April 3 to 30.

The jury includes Donald Bear, Director, Santa Barbara Museum of Art; Alfred Frankenstein, arts critic of the San Francisco Chronicle; and Reginald Poland, Director, Fine Arts Gallery of San Diego.

ART SCHOOL'S NEW COURSE IS THE MODERN DANCE

A departure from the usual courses of the visual arts in the form of an experimental course in The Modern Dance, has been added to the curriculum of the California School of Fine Arts, San Francisco.

In the nature of a theatre workshop the course is being offered primarily for those enrolled in other classes in the school.

Students will have an opportunity to work in terms of motion and time as well as in the visual arts, and will design their own choreography and sets.

Under the direction of Margery Schneider Dorian, well-known teacher and dancer, classes are being held every Friday afternoon.

ART SCHOOL ESTABLISHES DEPARTMENT OF PHOTOGRAPHY

Ten thousand dollars has been granted to the San Francisco Art Association by the Columbia Foundation for the establishment of a Department of Photography at the California School of Fine Arts, which will be opened on June 24 under supervision of Ansel Adams.

The art school is concerned primarily with giving technical training to those entering the professional field of photography.

CHANGING FADS IN HOME DECORATING

Looking back over the past half century it is amazing how many fads and fancies have appeared in home decoration.

Fifty years ago the "plush age" was at its height. Bulky plush furniture, often in strange colors, adorned the parlors of some pretentious homes. About forty years ago chestnut trim became popular, especially in medium sized homes, causing somber wall paper and draperies to be in vogue. This was followed by what has been called the "Taupe Age." Furniture, draperies and other accessories were in a monotonous yellowish gray color. (The word taupe, according to Webster, means a mole—the little dirty yellow animal that hates the light and burrows in the ground.) At this time the terrible "oatmeal" papers were used extensively for walls.

Then came the monotone period, which still lingers. Fatigued by the colorless taupe, many women replaced the taupe in their homes with weakly colored plain rugs, plain draperies, plain walls. The monotone effect of such decoration is fatiguing, boring and monotonous.

Now there seems to be a very definite trend towards the use of more color in American homes. Women are overcoming their fears against the liberal use of cheerful colors in pleasing combinations, and are turning a deaf ear to those prophets who preach the use of negative colors, such as resulted in the taupe and the monotone styles of decoration.

Through all these periods of decorative fads and fancies the ageless charm and beauty of Oriental rugs, as a foundation for the decorative motif, has been very popular among women of taste and distinction.

Many home makers have discovered that it is easy to fit Oriental rugs into any decorative plan of floor covering.

LANDSCAPE ARCHITECT

Allan Himes Reid, Landscape Architect, announces the opening of offices in Palo Alto, and San Francisco, California, and will specialize in civic, recreational and memorial areas, residential, business and industrial landscaping.

The Era of WAR MEMORIALS

By THADDEUS M. GRABOW, Chairman

Committee on War Memorials,

Association of Landscape Architects,

San Francisco Region

World War II has come to an end. The enemy has been defeated.

True to custom and the temperament of the American people, most communities, cities and States, will seek to memorialize the dead and the living who fought for freedom and a permanently peaceful world.

We are sure you will agree with us when we say that there are in existence throughout the land, many War Memorials which were ill conceived and misplaced; they are now neglected and forgotten, their original concept and purpose lost in the passing of time.

There are also many fine and lasting memorials.

We all seek to profit by experience, and to avoid a repetition of mistakes.

The Association of Landscape Architects, in making a study of War Memorials and thoughts concerning them, finds that today there are two schools of thought.

The one advocates a practical utilitarian War Memorial; the other champions the aesthetic, symbolic memorial.

We believe that there is much to be said for both, and that a combination of the two is wholly possible. All memorials must bear the mantle of appropriateness and deep meaning, which will express lasting spiritual values. There is nothing incongruous in planning a memorial which shall also serve a useful community purpose. But it is irrefutable that such a memorial must have careful planning, and be closely integrated with community life, that it may serve its utilitarian purpose to the community, and at the same time be fitting, appropriate, and lasting as a memorial.

We as Landscape Architects are keenly aware of the importance of foresight and judgment in the

design of lasting memorials. We therefore offer the following suggestions to all interested groups as the best approach to the problem:

1. Decide on type of War Memorial most desired, after thorough preliminary analysis and unbiased judgment. Both majority and minority local groups should be heard.
2. Examine into its fitness with relation to plans of the local planning commission and other related public bodies. Seek proper official approval, and adopt method of financing.
3. Engage competent professional designers, working in collaboration with local committees for continuous consultation, technical recommendations, and for actual designs and plans.
4. Provide for adequate upkeep and maintenance in the form of endowment or other practical means.

The Association of Landscape Architects and its individual members stand ready to assist in any capacity possible.

SYLVANIA ELECTRIC APPOINTS COAST FIELD ENGINEER

George R. Sommers, Pacific Coast Sales Manager for the Sylvania Electric Products Company, announces the appointment of William B. Kennedy as Pacific Coast Field Engineer for the company.

Kennedy has been engaged in lighting activities for many years and comes to the Coast from Salem, Mass.

ARCHITECT MOVES

Mario J. Ciampi, Architect, has moved his offices to 333 Kearny Street, San Francisco, California, Suite 701.

THE HOUSE I WANT

GRACE L. McCANN MORLEY*

Director, San Francisco Museum of Art

The San Francisco Museum of Art accepted with enthusiasm the opportunity to co-sponsor the six lectures of "The House I Want" presented by the Women's Architectural League at the Museum beginning in March.

It covers the field of planning the contemporary house and garden as a part of living today in this region. Experts of high standing in their professions and of wide experience have been secured by the initiative of the League and the advice of the Northern California Chapter of the American Institute of Architects to present the basic problems of building and planning a house in all its aspects for the aid of the prospective builder. There is expert advice and friendly counsel for those who contemplate building in this region.

The series is not limited to one point of view only, nor to local opinion only. It presents a balanced review of all contemporary possibilities, and it brings experience from north and south to broaden the local knowledge of problems peculiar to the Bay Region. In six meetings it cannot be exhaustive, but it brings to attention the general basic points every home builder must consider. It may be hoped that later similar series may take up in more detail those aspects of domestic architecture from the client's point of view that these lectures will define.

The organization of the series and all the work involved has been done by the Women's Architectural League and the credit is theirs. The Museum is grateful for their initiative and appreciation of their effort.

Why should a Museum of Art be so interested

* EDITOR'S NOTE: *This article by Grace L. McCann Morley serves as an introduction to the following pages which are devoted to "THE HOUSE I WANT" and those taking part in the series of six lectures on architecture and related subjects, presented by the Women's Architectural League and sponsored by the San Francisco Museum of Art and the Northern California Chapter of the American Institute of Architects.*

in such a series? Because it bears directly on one of those fields where art and contemporary living meet and intermingle, which the San Francisco Museum of Art considers its special concern. The average man and woman do not perhaps generally realize that problems of planning, building and living in a home have anything to do with the arts—known to them usually in museum galleries and remotely. They rarely realize that their house, how it serves them, and how they use it, are an inclusive and important contemporary art expression. They seldom know to what extent their house reflects the art of their time or how the art of studios, workshops and museums contribute to it. They do not realize that their home influences, as well, are influenced by the art of their day, and stands for one aspect of contemporary art. They are too modest! They are more important than they know. After all, the domestic architecture of the Middle Ages and of the Renaissance looms importantly in art history studies, and people today building houses are contributing their share to what will be the art history of our period.

Architecture stresses the basic principle of art but also those aspects of it that are of immediate practical interest to everyone, and form the framework and instrument of everyday living. Nowhere but in the architecture, landscaping, and decorating of a home do people come into as intimate contact and close accord with art. Art, as it is used for planning, building and perfecting a home, without losing its high quality, exemplifies all its utility for assuring orderly, suitable, convenient, sightly, and therefore, enjoyable living. These lectures offer guidance to home-building in these terms, and find place in this Museum because contemporary art in all its aspects, but above all, where it enters profoundly into the everyday living of everyone, is the reason for the San Francisco Museum of Art.



GARDNER DAILEY HOUSE Frances Elkins, Decorator Thomas D. Church, Landscape Architect

Modern Living

Residential architecture that finds expression in simplicity of design and richness of material, irrespective of whether the site be level or uneven, is of paramount importance to the lasting enjoyment of "Modern Living."

The same emotional appeal one finds in art should be incorporated into architecture and the appeal of a house must be drawn from the country and the people, and not from theory.

"Contemporary architecture has in recent years been advancing more or less by the trial and error method—some all trial, some all error."

Out of this confusion, some good will come and will survive. A few theories will be left undeveloped, while others will be carried too far. We find now, for instance, that "bringing the out doors in" frequently brings in a few things that are not so

desirable. Unpleasant glare, loss of sense of enclosure, and privacy.

Such things will in time be corrected, and a new sense of values uncovered, but, in the mean-

time a fuller understanding of what is wanted in a home, and greater appreciation of beauty in surroundings and materials, and directional stability is essential for "Modern Living."

Gardiner Dailey

Architect

A native of St. Paul, Minnesota, where he was born in 1895, Gardner Dailey traveled extensively in South American countries previous to his coming to California and entering the University of California in 1919. The following year he studied at Stanford University, and for the next two years he attended the Heald's Engineering School in San Francisco.

The urge for foreign travel was great and in 1926 he made a trip to Europe which included a visit to numerous points in North Africa, and returning the same year he established his own offices in San Francisco.

Eleven years later he made his second trip to Europe, including in this trip many of the points of interest missed upon his previous visit.

In 1943 he became Chief Architect-Engineer for the Amazon Division of the Rubber Development Corporation of Brazil.

He was elected President of the San Francisco Planning Commission in 1944.

Among outstanding works was award of second place in House and Garden competition and first prize in competition conducted by the House Beautiful, both contests being national in scope.





Thomas D. Church, Landscape Architect

The House-Garden Relationship

It's too bad the general public isn't better trained at reading plans because that is the best way to illustrate the point. I'm hoping to develop some simple presentation, probably involving isometrics, which will be clear to all school children.

While on the subject, what do you suppose an intimate relation of house and garden really is? I remember an article twenty years ago which heralded the new era of the "wedding of the house and garden."

Upon close study it involved, mainly, a few more doors out of the house into the same kind of garden we've always had. The new tricks of the well placed potted plant and the curving indoor-outdoor planting space seem superficial unless they are the result on an integrated scheme.

Visual relationship must be accompanied by, or be the result of, an honest use of the space surrounding a house. By honest I mean that there must be a sympathetic interpretation of the client's requirements and that the house and site developed around it must be conceived and designed simultaneously if the two are to be considered compatible.

There must be more than a pleasant relation between the house and the garden. This was accomplished when the garden designers' theory of house to terrace to lawn to flower border to shrubbery was as sound as parlor, bedroom and bath.

The designer today must accept the responsibility of planning indoors and outdoors from property line to property line.

Ease of maintenance has moved up to number one on our hit parade.

We started our practice in the bottom of the depression when simplicity and ease of maintenance were basic requirements. We soon realized that good design was not only compatible with this idea but that the two were madly in love.

The offering of this union has been a series of gardens in which the amount of footage under

permanent control has increased at the expense of extensive flower borders, shrub areas and even areas listed as under semi-permanent control. It is amazing how a small amount of planting, when properly placed, will give the effect of color and lush foliage.

Normal clients who want to use their garden space as well as look at it have been a help.

Thomas D. Church

Landscape Architect

Though Thomas D. Church is now-a-days identified with the West Coast, he was born east of the Rockies and received much of his training there. When he entered the University of California in 1918 he planned to be a lawyer, and only took a course in landscape design as a two-unit filler. He liked it so much that he graduated in landscape architecture.

From there he went to Harvard, where he graduated with a Master of Landscape Architecture degree. He won the Sheldon traveling Fellowship which took him to Europe for a year. He studied the gardens of Italy, France and Spain and wrote a thesis on their application to California conditions.

After teaching for two years at Ohio State, he returned to California in 1929.





HOUSE IN SAUSALITO — Furnishings Designed by Maurice Sands, A.I.D. Gardner Dailey, Architect

MODERN LIVING— CALIFORNIA STYLE

The furnishings shown were minimized in order to complement the architect's "open plan" to create a "sense of space out of all proportion to the actual size of the house."

The built-in sofa, in combining book-cases and cabinets in the one unit, eliminated the need for end-tables, separate storage pieces, and a coffee table. The addition of this extra furniture would have caused a crowded appearance in a room of this size.

The simplicity of the basic furniture was relieved through the use of colorful textured fabrics, the pattern of natural woods, and the interest of metals and pottery in accessories.

It was found to be not only possible, but desirable, to plan the furnishings from the "blue print stage" in order that the architectural background and decoration were not separate phases of the problem.

Maurice Sands

Decorator

Maurice Sands received his early education at the Palo Alto Military Academy and the Cogswell Polytechnical College, later as a special student he studied at the University of California, University of California at Los Angeles, and the University of Southern California.

From 1925 to 1936 he was engaged in various business phases including Personnel Management, Purchasing, Sales, Drafting, Designing, and Contract Furnishing in Los Angeles and San Francisco. During this period he also engaged in the business of furnishing furniture and equipment for schools, lodges, theaters, public buildings and private residences.

The next six years he operated his own business of Interior Designing, Color Consultation, and Furniture Manufacturing in the field of residential and public buildings.

During the War he served as purchasing agent for the Housing Authority of the City and County of San Francisco involving War Housing Projects housing over 30,000 Navy Yard Employees and Service Personnel. He also served as Design Consultant, Interior Design, and planned more than 24 Home Planning Institutes throughout northern California. As a part of the regular curriculum at the University of California, Berkeley, he will conduct a course on Home Furnishing during the next semester.





**Garrett Eckbo,
Landscape Architect**

RESIDENCE — John S. Bolles, Ross, California

Architecture Is A Fine Art

Architecture Is A Science

Architecture Is A Profession

These facts you know, but do you know that, in addition, your Architect is your agent and advisor — he is the only one qualified through education and experience to guide you through the infinite problems of your major personal, financial, and

social undertaking. Not alone does he design a building with taste and of structural soundness, but he can analyze your family needs and budgetary limitations in relation to site, building and total financial outlay. It is his problem to see that you

select the lot that fulfills your needs, that you do not under or over purchase in relation to total value and environs, and that your site is suitable for your building without entailing expensive site development. Your Architect will check to see that the required utilities are available, and that the building restrictions and limitations are favorable.

A successful building is one that balances the needs of the occupant, his budget and site, and in addition is structurally sound, well arranged within itself and in relation to its location, and is in every respect tasteful to the eye.

These results can be achieved only through the efforts of a competent Architect.

John S. Bolles

Architect

While he is a native of Berkeley, California, John S. Bolles received his Bachelor of Science and Civil Engineering from the University of Oklahoma in 1926, and a Master in Architecture from Harvard University in 1932. His early professional training included work as a structural engineer on a power plant in Oklahoma.

As Architect for the Oriental Institute of the University of Chicago he served on expeditions to Turkey in 1929, Egypt in 1930, and Persepolis, Persia, in 1935. During 1931 through 1934 he served as Architect for the Carnegie Institution of Washington on expeditions in Yucatan, and in 1930 also was Architect for the Medieval Academy of America for studies at Cluny, France, under Dr. Kenneth Conant of Harvard University.

In 1935 he became associated with Edward G. Bolles, A.I.A., in the practice of architecture in San Francisco, an association terminated by death in 1939.

He designed the Christian Science Monitor Building and Temple of Religion of the 1939 Exposition in San Francisco; was associated with Mayo Del Pino in the painting of murals for the State Ballroom and Temple of Religion at the San Francisco Exposition in 1939; served as Project Engineer for the Federal Public Housing Authority on construction of Marin City; was Technical Director for the Housing Authority of the City and County of San Francisco 1943-45; and is now a partner in the firm of J. Francis Ward & John S. Bolles, Architects, currently engaged in the development of the Apparel City project and residential development areas in the center of San Francisco. He is President of the California Council of Architects.



Choice of Building Site

As long as the youth of the country is interested in building and owning their own homes, the political future of the country will remain in strong hands. Everywhere I have spoken during the past year, especially since the return of the veteran, the audience has been chiefly composed of young couples looking forward to building or buying their own homes. Their bright, interested faces smile up at me, stimulating my desire to answer their intelligent questions. They take notes of everything, and it is easy to be sympathetic with their problems and desires.

In my discussions on Site Selection prior to planning a home, I try to demonstrate to them

how important it is to start with the lot they want, in the location and neighborhood suited to their needs. The environment of the new and growing family will be the dominating factor in its future and in the entire life of the children they so ardently hope for. It is almost beyond realization how many things should be taken into consideration in the selection of a site. I never realized myself the many elements of the problem until I started to put them on paper.

During the time I have been presenting these ideas to those attending the Home Planning Institute series, I have become impressed with the

interest of the public generally in home planning. To satisfy this interest we must present our thoughts in an intelligent and constructive ap-

proach. Our field lays before us as far ahead as we can see. Let us do our part well in the building of the homes for these young Americans.

Raymond D. Smith

Realtor

Raymond D. Smith, Executive Vice-President of the San Francisco Real Estate Board, has been intimately acquainted with all phases of the real estate business since 1919.

Prior to his present position, he was a salesman, sales manager, or real estate broker, specializing in homes and subdivisions. During the past two years he has been lecturing on the subject "Site Selections" in Home Planning Institutes which have been held in northern California.





SWIMMING POOL, Jay Paley, Beverly Hills Paul R. Williams, Architect

Period Influence In The Modern House

Modern architecture uses the period styles as a foundation for proportion in combination with functional planning and adds color, thereby creating "the pleasing assemblage of parts, but not the assembly of pleasing parts."

Another approach to planning is to forget the usual old formula for designing a home or industrial plant, and substitute a plan based upon the way we live and work today.

Interior design as well as exterior appeal, color

harmony, rendering, and prompt attention to desires of those contemplating the building of a home

or industrial building are an important part of today's architectural considerations.

Paul R. Williams

Architect

Orphaned when he was five years old Paul R. Williams has earned his niche in the hall of architectural fame by self sacrifice and hard work. While attending the University of Southern California and studying architectural engineering, he earned money to pay for his education by designing and manufacturing watch fobs.

He began his professional career as a draftsman, but soon became a specialist in design and sketching. Many of his earlier works were secured on his ability to render sketches of projects in less time than competitors.

Today his work includes residential and industrial buildings from California to New York, and currently he is engaged in a substantial project in Mexico.





PIETRO BELLUSCHI, Architect

The Modern House Trends

In architecture, as in other creative arts, it is quite different to keep ideas in a fluid state; it seems that we experience a feeling of insecurity in the face of the unknown, and all new ideas—as soon as they are explored and discovered—must

be promptly classified, stylized, and mapped, until they have become recognized symbols. That is how formulae and styles are created; and that is supposedly how words of human language are formed. But this crystallization, while it is our

guide, is also our greatest handicap in our process of clear thinking, and evolution.

In architecture, as in art, we cannot be static, but to be truly free (and few of us ever are) it takes more determined courage, introspection and restraint than to be in shackles.

The above theory explains why the great majority of us Architects labor mightily to force planning into predetermined forms, whether these be old styles or modern fashions; and it seems we cannot go about humbly and open-mindedly solving our little problems as they should be.

Pietro Belluschi

Architect

A graduate of Rome University in 1922 with a degree of Doctor of Engineering, Pietro Belluschi was born in Italy, August 18, 1899.

Obtaining an exchange scholarship to Cornell University, he studied and received a degree in Civil Engineering.

From 1923 to 1925 he devoted his time to field work, and since 1925 has engaged in the general practice of Architecture.

He is a member of the American Institute of Architects; Trustee of the Portland, Oregon, Art Museum, and is the immediate past president of the Oregon Chapter of the A.I.A.





STERN HALL, University of California

William Wilson Wurster, Architect

Contemporary Decoration

Work in conjunction with Stern Hall, University of California at Berkeley, was done for Mrs. Sigmund Stern who gave the Dormitory for Women to the University.

The low window was the result of experience at the Yerba Buena Club—realizing that very tall windows would need shades or curtaining to keep out the glare. Walls are bleached Philippine Mahogany, while the sofas are covered in a similar color.

All furniture is bleached and covered in rawhide, including the low tables. Furniture was made in Monterey.

The lamps are from Mexico and are made of lava, and the posts that divide the room are painted the color of lava.

Rugs are black and white cowskins, while all the accessories are tin.

The curtains on the opposite side of the room are red, yellow and blue, and the cushions on the sofas repeat the colors in the curtains.

Mrs. Francis Elkins

Decorator

With an early education in schools in France, Italy and Switzerland, Frances A. Elkins has spent a considerable amount of time in observing and studying European art and design. Until World War II she spent about six months of each year in Europe.

Her professional career in Interior Decoration and Antiquities began approximately fifteen years ago. Now she maintains offices in the Robert Louis Stevenson House in Monterey, California, from which is directed the manufacture of furniture in Monterey and all installations.

Many of her important residential works have been in the East, Chicago and on Long Island, as well as on the Pacific Coast.





HANGING of Black Valenciennes Lace and Spun Silk, with hanging of vertical silver stripes and rayon—Nattier Salon of the Blumenthal house. Dorothy Wright Liebes, Textile Designer.

Contemporary Decoration Textiles

"Where do we get the inspiration for these beautiful colors and textures?"

That is a question often asked of Dorothy Wright Liebes, as people view the unique and beautiful fabrics which this West Coast weaver creates with such versatile profusion.

To which Mrs. Liebes replies that it is not a matter of sitting down at the loom and letting some

divine inspiration guide her in creating another fabric that will hit a new high in beauty and originality. Quite the contrary, it is a matter of constant research, study and awareness of the contemporary scene.

"I am museum trained," she said. "I studied design and color in the Metropolitan Museum of Art. I spent years wandering about the American

Museum of Natural History and other New York museums. How else can a designer learn? Where else can anyone get inspiration, see documents and get ideas? The art of weaving is very ancient; so is matting and basketry. There are a wealth of ideas there for the taking. I am humble every time I get into a museum. My advice to any designer of anything is to get the museum habit."

"Color," she remarked, "is purely a matter of relationship, mood, time, place, subject to change without notice. There is no such thing as an ugly color, it is all a question of how you use and combine colors."

Travel, too, is important to the textile designer, Mrs. Liebes believes.

"Travel is still the designer's staff of life," she declared. "Nature is a wonderful teacher and a trip clears the cobwebs from your brains and gives you a fresh outlook." And to prove her point Mrs. Liebes makes four or five trips to the East Coast each year.

As far as new effects go, there is no limit to what can be done. There are countless ways of combining the various yarns at hand, and it is only a matter of the designer's ingenuity as to how new textures can be created.

Dorothy Wright Liebes

Textile Designer



A graduate of the University of California at Berkeley, Mrs. Dorothy Wright Liebes is a textile designer with a background of experience ranging from courses at Columbia University; teaching in New York City; study in Europe, Guatemala, Mexico, and Hawaii.

She has created some of the most outstanding designs in the field of decoration for a clientele and business connections international in scope. Her materials include wool, cotton, silks, linen, spun glass, plastics, gold, silver, copper, leather, Chinese reeds and ribbons.

Designs are first worked out on hand looms and later reproduced by large manufacturers, thus making available the most exclusive design and colors.



GARDEN of Mr. and Mrs. Robert E. Burns, Marin County, California

John Bolles, Architect

A Garden To Live In

The Site

A wooded hillside with south exposure and views of Mt. Tamalpais through the oak trees.

The Requirements

One spacious garden terrace for family use adjacent to the living rooms of the house. Minimum use of plant material for easy maintenance.

The Solution

Because of the material of the house (natural redwood) and the wooded character of the site, we

hesitated to use any material in a mass such as brick, tile or concrete since we felt that the result would be a harsh feeling incompatible with the already established character. The result is an obviously man made pattern, the old familiar checkerboard, handled in a new way. The squares are alternating blocks of redwood and concrete. The redwood blocks are made of 2x6's laid flat, and nailed to the 2x4 division strips. The concrete has a warm colored aggregate pushed into the top.

The outer form of the terrace is produced by the trees and the redwood retaining wall required to produce the level area. The top of the wall is seat height and the zig-zag of the wall was produced by the combination of the existing grades and trees and the pattern of the paving. This zig-zag,

coupled with the fact that the wall is tied into the 2" x 4" redwood division strips running through the paving, result in an extra stable wall.

The resultant design is a hard wearing, comfortable surface with rich pattern and texture.

Edward A. Williams

Landscape Architect

Born in Pittsburgh, Pennsylvania, in 1914, Edward A. Williams received his early education in Pittsburgh; Plainfield, New Jersey, and Oakland, California, high schools. He received his Bachelor of Science from the University of California, Berkeley, in 1935, majoring in Landscape Design and minoring in Art and Architecture. From 1936 to 1938 he worked with E. Leslie Kiler, Landscape Architect, Palo Alto, on projects at Stanford University, the City of Palo Alto and many large and small private gardens in Palo Alto, San Jose, Los Altos, Piedmont, and San Francisco.

He was associated with Butler Sturtevant, Landscape Architect, San Francisco, from 1938 to 1940 on projects including the University of Washington, Principia College in Illinois, Del Monte Lodge and Hotel Del Monte, King City City Hall, and numerous private gardens in Seattle, San Francisco, Monterey, Carmel, Carmel Valley, and the San Francisco peninsula.

During 1940 private practice association included Garrett Eckbo on Ross Grammar School, and Henry R. Sanler, Jr., in Sacramento to Arizona, including gardens for Mr. and Mrs. Leslie L. Ross in San Francisco, Ronald Coleman in Santa Barbara, and Mr. and Mrs. Richard Ham in Dixon.

Was with San Mateo County Recreation Commission in development of Master Recreation Plan in 1941 and 1942, and with Western Pipe and Steel and Walsh-Kaiser corporations through 1945 doing marine mechanical engineering.

At present associated with Garrett Eckbo and Robert Royston as landscape architects and planning consultants with more than 100 jobs in various stages of development.





BRUCE JOHNSTONE HOUSE, Inverness, California

William Clement Ambrose, Architect

Your House and the Architect

The extraordinary characteristic of the community of Inverness in Marin County, California, is that the people residing there not only enjoy its glorious panoramas of forested hills, calm bay waters, and wooded canyons, but also are content to build in harmony with the surroundings. It is

one of the few places where people have assembled in numbers, to which one does not apply the words of the hymn, "where every prospect pleases, and only man is vile."

The design of a house in such a location should be approached with humility. The exhibitionism

of big city architecture is distinctly out of place. One builds not to impress his importance upon his neighbor; he builds to provide for himself and his friends, the opportunity for enjoyment of the unique charm of the surroundings.

In planning the Bruce Johnstone house at Inverness, therefore, we dispensed with the trappings of the architecture of the moment. Careful planning was required to harmonize the lines of the house to the hills and the forest, to select the mate-

rials which would seem inevitable for the situation, and to provide the facilities for free enjoyment of informal living without encroaching upon the dignity and the charm of the site.

If the view shown here seems to be more of trees and sunshine than it does of house, then it gives an adequate impression of the architecture of the place. "The groves were the gods' first temples"; we hope that this grove has not been profaned.

William Clement Ambrose

Architect

A native of California, William Clement Ambrose graduated from the University of California, Berkeley, and started his architectural experience in the offices of Willis Polk & Company in San Francisco, working on five commercial and residential projects, including the Templeton Crocker house and Carolan house on the San Francisco peninsula and the Ehrmann, Naphaly, and Welch houses in San Francisco.

Since 1927 has maintained own office in general practice of architecture including city and country houses, commercial and public buildings. During the War he served as architect, with associates, for Army and Navy projects including airfields, hospital work, conversion of buildings for naval use, preparation of special reports, and architect, with associates, on Hunter's Point, San Francisco.

Awarded "Meritorious Civilian Service Award" by the U. S. Navy.

Has found time during his many years of architectural work to travel in Europe and North Africa, and is at present associated with Eldridge T. Spencer, Architect, on residential, commercial, and educational institution projects.



IN THE NEWS

STEEL STANDARDS

The American Iron and Steel Institute is sponsoring simplified practice recommendations for wire and staples, and a revision of Simplified Practice Recommendation R9-28 covering woven wire fencing. The matter is before the Division of Simplified Practice, National Bureau of Standards.

NEW DESIGN AIR FILTER

A new principle in Electronic air filtration is embodied in the "Electro-Airmat" unit manufactured by

the AMERICAN AIR FILTER COMPANY, 125 Central Avenue, Louisville, Kentucky.

The arrestance rating, when tested by the Discoloration Method at the normal velocity of 35 f.p.m. and standard rating of 1,000 c.f.m. per standard-sized 24" by 24" unit, is 90 per cent or better with atmospheric dust or smoke.

When an electrostatic charge is applied to AIRMAT a number of plies of porous tissue, like sheets formed of short cellulose fibers in "jack-straw" arrangement, tend to separate and each individual fiber

becomes a collecting electrode attracting and holding the dust or smoke particles.

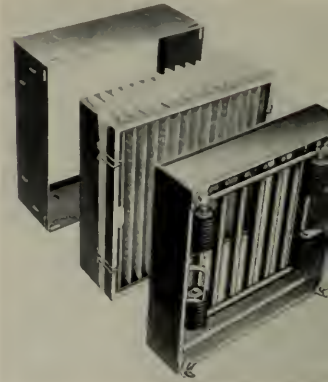

Easy to install and economical to maintain the unit operates on 110 volt 60 cycle single phase current.

PLASTIC DIFFUSER

Here is the new Guth PFC-4-foot white plastic diffuser. It has a spring-like grip design for easy cleaning.



Snaps on or off 40-Watt fluorescent lamp. Reduces brightness 75 per cent, yet is more efficient than glass diffusing panels. Manufactured by EDWIN F. GUTH COMPANY, St. Louis, Missouri.

HOLOPHANE SALES

A sales promotion department under the direction of Merritt Warner has been announced by the Holophane Company of New York.

Adoption of a common denominator known as the "four-inch rule" is advocated for the window work industry in the building of wood windows and sash.



stops destructive moisture invasion

Moisture molecules move with relentless action from hot to cold areas. These massed forces of vapor surround refrigerated rooms and constantly work toward penetrating the cold interior. They pass through warm walls and make insulation wet, soggy and valueless.

That's why **BROWNSKIN VAPORSEAL** is essential to effective and everlasting refrigeration protection. **BVS** stops moisture before it can reach vital insulation to do its destructive work.

Three reasons why **BVS** is the perfect refrigeration protection:

- 1) **BVS** is creped to resist stress and to protect it from strain, tearing and shrinkage. **BVS** S-T-R-E-T-C-H-E-S.
- 2) **BVS** is made of laminated and impregnated kraft, bonded with asphalt to provide vapor and water proofing.
- 3) **BVS** is treated with bituminous compound to resist vermin and fungus and to help prevent deterioration.

If you plan a refrigeration unit of any type, assure effective and everlasting results with **BVS**. **BROWNSKIN VAPORSEAL** samples and complete product information gladly sent on request.



Quality Products Since 1895

ANGIER SALES CORPORATION

Framingham, Massachusetts

PACIFIC COAST OFFICE: 116 NEW MONTGOMERY ST., SAN FRANCISCO 5, CALIFORNIA

DISTRIBUTORS

WESTERN ASBESTOS CO., SAN FRANCISCO
LOCKWOOD WAREHOUSE CORP., SEATTLE
BUILDING SUPPLIES, INC., SPOKANE

WARREN & BAILEY CO., LOS ANGELES
MASON'S SUPPLY CO., PORTLAND
R. W. FRANK & CO., SALT LAKE CITY

A. I. A.

ACTIVITIES

AMERICAN INSTITUTE OF
ARCHITECTS



Northern California Chapter:

Andrew T. Hass, President; E. Geoffrey Bangs, vice President; John S. Bolles, Secretary; Hervey Parke Clark, Treasurer; 369 Pine Street, San Francisco 4.

Southern California Chapter:

Charles O. Matcham, President; Adrian Wilson, Vice-President; John Landon, Secretary; Albert C. Martin, Jr., Treasurer; Offices 3757 Wilshire Blvd., Suite 212, Phone Filtroy 2393 or MUTual 4592. DIRECTORS, John Rex, Paul R. Hunter, and Weldon D. Becket.

CALIFORNIA COUNCIL OF ARCHITECTS:

John S. Bolles, President; Robert H. Orr, Vice-President; James H. Mitchell, Secretary-Treasurer; 369 Pine Street, San Francisco 4.

UNIFICATION OF THE ARCHITECTURAL PROFESSION COMPLETED IN CALIFORNIA

At the February meeting of the California Council of Architects held at the Santa Maria Inn, February 15th and 16th, John S. Bolles and James H. Mitchell were re-elected President and Secretary-Treasurer, respectively, of the Council. Charles O. Matcham, President of the Southern California Chapter of The American Institute of Architects, was elected Vice-President. Adrian Wilson, of Los Angeles, was delegated the responsibility of coordinating the legislative activities of the Council. On his committee are Norman K. Blanchard, of San Francisco, and Herbert E. Goodpaster, of Sacramento. Philip J. Daniel, of Santa Maria, became Chairman of the Committee on Professional Relations, and Charles Matcham, of Los Angeles, was asked to correlate the public relations programs of the five Chapters of The Institute.

Andrew T. Hass, President of the Northern California Chapter of The American Institute of Architects, has undertaken to set up a student training program for returning veterans. Wm. Clement Ambrose, of San Francisco, President of the State Board of Architectural Examiners, is assisting Mr. Hass in the formulating of this program. All architects will be urged to take returning service men into their offices for training purposes. Under the regulations of the Veterans' Administration, these men will receive up to \$90.00 per month compensation from the Government in addition to the wages earned while being trained to become the future architects of the State.

The unification program for the State of California was completed at the Santa Maria meeting with the admission to the Council of the Central Valley, the Santa Barbara and the Northern California Chapters of The American Institute of Architects. Under the unification procedure the North-

ern California and the Southern California Associations of Architects will cease to exist, with the Council taking over the responsibility of coordinating the Statewide activities of the profession. Indicative of the acceptance of the program by the Architects is the tremendous increase in membership of the various Chapters.

The California Council of Architects is planning to call a joint meeting of the membership of the five Chapters of The Institute. Mr. Vincent Palmer of Los Angeles, Chairman for the meeting, promises to make it the most outstanding get-together of the profession ever held in the State of California.

SOUTHERN CALIFORNIA CHAPTER

In a recent letter to the Chapter, President Charles O. Matcham declared: "As I told those present at the last Chapter meeting, I am at times somewhat skeptical of the full truth of the statement that California Architects are leaders.

"Undoubtedly, much excellent design, and progressive thought is accomplished here, but the activities of an Architect or group of Architects must not be confined only to specific projects for which they are commissioned. We have other and greater obligations than merely those to our own individual clients. I am afraid most of us, however, are guilty of believing we are too busy to assume those added obligations.

"After a recent trip across the country I came to the realization that in many respects the Architects of our community have failed . . . I traveled from one state to another on magnificently engineered and landscaped freeways. I walked along tree-lined boulevards and business streets and reflected on the elegance, stability and permanence of great, stately, though oftentimes simply designed buildings. I learned from other Architects of their activities in public life and in civic affairs, and realized their leadership contributed to the success of their communities.

"It is unforgivable that anyone of us sit back and say, 'Let's watch George do it.'

". . . I hope that during the coming year every single member of the Chapter will conscientiously and enthusiastically enter into our programs . . . assuming leadership in every phase of the life of our community."

WASHINGTON STATE CHAPTER

The "Monthly Bulletin" recently viewed the general situation in the following light: "The combination of strikes, lockouts, labor negotiations and holidays has been a little more than the human frame, not to mention the Architect, can bear. The work keeps pouring in in spite of prices and the

(See Page 44)

WITH THE ENGINEERS

Structural Engineers Association of
Northern California

W. Adrian, President; William W. Moore, Vice-President; Franklin P. Ulrich, Sec-Treas.; John A. Blume, Ass't. Sec-Treas.; Offices 214 Old Mint Building, San Francisco, Phone GARfield 3890. DIRECTORS, H. M. Engle, Mark Falk, and M. V. Pregnoff.

American Society of Civil Engineers
San Francisco Section

Theodore P. Dressler, Jr., President; Leon H. Nishkian and Sidney T. Harding, Vice-Presidents; John E. Rinne, Secretary-Treasurer; 225 Bush Street, San Francisco 20.

WESTERNER NAMED DIRECTOR AMERICAN SOCIETY OF CIVIL ENGINEERS

At its recent annual meeting in New York, the American Society of Civil Engineers elected Frederick W. Panhorst, Bridge Engineer of the California Division of Highways, a director of the society. Mr. Panhorst was elected an associate member in 1923 and member in 1933. For the last three years he has been chairman of the Local Membership Committee for this area. In 1944 he was elected to the Executive Committee of the Structural Division, on which western representation has been rare. Mr. Panhorst is Past President of the Sacramento, California, section of the Society.



Frederick W. Panhorst

Born in Andrain County, Missouri, Mr. Panhorst graduated from the University of Illinois in 1915, where he received his B. S. in civil engineering and later his C. E. degree. His early experiences included land surveying, mine surveying, construction of railroad bridges and mill building design. Two years after graduation from college, he came west as a naval architect for the Puget Sound Navy Yard in Bremerton. Later he returned to the M. K. & T. R. R. as an assistant bridge engineer. In 1920 he went to Anaconda, Montana, where he designed several complete copper smelting plants for the Anaconda Copper Company for construction in South America. From 1921 to 1927 he was in charge of construction of several large bridges for the State of Washington.

Mr. Panhorst came to California in 1927 as construction engineer for the Bridge Department of the Division of Highways. In 1931 he was appointed Acting Bridge Engineer and has been Principal Bridge Engineer since 1936. He is an active member of the Structural Engineering Asso-

ciation of Northern California. He succeeds Mr. Fred S. Scobey of San Francisco as a director of the American Society of Civil Engineers.

ENGINEERS' CONFERENCE

The Pacific Coast section of the Society for the Promotion of Engineering Education met at the University of California, Berkeley, recently, for the first time since the beginning of the war.

Faculty and staff members from colleges and universities in Arizona, Nevada, Utah, California and numerous engineers from Pacific Coast industries participated in the discussions which were presided over by Clement T. Wiskocil, professor of civil engineering, University of California.

PUBLICITY FOR ENGINEERS

The Committee on Public Education of the Structural Engineers' Association of Northern California have established a publication known as the Structural Engineers' News, which is designed to educate industry and the public on trends and affairs of western engineering.

William H. Popert, formerly connected with the Columbia Steel Company and retired after more than forty years, will serve as liaison representative of the Association.

LATIN-AMERICAN AWARDS

A fund of \$1600 has been turned over to the American Society of Civil Engineers by L. F. Harza, Chicago consulting engineer, for use in establishing a group of awards for Latin-American university civil engineering graduates.

Entrance fees for Junior membership in the Society, first year dues and a Society badge for candidates selected on the basis of scholarship, personality and interest in Pan-American affairs, is to be provided from the fund.

All applicants are to be reviewed by members of the Society, selected by the Board of Directors.

PLANNING AHEAD

The American Society of Heating and Ventilating Engineers have announced they will hold their Seventh International Heating and Ventilating Exposition in Cleveland, Ohio, January 27-31, 1947, in conjunction with their Fifty-third Annual Meeting.

This will be their first meeting since 1940.

TWO ENGINEERS

Two additional engineers have been appointed to the Bureau of Reclamation's Sacramento valley district offices.

Marshall Young, formerly acting superintendent in the Colusa, California, office and Albert W. Plummer, two years with the Navy Sea-Bees, have been assigned to the Chico headquarters.

IN THE NEWS

FHA APPLICATIONS

Sixty-two thousand dwelling unit applications were received by field offices of the FHA during the first 15-days under the new preference rating system for veterans' housing.

During the same period FHA processed and issued priorities covering 31,056 dwelling units with requirement construction be started within 90 days.

The new priority system became effective January 15th.

About 58 per cent of the applications were for dwellings to sell for less than \$7500, or to rent for less than \$60 per month.

DAM GATES INSTALLED

Nine penstock intake gates, approximately 12½ by 23½ feet, are to be installed at the upper end of the intake passage of the Keswick Dam of the Central Valley Project in California.

The gates will shut off the flow of water through intake passages so necessary inspection and maintenance work can be done inside the penstocks and on the turbines.

The Keswick Dam is located about nine miles below Shasta Dam on the Sacramento River.

OPPOSES BUILDING SUBSIDIES

L. C. Hart, president of the Producers' Council, has placed his organization on record in opposition to any form of subsidy to building products manufacturers.

Hart believes all necessary premium payments for building material production should be made available in the form of increases in OPA ceiling prices, and thus eliminate the delay of Congressional subsidy action.

PRIZE HOME COMPETITION

Two hundred and forty-three professional architects entered designs in the Chicago Tribune's \$24,000 home contest.

Color reproductions of the 24 prize winning designs were published by the Tribune during February and March.

OPENS SEATTLE OFFICE

John W. Maloney, A. I. A. Architect, recently announced the opening of offices at 654 Central Building, Seattle 4, Washington, for the practice of Architecture.



"built-in telephone outlets are inexpensive"



A plan that includes built-in telephone facilities is practical for even modest building budgets. Conduit installed during construction adds

little to building cost...and enhances future value. Even though only one telephone is needed immediately, others may be added later without tearing up the



flooring or bringing wire in along baseboards. Your clients will approve your foresight in planning built-

in telephone outlets. You are welcome to call on our Architects' and Builders' Service for any needed help at no cost.



The Pacific Telephone and Telegraph Company



PLANNING FOR STREET ACCESS A TYPICAL PROBLEM

Mr. J. W. A. Bollong, Traffic Engineer for the city of Seattle, Washington, has informed us of serious traffic conditions caused by plans for buildings and other construction being made, and in some cases construction being started or completed, without proper consideration being given to vehicular traffic between the building or other construction and the street.

This introduces serious traffic hazards or the necessity for making more or less serious compromise adjustments.

To remedy this situation, Architects are requested, when they have planning problems involving the crossing of sidewalks or otherwise the obtaining of access to streets, to consult with the traffic engineering department of the city so that adequate traffic facilities can be provided in the plans.

This is especially important in the planning of parking terminals, auto freight terminals and all other construction where heavy turnover in motorized equipment is involved or anticipated.—Reprinted from Monthly Bulletin, Washington State Chapter, A. I. A.



BAXCO
CHROMATED ZINC CHLORIDE



PRESSURE TREATED LUMBER
● **PROTECTS AGAINST DECAY
AND TERMITE ATTACK**

Specify it in your home
Available through Lumber Dealers

LOS ANGELES	SAN FRANCISCO
601 W. 5th Street	333 Montgomery Street
Phone Michigan 6294	Phone DOuglas 3883

J. H. Baxter & Co.

AGENTS FOR WEST COAST WOOD PRESERVING CO. SEATTLE, WASH.

HEADLINE NEWS & VIEWS

By E. H. W.

Just think of the permanent uses to which materials destroyed by the Navy's "Atomic" experiments in the Pacific might be applied . . . many an important construction project held-up for lack of materials could be completed with what "WE" choose to destroy.

△

"Plastic Advertising Specialties of Distinction," a booklet by The Emeloid Co., Arlington, N. J.—Novelty doo-dads, gadgets, and trick-idea advertising should really come into their own in the plastic field.

△

Universal Electric's "Systemeering" guide to profitable retailing leaves little unsaid about good merchandising . . . the \$64 question, still unanswered, is "How to get more display advertising for Architect and Engineer?"

△

California Mission Trails Association proposes public campaign for restoration of early Spanish-California Franciscan Missions . . . many beautiful, public, industrial, and residential structures employ basic architectural features of the Missions.

△

Congratulations! Compliments to Vol. 1, No. 1, of Structural Engineering News, official publication of the Committee on Public Education, Structural Engineers' Association of Northern California. A nice job, well done.

△

Average thinking of manpower reconversion centers around "industry," what about the greater percentage of workers—doctors, nurses, maintenance personnel, insurance men, architects, engineers, etc.—they surely represent an economic factor.

△

The General Bronze Corporation, New York, is launching a national campaign for the use of aluminum windows in residential construction.

Plans for a new RESEARCH CENTER in which greatly expanded and accelerated development work will be carried on in the fields of building materials, insulations and other products urgently needed to help house the Nation and increase efficiency of industrial operations in the postwar period have been announced by Lewis H. Brown, president of the JOHNS-MANVILLE CORPORATION.

CONSTRUCTION INDUSTRY ANALYZED BY EXPERT

"A Challenge to the Construction Industry" was the subject of a thoughtful talk made by Arthur A. Hood, Director of Dealer Relations of the Johns-Manville Sales Corporation before the March 4th meeting of the Northern California Chapter of the Producers' Council and their prospective new member guests.



Arthur A. Hood

Mr. Hood's interesting talk was made out of a background of a long and active career in the building industry. He says he was practically born in a lumber yard, 15 years of his business career has been spent as a retailer, 5 years as a wholesaler, and 12 years in the manufacturing branch of the building industry. His keen interest in distributor problems is indicated by his Chairmanship of the Marketing Committee of the Producers' Council, Inc. He is also Chairman of the Educational Committee of the National Homes Foundation, Member of the Distribution Committee in the following organizations: American Marketing Association, Society for the Advancement of Management and the National Association of Manufacturers.

He also serves as Chairman of the Joint Committee on Research, Education and Marketing for the building industry. In fact, one of his hobbies is the study of economics—but all with a very human touch, other hobbies being fishing, poker and golf.

PACIFIC DRILLING CORPORATION

Walter F. Harcourt-Palmer, mining and construction engineering executive, has been named president of the Pacific Drilling Corporation, a firm specializing in churn, rotary and square shaft drilling.

Headquarters of the new organization are located at 233 Sansome Street, San Francisco, California. Branch offices have been established in the Syndicate Building, Oakland, California.

EXPANDS OFFICES

William Wilson Wurster and Theodore C. Bernardi have announced the addition of Mr. Donn Emmons as a member of the firm.

Henceforth, the name of the firm will be: Wurster, Bernardi and Emmons, Architects, and they will be located at 402 Jackson Street, San Francisco 11, California.

Let's Talk Wiring

The growth in the use of electricity in the home has been steady and amazing. But, average wiring capacity has never quite been able to catch up, and few homes have truly enjoyed the most efficient and convenient use of appliances and lighting equipment.

Now, as we are about to begin a new era in building, there is an opportunity to "start from scratch" — to provide complete electrical adequacy for homes of the future.

These homes, from year to year, will demand an ever expanding list of appliances — appliances which can provide satisfactory and economical service, only if the wiring system is adequate for the job.

Make sure each house you plan will be modern, electrically, for years to come by specifying:

1. *Wiring of sufficient size.*
2. *Enough convenience outlets for future appliance and lighting needs.*
3. *Enough circuits to distribute the electrical load properly.*

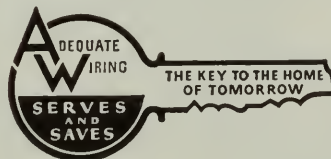

NORTHERN CALIFORNIA
ELECTRICAL BUREAU

1355 Market Street
San Francisco 3





**E. K. WOOD
LUMBER COMPANY**

LOS ANGELES
SAN FRANCISCO
OAKLAND

**WE MANUFACTURE
OR SUPPLY**

DOUGLAS FIR
REDWOOD
SUGAR PINE
PONDEROSA PINE
SASH AND DOORS
MILLWORK
MASONITE TEMPERED PRESSEDWOOD
CONCRETE FORM PANELS
CEMENT ASBESTOS BOARD
INSULATION AND
INSULATION BOARD
INSULATION TILE AND PLANK
PLASTER BOARD
FIR-TEX INSULATION PRODUCTS
TRIPLE-SEALED GYPLAP
SISALKRAFT BUILDING PAPER
ROOFING
WOODLIFE WATER REPELLANT
BUILDERS HARDWARE

DEPENDABLE QUALITY

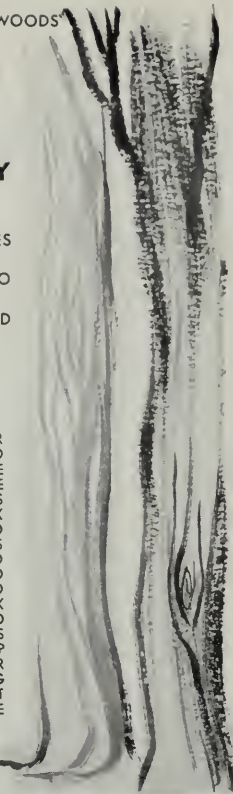

IN THE NEWS

**INTERNATIONAL LIGHTING
EXPOSITION — CHICAGO**

Leaders of the lighting industry throughout the nation will meet in Chicago on April 25 to 30 for the first postwar International Lighting Exposition.

Sessions during the six days will cover every major phase of commercial, industrial and home lighting.

More than 70 producers of commercial and industrial lighting equipment, lamps and allied products will have on display their latest models according to officials of the National Electrical Manufacturers' Association, sponsors of the event.

AMOROSO CONSTRUCTION COMPANY

The S. J. Amoroso Construction Company have moved their offices from 2136 Alemany Boulevard to 2100 Oakdale Avenue, San Francisco 24, in order to better serve their clients.

ANSLEY PANELTONE

A new type radio designed specifically for built-in installations has been announced by the ANSLEY RADIO CORPORATION of Long Island City, N. Y., and is being distributed by the PANELTONE CORPORATION, 1841 Broadway, New York.

Built on a heavy steel panel, requiring only 4 1/2 inches of depth, two models are offered—a 7-tube set on a 14 x 14 inch panel, and a 14 x 26 inch panel 17-tube de luxe model—in either AC or AC-DC.

Apartment houses and home installations where radio is desired without additional piece of furniture will find the new ANSLEY PANELTONE serves the purpose.

PULL THE WIRES

A long and careful study has revealed a serious major bottleneck to future home load building programs. House wiring has not kept pace with increased appliance use, nor with the increased wattages as applied to individual units, as:

	Originally	New
Toaster	500 watts or less	1000 watts
Iron	500 watts	1000 watts
Roaster	1000 watts	1300-1400 watts
Lamp Bulbs	40-75 watts	60-300 watts

Wiring in more than ninety-five per cent of America's homes is inadequate to carry efficiently the present lighting and appliance loads. Corrective action is a must in both new and old homes.

*Be sure you're getting the
finest window glass obtainable*

it costs no more to specify

PENNUERNON

Distributed by...

W · P · FULLER & CO.
PAINTS • GLASS • WALLPAPER

it's **PENNUERNON**
FLATTER *flat drawn*
CLEARER **WINDOW GLASS**
BRIGHTER

IN THE NEWS

LEADER

California has more employees of the executive branch of the federal government than any other state, or the metropolitan area of Washington, D. C. Of 2,912,093 paid employees as of June 30, 1945, California had 317,236; Washington, D. C., 256,710; and New York State, 293,018.

LESLIE REGULATOR

A self-contained, spring loaded, internal pilot, piston operated Temperature Regulator for steam service has been announced by the LESLIE COMPANY, 55 Delafield, Lyndhurst, N. J.

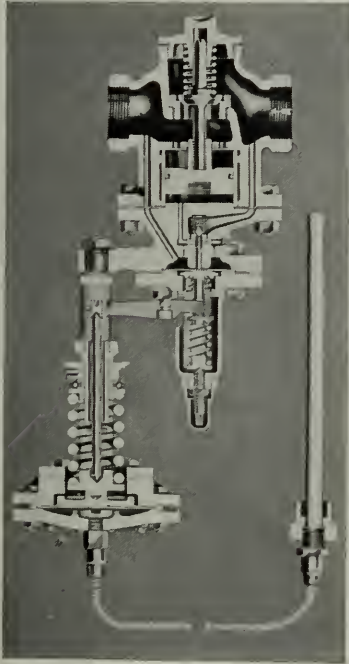

Self-contained Steam Regulator

Prominent feature is Duo-matic Control, whereby accurate temperature regulation and pressure control are simultaneously obtained.

Wearing parts are renewable, allowin for complete overhaul without removal from pipe line.

GLOWING AID

A plastic electric light switch plate equipped with a tiny electric lamp that glows when the lights it controls are out, has been developed.

FOR WORK OR RECREATION

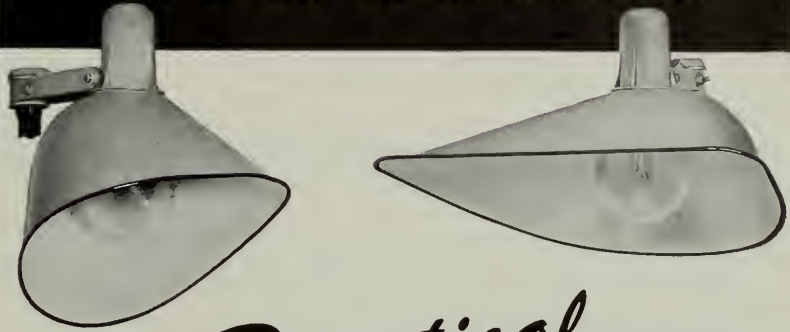

Practical FLOOD LIGHTING

for parking lots, sports areas,
filling stations, or the
home yard

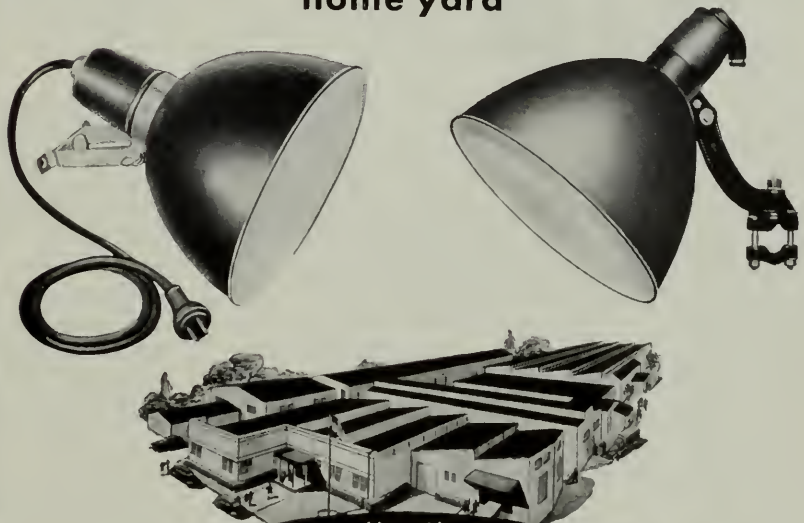

LOOK FOR THIS LABEL FOR THE FINEST IN
INCANDESCENT OR FLUORESCENT LIGHTING

PRODUCER'S COUNCIL PAGE

The National Organization of Manufacturers of Quality Building Materials and Equipment
affiliated with THE AMERICAN INSTITUTE OF ARCHITECTS

President, E. E. CATHCART
Johns-Manville Sales Corp.
116 New Montgomery St.

Vice-President, C. J. NICHOLAS
Bastian-Morley Co.
301 Brannan St.

Secretary, H. C. GALITZ
Westinghouse Electric Corp.
110 Sutter St.

Treasurer, E. P. LARSON
Celotex Corp.
675 Townsend St.

Edited by C. W. KRAFT, KRAFTILE CO., Niles, California

NORTHERN CALIFORNIA CHAPTER

In looking over the line-up of Officers and Committee Chairmen for this year, we find just one new face, that of Joe Carlson, Chairman of the Fellowship Committee. Agreeable, he brings a fine personality make-up to the job of making both members and guests feel welcome and at ease.



J. A. "Joe" Carlson
"A good Joe"

Joe didn't come from Minnesota—but the next thing to it, being born in Grafton in the Red River Valley in North Dakota. Joe did his bit in World War I, enlisting in the U.S. Army Signal Corps

and serving overseas one year with the 78th Lightening Division. Through a succession of jobs, Joe worked his way into, up and out West in the tile industry. His last job as Western Division Manager of Cambridge Tile Company lasted until they closed up their San Francisco warehouse during the war. Since then, Joe has managed Kraftile affairs in their San Francisco office.

Joe is married, has no children, lives in San Francisco. Besides the Producers' Council he is interested also in the activities of the Building Industry Conference Board, Credit Manager's Association and San Francisco Employers Council.

His sports interests include football, baseball and hockey; his hobbies, gardening and—collecting rare specimens of old tiles and vases!

AIA ELECTS: New Officers of the Northern California Chapter are President, Andy Hass; Vice-President, Hervey Clerk; Secretary, John Bolles; Treasurer, Ernest Born.

AIA TECHNICAL INFORMATION COMMITTEE appointments as announced by President Andy

Hass are: Wayne Hertzka, Chairman; Ernest Born, Wendell Spackman and John Devitt.

This constitutes the Architects' half of the very important Joint Technical Information Committee, our half of which is capably chairmanned by Ray Brown.

FIRST SHOWING of the slide film record "A Scotsman Looks at Modular Coordination" was made before the Building Industry Conference Board at their February meeting. Ray Brown handled the presentation and the reception was so good the Architects are asking for it at a joint AIA-Producers' Council meeting.

MODULAR MOMENTS

Question: If standardization is being adopted, why not go right to the metric system once and for all?

Mr. Lorimer: "Though the war undoubtedly brought a greater knowledge and use of the metric system, it may be a long time before America takes such a step nationally. Until such time, it is felt that the building industry will continue the present system of feet and inches. It should be noted, however, that the modular system in feet and inches is actually in extremely close relationship to the metric system. The modular unit is 4". The decimal multiple of 10 gives 40" as compared to the meter (39.37"). The 10 c.m. module already commonly used in French construction is 3.937" or less than 1/16" difference from the 4" module. Should the metric system eventually be adopted in America the transition should be relatively easy."

You might be interested in a little summary of one angle of company participation in Chapter affairs—the number of Chapter Presidents in company members. Always active in Council affairs, Johns-Manville men head 5 Chapters. Crane is a close second with 4, Armstrong Cork, Chamberlin
(See next Page)

USE QUALITY PRODUCTS



CONSULT AN ARCHITECT

Co. and H. H. Robertson have 2 each and the following 1 each: W. P. Fuller; Gladding McBean; Libbey, Owens, Ford; Mueller Brass; National Fireproofing; Otis Elevator and Westinghouse Electric.

HOUSING SHORTAGE boils down to two hard facts: 1) shortage of labor, 2) shortage of materials. Or, maybe that is a negative way of looking at it because what causes these shortages? The answer boils down to one condition—a tremendous demand. While everybody is mad at everybody else about the situation, 10 or 12 years ago everybody would have welcomed such a condition. Then, everybody was mad at everybody else because the opposite was true.

COOPERATION AND TOLERANCE of the other fellows problems is the only way out. Recriminations won't do it and we don't need to appropriate funds for a building program. What this country needs mainly is more people willing to do an honest day's work.

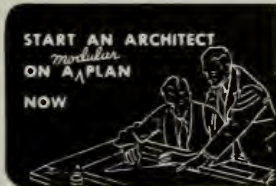

CALIFORNIA'S SYSTEM OF PLANNING COMMISSIONS

Through establishment of planning commissions, most local governments of the State are taking rapid strides towards making California communities much better places in which to live, although much progress is also being made by unofficial planning groups.

Recent surveys made by the California State Reconstruction & Reemployment Commission, of which Col. Alexander R. Heron, is director, shows the Commission has given assistance and advice to 115 communities in planning activities through field staff contacts.

Under provisions of the California public planning laws, for local governmental units to take advantage of wartime gains, cities may and counties must establish planning commissions.

The number of city planning commissions has increased from 132 in 1939 to 150 in 1945, and serve more than 95 per cent of the population in incorporated cities.

The number of county planning commissions has increased from 33 in 1939 to 50 in 1945, and represent 96 per cent of the State's population outside incorporated cities.

MOVES

The offices and yard of WILLIAM CURLETT, General Contractor, are now located at 820 W. Esther Street, Long Beach 6, California.

STRUCTURAL STEEL

For Class A Buildings,
Bridges, etc.

JUDSON PACIFIC - MURPHY CORP.

1200 SEVENTEENTH STREET
SAN FRANCISCO

Plants: San Francisco - Oakland

SISALKRAFT

REG. U. S. PAT. OFF.

"More than a building paper"

THE SISALKRAFT CO.

205 West Wacker Drive
Chicago, Ill.

55 New Montgomery Street
San Francisco, Calif.

BASALITE

LIGHTWEIGHT CONCRETE
BUILDING UNITS

CHARACTER • ECONOMY • INSULATION
FIRE-SAFE • TERMITE PROOF • PERMANENCE

BASALT ROCK CO., INC.
NAPA, CALIFORNIA

FORDERER CORNICE WORKS

Manufacturers of

Hollow Metal Products • Interior Metal Trim
Elevator Fronts and Cabs
Metal Plaster Accessories • Sanitary Metal Base
Flat and Roll Metal Screens
Metal Cabinets • Commercial Refrigerators

269 POTRERO AVE.
SAN FRANCISCO, CALIF. HEMLOCK 4100

KITCHEN JEWELRY!



STANLEY

Cabinet Hardware
Mayfair Pattern, 5 Other Handsome Patterns

This new line, styled by nationally noted industrial designers, is the result of years of research and test by the Stanley Engineering Department to make cabinet hardware smoother working, longer lasting and easier to install.

Specify it with the full assurance that you are recommending the best. The Stanley Works, New Britain, Conn.

BLUE RIBBON DESIGN



A HANDY SERVICE

Invaluable to those desirous of taking advantage of Postwar opportunities in the building-construction, and engineering field.

Consists of DAILY REPORTS giving name, location, architect, proposed cost and other valuable information about projects in Northern California.

Total cost \$10 per month

DON'T DELAY • SUBSCRIBE TODAY

ARCHITECT'S REPORTS

Published Daily by

ARCHITECT and ENGINEER, Inc.

68 Post Street, San Francisco

EXbrook 7182

COMES WEST

R. W. Fitzgerald has been promoted Western division manager of the Goodyear Tire & Rubber Company, at Los Angeles, California, succeeding the late E. L. Mefford.

He comes to the Coast from Detroit.

LIGHT REFLECTING CONCRETE FLOOR

A postwar innovation with a satisfactory record of war-plant performance is the light-reflecting concrete floor which is particularly adaptable for use in factories, schools, offices, libraries, hospitals, hangars, stairwells, and basements.

In a newly published 24-page booklet entitled "Light From Floors" the UNIVERSAL ATLAS CEMENT COMPANY, Chrysler Building, New York, show the peace-time possibilities of the white-cement floor both for new floors and the retopping of old floors.

Three hundred lighting tests are cited as proof that white cement floors, as against gray, increase illumination on the underside work surfaces of planes in aircraft factories of 61 per cent, and on their vertical work surfaces by 20 per cent.

Recommended practice for construction, surface treatment and maintenance are also covered in the booklet.

CLAIMS MANAGER

Theodore Herman was recently appointed manager of claims for the Bethlehem Pacific Coast Steel Corporation, San Francisco, California.

He comes to the Coast from Bethlehem, Pennsylvania.

"ROGERS PAINTS"

Earl L. Hess, vice president and general manager of the Detroit White Lead Works, recently announced that the name of the organization had been changed to ROGERS PAINT PRODUCTS, INC., "for world-wide identification" to the maker of a product which has enjoyed national prestige for 65 years.

Varnishes, enamels, automotive and industrial finishes manufactured by the Detroit White Lead Works have been marketed as "Rogers Paints" since 1880 when Colonel Ford H. Rogers became identified with the organization.

No changes in personnel or organization were announced.

OPENS OFFICE

Albert F. Roller, Architect, in the Crocker First National Bank Building, San Francisco, has opened offices for the practice of architecture in the Subway Terminal Building, 417 South Hill Street, Los Angeles, California.

ESTIMATOR'S GUIDE

BUILDING AND CONSTRUCTION MATERIALS

PRICES GIVEN ARE FIGURING PRICES AND ARE MADE UP FROM AVERAGE QUOTATIONS FURNISHED BY MATERIAL HOUSES TO SAN FRANCISCO CONTRACTORS. 2½% SALES TAX ON ALL MATERIALS BUT NOT LABOR

All prices and wages quoted are for San Francisco and the Bay District. There may be slight fluctuation of prices in the interior and southern part of the state. Freight cartage, at least, must be added in figuring country work.

BONDS—Performance—\$10 per \$1000 of contract. Labor and materials, \$10 per \$1000 of contract.

BRICKWORK—
Common Brick—Per 1M laid—\$50.00 to \$60.00 (according to class of work).

Face Brick—Per 1M laid—\$120 to \$150 (according to class of work.)

Brick Steps—\$1.60 per lin. ft.
Brick Veneer on Frame Bldg.—Approx. \$1.30 per sq. ft.

Common Brick—\$19.00 per M, truckload lots, f.o.b. job.
\$19.00 per M, less than truckload, plus cartage.

Face Brick—\$40 to \$80 per M, truckload lots, delivered.
Cartage—Approx. \$4.00 per M.

BUILDING PAPER—
1 ply per 1000 ft. roll.....\$3.50
2 ply per 1000 ft. roll..... 5.00
3 ply per 1000 ft. roll..... 6.25
Brownskin, Standard, 500 ft. roll..... 5.00
Sisalkraft, 500 ft. roll..... 5.00
Sash cord com. No. 7.....\$1.20 per 100 ft.
Sash cord com. No. 8..... 1.50 per 100 ft.
Sash cord spot No. 7..... 1.90 per 100 ft.
Sash cord spot No. 8..... 2.25 per 100 ft.
Sash weights, cast iron, \$50.00 ton.
Nails, \$3.42 base.
Sash weights, \$45.00 per ton.

CONCRETE AGGREGATES—
The following prices net to Contractors unless otherwise shown.
Gravel, all sizes—
\$1.95 per ton at Bunker; delivered\$2.50
Bunker Del'd
Top Sand\$1.90 \$2.50
Concrete Mix 1.90 2.45
Crushed Rock, ¼" to ¾"..... 1.90 2.50

Crushed Rock, ¾" to 1½"..... 1.90 2.50
Roofing Gravel 2.25 2.80
River Sand 2.00 2.45
Sand—
River Sand 2.00 2.45
Lapis (Nos. 2 & 4)..... 2.85 3.15
Olympia (Nos. 1 & 2)..... 2.85 3.10
Del Monte White84c per sack

Cement—
Common (all brands, paper sacks), carload lots, \$2.42 per bbl. f.o.b. car; delivered \$2.72.
Cash discount on carload lots, 10c a bbl., 10th Prox.; less than carload lots \$3.20 per bbl. f.o.b. warehouse or delivered.
Cash discount 2% on L.C.L.

Atlas White } 1 to 100 sacks, \$2.50 sack
Calaveras White } warehouse or del.; \$7.65
Medusa White } bbl. carload lots.
Forms labor average \$350 per 1000 sq. feet.
Average cost of concrete in place, 50c per cubic foot, exclusive of forms; \$15.00 per cubic yard. With forms \$1.60 per cubic foot.

DAMP-PROOFING and Waterproofing—
Two-coat work, \$3.50 per square.
Membrane waterproofing—4 layers of saturated felt, \$7.00 per square.
Hot coating work, \$2.50 per square.
Medusa Waterproofing, \$3.50 per lb. San Francisco Warehouse.
Tricocel waterproofing.
(See representative.)

ELECTRIC WIRING—\$12 to \$15 per outlet for conduit work (including switches).
Knob and tube average \$3.00 per outlet. (Available only for priority work.)

ELEVATORS—
Prices vary according to capacity, speed and type. Consult elevator companies. Average cost of installing a slow speed automatic passenger elevator in small four story apartment building, including entrance doors, about \$6500.00.

EXCAVATION—
Sand, 60 cents; clay or shale \$1 per yard.

Trucks, \$20 to \$32 per day.
Above figures are an average without water. Steam shovel work in large quantities, less; hard material, such as rock, will run considerably more.

FIRE ESCAPES—
Ten-foot galvanized iron balcony, with stairs, \$150 installed on new buildings; \$160 on old buildings.

FLOORS—
Composition Floors, such as Magnesite, 50c per square foot.
Linoflor—2 gages—\$1.25 to \$2.75 per sq. yd.
Mastopave—90c to \$1.50 per sq. yd.
Battleship Linoleum—available to Army and Navy only—1/8"—\$1.75 sq. yd.
3/8"—\$2.00 sq. yd.
Terazzo Floors—50c to 70c per sq. ft.
Terazzo Steps—\$1.75 per lin. ft.
Mastic Wear Coat—according to type—20c to 35c.

Hardwood Flooring—
Standard Mill grades not available.
Victory Oak—T & G
3/4" x 2 1/4".....\$143.25 per M. plus Cartage
1/2" x 2"..... 122.00 per M. plus Cartage
1/2" x 1 1/2"..... 113.50 per M. plus Cartage
Prefinished Standard & Better Oak Flooring
3/4" x 3 1/4".....\$180.00 per M. plus Cartage
1/2" x 2 1/2"..... 160.50 per M. plus Cartage
Maple Flooring
3/4" T & G Clear \$160.50 per M. plus Ctg.
2nd 153.50 per M. plus Ctg.
3rd 131.25 per M. plus Ctg.
Floor Layers' Wage, \$1.50 per hr.

GLASS—
Single Strength Window Glass.....20c per □ ft.
Double Strength Window Glass.....30c per □ ft.
Plate Glass, under 75 sq. ft.....\$1.00 per □ ft.
Polished Wire Plate Glass..... 1.40 per □ ft.
Rgh. Wire Glass34 per □ ft.
Obscure Glass27 per □ ft.
Glazing of above is additional.
Glass Blocks\$2.50 per □ ft. set in place

HEATING—
Average, \$1.90 per sq. ft. of radiation, according to conditions.
Warm air (gravity) average \$48 per register.
Forced air, average \$68 per register.

IRON—Cost of ornamental iron, cast iron, etc., depends on design.

LUMBER—All lumber at O.P.A. ceiling prices—

No. 1 Common.....	\$49.00 per M
No. 2 Common.....	47.75 per M
Select O. P. Common.....	52.75 per M

Flooring—

V.G.-D.F. B & Btr. 1 x 4 T & G Flooring.....	Delvd. \$80.00
C 1 x 4 T & G Flooring.....	75.00
D 1 x 4 T & G Flooring.....	65.00
D.F.-S.G. B & Btr. 1 x 4 T & G Flooring.....	61.00
C 1 x 4 T & G Flooring.....	59.00
D 1 x 4 T & G Flooring.....	54.00
Rwd. Plastic—"A" grade, medium dry.....	82.00
"B" grade, medium dry.....	78.50

Plywood—not available

	Under \$200	Over \$200
"Plyscord"— $\frac{3}{8}$ ".....	\$49.50	\$47.55
"Plywall"— $\frac{1}{4}$ ".....	45.15	43.30
3 ply— $\frac{2}{8}$ — $\frac{1}{4}$ ".....	48.55	46.60
"Plyform"— $\frac{3}{8}$ "—		
Unoiled.....	126.50	121.45
Oiled.....	127.90	122.75

Above prices delivered if quantity is sufficient to warrant delivery.

Shingles (Rwd. not available)—

Red Cedar No. 1—\$6.75 per square; No. 2, \$5.75; No. 3, \$4.45.
Average cost to lay shingles, \$3.00 per square.
Cedar Shakes—Tapered: $\frac{1}{2}$ " to $\frac{3}{4}$ " x 25"—\$8.95 per square.
Resawn: $\frac{3}{4}$ " to $\frac{1}{4}$ " x 25"—\$10.65 per square.
Resawn: $\frac{3}{4}$ " to $\frac{1}{4}$ " x 25"—\$10.65 per square.
Average cost to lay shakes, \$4.00 per square.

MILLWORK—Standard.

D. F. \$100 per 1000. R. W. Rustic \$100.00 per 1000 (delivered).
Double hung box window frames, average with trim \$6.50 and up, each.
Complete door unit, \$10.00.
Screen doors, \$3.50 each.
Patent screen windows, 25c a sq. ft.
Cases for kitchen pantries seven ft. high, per lineal ft., \$9.00 each.
Dining room cases, \$9.00 per lineal foot.
Rough and finish about 80c per sq. ft.
Labor—Rough carpentry, warehouse heavy framing (average), \$40.00 per M.
For smaller work average, \$40.00 to \$55.00 per 1000.

MARBLE—(See Dealers)

PAINTING—

Two-coat work.....	per yard 50c
Three-coat work.....	per yard 70c
Cold water painting.....	per yard 10c
Whitewashing.....	per yard 8c

PAINTS—

Two-coat work.....50c per sq. yd.
Three-coat work.....70c per sq. yd.
Cold water painting.....per yard 10c
Whitewashing.....8c per sq. yd.
Turpentine \$1.03 per gal. in drum lots.
\$1.08 per gal. in 5-gal. containers.
Raw Linseed Oil—not available.

Boiled Linseed Oil—\$1.38 per gal. in drums. Available only to work with high priority—\$1.48 per gal. in 5-gal. containers.

Use replacement oil—\$1.86 per gal. in 1-gal. containers.

Replacement Oil—\$1.20 per gal. in drums. \$1.30 per gal. in 5-gal. containers.

A deposit of \$6.00 required on all drums.

PATENT CHIMNEYS—

6-inch.....	\$1.20 lineal foot
8-inch.....	1.40 lineal foot
10-inch.....	2.15 lineal foot
12-inch.....	2.75 lineal foot

PLASTER—

Neat wall, per ton delivered in S. F. in paper bags, \$17.60.

PLASTERING (Interior)—

3 Coats, metal lath and plaster.....	Yard 1.50
Keene cement on metal lath.....	1.80
Ceilings with $\frac{3}{4}$ hot roll channels metal lath (lathed only).....	1.20
Ceilings with $\frac{3}{4}$ hot roll channels metal lath plastered.....	2.20
Single partition $\frac{3}{4}$ channel lath 1 side (lath only).....	1.20
Single partition $\frac{3}{4}$ channel lath 2 inches thick plastered.....	3.20
4-inch double partition $\frac{3}{4}$ channel lath 2 sides (lath only).....	2.20
4-inch double partition $\frac{3}{4}$ channel lath 2 sides plastered.....	3.85
Thermax single partition; 1" channels; $\frac{2}{4}$ " overall partition width. Plastered both sides.....	3.30
Thermax double partition; 1" channels; $\frac{3}{4}$ " overall partition width. Plastered both sides.....	4.40
3 coats over 1" Thermax nailed to one side wood studs or joists.....	1.65
3 coats over 1" Thermax suspended to one side wood studs with spring sound isolation clip.....	1.90

Note—Channel lath controlled by limitation orders.

PLASTERING (Exterior)—

2 coats cement finish, brick or concrete wall.....	Yard 1.00
3 coats cement finish, No. 18 gauge wire mesh.....	2.00
Lime—\$3.00 per bbl. at yard.	
Processed Lime—\$3.10 bbl. at yard.	
Rock or Grip Lath— $\frac{3}{8}$ "—20c per sq. yd.	
$\frac{1}{2}$ "—19c per sq. yd.	

Composition Stucco—\$1.80 to \$2.00 sq. yard (applied).

PLUMBING—

From \$100.00 per fixture up, according to grade, quantity and runs.

ROOFING—

"Standard" tar and gravel, 4 ply—\$8.00 per sq. for 30 sqs. or over.
Less than 30 sqs. \$9.50 per sq.
Tile, \$30.00 to \$40.00 per square.
Redwood Shingles, \$7.50 per square in place.
5/2 #1-16" Cedar Shingles, $\frac{4}{2}$ " Exposure.....\$8.00 square

5/8 x 16"—#1 Cedar Shingles, 5" Exposure.....	\$9.00 square
4/2 #1-24" Royal Shingles, $\frac{7}{2}$ " Exposure.....	\$9.50 square
Re-coat with Gravel.....	\$4.00 per sq.
Asbestos Shingles, \$23 to \$28 per sq. la	
1/2 x 25" Resawn Cedar Shakes, 10" Exposure.....	\$10.
3/4 x 25" Resawn Cedar Shakes, 10" Exposure.....	11.
1 x 25" Resawn Cedar Shakes, 10" Exposure.....	12.

Above prices are for shakes in place.

SHEET METAL—

Windows—Metal, \$1.75 a sq. ft.
Fire doors (average), including hardware \$2.00 per sq. ft.

SKYLIGHTS—(not glazed)

Copper, 90c sq. ft. (flat).
Galvanized iron, 40c sq. ft. (flat).
Vented hip skylights 60c sq. ft.

STEEL—STRUCTURAL—

\$150 ton (erected), this quotation is average for comparatively small quantities. Light truss work higher. Plate beams and column work in large quantities \$140 per ton.

STEEL REINFORCING—

\$100 to \$130 ton, set.

STONE—

Granite, average, \$6.50 cu. foot in place.
Sandstone, average Blue, \$4.00. Boi \$3.00 sq. ft. in place.
Indiana Limestone, \$2.80 per sq. ft. place.

STORE FRONTS (None available).

TILE—

Ceramic Tile Floors—\$1.00 to \$1.25 per sq. ft.
Cove Base—\$1.10 per lin. ft.
Glazed Tile Wainscot—\$1.25 per sq. ft.
Asphalt Tile Floor $\frac{1}{8}$ " & $\frac{3}{8}$ "—\$.18 to \$.35 per sq. ft. Light shades slightly higher.
Cork Tile—\$.40 to \$.75 per sq. ft.
Mosaic Floors—see dealers.
Lino-Tile, \$.35 to \$.75 per sq. ft.

Wall Tile—

Glazed Terra Cotta Wall Units (single face laid in place—approximate prices:
2 x 6 x 12.....\$1.10 sq.
4 x 6 x 12.....1.25 sq.
2 x 8 x 16.....1.20 sq.
4 x 8 x 16.....1.40 sq.

VENETIAN BLINDS—

40c per square foot and up. Installation extra.

WINDOWS—STEEL—

30c per square foot, \$5 for ventilators.

NEW RESIDENTIAL WINDOW

A new factory fitted 3-way residential window package, steel casement, storm sash and screen, has been developed by the DETROIT STEEL PRODUCTS COMPANY of Detroit.

Glass, wood casing, outside trim and hardware are also provided as part of the package which takes but a few minutes, rather than hours, to install.

More daylight, better ventilation, and longer life are also features of the product which will be on display at the annual convention of the National Association of Home Builders in Chicago, February 25-28.

NISHKIAN MOVES

L. H. Nishkian has moved his engineering offices from 155 Sansome Street, to 1045 Sansome Street, San Francisco. His son, Byron L. Nishkian, is now associated with the firm.

SAN RAFAEL ARCHITECT

Sidney A. Colton, Architect, has opened offices in the Cheda Building, San Rafael, California, for the practice of architecture. He is desirous of obtaining manufacturers' catalogues on building products.

SITE PLANNER LANDSCAPE ARCHITECT

Civic Recreational Areas
Memorial Sites
Residential Grounds
Commercial Developments

ALLAN HIMES REID

244 Oxford Ave., Palo Alto
Phones: Palo Alto 2-4226
San Francisco: Garfield 5084

1945 BUILDING TRADES WAGE SCALES (JOB SITES) NORTHERN CALIFORNIA

Six- and seven-hour day eliminated on all Government Work. A. F. L. - O. P. M. Agreement calls for eight-hour day.

NOTE: Predeterminations by the Department of Labor, as of July 1, 1944 (the wage-freezing date) have not yet been made in all of the counties listed. The wage scales shown are those being paid and in effect mostly by agreement between employees and their union.

CRAFT	San Francisco	Alameda and Contra Costa	Fresno	Marin	Sacramento	San Jose	San Mateo	Vallejo	Stockton
ASBESTOS WORKERS.....	1.50	1.50	1.25	1.50	1.50	1.25	1.50	1.50	1.25
BRICKLAYERS.....	1.87½	1.87½	1.75	1.87½	1.75	2.00	1.79-1/6	1.75	1.50
BRICKLAYERS, HODCARRIERS.....	1.40	1.40	1.05	1.40	1.05	1.50	1.35	1.50	1.14
CARPENTERS.....	1.50	1.50	1.50	1.43¾	1.37½	1.37½	1.43¾	1.50	1.37½
CEMENT FINISHERS.....	1.50	1.50	1.50	1.50	1.50	1.50	1.50	1.50	1.50
ELECTRICIANS.....	1.70	1.70	1.70	1.70	1.70	1.70	1.70	1.70	1.70
ELEVATOR CONSTRUCTORS.....	1.75½	1.75½	1.75½	1.75½	1.75½	1.75½	1.75½	1.75½	1.75½
ENGINEERS: MATERIAL HOIST.....	1.50	1.50	1.25	1.50	1.37½	1.62½	1.50	1.37½	1.25
PILE DRIVER.....	1.75	1.75	1.60	1.75	1.75	1.75	1.75	1.75	1.75
STRUCTURAL STEEL.....	1.75	1.75	1.60	1.75	1.75	1.75	1.75	1.75	1.60
GLASS WORKERS.....	1.40	1.40	1.12½	1.40	1.12½	1.21	1.40	1.40	1.40
IRONWORKERS: ORNAMENTAL.....	1.60	1.50	1.60	1.50	1.60	1.31¼	1.50	1.50	1.50
REINF. RODMEN.....	1.50	1.50	1.60	1.50	1.50	1.60	1.50	1.50	1.25
STRUCTURAL.....	1.75	1.75	1.75	1.75	1.75	1.75	1.75	1.75	1.37½
LABORERS: BUILDING.....	1.00	1.00	.90	.87½	.95	.90	.93¾	.90	.90
CONCRETE.....	1.00	1.00	.90	.87½	.95	.90	.93¾	.95	1.00
LATHERS.....	1.75	1.75	1.50	1.75	1.60	1.75	1.75	1.75	1.75
MARBLE SETTERS.....	1.50	1.50	1.50	1.50	1.50	1.50	1.50	1.50	1.50
MOSAIC & TERRAZZO.....	1.25	1.25	1.12½	1.25	1.15-5/8	1.12½	1.25	1.25	1.25
PAINTERS.....	1.50	1.50	1.28-4/7	1.50	1.43	1.50	1.42-6/7	1.64-2/7	1.37½
PILEDRIVERS.....	1.54	1.54	1.54	1.54	1.54	1.54	1.54	1.54	1.54
PLASTERERS.....	1.75	1.83½	1.75	1.75	1.75	2.00	2.00	1.75	1.83-1/3
PLASTERERS' HODCARRIERS.....	1.50	1.50	1.40	1.50	1.18¾	1.50	1.75	1.50	1.50
PLUMBERS.....	1.70	1.70	1.53-1/8	1.70	1.68¾	1.62½	1.70	1.70	1.50
ROOFERS.....	1.50	1.50	1.25	1.37½	1.37½	1.37½	1.25	1.37½	1.37½
SHEET METAL WORKERS.....	1.50	1.50	1.50	1.50	1.50	1.50	1.37½	1.50	1.50
SPRINKLER FITTERS.....	1.58	1.58	1.53-1/8	1.70	1.68¾	1.62½	1.70	1.78	1.50
STEAMFITTERS.....	1.75	1.75	1.53-1/8	1.70	1.68¾	1.62½	1.50	1.70	1.50
STONESETTERS (MASONS).....	1.87½	1.87½	1.50	1.75	1.75	1.50	1.75	1.75	1.50
TILESETTERS.....	1.50	1.50	1.37½	1.50	1.37½	1.50	1.50	1.50	1.37½

Prepared and compiled by

CENTRAL CALIFORNIA CHAPTER, ASSOCIATED GENERAL CONTRACTORS OF AMERICA

with the assistance and cooperation of secretaries of General Contractors Associations and Builders Exchanges of Northern California.

CLASSIFIED ADVERTISING

RATE: 8c PER WORD . . . CASH WITH ORDER

MINIMUM \$1.50 (3 Lines)

ARCHITECT'S REPORTS—A valuable advance news service giving building and construction information daily on projects in Northern California. Name, location, architect, proposed cost, etc., on individual slips. Ideal for securing new business leads. Hundreds of items, total monthly cost only \$10. Don't delay, subscribe today. ARCHITECT & ENGINEER, Room 618, 68 Post Street, San Francisco, California. Phone DOuglas 8311.

ARCHITECTS—A. McF. McSweeney, Architect, Room 927 Hearst Bldg., San Francisco. New offices. Desires catalogs.

FRED MAE, Room 721-22 Hearst Bldg., San Francisco 3, California.

PRINTING—Printers, bookbinders. See us for commercial printing. Mercury Press, 942 Howard Street, San Francisco.

PHOTOGRAPHY—Keep a pictorial record of your building, or construction project. Pictures are of tremendous value to contractors, builders, engineers, architects. For Industrial-Publicity-Aerial photography, see

WANTED—Architectural designer capable of taking charge of office, general practice. Excellent opportunity. Telephone Hlgate 6449, Oakland, California.

HOGAN LUMBER CO.

Wholesale and Retail

LUMBER

MILL WORK • SASH & DOORS

Office, Mill, Yard and Docks

SECOND AND ALICE STREETS • OAKLAND, CALIF.

Telephone GLencourt 6861

CLINTON CONSTRUCTION CO. OF CALIFORNIA

General Contractors

923 FOLSOM STREET • SAN FRANCISCO

SUtter 3440

MALOTT & PETERSON

ROOFING AND FLOORING
CONTRACTORS

20TH AND HARRISON STREETS
SAN FRANCISCO

Phone ATwater 1600

SANTA MARIA INN

SANTA MARIA, CALIFORNIA

FRANK J. McCOY, General Manager

FERNAND E. PIMENTEL, Manager

On the
Coast
Highway
between
San
Francisco
and
Los
Angeles



American
or
European
Plan
•
Old
English
Tap
Room

A. I. A. ACTIVITIES

(From Page 31)

inability of anyone to get anything built. We would like to have an electrical transcription of some of our talks with clients in about 1935-36 to compare with the negative attitude of the present. Some of it sounds like the Col. Stoopnagel stories because it is hard to picture an Architect telling a client to beat it and not interrupt an alleged chain of thought. The old story of 'Man bites dog.'"

NORTHERN CALIFORNIA CHAPTER

A report by Arthur C. Holden to the Executive Committee of the A. I. A. relative to the existing Code of Ethics, points out, "The test of professionalism is technical competence and moral integrity. Neither depends upon whether a man is employed full or part time or on a salary or a fee basis, or by a contractor as opposed to any other employer . . . The Architect's position is one of trust. The Architect must give the time required for the solution of the project irrespective of the cost of services. The Architect, however, cannot impose his solution on his client; he must necessarily adapt his own desires to the budget and the personality of his client. The Architect must use the same type of discretion and the same self sacrifice in finding a solution within the limits of budget and desires of his employer, whatever the status of his employer. If the Architect is employed on a salary basis, the employer pays for the architect's time. It is not the method of employment but the competence, the integrity and the responsibility of the Architect which counts."

ARCHITECTS AND U. N. O.

Formation of a nation-wide committee of leading architects, selected to provide the best ability and experience of the American architectural profession, is planned as a contribution towards development of the new United Nations Capital, has been announced by the American Institute of Architects.

In making available this professional experience, Institute officials declared they were not interested in the site, but were "assiduously interested in seeing that physically the U. N. O. Capital shall measure up to the objectives of the U. N. O.," and that "is more than likely the architecture here established will set a pattern for future generations."

A. I. A. ANNUAL CONVENTION will be held May 6 in Florida.

RALPH J. BISHOP, Architect, very cleverly announces the moving of his offices to 218 Great Northwest Life Building, Spokane 8, Washington.

IN THE NEWS

HEADS EXECUTIVE COMMITTEE AMERICAN STANDARDS ASSOCIATION

Howard Coonley, former president of the National Association of Manufacturers and of the American Standards Association, has been named head of a new Executive Committee who will have charge of the financial, administrative and executive direction of the organization.

During the recent War, Coonley served as advisor to the Chinese Government in establishing the Chinese War Production Board and getting it into actual operation.

BLIGHTED

Steps by which California communities may take advantage of the Community Redevelopment Act of 1945 are shown in a report, "Blighted," which was recently released by the State Reconstruction & Re-employment Commission.

Elimination of slum conditions, and the economic and social improvement of the general public, through a program of community cooperation is covered in the new booklet.

U. S. SURPLUS ARCHITECTURAL AND ENGINEERING EQUIPMENT

Quantities of architectural and engineering equipment declared surplus by the armed forces are being offered for sale to governmental agencies, veterans and tax exempt educational institutions.

Disposal of 2000 proportional dividers, 7/8 inch with case; 33000 drawing boards including those with folding or adjustable trestles; 80000 rolls of tracing cloth, ink type, in standard size rolls; 47000 architects' and engineers' triangular boxwood scales; and 64000 rolls, 26000 pads and 2000 gross loose sheets of tracing paper, is being conducted through 11 regional consumer goods offices maintained by the War Assets Corporation.

Western offices include: 1030 15th Street, Denver, Colo.; 30 Van Ness Avenue, San Francisco, Calif.; and 2005 5th Avenue, Seattle, Wash.

EMERGENCY CUTTING OUTFIT

Originally designed for the U. S. Navy, an emergency pack type cutting outfit manufactured by the VICTOR EQUIPMENT COMPANY, San Francisco, is now being offered to fire departments, rescue squads, state highway police and industry.

Known as the VICTOR Pack Type emergency cutting outfit, it is compact and portable for easy handling.

VERMONT MARBLE COMPANY

Producers and Finishers
of
Domestic and Imported Marbles

Write for new pamphlet describing our
Marble Toilets and Showers

San Francisco and Los Angeles

San Francisco phone: SUTTER 6747



The Most Complete Line of
STEELS and BUILDING MATERIALS
Made by a Single Producer



See Sweet's Catalog File or write us for
full information.

REPUBLIC STEEL CORPORATION

GENERAL OFFICES: CLEVELAND, OHIO

DENVER, COLORADO CONTINENTAL OIL BUILDING
LOS ANGELES, CALIFORNIA EDISON BUILDING
SALT LAKE CITY, UTAH WALKER BANK BUILDING
SAN FRANCISCO, CALIFORNIA RIALTO BUILDING
SEATTLE, WASH. WHITE-HENRY-STUART BUILDING

PACIFIC MANUFACTURING CO.

HIGH CLASS INTERIOR FINISH
QUALITY MILLWORK

142 SANSOME ST., SAN FRANCISCO
GARfield 7755

6820 McKINLEY AVE., LOS ANGELES
THornwall 4196

BUILDERS EXCHANGE, OAKLAND

"AMERICAN - MARSH"

CONDENSATION UNIT

Pumping
Machinery
for
Every
Purpose

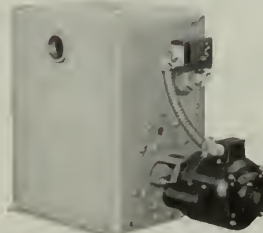

For Service
Call
DOuglas
6794
or
MUtual 8322

SIMONDS MACHINERY CO.

SAN FRANCISCO
816 FOLSOM

LOS ANGELES
455 EAST 4TH

Real Estate Loans



F H A loans are readily available on existing homes up to 80% of the appraised value. You can buy a home and pay for it in small monthly installments like rent. For example, a 20-year loan of \$6000 would cost about \$49.56 per month, including taxes, insurance, principal and interest.

*Come in and talk with us
We can help you get the home
you want*

CROCKER FIRST NATIONAL BANK

OF SAN FRANCISCO
California's Oldest National Bank
ONE MONTGOMERY STREET
Member Federal Deposit Insurance Corporation

To bring out and preserve the beauty of Exterior Redwood in its natural color use

Cabots # 230 Clear

OR

to give it an old weathered driftwood grey use

Cabots # 241

Bleaching Oil

OR

to stain or actually dye it in a wide range of colors use

Cabots Creosote Stains

Distributed by

GUNN CARLE and CO.

20 POTRERO AVENUE
SAN FRANCISCO 3
UNderhill 5480

IN THE NEWS

ACCIDENTS REDUCED

Improved lighting of main thoroughfares in cities throughout the Nation have decreased night accidents as much as 55 per cent a year in one Eastern city.

NEW BLOWERS

New overhead blower for low temperature cooling, incorporating engineering experience gained through years of production, now

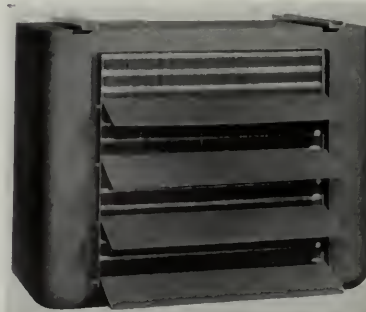

being produced by THE REMPO CO., 340 No. Sacramento Blvd., Chicago, Ill.

Housed in modern steel bonderized case of grey wrinkle baked enamel finish, they use all types of refrigerant including brine and prestone. All tubes and bends are of full area, while the louvers are individually adjustable to permit controlled flow of air.

HEAT-O-METER

A new calculating device for determining the correct amount of radiation required for Steam and Hot Water heater systems, eliminates tedious figuring; contains a surprising amount of other valuable heating data.

Comprising three concentric celluloid printed discs, the HEAT-O-METER is convenient in size. Manufactured by HEAT-O-METER, 424 W. 42nd Street, New York 18.

WELDWOOD GLUE

United States Plywood Corporation announces that supplies of Weldwood Glue are again open to unlimited civilian use.

U. S. SAVINGS BONDS

The Treasury will continue to sell "E", "F", and "G" bonds as a plan of savings for the American citizen during 1946.

JOHN D. McLAUGHLIN

Consulting Electrical Engineer

Electrical Designs

Industrial Power and

Lighting Layouts

Airport Lighting Design

SERVICES FOR

ARCHITECTS AND ENGINEERS

1641 Russ Building

San Francisco, California

Telephone EXbrook 5712

KYLE FORREST

Civil Engineer

Water Supply — Sanitation

Municipal — Private

Consultations — Investigations

Reports — Designs — Valuations

Supervision — Litigation

Ground Water Work a Specialty

Hydrologic studies — wells, de-watering, underdrainage, foundations, conservation, testimony.

1504 Russ Building

San Francisco 4

YUkon 0652

Built-In Fixtures for the Post-War Home

Paramount Fixtures will fit your post-war needs . . . investigate our new kitchen ideas which make for convenience and efficiency.

Paramount Built-in Fixtures meet the most exacting requirements. Our "Deluxe," "Moderne" and "Economy" cabinet fixtures are distinctive in design and construction and may be had in stock sizes or built to order.

Catalog for the asking

Paramount
BUILT-IN FIXTURE COMPANY
5107 Broadway, Oakland, California
Phone Pledmont 8100

JOHN CASSARETTO COMPANY

—Since 1886—And Still Active—

Building Materials

READY MIX CONCRETE
ROCK - SAND - GRAVEL - LIME
CEMENT - PLASTER - MORTAR
METAL LATH - WOOD LATH
STUCCO - WIRE NETTING

Service Unexcelled

Bunkers

Sixth and Channel, San Francisco
Phones: GARfield 3758 - 3760

MULLEN MFG. COMPANY

BANK, STORE AND OFFICE
FIXTURES—CABINET WORK
OF GUARANTEED QUALITY
CHURCH SEATING

Office and Factory:

60-80 RAUSCH ST., Bet. 7th and 8th Sts.
San Francisco
Telephone UNDERhill 5815

THE TORMEY COMPANY

GENERAL PAINTERS
AND DECORATORS

Phone UNderhill 1913

563 FULTON STREET
San Francisco

G. P. W. JENSEN & SON

Building Construction

320 Market Street, San Francisco

Phone: GARfield 2444

IN THE NEWS

VALUATION SERVICE

FHA is offering prospective home buyers an "unbiased appraisal system" at a charge of \$10. After February 1st the charge becomes a "must" on conditional commitments for FHA insurance of mortgages on small homes under Section 203 NH Act.

HOT FOOT

Electrically heated rugs have been designed for invalids, for use on floors where babies play, or for those who suffer from chilled feet.

TWEEZER SPOT WELDER

Something new in spot welding is the portable BESCO Tweezer which weighs only 25 pounds, and is about the size of a small radio.



A pair of insulated forged copper tweezers are connected with the unit which is operated with a foot switch.

Applications are unlimited for industries fabricating metal parts measuring .0005" to 1/8" round or thick. Plugs into 115V. 60 cycle power supply and may easily be adapted for 220V.

Complete data is available from TWEEZER-WELD Corporation, 280 Plane Street, Newark 2, N. J.

LEADER

Los Angeles continues to hold the spotlight in volume of construction among cities of the Pacific Slope States. San Francisco is second and Portland fourth according to latest figures.

AIRCO

Air Reduction, 60 East 42nd Street, New York, have issued a new catalog on arc welding accessories and equipment.

ANDERSON & RINGROSE

General Contractors

320 Market Street, San Francisco

Phone GARfield 2245

DINWIDDIE CONSTRUCTION COMPANY

BUILDERS

CROCKER BUILDING
SAN FRANCISCO



HERRICK IRON WORKS

STRUCTURAL STEEL
REINFORCING STEEL

18TH AND CAMPBELL STS.
OAKLAND, CALIF.
Phone GLencourt 1767

Phone GARfield 1164

Thomas B. Hunter

Consulting Engineer

DESIGNER OF HEATING
AIR CONDITIONING
VENTILATING AND WIRING
SYSTEMS, MECHANICAL
AND ELECTRICAL EQUIP-
MENT OF BUILDINGS

41 SUTTER STREET
ROOM 710

San Francisco California

George F. Brayer

ELECTRICAL
CONTRACTOR

166 Seventh Street
San Francisco

Phones: KLondike 2-0879
HEmlock 2646

SMITH, EMERY & CO.

Since 1904

Engineers - Chemists

Inspection, Tests, Analyses,
Research, Consultation
Structural Materials, Structures,
Equipment, Pipe, Soils

Associates

Los Angeles and Eastern Cities

Offices and Laboratories

651 Howard Street, San Francisco

A. F. MATTOCK CO.

Builders

★

212 CLARA STREET
SAN FRANCISCO

INDEPENDENT IRON WORKS

Steel Buildings
Service Stations
Steel Storage Tanks
Fabricated Plate Work
Steel & Sheet Metal Products
Fabricated Structural Steel
Steel Distributors

Eighth & Pine Sts. Oakland, 7

Index to Advertisers

ALADDIN Heating Corp.	48
ANDERSON, & Ringrose	47
ANGIER Sales Corporation	30
ARCHITECTS Reports	40
BASALT Rock Company	39
BAXTER & Company, J. H.	34
BRAYER, Geo. F.	48
CASSERETTO, John	47
CLARK, N., & Son	*
CLASSIFIED ADVERTISING	43
CLINTON Construction Company	44
COLUMBIA Steel Co.	*
COLOTYLE Corporation	*
CROCKER First National Bank	46
DINWIDDIE, Construction Company	47
FORDERER, Cornice Works	39
FORREST, Kyle	46
FULLER, W. P., Co.	36
GUNN, Carle & Company	46
HANKS, Inc., Abbot A.	48
HAWS Drinking Faucet Company	Back Cover
HERRICK Iron Works	47
HOGAN Lumber Company	44
HUNT, Robert W., Company	48
HUNTER, Thos. B.	47
IMPERIAL Brass Manufacturing Co.	*
INDEPENDENT Iron Works	48
JENSEN & Son, G. P. W.	47
JOHNSON, Company, S. T.	*
JUDSON, Pacific-Murphy Corp.	39
KRAFTILE Company	*
KAWNEER Company	*
MALOTT & Peterson	44
MATTOCK, A. F.	48
McLAUGHLIN, John D.	46
MULLEN, Mfg. Co.	47
MUELLER Brass Co.	*
NORTHERN California Electrical Bureau	35
OWENS Corning Fiberglas Co.	*
PACIFIC Coast Gas Association	*
PACIFIC Manufacturing Company	45
PACIFIC Portland Cement Company Inside Back Cover	
PACIFIC Telephone & Telegraph Co.	33
PARAMOUNT Built-in Fixture Co.	46
PARKER, STEFFINS & PEARCE	*
PAYNE Furnace & Supply Co., Inc.	*
PORTLAND Cement Association	*
REID, Allen Himes.	43
REMILLARD-Dandini Co.	48
REPUBLIC Steel Corporation	45
SANTA Maria Inn	44
SCOTT Co.	*
SIMONDS Machinery Company	45
SISALKRAFT Company	39
SMITH, Emery & Co.	48
SMOOT-Holman Co.	37
STANLEY Works, Inc., The	40
SOULE Steel Co.	*
TAYLOR Co., Halsey W.	29
TIMBER Engineering Co., Inc.	*
TORMEY Company, The	47
UTILITY Appliance Corp.	*
U. S. STEEL	*
VERMONT Marble Company	45
WESIX Electric Heater Co.	*
WESTERN Asbestos Company Inside Front Cover	
WOOD, E. K., Lumber Company	36

* Indicates Alternate Months

A L A D D I N

Heating Corp.

Specializing in

QUALITY HEATING
EQUIPMENT

2222 San Pablo Avenue

OAKLAND

TWinoaks 1022

ABBOT A. HANKS, INC.

Engineers & Chemists

INSPECTING — TESTING — CONSULTING
CONCRETE • STEEL • MATERIALS
CHEMICAL AND TESTING
LABORATORIES

• RESEARCH AND INVESTIGATION •

TESTS OF STRUCTURAL MATERIALS
DESIGN OF CONCRETE MIXES
SHOP AND ERECTION INSPECTION OF
STRUCTURES AND EQUIPMENT
INVESTIGATION OF STRUCTURES
AND MATERIALS
TESTS AND INVESTIGATION OF
FOUNDATION SOILS
FIRE RESISTANCE AND INSULATION
TESTS

624 Sacramento Street, San Francisco

Robert W. Hunt Company

ENGINEERS

Inspection - Tests - Consultation

Schools and Other Structures
Are Built as Designed

When Construction Materials are
Inspected at point of Manufacture
and during Erection by

ROBERT W. HUNT COMPANY

Cement, Concrete, Chemical, Metallurgical
X-Ray and Physical Laboratories

Chicago - New York - Pittsburg
Los Angeles - All Large Cities
San Francisco, 251 Kearny Street

REMILLARD-DANDINI CO.

Brick and
Masonry Products

★

633 BRYANT ST., SAN FRANCISCO

569 THIRD ST., OAKLAND

ARCHITECT AND ENGINEER



APRIL

1946

**The experience of over
4,000 acoustical installations
...is at your service**



*Acousti-Celotex installation — office of the
Western Pacific Railroad Co., San Francisco*



*Sound conditioning increases efficiency at
The Western Union Telegraph Co., Oakland*



*Acousti-Celotex provides quiet in these
offices, Kraft Cheese Co., San Francisco*



*Sound conditioned assembly and motor test
room, Caterpillar Tractor Co., San Leandro*



*Acousti-Celotex sound conditioning, general
office, Fairbanks Morse & Co., San Francisco*



THE great reservoir of our experience, gained in over 4,000 acoustical installations, is daily solving sound conditioning problems in all types of offices and factories.

This practical knowledge is available to you *only* through Western Asbestos Co., for our organization has analyzed, engineered and installed more sound conditioning in this area than any other firm in the acoustical field.

The combination of this experience with the world's most widely proved and used acoustical materials—Acousti-Celotex products—is your complete assurance of a job well done. The counsel and recommendations of a sales engineer are at your service, entirely without obligation.

WESTERN ASBESTOS CO.

DISTRIBUTORS • ENGINEERS • CONTRACTORS

YOUR BLOOD CAN SAVE LIVES—BE A DONOR TODAY!

ARCHITECT

Vol. 165

No. 1

AND ENGINEER

ARCHITECTS' REPORTS—Published Daily

Telephone DOuglas 8311

E. H. WILDER
Editor

MARK DANIELS, A.I.A.
Associate Editor

JOHN S. BOLLES, A.I.A.
Book Reviews

MICHAEL GOODMAN
Post-War Planning

L. H. NISHKIAN
Consulting Editor

E. N. KIERULFF*
Ass't Editor
*In the Service



Contents for

APRIL

COVER: WINDOW IN THE MASONIC TEMPLE, Lodi, California

ARTICLES AND MISCELLANEOUS TEXT

EDITORIAL NOTES	4
ARCHITECTURAL SCHEDULE OF FEES	6
PERCENTAGE BASIS	
NEWS AND COMMENT ON ART	8
REFERENCE FRAMES IN SPACE	10
By R. M. SCHINDLER, Architect	
THE CHURCH for St. Marks in The Valley	11
MODEL of the Mesa Campus Site, Santa Barbara College—University of California	12
By WINSOR SOULE, A.I.A.	
CHEERFULNESS IN LIVING	14
By ALLAN H. REID, Landscape Architect	
NEW MILL DEPOT, BETHLEHEM STEEL CO.	15
ARCHITECTURE FOR LEISURE	16
By HUBERT E. BOYD	
MODERN STAINED GLASS IN ARCHITECTURE	19
By HAROLD W. CUMMINGS	
OPA PRICE ADJUSTMENTS	26
LENINGRAD TO BE MODEL OF RUSSIA'S BEST CITY	26
HYGIENIC REASONS FOR PAINTING WALLS AND CEILINGS	28
By WALDEMAR SCHWEISHEIMER, M.D.	
IN THE NEWS	30, 37, 43, 46, 47
A.I.A. ACTIVITIES	31
WITH THE ENGINEERS	32
HEADLINE NEWS & VIEWS	34
By E. H. W.	
PRODUCERS' COUNCIL PAGE	38
ESTIMATOR'S GUIDE	41
CLASSIFIED ADVERTISING	43
BOOK REVIEWS	45
INDEX TO ADVERTISERS	48

ARCHITECT AND ENGINEER (Established 1905) is published on the 15th of the month by The Architect and Engineer, Inc., 68 Post St., San Francisco 4; Telephone EXbrook 7182. President, K. P. Kierulff; Vice-President and Manager, L. B. Penhorwood; Treasurer, E. N. Kierulff.

Los Angeles Office: Wentworth F. Green, 1709 West Eighth Street.

Entered as second class matter, November 2, 1905, at the Post Office in San Francisco, California, under the Act of March 3, 1879. Subscriptions United States and Pan America, \$3.00 a year; \$5.00 two years; foreign countries \$5.00 a year; single copy 50c. ARCHITECTS' REPORTS are published daily from this office, Vernon S. Yallop, Manager.



EDITORIAL NOTES

A BETTER UNDERSTANDING WILL RESULT

It was our privilege recently to attend a joint meeting of the Structural Engineers Association of Northern California and the Northern California Chapter of the American Institute of Architects held in the Engineers Club of San Francisco.

Some two hundred representatives of these two age-old professions, together with a few guests, heard a very learned and scholarly presentation, and then joined in a general discussion, of the subjects: "An Approach To A Rational Solution Of The Earthquake Problem," by Mark M. Falk; "Conflicting and Overlapping Regulations Affecting Building Design," by Vincent G. Raney; and "Suggestions for Improvement of Fire Proofing Requirements in Building Codes," by Harold M. Engle.

The fact that the audience represented men and women from Los Angeles and southern California, the Sacramento and San Joaquin Valleys, Monterey Peninsula, and the San Francisco-Oakland metropolitan area, was sufficient indication that the subjects under consideration were of paramount importance to the professions, and that the speakers selected to present them were exceptionally well qualified to do so.

Whether there was a complete meeting of all minds present on numerous points under consideration, which obviously have long represented a difference of opinion, is immaterial.

The important thing is that such a large group of outstanding leaders within these important professions, representing a wide territorial section of the Nation, can sit down at a table and talk freely about the ramifications of their respective professional endeavors.

Perhaps the adoption of a "uniform building code" by all cities and communities of the United States should be an ultimate goal of architects, engineers, and contractors, and possibly the time may come when this objective is reached.

However, it is well for even the most enthusiastic advocate of such a program to remember that as long as the people of this Nation enjoy individ-

ual liberty and personal freedom, and just as long as there exists free enterprise among men and women engaged in the practice of architecture, engineering, contracting and all other phases of commercial endeavor, there is bound to be differences of opinion—some of it good, and some bad.

It has taken the present generation, paced by governmental bureau and agency policies, to reach a state of conducting "business by influence", or by "pressure groups." Such business fundamentals as hard work, personal sacrifice, and diligent application of effort to accomplish results have been pretty much replaced by "Who do you Know?," or "Do you know the Right People?."

In all probability the next generation will look upon these current requisites of business as "old fashioned", and will substitute in their place some new phase of business operation based upon conditions of national economy, political thinking, and individuality of mind existant at that time.

Regardless of what coming generations may accept as their basic approach to any professional, economic, or business problem, the fact that truly great leaders of professions can and do get together today for frank industry discussions, is bound to reduce the complexities of tomorrow.

ELLIS FULLER LAWRENCE, prominent Portland architect and educator, died February 27, 1946. Born November 13, 1879 at Maldin, Massachusetts, he received his bachelor of science degree from the Massachusetts Institute of Technology, Boston, in 1901 and his master of science degree from there in 1902. Prior to moving to Oregon he traveled extensively in Europe.

He became Dean of the School of Architecture and Allied Arts at the University of Oregon in 1914, and Dean Director of the Division of Architecture and Allied Arts in 1932, a position which he held at the time of his death.

He is survived by his wife of Portland and three sons: Henry Abbott Lawrence, Architect, Portland, and Amos M. and Dennison H. Lawrence of California.

Spanish in design "Modern American" in Comfort



Reflecting the old Spanish influence so characteristic of Santa Barbara architecture, this edifice nevertheless is "modern American" in equipment. ★ PAYNE gas warm air heating . . . selected for advanced engineering, quality construction and unfailing dependability . . . assures comfort in any weather. ★ Architects and builders are urged to investigate the many applications of PAYNEHEAT to commercial and industrial jobs and public buildings. Consult your nearby PAYNE Dealer or your gas company. . . or write to us. ★ PAYNE factory engineering service "tailors" the installation to the job. Consultation is invited.

PAYNEHEATED Unitarian Church
Santa Barbara, California
Architect, E. Keith Lockhard



PAYNE ZONE-CONDITIONING

*Successor to old-fashioned
central heating*

Circulated winter warmth,
summer ventilation with
forced-air models . . . controlled
by "zones" (suites)
or individual rooms.

WRITE FOR FREE
BOOKLET



PAYNE FURNACE COMPANY
(One of the DRESSER Industries)
BEVERLY HILLS, CALIFORNIA

PAYNEHEAT
OVER 30 YEARS OF LEADERSHIP



ARCHITECTURAL SCHEDULE OF FEES

(PERCENTAGE BASIS)

AMERICAN INSTITUTE OF ARCHITECTS: NORTHERN CALIFORNIA CHAPTER, SOUTHERN CALIFORNIA CHAPTER, SANTA BARBARA CHAPTER, CENTRAL VALLEY OF CALIFORNIA CHAPTER, AND THE SAN DIEGO CHAPTER*

Following is a brief statement of the percentage method of paying for architectural services, issued in the interest of both the client and the architect. It is intended to indicate standard practice concerning services rendered by the architect, and fees for various types of work. Experience has shown that these charges are required for professional services resulting in satisfaction to both client and architect, with a legitimate profit to the architect.

This schedule of architectural fees is based upon a percentage of the total construction cost of the work to the client. It is to be regarded as a plan of minimum charges to serve as a basis for discussion and negotiation of a working agreement with the client. These charges are for complete architectural services and include structural, electrical and engineering services required for the work. Structural engineering includes design for earthquake conditions.

The architect's services include consultation with the client, preparation of sketches, preliminary estimates, working drawings, specifications, detail drawings, taking of bids, preparation of contracts, administration, accounting, certification of payments to contractors, and general supervision of the construction work.

The architect's fee does not include the cost of the following: superintendence by a full time in-

spector or clerk of the works, the cost of soil tests or engineering surveys, the cost of governmental inspection, permit and inspection charges by governmental agency, governmental checking and approval of instruments of service.

Partial architectural services are not generally recommended.

The percentage basis is perhaps the most usual method of establishing an architectural fee. It is not always the most desirable or practical method from either the client's or the architect's standpoint. At a later date, the California Council of Architects plans to expand this statement, and will issue information relative to other methods of rendering architectural services.

However, even when not directly used, the percentage method has value in arriving at a more appropriate plan of payment. No two clients' problems are ever exactly alike.

Friendly client relationships, so essential for successful conclusion of the work, are not bought with low fees and slovenly service.

FEE GROUPS

The cost to the Architect of producing sketches, studies, designs, contract documents and other categories or service varies considerably according to building type; that is, different types of buildings require different amounts of architectural service. For this reason the percentage rates must vary according to some scheme or classification of building type.

Following is a short list of building types ar-

* The California Council of Architects also includes the Northern California Association of Architects and the Southern California Association of Architects. Both associations automatically expired when the AIA unification program in California was completed.

ranged by percentage groups. It is by no means an exhaustive list but is intended to assist in working out some reasonable and proper working or contract basis.

Exact definitions of amount of fee are not always easily determined, nor is a mandatory attitude desirable, but still, the percentages shown may reasonably be regarded as minimum.

GROUP I. Fee 6 per cent

- Lofts
- Factories (simple)
- Exposition and Fair Buildings (temporary)
- Market Buildings
- Work of like nature and complexity

GROUP II. Fee 7 per cent

- Hotels, Apartments and Multiple Dwellings
- Banks
- Store Buildings
- Office Buildings
- Industrial Buildings
- Work of like nature and complexity

GROUP III. Fee 8 per cent

- Schools
- Churches
- Theaters and Auditoriums
- Governmental Administrative Buildings
- Hospitals, Children's Homes and Homes for the Aged and Indigent
- Clubs, Lodges and Fraternity Houses
- Mausoleums (public)
- Work of like nature and complexity

GROUP IV. Fee 10 per cent

- Residences
- Swimming Pools
- Tennis Courts
- Shop Fronts
- Fixtures
- Combined Shops and Residences
- Mausoleums (private)
- Monuments
- Work of like nature and complexity

GROUP V. Fee 15 per cent

For work involving much detail, such as Designing of Furniture, Lighting Fixtures, Special Fitments, Screens, Counters, etc.; Interiors and other detailed parts or appurtenances of buildings or structures, especially when they are not designed as part of a complete building project.

DUPLICATION

For buildings classified under Groups I and II if they are large projects and involve much duplication of units or of floor arrangements the minimum fee may be reduced not more than one per cent.

ALTERATIONS AND ADDITIONS

For alterations the minimum fee for buildings in all groups shall be increased by from 25 per cent to 50 per cent but this increase shall in general apply only to the cost of the alteration to the existing structures and not to the cost of additions beyond the alterations.

SEGREGATED CONTRACTS

Increased minimum fees shall be charged in all groups if segregated contracts are required. The minimum increase shall be 4 per cent of the value of the contracts segregated from the general contract but the increase shall not apply to the work remaining in the general contract.

FEES HIGHER THAN MINIMUM

Fees higher than the minimum are in no wise prohibited and are proper in all cases where the building problem is of greater complexity than the average of its kind, and would result in an increase in the architect's costs; or where special services are required; or where the reputation and ability of the architect command a large professional fee, or where the building project scope is relatively small.

SUBDIVISION OF THE ARCHITECT'S FEE

Payments on account of the architect's fee shall be made on a monthly basis or on the basis of progress as follows:

Upon completion of the preliminary studies a sum equal to 20 per cent of the basic rate computed upon a reasonable estimated cost.

Upon completion of specifications and general working drawings (exclusive of full size details) a sum sufficient to increase payments on the fee to 75 per cent of the basic rate, computed upon a reasonable estimated cost based on such completed specifications and drawings, or if bids have been received, then computed upon the lowest bona fide bid or bids.

The balance of the fee shall be paid on a monthly or periodic basis, during the course of construction.

—
Data courtesy of California Council of Architects, 369 Pine Street, San Francisco 4, California.

NEWS AND COMMENT ON ART

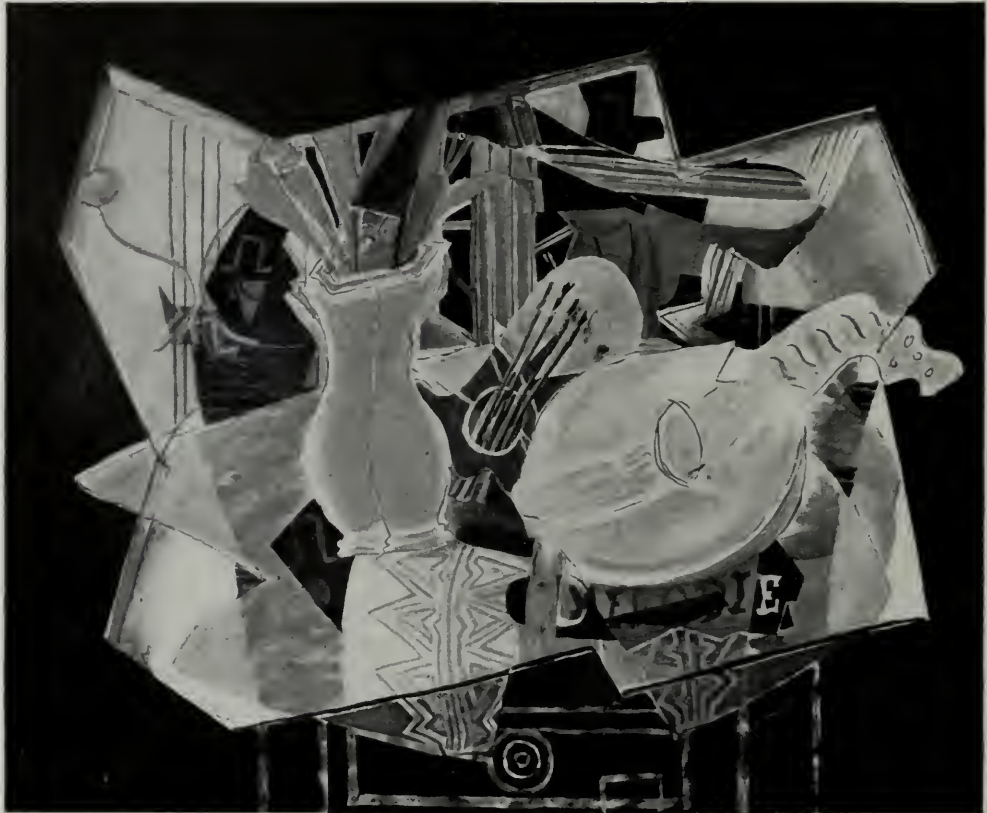

VASE, PALLETTE and MANDOLIN an Oil by Georges Braque (From the Permanent Collection of the San Francisco Museum of Art, a gift by W. W. Crocker)

ABSTRACT ART

Georges Braque (b.1882-) was one of the important figures, together with Picasso (b.1881-), in establishing what today is considered abstract art. Braque's particular form of abstraction was known as CUBISM.

He was the first actual exhibitor of an abstract picture, although he and Picasso worked closely together on its development.

Jan Gordon, writing in "Modern French Painters" says: "Cubism is the painters equivalent to architecture, or we may say that architecture is a variety of cubist sculpture."

Cubism developed into the art of organized space, linear form, movement and color, and dissociated from realistic appearance those forms of art which are today designated as non-objective, or New-Realism, Surrealism, Tantasist art and other denominations.

OAKLAND FLOWER SHOW

Of special interest to the planning profession and public is the exhibition of drawings to be featured as the Oakland Flower Show in the Oakland, California, Exposition Building from April 30 through May 6, 1946.

Prepared by members of the Association of Landscape Architects, and arranged by M. Halberstadt photographer and designer, the exhibit will feature an extensive collection of drawings showing many proposed projects through the planning stage.

Photographs of projects during and after construction will clearly portray the character of landscape work.

CALIFORNIA PALACE, LEGION OF HONOR APRIL EVENTS

A special schedule of organ music for the month has been arranged and will be played by Uda Waldrop, official organist.

Programs will be presented each Saturday and

Sunday at 3 p. m., starting April 6.

The April 20 (Saturday) and April 21 (Easter Sunday) programs will be the same and will be devoted to Easter Music, including the following: Easter Morning on Mt. Rubidoux, Harvey B. Gaul; Awake, Thou Wintry Earth, J. S. Bach; Easter song, "Hosanna", Gabriel Faure; Christ Triumphant, Pietro A. Yon; Improvisation on two Chorales:

"All Glory, Laud and Honor" and "Bourgeois," A. G. Y. Brown; Easter Alleluia, J. J. Baird; Ava Maria, Franz Schubert Chorale—"Sing, Pray and Walk at God's Direction", J. S. Bach; Paradise, Z. Fibich; Arisoso—"Thanks be to Thee," by Handel.

Special and request numbers will be played on the programs of April 27 and 28.

EXHIBITIONS

First Spring Annual Exhibition, April 3 to 30: The Alma de Bretteville Spreckels Collection of Sculpture, Tapestries and Furniture; and the Collis Potter Huntington Memorial Collection of 18th Century French Paintings, Sculpture, Tapestries, Furniture, and Porcelain.

MOTION PICTURE SERIES

Each Saturday at 2:30 p. m.—Admission Free.

EDUCATIONAL ACTIVITIES

Children's Classes, sessions in painting and drawing (6 through 8, and 9 through 12) from 10:30 o 11:45 a. m. each Saturday.

Adults, painting classes each Saturday from 2 o 4 p. m.

CALIFORNIAN WINNER

Among the 24 prize winning designs in the Chicago Tribune's recent prize-home competition, an event hotly contested by work submitted from architects throughout the nation, is a plan submitted by Merwin H. Freeman of Los Angeles, California.

Mr. Freeman won \$1000 in cash. More than 172 designs were submitted in the contest.

SAN FRANCISCO MUSEUM OF ART

Exhibitions at the War Memorial Building, Civic Center, San Francisco during the month of April will include:

Federico Cantu of Mexico, Watercolors and drawings, April 3 to 28

Marguerite Wildenhain, Stoneware and Pottery April 9 to 30

10 Annual Watercolor Exhibition of the San Francisco Art Association April 17 to May 5.

Among Activities scheduled for the month is the Studio Workshop and Sketch Club for amateurs and professionals, with competent guidance by George Harris, each Wednesday and Friday evening from 7 to 9 p. m.

The Childrens Saturday Morning Art Sessions,

with sympathetic guidance which enables the child to develop individuality and originality in his approach to art, will be conducted by Nora Lee Rohr each Saturday morning 10 to 11:30—ages 6 to 14.

FILM SHOWINGS will include a **KNOW YOUR WORLD SERIES** on Saturdays and Sundays at 2:30 p. m., and a **FAMOUS FILM SERIES** each Tuesday evening at 8 o'clock.

NEW FIRM

Announcement has been made of the formation of the firm of ECKBO, ROYSTON & WILLIAMS with offices at 21 Columbus Avenue, San Francisco, and 624 S. Carondelet, Los Angeles.

Partnership in the company includes Garrett Eckbo, Robert Royston and Edward Williams, and the firm will engage in the general practice of Planning Consultants, Landscape Architects, and Site and Recreation Planners.

STERN HALL

UNIVERSITY OF CALIFORNIA



Window curtains and seat cushions are same colors; tanhide tables, Mexican pottery lamp bases, bleached Philippine mahogany walls with plywood panels, and black floor, all combine to form the pleasure and comfort of this room. (Frances Elkins, Decorator).

Reference Frames in Space

By R. M. SCHINDLER, Architect

"Builder must check all measurements and be responsible for correctness."

This sentence, which all prudent architects print on their plans, reveals one source of professional worry and grief. However, instead of shifting the responsibility to the builder, they both could eliminate it altogether by replacing the old scheme of figured measurements with a unit system. Such a system replaces the confusing figures representing inches, centimeters, and their fractions by a standard unit which is established right on the plan by a grid of lines which fixes the location and size of building parts visually and at a glance.

For some strange reason this simplification of designing and building is resisted by almost everybody concerned. I started to use the unit system twenty-six years ago and have used it ever since, even though I have been forced, frequently, to make duplicate conventionally measured plans without grid lines for submission to building departments and finance companies.

Recently, the Producers' Council sent me an olive branch in the form of a pamphlet advocating the use of a four-inch module for all building work. This replacing of the inch by a slightly larger (four-inch) base measurement might help the manufacturer in standardizing his product, but it neglects to fill the real need of the architect. He wants to be relieved of hours of measuring, figuring and checking. He needs a unit of dimension which is large enough to give his building scale rhythm and cohesion. And last, but most important for the "space architect," it must be a unit which he can carry palpably in his mind in order to be able to deal with space forms freely but accurately in his imagination.

"Scale" denotes a consistent dimensional relationship of parts of a structure to each other and to a basic unit. This unit in a dwelling is quite naturally the human figure although in a palace

it might be the imaginary stature of the king. The maintenance of "scale" throughout the building is one of the most difficult feats of the architect and there are very few buildings which do not contain parts stricken by gigantism or dwarfism.

Only the architect devoid of feeling can fail to respond to the rhythmic undertone which the standard equal spacing of joists and studs gives the building, and only coarseness allows him to break that rhythm by introducing arbitrary unrelated dimensions into his layout. We human beings are unable to understand both time and space without a rhythmic key, which the architect should provide in his plans.

Rhythm is a space relationship. It cannot be achieved by an arithmetical repetition of the same part but must be maintained by related spacings of parts, whether they are similar or not. As in music, such a rhythmic scheme may be simple repetition or the more subtle interlocking of several rhythms. It is practically impossible to maintain such an interlacing rhythmic play on a plan indicating dimensions by figures. Even the four-inch module would not help, since such a small unit tends to create texture rather than rhythm.

To the space architect, however, a proper unit system is essential. Only two-dimensional plans can be worked out visually on paper. The space-architect deals with space-forms which must be visualized and created in his mind. The only way to really perceive a "space-form" is by being inside of it and therefore no perspective or model, even though it were sectional or transparent, could help much in designing space. In order to succeed with this difficult feat the architect not only has to have a special mental gift but he also needs a special frame of reference in order to develop his mental image. He must establish a unit system which he can easily carry in his mind and which will give

(Continued on Page 40)

WINDSOR SOULE

&

JOHN FREDERICK MURPHY

Architects, Santa Barbara,

California

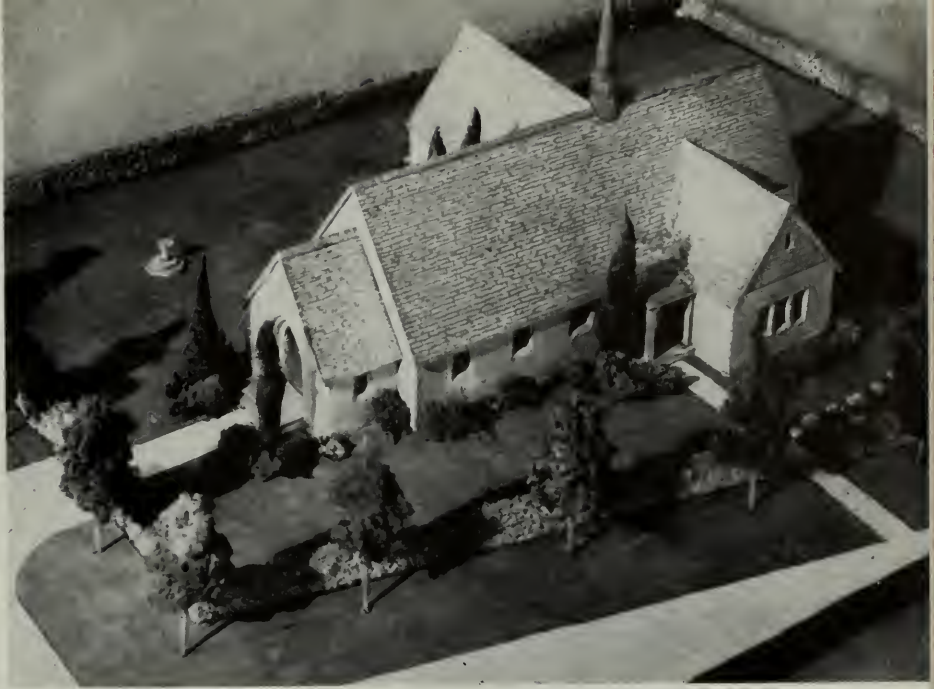

Photo by J. Walter Collinge

The CHURCH

For St. Marks in the Valley

The men and women of this Episcopal church are desirous of maintaining a single central point of worship to serve the widespread farming and ranching area of the "Valley" near Santa Barbara California.

In considering their needs they wish to develop a simple straightforward type of structure which would be manifestly a church to all observers, and yet a building that would be easy to maintain and support.

One of the parishioners, realizing that the ordinary person does not easily read or understand the information contained on a drawing, or blueprint, commissioned the firm of Winsor Soule and John Frederic Murphy A.I.A. Architects of Santa

Barbara, to prepare a scale model of their idea of the church, in order that all members of the church could visualize what was being planned in the way of a new building.

The model, illustrated above, was made in the Soule and Murphy offices by their draftsmen at a scale of $\frac{1}{8}$ inch equals 1 inch. The roof texture and window details are drawn directly on the cardboard of the model, while the trees and shrubs are cut and torn from sections of coarse sponge. The model hedges are sawed out of a sample of fiber tile.

The complete model is mounted on a piece of veneer and colored with poster paints as nearly as possible to represent the finished building.

MODEL

of the Mesa Campus Site

SANTA BARBARA COLLEGE

University of California

By WINSOR SOULE, A. I. A.

Winsor Soule & John Frederic Murphy

Architects, Santa Barbara, California



SITE WITHOUT FILL



SITE WITH FILL

Photos by H. E. McAllister

As a preliminary step to the preparation of the master plan for the development of the new campus for Santa Barbara College—University of California, a detailed model of the site was built in the Architects offices in Santa Barbara, on the scale of 100 feet to the inch.

In order to emphasize the fact that the grading and filling requirements of the site would represent a major consideration and perhaps a problem in the development of the site, the vertical scale of the models doubles that of the horizontal, or is scaled on the basis of 50 feet to the inch.

Each separate 5 foot contour line of the Model was traced by draftsmen in our office on a sheet of straw board of the appropriate thickness, the cardboard sections then being cut and mounted, one on top of the other in their correct relation.

The entire Model was then colored with poster paints and outlined in black, giving the elevation on the outside edge of each separate contour plateau.

As is evident from a casual observation of the site, the area is at present divided by a deep canyon in the form of a Y, cutting the site into three separate portions. As it was evident that this condition would have to be eventually remedied by rather extensive fill, either in part or in whole, sections of the same cardboard were cut out and fitted into the original model in order to give a visual idea of the area and proportions of the site after the fill had been accomplished.

The two photographs show the model with and without the proposed fill.

Cheerfulness in Living



Old Alcazar Garden,
Seville, Spain

By **ALLAN H. REID**

Landscape Architect and Site Planner

From the laboratories of scientists through the chambers of producers streams of new products are advancing upon us. Many of these products will undoubtedly affect the tunnels of our thinking and the habit of our living. Do we all recognize this threshold of change? Can we accept desirable new adjustments in our every day habits? Can we fully take advantage of those new products we select as worthy of our living pattern?

Answering the general question is of little value until specific cases are studied and some of these we may consider now.

Vast improvements made in equipment for earth moving and relative abundance of such equipment is a stride forward that appropriately comes after easily developed building sites are nearly off the market. Thus one of only average means can now afford to introduce borrowed fill portions of his flat tideland. Others on sloping terrain can balance their cut and fill to afford real windbreaks, pleasant terraced areas and ready circulation to

and through the building site. The improved machinery is especially helpful because of variations in its size so that one can readily hire equipment to handle the job whether in moving big quantities or for the job of dozing, plowing, or disking small intricate areas, yet areas in which the quantities would provoke groans from present day hand-labor and wheelbarrow. Accurate grading work then should become far more popular with the end result that buildings are better located, driveways less conspicuous yet more serviceable, the re-

(Continued on Page 30)



Earth Forming Stage of
on outdoor theatre

NEW MILL DEPOT:—

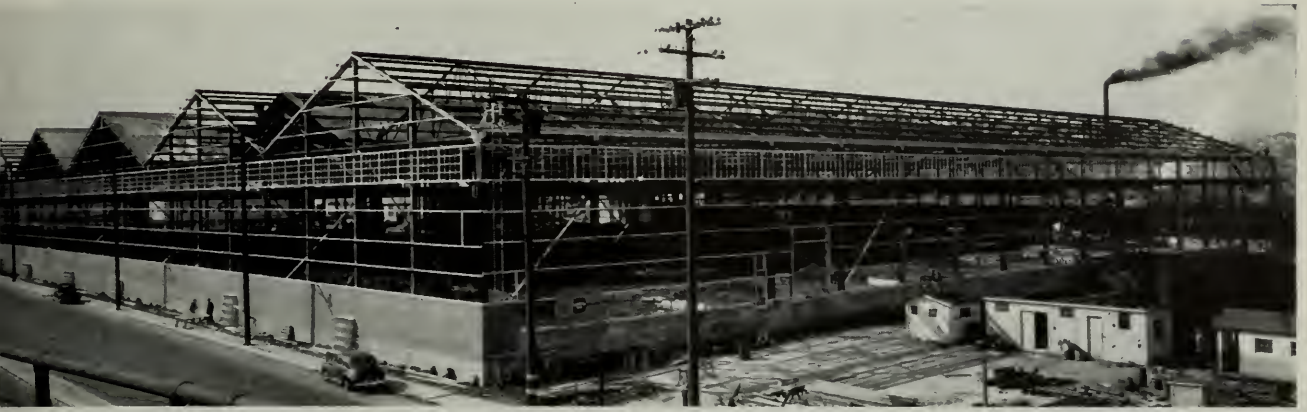

CONSTRUCTION NEARING COMPLETION

THIRD & MARIPOSA STREETS

Bethlehem Steel

San Francisco

Construction of the Bethlehem Steel Company's new Mill Depot at Third and Mariposa Streets in San Francisco represents one of the speediest steel erection jobs of recent record.

Ground was broken for the new building on October 1, 1945 and following the placing of foundations, the entire steel framework consisting of five 85 foot wide bays comprising twelve hundred tons of structural steel, each 375 feet in length and covering about four acres of land was erected in 17 working days.

Laying of the 170,000 square feet of steel roofing for the building is nearing completion, and with the brick masonry work on the front wall of the building already completed, it is expected the mill depot will be ready for occupancy about May 1, 1946.

Facilities of the new mill depot have been designed for a maximum efficiency in the handling of

products. Each of the 85 foot wide storage bays is served by two Southern Pacific railroad spur tracks and a double width truckway extends through the building. Thus steel for the building, manufacturing and jobbing trades can be quickly loaded for shipment to customers.

Expansion of the services offered the construction industry through this new Mill depot "is in line with our policy of growing with the market", H. H. Fuller, Pacific Coast Vice President of the Bethlehem Steel Company declared.

He also pointed out several technical services which have recently been added to the Company's consulting services to consumers, including a full metallurgical contact and consulting service which will be in charge of Frank C. Smith, Metallurgical Engineer at the San Francisco general offices.



ROGERSON HALL of Seaside Holiday Camp at Corton, Suffolk, England

Architecture for Leisure

By **HUBERT E. BIRD**

**well-known British broadcaster
and writer on civil engineering
and industrial subjects**

The Workers' Travel Association, founded in Britain in 1922, is much more than an efficient tourist and travel agency, though that is its primary function. Its activities are directed by an admittedly social motive to provide holidays for people of moderate incomes at a reasonable cost and in an atmosphere of friendly informality. Its directors give their services voluntarily. Shareholders receive reasonable dividends. The Association, however, is registered not as a commercial undertaking, but as a provident society, and profits in excess of such agreed dividends go back into a

general fund for improving and extending the holiday facilities it provides for its members.

In the years before World War II, the extension of the system of holidays-with-pay to lower paid workers enormously increased the demand for imperative holidays. Holidays in the popular seaside resorts, spent between the inadequate not inexpensive comforts of the boarding house and the noisy, overcrowded beach were not always what these people required. Many of them wanted relaxation and diversion for limited sums of money. The Workers' Travel Association was not

alone in sensing this new need, and a number of commercial concerns came quickly into the field with "holiday camps", most of which were built on the coast in or near existing resorts—for the Briton likes his annual sniff of the sea.

Five Hundred Holiday Makers

The W.T.A. began to grow in numbers and popularity, and the pressure of increasing membership faced it with the task of formulating long-term, large-scale programs. Already it had established in Britain a number of permanent holiday centers in suitably adapted country houses with accommodation for 50 to 150 people. But catering for considerably bigger numbers called for organization on a different scale. The directors' ultimate decision was that a system of holiday camps, each housing up to 500 people, would best give the members the sort of holiday they wanted.

In 1938, in association with the Co-operative Wholesale Society, the W.T.A. built its first holiday camp at Corton on the East Anglian Coast. In July 1939 it was opened and was recognized immediately as setting a new standard for holiday camps, both as a piece of social organization and as an exercise in community planning. The planned holiday camp was something new.

Taken as a piece of planning design, perhaps the unadorned functionalism of the lay-out was slightly raw, but it was just that avoidance of clever variations on a simple if unfamiliar theme and the absence of architectural mannerisms in the elevations that made it a significant contribution to the "architecture for leisure".

Architecturally the whole place is openly condi-

tioned by the basic planning requirements, and these it has met efficiently and unpretentiously. The disposition of dormitory, dining and recreational units was thoroughly put to the test in the camp's first season, for it worked. Throughout the season visitors to the new camp were never wanting and they went away satisfied.

What sort of holiday does this camp provide? That is entirely up to the holiday-maker. The facilities for indoor and outdoor recreation of almost every kind are there. There is no *table d'hôte* program of organized amusement, but if the clientele wants it, organized diversions, ranging from cinema shows in the nearest town to picnic excursions into the countryside, are, so to speak, "on tap". The lazy fellow, or the shy one, can lie back in his deck-chair and snooze. No one will trouble him, if he wants to be alone. The man with a strong social sense and a desire for the more active recreations can become a member of the social committee which the resident host gathers together weekly from the guests.

Diversity of Pursuits

In his plans the architect has to cater, though without extravagance, for a great diversity of holiday pursuits, dancing, billiards, bridge, boating and bathing and bicycling; table tennis indoors, and the tougher sort on hard and grass courts outside. The sea must be easily accessible from the dormitory blocks to obviate the tedious changing of swimming suits. There must be a diversionary corner for children with swings, slides and see-saws, and, not least important, a nursery

(Continued on Page 29)



Corner of the Dance Hall at Seaside Holiday Camp



Two of a series of twelve non-ecclesiastical windows designed and executed for the Gold Star Hall in the Memorial Union of Iowa State College, Ames, Iowa. These windows in rich Stained Glass are designed in medieval style as seen through modern eyes. The medallions, borders and other details present scenes and events of our national history alternating with events particular to the past and present of Iowa State College. All branches of the curriculum are represented, as well as Iowa State's contribution in stalwart young manpower to World War I.

Modern Stained Glass In ARCHITECTURE

By HAROLD W. CUMMINGS

Stained Glass has become cosmopolitan. It is making its shining contribution to the beauty of colleges, in club salons and swimming pools, in travel centers, in orphans' homes and recreational centers, in aquariums and libraries, apartments and financial and professional offices.

The directness and simplicity of to-day's architecture meets the need as an antidote for the complexity of our many-faceted contemporary **social** structure. In this contemporary trend the craftsman in Stained Glass is finding more opportunities than ever before to share the sparkle and joy of his craft.

As the church itself has emerged from its cloisters and lends its principles in the markets, so Stained Glass once exclusively the child of the church has emerged and is finding unbounded opportunities for expression through Monday-to-Saturday activities as well as in the liturgical field.

After the first glory of Stained Glass in the 12th and 13th Centuries the craft fell into decline and finally into a Rip Van Winkle slumber haunted by the distorted dreams of generations of artists who, though possibly masters in their own fields, failed to grasp the glory of glass itself as a medium instead of using it simply as a canvas is used by a painter. In the very presence of centuries of tremendous exterior social and economic change, on the craft of Stained Glass fitfully dozed.

Seemingly suddenly in America, in the early years of our own 20th Century, it awoke out of its nightmares. This awakening, this renaissance,

the late Ralph Adams Cr am in an article in the *Homiletic and Pastoral Review* addressed the clergy, "Truthfully speaking, it may be said that this restoration of a once great art to full power and value is one of the most miraculous events of modern times."

Now how has modern Stained Glass adapted itself to meet the newly unfolding architectural trends? Stained Glass craftsmen themselves do not wholly agree on what constitutes good modern Stained Glass. We have seen recent windows of landscapes complete with waterfalls and transmission lines in Stained Glass, with all the realism and perspective of the old opalescent glass period, and this has been called modern glass. But the introduction of subject matter as modern as a high



Light over entrance to Bank of America, Napa branch. In this example the ship emblem, background and borders are all executed in textured glasses in simple modern lines, designed to admit full daylight but to diffuse harsh glare.

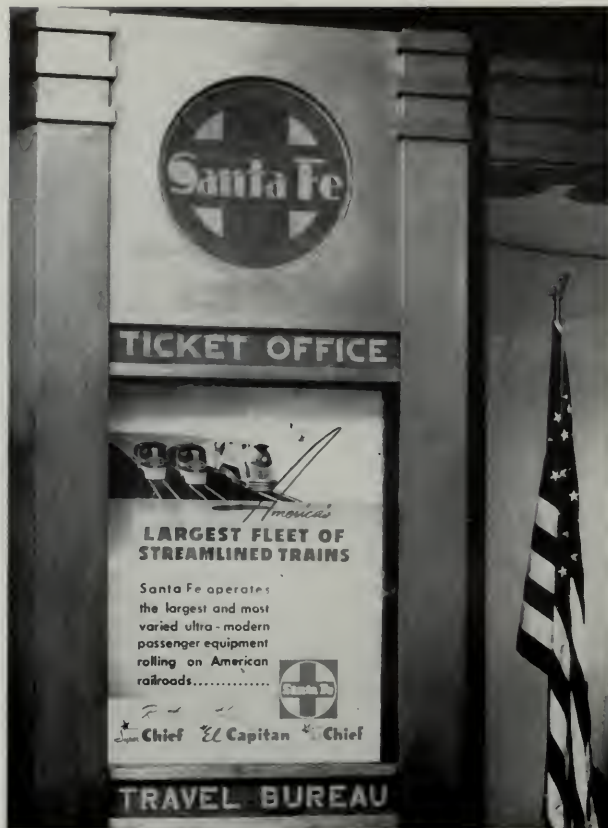

Left: Lucent Mosaic "herald" made for the Atchison, Topeka and Santa Fe Railway ticket office, San Francisco. This is an emblem designed to "tie in" with the architecture of the building. The design is "cast" glass and lead in the railway's colors, blue and white.

Right: Detail of the Santa Fe emblem, showing bold treatment of the simple design.



tension line alone does not compensate for the departure from craft principles which the use of realism and perspective involves, and as long as the nature of glass and lead themselves remains rigid, their expression should be interpretive or representative rather than realistic.

Another school superimposes groups of Brugel-like figures on heavily matted grayish backgrounds and calls that modern glass. It would not be fair to skip the fact that such a trend is a duplication of the manner of the end of the 16th Century during which Stained Glass was well into its tragic decline.

Stained Glass is not without its surrealists, too; and the distortions and confusion expressed in every other field of art and craft are found here, as well.

Nevertheless, out of all the expository and experimental work have come many excellent expressions of our own times, still consistent with the timeless principles of Stained Glass, the color still lying in the glass itself, the leadlines an integral part of the design, with proven craft practices adhered to.

Sometimes in our new chaste buildings, tailor made, functional and pleasing in every way, some

accent, some staccato note of strong clear color is needed to pick it up out of what easily can (and often does) become a monotone, emotionally insufficient to be enduringly satisfying. The Chinese, old and seasoned in their expression of the chaste, confine their decoration to few things indeed, but these few things are rare, significant of the family whose house they grace, worthy of being long admired and lived with.

Modern Stained Glass is one answer to that need for something more rare, vitalizing, individualizing.

Architectural style itself should be the determining factor in the styling of Stained Glass windows. We do not advocate that Stained Glass go modern in a building of Gothic or Romanesque inspiration, ecclesiastical or sectarian. But modern design in architecture is paralleled by modern design in Stained Glass. Close at hand is the choir window in the United States Navy Chapel on Treasure Island whose virility and chaste simplicity assuredly are expression of our own times, and complement the architecture of the building. Further to be seen are the windows in the Church of St. Leo the Great in New Orleans and the penthouse windows at 199 Chestnut Street in San Francisco.

Ornamental transom lights made for the clubrooms of the Musicians' Union, San Francisco. Here again flashed opal glass is used in soft tones, the central emblem, in richer color, is a Lucent Mosaic medallion, the individual pieces or "tesserae" being cast lead. The flanking lettering is painted and kiln-fired into the background glass.





Stained Glass panel for a private library. This is a residential Stained Glass light, done in full color in English 15th Century style. The background is designed in diamonds or "quarries", surrounded by a double border in contrasting colors. The reading figure is flanked top and bottom by broad bands of conventionalized plant forms in deep rich colors.

The use of symbolism in modern Stained Glass is occasionally discussed, the question arising as to whether abstract design only is more in keeping with the trend of our time.

Communication through symbolism of design and color is older than language itself, transcending nationality, race, the very centuries. It speaks

to the so-called over-privileged and under-privileged alike. It is a rich body of culture so valuable, so universal in its reach that to fail to use so fundamental a means of communication would impoverish ourselves and our descendents.

Rather should symbolism be enriched by today's unfolding life, and this will be expressive of



This is an example of what can be done with an unattractive window opening. The problem in this case was to treat the large area decoratively, and at the same time to admit full daylight. This has been solved with a simple design in lead and textured glass, with a few "breaks" scattered in the field to add interest. This window is in the penthouse of Mrs. Mayes, Telegraph Hill, San Francisco.

our culture long after words themselves have become obsolete. It is doubtful, indeed, if the more thoughtful would sacrifice the immeasurable teaching value of symbolism. Here in our cosmopolitan west, a pot pourri of colors and tongues and creeds, is the universal language of symbolism especially significant.

Such an instance of writing contemporary history in Stained Glass was done in Gold Star Hall of the Students' Union Memorial Building at Iowa State College at Ames. A series of windows lining each side of a marble corridor depicts the progress of that land-grant college from its founding to its present significant status, including the supreme contribution made their country by Ames men and

women in World War I. One instance is the Tolerance Window. Of the three major medallions the top expresses tolerance in freedom of speech, showing a conventionalized figure atop a soap box expounding to listeners below him. The middle medallion shows conventionalized tennis players, a young man and a young woman, expressing tolerance promoted by co-education. The third medallion contains two old soldiers, opponents in the Civil War, but now standing shoulder to shoulder. In the base of the window is depicted the special war service of Ames men in the Rainbow Division, going over the top with the banner, "Fight, Ames, Fight!"

Thus iconography or symbolism in Stained

Glass has been enriched rather than sacrificed. It is a fitting and an enduring memorial to those who gave their lives in World War I.

This ability to endure without fading or depletion is an invaluable quality Stained Glass gives to architecture. Particularly in our own sun-drenched state is this priceless. Paints, fabrics, etc., yield color and require continual renewing and replenishing as the years go by—time strata of temporary brilliance and satisfaction with recurring stages of degeneration and delapitude. Stained Glass is proven permanent color, Chartres Cathedral windows having served their architecture and the spiritual needs and aspirations of humanity since the 12th and 13th Centuries. Still their color sings, still scintillates, even more beautiful with the passing of the centuries.

Sometimes the relatively inexperienced glass craftsman is led into the quagmire of disappointment by a desire for originality in the use of color. Now a desire for change for the sake of change **can** lead to great progress; on the other hand it may be merely an expression of restlessness or ego. Since, in Stained Glass, the light comes **through** the medium instead of being stopped by it, color is carried along by the light, and the atmosphere, or glow, of a room is fixed by the color through which the light comes. Green, for example, is a delightful color for opaque substances, such as spring hills, or in paints or fabrics; but in Stained Glass a predominately green window will, regardless of the intention of the craftsman, cast a cadaverous light on the most hale observer. Undoubtedly all the old craftsmen tried these things out, too; and finding the glow radiated by the primary colors most delightful and sublime, produced their masterpieces with blue or ruby predominating, and the secondary colors playing secondary roles. Change in architectural style does not change these physical facts, and the modernist who really loves light and color prefers

even now the primary colors in Stained Glass for the wonders they perform with light.

This generation with its passion for light and freedom and limitless view uses much glass in a light key, and often clear glass with full color to accentuate structural lines or to draw attention to a focal point.

In line with the trend of modern architecture to produce structures that cost less money per unit, Stained Glass has followed the lead of her mistress. It is hoped that every fundamental principle is still always adhered to, but the pattern is sometimes simplified. This is fitting, as modern architecture herself gives an extremely simplified effect. The glass is often cut in larger pieces, thus cutting down the cost of much handling. It is often quite geometric in pattern rather than having the intricate decoration and flow of the Gothic style. It necessarily sacrifices some of the scintillating quality of Stained Glass found in finely cut up windows, because the number of planes of color and their corresponding angles of refraction of light is lessened. Nor does it mean that the ideal is not still finely cut up work. But it does democratize Stained Glass and make it available—correct and enduring decoration—to a greater proportion of people, where the item of cost is one of the principals to be considered.

To us, modern Stained Glass is a logical expression of to-day's living. In all the great body of culture given us by the centuries we have made our own individual adaptation—finding, claiming and using all the wealth and joy of the principles which are without age, and adding to that body of culture an expression of the freedom and greater joy of our own age.

NOTE: *The author of this article, Harold W. Cummings, San Francisco, is president of the Stained Glass Association of America, and is internationally recognized in the stained glass industry.*—The Editor.



Lead overlay transom light, designed and executed for the Financial Center Building, San Francisco. An extremely rich design was achieved by the bold use of sheet lead over glass. The lights are composed of leaded glass panels in alternate squares and rectangles of octagonal shape. The sheet lead is pierced in a design of stylized leaves and heraldic animals and soldered to the main leads between the panels. The entire effect is that of a completely weatherproof and translucent grille. The leadwork is designed to harmonize with the bronze lamp and general architectural ornamentation of the foyer.

OPA PRICE ADJUSTMENTS

Following changes in O.P.A. prices have been announced:

Basic Steel Products. Increases averaging \$5 per ton in steel mill ceilings, effective immediately, and may be applied on all deliveries of steel since Feb. 15, 1946. An increase of 8.2 per cent. Average realized price of all steel, carbon and alloy, is \$65.92 per ton, compared with former \$60.92 per ton. Steel warehouses and jobbers will be permitted to pass through to customers the amount of increases.

Vitrified Clay Sewer Pipe. An increase of 6.5 per cent over March, 1942, levels on manufacturers sales of vitrified clay sewer pipe and allied products produced in Northern California, effective March 6, 1946. Applies to "pick-up shipments" and "less than carload" shipments also.

Softwood and Hardwood Lumber. The regulation governing services of custom-milling and kiln-drying of northeastern softwood lumber has been extended to include all hardwood and all softwood species, EXCEPT western softwoods. Effective March 11, 1946.

Ceramic Floor and Wall Tile. New prices are determined by calculating "adjusted total costs," and adding 1.8 per cent.

Trade-Sales Paints. Individual manufacturers of trade-sales paints may apply for adjustments in their ceiling prices, effective March 13, 1946. Industrial paints are not affected. Prices were frozen to March, 1942, levels.

West Coast Logs. Logs produced in Western Oregon and Washington raised an average of \$1.25 per thousand feet log scale to cover wage increase of 15 cents per hour.

Shingle Grade and Camp Run Cedar Logs. Increased \$4 per thousand feet, effective March 13, 1946. This will require an increase in prices of western softwood shingles.

Douglas Fir Peeler Logs. Raised \$1.50 per thousand feet. Present ceilings maintained on select spruce, aircraft noble fir and No. 2 wood logs. A \$1 advance permitted on all other grades and species, and a ½ cent a foot increase is authorized for pulp species scaled under the Sorenson Cubic Foot Rule.

LENINGRAD TO BE MODEL OF RUSSIA'S BEST CITY

Planning model for the whole country, this one time capital will be rebuilt around broad avenues and many large new squares and parks. Five or six story apartment buildings will be organized as superblocks with large central lawn areas for parks or playgrounds. Plans call for a generally uniform roof line. Some parts of the city will have a central heating system, and eventually the whole city will be provided with heating stations.

Planners intend to pipe peat gas from a factory 40 miles from the city to plants and heating stations. Hope is that street cars will soon give way to motor buses. A subway will also be built. Leningrad counts on many more automobiles and plans to provide parking for 20,000 or 30,000 cars in an area surrounding its central square.

Stalingrad's Future

Stretching along the Volga for 80 miles of waterfront, the future city will be rimmed by a greenbelt of trees, which will also serve as a windbreak.

Paralleling the river, highspeed electric trains will run the length of the city, while buses will provide lateral transportation. Main streets will be nearly 100 feet wide. If sufficient natural gas is found along the Volga River, it will be used for heating. Excess heat from industrial plants will be diverted to central home heating systems.

About 15 per cent of the new houses planned will be individually owned and built. Prefabricated emergency housing will provide for about one-third of the city's population, and present plans call for their replacement by more permanent structures within the next ten years.

Moscow's Dream

The last of Moscow's cobblestones will disappear under asphalt surface paving as streets are widened to fit into the new plan calling for a series of broad ring boulevards, intersected by radial streets emanating from the city's core.

Direct auto thoroughfares will connect the newer residential neighborhoods with the factory district. Because of predominant westerly winds, factories will be located on the east to keep smoke as far away from the center as possible.

Expansion of the city will take place chiefly in the southwest and the northwest, with the southwest section being devoted mostly to large-scale cottage developments.

Many buildings will be moved to make room for the new street pattern, while many old buildings will be given new facades. The pavilion built for the New York World's Fair, now stored in warehouses, will be re-erected.

A wide belt of green trees will encircle the rebuilt city.

Hygienic Reasons For Painting Walls and Ceilings

By **WALDEMAR SCHWEISHEIMER, M. D.**

The painter is not only a worker in the beauty trade,—he is also an important aid of the doctor and the public health authorities. Painting of walls and ceilings is supposed to lessen the danger of dust.

Dust settles much more easily on unpainted walls. If you cover a wall with cloth or carpets and beat them after some time you will be surprised about the amount of dust which has accumulated in those covers. From niches and corners of the unpainted walls dust is blown into the room air by the slightest breeze—and is inhaled by the inmates.

Paint a Germicide

Some kinds of dust contain numerous germs, especially tuberculosis bacteria. It has been known for a long time that the air of a room may be contaminated through the coughing or sneezing of a sick person. We call this droplet infection. The finer particles of the sneezed-out or coughed-out liquid may fleet about in the air, then settle to the floor, the walls or the ceiling,—may soon dry, become powder and dust, and be found later in the dust, contaminating the air of the room.

In this way they are inhaled.

That is why it is so important to live in newly painted rooms. You never know who has lived in your room before you,—or may have died there. Your predecessor may have had a cough, and his cough bacteria or other particles may have contaminated the walls of the room.

Proper painting of the walls prevents such danger. Some decades ago much was thought of thorough disinfection of every part of a sick room after recovery of the patient. Liquid chemicals as well as disinfectant vapors were used to destroy all germs and bacteria in the room. Today we are no longer as anxious about this particular kind of disinfection. We want, however, newly painted or papered the room where somebody was sick with an infectious disease. This lessens remarkably the

danger of transmission of germs to other people, as experience shows. Painting by itself usually destroys the germs; furthermore there are many paints which contain certain substances toxic for bacteria and which, consequently, may be considered actual disinfectants.

A well washable paint may be of good service in this respect, e. g. in hotels or nurseries or sick rooms. It is comparatively easy to wash a semi-gloss or gloss finish, according to Dr. J. S. Long—but flat finishes—particularly the "dead flat" type,—won't stand as much soap and water. On the other hand, he says, a flat finish is more desirable for big wall areas and ceilings because it gives a more diffuse light and a softer effect to the eye. A compromise is frequently the solution.

Mold is Unpleasant

Dust favors the development of mold on walls and ceilings, especially in damp rooms. The result is a highly unpleasant odor that renders this kind of room nearly uninhabitable for more sensitive persons. This odor may well irritate the mucus membranes of the respiratory organs: nose, throat, windpipe, bronchi and lungs.

Susceptible people may even develop real asthmatic attacks in connection with and produced by this odor. On the other hand, those asthma attacks may disappear like by magic when the room where the patient lives and sleeps has been newly painted.

This is the most thrilling proof for the immediate hygienic influence of new painting. If the walls have a smooth finish, dust, mold and germs do not settle down easily. Half-painted ceilings and walls are particularly harmful, showing the previous coat of paint peeled and hanging down like bits of bark.

Light and Paint

The deposit of dust and soot on unpainted or long-neglected walls and ceilings gradually darkens these even though they had previously been

a gleaming white. In consequence, the entering daylight or the artificial light of the room cannot be adequately reflected by the walls and the ceiling, and the room looks dark and gloomy. The more light a room has, however, the less germs and bacteria can resist the influence of the rays of the sun, and the more healthful is the room to live in. Painting of walls and ceilings at regular intervals will improve this condition.

The same is true for avoiding unpleasant eyestrain and eye fatigue by re-painting a darkened room. Studies conducted jointly by Du Pont Company color technicians and Philadelphia Electric Company illuminating engineers recently gave evidence of this fact. White ceiling and side-walls of a room had lost much of their original whiteness and reflection value; the floor had been dark maroon, and the equipment of the room was dark mahogany furniture. The coefficient of light utilization had been no more than 27 per cent.

After refinishing the ceiling with light cream paint, the coefficient of light utilization was raised from 27 to 35 per cent by this simple procedure alone. Then, in successive steps, the side walls were refinished with a neutral green paint, the dark table and chairs were replaced with blonde furniture, and finally, the dark maroon floor was recoated with white floor paint stippled with spruce brown.

By this planned use of all reflecting surfaces, the coefficient of light utilization was brought up to 55 per cent,—an improvement of more than 100 per cent over the original arrangement. It is remarkable that this was achieved without installing any additional lighting equipment. Poor illumination in a room produces headache, eyestrain, blind spots, causes accidents and reduces the efficiency of working people. Refinishing walls and ceilings may be the safest and quickest way to improve those conditions.

Choose Colors and Ornaments Carefully

For the side-walls of hospitals, sick-rooms and nurseries paints are preferable which may suffer without damage the washing with chemical substances and liquids for disinfecting purposes whenever a new patient moves in,—or when the inmate has gone through an infectious disease. The choice of colors in those rooms should consider the general mental condition of sick people. It is better to pick colors on the light side rather than on the dark side. Light colors are cheering and stimulating for the majority of people. For painting the walls as well as for wall-paper no restless, incessantly repeated ornaments and designs should be chosen.

Quite a number of patients do not stop examining and re-examining those artistic ornaments and

designs. Particularly patients who are suffering from high fever may see terrible grimaces and threatening monsters in those innocent designs. They get restless and are frightened. The frequent repetitions of one and the same ornament on the wall makes the fever-ridden patient count mechanically all those designs, and this futile activity may produce a nervous exhaustion which robs him of quiet and sleep.

Quiet plain surfaces of the walls, occasionally interrupted by straight ledges and lines, are best for sick rooms,—and for bedrooms as well. If a decoration or enlivenment of the wall is intended, it may be produced rather by change of the color. Particularly children like this kind of decoration. The same tendency is valid for bedrooms as regular bedrooms are usually the predestined sick rooms for the members of the family.

PARAFFINE MERGER

Stockholders of the Paraffine Companies, Inc., voted at a meeting March 15, 1946 to merge with the Schumacher Wall Board Corporation, and approval of such a merger was voted at a meeting of the Schumacher Wall Board Corporation in South Gate on March 18.

METAL INSULATION AVAILABLE THROUGH WESTERN ASBESTOS CO.

For the first time since before the war, Reynomet, formerly called Reynolds Metallation, is available to the building industry in northern California and western Nevada.

The home insulation material is being distributed by Western Asbestos Co., whose main office is in San Francisco with branches in Oakland and Sacramento. For the past eleven years, Western Asbestos Co. has been associated with the Reynolds Metals Co. as a distributor in this area.

Two types of Reynomet are available: type "B" with foil mounted on both sides of heavy kraft paper and type "C" with foil mounted on one side of heavy kraft paper.

TESTING MINERAL ORES

A pilot plant for testing of mineral ores was placed in operation at the Shasta Dam, California, on March 14 by Mines and Reclamation Bureaus of the U. S. Department of the Interior.

Facilities are provided for testing ore deposits of Northern California and Southern Oregon to determine their potentialities for raw materials needed by West Coast industrial plants.

A direct arc furnace of the Herault type with automatic control is served by a transformer and switchgear with rated capacity of 2000 kva. It has a holding capacity of six tons.

ARCHITECTURE FOR LEISURE

(Continued from Page 17)



THE LOUNGE of Rogerson Hall has been designed for comfort

with a trained nurse to take the family off mother's hands for part of the day.

The Association's experience with its first holiday camp at Corton has convinced the directors that they were on the right lines and now they have invited architects to submit designs for other holiday centers, on hypothetical sites, one inland, and one by the sea. The requirements, based on the working arrangements of the Corton camp, have been worked out in detail and are set forth in a list of 30 items. Nothing seems to have been forgotten, from the kitchen and cafeteria to the "workshop and tool house with accommodation for a lawn mower." The distinguished panel of assessors includes the eminent planners, Sir Patrick Abercrombie and Mr. J. H. Forshaw, who together drew up the impressive "Country of London" plan. The architect's job in this case is, in fact, primarily a planning concern, for on the convenience of his lay-out depends whether or not the 50 staff he has to accommodate, can reasonably hope to minister to the needs of the 500 guests for whom he must provide dormitories and dining rooms. Let this be right and he can happily set about refreshing the sober English eye with the inventiveness of his elevations, by which, as much as by any nicety of domestic planning, he is likely to be remembered.

Importance of Design

Style and siting of the grouped buildings are of course as important to the preservation of the locality's amenities as the internal planning is to the smooth running of the camp itself. Too often in the past the ill-considered siting of a house or hotel has ruined the very beauties that brought about its existence. Discreet design and siting of new buildings in rural areas is a tenet of great importance in the counsels of Britain's planners, and the Workers' Travel Association has been both bold and wise enough to emphasize this in announcing this competition.

There is a real shortage of holiday centers in Britain, and it is certain that a holiday so accommodating to the personal taste will become increasingly popular. The winning designs in this competition will, it is hoped, produce not one, but a whole string of comely buildings whence the ordinary man can see and come to know the mountains, moorlands and remoter valleys that are Britain's pride, as well as the varied beauties of her coasts. The W.T.A. is to be applauded as a pioneer in providing holidays in surroundings whose planned simplicity both expresses and makes available the social possibilities of community relaxation.

CHEERFULNESS IN LIVING

(From Page 14)

maining site more usable and drainage more efficient.

After grading the site, construction can progress using a greater range of materials than ever before. To avoid utter confusion selection of these materials must be more carefully weighed. Only on the small property does the architect's choice of materials used for the building closely control selection of materials used in site development. Elsewhere it is vital that the architect and site planner work closely together, for the selection of materials used to build up the site may control the architect's choice of materials in building.

Ceramics are to be used far more extensively in the makeup of building sites, in gardens, and in civic centers. We need only to review our Moroccan and Spanish architectural and garden books to understand how basic a part of their beauty depended on ceramics. To quote from Helen Morganthau Fox's book "Patio Gardens"—"Unlike the flowers, no drought or disease can affect them and they are a permanent embellishment to the garden". Tile used in patios, terraces, walks, and walls, for garden seats, and headers about plant beds, abetted by new methods of calking and waterproofing these units, carry on through the seasons with little or no maintenance. The design patterns must be harmonious and we would like plants, both the ground covered and upright plants to soften the effect by foliage and shadow.

Concrete is certainly an adaptable material and well suited to variations of design in walk and patio surfacings, for pools, seats, plant beds, walls, and drainage features. Walls can cheer us by their tone, by the silhouettes of plant shadows draping them, by elimination of maintenance, as well as by ease of construction since by use of inter-locking blocks few forms and no mortar is necessary. Concrete as a wall material takes the lead by combining elements of space saving, wind control, privacy, and the retaining of earth. Improved products for waterproofing and dampproofing the concrete are now readily available just to add further comfort. Better designed plant beds whether within or without the building will replace many of the hard-to-maintain scattering of flower pots now commonly featured in magazines and some homes. Extra labor to construct well placed concrete (or metal) beds whether or not these are faced with tile will soon be repaid by the lessened maintenance and worry over yellowing foliage.

Plywood is a product as yet unexploited for landscape purposes. In combination with waterproof glues and surface treatments there is no end

(Continued on Page 39)

IN THE NEWS

EXPOSITION POSTPONED

Due to the uncertainty of products and delivery schedules of vast numbers of the nation's leading manufacturers the PRODUCTS OF TOMORROW Exposition scheduled to open at the Chicago Coliseum on April 27th, has been indefinitely postponed, Marcus W. Hinson, Exposition general manager has announced.

Manufacturers who originally planned to display their postwar products consider it inadvisable to participate in public exhibits until they are more certain of their future capacity for delivery.

The Exposition may be held this Fall or early in 1947.

ROBERT E. ALEXANDER, A.I.A. Architect, announces the opening of offices at 3701 Stocker Street, Los Angeles 43, California with Walter P. Graydon, as office manager.

ADVERTISING AGENCY

Calvin D. Wood, announces the opening of Advertising Agency offices at 617 Montgomery Street, San Francisco 11.

Six-seventeen Montgomery street has an interesting historical background as it was on this site in 1860 that the Pony Express opened its headquarters and western terminus.

SLUM CLEARANCE IS SAN FRANCISCO CHAMBER AIM

Clearance of slum dwellings from San Francisco areas destined for industrial and commercial development is recommended by the Sites and Buildings section of the Industrial Department of the San Francisco chamber of commerce through the Chamber's board of directors.

The Chamber advocates an agreement between the San Francisco Housing Authority and the Board of Supervisors whereby funds made available by the authority shall be used as a revolving fund for slum clearing purposes.

Under the plan some \$151,974 would be available.

J. LLOYD CONRICH, announces the removal of his office to 593 Market St., San Francisco.

KINGSFORD JONES, announces the opening of offices at 45 North First St., San Jose, Calif., and desires literature and catalogues of building materials.



CALIFORNIA COUNCIL OF ARCHITECTS:

John S. Bolles, President; Robert H. Orr, Vice-President, James H. Mitchell, Secretary-Treasurer; 369 Pine Street, San Francisco 4.

Washington State Chapter:

George W. Stoddard, President; Clifton J. Brady and Joseph H. Wohleb, Vice-Presidents Stephen H. Richardson, Secretary; J. H. Dillon De Hart, Treasurer; Offices 516 Central Building, Seattle 4, Washington.

Northern California Chapter:

Andrew T. Hass, President; E. Geoffrey Bangs, vice President; John S. Bolles, Secretary; Hervey Parke Clark, Treasurer; 369 Pine Street, San Francisco 4.

Southern California Chapter:

Charles O. Matcham, President; Adrian Wilson, Vice-President John Landon, Secretary; Albert C. Martin, Jr., Treasurer; Offices 3757 Wilshire Blvd., Suite 212, Phone Flitzroy 2393 or Mutual 4592. DIRECTORS, John Rex, Paul R. Hunter, and Weldon D. Becket.

SOUTHERN CALIFORNIA CHAPTER

"Few of us realize, what responsibilities and duties are carried by such a small group as the Chapter Executive Committee. These first few months of the year are ones of organization and planning, and much credit is due to those who have cooperated so willingly in establishing policies for the forthcoming year," reports Charles O. Matcham, president of the Chapter.

Eleven new Institute members have been taken into the Chapter in the past few months, as has one Associate, and six Junior Associates.

David C. Allison of Los Angeles has been named a member of the A.I.A. nationwide committee to advise on architectural phases of the new United Nations Organization Capital. Eric Gugler of New York, has been appointed chairman of the Committee.

The Executive Committee has appointed Anthony Thormin, 72 S. Lafayette Park Place, editor of the Chapter BULLETIN, effective at once. Members are urged to send the new editor items for publication.

NORTHERN CALIFORNIA CHAPTER

Speaking of "Technical Competence" the report of Arthur C. Holden on the questions raised by the Wisconsin Chapter, as submitted to the executive committee of the A.I.A., says:

"The architect cannot excuse work which is detrimental to the standards of his profession by hiding in anonymity behind the name of any type of employer. Where a registered architect, who is an Institute member, has violated the standards of public safety, good taste, or honest procedure, or has shown incompetence, then he should be criticized and disciplined by his peers in the Institute irrespective of his employment status. The architect's standards of conduct are based upon character and competence and not upon whether he is paid on the fee basis by an owner or on the salary basis by a Developing builder."

The Report continues to say "The experience

which the architect gains when he is a part of a building organization, should prove a valuable addition to the knowledge and background of his own profession, and his contact within the membership of the Institute affords him the opportunity for sharing with the other members of his profession the value of his knowledge thus gained."

WASHINGTON STATE CHAPTER

Members heard V. H. Dent, Executive Vice President of the Master Builders' Association report on the recent convention of the National Association of Home Builders in Chicago, and viewed a sound motion picture on Modular Coordination presented by the Producers' Council at their Regular March meeting.

Officers of the Chapter for 1946 include: George W. Stoddard, president; Clifton J. Brady, and Joseph H. Wohleb, vice presidents; Stephen H. Richardson, secretary; LaMonte Shorett and Edwin T. Turner, Executive Committee members; and John W. Maloney and Ralf Decker, delegates to the convention.

The Tacoma Society of Architects have elected the following officers for the ensuing year: Silas Nelsen, president; Charles Reuger, vice president; W. W. Durham, secretary-treasurer.

ARCHITECTS HONORED

Two interesting luncheon meetings were held during March by the Northern California Chapter, A.I.A. honoring participants in the "House I Want" series of lectures which were sponsored by the Women's Architectural League of San Francisco and sponsored by the Chapter.

The first luncheon featured Paul R. Williams, A. I. A. of Los Angeles, while the other honored Pietro Belluschi, A.I.A. of Portland, Oregon.

ALBERT C. MARTIN, Architect, has moved his offices from the Higgins Building, Los Angeles, to 333 South Beaudry Avenue, same city.

WITH THE ENGINEERS

Structural Engineers Association of
Northern California

W. Adrian, President; William W. Moore, Vice-President; Franklin P. Ulrich, Sec-Treas.; John A. Blume, Ass't. Sec-Treas.; Offices 214 Old Mint Building, San Francisco, Phone GARfield 3890. DIRECTORS, H. M. Engle, Mark Falk, and M. V. Pregnoff.

American Society of Civil Engineers
San Francisco Section

Theodore P. Dressler, Jr., President; Leon H. Nishkian and Sidney T. Harding, Vice-Presidents; John E. Rinne, Secretary-Treasurer; 225 Bush Street, San Francisco 20.

Puget Sound Council (Washington)
Engineering & Technical Societies

R. E. Kistler, A. I. E. E., Chairman; A. L. Miller, A.S.C.E., Vice-Chairman; L. B. Cooper, A.S.M.E., Secretary; B. A. Travis, I.E.S., Treasurer; Offices, Seattle, Washington.

ENGINEER SOCIETY NAMES

GAIL A. HATHAWAY OFFICER

Gail A. Hathaway of the office of Chief of Engineers, U. S. War Department, was named vice president of the American Society of Civil Engineers, succeeding A. C. Polk of Birmingham, Alabama, who died early in March.

As senior director in the Society's second zone, Hathaway represents some 3,300 members in 15 local sections extending from New Jersey to Florida and from the Atlantic as far west as Mississippi.

A resident of Maryland, he has been active in sponsoring meteorological studies of flood producing storms and is the author of several works on such studies.

ANNUAL JOINT MEETING

At the Annual Joint Meeting of the San Francisco Engineering Council in San Francisco recently, Lester S. Ready, Consulting Engineer, gave an address on the "Proposed Water Resources Development of the Central Valley Basin of California."

Plans for development of the State's water resources, including their engineering, social and economic implications, were described by Mr. Ready.

PUGET SOUND COUNCIL ELECTS

Officers of the Puget Sound Council of Engineering and Technical Societies, Seattle, Washington, have been selected for the Council organization during 1946.

R. E. Kistler, was named Chairman; A. I. Miller, Vice-Chairman; L. B. Cooper, Secretary; and B. A. Travis, Treasurer.

The Council is composed of some eighteen Technical Societies, representing a membership of more than 3000 architects, engineers, and scientists.

ASHVE APPOINTMENT

Clyde A. McKeeman has been named assistant to the president of the American Society of Heating and Ventilating Engineers, and will represent the Society in its research activities.

His work will be conducted from New York.

NEW INDUSTRIAL ENGINEERING SERVICE FIRM

Charles W. English of San Francisco and Portland, has been named president of Production Management Engineering Associates, Inc., an organization which has absorbed the firm of Albert Raymond and Associates.

Pacific Coast headquarters will be maintained in San Francisco, with district service offices in principal west coast cities.

Other officers include: E. D. Hayward of Los Angeles, vice president and secretary, and A. M. Brenne and R. L. Kron, directors.

HENRY DIEVENDORF DEWELL

Prominently identified with the engineering profession of the West for many years, both as a civil engineer and as a consulting engineer, Henry D. Dewell, died March 20, 1946.

Born in Springfield, Ohio, in 1881, he came to California the same year; attended public schools in Fresno, and graduated from the University of California in 1906 as a Civil Engineer.

In 1915 he was chosen Chief Structural Engineer for the Panama Pacific International Exposition, and during the past 30 years has been connected with many important engineering projects on the Pacific Coast, being recognized as an authority on timber structures and earthquake resistant construction.

He was a life member of the American Society of Civil Engineers, past director of the National Society and past president of the San Francisco Section; member of the State Board of Registration for Civil Engineers from 1932 to 1945; member of the Structural Engineers Association of Northern California, and many other professional societies.

He is survived by his wife, a son Henry D. Dewell, Jr., daughter Mrs. Jane Dewell Reanier; and son Robert D. Dewell, of Oakland with whom he was associated in business.

STRUCTURAL ENGINEER EXAMINATION

An examination for authority to use the title "Structural Engineer" will be given by the California State Board of Registration for Civil Engineers in May, according to Mark M. Falk, San Francisco, president of the board.

"It has been the policy of the Board to hold only one examination for the structural title each year,

however, a large number of prospective applicants have requested an examination this spring, therefore the Board will hold an extra session this year," Falk declared.

Any registered civil engineer is eligible to make application for the authority who can submit evidence satisfactory to the Board that he has been in responsible charge of Structural engineering work for at least 3 years prior to the date of his application.

JOINS KAISER ENGINEERS INC.

Rufus W. Putnam, has been named head of the Los Angeles office of Kaiser Engineers, Inc.

During the War he served as Colonel in charge of the Los Angeles District, U. S. Engineer Department and supervised construction of hospitals, hangars, barracks, airstrips, camouflage protection and jet propulsion laboratories.

He was also in charge of military projects at Bellemont, Arizona, Tonopah, Nevada, and Muroc California.

His "Modern Rail and Water Terminals" and "Water Transportation versus Rail Transportation" won him the Arthur M. Wellington prize for the American Society of Civil Engineers in 1924 and 1939.

TACOMA NARROWS BRIDGE

A new suspension bridge has been designed for the Tacoma Narrows to replace the structure that collapsed on November 7, 1940.

A report by Charles E. Andrew, Chief Consulting Engineer of the Washington Toll Bridge Authority, indicates that through newly developed wind tunnel techniques on full length bridge models a means has been found for predetermining the vibratory action of the prototypes.

The result is a new suspension bridge design that takes aerodynamic considerations scientifically into account.

KLAMATH RECLAMATION PROJECT

A contract for \$145,558 for work on the Modoc Unit of the Klamath Reclamation Project in southern Oregon and northern California, has been awarded to Clifford A. Dunn and Slate Construction Company of Klamath Falls, Oregon.

The contract covers construction of canals, laterals, and drains in the Coppeck Bay area of the Tule Lake Division where there is a strong demand by returning veteran's for homesteads.

Of 14,500 acres of public lands in this region, some 7500 acres are scheduled for opening this year, according to a report by the U. S. Department of the Interior, Bureau of Reclamation.



..and here's where we've planned telephone outlets"



Your clients will be pleased with built-in telephone facilities. Multiple outlets are conveniences that add real value to the homes you build today. Even if only one telephone is needed now, it is wise economy to include additional outlets.

Conduit is inexpensive if installed during construction...and it provides for future telephones without tearing up floors or bringing wire in along baseboards.

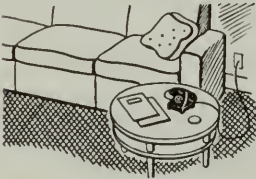

So plan built-in telephone facilities with an eye to

future needs. Our Architects' and Builders' Service will help you in every possible way at no charge.

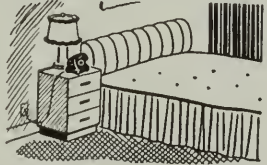

The Pacific Telephone and Telegraph Co.



HEADLINE NEWS & VIEWS

Protecting Their Health IS PART OF THE Job!



The education of the child is only part of the job at any school. In planning the appointments of the building or in remodeling, architects and school authorities face the factors of health, comfort and convenience as well. If you select Halsey Taylor Fountains, health-safety is definitely taken care of, and you can rely on their exclusive features to provide a welcome freedom from servicing troubles.

THE HALSEY W. TAYLOR CO.
WARREN, O.
West Coast Plant, Redlands, Calif.



HALSEY TAYLOR

**DRINKING
FOUNTAINS**

S-2

BAXCO
CHROMATED ZINC CHLORIDE

CEC

PRESSURE TREATED LUMBER
● **PROTECTS AGAINST DECAY
AND TERMITE ATTACK**

*Specify it in your home
Available through Lumber Dealers*

LOS ANGELES
601 W. 5th Street
Phone MIchigan 6294

SAN FRANCISCO
333 Montgomery Street
Phone DOuglas 3883

J. H. Baxter & Co.

AGENTS FOR WEST COAST WOOD PRESERVING CO. SEATTLE, WASH.

May 19-25 has been designated "11th Annual National Foreign Trade Week"—How about setting aside one week each year when the wheels of industry may turn . . . unhampered.

△

This is an "election year"—IF you don't approve of your representation in State Legislatures and Congress, NOW is the time to do something about it.

△

Despite lessened industrial employment opportunities in certain strategic war-industry areas, there seems to be little change in housing problems.

△

Recent OPA interpretations on building material prices and veteran priorities for scarce building materials will not check construction of homes progressing with HH preference rating, officials of the Veterans Emergency Housing Program declare.

△

San Francisco is revising its Building Code—When approved in final form the new Code will represent one of the "latest" metropolitan city rules and regulations covering the building industry.

△

It is claimed that "Visual Education" will develop rapidly as improved color reproduction processes become available—What an opportunity this offers in architectural, engineering, and construction professions.

△

Advance indications are that the "Construction Industries Exposition and Home Show" scheduled for the Pan-Pacific Auditorium in Los Angeles on July 12 to 21, will give the public its first opportunity to view many of the "new developments" in home planning, equipment and construction.

The Northern California Chapter A.I.A. have a very commendable program of veteran training in architectural draftsmen which is being conducted in "On The Job Training" provisions of the G. I. Bill.

△

At a joint meeting of the Structural Engineers Association of Northern California and the Northern California Chapter of the A.I.A., held in San Francisco recently, discussions relative to "building codes" indicated much progress was being made in ironing out "differences" of individual opinion relative to building code requirements.

HOME REMODELING

The Federal Housing Administration is undertaking a broad cooperative program to stimulate home remodeling as a means of getting housing for veterans.

Cooperation of communities, dealers, and lenders is being stimulated in this method of producing more living quarters for returning servicemen and their families.

Since property owners are not always aware of home potentialities in conversion and do not voluntarily seek out lenders or contractors to offer their properties as subjects for remodeling, the program is endeavoring to secure cooperation of numerous local agencies.

Owners may obtain loans up to \$5,000, with terms up to seven years, under the "Remodel for Veterans" program of the FHA.

SAN FRANCISCO REVISING BUILDING CODE

The San Francisco Bureau of Building Inspection, under the direction of John G. Little and assisted by George S. Hill and Feliz H. Spitzer, have been working for many months on a revision of San Francisco's Building Code, which was originally put into effect in 1909.

Preliminary revision of the Code has been completed, however, prior to submitting for approval by the Board of Supervisors, Mr. Little has released mimeographed copies to architects, engineers, and other interested groups, asking that they review the material and submit any suggestions they deem advisable.

Upon completion of this "industry" survey, the tentative Code will be reviewed and then submitted to the San Francisco Board of Supervisors for official adoption.

SIMPLIFIED PRACTICE

A simplified practice recommendation for Copper Water Tube and Copper and Brass Pipe has been approved, according to the National Bureau of Standards, to become effective March 15, 1946.

Known as R217-46, the recommendation covers copper water tube and copper and brass pipe intended for plumbing uses. It establishes a useful standard of practice in the production, distribution, and uses of these items, a simplified list of types and sizes.

OPENING OFFICE

Percy George Ball, Architect, announces the opening of offices at 701-11 Jones Building, 909 Broadway, Tacoma 2, Washington. He will engage in the general practice of architecture.

MODERN IS AS MODERN DOES

As an architect, you realize that homes not wired for the most convenient and efficient use of electricity cannot be called modern, even though they are new.

Your client may not realize how much his future comfort depends on a full measure of electricity for improved home lighting and an ever-expanding list of new electrical appliances; he may not understand that the difference is so small between a good wiring job and a poor one . . . until you tell him. But when the house is built and occupied, he will remember, with increasing satisfaction, your thoughtfulness in insisting on a wiring installation completely adequate for modern living.

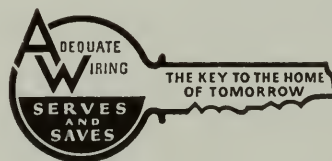

NORTHERN CALIFORNIA
ELECTRICAL BUREAU

1355 Market Street
San Francisco 3



*Be sure you're getting the
finest window glass obtainable*

it costs no more to specify

PENNUERNON

Distributed by...

W · P · FULLER & CO.
PAINTS • GLASS • WALLPAPER

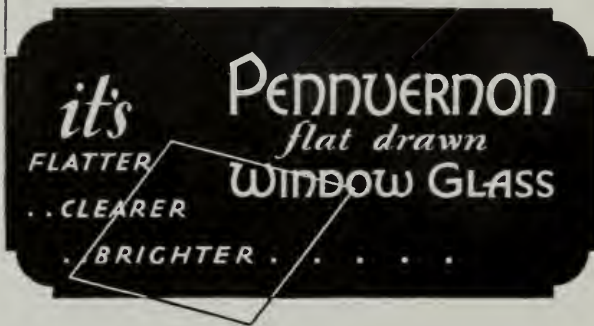

**E. K. WOOD
LUMBER CO.**

**WE MANUFACTURE
OR SUPPLY**

DOUGLAS FIR
REDWOOD
SUGAR OR
PONDEROSA PINE
SASH AND DOORS
MILLWORK
MASONITE TEMPERED PRESWOOD
CONCRETE FORM PANELS
CEMENT ASBESTOS BOARD
INSULATION AND
INSULATION BOARD
INSULATION TILE AND PLANK
PLASTER BOARD
FIR-TEX INSULATION PRODUCTS
TRIPLE-SEALED GYPLAP
SISALKRAFT BUILDING PAPER
ROOFING
WOODLIFE WATER REPELLENT
MASONITE CEL-U-BLANKET

DEPENDABLE QUALITY

LOS ANGELES
OAKLAND
SAN FRANCISCO

"GOODS OF THE WOODS"

**OPA CHARGED WITH
BUILDING CHAOS**

The cost of building new homes for veterans will decrease if the OPA grants the ceiling price increases needed to speed up production of scarce materials now holding up home building, is the opinion of Douglas Whitlock, chairman of the Advisory Board of the Producers' Council.

"The proposed \$600,000,000 subsidy plan, under which manufacturers would receive premium payments in place of ceiling price increases, would not reduce prices of homes, but would merely attempt to prevent prices from rising further," Whitlock reports.

Building costs are reported abnormally high because (1) builders have to resort to the black market to obtain some critical items, (2) many building products are being produced only in the higher grades which can be sold at a profit but cost considerably more than standard lines, and (3) because of extra expense incurred as a result of having to wait for materials, last minute substitutions and disrupted schedules.

Many manufacturers of building products are opposed to the Wyatt plan for premium subsidy payments as such a plan will not permit all out home building.

BRUCE M. DACK, Structural Engineer, announces opening of offices in Sacramento, California to serve the building industry of Central and Northern California.

PONDEROSA PINE ASSOCIATION

E. J. Curtis was elected president of the Ponderosa Pine Woodwork Association at the organizations recent annual meeting. Other officers named included: M. P. McCullough, vice president; Frank Stevens, secretary; and T. L. O'Gara, Treasurer.

Swift Berry of Camino, California; J. L. Pierce, Santa Clara, California; G. F. Neils, Klickitat, Washington; A. W. Olson, Missoula, Montana; and Hal Dixon of Spokane, Washington, were elected to the board of directors to represent the West.

TAXPAYERS MEET

The Twentieth Annual Meeting of California Taxpayers' Association was held in Los Angeles on March 26, 1946.

Speakers included Dr. George S. Benson of Harding College, Arkansas; James Mussatti, general manager of the California State Chamber of Commerce; and William Keith, president of Cosgrove & Company, and chairman of the Los Angeles Citizens' Revenue and Taxation Committee.

IN THE NEWS

VETERAN'S HOUSING

Since January 15, when the Veteran's Preference Rating System for home building went into effect, through March 7, more than 200,000 applications have been received by some 71 field offices. Of these, about 134,000 have been authorized.

RETURNS TO DESK

Henry Garnjobst, director of the American Lumber & Treating Co.'s News-Bureau, has returned to his desk in the company's Chicago offices, following an assignment with the Government in Washington, D. C.

ADJUSTABLE QUADRANGLE

A new plastic drafting tool combining many features not usually available in one instrument has been announced by the STEWART-JACKSON INSTRUMENT COMPANY of Los Angeles.

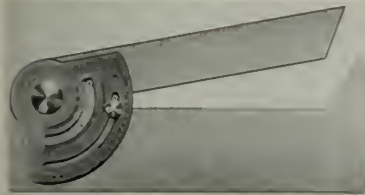

Called the S&J Quadrangle, angles from 0 to 90 degrees; pitch scales from 0 to 24 / 12; percentage slopes from 0 to 100 per cent; sine or cosine functions and tangents may be found. It has eight drawing edges, rectangular in shape, and may be used as a triangle.

TEXAS WYNNEWOOD

Work has started on the \$25,000,000 Wynnewood housing project in Dallas, Texas, which is believed to be the nation's largest integrated housing development. 820 acres in South Oak Cliff will provide 2,200 homes, 1000 apartments and a complete shopping center with a five year completion date.

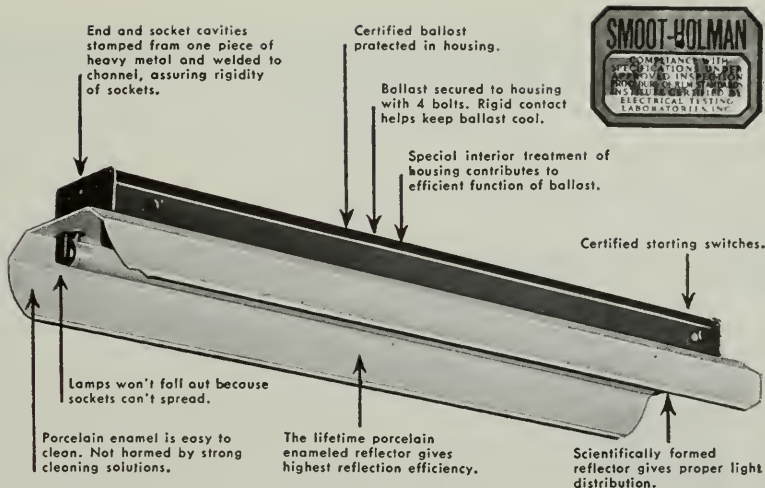

*Why Buy
Certified Quality?*

Because the many features which enable Smoot-Holman to certify highest quality provide equipment giving the most light with the least maintenance cost. The RLM label is an additional guarantee, because RLM quality is policed by independent testing laboratories. Because material shortages still exist, we can accept orders only for future delivery. We suggest that you anticipate the fall season by placing orders now to assure delivery at that time.



Offices in Principal Western Cities—Branch and Warehouse in San Francisco

PRODUCER'S COUNCIL PAGE

The National Organization of Manufacturers of Quality Building Materials and Equipment
affiliated with THE AMERICAN INSTITUTE OF ARCHITECTS

President, E. E. CATHCART
Johns-Monville Sales Corp.
116 New Montgomery St.

Vice-President, C. J. NICHOLAS
Boston-Marley Co.
301 Bronnon St.

Secretary, H. C. GALITZ
Westinghouse Electric Corp.
110 Sutter St.

Treasurer, E. P. LARSON
Celotex Corp.
675 Townsend St.

Edited by C. W. KRAFT, KRAFTILE CO., Niles, California

NORTHERN CALIFORNIA CHAPTER

Bill Collier, one of our new members, didn't take long to get into Council activities, and is serving currently on the very important Program Committee. His company, Leo J. Meyberg Co., of which he is Vice-President and Asst. General Manager represents the Norge Division of the Borg-Warner Corporation, new National Council members. Products include refrigerators, washing machines, heaters, coolers, and deep freeze equipment.



WM. A. COLLIER

Bill is a local boy for a change, born right out here in Livermore. Says his grandparents advised him that he was delivered by 5,000 tired and thirsty blackbirds at the end of a four year drought back in '99—it rained for six weeks thereafter. He now lives in San Mateo, is married and has two children.

Bill is active in his vocation, serving at present as President of the San Francisco Sales Manager's Association. His hobbies are gardening and fishing.

OTHER NEW MEMBERS at this writing are:

Ceco Steel Products Corp., Floyd E. Jennings and Philip E. Johnson and Tait Smith, Alternates.

General Electric Supply Co., C. A. Dahl and F. W. Fields, Alternate.

The Hillyard Company, J. F. Dukeslaw.

Schaible Company represented by Rayburn-Judd Co., E. B. Smith and C. R. Smith, Alternate.

ALL TIME HIGH for both Chapter and National organizations with 39 members in the Northern California Chapter and 81 Company and 22 Association members in the Council nationally.

PRESIDENT ED CATHCART reports a very nice trip to Chicago for the Chapter Presidents Conference March 4th and 5th and a very interesting session on Chapter activities. Particularly pleasing to Ed was to learn how far out in front was the

Northern California Chapter in accomplishing things that they are now trying to do elsewhere.

COUNCIL POSITION on the Emergency Housing Bill has been misrepresented by some of its more rabid proponents. Calculated to appeal to the emotions, the accusation that the Council is "opposed to housing for veterans" ignores the fact that the Council is opposed to some of the methods but not to the aim of the measure. Objection to the subsidy feature is a good case in point.

TECHNICAL INFORMATION COMMITTEE is active. The Lorimer film "A Scotsman Looks at Modular Coordination" was presented by Chairman Ray Brown to a meeting of the Building Industry Conference Board Wednesday, February 13th and The Northern California Section, American Ceramic Society Monday, March 18th.

Plans are now on foot for a request presentation by the Northern California Chapter AIA.

SOUTHERN CALIFORNIA also is making good use of the film, owned jointly by both Chapters. On Monday, February 18th a showing was made before a joint meeting of the Southern California Chapter of the AIA and the Producers' Council and on Thursday, February 21st to the San Fernando Valley Architects Group meeting.

MODULAR MOMENTS

Question: Does the system apply to wood-frame construction?

Mr. Lorimer: Yes. The 4" module is inherent in traditional 16" stud spacing and 48" sheet materials. The Architects' plans for such construction have always given nominal dimensions such as 4", 6" and 8" for studs which are actually dressed to smaller sizes. The difference between "nominal" and "actual" size should, therefore, prove no obstacle to the carpenter.



USE QUALITY PRODUCTS



CONSULT AN ARCHITECT

CHEERFULNESS IN LIVING

(From Page 30)

to possibilities of using plywood in features such as windbreaks, decorative fencing, and furniture.

Glass is the magic product that will affect the great change in our living habits. No longer in the office or home need we be imprisoned by stingy walls or worry over heat losses when we pierce the wall with ample windows. In truth, by orientation, heat from the sun can largely supplant costly artificial means. Of more importance is the fact that cheerfulness goes hand in hand with daylight and outdoor beauty. With daylight ever available and night illumination now practical, our attention need only be aimed at retaining existing beauty in nature or if this is already smirched by man, then to seek replacement.

Let us design the house as a part of the site. In this design, views framed by windows are more than three dimensional pictures for in addition we are closer to beauties of nature—birds and butterflies; changes in foliage, flowering and fruiting habits of plants; changes in sky tones; and thus inherent cheerfulness. We shall seek to have much of the indoors as a part of the outdoors. With this close association the well-designed building and grounds will continually afford complete harmony and fresh daily interests. With these goals attained as background in all homes, the doctor and social worker may have vacations.

In closing, let us not overlook new products of the plant world. Thousands of plant species and varieties are available and naturally the problem is to select those carrying the most interest yet harmonizing with each other and subduing this facade or strengthening that feature. One's home or office can have its own individuality due alone to plant selection. In any case do not adopt a planting scheme that savors of the spottiness characteristic of cemeteries.

Better plant selection is here already. Improvements are due to new introductions from little-exploited plant worlds of South America, Pacific Islands, and the Western States. Better plant selection will come also from improving strains of established species. Fortunately the propagators are now back at work. With encouragement they will develop local varieties of highly ornamental plants to withstand local conditions of frost and summer heat and yet further fascinate us with rich embellishments.

Back to the field survey and paper work in planning the site. Back to the supervision given grading, construction, and planting. Thus through these preliminaries and vital decisions, furthered by cooperation of all parties there emerges the well-developed site and there results cheerfulness of living.

SISALKRAFT

REG. U. S. PAT. OFF.

"More than a building paper"

THE SISALKRAFT CO.

205 West Wacker Drive
Chicago, Ill.

55 New Montgomery Street
San Francisco, Calif.

BASALITE

LIGHTWEIGHT CONCRETE
BUILDING UNITS

CHARACTER • ECONOMY • INSULATION
FIRE-SAFE • TERMITE PROOF • PERMANENCE

BASALT ROCK CO., INC.
NAPA, CALIFORNIA

FORDERER CORNICE WORKS

Manufacturers of

Hollow Metal Products • Interior Metal Trim
Elevator Fronts and Cabs
Metal Plaster Accessories • Sanitary Metal Base
Flat and Roll Metal Screens
Metal Cabinets • Commercial Refrigerators

269 POTRERO AVE.

SAN FRANCISCO, CALIF.

HEMLOCK 4100

STRUCTURAL STEEL

For Class A Buildings,
Bridges, etc.

JUDSON PACIFIC - MURPHY CORP.

1200 SEVENTEENTH STREET
SAN FRANCISCO

Plants: San Francisco - Oakland

REFERENCE FRAMES IN SPACE

(Continued from Page 10)

him the size values of his forms directly without having to resort to mathematical computations. Measurements in figures express abstract size relations void of any human connotation and offering no assistance for the imagination. It is hardly possible to visualize a room 7' 10" by 11' 9" but (assuming a unit of 4 feet) you can feel a space two units wide and three long. The "foot," although it has a human basis, is too small for mental handling. The meter, as the forty-millionth part of a meridian, is a theoretical absurdity without any meaning in real life. It can only serve to establish minute relationships of a mechanical nature.

The architectural product must be a part of human life, and unless related to us in scale and rhythm is monstrous. In order to be useful the unit must have a simple relation to human stature and must be large enough to keep the necessary number of units required to size the average room small enough for easy grasp. It must be small enough to fill all needs for detail sizes by subdividing into simple fractions which can easily be pictured, $\frac{1}{2}$, $\frac{1}{3}$ or $\frac{1}{4}$ at the most. For practical reasons the unit should adapt itself to certain standard dimensions already established in our industry—lumber lengths, door and ceiling heights,

16" in woodframing, etc.

I have found that the four-foot unit will satisfactorily fulfill all specifications outlined above. To show its application:

Human height = $1\frac{1}{2}$ units = 6'

Standard door height = $1\frac{2}{3}$ units = 6'

Standard room height = 2 units = 8'

Fractions: $\frac{1}{2}$ unit = 2'

$\frac{1}{3}$ unit = 16"

$\frac{1}{4}$ unit = 12"

These three fractions plus small multiples of the four-foot unit will give all the dimensions necessary for the architect. He can dispense with measuring tapes, rulers, figured dimensions, endless additions, subtractions, checking and re-checking of figures, confusing dimension lines and arrows.

It is, of course, possible to work with a grid which is not rectangular. To depart from this simple frame of reference of space, however, would be justified only by the most compelling reasons for it would result in tricky patterns and complicate three dimensional thinking.

To use the reference frames efficiently, the unit lines are indicated on all plans in form of a four-foot grid. One system of lines in the plan is marked by letters, the other is numbered, and the vertical ones marked with grades prefixed by a plus sign. Therefore, designation for any point on the building would take this form: A-111-16 or A $1\frac{1}{3}$ -111-16.

Such a system has innumerable advantages over the usual dimension figure. Besides helping the architect's vision, it simplifies construction and is absolutely necessary for the execution of space architecture. Room walls used to create space forms do not rise straight and boxlike from floor to ceiling, but may project or recess in between. Therefore, it is often necessary to make several successive floor plans on different levels between floor and ceiling. The average builder is unable to lay out these various levels properly unless he has the same fixed unit lines in all levels to refer to. In order to utilize fully the advantages of the unit-system on the premises, my specifications call for a continuous battenboard around the building on which the unit-lines must be marked by nails and their names. In laying out a building designed with this method, the builder does not have to start figuring and laboriously add up measurements back to some corner. A glance at the plan immediately locates any portion of the building, and a line stretched between two nails on the battenboard transfers this location onto the ground. Even fractional positions between the unit-lines are ascertained at a glance, and the largest measurement the builder has to deal with is four feet. The same battenboard serves all trades, and discrep-

(Continued on Page 44)

FOR SALE BUILDING NEWS

Pertinent facts relative to building and contracting projects contemplated in Northern California.

A DAILY ADVANCE new service giving name and location of project, architect, proposed cost, and other valuable information.

YOU GET DAILY REPORTS at a total cost of \$10 PER MONTH. Get prepared for the coming building opportunities.

Subscribe for This Service Today

ARCHITECT'S REPORTS

Published Daily by

ARCHITECT and ENGINEER, Inc.

68 Post Street, San Francisco

EXbrook 7182

ESTIMATOR'S GUIDE

BUILDING AND CONSTRUCTION MATERIALS

PRICES GIVEN ARE FIGURING PRICES AND ARE MADE UP FROM AVERAGE QUOTATIONS FURNISHED BY MATERIAL HOUSES TO SAN FRANCISCO CONTRACTORS. 2½% SALES TAX ON ALL MATERIALS BUT NOT LABOR

All prices and wages quoted are for San Francisco and the Bay District. There may be slight fluctuation of prices in the interior and southern part of the state. Freight cartage, at least, must be added in figuring country work.

BONDS—Performance—\$10 per \$1000 of contract. Labor and materials, \$10 per \$1000 of contract.

BRICKWORK—

Common Brick—Per 1M laid—\$50.00 to \$60.00 (according to class of work).

Face Brick—Per 1M laid—\$120 to \$150 (according to class of work.)

Brick Steps—\$1.60 per lin. ft.

Brick Veneer on Frame Bldg.—Approx. \$1.30 per sq. ft.

Common Brick—\$19.00 per M, truckload lots, f.o.b. job.

\$19.00 per M, less than truckload, plus cartage.

Face Brick—\$40 to \$80 per M, truckload lots, delivered.

Cartage—Approx. \$4.00 per M.

BUILDING PAPER—

1 ply per 1000 ft. roll.....	\$3.50
2 ply per 1000 ft. roll.....	5.00
3 ply per 1000 ft. roll.....	6.25
Brownskin, Standard, 500 ft. roll.....	5.00
Sisalcraft, 500 ft. roll.....	5.00
Sash cord com. No. 7.....	\$1.20 per 100 ft.
Sash cord com. No. 8.....	1.50 per 100 ft.
Sash cord spot No. 7.....	1.90 per 100 ft.
Sash cord spot No. 8.....	2.25 per 100 ft.
Sash weights, cast iron, \$50.00 ton.	
Nails, \$3.42 base.	
Sash weights, \$45.00 per ton.	

CONCRETE AGGREGATES—

The following prices net to Contractors unless otherwise shown.

Gravel, all sizes—
\$1.95 per ton at Bunker; delivered\$2.50

	Bunker	Del'd
Top Sand	\$1.90	\$2.50
Concrete Mix	1.90	2.45
Crushed Rock, ¼" to ¾".....	1.90	2.50

Crushed Rock, ¾" to 1½".....	1.90	2.50
Roofing Gravel	2.25	2.80
River Sand	2.00	2.45

Sand—

River Sand	2.00	2.45
Lapis (Nos. 2 & 4).....	2.85	3.15
Olympia (Nos. 1 & 2).....	2.85	3.10
Del Monte White84c per sack	

Cement—

Common (all brands, paper sacks), carload lots, \$2.42 per bbl. f.o.b. car; delivered \$2.72. Cash discount on carload lots, 10c a bbl., 10th Prox.; less than carload lots \$3.20 per bbl. f.o.b. warehouse or delivered.

Cash discount 2% on L.C.L.

Atlas White	} 1 to 100 sacks, \$2.50 sack warehouse or del.; \$7.65 bbl. carload lots.
Calaveras White	
Medusa White	

Forms labor average \$350 per 1000 sq. feet.

Average cost of concrete in place, 50c per cubic foot, exclusive of forms; \$15.00 per cubic yard. With forms \$1.60 per cubic foot.

DAMP-PROOFING and Waterproofing—

Two-coat work, \$3.50 per square.

Membrane waterproofing—4 layers of saturated felt, \$7.00 per square.

Hot coating work, \$2.50 per square.

Medusa Waterproofing, \$3.50 per lb. San Francisco Warehouse.

Tricocel waterproofing.

(See representative.)

ELECTRIC WIRING—\$12 to \$15 per outlet for conduit work (including switches).

Knob and tube average \$3.00 per outlet. (Available only for priority work.)

ELEVATORS—

Prices vary according to capacity, speed and type. Consult elevator companies. Average cost of installing a slow speed automatic passenger elevator in small four story apartment building, including entrance doors, about \$6500.00.

EXCAVATION—

Sand, 60 cents; clay or shale \$1 per yard.

Trucks, \$20 to \$32 per day.

Above figures are an average without water. Steam shovel work in large quantities, less; hard material, such as rock, will run considerably more.

FIRE ESCAPES—

Ten-foot galvanized iron balcony, with stairs, \$150 installed on new buildings; \$160 on old buildings.

FLOORS—

Composition Floors, such as Magnesite, 50c per square foot.

Linoflor—2 gages—\$1.25 to \$2.75 per sq. yd.

Mastopave—90c to \$1.50 per sq. yd.

Battleship Linoleum—available to Army and Navy only—1/8"—\$1.75 sq. yd. 7/8"—\$2.00 sq. yd.

Terazzo Floors—50c to 70c per sq. ft.

Terazzo Steps—\$1.75 per lin. ft.

Mastic Wear Coat—according to type—20c to 35c.

Hardwood Flooring—

Standard Mill grades not available.

Victory Oak—T & G	
¾" x 2¼".....	\$143.25 per M. plus Cartage
½" x 2".....	122.00 per M. plus Cartage
½" x 1½".....	113.50 per M. plus Cartage
Prefinished Standard & Better Oak Flooring	
¾" x 3¼".....	\$180.00 per M. plus Cartage
½" x 2½".....	160.50 per M. plus Cartage

Maple Flooring

¾" T & G Clear	\$160.50 per M. plus Ctg.
2nd	153.50 per M. plus Ctg.
3rd	131.25 per M. plus Ctg.

Floor Layers' Wage, \$1.50 per hr.

GLASS—

Single Strength Window Glass.....	20c per □ ft
Double Strength Window Glass.....	30c per □ ft.
Plate Glass, under 75 sq. ft.....	\$1.00 per □ ft.
Polished Wire Plate Glass.....	1.40 per □ ft.
Rgh. Wire Glass34 per □ ft.
Obscure Glass27 per □ ft.
Glazing of above is additional.	
Glass Blocks	\$2.50 per □ ft. set in place

HEATING—

Average, \$1.90 per sq. ft. of radiation, according to conditions.

Warm air (gravity) average \$48 per register.

Forced air, average \$68 per register.

IRON—Cost of ornamental iron, cast iron, etc., depends on design:

LUMBER—All lumber at O.P.A. ceiling prices—

No. 1 Common	\$49.00 per M
No. 2 Common	47.75 per M
Select O. P. Common	52.75 per M

Flooring—

	Delvd.
V.G. D.F. B & Btr. 1 x 4 T & G Flooring	\$80.00
C 1 x 4 T & G Flooring	75.00
D 1 x 4 T & G Flooring	65.00
D.F.-S.G. B & Btr. 1 x 4 T & G Flooring	61.00
C 1 x 4 T & G Flooring	59.00
D 1 x 4 T & G Flooring	54.00
Rwd. Plastic—"A" grade, medium dry	82.00
"B" grade, medium dry	78.50

Plywood—not available

	Under \$200	Over \$200
"Plyscord"— $\frac{3}{4}$ "	\$49.50	\$47.55
"Plywall"— $\frac{1}{4}$ "	45.15	43.30
3 ply— $\frac{2}{8}$ — $\frac{1}{4}$ "	48.55	46.60
"Plyform"— $\frac{3}{8}$ "		
Unoiled	126.50	121.45
Oiled	127.90	122.75

Above prices delivered if quantity is sufficient to warrant delivery.

Shingles (Rwd. not available)—

Red Cedar No. 1—\$6.75 per square; No. 2, \$5.75; No. 3, \$4.45.
Average cost to lay shingles, \$3.00 per square.
Cedar Shakes—Tapered: $\frac{1}{2}$ " x $\frac{3}{4}$ " x 25"—\$8.95 per square.
Resawn: $\frac{3}{4}$ " x $\frac{1}{4}$ " x 25"—\$10.65 per square.
Resawn: $\frac{3}{4}$ " x $\frac{1}{4}$ " x 25"—\$10.65 per square.
Average cost to lay shakes, \$4.00 per square.

MILLWORK—Standard.

D. F. \$100 per 1000. R. W. Rustic \$100.00 per 1000 (delivered).
Double hung box window frames, average with trim \$6.50 and up, each.
Complete door unit, \$10.00.
Screen doors, \$3.50 each.
Patent screen windows, 25c a sq. ft.
Cases for kitchen pantries seven ft. high, per lineal ft., \$9.00 each.
Dining room cases, \$9.00 per lineal foot.
Rough and finish about 80c per sq. ft.
Labor—Rough carpentry, warehouse heavy framing (average), \$40.00 per M.
For smaller work average, \$40.00 to \$55.00 per 1000.

MARBLE—(See Dealers)

PAINTING—

Two-coat work	per yard 50c
Three-coat work	per yard 70c
Cold water painting	per yard 10c
Whitewashing	per yard 8c

PAINTS—

Two-coat work50c per sq. yd.
Three-coat work70c per sq. yd.
Cold water painting.....per yard 10c
Whitewashing 8c per sq. yd.
Turpentine \$1.03 per gal. in drum lots.
\$1.08 per gal. in 5-gal. containers.
Raw Linseed Oil—not available.

Boiled Linseed Oil—\$1.38 per gal. in drums. Available only to work with high priority—\$1.48 per gal. in 5-gal. containers.

Use replacement oil—\$1.86 per gal. in 1-gal. containers.

Replacement Oil—\$1.20 per gal. in drums. \$1.30 per gal. in 5-gal. containers.

A deposit of \$6.00 required on all drums.

PATENT CHIMNEYS—

6-inch\$1.20 lineal foot
8-inch 1.40 lineal foot
10-inch 2.15 lineal foot
12-inch 2.75 lineal foot

PLASTER—

Neat wall, per ton delivered in S. F. in paper bags, \$17.60.

PLASTERING (Interior)—

	Yard
3 Coats, metal lath and plaster	1.50
Keene cement on metal lath	1.80
Ceilings with $\frac{3}{4}$ hot roll channels metal lath (lath only)	1.20
Ceilings with $\frac{3}{4}$ hot roll channels metal lath plastered	2.20
Single partition $\frac{3}{4}$ channel lath 1 side (lath only)	1.20
Single partition $\frac{3}{4}$ channel lath 2 inches thick plastered	3.20
4-inch double partition $\frac{3}{4}$ channel lath 2 sides (lath only)	2.20
4-inch double partition $\frac{3}{4}$ channel lath 2 sides plastered	3.85
Thermax single partition; 1" channels; $\frac{2}{4}$ " overall partition width. Plastered both sides	3.30
Thermax double partition; 1" channels; $\frac{4}{4}$ " overall partition width. Plastered both sides	4.40
3 coats over 1" Thermax nailed to one side wood studs or joists	1.65
3 coats over 1" Thermax suspended to one side wood studs with spring sound isolation clip	1.90
Note—Channel lath controlled by limitation orders.	

PLASTERING (Exterior)—

	Yard
2 coats cement finish, brick or concrete wall	1.00
3 coats cement finish, No. 18 gauge wire mesh	2.00
Lime—\$3.00 per bbl. at yard.	
Processed Lime—\$3.10 bbl. at yard.	
Rock or Grip Lath— $\frac{3}{8}$ "—20c per sq. yd.	
$\frac{1}{4}$ "—19c per sq. yd.	

Composition Stucco—\$1.80 to \$2.00 sq. yard (applied).

PLUMBING—

From \$100.00 per fixture up, according to grade, quantity and runs.

ROOFING—

"Standard" tar and gravel, 4 ply—\$8.00 per sq. for 30 sqs. or over.
Less than 30 sqs. \$9.50 per sq.
Tile, \$30.00 to \$40.00 per square.
Redwood Shingles, \$7.50 per square in place.
5/2 # 1-16" Cedar Shingles, 4 1/2" Exposure\$8.00 square

5/8 x 16"—# 1 Cedar Shingles, 5" Exposure\$9.00 square
4/2 # 1-24" Royal Shingles, 7 1/2" Exposure\$9.50 square
Re-coat with Gravel \$4.00 per sq.
Asbestos Shingles, \$23 to \$28 per sq. laid.
1/2 x 25" Resawn Cedar Shakes, 10" Exposure\$10.50
3/4 x 25" Resawn Cedar Shakes, 10" Exposure 11.50
1 x 25" Resawn Cedar Shakes, 10" Exposure 12.50
Above prices are for shakes in place.

SHEET METAL—

Windows—Metal, \$1.75 a sq. ft.
Fire doors (average), including hardware \$2.00 per sq. ft.

SKYLIGHTS—(not glazed)

Copper, 90c sq. ft. (flat).
Galvanized iron, 40c sq. ft. (flat).
Vented hip skylights 60c sq. ft.

STEEL—STRUCTURAL—

\$150 ton (erected), this quotation is an average for comparatively small quantities. Light truss work higher. Plain beams and column work in large quantities \$140 per ton.

STEEL REINFORCING—

\$100 to \$130 ton, set.

STONE—

Granite, average, \$6.50 cu. foot in place
Sandstone, average Blue, \$4.00. Boise. \$3.00 sq. ft. in place.
Indiana Limestone, \$2.80 per sq. ft. in place.

STORE FRONTS (None available).

TILE—

Ceramic Tile Floors—\$1.00 to \$1.25 per sq. ft.
Cove Base—\$1.10 per lin. ft.
Glazed Tile Wainscot—\$1.25 per sq. ft.
Asphalt Tile Floor $\frac{1}{8}$ " & $\frac{3}{16}$ "—\$.18 to \$.35 per sq. ft. Light shades slightly higher.
Cork Tile—\$.40 to \$.75 per sq. ft.
Mosaic Floors—see dealers.
Lino-Tile, \$.35 to \$.75 per sq. ft.

Wall Tile—

Glazed Terra Cotta Wall Units (single faced) laid in place—approximate prices:
2 x 6 x 12.....\$1.10 sq. ft.
4 x 6 x 12..... 1.25 sq. ft.
2 x 8 x 16..... 1.20 sq. ft.
4 x 8 x 16..... 1.40 sq. ft.

VENETIAN BLINDS—

40c per square foot and up. Installation extra.

WINDOWS—STEEL—

30c per square foot, \$5 for ventilators.

IN THE NEWS

"KRAFLITE" BLOCKS

Another building material has been added to the list of products manufactured, or distributed, by the KRAFTILE COMPANY of Niles, California.

It consists of a lightweight concrete block known as "Kraflite" which is inexpensive, fireproof, and termite proof, and is manufactured of batched aggregates and pure lightweight pumicite.

C. W. Kraft, president of the company, announces that James Crawford, vice president of Kraftile will be in charge of the "Kraflite" division.

HOWARD RILEY, 405 New World Life Bldg., Seattle, Wash., to 304 Westlake Square Bldg., Seattle, Wash.

J. CLARENCE FELCIANO, 4010 Montecito, Ave., Santa Rosa, Calif., to Box 424, Santa Rosa, Calif.

W. M. CLARKE, 1371 San Pasqual Ave., Pasadena to 435 No. Beechwood Drive, Los Angeles 4, Calif.

ARTHUR C. MUNSON, 433 So. Spring St., Los Angeles, to 728 Fidelity Bldg., Los Angeles, 13.

JOSEPH C. LONGUEVILLE, 417 N. Palm, Alhambra to 400 Meridian, Alhambra, Calif.

SITE PLANNER LANDSCAPE ARCHITECT

*Civic Recreational Areas
Memorial Sites
Residential Grounds
Commercial Developments*

ALLAN HIMES REID

244 Oxford Ave., Palo Alto
Phones: Palo Alto 2-4226
San Francisco: Garfield 5084

1945 BUILDING TRADES WAGE SCALES (JOB SITES) NORTHERN CALIFORNIA

Six- and seven-hour day eliminated on all Government Work. A. F. L. - O. P. M. Agreement calls for eight-hour day.

NOTE: Predeterminations by the Department of Labor, as of July 1, 1944 (the wage-freezing date) have not yet been made in all of the counties listed. The wage scales shown are those being paid and in effect mostly by agreement between employees and their union.

CRAFT	San Francisco	Alameda and Contra Costa	Fresno	Marin	Sacramento	San Jose	San Mateo	Vallejo	Stockton
ASBESTOS WORKERS.....	1.50	1.50	1.25	1.50	1.50	1.25	1.50	1.50	1.25
BRICKLAYERS.....	1.87½	1.87½	1.75	1.87½	1.75	2.00	1.79-1/6	1.75	1.50
BRICKLAYERS, HODCARRIERS.....	1.40	1.40	1.05	1.40	1.05	1.50	1.35	1.50	1.14
CARPENTERS.....	1.50	1.50	1.43¾	1.37½	1.37½	1.37½	1.43¾	1.50	1.37½
CEMENT FINISHERS.....	1.50	1.50	1.50	1.50	1.50	1.50	1.50	1.50	1.50
ELECTRICIANS.....	1.70	1.70	1.70	1.70	1.70	1.70	1.70	1.70	1.70
ELEVATOR CONSTRUCTORS.....	1.75½	1.75½	1.75½	1.75½	1.75½	1.75½	1.75½	1.75½	1.75½
ENGINEERS: MATERIAL HOIST.....	1.50	1.50	1.25	1.50	1.37½	1.62½	1.50	1.37½	1.25
PILE DRIVER.....	1.75	1.75	1.60	1.75	1.75	1.75	1.75	1.75	1.60
STRUCTURAL STEEL.....	1.75	1.75	1.60	1.75	1.75	1.75	1.75	1.75	1.60
GLASS WORKERS.....	1.40	1.40	1.12½	1.40	1.12½	1.21	1.40	1.40	1.40
IRONWORKERS: ORNAMENTAL.....	1.60	1.50	1.60	1.50	1.60	1.31¼	1.50	1.50	1.25
REINF. RODMEN.....	1.50	1.50	1.60	1.50	1.50	1.60	1.50	1.50	1.25
STRUCTURAL.....	1.75	1.75	1.75	1.75	1.75	1.75	1.75	1.75	1.37½
LABORERS: BUILDING.....	1.00	1.00	.90	.87½	.95	.90	.93¾	.90	.90
CONCRETE.....	1.00	1.00	.90	.87½	.95	.90	.93¾	.90	1.00
LATHERS.....	1.75	1.75	1.50	1.75	1.60	1.75	1.75	1.75	1.75
MARBLE SETTERS.....	1.50	1.50	1.50	1.50	1.50	1.50	1.50	1.50	1.50
MOSAIC & TERRAZZO.....	1.25	1.25	1.12½	1.25	1.15-5/8	1.12½	1.25	1.25	1.25
PAINTERS.....	1.50	1.50	1.28-4/7	1.50	1.43	1.50	1.42-6/7	1.64-2/7	1.37½
PILEDRIVERS.....	1.54	1.54	1.54	1.54	1.54	1.54	1.54	1.54	1.54
PLASTERERS.....	1.75	1.83½	1.75	1.75	1.75	2.00	2.00	1.75	1.83-1/3
PLASTERERS' HODCARRIERS.....	1.50	1.60	1.40	1.50	1.18¾	1.50	1.75	1.50	1.50
PLUMBERS.....	1.70	1.70	1.53-1/8	1.70	1.68¾	1.62½	1.70	1.70	1.50
ROOFERS.....	1.50	1.50	1.25	1.37½	1.37½	1.37½	1.25	1.37½	1.37½
SHEET METAL WORKERS.....	1.50	1.50	1.50	1.50	1.50	1.50	1.37½	1.50	1.50
SPRINKLER FITTERS.....	1.58	1.58	1.53-1/8	1.70	1.68¾	1.62½	1.70	1.70	1.50
STEAMFITTERS.....	1.75	1.75	1.53-1/8	1.70	1.68¾	1.62½	1.50	1.70	1.50
STONESETTERS (MASON'S).....	1.87½	1.87½	1.50	1.75	1.75	1.50	1.75	1.75	1.50
TILESETTERS.....	1.50	1.50	1.37½	1.50	1.37½	1.50	1.50	1.50	1.37½

Prepared and compiled by

CENTRAL CALIFORNIA CHAPTER, ASSOCIATED GENERAL CONTRACTORS OF AMERICA

with the assistance and cooperation of secretaries of General Contractors Associations and Builders Exchanges of Northern California.

CLASSIFIED ADVERTISING

RATE: 8c PER WORD . . . CASH WITH ORDER

MINIMUM \$1.50 (3 Lines)

ARCHITECT'S REPORTS—A valuable advance news service giving building and construction information daily on projects in Northern California. Name, location, architect, proposed cost, etc., on individual slips. Ideal for securing new business leads. Hundreds of items, total monthly cost only \$10. Don't delay, subscribe today. ARCHITECT & ENGINEER, Room 618, 68 Post Street, San Francisco, California. Phone DOUGLAS 8311.

ARCHITECTS—A. McF. McSweeney, Architect, Room 927 Hearst Bldg., San Francisco. New offices. Desires catalogs.

PHOTOGRAPHY—Keep a pictorial record of your building, or construction project. Pictures are of tremendous value to contractors, builders, engineers, architects. For Industrial-Publicity-Aerial photography, see

FRED MAE, Room 721-22 Hearst Bldg., San Francisco 3, California.

PRINTING—Printers, bookbinders. See us for commercial printing. Mercury Press, 942 Howard Street, San Francisco.

WANTED—Architectural designer capable of taking charge of office, general practice. Excellent opportunity. Telephone Hlgate 6449, Oakland, California.

**CLINTON
CONSTRUCTION CO.
OF CALIFORNIA**

General Contractors

923 FOLSOM STREET • SAN FRANCISCO

SUtter 3440

MALOTT & PETERSON

**ROOFING AND FLOORING
CONTRACTORS**

20TH AND HARRISON STREETS

SAN FRANCISCO

Phone ATwater 1600

HOGAN LUMBER CO.

Wholesale and Retail

LUMBER

MILL WORK • SASH & DOORS

Office, Mill, Yard and Docks

SECOND AND ALICE STREETS • OAKLAND, CALIF.

Telephone GLencourt 6861

SANTA MARIA INN

SANTA MARIA, CALIFORNIA

FRANK J. McCOY, General Manager

FERNAND E. PIMENTEL, Manager

On the
Coast
Highway
between
San
Francisco
and
Los
Angeles



American
or
European
Plan
•
Old
English
Tap
Room

**REFERENCE FRAMES
IN SPACE**

(Continued from Page 40)

ancies in the location of pipes, ducts, etc., are impossible.

It is further obvious that a number plus a letter plus a grade indicates with precision any point on the plan and in the building. This makes it possible to make specific instructions given by telephone or in writing. Detail sections are taken along unit-lines and may be broken in the plan and indexed without additional confusing section lines and numbers. It makes it possible to number and locate at the same time all columns, beams, doors and details, etc., with precision, eliminating the search for parts, reference numbers and sections throughout the plans. This feature makes the unit system plan absolutely essential for prefabrication, where speed in numbering, listing, checking and assembling of parts is important. A generally accepted unit scheme would further a healthy standardization in the whole building industry—healthy because it would standardize measurements and simplify assembly without forcing the use of too many similar parts. Such standardization would not suppress individual expression but stimulate it.

I shall submit a simple example to show that the 4" unit cannot be maintained and does not solve the problem of fabricating parts which are universally usable. Say that a manufacturer making steel sash, which may have to be used in continuous rows, provides a 4" mullion. Such a mullion would not accommodate a cross partition of either hollow tile, wood frame or brick, since the plastered thickness of each of these is about 5½", and it is therefore not practical. An 8" mullion is too wide to maintain the effect of a continuous opening. However, if the same factory would make windows to fit a four-foot unit scheme, designing the mullions at a minimum width which would be practicable for all its possible uses, his product would fit without disturbance into all houses based on the same unit. To make a unit dimension of 4" or 8" mandatory for all brick work means complete standardization, not only for the brick but also for the joint and therefore eradicating all freedom of design. We must realize that "proportion" is not any more a simple mathematical relationship (Golden Rule, etc.) which can be applied universally in all buildings as it was in classical times. Proportion is an alive and expressive tool in the hands of the modern architect who uses its variations freely to give each building its own individual feeling. Only a large four-foot unit will give him enough leeway to relate the brick with

(Continued on opposite page)

IN THE NEWS

1946 EDITION UNIFORM BUILDING CODE.
Published by the Colling Publishing Company, 124
W. 4th Street, Los Angeles 13, California. Cloth
bound \$3.00; Paper \$2.50.

The 1946 Edition of the Uniform Building Code contains many important and far reaching changes which have been approved at Annual Conventions of the Pacific Coast Building Officials Conference since publication of the 1943 Edition.

Extensive revisions which take into consideration new materials as well as new uses of old materials, include Administration (Chapters 1 to 4); Masonry (Chapter 24); Glued Structural Lumber (Sections 2526 to 2530, Chapter 25); Chimneys, Vents, and Fireplaces (Chapter 37); Prefabricated Construction (Chapter 50); Heating Appliances (Chapter 51); and additional regulations are included for floor furnaces, attic furnaces, commercial gas ranges, large boilers, domestic water heaters, construction of warm air ducts, and the performance standards of the appliances.

REFERENCE FRAMES IN SPACE

(Continued)

whatever joint his proportional scheme demands.

It is not necessary that the designer be completely enslaved by the grid. I have found that occasionally a space-form may be improved by deviating slightly from the unit. Such sparing deviation does not invalidate the system as a whole but merely reveals the limits inherent in all mechanical schemes.

Since I believe that "space-architecture" and not the now fashionable "International" and "Functional" styles will be the lasting contribution of our time to the future, it is important for the builders to acquaint themselves with the use of reference frames as soon as possible.

March 25, 1946

Architect & Engineer
68 Post St.,
San Francisco, California

Dear sir:

Having returned from my war job, I am again at home, at the old stand. I miss your Magazine on my desk so please enter my name on your mailing list. Will enclose check for three dollars, the old subscription; if more let me know. It could start with the March number if there are any on hand.

Colusa, Calif.

Yours truly,
Harry U. Stople.

The Most Complete Line of
STEELS and BUILDING MATERIALS
Made by a Single Producer



See Sweet's Catalog File or write us for
full information.

REPUBLIC STEEL CORPORATION
GENERAL OFFICES: CLEVELAND, OHIO

DENVER, COLORADO CONTINENTAL OIL BUILDING
LOS ANGELES, CALIFORNIA EDISON BUILDING
SALT LAKE CITY, UTAH WALKER BANK BUILDING
SAN FRANCISCO, CALIFORNIA RIALTO BUILDING
SEATTLE, WASH. WHITE-HENRY-STUART BUILDING

PACIFIC MANUFACTURING CO.

HIGH CLASS INTERIOR FINISH
QUALITY MILLWORK

142 SANSOME ST., SAN FRANCISCO
Garfield 7755

6820 MCKINLEY AVE., LOS ANGELES
THornwall 4196

BUILDERS EXCHANGE, OAKLAND

"AMERICAN - MARSH"

CONDENSATION UNIT

Pumping
Machinery
for
Every
Purpose

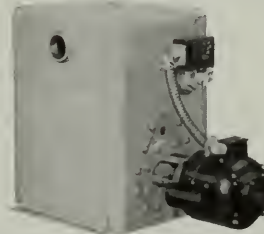

For Service
Call
DOuglas
6794
or
MUtual 8322

SIMONDS MACHINERY CO.
SAN FRANCISCO 816 FOLSOM
LOS ANGELES 455 EAST 4TH

VERMONT MARBLE COMPANY

Producers and Finishers
of
Domestic and Imported Marbles

Write for new pamphlet describing our
Marble Toilets and Showers

San Francisco and Los Angeles
San Francisco phone: SUtter 6747



Real Estate Loans



F H A loans are readily available on existing homes up to 80% of the appraised value. You can buy a home and pay for it in small monthly installments like rent. For example, a 20-year loan of \$6000 would cost about \$49.56 per month, including taxes, insurance, principal and interest.

*Come in and talk with us
We can help you get the home
you want*

CROCKER FIRST NATIONAL BANK

OF SAN FRANCISCO
California's Oldest National Bank
ONE MONTGOMERY STREET
Member Federal Deposit Insurance Corporation

Venetian Blinds
of
Metal or Wood
for
Homes and Offices

Installed and Serviced
by

GUNN CARLE & CO.

20 POTRERO AVENUE
SAN FRANCISCO 3
UNDERhill 5480

IN THE NEWS

WALLPAPER DESIGN

An international wallpaper design contest with \$7,500 in prizes has been announced by UNITED WALLPAPER, Inc., 3330 West Fillmore Street, Chicago. Open to everyone the competition will be conducted from April 1, 1946 to August 31, 1946.

A NEW BRANCH

New offices of the firm of Mangrum, Holbrook & Elkus, have been established at 508 "J" Street, Sacramento, California. The Company now operate branches in San Francisco, Oakland, Los Angeles, and Sacramento.

ON JOB AGAIN

Marx Hyatt, San Francisco district sales manager of the American Lumber and Treating Company, has resumed his duties following military service. Production plants are operated at Wauna, Oregon, and Weed, California.

NEW DOORHOLDER

A new idea in doorholders is introduced to the building, hardware, and institutions field by the SWALLOW AIRPLANE CO., of Wichita, Kansas.

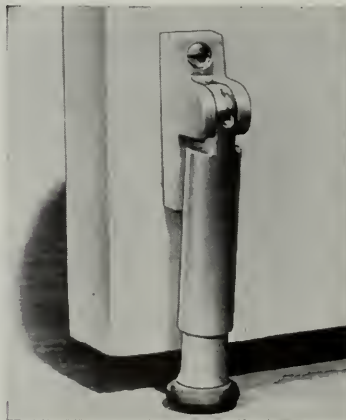

Employing the spring idea the "Doormaster" holds the heaviest doors without slipping. It is made of durable aluminum and mounts a tough rubber foot firmly to the spring loaded piston, and may be easily raised when not in use.

KYLE FORREST

Civil Engineer

Water Supply — Sanitation

Municipal — Private
Consultations — Investigations
Reports — Designs — Valuations
Supervision — Litigation

Ground Water Work a Specialty

Hydrologic studies — wells, de-watering, underdrainage, foundations, conservation, testimony.

1504 Russ Building
San Francisco 4
YUkon 0652

JOHN D. McLAUGHLIN

Consulting Electrical Engineer

Electrical Designs
Industrial Power and
Lighting Layouts
Airport Lighting Design

SERVICES FOR
ARCHITECTS AND ENGINEERS

1641 Russ Building
San Francisco, California
Telephone EXbrook 5712

Scott Company

HEATING . . PLUMBING . . TILE



243 MINNA STREET
SAN FRANCISCO
Phone EXbrook 6741

Swimming Pools of Distinction

Built by technicians with specialized pool construction experience.

Landon Standard Pools

A Northern California Enterprise.

(We have the Background, the Men and the Material)
Telephone Belmont 2312 425 Old County Road Belmont, Calif.

MULLEN MFG. COMPANY

BANK, STORE AND OFFICE
FIXTURES—CABINET WORK
OF GUARANTEED QUALITY
CHURCH SEATING

Office and Factory:
60-80 RAUSCH ST., Bet. 7th and 8th Sts.
San Francisco
Telephone UNderhill 5815

THE TORMEY COMPANY

GENERAL PAINTERS
AND DECORATORS

Phone UNderhill 1913

563 FULTON STREET
San Francisco

G. P. W. JENSEN & SON

Building Construction

320 Market Street, San Francisco
Phone: GARfield 2444

JOHN CASSARETTO COMPANY

—Since 1886—And Still Active—

Building Materials

READY MIX CONCRETE
ROCK - SAND - GRAVEL - LIME
CEMENT - PLASTER - MORTAR
METAL LATH - WOOD LATH
STUCCO - WIRE NETTING

Service Unexcelled

Bunkers
Sixth and Channel, San Francisco
Phones: GARfield 3758 - 3760

IN THE NEWS

UNHEARD OF

Building valuation for January 1946 in Los Angeles showed an increase over January of 1945 of more than \$14,000,000, or 566 per cent.

NEW SWINGSPOUT FAUCET

Designed for kitchen and "utility" use, the new COMMODORE ledge type swingspout faucet manufactured by the General Tire and Rubber Company of California, is now on the market.

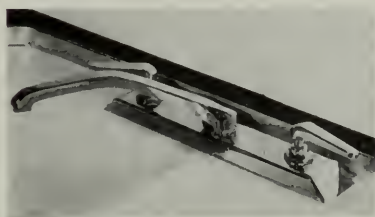

First in a line of plumbing fixtures to be manufactured by this company, emphasis has been placed on ease of cleaning and working clearance.

PUBLIC RELATIONS

The annual meeting of the American Public Relations Association, held in Washington, D. C., the latter part of March, disclosed the fact that many organizations, business institutions, and industrial organizations are seeking favorable public support through educational programs.

INSULUX LOS ANGELES

Kenneth H. Cunningham and E. C. Titus have rejoined the sales office of the Insulux Products Division of the Owens-Illinois Glass Company at Los Angeles, after serving in the armed forces of the U. S. during the War.

TACOMA ARCHITECT

Percy Ball, Architect, has opened offices in the Jones Building, Tacoma, Washington, for the general practice of architecture.

DINWIDDIE CONSTRUCTION COMPANY

BUILDERS

CROCKER BUILDING
SAN FRANCISCO



HERRICK IRON WORKS

STRUCTURAL STEEL
REINFORCING STEEL

18TH AND CAMPBELL STS.
OAKLAND, CALIF.
Phone GLencourt 1767

Phone GARfield 1164

Thomas B. Hunter

Consulting Engineer

DESIGNER OF HEATING
AIR CONDITIONING
VENTILATING AND WIRING
SYSTEMS, MECHANICAL
AND ELECTRICAL EQUIP-
MENT OF BUILDINGS

41 SUTTER STREET
ROOM 710
San Francisco California

ANDERSON & RINGROSE

General Contractors

320 Market Street, San Francisco
Phone GARfield 2245

SMITH, EMERY & CO.

Since 1904

Engineers - Chemists

Inspection, Tests, Analyses,
Research, Consultation
Structural Materials, Structures,
Equipment, Pipe, Soils

Associates

Los Angeles and Eastern Cities

Offices and Laboratories

651 Howard Street, San Francisco

A. F. MATTOCK CO.

Builders

★

212 CLARA STREET
SAN FRANCISCO

INDEPENDENT IRON WORKS

Steel Buildings
Service Stations
Steel Storage Tanks
Fabricated Plate Work
Steel & Sheet Metal Products
Fabricated Structural Steel
Steel Distributors

Eighth & Pine Sts. Oakland, 7

George F. Brayer

ELECTRICAL
CONTRACTOR

166 Seventh Street
San Francisco

Phones: KLondike 2-0879
HEmlock 2646

Index to Advertisers

ALADDIN Heating Corp.	48
ANDERSON, & Ringrose	47
ANGIER Sales Corporation.	30
ARCHITECTS Reports	40
BASALT Rock Company	39
BAXTER & Company, J. H.	34
BRAYER, Geo. F.	48
CASSERETTO, John	47
CLARK, N., & Son	*
CLASSIFIED ADVERTISING	43
CLINTON Construction Company ...	44
COLUMBIA Steel Co.	*
COLOTYLE Corporation	*
CROCKER First National Bank	46
DINWIDDIE, Construction Company ..	47
FORDERER, Cornice Works	39
FORREST, Kyle	46
FULLER, W. P., Co.	36
GUNN, Carle & Company	46
HANKS, Inc., Abbot A.	48
HAWS Drinking Faucet Company * ..	Back Cover
HERRICK Iron Works	47
HOGAN Lumber Company	44
HUNT, Robert W., Company	48
HUNTER, Thos. B.	47
IMPERIAL Brass Manufacturing Co. ...	*
INDEPENDENT Iron Works	48
JENSEN & Son, G. P. W.	47
JOHNSON, Company, S. T.	*
JUDSON, Pacific-Murphy Corp.	39
KRAFTILE Company	1
KAWNEER Company	*
MALOTT & Peterson	44
MATTOCK, A. F.	48
McLAUGHLIN, John D.	46
MULLEN, Mfg. Co.	47
MUELLER Brass Co.	2
NORTHERN California Electrical Bureau	35
OWENS Corning Fiberglas Co.	*
PACIFIC Coast Gas Association	Inside Back Cover
PACIFIC Manufacturing Company ...	45
PACIFIC Portland Cement Company..*	
PACIFIC Telephone & Telegraph Co. ...	33
PARAMOUNT Built-in Fixture Co.	46
PARKER, STEFFINS & PEARCE	*
PAYNE Furnace & Supply Co., Inc. ...	5
PORTLAND Cement Association.....*	
REID, Allan Himes	43
REMILLARD-Dandini Co.	48
REPUBLIC Steel Corporation	45
SANTA Maria Inn	44
SCOTT Co.	*
SIMONDS Machinery Company.....	45
SISALKRAFT Company	39
SMITH, Emery & Co.	48
SMOOT-Holman Co.	37
STANLEY Works, Inc., The.	40
SOULE Steel Co.	*
TAYLOR Co., Halsey W.	34
TIMBER Engineering Co., Inc.	*
TORMEY Company, The	47
UTILITY Appliance Corp.	*
U. S. STEEL	*
VERMONT Marble Company	45
WESIX Electric Heater Co.	*
WESTERN Asbestos Company.....	Inside Front Cover
WOOD, E. K., Lumber Company	36

* Indicates Alternate Months

ABBOT A. HANKS, INC.

Engineers & Chemists

INSPECTING — TESTING — CONSULTING
CONCRETE • STEEL • MATERIALS
CHEMICAL AND TESTING
LABORATORIES

• RESEARCH AND INVESTIGATION •

TESTS OF STRUCTURAL MATERIALS
DESIGN OF CONCRETE MIXES
SHOP AND ERECTION INSPECTION OF
STRUCTURES AND EQUIPMENT
INVESTIGATION OF STRUCTURES
AND MATERIALS
TESTS AND INVESTIGATION OF
FOUNDATION SOILS
FIRE RESISTANCE AND INSULATION
TESTS

624 Sacramento Street, San Francisco

Robert W. Hunt Company

ENGINEERS

Inspection • Tests • Consultation

Schools and Other Structures
Are Built as Designed

When Construction Materials are
Inspected at point of Manufacture
and during Erection by

ROBERT W. HUNT COMPANY

Cement, Concrete, Chemical, Metallurgical,
X-Ray and Physical Laboratories

Chicago • New York • Pittsburgh
Los Angeles • All Large Cities
San Francisco, 251 Kearny Street

REMILLARD-DANDINI Co.

Brick and
Masonry Products

★

633 BRYANT ST., SAN FRANCISCO

569 THIRD ST., OAKLAND

A L A D D I N Heating Corp.

Specializing in
QUALITY HEATING
EQUIPMENT

2222 San Pablo Avenue

OAKLAND

TWinoaks 1022

ARCHITECT AND ENGINEER



MAY

1946

Teamed up

TO OFFER MORE ON ANY INSULATION JOB!

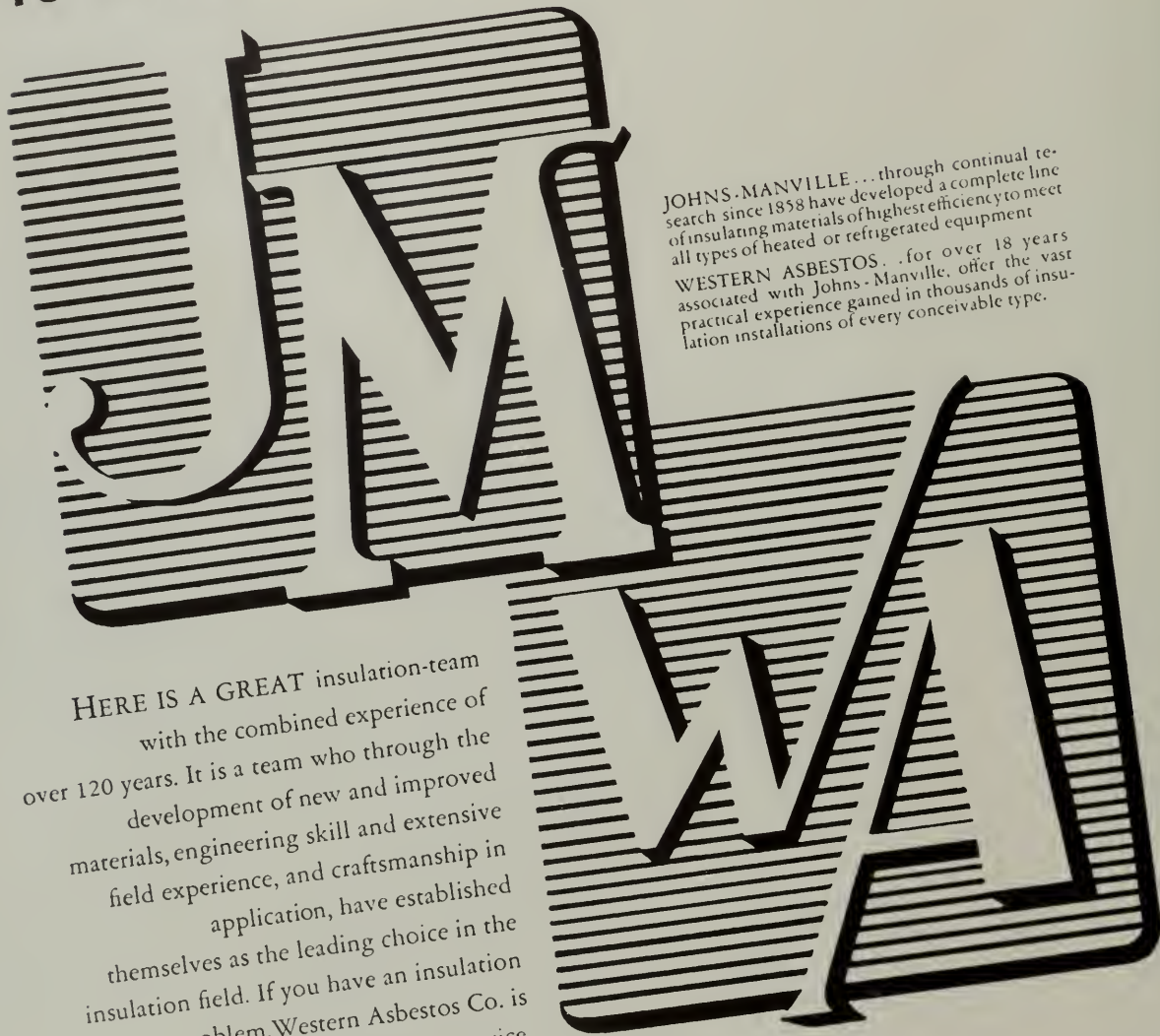

JOHNS-MANVILLE... through continual research since 1858 have developed a complete line of insulating materials of highest efficiency to meet all types of heated or refrigerated equipment

WESTERN ASBESTOS... for over 18 years associated with Johns-Manville, offer the vast practical experience gained in thousands of insulation installations of every conceivable type.

HERE IS A GREAT insulation-team with the combined experience of over 120 years. It is a team who through the development of new and improved materials, engineering skill and extensive field experience, and craftsmanship in application, have established themselves as the leading choice in the insulation field. If you have an insulation problem, Western Asbestos Co. is ready to offer you immediate service.

Contractors and Distributors for Johns-Manville Corporation

WESTERN ASBESTOS CO.

DISTRIBUTORS • ENGINEERS • CONTRACTORS

MAIN OFFICE: 675 TOWNSEND STREET, SAN FRANCISCO 3 • BRANCH OFFICES: OAKLAND AND SACRAMENTO

• ARCHITECT

Vol. 165 No. 2

AND ENGINEER

ARCHITECTS' REPORTS—Published Daily
Telephone DOuglas 8311

E. H. WILDER
Editor

MARK DANIELS, A.I.A.
Associate Editor

JOHN S. BOLLES, A.I.A.
Book Reviews

MICHAEL GOODMAN
Post-War Planning

L. H. NISHKIAN
Consulting Editor

E. N. KIERULFF*
Ass'l Editor
*In the Service

Contents for

MAY

COVER: "RAISING THE CALIFORNIA BEAR FLAG" . . . See Story on Page 7

ARTICLES AND MISCELLANEOUS TEXT

EDITORIAL NOTES	4
NEWS AND COMMENT ON ART	6
INDUSTRIAL BUILDING CONSTRUCTION METHODS	9
By J. P. H. PERRY, Vice President, Turner Company	
WAR MEMORIAL, Columbus Memorial Lighthouse Project	13
EXPANSION PROJECT FOR SHELL DEVELOPMENT COMPANY	14
By ULYSSES FLOYD RIBLE, A.I.A. Allison & Rible, Architects	
LANDSCAPE ARCHITECTURE, a Summary Description	18
By JOHN WILLIAM GREGG, Fellow A.S.L.A.	
CODE FOR RATING RESIDENTIAL AND COMMERCIAL STEEL BOILERS	23
DECENTRALIZATION, Plan of New Furniture Store	24
THE GARDEN AND THE HOUSE, a Cooperative Housing Project	26
By HILDEGARD BOENINGER	
A.I.A. ACTIVITIES	31
WITH THE ENGINEERS	32
HEADLINE NEWS & VIEWS	36
By E. H. W.	
IN THE NEWS	28, 29, 37, 39, 40, 43, 46, 47
PRODUCERS' COUNCIL PAGE	38
Edited by C. W. KRAFT	
ESTIMATOR'S GUIDE	41
CLASSIFIED ADVERTISING, Wage Scales	43
BOOK REVIEWS, Booklets, etc.	45
INDEX TO ADVERTISERS	48

ARCHITECT AND ENGINEER (Established 1905) is published on the 15th of the month by The Architect and Engineer, Inc., 68 Post St., San Francisco 4; Telephone EXbrook 7182. President, K. P. Kierulff; Vice-President and Manager, L. B. Penhorwood; Treasurer, E. N. Kierulff.

Los Angeles Office: Wentworth F. Green, 1709 West Eighth Street.

Entered as second class matter, November 2, 1905, at the Post Office in San Francisco, California, under the Act of March 3, 1879. Subscriptions United States and Pan America, \$3.00 a year; \$5.00 two years; foreign countries \$5.00 a year; single copy 50c. ARCHITECTS' REPORTS are published daily from this office, Vernon S. Yallop, Manager.



• EDITORIAL NOTES •

ANOTHER THEORY

The drastic restraint placed on much needed postwar building to permit a veteran priority construction, will neither solve the veteran's problem, nor allow a building-industry economy which will justify the recent Federal government action.

There is no logic in reducing industrial production and construction industry activity to the point where unemployment of available labor results, in order that the Veteran may build a house. How is he going to build, when he has no job?

Until such time as the manufacturer is able to produce products and sell them at a price the consumer can afford to pay, on a basis of ample profit to the manufacturer and an economic value to the consumer, there will be no sound operation of the building and construction industry.

California's director of motor vehicles is advocating the issuance of two license plates annually . . . well, automobile and truck owners are entitled to something for their high license fees.

PEOPLE ARE INTERESTED

It is our observation that nearly everyone is interested in "building".

Some desire to build a new home which will embody all of the conveniences and pleasures of a "Dream Castle", while others have a longing to erect an industrial or commercial plant that establishes a new high in personal and community pride.

Because of this apparent inherent desire to translate wishful-planning into actual building people are interested in what someone else may be constructing.

ARCHITECT & ENGINEER is anxious to publish articles and illustrations of the building-construction developments throughout the Pacific Coast states. If you are an Architect, Engineer, or Contractor and have an "interesting" project we will be interested in publishing it.

The OPA and Department of Justice announced recently the inauguration of an extensive enforcement program against the lumber black market . . . practically every item under OPA jurisdiction is engulfed in "Black Market" operations, there are probably "black markets" within the "black market".

INCOMPETENTS IN GOVERNMENT

This is a so-called "political year".

A year in which elections are held throughout the Nation to elect representatives for local, state, and federal government offices.

It is your obligation as an American citizen to vote. It is your responsibility to go to the polls on Election Day and indicate by your ballot whether you desire to retain, or replace, your present representative in government.

If in your opinion, your present representative has failed in his duty as a servant of the people, this is YOUR OPPORTUNITY to do something about it, while on the other hand if you are satisfied with present government, get your neighbor and his neighbor and make sure there is no change.

We have just fought the most costly war in history . . . costly in lives, suffering, and money . . . in order that YOU may Vote as a FREE AMERICAN.

If you are one of those unfortunates who have tried to obtain surplus Army or Navy goods, your understanding of INCOMPETENTS IN GOVERNMENT is first hand.

WHY BUY BONDS NOW?

Determination of the U. S. Treasury Department to continue the sale of Series E, F and G Savings Bonds is a sensible move as purchase of these bonds by the public will serve the country well from many economic standpoints.

Such a program combats inflation by investing in bonds rather than bidding up prices for scarce goods with surplus cash.

By keeping the savings bond investment total at its present \$48,700,000,000 peak it will hold a reserve of spending power for new homes, equipment, and a better living for all thrifty Americans.

Buying bonds teaches thrift.

Combatting inflation is certainly one of our most important duties and one of the best attacks is to refuse to buy in the "black market," regardless of whether prices are within easy financial grasp.

Another aspect to the continued bond buying is the fact that the more people who hold government securities the greater and more widespread will be the public interest in the functioning of that government.

Public apathy in good government is just asking for trouble.



Modular-Sized **KRAFTILE PRODUCTS** "ADD UP" TO *Lower* **CONSTRUCTION COSTS**

KRAFTILE Glazed Wall Units are now available in modular-coordinated sizes. This means that they may be combined with other modular-coordinated products* with a minimum of cutting and fitting. It means, too, a minimum of "brick counting" and tedious detailing in designs for masonry construction, for the nominal sizes (net size plus a standard mortar joint) of all Kraftile Wall Units are coordinated to the standard 4" module.

An early example of the advantages of coordinated masonry sizes is the Owens-Illinois Pacific Coast Company building pictured above. Present 6" x 12" nominal Kraftile wall units combine perfectly with standard modular glass block without special sizes or cutting... a feature that can reduce wasted time and material as much as 50%.

**Modular-sized glass block, structural clay products, steel and wood sash, concrete block and many other materials are now offered by manufacturers.*

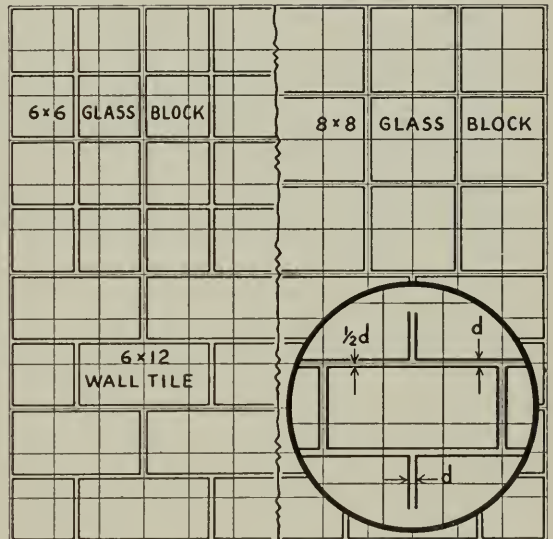

THE MORTAR JOINT is automatically provided for with modular-coordinated units. Net size plus standard mortar joint (d) equals nominal size, thus the architect need work only with nominal dimensions.

"KRAFTILE CAN ANSWER YOUR SPECIAL CONSTRUCTION PROBLEMS"

KRAFTILE COMPANY · NILES · CALIFORNIA

NEWS AND COMMENT ON ART



Title: "SCOOTERS"

Crayon by EDGAR TAYLOR, Artist
of Berkeley, California

Exhibited at the 10th Annual
Drawing and Print display of
San Francisco Museum of Art.

CALIFORNIA PALACE OF THE LEGION OF HONOR—Exhibitions

MODERN RUBBINGS FROM ANCIENT
CHINESE TILES to May 31.

One of the most important forms of art in the Han Dynasty (206 B. C.-220 A. D.) are the stone carvings found in caves, temples and on tombs in the Province of Shantung in China. They illustrate the mythical and recorded deeds of ancient Chinese history and are the earliest representations of human life in Chinese art.

Rubbings from these carvings of figures of men, horses, chariots, and other subjects are in silhouette.

CITYSCAPES—Watercolors by NADINE PIZZO to May 31.

A native of San Francisco, Nadine Pizzo has exhibited in the Annuals of the San Francisco Art Association and the Oakland Art Gallery and was represented at the Golden Gate International Exposition in 1939. She works in both oil and watercolor and is interested in theatrical design, landscape and figure painting.

OBJECTS AS SUBJECTS—Circulated by the Museum of Modern Art May 21 - June 11.

The fascination of executing a painting of "Still Life" is not limited to artists whose chief concern is the reproduction on the painted surface of the texture of fruit or flower. Most artists have at one time found it rewarding to control the problems of painting with such subjects. It is interesting to

compare the art of a variety of painters by means of similar subject matter and this exhibition of fifteen important paintings from the Museum of Modern Art Collection offers a fine introduction to a group of outstanding 20th Century artists. Among those who will be represented are Bonnard, Braque, Gris, Matisse, Miro, Picasso, and the other Americans, Demuth, Dickinson, Knaths, Kuhn, and Weber.

The Alma de Brettville Spreckels Collection of Sculpture by Auguste Rodin.

The Mildred Anna Williams Collection of Paintings, Sculpture, Tapestries and Furniture.

The Collis Potter Huntington Memorial Collection of 18th Century French Painting, Sculpture, Tapestries, Furniture and Porcelain.

SPECIAL PROGRAMS

Organ Recital each Saturday and Sunday at 3 p. m. by Uda Waldrop.

FREE MOTION PICTURES—Each Saturday at 2:30 p. m.

"THE GENERAL", Buster Keaton, 1927 (Silent) May 18.

"GRANDMA'S BOY", Harold Lloyd, 1922 and "SHERLOCK, JR.", Buster Keaton, 1924; May 25.

EDUCATIONAL ACTIVITIES

Childrens Classes in Painting and Drawing (ages 6-8, 9-12) each Saturday from 10:30 to 11:45 a. m.

Adult Classes each Saturday from 2 to 4 p. m.

COVER ILLUSTRATION

SAN FRANCISCO MUSEUM OF ART

The Sixth Annual exhibit of the Serigraph Society will be shown through May 26; GALLERY TOURS will be conducted by members of the Staff on current exhibitions each Sunday at 3:30 p. m.

HIGHLY HONORED

Grace L. McCann Morley, Director of the San Francisco Museum of Art, has been appointed by President Truman to serve as a member of an Advisory Committee for a National Museum.

Dr. Morley is a widely recognized authority on museum organization and administration.

CALIFORNIA SCHOOL OF FINE ARTS

A faculty of twenty-one, including two noted New York artists, heads the Summer program to be offered from June 24 to August 2.

The special six-weeks session will offer subjects unusually wide in scope and is designed to meet the interest of beginners, advanced students, teachers, and practicing artists.

Courses in painting, sculpture, graphic art, design, color, illustrating, ceramics, and jewelry will be taught by the school's regular faculty.

William Baziotas and Evsa Model of New York will serve as guest instructors during the six weeks period.

STUDENT EXHIBITION AT ART SCHOOL

The first in a series of student sponsored exhibitions was held at the California School of Fine Arts recently.

Work in the Associated Arts Workshop relating to architecture, painting, sculpture, mosaic, and ceramics were shown.

Projects shown included the Chemurgic Corporation model building; the I. J. Quillen residence at Stanford University; and the outdoor swimming pool of the Yehudi Menuhin estate in Los Gatos.

DE YOUNG MUSEUM GOLDEN GATE PARK

Among activities scheduled for May are the following:

SPECIAL EXHIBITIONS

Masterworks from a Famous Paris Collection through May.

In the early morning hours of June 14, 1846, a stalwart group of pioneers, fearing numerous restrictions being placed upon Americans by the Mexican government, descended on the Mexican headquarters of Governor General Guadalupe Vallejo at Sonoma, wrested control of the community in a bloodless coup d'état and gallantly raised the Bear Flag to form the new California Republic.

A few days later U. S. Army representatives arrived in Sonoma from Monterey and following peaceful negotiations the Stars and Stripes were raised and Sonoma became a part of the United States.

The California Bear Flag was subsequently adopted as the official emblem of the State of California.

One June 14, 15, 16, 1946, colorful ceremonies will mark the 100th anniversary of the founding of the California Republic. Stirring pageantry, romance of the Bear Flag Republic, rodeo, air circus and other events inaugurate a series of outstanding historical episodes which will extend from Sonoma throughout the Pacific Coast and will continue from now until 1950.

One hundred years of Pacific Coast progress on parade.

The well-known artist Al Sontag has depicted the historic Bear Flag scene in his mural which has been reproduced on the cover of this issue of Architect and Engineer.

Paintings from the Collection of Mrs. David Armstrong-Taylor through early May.

San Quentin—Activities and Industries of One of the World's Great Penitentiaries through May.

Paintings by Max Schoop, opening May 1

Watercolors by John M. Saccaro, opening May 1.

Watercolors and Drawings by First Sergeant Harry D. Reeks, U.S.M.C., opening May 1.

Paintings by Ralston Crawford, opening May 4.

Oil in Watercolor, sponsored by the American Federation of Arts, opening May 5.

Greek Textiles from the Henrietta Brewer Collection, through May .

Domes and Spires, Photographs and Drawings lent by Mr. Reddick Bickel through May.

Watercolor Sketches of California Wild Flowers, opening May 8.



Impressive room in the home of Howard G. Robinson, decorations were by Frances Elkins of Monterey and the fabrics by Dorothy Wright Liebes, textile designer of San Francisco.

Industrial Building Construction Methods

By **J. P. H. PERRY, Vice President**
Turner Construction Company*

Thirty-nine years ago this month I was privileged to enter the employ of the Turner Construction Company in the fourth year of its existence. That year it did \$867,000 of business. In 1944, it did \$117,000,000 of business. In its 43 years of existence it has done over three-quarters of a billion dollars' business—involving the construction of more than 2,000 buildings (principally for industrial usage) and the participation in the building of ships, mining coal, managing a city for the Army, operating shipping bases for the Navy and directing the procurement of most of the supplies for the Seabees Battalions of the U. S. Navy.

This sizable background of experience may lend some substance to the following observations as to industrial building construction practice and methods in America.

The problem of erecting industrial buildings is susceptible of solution or analysis from several different viewpoints. There are divergent schools of thought as to which is the better approach.

Broadly, there are two basic questions to be resolved:

1. How best to handle the planning and design.
2. What is the best way to execute the work in the field.

Each of these fundamentals sub-divide themselves again as will be noted hereinafter.

At the beginning of the 20th century an industrial executive having determined that his company needed a new factory or warehouse gener-

ally followed building practices which had prevailed for generations in commercial and institutional building lines. An architect or engineer was engaged to prepare plans and specifications, bids were taken competitively from a number of contractors, the low bidder usually secured the contract and then went to work to do the job.

About the time of World War I a contractor in the Middle West began advertising what has become known in the trade as the "Package Service." This contractor claimed great merit in the combining of design with execution. He has been successful the past 30 years and has done many millions of dollars of fine work under contracts which required him to be father, mother and wet nurse—all in one person.

Developing with World War II and in recognition of some of the merits of this "Package" method of construction, another practice developed successfully—that in which the building contractor was given the primary responsibility for getting the job done. The owner puts up to this contractor the responsibility for selecting the most appropriate architect or engineer (or both) to work with the owner in designing the building to be erected. The designer in this setup may be paid either by the contractor or by the owner. The merit of this approach compared to the "Package" method is believed by some to lie chiefly in the fact that it seems logical that no one contracting company can have in their employ or "on their shelves" the very top expert in all types of building design or the best specialists in production line layouts or in respect to important building details.

This "Cooperative Contractor" method, if it can be called that, permits the owner, on the advice of his selected contractor, to pick the ideal engineer

* This article was presented for discussion before the industrial buildings panel of the American-Soviet Building Conference, recently held in Engineering Societies Building, New York City, under auspices of the Architect's Committee, National Council of American-Soviet Friendship, Inc.

INDUSTRIAL BUILDING CONSTRUCTION METHODS—Cont'd

rather than to take one who is at the moment available.

It has been our Company's privilege to do many millions of dollars of work under this so-called "Cooperative Contractor" method.

One difficulty of the "Package Service" method has been that it results in the contractor, who sells it, antagonizing architects and engineers, men who in this country largely control building construction work. Furthermore, the "Package Service" method has the weakness that it requires the owner to "put all his eggs in one basket." Many corporations and industrial executives, and particularly Government agencies, hesitate to have no outside auditing or checking. They object to "Smith checking Smith."

Today in this country, therefore, there are three accepted methods, all of merit for initially handling industrial construction.

1. The traditional one where architects or engineers prepare plans and specifications and contractor is later selected to carry out these plans.

2. The "Package Service."

3. The variation of "Package Service" in this paper called the "Cooperative Contractor" method.

The Federal Government in World War II, in carrying out its approximately \$25,000,000,000 of building construction programs, developed two new forms of contract. Normally, the Government does its work by lump sum competition, or in emergencies on a cost plus basis. The two new methods are the "A-E-M" contract (Architect-Engineer-Management), which in its essentials took a leaf out of the package service school of thought by combining individual engineers, architects and construction managers into an entity to handle a given job. The other form of contract is the "Engineer-Constructor" form which more nearly follows the "Cooperative Contractor" method in that a contractor and an engineer are brought together to do a job with the contractor usually in the dominant position.

Another problem to be solved in creating an industrial building is the type of contracts to be used. On private work in this country the form of contract predominantly used is the lump competitive contract. In the past 30 years, however, there has been a very wide acceptance of the "cost plus" method of doing work.

Many owners like to compromise between these two methods. There has resulted the "cost plus guaranteed total" form of contract. Under this contract the contractor agrees that if the actual cost of the work is less than the guaranteed total the difference or saving will revert to the owner. Frequently an owner, being psychologically wise,

gives the contractor a share in these savings as an added incentive to perform the work economically.

When the plans and specifications have progressed sufficiently to warrant starting construction work at the site there are available several solutions to the basic problem of "how to do it."

The predominant practice in this country is to entrust the work to a general contractor and hold him, either directly or through the architect, responsible for the execution of the entire project. There are, however, those who believe that they get better results by doing the work by "separate contracts." Under this method there is no general contractor, at least in name (though actually the owner or the architect attempt to exercise its functions), but the owner through its own construction or engineering departments, if it has such, or through its architect, breaks the work up into sometimes 50 or 60 separate contracts. These contractors would normally be subcontractors to the general contractor. Most of the "Garment Center" on the west side of Manhattan Island was built by this method. It gives the owner a chance to do some sharp buying. It requires very capable management to coordinate all these varying contracting concerns to be sure that there are no gaps or loop holes. Few industrial concerns are willing to organize to give this management and supervision. They prefer to "stick to their last" and devote their executive management energies to manufacturing their own product or doing their own business. They are willing to let an experienced, able general contractor earn a reasonable profit by rendering this broad service.

Certain states, such as New York and New Jersey, for example, by statute require that on public work the mechanical trades—plumbing, heating, lighting, elevators and sometimes also structural steel—be let by competitive bidding entirely independent of the general contract. It is doubtful whether this has worked in the interest of the state.

As to construction methods in the field—I suspect that American practice varies from European practice largely because here labor is expensive and materials relatively cheap, whereas the reverse is true on the European Continent. Many times I have had submitted to me methods of construction, or for that matter of design of industrial buildings which enjoyed substantial vogue in European countries and came to me with good backing. An analysis of their adaptability to American practice usually showed them ill suited or uneconomical. The rock on which these ventures usually cracked up was on our labor costs.

The construction methods used in industrial

building construction in the field are largely built around an effort to save labor or to get greater production from labor, which is another way of saying the same thing. We increasingly tend to mechanize our jobs to a greater extent than in the past. On the other hand it has been our experience that many building contractors have overplanted or over-mechanized their building jobs. The amount of construction equipment involved in the erection of the average industrial building is insignificant compared to the cost of such equipment on "heavy work," that is bridges, dams, tunnels, highways, sewers, river and harbor work.

As to such equipment as is used here today it is probably fair to say that the trend has been towards larger and heavier individual pieces. We hoist concrete in buckets with a caterpillar crane up to the 13th floor instead of running it up in a bucket elevator. The flexibility of the caterpillar treaded steam shovels, cranes, whirlies, etc., has made these devices tools of everyday usage.

In recent years the use of centrally mixed concrete, distributed in large transit-mix motor trucks has become very general in urban and suburban areas throughout this country. This use of centrally mixed concrete has come about largely because of two factors: it is more economical and in general it is more uniform than concrete mixed in individually installed mixing plants—especially on small jobs.

A goal which may be reached in the future if the cooperation of organized labor can be secured would be an increase in shop fabrication or shop sub-assembly of building materials and units. A great many stone cutting operations and much of the bending of reinforcing steel could be done at central points similar to a central concrete mixing plant. It is believed that kitchen units and bathroom units can be assembled as entities placed upon a truck and installed in place with a crane with great economy in time and cost.

A trend is in sight toward doing away with plaster as much as possible. Fine concrete surfaces that can be painted, wallboards and other synthetic boards and surfaces are winning their way to obviate the necessity of bringing tons of water into a building just when its occupancy otherwise would be in sight.

The use of metal forms for concrete work is making progress in competition with wooden forms. There should be a further development along this line.

The use of powered hand tools such as saws, grinders, tampers, vibrators is constantly on the increase.

Industrial buildings are tending to become more intricate and complicated, as witness the increasing use of air conditioning, ventilation, complicated

lighting and more flexible power distribution systems together with soundproofing, greater sociological features, such as cafeterias and attendant kitchens, locker rooms, wash rooms, first aid and hospitalization facilities, recreation lounges, athletic facilities and playgrounds in larger plants. These features have increased the trend towards specialization of the industry. This is responsible for the increasingly wide break-down of a building job into tens or scores of sub-contractors.

The successful handling of large industrial building operations by the bigger and better known general contractors is due, in my judgment, in our case at least, to an insistence upon adequately staffing the job supervisory force. Our philosophy has been that the superintendent in the field should have primarily but one responsibility, that is to get production out of his men. He should be burdened with a minimum of paper work. His problems of interpreting plans, purchas-

MUNICIPAL BUILDING

FRESNO, CALIFORNIA



Modern entrance to one of Fresno's attractive municipal buildings.

INDUSTRIAL BUILDING CONSTRUCTION METHODS—Cont'd

ing, expediting materials, store-keeping, accounting, should all be controlled for him by a strong headquarters staff. Our company has been a firm believer in the Army idea of "a strong line and a strong staff." Headquarters control of accounting, purchasing, expediting, requisitioning has helped us get good costs and expeditious handling of the work.

The temptation of some of the smaller contractors to skimp on their job supervisory force is readily understandable but if succumbed to is usually fatal in its results over the years. We are firm believers in replacements—in having an experienced, adequately trained number two man immediately available to step into number one man's place.

Another vital element in the successful management of some of the large American building construction organizations has been their general policy of "carrying organization." Many companies, of course, still operate essentially on the "hire and fire basis"—picking up men when a new contract comes in and if no work is available when that job is done laying them off or putting them on partial time. The better companies have found in the long run that it pays to keep men fully employed. In our company, for example, our 14 active officers average more than 30 years continuous service. Currently we have more than 40 superintendents who average 17 years and 2 months' service with us; something over 125 active foremen average 17 years' service. These field men are supported by inside staffs on purchasing, engineering, expediting and accounting who have similar or longer service records.

America has become famous for its production methods and straight line production at that. Normally in peacetime years our company has received on the average a contract a week—50 or more contracts a year, usually involving perhaps 70 or 75 buildings total. In our more than 40 years' experience our buildings have averaged about \$300,000 apiece in cost. To deliver such buildings at the rate of one or more a week has required careful scheduling and inside planning—all part of a tested production program.

Our considered observation is that the success of American construction has been the insistence that the job be "built on paper" before it was built in the field. Of course, many of us are great believers in this country in the "cost plus" method of carrying out work which means starting a job before the plans are complete. This has resulted in a healthy rivalry between the inside and outside forces (between the office and the field) but such a rivalry need not and generally does not prevent

the job being built on paper before the attempt is made to build it in the field.

During the nearly two score years that I have had a hand in the management of the Turner Construction Company I have seen the industrial building construction industry pass from the hands of the rule of thumb contractor and superintendent into the hands of companies managed by and staffed by technically trained university graduates. Our company, for example, currently has in its employ graduates of 90 technical schools and universities. In a large construction organization such as ours we believe in the college graduate but not exclusively in the technical school graduate. There are opportunities for the graduate of a liberal arts college as distinct from an institute of technology. The college man may have a better chance than the technical institute man if he concerns himself with purchasing, selling, accounting and leaves the technical graduate to handle detailed designing, plant management and the supervision of the construction work in the field.

A fundamental to the success of any construction operation is cost control. I think if I had to put one requirement that a contractor must have to be successful ahead of all others year in and year out I would put **cost control**—knowledge of costs and how to interpret them.

The time to use costs is when they are being made. Many contractors keep cost records in such shape they are available for use generally only at the end of the job and are primarily studied as a basis for bidding on or figuring the next job.

The theory of cost control from the inception of our company has been that while costs are useful as a basis for bidding the next job their greatest value is as a tool to control cost of work while it is in progress. We get out a "unit cost" every two or three weeks and an "indicated outcome" every six weeks on all our work.

The "unit cost" is just what its term implies—a series of costs made for a current period on anywhere from 30 to 100 or more items of work—bricklaying, making forms, placing forms, bending steel, removing forms, hoisting steel, laying finish, plastering, painting, etc., etc. These costs are related to the budget estimate which is set up at the inception of every job. If there is variation between estimated costs and actual costs the headquarters staff, through vice presidents or general superintendents, are in a position to apply corrective methods.

An "indicated outcome" is a projection of the unit costs on an empirical basis throughout the remainder of the life of the job. They are invaluable in controlling costs for all types of building

(Continued on Page 34)

WAR MEMORIAL

COLUMBUS MEMORIAL LIGHTHOUSE PROJECT

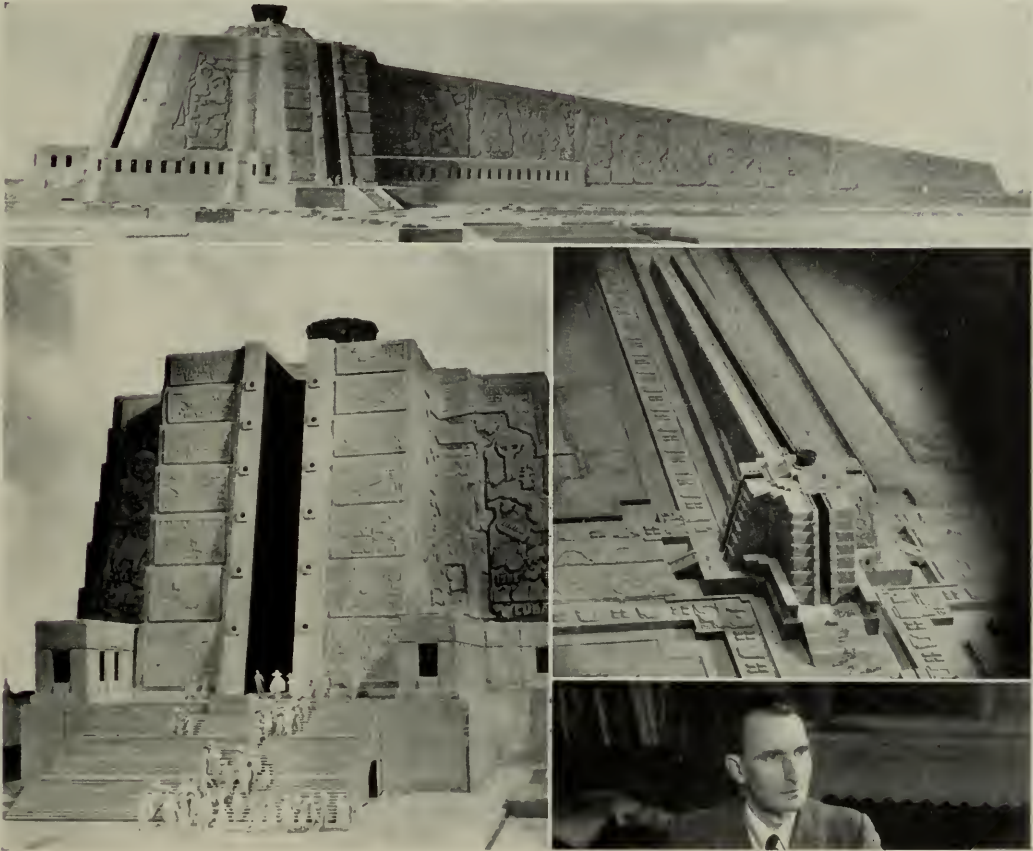

British I. S. Photo

Forty-foot model of the proposed Columbus Memorial Lighthouse to be erected on a 200-acre site near where Columbus first landed in the Dominican Republic. In yellow stone in the shape of a great recumbent cross, three-quarters of a mile long, the memorial will have carried on its walls in all the languages of the world the names of men and women who have led the progress of the New World; a chapel containing the remains of Columbus, and at night, its lights will throw a mighty cross into the sky and onto the clouds. Work is ready to start, the project having been approved by the U. N. O. Models have been shown at the Chicago Fair in 1933 and the New York World's Fair in 1939. Illustrated above are side, front, and top views together with its Architect Joseph Lea Gleave, whose design was selected from more than 455 entries in a worldwide competition held 15 years ago.



Architect's airplane view of Shell Development Company's \$3,500,000 research laboratory at Emeryville, California, which will take two years to complete

Expansion Project for Shell Development Company

By **ULYSSES FLOYD RIBLE, A.I.A.**

of Allison and Rible, Architects

Industry has realized an amazingly consistent growth and development during the past 150 years, but it was not until approximately twenty-five years ago that businessmen became convinced that industrial research was the important ingredient in industrial development. As a consequence, during these twenty-five years industrial research had to "catch up" with the big development that industry had realized during the preceding 125 years as well as to serve the gigantic industrial program of the past twenty-five years. The extreme importance of research to industry was acknowledged in the Preparedness Plea recently issued by General Marshall in which

a key line was, "Scientific research and development must be intensified."

The integration of the varied activities conducted within the confines of a research laboratory as they relate to steel and concrete is obviously one of the most exciting opportunities afforded an architect and one in which the architect may justify his claims to training in planning as broadcast over the years.

A review of research laboratories built within the past few years and those under construction or being planned for early construction, like research itself, reveals that there is nothing sure except the uncertainty of the problem. By this it

is meant that evidence indicates that the approach to the design of a research laboratory is influenced by local factors rather than by a system of broad principles. These local factors may be listed as the following three general influences (a) the type of exploration to be performed, (b) the general locale in which the exploration is located and, (c) the approach the individual designing office directs. Each of these factors affects the design of identical activities to such an extent that, given but slight preponderance to any one factor, the result may appear different in the extreme. Each factor may claim for itself that it has found the logical answer in the solution of each individual requirement. Specifically, a laboratory in which it is planned to conduct a relatively similar exploration may, as evidence indicates, be an "inside" air-conditioned space, or an "exterior" room, a square shape or a rectangular shape. It may vary in size from a two-man laboratory to a six or eight-man laboratory. The services may be brought to the laboratory from the corridor side, from the exterior wall, from the ceiling, or from the floor. And there is divergence in opinion as to the size and location of office space pertinent to the laboratory in which a similar exploration is being conducted. Likewise, broader aspects of function, management and financing vary to a similar degree.

The premise of uncertainty affords the greatest flexibility of thought and result which, as has been stated, in turn affords the designer a most interesting challenge. Now, couple this whole character of an industry with the problem of expanding an

already completely improved site housed within fixed borders and it is obvious that the challenge becomes one of interest in the extreme.

The site occupied by the Shell Development Company in Emeryville, California, occupies an area slightly in excess of seven acres. This site is totally occupied by various activities. The principal elements consist of a three-story laboratory building built in about 1928; a four-story and basement laboratory-administration building built in 1938; miscellaneous and engineering laboratories; a sizable area given to process development and pilot plan activities; a large motor laboratory, miscellaneous storage and engineering shops. Incidental areas are occupied by activities that might be carried on in any available space. A sizable area also provides for automobile parking.

The building program being currently considered contemplates about 100% expansion in working area for laboratories and administrative facilities. This expansion is based upon not only an increased personnel, but the provision of greater area per worker. The program contemplated also proposes additions to and the extension of pilot plants and appurtenant activities.

Therefore, the task of the architect in his approach to this problem was three-fold: first, there was a site completely occupied by existing buildings and structures, most of which it was economically sound to maintain in place. Second, the required provision of 250,000 square feet of additional area for research and administrative activities to be housed in either additions to present build-

All eight floors of this new building will house staff of scientists and research laboratories.

**Allison & Rible
Architects**





West laboratory building showing new office wing

ings or new buildings was of prime importance. Third, study of overall integration and organization of existing and proposed facilities, at the same time bearing in mind the economics of the entire program, was necessarily dominant.

Attack on the program was initiated by reviewing the activities of each of some thirty departments and ascertaining the fundamental relationships between them. The logical allocation of general areas thus determined dictated the development as currently proposed. The development of certain access roads throughout the site assisted in the definition of various types of activities.

By the reorganization of certain activities within the pilot plant area, increased space was made available for the required expansion of this facility. An addition to the existing combination laboratory-administration building is proposed to house solely the required increase in administrative functions. Therefore, the single activity housed reflects a lower construction cost per square foot than if this addition and housed both laboratories and offices. The principal expansion of laboratory facilities is housed in an eight-story laboratory building located in proximity to the existing north laboratory and existing laboratory-administration building.

At the far south-end of the site an existing sizable one-story building houses a motor laboratory, shipping and receiving department, pilot plant storage and miscellaneous engineering shops.

It is at this time proposed to leave this building entirely intact this area being reserved for future expansion of the pilot plant area and the activities now being housed therein. It is planned in the future to expand the usefulness of this area by constructing a multi-story structure.

The current program contemplates a four-story and basement building to house the heavy equipment to be located in proximity to the site reserved for further expansion of these general facilities as above indicated. Parking for automobiles has been provided outside the confines of the present site except for executives and guests. Gas-fired elements have been assembled in the central area of the site formerly occupied by the parking lot and are segregated from pilot plants and principal buildings by access roadways. Within the gas-fired area will be located a new furnaces building for use of the pilot plants, a power plant, and other miscellaneous gas-fired equipment.

It is obvious that not only the fundamental composition of the buildings on the site but the varied architecture of existing buildings with the peculiar

requirements of new structures imposed a considerably acute problem. The two large main buildings built ten years apart reflect all of that difference in the type of fenestration, wall treatment, and general character of architectural design.

The addition to the administration building has been delineated in a form which will present an inviting and dignified entrance to the administrative activities of the company. The new laboratory building known as the technical services building has been developed in plan as a relative square, the core of which houses the general toilet, stairway, and elevator facilities, as well as a central shaft for the housing of ventilation ducts and services. Immediately surrounding the core is a continuous corridor, the ceiling of which acts as a horizontal distributing space for certain ducts and services out of the central shaft. Laboratories are located around the perimeter of the plan. Certain hazardous laboratories confined to the south and east sides are provided with continuous exterior balconies. The balconies perform three specific functions: They act as additional exits from these hazardous areas; they permit the housing of temporary hazardous liquid or gas stores; by their physical projection they act as sun shades for the large windows provided in the laboratories.

Generally the typical laboratory is established as a four-man unit and is directly accessible from

the principal corridor. Adjacent to the entrance are the lockers for those who work in the laboratories. In this general area also is the automatic safety shower. It is proposed that the individual laboratory controls for the various services entering the laboratory will be within normal hand reach at the soffit just inside the entrance door. Contained within the general laboratory area and also directly available to the corridor is a small office to house the person assigned to it. Direct access to the laboratory from the office is also provided. The office is sufficiently flexible so that it may house one section leader or the desks of two chemists to whom such a quiet space should be assigned, or it can act as an auxiliary balance or instrument room available to the laboratory. The wall separating the office from the laboratory is formed of two identically sized cabinets. One is designed to house glassware and general storage accessible to the laboratory and the other to accommodate files, bookcases and wardrobe for the person or persons using the office space.

The laboratory proper is arranged with services on three walls as well as for an island bench. The function of furniture to be used will vary in each laboratory, but each unit is being designed on a three-foot module. This includes not only the several different types of cabinets, chests, tables and

(Continued on Page 44)

Smallest of the three new major buildings designed by Allison and Rible, architects, this windowless-wall South laboratory building will house heavy equipment and large scale laboratory facilities. The building is designed to minimize sun glare from nearby San Francisco Bay.



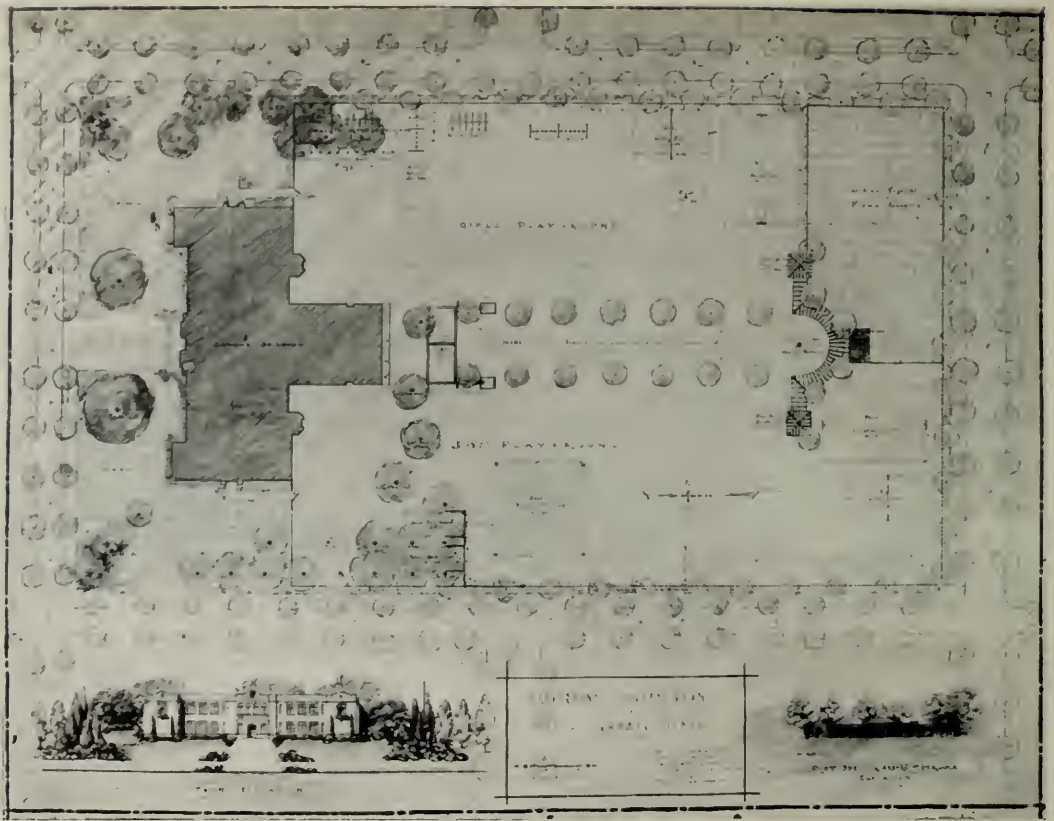

Playground and Garden Plan of Colusa, California Grammar School

Landscape Architecture

A SUMMARY DESCRIPTION
ITS AREA OF COMPETENCE AND
FIELDS OF SPECIALIZATION

By **JOHN WILLIAM GREGG, Fellow A.S.L.A.**
Member of the Board of Trustees,
American Society of Landscape Architects

The landscape architect plans and designs all types of land areas for human use and enjoyment. He adapts the physical conditions of a site to the practical requirements of its intended use and ap-

pearance, and develops plans suited to the character of the landscape. If a natural development is suggested, in a park for example, appropriate natural forms of earth, water, and vegetation will

be kept. When he develops a playground or other site for intensive human use, he subordinates the natural character of the landscape to practical requirements. He uses and modifies the topography, water forms, and natural vegetation in relation to the landscape and in combination with his creative ability; produces forms and designs peculiar to landscape architecture, especially in the modeling of ground forms, arrangement of land areas for diverse purposes, setting of buildings with regard for topography, and use of shrubs and trees as design material.

Occupational Summary

The landscape architect in every project considers the economical and efficient use of space together with attaining a satisfactory and pleasing appearance. He makes preliminary studies of the character of the area, determining the kind of development most suitable to the project. He sets forth the facts and his recommendations in a report, which with a general plan of the proposed landscape architectural treatment, is submitted to his principal or to other authorities for approval. He then prepares working drawings, specifications, detailed estimates of costs, and a schedule of the materials required. He draws up a contract, and, after it is let, supervises construction and authorizes payments.

Major Branches

The Landscape architect, whether working as a private practitioner or in some other capacity, is concerned—through the preparation of plans and reports—with the following types of work:

1. Development of Projects

In this specialty the landscape architect locates and designs public lands, parks, playgrounds and other smaller recreation areas, institutional properties, cemeteries, land subdivisions, housing projects, and private residential properties. He places buildings and other structures in relation to topography, provides for vehicular and pedestrian circulation, drainage and irrigation systems, and arranges trees and shrubs suitable to the project.

2. Land Use Problems and General Land Development Programs

NOTE:

Realizing that many people, both lay and professional, do not have a clear understanding of some professional titles, and the area of competence and specialization which these titles presume to define, a special committee of the American Society of Landscape Architects recently prepared a statement defining in general the terms Landscape Architect and Landscape Architecture. It is hoped that such a statement will help to clarify in the minds of the general public, and indeed of allied professions, the field of professional practice known as Landscape Architecture.

THE EDITOR

(a) Regional programs: The landscape architect performs reconnaissance investigations, develops programs, and drafts legislation in connection with allocation of land for economic, recreational, social or scientific purposes such as agriculture, industry, housing, erosion control, wildlife conservation, reforestation, parks, parkways, and park systems of national, state, regional, or municipal character.

(b) On a specified area: The landscape architect determines the various types of land use in which an area should be divided, the general location of special improvements or alterations, and recommends the extent and character of improvements relating to specific use of land for such public or private uses as recreation, reforestation, or wildlife restoration.

3. General and Broad-Scale Planning

The landscape architect selects the site for proposed development to conform to predetermined requirements; appraises present conditions; and makes recommendations for such facilities as transportation, recreation, social, and public service as well as for planning and zoning legislation. He cooperates with local planning authorities, and coordinates his broad plan with local physical development programs and social or economic activities.

Functions

The landscape architect may specialize in any of the following functional activities:

1. Landscape architectural practice either independently, or as an employee of another landscape architect, a government agency, or a private institution.
2. Teaching of landscape architecture in a college, university, or other institution.
3. Research in problems dealing with recreational opportunities and facilities, soil conservation and reforestation, or use of plants under varied conditions.
4. Editing and writing of books and articles.
5. Administration and management of government agencies carrying on landscape architectural work.

Professional Affiliations and Civil Service Ratings

Full membership in the national professional organization (American Society of Landscape Architects) is limited to individuals who have acceptable professional qualifications. Lack of such membership, however, should not be construed as indicative of non-professional status.

In those states which operate under a merit system, and in the Federal Civil Service, a professional job classification or a professional rating



An enclosed Menlo Park, California, residence court or patio designed by the Landscape Architect in the Spanish motif adapted to modern living.

John William Gregg, F.A.S.L.A.

on a civil service register is ordinarily indicative of the professional status of the landscape architect.

As yet no state regulates the practice of landscape architecture through the requirement of legal registration and licensing.

Educational Qualifications

1. Graduation from a recognized school of landscape architecture with a professional degree in landscape architecture.

2. One may also attain professional status with less formal schooling if one has considerable experience of progressive responsibility in office under a competent landscape architect.

Related Professional Fields and Alternate Titles

Landscape architects are closely related in training and experience to civil engineers, agricultural engineers, agronomists, soil specialists, horticul-

turalists, botanists, and to city or area planners. Because it is impossible to make a sharp distinction between landscape architecture and some of its name phases, such as land planning, recreation planning, etc., many planners and government officials in the field of conservation, recreation, and

land planning in general terms are trained landscape architects although working under titles which give no clue to their professional background. Some of these titles are Site Planner or Site Engineer, Park Planner or Park Engineer, Recreation Planner or Recreation Engineer.



An outdoor theater within a city park planned by the Landscape Architect to consider orientation, exposure, topography, pedestrian and vehicular circulation and landscape setting.

Reinhold Von Wetter, Landscape Architect

Sources of Employment

Until recent times most landscape architects have practiced their profession in private offices, as principal or assistant, or on a salary basis for the development of a single privately-owned or institution-held property. Of late, increasing numbers have been employed on a salary basis by many agencies of local and Federal government.

Related Non-Professional Occupations

There are a number of sub-professional occupations related to and often confused with profes-

sional landscape architecture. The preponderance of individuals engaged in these fields do not possess a bachelor's degree in landscape architecture since such training is unnecessary for these occupations. The work performed is usually of a limited and repetitive nature, with training derived for the most part through practical experience. The chief occupations in this category are: gardening and landscape gardening, practical horticulture not concerned with fruit production or research, landscape contracting, tree surgery, nurseryman-contracting.

Steps and walls can be so designed as to be both comfortable for use and pleasantly beautiful. Thos. D. Church, Landscape Architect



Code For Rating Residential and Commercial Steel Boilers

A Code for rating and testing oil-fired residential steel boilers and for rating commercial boilers has been issued by STEEL BOILER INSTITUTE, Inc.

This Code will replace the steel boiler Code originally adopted in 1929, and though test results are better than the prescribed minimum requirements, net ratings in square feet of steam are limited to seventeen times the square feet of heating surface in a mechanically fired residential boiler. A. S. M. E. Boiler Code construction is required.

Residential steel boilers are defined by the Code as those containing not more than 177 square feet of heating surface and having catalog steam SBI net ratings not greater than 3,000 square feet when mechanically fired. Ratings shall be expressed in square feet of steam or water radiation and in Btu per hour. Boiler horsepower may be shown if desired. Steam ratings are considered as emitting 240 Btu per square foot per hour, and hot water ratings are based on 150 Btu per square foot per hour. One boiler horsepower is considered equivalent to 140 square feet of steam radiation.

SBI net ratings for residential steel boilers include the load imposed by the connected radiation required to heat the building, and heat loss from piping up to 20% of the installed radiation. Piping losses in excess of 20% of the installed radiation must be considered as additional net load. The estimated maximum heat required by water heaters or other apparatus connected to the boiler must be considered as additional net load and extra boiler capacity must be provided for it.

Provisions for rating oil-fired residential steel boilers under the new Code prescribe:

Heating Surface: The SBI net rating expressed in square feet of steam radiation shall be not greater than 17 times the heating surface of the boiler.

Carbon Dioxide in Flue Gases: The burner shall be set to produce 10% carbon dioxide (plus or minus 0.2%) in the flue gases.

Flue Gas Temperature: The flue gas temperature shall not exceed 600° F. when the boiler is operating at 150% of the SBI net rating.

Overall Efficiency: The overall efficiency of the boiler and burner shall be not less than 70% when operating at 150% of the SBI net rating.

Draft Loss Through Boiler: The difference between the draft at the breeching and the draft in the firebox when the boiler is operating at 150%

of the SBI net rating shall be not greater than that determined by the formula: Draft Loss (in hundredths of an inch of water) equals Net Rating over 200, plus 4. This draft loss limitation shall not apply to integral boiler-burner units regularly cataloged and marketed complete with boiler, burner and refractory designed to operate with higher draft losses and where means is provided to develop sufficient draft to overcome the high draft loss.

Furnace Volume: The furnace volume shall be not less than one cubic foot for every 110 square feet of steam SBI net rating. This limitation shall not apply to integral boiler-burner units.

Every boiler is to carry a plate that shows the manufacturer's name and address, the boiler number and type, the SBI symbol, the amount of heating surface, the SBI net rating in Btu for each type of firing recommended, and whether or not baffles or turbulators are used. Non-members of SBI, upon approved application, may receive permission to test and rate boilers according to the Code.

A Section of the new Code sets up the test procedure for residential steel boilers and the calculations for oil-fired test items. Manufacturers are to submit their test data, and the Steel Boiler Institute will review these data and approve Net Ratings to be used for the equipment if test results are satisfactory.

No test procedure is provided or required for commercial steel boilers. Commercial boilers designed to be fired mechanically are rated in square feet of steam radiation equal to 17 times the heating surface of the boiler in square feet. The SBI ratings in square feet of steam for boilers designed for hand-fired solid fuel are equal to 14 times the heating surface. A rating table in the Code shows for commercial steel boilers the SBI Rating, the SBI Net Rating, heating surface in square feet, minimum furnace volume in cubic feet for mechanically-fired boilers that are fired with a bituminous stoker. Furnace heights for stoker-fired boilers have been determined in cooperation with the Stoker Manufacturers Association. Minimum grate areas are shown for hand-fired boilers. These physical specifications for commercial boilers determine the SBI rating.

This new steel boiler Code has been developed by the Engineering Committee of the Institute under the chairmanship of L. N. Hunter of National Radiator Company. Members of the Committee include C. E. Bronson of Kewanee Boiler Corporation; J. B. Kingsley of International Boiler Works Company; C. E. Olson of Fitzgibbons Boiler Company, Inc.; and J. W. Turner of Pacific Steel Boiler Division, U. S. Radiator Corporation. Copies of the Code are available through the Steel Boiler Institute, Inc., 366 Madison Avenue, New York City.

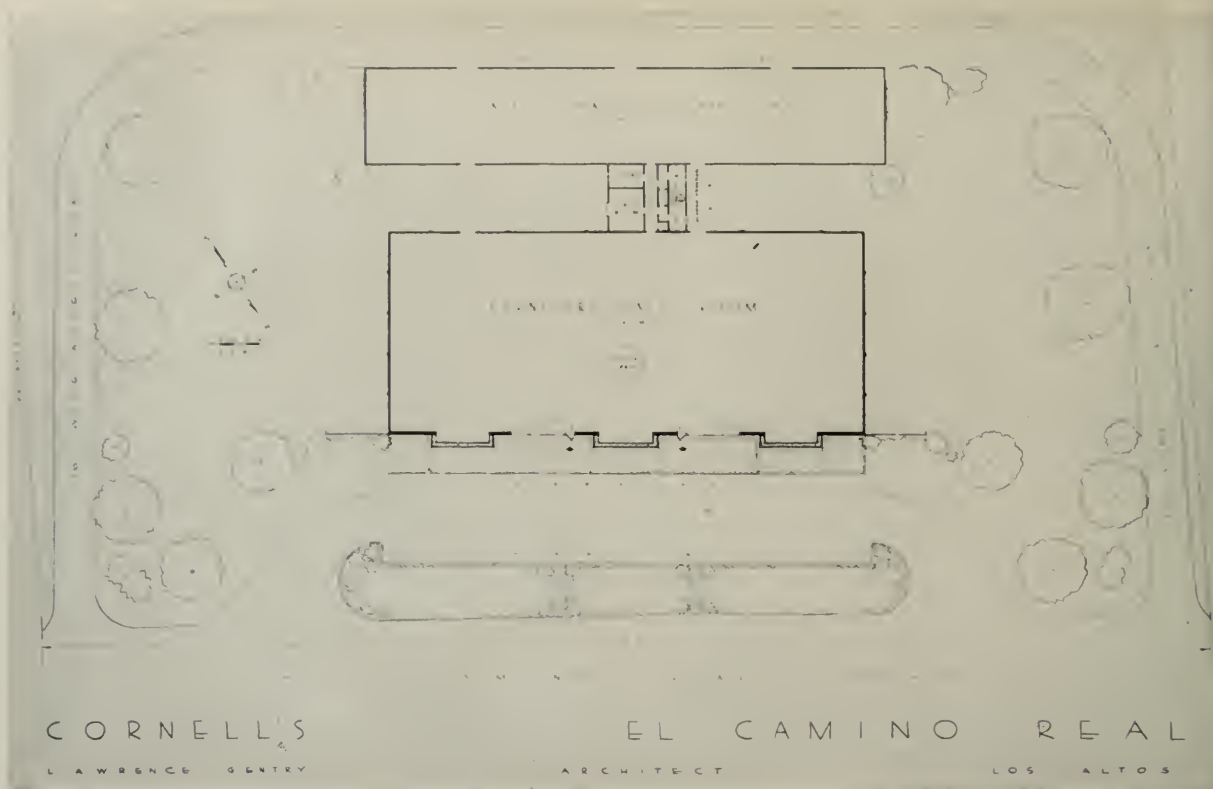

Lawrence Gentry, Architect

Decentralization

PLAN OF NEW FURNITURE STORE
BEING BUILT ON EL CAMINO REAL
SANTA CLARA COUNTY, CALIFORNIA

Among today's pioneers in the rapidly expanding trend towards decentralization of commercial enterprise in favor of the establishment of large and complete business institutions in favorable suburban communities, is the new furniture store being built for Julius J. Cornell on El Camino Real Highway between Palo Alto and San Jose, California.

The wide, one store building, 183-foot by 80-foot, was designed by Lawrence Gentry, Architect, of

Los Gatos, and is in the California ranch style with pleasant overhanging eaves, a heavy split shake roof, and vertical redwood boards above a brick wainscoat.

Five large windows will make the interior of the store visible from a 15-foot side walk which crosses the front of the building.

The building will have steel roof trusses spanning the full depth, thus giving an unobstructed floor area. Reinforced concrete construction will

comprise the exterior wall, while the floor is of wood but will be entirely carpeted.

An auxiliary steel warehouse 200x40 feet is located immediately back of the main building. This will house the upholstery, carpet and general service shops, and will be joined to the furniture display building by a smaller building in which accessory rooms will be located.

A complete air conditioning system has been provided by Clyde Bentley, ventilating and heating engineers of San Francisco, including the filtration of warm or cool air and a constant supply of fresh air.

The interior lighting of the building will incorporate the very newest developments in fluorescent installations, including a continuous line of cold cathodes for balance and comfortable lighting. Special designs and lighting effects have been provided for night illumination which will make the building one of the most outstanding night displays on the peninsula.

The property upon which the new building and auxiliary structures are being built has a 454-foot frontage on the El Camino Real Highway. Traffic confusion will be avoided by having a driveway and parking area in front of the store which will be separated from the highway by an island

of lawn and shrubbery. As the main building sets back 70 feet from the highway the entire area of store, sidewalk, driveway, and parking space, is to be landscaped in an appropriate setting for the particular California architecture of the store as designed by the architect Lawrence Gentry.

It is the desire of not only giving the furniture store an attractive setting, but also providing for the display of garden furniture and accessories in an appropriate manner.

Five outdoor display areas each of which is complete within itself with background of well selected plant materials has been developed by Allan H. Reid, Site Planner and Landscape Architect. Other areas will provide for barbecue fireplace with cupboards and incinerator, making ideal display surroundings for culinary equipment.

**AIR CONDITIONING
SYSTEM USED IN THE
J. J. CORNELL
FURNITURE BUILDING
WAS DESIGNED BY
CLYDE E. BENTLEY
CONSULTING ENGINEER**

216 Pine St., San Francisco

1441 Franklin St., Oakland

**A new design in
"decentralized"
merchandising is
geared to mild
California weather
and abundant
sunshine.**



THE GARDEN AND THE HOUSE A COOPERATIVE HOUSING PROJECT

By **HILDEGARD BOENINGER**

Few men, like Faust, have the desire to create a city, but all men would like to live in a well-planned community. To Dr. J. Murray Luck, a public-minded citizen of Stanford University, came this inspiration. A group of residents of Palo Alto, California, and vicinity readily followed his leadership in the belief that a community could be established on a cooperative basis. Stimulated to action by the acute housing shortage on the West Coast, the group was incorporated in April 1944 as the Peninsula Housing Association. Its members are interested "in developing cooperatively and at cost a good residential area for 400 middle income families."

The group is purchasing a site consisting of 250 acres of rolling foothill land a few miles from the Stanford campus. John Funk of San Francisco has been named consulting architect. Homes are to be designed in the contemporary manner and each family will have its choice of a number of floor plans, according to its needs.

Although there will be considerable conformity in outward appearance, individuality in the treatment of interiors will be maintained. The group is anxious to avoid the hodge-podge of building styles that now exists. No tall-columned Colonial house will appear next to a low rambling ranch house in this model community. Streets will not be laid out in the usual squares, but houses are to be situated on curves pleasing to the eye and safe for the children who can play in the cul-de-sacs without fear of being hit by speeding trucks. About 50 acres will be set aside for parks and playgrounds. There will be an elementary school and a number of cooperative stores. Most attractive are some of the special features the members plan to establish: gardening and domestic service, a community recreation center, guest houses, a restaurant, tennis courts and a swimming pool.

The present membership numbers about 60 and includes a variety of professions and occupations: accountants, professors, engineers, attorneys, carpenter, publisher, illustrator, novelist and photographer. Their common interest has been most conducive to good fellowship. Picnics have been held on the proposed site, so that members can become

thoroughly familiar with the ground on which they plan to build their homes. Experts have lectured on various phases of such a project so that the group has some knowledge of the problems which confront it. Building will begin as soon as materials are available and the membership is large enough to finance it.

Although offering many advantages which the individual home owner could not afford, the project promises to effect savings for its participants. This will be accomplished by the large-scale construction and the purchase of standardized units and equipment. As stated by one of the members in the group's semi-monthly publication: "By working with Peninsula Housing Association it may be possible to build for, say \$4500, a house that would cost \$6000 purchased through the regular channels. But how many families will do just that, and pocket the \$1500 savings. Very few, we think. Instead most of us will spend the whole \$6000, getting perhaps an \$8000 home for the money when spent in this cooperative way . . ."

Founded, not like Brook Farm or the Amana Colonies, on social Utopianism or religious principles, but rather on 20th century American cooperation, the project should prove an interesting experiment in group living.

STEEL—IN THE WAR

A well presented and highly illustrated record of the steel industry's war accomplishments has just been released by the United States Steel Corporation.

Compiled by Douglas A. Fisher of the office of assistant to the Chairman, with the assistance of officials and staff members of U. S. Steel Corporation subsidiaries, 164 page book is dedicated to the men and women "more than three hundred thousand in number, whose skill, diligence, loyalty, and toil enabled U. S. Steel to produce record breaking quantities of steel, ships and countless war products made of steel."

The book recognizes the work of employees in "U. S. Steel's mines, quarries, furnaces, mills, plants, shipyards, railroads, docks, warehouses, and offices."

"It is our earnest wish that those who read "Steel in the War" may take pride in the war contribution of the steel industry, and may draw therefrom a renewed faith in the destiny of this nation, as with the dawn of peace, it resumes its march of forward progress," states Irving S. Olds, Chairman of the Board in the Foreword of the book.

AMERICAN UNIVERSITY OF BEIRUT IN LEBANON TO COUNSTRUCT \$2,500,000 MEDICAL CENTER

Plans for the construction of a Medical Center at the American University of Beirut, Lebanon, at an estimated cost of \$2,500,000, were announced recently by Albert W. Staub, American Director of the Near East College Association, Inc. The University's Board of Trustees has approved this project. He said that the Medical Center will increase the bed capacity of the present hospital by more than 250 per cent, make possible the training of 25 per cent more medical students and treble the size of the Nursing School. Mr. Staub predicted that when the Center is in operation, American medicine will come into the foreground in the Near East. The building will take sixteen months to complete and work is expected to start this spring.

Architect for the Medical Center is W. Stuart Thompson, 125 East 46th Street, New York. Mr. Thompson, who has had an office in Athens, Greece, for 20 years, went to Lebanon in 1940 to study the needs of the University's Medical School and to investigate the possibility of using native materials.

"Because the zoning law in Beirut is even stricter than the law in New York City, the building will be set back above the fifth floor," Mr. Thompson said. "This regulation was utilized to provide sun decks on the three top floors. On the south side of the building there are three large solariums on each floor."

NAMED MANAGER OF KELLOGG

Norman H. Saunders has been named Engineering Manager in charge of all research, development, design and general engineering of the KELLOGG SWITCHBOARD & SUPPLY CO., Chicago.

Saunders is well known in the independent telephone industry through his many years of engineering work and numerous articles on various phases of dial switching equipment.

During World War II, he served as a colonel in the U. S. Army Signal Corps and saw service in French Morocco, Sicily, and on the Mediterranean Coast of France.

CECO STEEL MOVES

General offices of the CECO STEEL PRODUCTS Corp'n. have been moved from Omaha, Nebraska, to its manufacturing division headquarters in Chicago, Illinois.



New Design In Home and Farm Freezing Units

Production of a complete line of home and farm freezers, ranging from a specially designed Deluxe 5 cubic foot model to fit into modernized "new kitchens" to one of 25 cubic feet for large kitchens or utility rooms, has been announced by SCHAEFER INC., Minneapolis, Minn.

Recognizing the important role that frozen food will play in economy, convenience and shorter hours of kitchen work for American homemakers, Schaefer engineers have designed the "PAK-A-WAY" line in an all-steel construction with hermetic compressors.

The Deluxe 5, illustrated here, is intended to harmonize with modern "unit kitchens" and provides 5 cubic feet of storage space for frozen foods.

Acid resisting porcelain covers, the counter-balanced, self-raising lid and a convenient temperature control at the center, rear, permits the housewife to adjust the cabinet for quick freezing or storage.

Two spacious unrefrigerated drawers at the bottom of the unit adds to its general utility.

IN THE NEWS

SAFETY COLOR CODE

The value of a standard safety code has been demonstrated by the experience of the Army.

Certain types of accidents, resulting in disabling injuries, have been entirely eliminated, while others have been reduced from a frequency of 46.14 to a yearly average of 5.58. One quartermaster depot reported that during the first year after adoption of the code, for each 1,000,000 man-hours worked, disabling injuries were cut down from 13.25 to 6.99.

Red, green, yellow, white, and black, and combinations thereof, are the colors used in the standard code.

Red is the basic color for the identification of fire protection equipment, danger, and stop signals. Green designates safety, location of first aid equipment, first aid dispensaries, starting buttons, the "Go" for traffic, and all instances where safety is to be designated. Yellow is used to designate caution and for making physical hazards more visible. Where conditions call for a more striking symbol, black and yellow stripes or a checkerboard effect is used. Black, white, or a combination of the two are the two basic colors for designating housekeeping, sanitation and traffic markings.

By standardizing the code, its effectiveness is not lost where labor turn-overs are large and employees move from one plant to another.

ARMY ORDNANCE COOPERATION

In peace as in War the Army's Ordnance Department is depending on support of American industry, universities and research agencies. During the war the Ordnance Department spent more than 125 million dollars on basic research and long range development programs and enlisted the aid of outstanding laboratories of science and industry, as well as scores of universities and colleges. The program paid handsome dividends.

Many American industrial organizations have extensive research laboratories which during the war were used to investigate problems that, in some instances, were not even remotely connected with peace-time products.

New methods of manufacturing, substitutes for critical materials, advanced metallurgy and ballistic tables were a few of the problems successfully solved. While most of the work was done for military application, the discoveries have been widely adapted for peace time pursuits.

The Ordnance Department has contracted with a number of universities, industrial and independent research agencies to continue work on scientific problems of research and development, while other contracts will soon be negotiated.

THERMAL CONDUCTIVITY INSULATING MATERIALS

A new program to provide more accurate and dependable values of thermal conductivity for insulating materials on the market has been initiated by the Committee on Research of the American Society of Heating and Ventilating Engineers.

Commercial and university laboratories known to have hot plate equipment are being canvassed to determine whether their equipment conforms to ASTM C77-45 Standards, and whether they are willing to undertake tests to establish correlations and determine the relative accuracy of the various pieces of test equipment.

The laboratories having acceptable equipment and indicating a willingness to participate in the plan, will receive samples of insulating material to be tested.

As soon as possible a list of approved laboratories will be made available to manufacturers of insulating materials, and they will be urged to have their products checked at one of the laboratories listed.

NATIONAL LUMBER MANUFACTURERS ASSOCIATION DIRECTORS MEET

The Board of Directors and members of major committees of the National Lumber Manufacturers Association will meet in San Francisco on June 10-12 to consider the repercussions of government regulations on lumber manufacturing, the industry's long-term research and forestry programs and other major problems.

More than 100 lumbermen from all parts of the country are expected to attend the sessions.

WESTINGHOUSE

Charles A. Scarlott, editor of "Westinghouse Engineer" and head of the Editorial Service for Westinghouse Electric and Manufacturing Company, Pittsburg, Pa., was a recent visitor to the Pacific Coast.

Company activities in Arizona, California, Oregon, Washington and other western states were viewed by Scarlott.

As a result of the recent advances granted by the OPA, the finished steel composite price has risen to 2.69516 cents per pound, compared with 2.28297 cents per pound in August, 1939.—American Iron & Steel Institute.

IN THE NEWS

STATE BOARD ARCHITECTURAL EXAMINERS TO MEET

The State Board of Architectural Examiners will meet on May 10 and 11, 1946, at 906 State Building, Los Angeles. At this meeting, the final action toward granting certificates to practice architecture will be taken for those who passed the last examination. The written examinations in January were taken by 131 candidates for certificates, of which 59 or 45 per cent of the total passed their examinations. At this examination there were 69 persons who took the examination for the first time and of these, 20 passed in all subjects.

The rules of the Board require that the candidate pass all the examinations within a three-year period. Of those passing the written examination, 31 took the subsequent oral examination in San Francisco and 28 took the subsequent oral examination in Los Angeles. The successful candidates will be notified immediately after the meeting of the Board on May 10th and 11th.

Examinations are now given twice a year and the next examination will be June 24th to the 27th, inclusive, 1946. Examinations will be conducted simultaneously at the University of California at Berkeley and at the University of Southern California at Los Angeles.

SAN FRANCISCO LEADS IN HOUSING PERMITS

More housing construction permits have been authorized for San Francisco than any other city in the nation, it was disclosed recently by the San Francisco Chamber of Commerce on the basis of figures released by the Civilian Production Administration.

California, Oregon, and Washington received the largest number of authorizations for any one section in the country.

San Francisco is scheduled for 17,000 home constructions. The next highest allocations in the nation were Los Angeles and Detroit which got 16,488 and 15,209 home permits respectively.

Of the San Francisco homes authorized, 14,000 will be for sale and the remainder for rent. Sale prices range from \$4,499 or less to a maximum of \$10,000 including land and improvements. Rental prices run from \$39.99 or less to a maximum of \$80.00.

Ratings for the new construction were issued under priorities regulations which direct a certain portion of 17 critical building materials into the

construction of dwelling units for veterans.

Total authorizations for homes to be sold in California, Oregon, and Washington were 36,482.

CASA FIGUEROA

By L. S. SANDERSON

One hundred years ago, the Figueroa family built an adobe home on a country road three miles south of Los Angeles at what is now Figueroa and Jefferson Boulevards.

December 15th last, a fire broke out in it and destroyed a small portion of the roof, but, being built of adobe, it was otherwise unaffected as it has been through six wars this country has engaged in. It is therefore older than the Suez and Kiel Canals, the Atlantic Cable, the telephone and Bessemer Steel process.

Iowa had not been admitted as the 29th state and the national debt was a mere \$16,000,000 when the Figueroas of Los Angeles moved into their fine new home.

Casa Figueroa is not an Architectural shrine but rather an example of good sound building, still enjoying 100% occupancy at ceiling prices, which it will continue to do for many years to come.

On the basis of this performance and the probable all-time shortage of lumber, it will harm no Architect, Engineer, prospective builder or banker to "look-see." It is what the French call "a good set-up." It is certainly a very rational straightforward way to make a machine to line in, unhindered by tradition, ignorance or confusion.

Que viva Figueroa, viva ese siglo encantador, viva Los Angeles, viva California—ole.

CHROME PAINT

A ready mixed paint which approaches a natural silver chrome finish has been announced by the ALUMATONE CORPORATION of 1523 Grande Vista, Los Angeles 13, California.

The paint holds full brilliance and color and a patented stabilizer used in its manufacture gives package stability and prevents the paint from darkening in the can even after opening.

It has a wide variety of uses and is suitable for wood or metal, outdoors or in. A high gloss finish is obtained in 2 to 4 hours after application.

ARCHITECT MOVES

Johnson, Wallwork & Dukehart, architects, have moved into new quarters in the Dekum Building, 519 Southwest Third Avenue, Portland, Oregon.

The firm is comprised of Folger Johnson, A.I.A.; C. H. Wallwork, A.I.A., and John K. Dukehart, A.I.A.

BRITISH ARCHITECTURAL STUDENTS SEEK AMERICAN CONNECTION

The following communication has been received by ARCHITECT & ENGINEER and on the chance that someone may be interested in the problem of these British architectural students, their letter is being published.

London, England
1st April, 1946

ARCHITECT & ENGINEER

68 Post Street
San Francisco, Calif.

Gentlemen:

We are student members of the Royal Institute of British Architects and are in our fourth year at college.

By the Spring of 1947 we hope to have passed our Final Qualifying Examinations, after which we have to work for at least six months in an Architect's office before being accepted as candidates for election as Associate Members.

As we are very interested in American methods of design and construction, we wondered if it would be possible to work for this period in the U.S.A.

Professor Sir Charles Reilly, M.A., F.R.I.B.A., an Honorary Corresponding Member of the American Institute of Architects advised us to write to the A.I.A. for information and further advice.

Mr. Edward C. Kemper, the Executive Secretary of the A.I.A. contacted the State Department with reference to visas and has informed us that we must have evidence from an architect in the United States of a definite position in his office being available for us together with proposed length of employment in the office and the remuneration to be received. We are writing to you in the belief that you will be able to offer us some assistance in contacting architects who might be interested. We hope you will favor us with an early reply.

Yours faithfully

John Roake Bertha Poess Mary Haines
D. N. Wisdom.

Anyone interested in communicating with the four students may do so by addressing them care D. N. Wisdom, Esq., 48 Oakfield Road, Southgate, London.

NEW DESIGN IN STOVE BUILDING

The American Stove Company, St. Louis, Missouri, has incorporated many of the newest ideas of structural and aesthetic design in its new administration building.

The six-story building will be an outstanding example of contemporary design for large office-type structures and will centralize the principal offices and executive activities of the company.

Harris Armstrong, Kirkwood, Missouri, is the architect; Neal J. Campbell, designing engineer; and Ferris and Hamig, mechanical engineers.

DETROIT STEEL PRODUCTS

Wilfred C. Owen, identified with the company since 1914, has been named executive vice president of the Detroit Steel Products Company of Detroit, Michigan, according to a recent announcement by H. F. Wardwell, president.

Mr. Owen has served as assistant superintendent, shop superintendent, general factory manager, vice-president and director. He will continue to serve as Director.

The Detroit Steel Products Company has long been identified with the manufacture and distribution of steel windows, building panels and automobile springs.

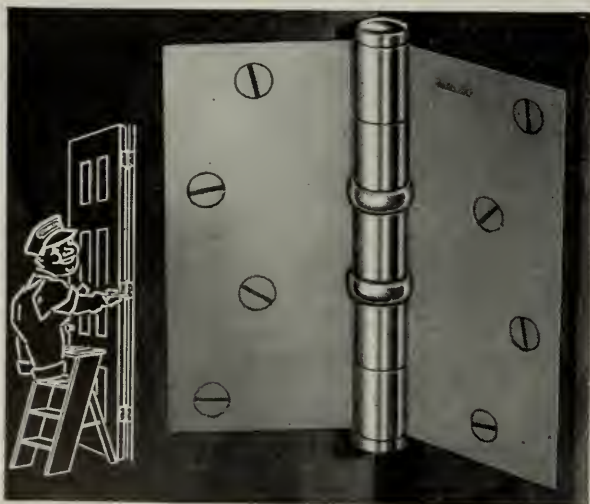

Again.. Three Hinges to a door

Postwar building calls for "three hinges to a door" — to prevent warping and to assure a permanently true-hung door. Specify Stanley Hardware for appearance, endurance and owner satisfaction.

STANLEY

THE STANLEY WORKS, NEW BRITAIN, CONNECTICUT

A. I. A.

American Institute



ACTIVITIES

of Architects

CALIFORNIA COUNCIL OF ARCHITECTS:

John S. Bolles, President; Robert H. Orr, Vice-President, James H. Mitchell, Secretary-Treasurer; 369 Pine Street, San Francisco 4.

Washington State Chapter:

George W. Stoddard, President; Clifton J. Brady and Joseph H. Wohleb, Vice-Presidents Stephen H. Richardson, Secretary; J. H. Dillon De Hart, Treasurer; Offices 516 Central Building, Seattle 4, Washington.

Northern California Chapter:

Andrew T. Hass, President; E. Geoffrey Bangs, vice President; John S. Bolles, Secretary; Hervey Parke Clark, Treasurer; 369 Pine Street, San Francisco 4.

Southern California Chapter:

Charles O. Matcham, President; Adrian Wilson, Vice-President John Landon, Secretary; Albert C. Martin, Jr., Treasurer; Offices 3757 Wilshire Blvd., Suite 212, Phone Flitzroy 2393 or Mutual 4592. DIRECTORS, John Rex, Paul R. Hunter, and Weldon D. Becket.

WASHINGTON STATE CHAPTER

Members heard D. W. Carswell, District Manager of the Civilian Production Administration, outline the recently applied restriction order on building construction at their regular April Meeting.

At the same meeting Erwin L. Weber, Engineer, gave a very interesting and instructive discussion on Radiant Heating, explaining many of his points through use of lantern slide illustrations.

Ivan W. Meyer and Harrison J. Overturf of Seattle, and John S. Villesvik of Yakima have become members of the A.I.A. with assignment to the Washington State Chapter.

The Tacoma Society of Architects have scheduled a "field trip" for inspection of plans for the new Tacoma Narrows Bridge at the Toll Bridge Authority offices at Titlow's Beach; an inspection of a prefabricated panel construction house, and a trip through some of the local plants producing pre-fabricated materials, plywoods, and pre-moulded door casings and jambs.

Washington State building codes. A recent survey conducted by the University of Washington shows that of 138 cities; 61 have building codes especially written for the individual city; 8 have adopted by reference the Building Code of the National Board of Fire Underwriters; 9 have adopted by reference the 1937 Uniform Building Code of the Pacific Coast Buildings Conference, and 8 have adopted the Suggested Basic Building Code for Washington Cities prepared by the Bureau of Governmental Research and Association of Washington Cities.

Betty Fullerton, University of Washington School of Architecture, is now on the staff of the City Planning Board of Portland, Maine.

NORTHERN CALIFORNIA CHAPTER

Reporting to the Executive Committee of the A. I. A., in the matter of the Wisconsin Chapter's "questions" and Board of Directors "answers", Arthur C. Holden writes:

"Long ago when architects were far more dilettante than they are today, and when they did not have the power to control the price of a house nor to deliver a house at the price promised, the Board declared that it was unethical for an architect to undertake to do things that he did not have the power to do nor to pretend to control things that he did not have the power to control. Where an architect does have the power and where he can assure delivery of a product to the public at a specific known price, that architect performs a public service. If the practice is open and above board and recognized as such by the Institute, there should be nothing unethical in the architect participating in a development where houses are offered for stated final prices which include all costs to the owner. This is a public service of a very high character.

"What the architect cannot do is to participate in anything which pretends to be something it is not.

"The time has come when the American Institute of Architects should be ready to reach out and recognize honest services honestly performed, and above all things recognize that there are many ways in which the Architect can serve the public."

William Hull Camp of San Diego was awarded the Degree of Bachelor of Arts, School of Architecture, University of California recently.

A Joint Meeting

The Northern California Chapter, A.I.A. held a joint meeting with the Producers' Council, North-

(Continued on Page 36)

WITH THE ENGINEERS

Structural Engineers Association of
Northern California

W. Adrian, President; William W. Moore, Vice-President; Franklin P. Ulrich, Sec-Treas.; John A. Blume, Ass't. Sec-Treas.; Offices 214 Old Mint Building, San Francisco, Phone GARfield 3890. DIRECTORS, H. M. Engle, Mark Falk, and M. V. Pregnoff.

American Society of Civil Engineers
San Francisco Section

Theodore P. Dresser, Jr., President; Leon H. Nishkian and Sidney T. Harding, Vice-Presidents; John E. Rinne, Secretary-Treasurer; 225 Bush Street, San Francisco 20.

Puget Sound Council (Washington)
Engineering & Technical Societies

R. E. Kistler, A. I. E. E., Chairman; A. L. Miller, A.S.C.E., Vice-Chairman; L. B. Cooper, A.S.M.E., Secretary; B. A. Travis, I.E.S., Treasurer; Offices, Seattle, Washington.

STRUCTURAL ENGINEERS ASSOCIATION OF NORTHERN CALIFORNIA

The proposed new Building Code of San Francisco was discussed recently and based upon discussion by members of the Association, recommendations will be presented Harry C. Vensano, Director of Public Works of the City and County of San Francisco, under whose direction the new measure is being prepared.

CHINESE ENGINEERS

The Chinese Government has sent 13 Chinese hydro-electrical engineers to California to study the power and irrigation projects in the Central Valley project. The study is preparatory to beginning work on the huge Yantze Gorge development, which is to be undertaken by the Chinese Government under technical supervision of the U. S. Reclamation Bureau.

AGRICULTURAL ENGINEERING

Iowa State College is offering a course of instruction in building farm structures training young men to go into construction work, according to Henry Giese, Professor of Agricultural Engineering.

The course includes, carpentry, commercial woods, lumber manufacture, wood preservation, and lumber markets.

STUDY BREAKWATER

Using a Tom Thumb model in an outdoor laboratory, University of California engineers are furnishing the Navy Department with information needed for the construction of a breakwater at Hunter's Point, San Francisco.

Tides, silting and other factors preliminary to actual construction of a breakwater are being studied.

SPRING TERM GRADUATES COLLEGE OF ENGINEERING

The Degree of Bachelor of Applied Science was conferred by the University of California upon the following recently:

Fresno—Jack B. Lindsey; **Los Angeles**—Don Lebell; **Stockton**—Clifford Eric Victorin.

The Degree of Bachelor of Science was conferred upon: **Compton**—Earl George Sorensen; **Davis**—Eugene Frank Serr, III; **Glendale**—Louis Henry Brennwald, Hal Kay St. Clair; **Hollywood**—Julius Carl Seibly, Jr.; **Long Beach**—Perry Wesley Holzgraf, Thomas Richard Stuelpnagel, Robert Aunger Weld; **Los Angeles**—Edgar Milton Foster, Marvin Greenbaum, Robert Bruce Hamilton, John Morgan Page, Philip Helge Skarin, Dino William; **Manhattan Beach**—James Oswald Gerlich, Richard Alan Lindsay; **Pasadena**—Daniel Arthur Shiells; **San Diego**—Don G. Simpson; **Santa Rosa**—Theodore Leo Kopp, Jr., Lawrence Andrew Lindsey; **Taft**—John Robert Shore; **Vallejo**—Stephen Garth Abbott.

ENGINEERING MEETING

The National West Coast Transportation and Maintenance meeting of the National Society of Automotive Engineers, will be held in Seattle, Washington, on August 22, 23, 24.

STRUCTURAL ENGINEERS

Major Richard F. Lyman has been appointed representative delegate of the San Francisco Post of the Society of American Military Engineers to the San Francisco Engineering Council and the Building Industry Conference Board.

Arthur P. Cramer, W. A. Giddings, and Harold O. Sjoberg have taken membership in the Structural Engineers Association of Northern California.

Walter T. Norris, Engineer, has moved into new offices in the Russ Building, San Francisco.

SAN FRANCISCO SECTION AMERICAN SOCIETY OF CIVIL ENGINEERS

Edwin M. Wetmore, Director of Accident Prevention for the Key System Railway, spoke before the April meeting on the subject "A Change of Attitude".

New members include F. W. Panhorst, T. P. Moorhead, W. E. Joyce; Associate Member Paul L. Anderson; and Junior Members J. F. Aguilar, Vincent A. Arena, Vernon C. Bengal, Glen E. Dillon, H. L. Klyce, N. Landes, Thomas H. Peterson, and Donald P. Schultz. This brings the subscribing membership to 721.

Ray L. Allin, has opened a consulting office in San Francisco.

Arthur B. Sullivan, has been appointed City

Engineer of San Mateo, California, following service in the Army as a Major.

U. S. ENGINEERING PROJECT WILL DEVELOP NEW HARBOR

The United States Senate has approved the outlay of \$1,600,000 for harbor improvements at Crescent City, California, which is located 270 miles north of San Francisco, about 70 miles north of Humboldt Bay (Eureka, California), and 17 miles south of the Oregon State line.

The present Crescent City harbor is an open cove, about one mile in length and facing south has no protection against southerly winter storms.

The project provides for breakwaters and authorizes maintenance for a depth of 20 feet, which will permit ocean-going vessels to dock within the harbor.

Cost of harbor improvements to June 30, 1939 including a contribution of \$245,000 by local interests, was \$1,300,000 for new work and \$290,000 for maintenance.

During the War an appropriation of \$200,000 was approved by Congress for construction of an inner breakwater within the harbor to protect commercial fishing boats, after need for such protection was demonstrated by the California State Chamber of Commerce, the Corps of Engineers, U. S. Navy, U. S. Coast Guard, Fish and Wild Life Service and Crescent City interests. Work was not started, however, the project is now being advertised for bids.

While principal area served by the Harbor represents agriculture, mining, fishing, and lumbering, it is the lumbering industry that attracts current need for immediate development.

The new harbor will provide access to 15-billion board feet of timber far removed from rail lines, which will help ease one of the most critical bottlenecks in the Veterans Emergency Housing Program.

The Veterans Emergency Housing Program calls for construction of 2,700,000 homes this year and next. As a result it is estimated the lumber needs of the nation will mount to more than 36-billion board feet a year.

The volume of timber tributary to Crescent City is estimated at about 15-billion board feet, including about nine billion board feet of redwood, about two and a half billion board feet of Douglas Fir, and from three to four billion board feet of mixed conifer timber.



"...built-in telephone outlets add real value to a home"



real value to a home.

Future telephones can be added without tearing up flooring or bringing wires in along baseboards.

Your clients will appreciate



your foresight in planning with an eye to future needs. Our Architects' and Builders' Service will help you in every way possible at no cost.



The Pacific Telephone and Telegraph Company



INDUSTRIAL BUILDING CONSTRUCTION METHODS

(Continued from Page 12)

work. As for example, there may be a unit of the cost of laying common brick in the wall of \$30 per thousand average for the whole job. This might mean that at the start of the work where the job hadn't yet been fully organized or where there were piece-meal operations the superintendent might be making a unit of \$50 and the same way at the wind-up of the job. In order to average \$30 therefore the superintendent might be required to make at the peak of operations a unit of \$20 or less. If he saw that he was getting a \$30 unit in mid-stride he might feel complacent, whereas actually he was due for a headache when the final costs were in. These indicated outcomes or projected costs have saved our clients and us many hundreds of thousands of dollars.

One thing of which I am apprehensive as we go into peacetime construction is the possible unfortunate effect on our construction man power and on its supervisory forces of the experience so many of them will have had in the armed services. I refer particularly to the "Seabees" and to their sister organization, the Engineer Construction Regiments of the Service Forces of the U. S. Army. Here is a group—of probably three-quarters of a million men—in many ways the flower



of our construction personnel who have from two to nearly four years been exposed, through force of circumstance, to an absolute disregard of cost. They have had absolute freedom to have the most expensive tools and equipment. There has been only one requirement, that is to get the job done as quickly as possible regardless of waste of material or cost. Care of construction equipment, conservation of materials and man power have properly been disregarded in the interest of time. To be sure, those Army and Navy engineers and constructors have had a superb training in ingenuity in getting things done. Their self-confidence that anything is possible will be a great asset to huge construction problems which lie ahead of us in America but the fact that the dollar sign has been removed from their thinking for long periods of time may be a not insignificant cloud on our horizon.

In America we have learned that winter weather is seldom a real hurdle to constructing a building. All sorts of industrial buildings—steel, concrete or timber—have been built under severe winter weather conditions substantially as rapidly as under summer conditions. The cost of such winter work varies in our experience from 3 per cent to 10 per cent above normal weather construction. Techniques in protecting masonry and concrete have been developed to a point where they cease to be matters of discussion.

While American building construction may be notable for the speed that has been attained it is my judgment that double or triple shift work seldom pays, either in dollars or in time. We have found, on large operations at least, that with a long (9 or 10 hour) single shift, we can get better production and far better costs than we can by going to two shifts. On building work the third, or night shift, is practically never justified in our experience. It is very costly and very dangerous. Amazing results can be produced on a single shift basis by proper planning of sequence of operations. This is particularly true on jobs large enough to permit shifting of gangs from one part of the work to another.

To produce one good industrial building each week—week in and week out—ready for owner's occupancy, requires, we have found, that the contractor organize to furnish **rigid** self-inspection. No inspection force of the owner or architect can get out of a contractor what he does not intend to give himself. Just as most armies have an Inspector Generals Department, we are geared so that we do not rely upon someone else's inspection of our progress, quality or cost. A good contractor is his own severest critic.

Another trend in this country that may be different from other parts of the world—at least so far

PRESSURE TREATED LUMBER
● **PROTECTS AGAINST DECAY
AND TERMITE ATTACK**

Specify it in your home
Available through Lumber Dealers

LOS ANGELES 601 W. 5th Street Phone Michigan 6294	SAN FRANCISCO 333 Montgomery Street Phone DOuglas 3883
---	--

J. H. Baxter & Co.

AGENTS FOR WEST COAST WOOD PRESERVING CO. SEATTLE, WASH.

as industrial building construction is concerned—is the lack of "standards." The moment someone adopts a "standard" he is prone to freeze his thinking. I saw a phrase the other day which applies most aptly to this situation—"Beaten paths are for beaten men." Our building construction industry is in a constant state of flux—new materials, new methods, new sites, new foundation conditions, new management, new problems—these all tend to keep the industry on anything but **standards**.

Fundamentally, industrial building construction methods are a problem in logistics. What we build is seldom spectacular or very much different than the overall of some sister job but the problem of organizing labor and mechanics, materials and equipment and handling, purchasing, expediting and assembly under pressure of time and cost is the hub of the wheel. The spokes to the rim of final assembly have each one to be studied, but they must all fit so that the wheel rolls along smoothly without vibration or flats.

The work which it was our company's privilege to have a major part in doing from August, 1939, to January, 1944, in building nearly \$400,000,000, worth of Fleet and Air Bases for the U. S. Navy in Hawaii, Midway, Wake, Guam, Manila and Samoa and elsewhere in the Pacific, while dramatic and romantic, was unspectacular in general so far as the things built, but was tremendously spectacular in the problem of logistics. This big job in the Islands of the Pacific and the similar work that other American contractors did on bases in the Aleutians and in the North Atlantic, to say nothing of Africa and Persia, were the fruit of the American construction industry's ability to organize soundly and to staff its jobs with laborers, mechanics and supervisory forces who had had over the years a profit motive to train them to amazing accomplishments.

U. S. SPEEDS UP CENTRAL VALLEY PROJECT

Contracts totaling over 31 million dollars have been either awarded or about to be, since V-J Day, on the Central Valley Project of California.

Contracts for over 30 miles of the Friant-Kern Canal have been let, while an additional 42 mile section is out for bids.

As soon as funds, men, and materials become available work on the huge Project is being speeded up according to Bureau of Reclamation officials.

Rear Admiral Kirby Smith, USNR (Civil Engineering Corps), has been appointed General Deputy Expediter for the Veterans Emergency Housing Program by William W. Wyatt.

HE DEPENDS ON YOU

Your client comes to you for expert advice and skill in home planning. He is confident that he can trust your judgment and ability to specify the kind of a house he wants . . . one which will provide, abundantly, the comforts and conveniences of modern living.

Today one of the principal considerations in providing those comforts and conveniences is the electrical wiring. New, improved lighting and an ever-increasing number of appliances will make unprecedented demands on future wiring systems. No home will be entirely satisfying unless it provides electrical adequacy for years ahead.

That is why architects are insisting on "Adequate Wiring" for every new home—plenty of outlets and switches, plenty of circuits of ample-sized wire (nothing smaller than No. 12).

Prevent future annoyances and disappointments by making "Adequate Wiring" your primary recommendation.



NORTHERN CALIFORNIA
ELECTRICAL BUREAU

1355 Market Street

San Francisco 3



A. I. A. ACTIVITIES

(Continued from Page 31)

ern California Chapter, in the Engineers' Club, San Francisco in April and heard a very interesting program on "Dimensional Coordination" by Ray Brown and Chas. Kraft; "Construction Limitation Order - Part 4700", analysis by Wm. H. Hague, Secretary, Central California, A.G.A.; and a review of the proposed new San Francisco Building Code, by Al Evers, Chairman of the A.I.A. Building Code Committee.

SAN FRANCISCO ARCHITECTURAL CLUB

The San Francisco Architectural Club is preparing to re-open its regular classes and will conduct an architectural seminar for those who expect to take the State architectural examination later.

The seminar will consist of about 15 lectures given by architects and engineers and will last two hours each.

Anyone interested in the courses to be offered should contact the Club offices at 666 Mission Street, San Francisco.

HEADLINE NEWS & VIEWS

By E. H. W.

It is estimated real estate prices have increased from 16 per cent to 18 per cent in larger cities since V-J Day, and range from 25 per cent to well over 100 per cent since 1940. The "inflation rate" is even greater in the smaller cities.

Russell G. deLappe, architect, A.I.A., of Berkeley, California, in cooperation with the American Veterans of Oakland, Berkeley, and San Francisco, has a well founded plan of veteran home building through the group plan. Considerable interest has been developed in the project.

Within the construction industry alone there is a backlog of more than \$29 billion awaiting the "go-ahead" signal. Wonder why someone doesn't give the signal?

The accentuated demand for construction materials resulting from the Wyatt building program will prolong building material shortages throughout 1947. Production of most building materials will have to be at least doubled from current levels to provide the requirements for the two-year housing plan.—New York Journal of Commerce.

A much publicized Los Angeles postwar house is described as "The most thought provoking house in America." So! The "home-beautiful" has become "provoking."

"Steelways," published quarterly by the American Iron and Steel Institute, New York, has done a beautiful job with No. 4. Highways and Building Codes are two of the subjects presented.

Lincoln, Placer county, California, will hold an election on May 3rd to vote on authorizing \$245,000 high school additions and \$100,000 grammar school additions.

"Inflation in Homes and Home Sites," recent publication of the National Housing Agency, Washington, D. C., comprises some 36 pages of facts and figures on what has happened to housing costs.

One-third of the priorities issued through FHA during the first quarter of this year were for homes costing \$6500 or less. It is estimated this figure will raise 50 per cent in the second quarter.

What the construction industry needs is fewer government dollars (in subsidies) and more "sense."



**E. K. WOOD
LUMBER CO.**

**WE MANUFACTURE
OR SUPPLY**

- DOUGLAS FIR
- REDWOOD
- SUGAR OR
- PONDEROSA PINE
- SASH AND DOORS
- MILLWORK
- MASONITE TEMPERED PRESWOOD
- CONCRETE FORM PANELS
- CEMENT ASBESTOS BOARD
- INSULATION AND
- INSULATION BOARD
- INSULATION TILE AND PLANK
- PLASTER BOARD
- FIR-TEX INSULATION PRODUCTS
- TRIPLE-SEALED GYPLAP
- SISALKRAFT BUILDING PAPER
- ROOFING
- WOODLIFE WATER REPELLENT
- MASONITE CEL-U-BLANKET

DEPENDABLE QUALITY

**LOS ANGELES
OAKLAND
SAN FRANCISCO**

"GOODS OF THE WOODS"

IN THE NEWS

OPENS TACOMA OFFICE

Frank Mahon and Felix Robinson, Architects, have opened offices in the Provident Building, Tacoma, Washington, for the general practice of architecture.

WANTS LITERATURE

Casebolt Dakin, 777 N. Lake Avenue, Pasadena 6, California desires to be put on manufacturers lists to receive new catalogues.

SMALL DIAMETER WIRE

National Electric Code approval has been given a small diameter electric wire known as "LAYTEX" for use in buildings. The wire weighs only 30 pounds per mile, and half million miles of it were used during the War as communications and demolition cable.

U. S. PLYWOOD EXPANDS

Fifty-nine per cent of the Kosmos Timber Company and acquisition of the Seattle Export Lumber Company have been announced by the United States Plywood Corp'n.

BENCH TYPE SPOT WELDER

A new plug-in type air operated midget bench spot welder is announced by DAVIS & MURPHY, Davis Bldg., Chicago, Ill.

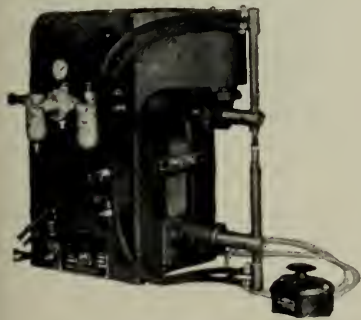

It is the UNIVERSAL USP-7½.

A solenoid valve control of air cylinder by adjustable pressure switch provides a wide range of uses for welding non-ferrous metals, wire, jewelry, and steel.

FOR WORK OR RECREATION

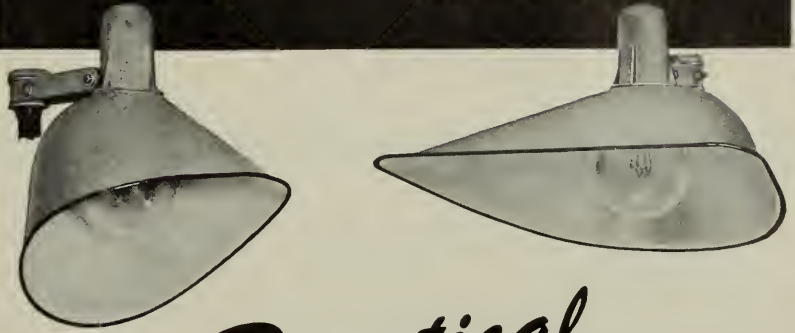

Practical **FLOOD LIGHTING**

for parking lots, sports areas,
filling stations, or the
home yard



LOOK FOR THIS LABEL FOR THE FINEST IN
INCANDESCENT OR FLUORESCENT LIGHTING

PRODUCER'S COUNCIL PAGE

The National Organization of Manufacturers of Quality Building Materials and Equipment
affiliated with THE AMERICAN INSTITUTE OF ARCHITECTS

President, E. E. CATHCART
Johns-Manville Sales Corp.
116 New Montgomery St.

Vice-President, C. J. NICHOLAS
Bostion-Morley Co.
301 Brannon St.

Secretary, H. C. GALITZ
Westinghouse Electric Corp.
110 Sutter St.

Treasurer, E. P. LARSON
Celotex Corp.
675 Townsend St.

Edited by C. W. KRAFT, KRAFTILE CO., Niles, California

NORTHERN CALIFORNIA CHAPTER

BUILDING CODES are being subjected to a lot of critical analysis these days. The public is fearful antiquated codes will prove inadequate to the task of meeting changing conditions and retard construction. The Producers' Council, long conscious of the need for modernizing building codes, took cognizance of this in a speech made by J. W. Follin, Managing Director, before a meeting of the Building Officials Conference of America at Rock Island, Illinois, last fall.

SAN FRANCISCO keeping pace with the times in considering a new building code finds our Northern California Chapter alert to the situation and willing to make definite recommendations.

UNIFORM BUILDING CODE is urged for adoption by this Chapter. It is a well organized, up-to-date document representing the best efforts of a cross-section of building officials and provides for an orderly procedure of change to meet the situations developed by new materials and methods.

Already adopted by some 410 municipalities and other governing bodies, it has the further advantage of uniformity as its name indicates with provision for meeting local conditions as well.

HIGH UP on the list with code matters in order of importance is Modular Planning and Dimensional Coordination as a means of reducing building costs. This very live subject was presented to the Northern California Chapter, A.I.A., by the Producers' Council at a joint meeting April 11th through the slide film record, "A Scotsman Looks at Modular Coordination," featuring a talk by A. Gordon Lorimer, Chief, Bureau of Architecture, City of New York.

Speaking as an Architect to Architects, Mr. Lorimer shows how modular planning and the use of modular coordinated products results in better design and economy both in layout and in construction costs.

NICK NICHOLAS, Program Chairman, is to be congratulated on the informative talks he has arranged this year to post Architects at our monthly meetings on what's new in materials and construction methods. Fine talks and demonstrations of late have been put on by Johns-Manville about the latest thing in removable office partitions, and

Commander Dickie, U. S. Navy, with a movie on the work of pouring under-water construction at the Hunters Point dry docks.

A. A. HOOD, Director of Dealer Relations of Johns-Manville and Chairman of the Marketing Committee of the Producers' Council, maintained the high caliber of our meetings this year with his talk, "A Challenge to the Construction Industry." It is interesting in this connection to note that no meeting this year has attracted less than 60 members and guests—a high for previous years.

LOOKING AHEAD to further informative meetings, Nick has lined up interesting talks as follows:
May—Josam-Pacific: movie on the manufacture of brass goods.

June—Norge Division: "The Packaged Kitchen."

July—Armstrong Cork Company.

August—Mueller Brass Company: copper tubing and Bastian-Morley: "Basmor" boilers for "Panel Heating."

MODULAR MOMENTS

Question: Does the adoption of the 4-inch module means that structural beams and slabs will also conform with consequent excess of material and weight?

Mr. Lorimer: Certainly not. It should be remembered that any system of coordination is the servant of the designer—not his master. The three-dimensional grid on 4-inch centers is a convenient means of referencing in three dimensions all the components of the structure in the same way that cartesian coordinates are used in defining in two dimensions an objective on a military map. Structural thickness will still be designed for functional efficiency. The grid gives a convenient and accurate method of determining the exact detail required to make any required adjustment between the structural elements and coordinated masonry materials. Where possible, this adjustment is handled in the plastic materials such as plaster or concrete cove rather than cutting small slivers of masonry materials.



USE QUALITY PRODUCTS



CONSULT AN ARCHITECT

IN THE NEWS

RODGER YOUNG VILLAGE

Formal ceremonies dedicating the Rodger Young Village, Los Angeles, were held on April 27, 1946; with Fletcher Bowron, Mayor; George H. Moore, President of the City Council; and officials of the Housing Authority of Los Angeles taking part.

Located two miles north of Los Feliz intersection, with the main entrance off Riverside Drive, the Rodger Young Village is purported to be the largest Veterans' Housing Project in the country.

APPOINTED

Ormie C. Lance, for 13 years secretary of the Northwestern Lumbermen's Association, has been named secretary-manager of the National Door Manufacturers' Association, succeeding W. M. Steinbauer.

NDMA is expanding its activities of product development, standardization, research, public relations and general industry progress.

GENERAL ELECTRIC CHANGES

W. R. Rivers, Bridgeport, Conn., has been appointed district representative for construction materials sales for the General Electric Company, with headquarters in Los Angeles, J. O. Dillingham, Pacific District manager announced.

Jack Peevey has been appointed to a similar position in the Southwestern District with headquarters in Houston, Texas.

RESEARCH LABORATORY ADDED

The ALLEGHENY LUDLUM STEEL CORPORATION is adding an ultra modern \$2,000,000 research laboratory and experimental center to its headquarters plant at Brackenridge, Pa., according to a recent executive announcement.

Fundamental and applied research on highly specialized stainless, magnetic, valve, tool, and other complex steels will be conducted.

Southern yellow pine guides in a spray type pickling machine treated with "ASIDBAR", a plastic-impregnated wood developed by KOPPERS WOOD PRESERVING TECHNICAL DEPARTMENT, Orrville, Ohio, were found to be sound after 18 months of service. Untreated wood in the same application, subject to a 10 per cent to 15 per cent sulfuric acid at temperatures of 180 degrees F., lasted only two to three weeks.

BASALITE

LIGHTWEIGHT CONCRETE
BUILDING UNITS

CHARACTER • ECONOMY • INSULATION
FIRE-SAFE • TERMITE PROOF • PERMANENCE

BASALT ROCK CO., INC.
NAPA, CALIFORNIA

FORDERER CORNICE WORKS

Manufacturers of

Hollow Metal Products • Interior Metal Trim
Elevator Fronts and Cabs
Metal Plaster Accessories • Sanitary Metal Base
Flat and Roll Metal Screens
Metal Cabinets • Commercial Refrigerators

269 POTRERO AVE.

SAN FRANCISCO, CALIF.

HEMLOCK 4100

STRUCTURAL STEEL

For Class A Buildings,
Bridges, etc.

JUDSON PACIFIC - MURPHY CORP.

1200 SEVENTEENTH STREET
SAN FRANCISCO

Plants: San Francisco - Oakland

SISALKRAFT

REG. U. S. PAT. OFF.

"More than a building paper"

THE SISALKRAFT CO.

205 West Wacker Drive
Chicago, Ill.

55 New Montgomery Street
San Francisco, Calif.

IN THE NEWS

Los Angeles, California
April 14, 1946

ARCHITECT & ENGINEER

68 Post Street

San Francisco, California

Gentlemen:

I would like to subscribe to your magazine but am unfamiliar with your subscription rates. If you will forward me this information, I shall remit by return mail.

For many years, prior to my entry into military service, I enjoyed your magazine and look forward to receiving it once again.

Thanking you for an early attendance to this matter, I remain

Sincerely yours

Clifton S. Halliday

4156½ Normal Avenue

Los Angeles 27, California

ALL AMERICAN ENTERS BUILDING MATERIALS FIELD

James "Monk" Moscrip, All-American end of the Stanford University 1933-34-35 football teams has entered the building materials field.

FOR SALE BUILDING NEWS

Pertinent facts relative to building and contracting projects contemplated in Northern California.

A DAILY ADVANCE new service giving name and location of project, architect, proposed cost, and other valuable information.

YOU GET DAILY REPORTS at a total cost of \$10 PER MONTH. Get prepared for the coming building opportunities.

Subscribe for This Service Today

ARCHITECT'S REPORTS

Published Daily by

ARCHITECT and ENGINEER, Inc.

68 Post Street, San Francisco

EXbrook 7182

He is now northern California sales representative for L. Sonneborn Sons, Inc., manufacturers of building materials, whose distributors for the San Francisco bay area are Western Asbestos Company, San Francisco, Yancey Company, Sacramento; and Valley Insulation Company, Fresno.

CAST IRON RADIATORS

Revision of the Simplified Practice Recommendation R174-43, which applies to Cast-Iron Radiators, has been announced by the National Bureau of Standards.

The revision retains all but one of the small-tube radiators, and adds a stock assembly schedule.

Results of a study discloses that 60 standard assemblies will take care of 90 per cent of total demands throughout the country.

Mimeographed copies of the revision may be obtained from the Division of Simplified Practice, National Bureau of Standards, Washington 25, D. C.

FACTORY FABRICATED HOUSES

Formation of a new corporation to design, manufacture and distribute completely equipped factory fabricated houses at erected prices to the owner ranging from \$4997 to \$5891 has been announced by Donald Deskey, internationally known industrial and architectural designer.

The new corporation, known as Shelter Industries, Inc., of New York, has already started production in its East Coast manufacturing facilities, and volume production will make houses available at the rate of 200 per month before the end of the year.

Present plans to expand the number of factories identified with the program will enable the company to produce at the rate of more than 26,000 houses annually during 1947, company officials have declared.

COLUMBIA STEEL

C. T. Spivey has been appointed assistant director of industrial relations of Columbia Steel Company, William A. Ross, president announced from the Company's San Francisco offices.

He has served in numerous engineering and industrial capacities since joining the company in 1937.

SEMI-ANNUAL MEETING

The Semi-Annual meeting of the American Society of Heating and Ventilating Engineers in 1946 will be held in Montreal, Canada, on June 10, 11, and 12.

Three business and technical sessions have been scheduled according to Alfred J. Offner, president of the Society.

ESTIMATOR'S GUIDE

BUILDING AND CONSTRUCTION MATERIALS

PRICES GIVEN ARE FIGURING PRICES AND ARE MADE UP FROM AVERAGE QUOTATIONS FURNISHED BY MATERIAL HOUSES TO SAN FRANCISCO CONTRACTORS. 2½% SALES TAX ON ALL MATERIALS BUT NOT LABOR

All prices and wages quoted are for San Francisco and the Bay District. There may be slight fluctuation of prices in the interior and southern part of the state. Freight cartage, at least, must be added in figuring country work.

BONDS—Performance—\$10 per \$1000 of contract. Labor and materials, \$10 per \$1000 of contract.

BRICKWORK—

Common Brick—Per 1M laid—\$50.00 to \$60.00 (according to class of work).
 Face Brick—Per 1M laid—\$120 to \$150 (according to class of work.)
 Brick Steps—\$1.60 per lin. ft.
 Brick Veneer on Frame Bldg.—Approx. \$1.30 per sq. ft.
 Common Brick—\$19.00 per M, truckload lots, f.o.b. job.
 \$19.00 per M, less than truckload, plus cartage.
 Face Brick—\$40 to \$80 per M, truckload lots, delivered.
 Cartage—Approx. \$4.00 per M.

BUILDING PAPER—

1 ply per 1000 ft. roll.....\$3.50
 2 ply per 1000 ft. roll.....5.00
 3 ply per 1000 ft. roll.....6.25
 3 Brownskin, Standard, 500 ft. roll.....5.00
 Sisalkraft, 500 ft. roll.....5.00
 Sash cord com. No. 7.....\$1.20 per 100 ft.
 Sash cord com. No. 8.....1.50 per 100 ft.
 Sash cord spot No. 7.....1.90 per 100 ft.
 Sash cord spot No. 8.....2.25 per 100 ft.
 Sash weights, cast iron, \$50.00 ton.
 Nails, \$3.42 base.
 Sash weights, \$45.00 per ton.

CONCRETE AGGREGATES—

The following prices net to Contractors unless otherwise shown.
Gravel, all sizes—
 \$1.95 per ton at Bunker; delivered\$2.50

	Bunker	Del'd
Top Sand	\$1.90	\$2.50
Concrete Mix	1.90	2.45
Crushed Rock, ¼" to ¾".....	1.90	2.50

Crushed Rock, ¾" to 1½".....	1.90	2.50
Roofing Gravel	2.25	2.80
River Sand	2.00	2.45

Sand—

River Sand	2.00	2.45
Lapis (Nos. 2 & 4).....	2.85	3.15
Olympia (Nos. 1 & 2).....	2.85	3.10
Del Monte White84c per sack	

Cement—
 Common (all brands, paper sacks), carload lots, \$2.42 per bbl. f.o.b. car; delivered \$2.72.
 Cash discount on carload lots, 10c a bbl., 10th Prox.; less than carload lots \$3.20 per bbl. f.o.b. warehouse or delivered.
 Cash discount 2% on L.C.L.

Atlas White	} 1 to 100 sacks, \$2.50 sack warehouse or del.; \$7.65 bbl. carload lots.
Calaveras White	
Medusa White	

Forms labor average \$350 per 1000 sq. feet.
 Average cost of concrete in place, 50c per cubic foot, exclusive of forms; \$15.00 per cubic yard. With forms \$1.60 per cubic foot.

DAMP-PROOFING and Waterproofing—

Two-coat work, \$3.50 per square.
 Membrane waterproofing—4 layers of saturated felt, \$7.00 per square.
 Hot coating work, \$2.50 per square.
 Medusa Waterproofing, \$3.50 per lb. San Francisco Warehouse.
 Tricocel waterproofing.
 (See representative.)

ELECTRIC WIRING—\$12 to \$15 per outlet

for conduit work (including switches).
 Knob and tube average \$3.00 per outlet. (Available only for priority work.)

ELEVATORS—

Prices vary according to capacity, speed and type. Consult elevator companies. Average cost of installing a slow speed automatic passenger elevator in small four story apartment building, including entrance doors, about \$6500.00.

EXCAVATION—

Sand, 60 cents; clay or shale \$1 per yard.

Trucks, \$20 to \$32 per day.
 Above figures are an average without water. Steam shovel work in large quantities, less; hard material, such as rock, will run considerably more.

FIRE ESCAPES—

Ten-foot galvanized iron balcony, with stairs, \$150 installed on new buildings; \$160 on old buildings.

FLOORS—

Composition Floors, such as Magnesite, 50c per square foot.
 Linoflor—2 gages—\$1.25 to \$2.75 per sq. yd.
 Mastopave—90c to \$1.50 per sq. yd.
 Battleship Linoleum—available to Army and Navy only—1/8"—\$1.75 sq. yd.
 7/8"—\$2.00 sq. yd.
 Terazzo Floors—50c to 70c per sq. ft.
 Terazzo Steps—\$1.75 per lin. ft.
 Mastic Wear Coat—according to type—20c to 35c.

Hardwood Flooring—
 Standard Mill grades not available.
 Victory Oak—T & G
 1½" x 2¼".....\$143.25 per M. plus Cartage
 ½" x 2".....122.00 per M. plus Cartage
 ½" x 1½".....113.50 per M. plus Cartage
 Prefinished Standard & Better Oak Flooring
 1½" x 3¼".....\$180.00 per M. plus Cartage
 ½" x 2½".....160.50 per M. plus Cartage
 Maple Flooring
 1½" T & G Clear \$160.50 per M. plus Ctg.
 2nd 153.50 per M. plus Ctg.
 3rd 131.25 per M. plus Ctg.
 Floor Layers' Wage, \$1.50 per hr.

GLASS—

Single Strength Window Glass.....	20c per	<input type="checkbox"/> ft
Double Strength Window Glass.....	30c per	<input type="checkbox"/> ft.
Plate Glass, under 75 sq. ft.....	\$1.00 per	<input type="checkbox"/> ft.
Polished Wire Plate Glass.....	1.40 per	<input type="checkbox"/> ft.
Reg. Wire Glass.....	.34 per	<input type="checkbox"/> ft.
Obscure Glass.....	.27 per	<input type="checkbox"/> ft.
Glazing of above is additional.		
Glass Blocks	\$2.50 per	<input type="checkbox"/> ft. set in place

HEATING—

Average, \$1.90 per sq. ft. of radiation, according to conditions.
 Warm air (gravity) average \$48 per register.
 Forced air, average \$68 per register.

IRON—Cost of ornamental iron cast iron, etc., depends on design.

LUMBER—All lumber at O.P.A. ceiling prices—

No. 1 Common	\$49.00 per M
No. 2 Common	47.75 per M
Select O. P. Common	52.75 per M

Flooring—

	Delvd
V.G D.F. B & Btr. 1 x 4 T & G Flooring	\$80.00
C 1 x 4 T & G Flooring	75.00
D 1 x 4 T & G Flooring	65.00
D.F.-S.G. B & Btr. 1 x 4 T & G Flooring	61.00
C 1 x 4 T & G Flooring	59.00
D 1 x 4 T & G Flooring	54.00
Rwd. Plastic—"A" grade, medium dry	82.00
"B" grade, medium dry	78.50

Plywood—not available

	Under \$200	Over \$200
"Plyscord"—3/8"	\$49.50	\$47.55
"Plywall"—1/4"	45.15	43.30
3 ply—2/s—1/4"	48.55	46.60
"Plyform"—3/8"		
Unoiled	126.50	121.45
Oiled	127.90	122.75

Above prices delivered if quantity is sufficient to warrant delivery.

Shingles (Rwd. not available)—

Red Cedar No. 1—\$6.75 per square; No. 2, \$5.75; No. 3, \$4.45.
Average cost to lay shingles, \$3.00 per square.
Cedar Shakes—Tapered: 1/2" to 3/4" x 25"—\$8.95 per square.
 Resawn: 3/4" to 1 1/4" x 25"—\$10.65 per square.
 Resawn: 3/4" to 1 1/4" x 25"—\$10.65 per square.
Average cost to lay shakes, \$4.00 per square.

MILLWORK—Standard.

D. F. \$100 per 1000. R. W. Rustic \$100.00 per 1000 (delivered).
Double hung box window frames, average with trim \$6.50 and up, each.
Complete door unit, \$10.00.
Screen doors, \$3.50 each.
Patent screen windows, 25c a sq. ft.
Cases for kitchen pantries seven ft. high, per lineal ft., \$9.00 each.
Dining room cases, \$9.00 per lineal foot.
 Rough and finish about 80c per sq. ft.
Labor—Rough carpentry, warehouse heavy framing (average), \$40.00 per M.
For smaller work average, \$40.00 to \$55.00 per 1000.

MARBLE—(See Dealers)

PAINTING—

Two-coat work	per yard 50c
Three-coat work	per yard 70c
Cold water painting	per yard 10c
Whitewashing	per yard 8c

PAINTS—

Two-coat work50c per sq. yd.
Three-coat work70c per sq. yd.
Cold water painting.....per yard 10c
Whitewashing 8c per sq. yd.
Turpentine \$1.03 per gal. in drum lots.
 \$1.08 per gal. in 5-gal. containers.
Raw Linseed Oil—not available.

Boiled Linseed Oil—\$1.38 per gal in drums. Available only to work with high priority—\$1.48 per gal. in 5-gal. containers.

Use replacement oil—\$1.86 per gal. in 1-gal. containers.

Replacement Oil—\$1.20 per gal. in drums. \$1.30 per gal. in 5-gal. containers.

A deposit of \$6.00 required on all drums.

PATENT CHIMNEYS—

6-inch	\$1.20 lineal foot
8-inch	1.40 lineal foot
10-inch	2.15 lineal foot
12-inch	2.75 lineal foot

PLASTER—

Neat wall, per ton delivered in S. F. in paper bags, \$17.60.

PLASTERING (Interior)—

	Yard
3 Coats, metal lath and plaster	1.50
Keene cement on metal lath	1.80
Ceilings with 3/4 hot roll channels metal lath (lathed only)	1.20
Ceilings with 3/4 hot roll channels metal lath plastered	*2.20
Single partition 3/4 channel lath 1 side (lath only)	1.20
Single partition 3/4 channel lath 2 inches thick plastered	3.20
4-inch double partition 3/4 channel lath 2 sides (lath only)	2.20
4-inch double partition 3/4 channel lath 2 sides plastered	3.85
Thermax single partition; 1" channels; 2 1/4" overall partition width. Plastered both sides	3.30
Thermax double partition; 1" channels; 4 3/4" overall partition width. Plastered both sides	4.40
3 coats over 1" Thermax nailed to one side wood studs or joists	1.65
3 coats over 1" Thermax suspended to one side wood studs with spring sound isolation clip	1.90

Note—Channel lath controlled by limitation orders.

PLASTERING (Exterior)—

	Yard
2 coats cement finish, brick or concrete wall	\$1.00
3 coats cement finish, No. 18 gauge wire mesh	2.00
Lime—\$3.00 per bbl. at yard.	
Processed Lime—\$3.10 bbl. at yard.	
Rock or Grip Lath—3/8"—20c per sq. yd.	
3/4"—19c per sq. yd.	

Composition Stucco—\$1.80 to \$2.00 sq. yard (applied).

PLUMBING—

From \$100.00 per fixture up, according to grade, quantity and runs.

ROOFING—

"Standard" tar and gravel, 4 ply—\$8.00 per sq. for 30 sqs. or over.
Less than 30 sqs. \$9.50 per sq.
Tile, \$30.00 to \$40.00 per square.
Redwood Shingles, \$7.50 per square in place.
5/2 #1-16" Cedar Shingles, 4 1/2"
Exposure\$8.00 square

5/8 x 16"—#1 Cedar Shingles, 5"
Exposure\$9.00 square
4/2 #1-24" Royal Shingles, 7 1/2"
Exposure\$9.50 square
Re-coat with Gravel \$4.00 per sq.
Asbestos Shingles, \$23 to \$28 per sq. laid.
1/2 x 25" Resawn Cedar Shakes,
 10" Exposure\$10.50
3/4 x 25" Resawn Cedar Shakes,
 10" Exposure 11.50
1 x 25" Resawn Cedar Shakes,
 10" Exposure 12.50
Above prices are for shakes in place.

SHEET METAL—

Windows—Metal, \$1.75 a sq. ft.
Fire doors (average), including hardware \$2.00 per sq. ft.

SKYLIGHTS—(not glazed)

Copper, 90c sq. ft. (flat).
Galvanized iron, 40c sq. ft. (flat).
Vented hip skylights 60c sq. ft.

STEEL—STRUCTURAL—

\$150 ton (erected), this quotation is an average for comparatively small quantities. Light truss work higher. Plain beams and column work in large quantities \$140 per ton.

STEEL REINFORCING—

\$100 to \$130 ton, set.

STONE—

Granite, average, \$6.50 cu. foot in place
Sandstone, average Blue, \$4.00. Boise \$3.00 sq. ft. in place.
Indiana Limestone, \$2.80 per sq. ft. in place.

STORE FRONTS (None available).

TILE—

Ceramic Tile Floors—\$1.00 to \$1.25 per sq. ft.
Cove Base—\$1.10 per lin. ft.
Glazed Tile Wainscot—\$1.25 per sq. ft.
Asphalt Tile Floor 1/8" & 3/8"—\$.18 to \$.35 per sq. ft. Light shades slightly higher.
Cork Tile—\$.40 to \$.75 per sq. ft.
Mosaic Floors—see dealers.
Lino-Tile, \$.35 to \$.75 per sq. ft.

Wall Tile—

Glazed Terra Cotta Wall Units (single faced) laid in place—approximate prices:
2 x 6 x 12\$1.10 sq. ft.
4 x 6 x 12 1.25 sq. ft.
2 x 8 x 16 1.20 sq. ft.
4 x 8 x 16 1.40 sq. ft.

VENETIAN BLINDS—

40c per square foot and up. Installation extra.

WINDOWS—STEEL—

30c per square foot, \$5 for ventilators.

ARCHITECT AND ENGINEER

IN THE NEWS

LOW COST HOMES

The FHA has re-established the so-called Title 1 Class 3 small home program which proved so successful during prewar years.

The plan is designed to furnish homes for veterans at a cost of as little as \$25 per month, including principal and interest charges as well as taxes, insurance, and special assessments.

Rural areas, small towns, and urban centers where houses are in the \$3,000 to \$3,500 price range are best suited to the program, FHA officials point out.

JOHN E. FENNACY, architect, has moved his offices from Menlo Park, to Fresno, California, Route 11, Box 578.

OPENS OFFICE

E. J. Peterson, Architect, has opened offices in the Sherwood Building, Spokane 8, Washington. He returns to the practice of Architecture after four and one half years service with the U. S. Army Engineers.

SITE PLANNER LANDSCAPE ARCHITECT

*Civic Recreational Areas
Memorial Sites
Residential Grounds
Commercial Developments*

ALLAN HIMES REID

244 Oxford Ave., Palo Alto
Phones: Palo Alto 2-4226
San Francisco: Garfield 5084

1945 BUILDING TRADES WAGE SCALES (JOB SITES) NORTHERN CALIFORNIA

Six- and seven-hour day eliminated on all Government Work. A. F. L. - O. P. M. Agreement calls for eight-hour day.

NOTE: Predeterminations by the Department of Labor, as of July 1, 1944 (the wage-freezing date) have not yet been made in all of the counties listed. The wage scales shown are those being paid and in effect mostly by agreement between employees and their union.

CRAFT	San Francisco	Alameda and Contra Costa	Fresno	Marin	Sacramento	San Jose	San Mateo	Vallejo	Stockton
ASBESTOS WORKERS.....	1.50	1.50	1.25	1.50	1.50	1.25	1.50	1.50	1.25
BRICKLAYERS.....	1.87½	1.87½	1.75	1.87½	1.75	2.00	1.75-1/6	1.75	1.50
BRICKLAYERS, HODCARRIERS.....	1.40	1.40	1.05	1.40	1.05	1.50	1.35	1.50	1.14
CARPENTERS.....	1.50	1.50	1.50	1.43¾	1.37½	1.37½	1.43¾	1.50	1.37½
CEMENT FINISHERS.....	1.50	1.50	1.50	1.50	1.50	1.50	1.50	1.50	1.50
ELECTRICIANS.....	1.70	1.70	1.70	1.70	1.70	1.70	1.70	1.70	1.70
ELEVATOR CONSTRUCTORS.....	1.75½	1.75½	1.75½	1.75½	1.75½	1.75½	1.75½	1.75½	1.75½
ENGINEERS: MATERIAL HOIST.....	1.50	1.50	1.25	1.50	1.37½	1.62½	1.50	1.37½	1.25
PILE DRIVER.....	1.75	1.75	1.60	1.75	1.75	1.75	1.75	1.75	1.75
STRUCTURAL STEEL.....	1.75	1.75	1.60	1.75	1.75	1.75	1.75	1.75	1.60
GLASS WORKERS.....	1.40	1.40	1.12½	1.40	1.12½	1.21	1.40	1.40	1.40
IRONWORKERS: ORNAMENTAL.....	1.60	1.50	1.60	1.50	1.60	1.31¼	1.50	1.50	1.50
REINF. RODMEN.....	1.50	1.50	1.60	1.50	1.50	1.60	1.50	1.50	1.25
STRUCTURAL.....	1.75	1.75	1.75	1.75	1.75	1.75	1.75	1.75	1.37½
LABORERS: BUILDING.....	1.00	1.00	.90	.87½	.95	.90	.93¾	.90	.90
CONCRETE.....	1.00	1.00	.90	.87½	.95	.90	.93¾	.95	1.00
LATHERS.....	1.75	1.75	1.50	1.75	1.60	1.75	1.75	1.75	1.75
MARBLE SETTERS.....	1.50	1.50	1.50	1.50	1.50	1.50	1.50	1.50	1.50
MOSAIC & TERRAZZO.....	1.25	1.25	1.12½	1.25	1.15-5/8	1.12½			
PAINTERS.....	1.50	1.50	1.28-4/7	1.50	1.43	1.50	1.42-6/7	1.64-2/7	1.37½
PILEDRIVERS.....	1.54	1.54	1.54	1.54	1.54	1.54	1.54	1.54	1.54
PLASTERERS.....	1.75	1.83½	1.75	1.75	1.75	2.00	2.00	1.75	1.83-1/3
PLASTERERS' HODCARRIERS.....	1.50	1.60	1.40	1.50	1.18¾	1.50	1.75	1.50	1.50
PLUMBERS.....	1.70	1.70	1.53-1/8	1.70	1.68¾	1.62½	1.70	1.70	1.50
ROOFERS.....	1.50	1.50	1.25	1.37½	1.50	1.37½	1.25	1.37½	1.37½
SHEET METAL WORKERS.....	1.50	1.50	1.50	1.50	1.50	1.50	1.37½	1.50	1.50
SPRINKLER FITTERS.....	1.58	1.58	1.53-1/8	1.70	1.68¾	1.62½	1.70	1.78	1.50
STEAMFITTERS.....	1.75	1.75	1.53-1/8	1.70	1.68¾	1.62½	1.50	1.70	1.50
STONESETTERS (MASON'S).....	1.87½	1.87½	1.50	1.75	1.75	1.50	1.75	1.75	1.50
TILESETTERS.....	1.50	1.50	1.37½	1.50	1.37½	1.50	1.50	1.50	1.37½

Prepared and compiled by

CENTRAL CALIFORNIA CHAPTER, ASSOCIATED GENERAL CONTRACTORS OF AMERICA

with the assistance and cooperation of secretaries of General Contractors Associations and Builders Exchanges of Northern California.

CLASSIFIED ADVERTISING

RATE: 8c PER WORD . . . CASH WITH ORDER

MINIMUM \$1.50 (3 Lines)

ARCHITECT'S REPORTS—A valuable advance news service giving building and construction information daily on projects in Northern California. Name, location, architect, proposed cost, etc., on individual slips. Ideal for securing new business leads. Hundreds of items, total monthly cost only \$10. Don't delay, subscribe today. **ARCHITECT & ENGINEER**, Room 618, 68 Post Street, San Francisco, California. Phone DOuglas 8311.

ARCHITECTS—A. McF. McSweeney, Architect, Room 927 Hearst Bldg., San Francisco. New offices. Desires catalogs.

PHOTOGRAPHY—Keep a pictorial record of your building, or construction project. Pictures are of tremendous value to contractors, builders, engineers, architects. For Industrial-Publicity-Aerial photography, see

FRED MAE, Room 721-22 Hearst Bldg., San Francisco 3, California.

PRINTING—Printers, bookbinders. See us for commercial printing. Mercury Press, 942 Howard Street, San Francisco.

WANTED—Architectural designer capable of taking charge of office, general practice. Excellent opportunity. Telephone Hilgate 6449, Oakland, California.

MALOTT & PETERSON

ROOFING AND FLOORING
CONTRACTORS

20TH AND HARRISON STREETS
SAN FRANCISCO
Phone ATwater 1600

HOGAN LUMBER CO.

Wholesale and Retail

LUMBER

MILL WORK • SASH & DOORS

Office, Mill, Yard and Docks

SECOND AND ALICE STREETS • OAKLAND, CALIF.

Telephone GLencourt 6861

CLINTON CONSTRUCTION CO. OF CALIFORNIA

General Contractors

923 FOLSOM STREET • SAN FRANCISCO
SUtter 3440

SANTA MARIA INN SANTA MARIA, CALIFORNIA

FRANK J. McCOY, General Manager

FERNAND E. PIMENTEL, Manager

On the
Coast
Highway
between
San
Francisco
and
Los
Angeles



American
or
European
Plan
•
Old
English
Tap
Room

EXPANSION PROJECT . . . SHELL DEVELOPMENT COMPANY

(Continued from Page 17)

fume hoods but a unique arrangement for chemists' write-up spaces as well. The entire service function is predicated upon flexibility so that low or high wall benches may be used or equipment merely hung to wall racks, attachments for which are provided. It is proposed that partitions be likewise constructed of a similar unit design to be readily removable by the minimum use of tools and effort. A complete ventilating system for the building is provided; refrigeration is not required because of the ideal year-round temperature in Emeryville.

The building housing heavy equipment is designed as a "catch-all" for miscellaneous heavy activities. Generally speaking, these constitute certain heavy plastics and rubber laboratories and housing for certain heavily-equipped engineering shops.

One of the peculiar requirements of this site became an important element in the architectural design of both new buildings and the remodeling of existing buildings. The long dimension of the site fronts west on the east side of San Francisco Bay. A strong and glaring southwest sun becomes a detrimental factor to those laboratories and offices generally facing south and west. Various studies were made in an effort to control this situation. These studies necessarily were tempered by including existing buildings and cost factors. It was ultimately decided to use a type of vertical louver adjusted to the correct angle to prohibit the objectionable rays of the sun and yet provide maximum clear light. This solution turned out to be the common denominator required in the architecture to properly unify new buildings with existing buildings to be remodeled. Louvers are to be used on the south and west facades of the buildings, and the head and sill extensions to receive them are to be reduced to a minimum and the louvers omitted on the north and east facades.

It generally has been the desire to develop an architecture practical from the standpoint of plan and critical exposures and yet dignified and professional in appearance. By the use of certain architectural forms and characteristics, a technical air has been developed which, in the opinion of those who have studied the problem, gives each of the buildings on the site a character consistent with the activity pursued therein.

BOOK REVIEWS

REX SANITATION AND LIQUID CLARIFICATION.
Bulletin No. 46-3, Chain Belt Company, 1600 W.
Bruce Street, Milwaukee 4, Wisconsin.

Forty-four-page booklet deals with conveyor sludge collectors and Tow-Bro sludge removers, grit collectors and washers, Verti-Flo thickeners, skimmers, Aero-filters, Floctrol, rapid mixers, gravity waste water-oil separators, and water screens.

Illustrated with pictures, drawings, and diagrams

CATALOG OF AMERICAN STANDARDS. Industrial Standardization Part 2; American Standards Ass'n., 70 E. 45th St., New York 17, N. Y.

Complete set of all American Standards may be obtained at special price of \$185.00 per set, includes more than 800 standards approved to date by the Association. Revised to April 15, 1946. Includes Civil, Engineering and Construction, Mechanical Engineering, Electrical Engineering, Automotive, Transportation, Ferrous Metals and Metallurgy, Non-Ferrous Metals and Metallurgy, Rubber, Chemical Industry, Textile Industry, Mining, Wood Industry, Pulp and Paper Industry, Miscellaneous, and Commercial Standards.

TIN RESEARCH INSTITUTE 1942-1944. Tin Research Institute, Battelle Memorial Institute, 505 King Avenue, Columbus, Ohio.

Covers the Institute's activities in development of tin uses during the past three year period. Includes numerous illustrations and a section devoted to pamphlets issued dealing with technical uses and discussions of tin and tin alloys.

CELANESE SYNTHETICS FOR THE ELECTRICAL INDUSTRY. Celanese Plastics Corp'n., 180 Madison Avenue, New York 16, N. Y.

A highly illustrated booklet containing many examples of synthetics, their characteristics, mechanical and electrical properties and application to the electrical field. Offers technical service and help on special problems relating to the adoption of synthetics.

A total of 12,578 applicants for housing were interviewed by the San Francisco Housing Authority rental office staff during 1945. This is an average of 241 per week. Average number of interviews per week of the first quarter of 1946 dropped to 180.

PACIFIC MANUFACTURING CO.

HIGH CLASS INTERIOR FINISH
QUALITY MILLWORK

142 SANSOME ST., SAN FRANCISCO
GARfield 7755

6820 MCKINLEY AVE., LOS ANGELES
THornwall 4196

BUILDERS EXCHANGE, OAKLAND

"AMERICAN - MARSH" CONDENSATION UNIT

Pumping
Machinery
for
Every
Purpose

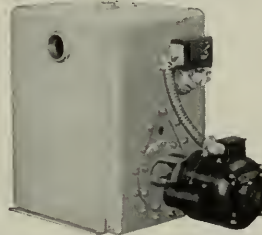

For Service
Call
DOuglas
6794
or
MUtual8322

SIMONDS MACHINERY CO.
SAN FRANCISCO 816 FOLSOM
LOS ANGELES 455 EAST 4TH

VERMONT MARBLE COMPANY

Producers and Finishers
of
Domestic and Imported Marbles

Write for new pamphlet describing our
Marble Toilets and Showers

San Francisco and Los Angeles
San Francisco phone: Sutter 6747



The Most Complete Line of
STEELS and BUILDING MATERIALS
Made by a Single Producer



See Sweet's Catalog File or write us for
full information.

REPUBLIC STEEL CORPORATION
GENERAL OFFICES: CLEVELAND, OHIO

DENVER, COLORADO CONTINENTAL OIL BUILDING
LOS ANGELES, CALIFORNIA EDISON BUILDING
SALT LAKE CITY, UTAH WALKER BANK BUILDING
SAN FRANCISCO, CALIFORNIA RIALTO BUILDING
SEATTLE, WASH. WHITE-HENRY-STUART BUILDING

Real Estate Loans



F H A loans are readily available on existing homes up to 80% of the appraised value. You can buy a home and pay for it in small monthly installments like rent. For example, a 20-year loan of \$6000 would cost about \$49.56 per month, including taxes, insurance, principal and interest.

*Come in and talk with us
We can help you get the home
you want*

CROCKER FIRST NATIONAL BANK

OF SAN FRANCISCO
California's Oldest National Bank
ONE MONTGOMERY STREET
Member Federal Deposit Insurance Corporation

Venetian Blinds

of

Metal or Wood

for

Homes and Offices

Installed and Serviced

by

GUNN CARLE & CO.

20 POTRERO AVENUE

SAN FRANCISCO 3

Underhill 5480

IN THE NEWS

LAND PRICES UP

Raw land prices on the Pacific Coast have increased 98.5 per cent since 1940 a recent survey of the National Housing Agency shows.

NEW STAIR TREAD

Protecting the step against foot traffic and the riser against kicking and scuffing, especially by youngsters running up the stairs, a new product by the AMERICAN MAT CORP'n, Toledo, Ohio, known as DOUBLE-DUTY STAIR TREAD is being marketed in two sizes, 18" and 24" widths.

NEW ELECTRIC WALL HEATER

Enclosed in a heavy steel casing that fits flush with the wall a new electric wall heater is being placed on the market this month by HYDRO-AIRE, Inc., Los Angeles, California.



The heater is equipped with nichrome wire twin heating elements and a highly polished reflector. The grill is of heavy design in either aluminum or chrome plate.

Size is 12" x 18" x 4". Wattage 1500, Voltage 120 ac, weight about 7 pounds.

INTERNATIONAL NICKEL

The tonnage of ore mined during the War equalled that mined by the Company during the preceding 54 years.

KYLE FORREST

Civil Engineer

Water Supply — Sanitation

Municipal — Private
Consultations — Investigations
Reports — Designs — Valuations
Supervision — Litigation

Ground Water Work a Specialty

Hydrologic studies — wells, de-watering, underdrainage, foundations, conservation, testimony.

1504 Russ Building
San Francisco 4
YUkon 0652

ELMER F. STEIGELMAN

CIVIL ENGINEER

Structures of Steel, Wood
and Reinforced Concrete

Special Attention to
Architects' Requirements

690 Market Street
San Francisco, California
GARfield 0588

Built-In Fixtures for the Post-War Home

Paramount Fixtures will fit your post-war needs . . . investigate our new kitchen ideas which make for convenience and efficiency.

Paramount Built-in Fixtures meet the most exacting requirements. Our "Deluxe," "Moderne" and "Economy" cabinet fixtures are distinctive in design and construction and may be had in stock sizes or built to order.

Catalog for the asking

Paramount
BUILT-IN FIXTURE COMPANY
5107 Broadway, Oakland, California
Phone Pledmont 8100

THE TORMEY COMPANY

GENERAL PAINTERS
AND DECORATORS

Phone UNDERhill 1913

563 FULTON STREET
San Francisco

G. P. W. JENSEN & SON

Building Construction

320 Market Street, San Francisco

Phone: GARfield 2444

JOHN CASSARETTO COMPANY

—Since 1886—And Still Active—

Building Materials

READY MIX CONCRETE
ROCK - SAND - GRAVEL - LIME
CEMENT - PLASTER - MORTAR
METAL LATH - WOOD LATH
STUCCO - WIRE NETTING

Service Unexcelled

Bunkers
Sixth and Channel, San Francisco
Phones: GARfield 3758 - 3760

MULLEN MFG. COMPANY

BANK, STORE AND OFFICE
FIXTURES—CABINET WORK
OF GUARANTEED QUALITY
CHURCH SEATING

Office and Factory:
60-80 RAUSCH ST., Bet. 7th and 8th Sts.
San Francisco
Telephone UNDERhill 5815

IN THE NEWS

COAST VISITOR

Charles A. Scarlott, head of Westinghouse "Editorial Service" and editor of WESTINGHOUSE ENGINEER was an April-May visitor to the Pacific Coast. His offices are located in Pittsburgh, Penn.

HOME PRICES UP

Homes that sold for \$6000 or less in 1940 have increased an average of 96.3 per cent in Pacific Coast States, as compared with a national average price of 65.1 per cent according to National Housing Agency survey.

FLOOD LIGHTING

The new Guth HY-LITERS provide intense spot or flood lighting for merchandise displays and show windows.

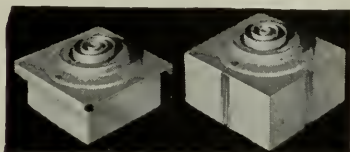

They are simple and beautifully designed, finished in white enamel and trimmed with polished aluminum flutings. Made for surface or recessed mounting with flange or teebar, and easily installed. Edwin F. Guth Company, St. Louis, Mo.

POSTWAR PRODUCT

This shower cabinet is a modernization of the FIAT METAL MANUFACTURING COMPANY, Pasadena, California, "Cadet" model, restyled to include rounded interior corners and stiles, and bonderized galvanized rustproof steel wall panels.

Supplied with shower curtain or Fiat Zephyr aluminum framed glass door.

PREFABRICATED HOMES

Dawson Winn, Laurel, Mississippi, has been elected president of the Prefabricated Home Manufacturers' Institute. Some 44 member manufacturers have adopted a program calling for 850,000 permanent prefabricated homes in the next two years.



HERRICK IRON WORKS

STRUCTURAL STEEL
REINFORCING STEEL

18TH AND CAMPBELL STS.
OAKLAND, CALIF.
Phone GLencourt 1767

Phone GARfield 1164

Thomas B. Hunter

Consulting Engineer

DESIGNER OF HEATING
AIR CONDITIONING
VENTILATING AND WIRING
SYSTEMS, MECHANICAL
AND ELECTRICAL EQUIP-
MENT OF BUILDINGS

41 SUTTER STREET
ROOM 710
San Francisco California

ANDERSON & RINGROSE

General Contractors

320 Market Street, San Francisco
Phone GARfield 2245

DINWIDDIE CONSTRUCTION COMPANY

•
BUILDERS

•
CROCKER BUILDING
SAN FRANCISCO

A. F. MATTOCK CO.

Builders



212 CLARA STREET
SAN FRANCISCO

INDEPENDENT IRON WORKS

Steel Buildings
Service Stations
Steel Storage Tanks
Fabricated Plate Work
Steel & Sheet Metal Products
Fabricated Structural Steel
Steel Distributors

Eighth & Pine Sts. Oakland, 7

George F. Brayer

ELECTRICAL
CONTRACTOR

166 Seventh Street
San Francisco

Phone: Market 1761

SMITH, EMERY & CO.

Since 1904

Engineers - Chemists

Inspection, Tests, Analyses,
Research, Consultation
Structural Materials, Structures,
Equipment, Pipe, Soils

Associates

Los Angeles and Eastern Cities
Offices and Laboratories
651 Howard Street, San Francisco

Index to Advertisers

ALADDIN Heating Corp.	48
ANDERSON, & Ringrose	47
ANGIER Sales Corporation	*
ARCHITECTS Reports	40
BASALT Rock Company	39
BAXTER & Company, J. H.	34
BENTLEY, Clyde	25
BRAYER, Geo. F.	48
CASSERETTO, John	47
CLARK, N., & Son	*
CLASSIFIED ADVERTISING	43
CLINTON Construction Company	44
COLUMBIA Steel Co.	*
COLOTYLE Corporation	*
CROCKER First National Bank	46
DINWIDDIE, Construction Company	47
FORDERER, Cornice Works	39
FORREST, Kyle	46
FULLER, W. P., Co.	2
GUNN, Carle & Company	46
HANKS, Inc., Abbot A.	48
HAWS Drinking Faucet Company	Back Cover
HERRICK Iron Works	47
HOGAN Lumber Company	44
HUNT, Robert W., Company	48
HUNTER, Thos. B.	47
IMPERIAL Brass Manufacturing Co.	*
INDEPENDENT Iron Works	48
JENSEN & Son, G. P. W.	47
JOHNSON, Company, S. T.	*
JUDSON, Pacific-Murphy Corp.	39
KRAFTILE Company	5
KAWNEER Company	*
MALOTT & Peterson	44
MATTOCK, A. F.	48
MULLEN, Mfg. Co.	47
MUELLER Brass Co.	*
NORTHERN California Electrical Bureau	35
OWENS Corning Fiberglas Co.	*
PACIFIC Coast Gas Association	*
PACIFIC Manufacturing Company	45
PACIFIC Portland Cement Company	1
PACIFIC Telephone & Telegraph Co.	33
PARAMOUNT Built-in Fixture Co.	46
PARKER, STEFFINS & PEARCE	*
PAYNE Furnace & Supply Co., Inc.	*
PORTLAND Cement Association	*
REID, Allan Himes	43
REMILLARD-Dandini Co.	48
REPUBLIC Steel Corporation	45
SANTA Maria Inn	44
SCOTT Co.	*
SIMONDS Machinery Company	45
SISALKRAFT Company	39
SMITH, Emery & Co.	48
SMOOT-Holman Co.	37
STANLEY Works, Inc., The	30
STEIGELMAN, Elmer F.	46
SOULE Steel Co.	*
TAYLOR Co., Halsey W.	*
TIMBER Engineering Co., Inc.	*
TORMEY Company, The	47
UTILITY Appliance Corp.	*
U. S. STEEL	*
U. S. BONDS	Inside Back Cover
VERMONT Marble Company	45
WESTIX Electric Heater Co.	*
WESTERN Asbestos Company
.....	Inside Front Cover
WOOD, E. K., Lumber Company	36

* Indicates Alternate Months

Robert W. Hunt Company

ENGINEERS

Inspection - Tests - Consultation

Schools and Other Structures
Are Built as Designed

When Construction Materials are
Inspected at point of Manufacture
and during Erection by

ROBERT W. HUNT COMPANY

Cement, Concrete, Chemical, Metallurgical,
X-Ray and Physical Laboratories

Chicago - New York - Pittsburgh
Los Angeles - All Large Cities
San Francisco, 251 Kearny Street

REMILLARD - DANDINI Co.

Brick and
Masonry Products



633 BRYANT ST., SAN FRANCISCO
569 THIRD ST., OAKLAND

ALADDIN Heating Corp.

Specializing in
QUALITY HEATING
EQUIPMENT

2222 San Pablo Avenue
OAKLAND
TWINOAKS 1022

ABBOT A. HANKS, INC. Engineers & Chemists

INSPECTING - TESTING - CONSULTING
CONCRETE • STEEL • MATERIALS
CHEMICAL AND TESTING
LABORATORIES
• RESEARCH AND INVESTIGATION •

TESTS OF STRUCTURAL MATERIALS
DESIGN OF CONCRETE MIXES
SHOP AND ERECTION INSPECTION OF
STRUCTURES AND EQUIPMENT
INVESTIGATION OF STRUCTURES
AND MATERIALS
TESTS AND INVESTIGATION OF
FOUNDATION SOILS
FIRE RESISTANCE AND INSULATION
TESTS

624 Sacramento Street, San Francisco

ARCHITECT AND ENGINEER

IN THIS ISSUE

GOOD HOUSES Are Built of Dry Lumber

**ONE ANSWER TO THE VETERAN HOUSING
PROBLEM**

IRWIN M. JOHNSON DESIGNS A COMMUNITY

THE PERSONALIZED MODERN HOUSE

PIETRO BELLUSCHI DESIGNS A SHOE STORE

A VETERANS' HOUSING COOPERATIVE PLAN

And Many Other Items of Particular Interest in the Architectural and
Engineering Profession, and Building and Contracting Industry.

JUNE

1946

HOW MANY STEPS TO MAKE A *Cake?*

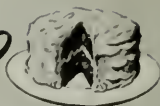

In baking a cake, Mrs. Homemaker may take as many as 600 steps, as few as 300. Her kitchen "mileage" is largely under *your* control. Design her kitchen for step-saving and assembly-line food preparation . . . equip with modern gas appliances . . . and save her as much as 500 miles' walking a year,* as well as assuring these advantages: faster, easier cooking, with more certain results . . . silent, carefree refrigeration . . . ample hot water—all at low cost, with gas. ★ *Your* "dividends": client good will; greater saleability of speculative homes; more recommendations of your services.

*Authoritative tests show that in a poorly-designed and equipped kitchen, the housewife may walk a minimum of *1,000 miles* a year in preparing average meals for a family of five . . . and that scientific design can cut this mileage in half!

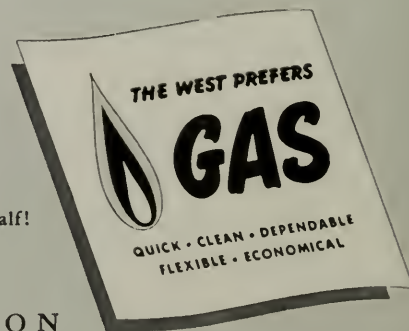

THE PACIFIC COAST GAS ASSOCIATION

• ARCHITECT

Vol. 165 No. 3

AND ENGINEER

ARCHITECTS' REPORTS—Published Daily

Telephone DOuglas 8311

E. H. WILDER
Editor

MARK DANIELS, A.I.A.
Associate Editor

JOHN S. BOLLES, A.I.A.
Book Reviews

MICHAEL GOODMAN
Post-War Planning

L. H. NISHKIAN
Consulting Editor

E. N. KIERULFF
Ass't Editor
*In the Service

Contents for



JUNE

ARTICLES AND MISCELLANEOUS TEXT

EDITORIAL NOTES	4
NEWS AND COMMENT ON ART	6
GOOD WOOD HOUSES Are Built of Dry Lumber	9
By L. V. TEESDALE, Engineer	
ONE ANSWER TO THE VETERAN HOUSING PROBLEM	10
IRWIN M. JOHNSON Designs a Community	12
By C. W. KRAFT	
THE PERSONALIZED MODERN HOUSE	16
By MARGARET McKAY TEE, Interior Decorator and Designer	
PIETRO BELLUSCHI Designs a Shoe Store	19
A VETERANS HOUSING COOPERATIVE PLAN	22
By JULIUS M. KELLER	
INTERMOUNTAIN ALL METAL HOME	26
By C. L. BRUM	
SUPER-HIGHWAYS, French	27
COMMENTS ON USE OF MODULAR DESIGN	28
By CHARLES CRESSEY, Architect	
IN THE NEWS	29, 36, 37, 39, 43, 46, 47
A.I.A. ACTIVITIES	31
WITH THE ENGINEERS	32
HEADLINE NEWS & VIEWS	35
PRODUCERS' COUNCIL PAGE	38
ESTIMATOR'S GUIDE	41
WAGE SCALES	43
CLASSIFIED ADVERTISING	43
BOOK REVIEWS	45
INDEX TO ADVERTISERS	48

ARCHITECT AND ENGINEER (Established 1905) is published on the 15th of the month by The Architect and Engineer, Inc., 68 Post St., San Francisco 4; Telephone EXbrook 7182. President, K. P. Kierulff; Vice-President and Manager, L. B. Penhorwood; Treasurer, E. N. Kierulff.

Los Angeles Office: Wentworth F. Green, 1709 West Eighth Street.

Entered as second class matter, November 2, 1905, at the Post Office in San Francisco, California, under the Act of March 3, 1879. Subscriptions United States and Pan America, \$3.00 a year; \$5.00 two years; foreign countries \$5.00 a year; single copy 50c. ARCHITECTS' REPORTS are published daily from this office, Vernon S. Yallop, Manager.



TAKING STOCK

Architects, Engineers, and Contractors who have been wrestling with non-professional matters during the war should find a great value in numerous national surveys of present day ideas in housing, schools, industrial and municipal buildings.

That the war changed ideas is obvious; what is less apparent at this time is the tremendous construction planning, and the extensive progress in such technical matters as materials.

The techniques of rapid building and economy of material, a new freedom in open planning and composite forms of architectural composition are results of "ideas" developed during the war when the necessity for speed and lack of material discarded many long accepted customs.

* * *

Manufacturers are wondering how soon they will have to turn a part of their efforts to selling rather than producing.

* * *

WHAT YOU MAY EXPECT

If you are interested in Who's going to build What, a careful study of the information contained in ARCHITECTS' (Daily) REPORTS during the past several weeks, indicates the greatest increase in percentage volume of construction during the balance of 1946 will be in the classification of schools, hospitals and municipal buildings. Because of various restrictions on scarce materials for general construction and the favorable priorities and great emphasis being placed on Veterans' Housing, homes and apartments represent the greater increase in per dollar volume, with current upward trends extending well into 1947.

Industrial and commercial construction, while representing a substantial volume, has slowed considerably since the first of the year and is apparently awaiting a more favorable labor and materials market before hitting its anticipated postwar stride.

* * *

Projecting emergency wartime housing practices into present-day home construction is but building the slums of tomorrow!

* * *

SPEAK THEIR MIND

Members of the Southern California Chapter, A.I.A., have expressed their opinion of current government regulations being imposed upon the construction industry in the words of the following resolution:

"RESOLVED, That the Delegates from this Chap-

ter to the 1946 Convention of the American Institute of Architects be advised that it is the sense of this meeting that this Chapter recommend that the Institute publicly voice dissatisfaction with any continuance of all government regulations on any and all phases of the construction industry, believing that better solutions will more quickly be found for the critical lack of housing through means of freedom of competition and private enterprise in lieu of mandatory and manipulated economy."

* * *

A SIGNAL HONOR

Harold Ellis, manager of public information for the University of California, has been given an award by the American College Public Relations Association for "Outstanding Achievement in the Interpretation of Education" during the past year.

Ellis earned the honor through his handling of the University of California Convocation on the Berkeley campus during the United Nations Conference in San Francisco, when six world leaders gave addresses and were presented with honorary degrees and for his work in connection with the Army-Navy "E" Award and the University's Los Alamos Scientific Laboratory, where the atomic bomb was made.

This national recognition of Mr. Ellis' work is a distinct honor. It reminds us that the responsibility of those who direct public thinking is indeed great, whether it be in the field of education, industry, or commerce.

* * *

DEMANDS FOR HOME REPAIR

There is a gigantic pent-up demand for home repair and improvement work to be done as soon as materials for the purpose are available, according to the Federal Housing Administration. In estimating the demand for credit to finance this type of work, "We need only to consider that there are near 40,000,000 dwelling structures in this country and that very little improving or modernizing work has been done during the past five years. Practically every house needs some kind of work done to it." Possibly half of these dwelling owners would want work done as soon as materials are available and one out of six would seek credit. This would mean 3,300,000 loan applications.

Alteration and repair work costing more than \$400 may now be authorized by the Federal Housing Administration acting for the Civilian Production Administration. Remodeling to create additional dwelling units for veterans' occupancy may be undertaken with priorities assistance.



**We made our record
IN THE AIR
by keeping our feet
ON THE GROUND...**



In the late 20's we shared Lockheed's thrill in their new Vega—our Finishes were on that ship. Today, Lockheed's Constellation is another air-world sensation. She, too, flies with Fuller Aircraft Finishes!

There's more. Fuller Finishes are on the Douglas DC-6, on Consolidated Vultee's Convair and on the Boeing Stratocruiser.

Our continuing leadership in Aircraft Finishes comes directly from our strict laboratory and field procedure on ALL industrial products. This: "Know the *whole* problem to get the *complete* answer."

All Fuller Aircraft Products now are available in any quantity for private use. Inventories on other Industrial Finishes are being increased as rapidly as materials permit. W. P. Fuller & Co. Factories in San Francisco, Los Angeles, Portland; Branches, Warehouses in principal Western cities.

FULLER
Industrial **FINISHES**



THE WEST— AMERICA'S NEW INDUSTRIAL FRONTIER

FULLER pioneered in '49; became West's largest, most skilled paint makers. We're still pioneering in '46—with NEW products for our Western Industrial frontier!

MAINTENANCE FINISHES

In the field of factory maintenance, Fuller Color Engineering *puts color to work* . . . increases production profit through better employee safety, morale. Write for new, up-to-minute book, or have Fuller representative call with data.

PRODUCTION FINISHES

Under the pressure of war needs, we telescoped years of research on the problems of Plywood finishing. Today, we feel we lead the field. Whether you're interested in sealing Plywood at a mill or in working out a finishing system in the shop, Fuller can give you the right answers.

MARINE FINISHES

Mr. Boatbuilder: See Fuller! From a plastic laminated hull down to the lowly dory, we've got a finish for every purpose. (For sea-going ships, too!)

NEWS AND COMMENT ON ART

UNUSUAL EXHIBITION OPENS AT M. H. DeYOUNG MEMORIAL MUSEUM

One Hundred Fifty Best Paintings from 300 Submitted in Second Annual Pepsi-Cola Competition for American Artists Will Be Shown Under Auspices of 34 Art Societies

San Franciscans will see an unusual art exhibition of contemporary American painting in the Second Annual "Portrait of America" at the M. H. DeYoung Memorial Museum.

The exhibition, which will continue through June 30, has been made possible by the joint efforts of Pepsi-Cola Company and thirty-four art societies. The showing here is the fourth stop on the national tour of eight major cities in the United States where the exhibition is touring throughout 1946, following its initial presentation in Rockefeller Center, New York City. The exhibit consists of 150 paintings, selected by a jury of artists, from among 3,000 canvases submitted by artists throughout the country to the nation-wide Second Annual Pepsi-Cola competition for American artists, conducted in order to bring the finest contemporary art before the American public.

From the 150 exhibition paintings, twenty were chosen by an art jury as prize winners of a total of \$15,250, which was presented by the industrial patron. Paul Burlin won the first prize of \$3,500 for his "Soda Jerker." Max Weber, who is represented in the permanent collection of the Palace of the Legion of Honor, won the second prize of \$2,000 for "Colonial Table." Gregorio Prestopino won third prize of \$1,500 for "Morning Conference." Mark Tobey won fourth prize of \$1,000 with "Sale." Zoltan Sepeshy, who was awarded second prize at the San Francisco Exposition in the year 1940, won the fifth prize of \$750 for his painting "Fisherman's Morning." Fifteen other artists won \$500 each.

The citizens of San Francisco will vote for their favorite painting among the 150, and the winning

artist will receive a special award of \$100 offered by Mr. Angelo Campodonico.

Among the exhibition artists of special interest to San Francisco, in addition to the major award winners, are Adams W. Garrett and Phil Paradise, each the winner of a \$500 award. Garrett has exhibited at the San Francisco Museum of Modern Art while Paradise received the first award for water colors from the San Francisco World's Fair in 1940. Other artists represented in the exhibit and also known to San Francisco include John Atherton, George Biddle, Alexander Brock, Teresa D'elia, Hayley Lever, Ward Lockwood, Peppino Mangravite, Antonio P. Martino, Raymond P. R. Neilson, Henry Varnum Poor, Chauncey F. Ryder, Maurice Sterne, Denny Winters, Harold Holmes Wrenn and N. C. Wyeth. Two of the artists, Gordon Grant and William Hesthal, were born in San Francisco.

The first four prize winners and also two recipients of \$500 awards are the property of Pepsi-Cola Company, which, together with sixteen additional paintings purchased from the first annual "Portrait of America" exhibition, will become the nucleus of a collection of contemporary art. "Beachcomber" by Julian Levi and "Coasting Schooner" by John C. E. Taylor have also been purchased by members of the public as a result of the exhibitions in New York and New Orleans.

The following twelve prize winning canvases have been reproduced, one-half million of which have been distributed free of charge to libraries, museums, schools, stores, etc., throughout the country: "Colonial Table" by Max Weber; "Morning Conference" by Gregorio Prestopino; "Fisherman's Morning" by Zoltan Sepeshy; "Practice" by Lester Rondell; "Station Road" by Carl Gaertner; "March Wind" by Phil Paradise; "Southern Town" by Sgt. Oke G. Nordgren; "March First Move" by Terence R. Duren; "Pier at Rockport" by James



REDWOOD MURAL by Almo Lazarini, New York artist. On display in the Redwood Lounge of the Petaluma Hotel, Petaluma, California

NEWS AND COMMENT ON ART

MADEMOISELLE RAVOUX

by Vincent Van Gogh

This portrait of 1890, reckoned among the most important of the artist's mature style, is on indefinite loan at the San Francisco Museum of Art thanks to the generosity of an anonymous lender. It is exhibited frequently, and during June will be hung at the entrance of the galleries.



Illustration Courtesy San Francisco Museum of Art

Lechay; "The Farm" by Doris Kunzie; "Fog" by Jon Corbino; and "St. Louis Union Station" by Fred Conway.

SAN FRANCISCO MUSEUM OF ART

Among the current exhibitions is the one-man exhibition by Eduardo Kingman of Ecuador consisting of oils, gouaches and wood blocks. Mr. Kingman is here in an official capacity. The Casa de Cultura selected him as plastic arts representative on Council in 1944 and he has been in the United States since 1945. Although he is represented, in his current exhibition, as an easel painter, he has been more active as a mural painter. In 1939 he spent ten months in New York working on the decoration of the Ecuadorian Pavilion at the New York World's Fair.

EXHIBITIONS:

ANTON REFREGIER: Paintings and Drawings of the San Francisco Conference—June 11- July 9.
GRAHAM SUTHERLAND: British Painter—June 11- July 7.

HISTORY OF WATERCOLOR: From the Collection of the Whitney Museum—June 18- July 14.
THIRTY-FIVE DISTINGUISHED BAY REGION WATERCOLORISTS—June 18-July 14.
COLONIAL LATIN AMERICAN ARCHITECTURE—June 18-July 14.
WAR DRAWINGS by Corrado Cagli—June 25- July 7.
SEVEN AGES OF A PHYSICIAN: Paintings by James Chapin—June 25-July 7.

MUSEUM ACTIVITIES:

STUDIO WORKSHOP—Wednesdays, 7 to 9:30 p.m.
SKETCH CLUB—Fridays, 7 to 9:30 p.m. Studio meetings for amateurs and professionals with competent guidance by George Harris. Free to Members.
GALLERY TOURS—Every Sunday on Current Exhibitions by Members of the Museum Staff.

FILMS:

KNOW YOUR WORLD SERIES—Saturdays, Sundays, 2:30 o'clock.
RUSSIAN PROGRAM—June 15, 16.
UNITED STATES PROGRAM—June 22, 23.
MARINE LIFE—June 29, 30.

NEWS AND COMMENT ON ART—con't

FAMOUS FILM SERIES:

THE INFORMER, 1935, Directed by John Ford—
Tuesday, June 18, 8 p.m.

CALIFORNIA PALACE OF THE LEGION OF HONOR

Dr. Jermayne MacAgy, acting Director of the California Palace of the Legion of Honor, has announced the following schedule of exhibitions and special events for June:

EXHIBITIONS

"Paris," an exhibition of paintings by Floyd Davis and Gladys Rockmore Davis, being circulated by Life Magazine, will open at the California Palace of the Legion of Honor, June 14, for one month. Illustrating life in Paris in the year 1945, the paintings cover a wide variety of subjects including book stalls along the Seine; execution wall near the Champs-Elysees where patriots were shot by the Nazis; La Madeleine in the moonlight; Montmartre; buying apples from a push-cart in Montmartre; the flower stalls; GI's returning from the front; German prisoners; German torture chamber; collaborationists' stores; trail of the collaborationist, Stephane Lausanne, and the buying of perfume.

Also opening at the California Palace of the Legion of Honor on June 14 will be "San Francisco: Two Viewpoints," an exhibition of watercolors and photographs of important places and buildings in this city. One may see here the interpretation of a watercolorist and the interpretation of a photographer. The watercolorist is Leola Dixon and the photographer, her husband, Madison Devlin. Both have depicted the same scenes and the exhibition presents the two approaches of the different mediums.

Opening June 10 will be a showing of work from the Museum's Saturday afternoon adult paint class, and on June 11 there will open an exhibition of "Chinese Peasant Woodblocks," lent by Paul Forster, who brought them back from his assignment in the Orient for the Office of War Information.

WORK FROM MUSEUM'S SATURDAY AFTERNOON ADULT PAINTING CLASS—Opening June 10th.

CHINESE PEASANT WOODBLOCKS—Opening June 11th.

CHARLES HOWARD: RETROSPECTIVE EXHIBITION, 1925-1946—Closing June 9th.

LOAN COLLECTION OF IMPORTANT 20th CENTURY PAINTINGS—Closing June 11th.

CITYSCAPES BY NADINE PIZZO—Closing June 9th.

RUBBINGS OF ANCIENT CHINESE TILES, lent by Mr. Paul Forster—Through June.

The Alma de Bretteville Spreckels' Collection of Sculpture by Auguste Rodin.

The Mildred Anna Williams' Collection of Paintings, Sculpture, Tapestries and Furniture.

The Collis Potter Huntington Memorial Collection of 18th Century French Paintings, Sculpture, Tapestries, Furniture and Porcelain.

SPECIAL PROGRAMS

Organ Recital by Uda Waldrop, every Saturday and Sunday, 3 p. m.

Organ Concert Broadcast at 3:30 p. m., Saturday, Station KSFO.

FREE MOTION PICTURES

Each Saturday at 2:30 p. m.

FIVE KEYSTONE COMEDIES—CHARLIE CHAPLIN:

MAKING A LIVING—1914—(Silent)

HIS NEW PROFESSION—(Silent)

GETTING ACQUAINTED—(Silent)

THE KNOCKOUT—(Silent)

THE ROUNDERS—(Silent)—June 15.

TROUBLE IN PARADISE—1932—(Sound)—Miriam Hopkins, Herbert Marshall—June 22.

MILLION DOLLAR LEGS—1932—(Sound) W. C. Fields, Jack Oakie—June 29.

SPECIAL FILMS FOR CHILDREN—10:30 every Saturday morning:

June 15—"JUNGLE CAVALCADE"—Frank Buck;
June 22—"BLACK BEAUTY"; June 29—"DANIEL BOONE"—George O'Brien and Heather Angel.

SPECIAL LECTURES by Thomas Carr Howe, Jr., Director of the Museum, and former Lt. Comdr., U. S. N. R., on his experience during the war, as acting Chief of the Monuments, Fine Arts and Archives Section, Headquarters U. S. Forces at Frankfurt, Germany.

Wednesday, June 19, 3 p. m.—"The Restitution of Art Looted by the Nazis."

NEW ACQUISITION

The painting, ST. JOHN THE BAPTIST, by El Greco, considered a masterpiece of painting by one of the greatest masters of art, has been acquired for the permanent collection from funds received through sale of duplicate and inferior items in the Museum's storage.

With the Rubens "Tribute Money," acquired two years ago, and the Cranach "Virgin and Child with St. John," presented to the Museum earlier

(Continued on Page 40)

Good Wood Houses

Are built of dry lumber

By **L. V. TEESDALE, Engineer**

Forest Products Laboratory,* Forest Service

U. S. Department of Agriculture

We need homes in this country, millions of them, not only for our GI's, but for untold numbers of families whose present housing accommodations are inadequate. The buyers of these houses expect them to be permanent homes, well constructed and comparable to the type built in pre-war days. They will not be equal, however, unless the materials used are equal to those used in the past. One important difference is the lack of stocks of seasoned lumber and the fact that green or unseasoned material may be used.

The tremendous demand for housing will require an enormous amount of lumber. Because present lumber stocks are practically exhausted the lumber required must be produced from trees now standing in the forests. Freshly cut lumber is green, that is, it contains a lot of moisture or sap. This moisture should be removed before the material is suitable for use. The sawmill capacity of this country for ordinary peacetime needs in the past has been somewhat greater than is required to fill orders for lumber so that stocks have accumulated at the sawmill and in wholesale and retail yards. Time was thus allowed for stock to be adequately dried or seasoned before it was finally sold to the consumer. During periods when the demand for stock exceeds the capacity of the mills, however, the stock on hand becomes smaller and smaller, the time allowed for seasoning decreases, and if the demand becomes great enough the lumber may be sold as fast as it can be cut and without time for seasoning. Such a condition of demand exceeding the production began to develop before Pearl Harbor and has been with us ever since. The backlog of yard stock was

exhausted years ago, and it will be many years in the future before stocks can be built up at sawmills and distributing yards for seasoning.

It is immediately advantageous to both the lumber producers and the distributors to sell the stock unseasoned since it means quick turnover of capital invested, reduced labor costs for piling and handling, reduced insurance and carrying charges, and no loss in grade that may accompany seasoning. Nevertheless, the responsible sawmill operators and lumber dealers understand the disadvantages of using unseasoned lumber and would prefer to sell it seasoned. On the other hand, the current demand for lumber of any kind is imperative and leaves them no choice but to sell it as fast as it can be produced. The ultimate home owners are, however, generally unaware of the hazards they will encounter as a result of using the lumber unseasoned.

The GI in need of a place to live is naturally impatient in his demand for a home but also expects that the materials used are of good quality and suitable for the purpose. He will be bitterly disillusioned when he finds through defects that develop in the structure that unseasoned material has been used. We have been building houses since our ancestors first landed in this country and have learned how to build better houses than they built, but we still have not learned how to build good houses of unseasoned lumber.

Woods used for construction materials are of two classes: (1) those used for beams, joists, studs, rafters, sheathing, and subflooring, commonly called framing or yard lumber; and (2) those used for flooring, finish, trim, doors, and windows, called finishing lumber or planing-mill products. Most

* Maintained at Madison 5, Wis., in cooperation with the University of Wisconsin.

(Continued on Page 33)



An assembly line view of Wingfoot Homes showing three stages of operation: (left to right), (1) kitchen cabinets and sink being installed adjacent to heating unit; (2) walls of living room being erected and (3) roof being moved into place.

One Answer To The Veteran Housing Problem

Mass production of some 48,900 two-bedroom homes annually to relieve the nation's acute housing shortage and to aid the veteran in securing living quarters, has been offered by Wingfoot Homes, Inc., a subsidiary of the Goodyear Tire and Rubber Company, providing the necessary materials and equipment for manufacture are readily forthcoming.

It has been proposed to Wilson Wyatt, Federal Housing Expeditor, that idle war plants be utilized

for the manufacture of the completely assembled homes, and that under proper cooperation in respect to materials needed for construction, that the rate of production would exceed 157 per day.

Peak production would be reached 90 days after installation of required plant equipment and priority building materials and company officials stated the assembled homes would sell at the factory for under \$2,500 and would be delivered ready for the veteran's family to move in complete

with bathroom and kitchen fixtures, built-in beds, bureaus, closets, mirrors and cabinets.

Veteran's would be given preference in employment in all phases of the Wingfoot housing projects.

First developed in 1942 the houses have been produced on a limited scale during the past 12 months in a pilot assembly plant at Litchfield Park, Arizona. During the four years of construction developments have been made to a point where a pattern for production now exists and which can be quickly expanded to a large volume production plan.

The home is 26 feet long and 8 feet wide while in transit which permits its delivery by truck over any highway in the country. Bedroom wings are extended at the delivery site to an overall width of 15 feet 4 inches converting the house into a T-shape unit. It has a floor area of about 250 square feet and weight 6500 pounds.

A front porch floor and roof are attached as the house is moved onto its foundation ready for sewage, water, gas and electric connections, and telephone. Only curtains, linen and a minimum of living-dining room furniture are required to make the home complete.

The living space consists of a combination kitchen-dining-living room, two bedrooms, bathroom consisting of a toilet, lavatory and stall shower and two large bedroom closets.

Included in the built-in features are one double bed, two single beds in bunk style, lockers and extra shelves, two book cases, five-drawer vanity, seven-drawer dresser, seven-drawer chest, two mirrors (one for each bedroom), kitchen cabinets,

medicine cabinet, sink storage cabinet and utility storage space.

An ice box, four burner gas range insulated oven with broiler, automatic 20-gallon water heater and a circulating heater are provided as standard equipment.

The homes are provided with nine windows and two doors, all weather-stripped, and in addition five weather-proof louvers provide adequate ventilation. Screens are provided at no extra cost.

The plumbing consists of four-inch pipe, with two-inch drain from shower and one and a half inch drain from the sink, each properly trapped and vented. The water system is in copper tubing with soldered fittings, and the gas system is of standard piping. Bathroom complete with standard fixtures while the shower cabinet is enameled metal.

All electrical wiring is No. 12 or No. 14 BX cable. Switches and convenience outlets are in boxes. Included in the wiring are four fixture outlets complete with suitable approved lighting fixtures and seven duplex convenience outlets.

Other features of the Wingfoot home include an exterior of Tempered Presdwood, fir plywood interior, and fully insulated and painted inside and out with waterproof enamel paints. The floors consist of five-eighths-inch five-ply plywood with 2 x 4 joists and completely insulated. Bathroom is covered with inlaid linoleum.

The roof is made of plywood with asbestos covering, with all edges protected by metal flashing, slightly pitched to permit proper drainage and fully insulated.

The homes qualify for long term financing.



Simple method of loading and unloading a Wingfoot Home with little equipment calls for the use of jacks and house steps. The house is jacked up gradually to a height sufficient to back a trailer beneath it. Note that bedroom bays are collapsed to permit movement on the highway.



IN THIS NILES BLOCK, individual pictures of the property were taken so that owners could "match" them

M. A. JOHNSON COMMUNITY

By C.

Irwin M. Johnson, Oakland architect and member of the Northern California Chapter of A.I.A., recently embarked on a project as challenging as any a broadscale planner could receive. He has been retained by the civic and business leaders of Niles, California, to re-style their business area, comprising five blocks and embracing the major portion of the town viewed by motorists from the several highway entrances.

Mr. Johnson's commission came about when Niles leaders displayed keen interest in the subject of postwar civic face-lifting. As it works out, his efforts in behalf of Niles may be among the first tangible results of the California State Department of Education's recent campaign to stimulate community modernization. His subject is a worthy one, for Niles is not an ordinary town. It is one of California's oldest communities, with a tradition

that goes back to the days when Mexican vaqueros rode the ranges of the Southern Alameda County hills.

Niles merchants and professional men had for some time discussed the possibilities of making their town more attractive to residents of the area and visitors. They were generally acquainted with the national trend which showed radical shopping shifts when better highway transportation made it possible for buyers to travel out-of-town for wider selection and competitively-priced merchandise. They knew that to keep people of Niles and vicinity spending in Niles meant earning their patronage with facilities that compared favorably with those of neighboring shopping and service centers.

Their interest in the entire subject was brought to a peak recently when a representative of the



"After Remodelling" sketch and see just how their old buildings would be out of harmony with the new overall d

DESIGNS A UNITY

RAFT

California State Department of Education, talked to the Chamber of Commerce and leading merchants on the findings of the state Business Planning Institute. After this spark-plugging talk, a Niles Face-Lifting Committee was formed, chairmanned by L. R. Batman, the local publisher. Its members were C. W. Chrysler, E. A. Ellsworth, and the writer. Ex-officio members were D. Q. Grabill, president of the Niles Chamber of Commerce, and A. J. Petsche, secretary of the chamber.

The Niles people wisely decided that their job should be done **right** and should be so planned that the results would constitute a great civic advantage and be applauded by the citizenry. The first step along these lines was to approve the retention of an architect—and to select Irwin M. Johnson.

Mr. Johnson was delighted with the opportunity to pit his talents against the sizable and complex problem of remaking a community. He began his study by taking many photographs and among these pictures were separate views of the individual buildings and store fronts that would eventually be changed. Part of the problem, of course, was to present the face-lifting plan so that property owners and store managers would want to back the program unanimously.

It was decided by the architect to show them "before and after" effects. The individual photos were therefore arranged in block form, so that the future changes could be dramatically contrasted as the old structures were eliminated one by one.

The Spanish theme, which showed up somewhat in various parts of Niles, was decided upon by Mr. Johnson. His recommendation was warmly re-



THE NILES BLOCK shown elsewhere (in the architect's rendering of "After Remodelling") is here pieced

ceived by the civic leaders, because their home town did, in point of fact, continue early California traditions after a fashion.

In electing this theme, departure was made from the usual practice, which seems to favor streamlined "World of Tomorrow" design. For instance, a similar face-lifting project now being pushed in Burlingame, Calif., calls for remodeling a number of business blocks in ultra-modern style, on the theory that postwar merchandising will require "advanced" settings. Exponents of super-modern planning can marshal many arguments for its rightness. In the case of Niles, however, it just did not fit.

Some of the Niles business blocks were found to contain buildings that definitely were in key with this theme, as to basic structure. Mr. Johnson then decided to use such buildings as anchors for remodeling the outmoded areas in between. With this designing plan, he made graphic creative sketches of the blocks. One of these sketches is shown as an accompanying illustration. It is seen at once that Niles is not only scheduled for modernization, but that the "charm of age" will not be lost. There is no major accent on "super streamlined modernity" because this type of architecture

was deemed inappropriate for the former hacienda town. Yet the basic commercial advantages of well-lighted store interiors, broad and open fronts, and easily-entered buildings have been provided.

The materials to be used will be principally stucco, roof tile, decorative tiles, and glass. Simulations of Spanish housing and marketing structures will be secured with ease from these modern materials, when the project reaches the stage of detailed construction plans.

Although the program is generally known as face-lifting, there will be much attention given to the interiors of stores and offices. How far the merchants carry their interior plans will depend upon the individual businessman's alertness to new forces in dwelling design and merchandising. The epitome of such specialization was recently observed when a California shoe store invested up to \$10,000 to determine in advance the number and type of customers who could be expected to patronize one of its de luxe stores—and then commissioned an architect to design an interior which would best serve that style-bracketed and price-classified postwar "customer potential." It is not expected that Niles merchants will go that deeply into the subject, because the town's business



together as it actually looks "Before Remodelling." Note the anchor buildings at each end of the block.

volume is considerably smaller than that of neighboring cities. However, the merchants are keyed up to match as well as they can the over-all appeal of "competition down the highways" (in both directions, in the case of Niles!).

In their own "early California way," Niles people expect to create a pleasing civic personality. They intend to give Irwin M. Johnson full cooperation in reaching the goal. If it is possible to create a "Niles character" in the minds of shoppers in a wide radius, even to including motorized shoppers from the metropolitan centers north and south of the town, this is expected to be done — through specialization and novelty presentation of items peculiar to the area, i.e., foodstuffs, fruits, products of the vineyard.

Noteworthy is the fact that this small-community group has accepted the axiom that "towns and cities never stand still;" that they go forward or go into decay, particularly when combatting the competition of broad highways. Farther back in the minds of these men is the possibility, though some regard it as extremely remote, that the coming "atomic and air age" may bring about population shifts of a character favorable to more spectacular growth of Niles.

The action by Niles leaders is in its own way exactly in line with the solid trend toward com-

munity acceptance of high standard restrictions in design. The creation of Westwood Village in Southern California in the past decade is an example of community achievement which has benefited merchants through establishing a definite character of locale. Berkeley Chamber of Commerce is also advocating remodernization of downtown business buildings and the goal there is to increase the new, large volume of shopping which came to the University City during the war years. Burlingame's face-lifting is among the first of the large-scale postwar efforts resulting from the stimulation by the California State Business Planning Institute.

For the reader who may be specifically interested in how the Business Planning Institute cooperates in developing community interest in any California town or city, the State of California Department of Education at Sacramento will supply a manual, speakers, and counsel upon request. The men identified with this agency appear to be expert in their subject.

Some of the other firms cooperating with Business Institute are General Electric, Westinghouse Electric, Sylvania Electric, the Kawneer Company, Pittsburgh Plate Glass, Libbey-Owens-Ford, National Cash Register, Pacific Gas and Electric, Pacific Coast Advertising Association, and Bank of America.



HOME OF FLOYD McCALL, Denver, Colorado *Margaret McKay Tee, Decorator*

The Personalized Modern House

By MARGARET MCKAY TEE, Colorado

Interior Decorator and Designer*

That we live in a widely changing world is no longer a surprising idea, but that these many changes may eventually reduce us to a highly mechanized, push button, postwar style as our very intimate background for living has not been so well considered.

The things we may do to keep this potential "Frankenstein" from gobbling us up in soul as well as body, must be carefully studied and thoroughly practiced by the real home maker.

While it is granted there are numerous advantages in time saving devices, washed air, modern conveniences, and speed of living in the mechan-

ized house, the important question for the average liberated American woman is, the time so saved is for what?

Today's changes therefore will not be limited to outward forms, tasks and attitudes, but will encompass a great variety of activity during newly gained time.

We need a means of expression and a channel for growth quite apart from the usual mechanics of living, and also apart from a ready-made or professionally planned beauty of surroundings.

The mannequin can never become the real woman.

**MARGARET McKAY TEE, Colorado
colorist, designer, interior decorator
and art instructor.**



**HAND HOKCED CURTAINS . . . Blue on washed muslin
showing detail of design. Margaret McKay Tee, Decorator**

THE PERSONALIZED MODERN HOUSE

The real person in order to achieve the fullest of life's opportunities, must wrestle with some phase of his environment in order to really live in it. It will take a realization of a new and personal responsibility to make us combat the mechanical perfection of our homes, for example by using and developing completely the artistic creative ability that is latent in most people.

The young men, and women, of the armed forces are setting the pace in this direction and have surprised educators by the great demand for courses in liberal and fine arts to be offered under the Veterans Educational program. This trend is no accident, but is a normal and healthful reaction from war.

Art, fine or applied, is the balancing activity of modern society.

Many people are already preparing for greater living in the postwar era by installing working studies and shops, as well as play rooms and bars in their homes. It is a somewhat modern version of olden times when the large Colonial kitchen or the Victorian front porch was the center of family activity.

It is interesting to observe, also, that the currents of style which since the founding of the American culture on the eastern seaboard of the United States a few generations ago, and subsequently, has flowed strongly from the east to the west, is definitely changing direction—from the west and southwest the warm, leisure trade winds are slowly but surely blowing away some of the traditional style customs inherited from the cold and damp lands of Europe.

With this change of basic style direction is coming a warmer and freer living trend, one replete with space and color and one which produces lower, simpler and smaller houses, permitting the introduction of new landscaping techniques as an outdoor family activity.

Numerous new and heretofore unheard of products will soon be on the market. Some will be adaptations of military origin for civilian use, others will utilize the ever expanding domestic service of gas and electricity, including appliances and new and strange lighting. These factors with

new building material, glass products, sunshine, and airiness will all have an effect on our way of life.

The most conservative mind and most prejudiced thinking must admit that the usually accepted decorative forms of palaces and formal society must pass. With the freedom of slacks and shorts must come a new background of informal materials, and with the need of such materials the way may be opened for an opportunity in art which will loosen the sometimes narrow and one-sided restrictions of applied science and thus allow a new modern applied art also to enter.

It is certain that creating the sense of personal possession is absolutely essential to the enjoyment of the house beautiful.

Channels for this development are found in water color, pastel and finger painting; the hand blocking of fabrics, pottery and hooked-rug making. Use of textile dyes for smaller fabrics, weaving and embroidering with Latin American inspiration carries on the utilization of southwestern culture, while a revival of China painting would restore an art which fell by the wayside because its artistic standards became too low. Under better leadership the art of ceramics is our most enjoyable and practical crafts open to women.

Papier maché, an extensive craft of the 18th Century, should receive more attention; photography, which is making great strides in many commercial fields, may be used for something better in the home than just decorating the mantel with family pictures; while metal and wood crafts are the most practical for home consideration, and furniture making has already become a widely practiced home art.

The range of material to work with is almost endless as most cities now have well organized craft and vocational centers under direction of competent instructors and any one of the activities mentioned in this article plus many others may be studied and thoroughly enjoyed by adults who are complete beginners in the field of art.

It is really astounding to see the avidity with which mothers and fathers of 'teen agers desert their bridge tables and cocktail bars and "take to" some applied art which awakens their creative sense and gives the hands something to do, guided by intelligent thinking.

This stirring of creative thinking and action in our land is not complete until the home is provided, not only with modernized mechanical and scientific conveniences, but also is graced by art as a working and intimate part of our every day concept of living.

* ARCHITECT & ENGINEER is fortunate in being able to publish this illustrated article by MARGARET McKAY TEE, who has an enviable record of success as a Rocky Mountain region colorist, designer, interior decorator, and art instructor. Her work has been extensively exhibited, including the American Galleries in New York by the Artist Guild of Denver, the University of Denver, the Denver Art Association and the Graland Country Day School of Denver. A comprehensive showing of Water Colors was recently exhibited at the Art Colony by the Ogden Art Guild of Ogden, Utah.—THE EDITOR.



Pietro Belluschi

Designs a Shoe Store

The design for this shoe store was conceived as an effort to exploit in a more definite and organic way the idea of the open front. This same idea has in many cases fallen short of success, because

the attention of the onlooker was divided and confused between an interior which was not designed to be seen from the sidewalk, and an exterior front which hated to lose its identity. . . .

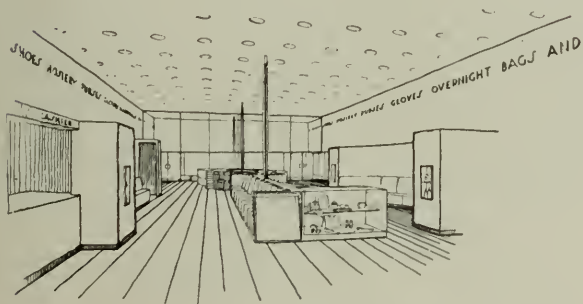

Pittsburgh Plate Glass Co. Photos

It seemed that a thoughtful use of glass, and a carefully laid out interior would show the inherent possibilities of the open front plan, and its probable impact as an advertising medium.



UPPER VIEW is the new six and one-half story building of reinforced concrete and brick construction with an area of 240,000 square feet which is being built by **THE STANLEY WORKS, INC.**, of New Britain, Conn. It will house machinery for manufacture of regular hardware lines on an expanded scale to meet postwar requirements of the firm.

LOWER VIEW shows the new six-story building of the **STANLEY Company** which is being constructed of concrete and brick to house the Stanley Electric Tool Division.



FORMS AND FUNCTIONS OF ARCHITECTURE

The first complete work in more than half a century on the principles and elements of architecture is now being written at Columbia University under the sponsorship of the School of Architecture, Leopold Arnaud, dean of the school, has announced.

The work has been tentatively titled, "The Forms and Functions of Architecture."

Talbot Hamlin, former librarian of the Avery Architectural Library and Lecturer in the Theory of Architecture at Columbia, has been named editor and is already at work. Mr. Hamlin will write some of the text himself while the sections on building types will each be written by a recognized expert in the field. The complete list of contributors will be announced in the near future.

Although no definite date has been set for publication, the work will be published in three volumes by Columbia University Press as soon as possible after the completion of the writing. It is anticipated that the three volumes will run to about 300,000 words, and will be fully illustrated.

In order to make this project representative of the best thought in the architectural profession, Dean Arnaud, as chairman, has named the following advisory board: Turpin Bannister, dean of the School of Fine Arts, Alabama Institute of Technology; Jean Labatut, Professor of Architecture, Princeton University; John C. B. Moore, architect, and Morris B. Sanders, architect and industrial designer, both of New York City.

"The architecture of today is no longer revolutionary," Dean Arnaud pointed out in announcing the beginning of the work. "Contemporary design in buildings has been sufficiently established, and has developed over a long enough period, so that its elements and principles can be studied and evaluated. Its place in the continuing stream of architectural tradition is assured; its relationships to the basic problem of architecture—the integration of use, structure and beauty—is clear.

"The time thus seems ripe to produce a work for architects and architectural students which will do for the architectural elements, the principles of design, and the building types of today what Julian Guadet did for the eclectic architecture of 50 years ago in 'Elements and Theory of Architecture.' The School of Architecture of Columbia University, realizing this, has undertaken to prepare such a work."

Guadet's four volume work was published in French in 1894, based on lectures which he began giving as early as 1872. Since then there has been no comparable work and Guadet's volumes have not been revised.

FIRST MULTIPLE QUONSET HOUSES LITTLE GIANT, INC.



GROUND BREAKING near Hayward, California, recently for multiple quonset home of Little Giant, Inc., washing machine manufacturers. Taking part in the ceremony, left to right, is C. W. Kraft, Kraftile Company; G. D. Hecker, Jr., and H. F. Keefe of Little Giant, Inc.; and H. A. Plemmons, Hayward Chamber of Commerce.

In Hayward, California, recently, civic officials joined with executives of the Little Giant washing machine company in ground breaking ceremonies dedicating the first multiple arch Quonset "package" steel building to be erected in northern California.

The multiple Quonset solved a postwar emergency manufacturing problem for the company who found their Oakland plant too small to cope with postwar plans embracing new models and a stepped-up sales and service schedule. Confronted by national construction stoppage orders the "packaged" steel building was decided upon which permitted immediate construction and did not employ any of the materials critical to the nation's Veterans' Housing Program.

According to C. W. Kraft, president of the Kraftile Company of Niles, California, manufacturer and distributor of building materials, the multiple Quonset design is unique in its flexibility as the building can be as large as the user desires. Increased widths are possible through increases in increments of 20 feet 6 inches and lengths are increased in increments of 20 feet.

The sheet steel exterior is nailed directly to the Stran-Steel framing by use of patented nailing grooves in the arch ribs.



ENTRANCE TO EXHIBIT at office of RUSSELL GUERNE de LAFPE, Architect, A.I.A.

A Veterans' Housing Cooperative Plan

Sponsored by the American Veteran Committee
San Francisco-Oakland Area

By JULIUS M. KELLER

Much has been written about the present housing shortage. Our legislators and our Congressmen have talked about it for months. Radio commentators, editorial writers and other verbal artists have deplored the situation. Still we have no adequate housing. One year has passed since V-E Day, many months have passed since V-J Day, and only recently did Congress finally pass legislation which may aid the veteran to secure some relief.

In the meantime, the cost of inadequate housing has jumped fourfold. Real estate speculators have reaped profit upon profit by the sale and resale of below standard housing. Jerry-built-cracker-boxes, newly constructed, are being foisted upon the house-parched veteran at prices that should build him a substantial home and even

these are scarce. The greater number of veterans is unable to secure any type of living accommodations for himself and for his family.

The present situation is fraught with this danger: The veteran needs a place to live; he must establish his family in a permanent or, at least, a semi-permanent home. Hence, he will take whatever is offered, regardless of its value, and no matter whether or not he is mortgaging his future by burdening himself with a home which has all the potentialities of becoming a slum, at a price which should have purchased him a well built home in a well planned community.

Some few months ago, the San Francisco Bay Area Council of the American Veterans' Committee, a World War II veterans' organization, realized this situation. It was seen that what was

needed was not only an immediate temporary housing, but more important, a long range program to secure for the veteran a decent home at a price he could afford to pay. A home that would, in the future, be a source of good living, and give to the ex-serviceman the pride of ownership of a decent well-constructed place to live in a well planned community. The American Veterans' Committee believed that it could actually do very little about the immediate housing needs—that Municipal, State and Federal Governments must take care of the present emergency and provide temporary shelter for its returning service people. It was further believed that if the veteran thought that in the not too distant future he could, within his earning capacity, be assured of owning a better home in a better community, the effect would be that he could more easily tolerate his present inadequate shelter and would not be so quick as to grasp the first offered three thousand dollars that was being offered to him for eight thousand or more dollars.

Background

A committee representing all of the San Francisco Bay Area American Veterans Committee Chapters was called to determine what, if anything, could be done about the situation. As a result of this meeting, it was determined that if decent housing was to be secured, at a reasonable price, that the only method by which this could be done was under the cooperative plan of organization.

A study was made of the Taft-Wagner-Ellender Act pending in the Congress of the United States, and also of the financing possibilities under the

G.I. Bill of Rights. A further study was made of available land sites and building materials. An architect, by the name of Russell de Lappe, was consulted. A study was made of the California statutes regarding the incorporation of cooperatives and of the corporation security regulations.

The Basic Plan

As a result of these studies, the following plans were evolved:

It was decided to organize ourselves into a Cooperative Corporation, under the laws of the State of California, to be known as the Veterans Housing Cooperative, Incorporated. Prior to incorporation, however, to secure from one hundred interested people pre-incorporation subscriptions agreements, under which they would agree to subscribe to at least one share of stock at fifty dollars per share, and upon securing signatures from the one hundred people, to effectuate the incorporation of the cooperative.

The five thousand dollars thus raised from the original incorporators to be used for the purpose of securing options on available land sites, hiring a permanent building and community manager, and to defray the costs of incorporation.

The original one hundred share holders are to organize themselves, elect a Board of Directors, and officers for the proper operation of the corporation. Prior to the time that any options on lands were to be taken there to be a vote as to which project should first be started.

It is contemplated the cooperative should build four projects, one on each side of the four sides of the San Francisco Bay and to comprise not less than fifteen hundred homes.

Portion of American Veterans' Housing and General Planning Exhibit — on display in the offices of Russell Guerne de Lappe, A.I.A., Claremont Hotel, Berkeley, California.

Emphasis is placed on living conveniences of the plan, plus low initial cost, and permanence.





THOUSANDS of interested people from all parts of California inspected details of the Plan as exhibited in the offices of Russell Guerne de Lappe, A.I.A., Claremont Hotel, Berkeley, California. Special provision was made for a thorough explanation by Architect de Lappe, members of his office staff and veterans.

Financing

A national question arises, how are these projects to be financed? The committee has worked out two alternative plans, known as **Plan A** and **Plan B**.

Plan A

Plan A depends upon the passage of the National Housing Act (known as the Taft-Wagner-Ellender Act, now pending in the House of Representatives). This Act passed the Senate during April, 1946. Under the proposed provisions of this Act, Mutual Home Ownership Corporations, such as here contemplated, would be able to borrow funds from the banks, which loans would be guaranteed up to ninety-five per cent by the Government. These would be forty-year, three and one-half per cent loans. Thus, upon securing an option on land, it would be possible to secure sufficient money to improve the land, and build our homes with the money borrowed from some financial institution with governmental backing.

Under this system of financing, title to all land and homes would remain in the cooperative until fully paid for, and the individual would enter into possession upon a contract to purchase. Under such an agreement, the individual would have as much right to the property as if he had actual legal title; with the same power to remodel, exchange, sell, mortgage, and use.

Plan B

Under Plan B, financing arrangements would be made by use of the financial backing given the veteran under the G.I. Bill of Rights.

After an option is secured for a tract of land, a short-term bank loan would be taken for the purchase and improvement of the land. Individual lots would then be deeded to the prospective home

owner. A loan, guaranteed by the G.I. Bill would then be secured from a lending institution. Under present conditions, it is possible to secure loans ranging up to eight thousand dollars without any down payment by the purchaser-veteran. The loan secured would pay for the original cost of the land, plus the improvement, and the erection of the home.

It is believed that under either Plan, monthly payments would not exceed \$45.00-\$50.00 per month, including gas, electricity, and principal payments; provided, our goal, of homes **not to exceed** six thousand dollars (\$6,000), is realized.

Cooperative

The cooperative method of building has many advantages. We believe that under this method, the veteran will be able to secure a well built, modern home, for the same price, or less, than he is forced to pay for the poorly constructed, unlivable, quickly built shacks, that are now offered him.

Before a single home is built, the entire community will be carefully laid out, with space left as open commons.

Advantage will be taken of mass construction methods. Either on-the-job fabrication, or for parts of houses, pre-fabrication will be used. A study is being made of new building materials such as poured concrete houses; steel girder, wire mesh, sprayed concrete construction, and aluminum instead of wood and plaster for walls. An investigation is to be made of heating, bathroom, kitchen units, pre-built at the factory.

One striking advantage of the cooperative method is that no profit, accrues to anybody. Each home owner is a shareholder in the corporation. The profit, if any, is divided among the homeowners, not the shareholders.

The two main destinations between a commercial corporation and a cooperative corporation are: In the latter each shareholder, no matter how many shares of stock he may own, has **one** vote and no more on any matter of corporative business, including election of officers; and in a cooperative the profit that may be returned to the shareholder, as such, is limited by statute to five per cent

and no more; the bulk of the profits being returned to the consumer in proportion to the amount he spends with the cooperative; which in our case, would be to the home owners.

In building these homes ourselves, we would save the profit made by the real estate subdivider, the real estate salesman, the speculator, and the development company. These profits would be made by the home-owner.

Method of Building

Since home construction is a specialized business, it will be necessary to secure the services of a competent, well organized contractor to do the main construction. However, by retaining for ourselves the sub-contracts, and limiting the profit of both the sub-contractors and the general contractors to a fair, but reasonable profit, it is believed that considerable savings can be made. The architect in charge, will have the authority and duty to supervise the letting of these contracts under the direct contract of the Board of Directors of the Cooperative, and the management of them, to see to fair treatment for all concerned.

Present Progress

To date, June 5, 1946, we have interested some seventy-five persons, who have signed pre-incorporation subscriptions agreements. No further

definite progress can be made until one hundred have been signed.

Investigation has been made of available land sites, and their availability has been tentatively ascertained. However, since the infant cooperative is in no position to take action, nothing concrete has been done.

The program was graphically shown to veterans, veteran organizations and the public, through a series of display panels prepared by Russell Guerne de Lappe, Architect, and exhibited in his offices in the Hotel Claremont, Berkeley.

Numerous advantages of community planning were emphasized as was the lasting result of home building by cooperative effort. Architect de Lappe, having had considerable experience in designing municipal buildings throughout California, and having been the architect on several large federal government housing projects during the recent war, as well as serving as a technical advisor to other large-scale housing projects, was able to show by drawing, scale models, and photographs a comprehensive picture of the project.

Recently the services of Hal Dunleavy were secured to serve as a housing consultant for the project, he having had many years of public and private practice in housing development.



DETAILS of one of the several panels of the exhibit—note model of "Polycrete" House and data in right-hand panel.



"THE SUMMIT" — Newly Developed All-Metal Home

C. L. Brum, Photo

INTERMOUNTAIN ALL METAL HOME

Convertible Homes, Inc. Entering Denver Small Home Building Field

By C. L. BRUM*

The recently formed organization of Convertible Homes, Inc. is entering the Denver and surrounding territory small home building field with production of an all metal, pre-cut, two-bedroom housing unit.

The firm, of which Denver architect and contractor Robert M. Morris is president, is offering the units, complete with plumbing fixtures, heating units and electrical fixtures and outlets, on a completely erected basis, on a site supplied by the purchaser, for less than \$4,000, or in unassembled form at the factory.

Component parts of the structure will be manufactured in the factory of Fox and Co., one of Denver's largest sheet metal fabricators. The Fox

and Co. plant produced nearly 1,000 prefabricated hospital barracks for use in the South Pacific during the war.

"The Summit," first model being shown by Convertible Homes, was created to meet the needs of the average returning veteran. It is engineered to be built of available materials, and is designed along the prefabrication lines developed and perfected by the Corps of Engineers during the war. The decision to adapt this type of construction was made after preliminary engineering experiments in the insulation qualities. Other models and a companion garage to the "Summit" will be offered at a later date when production has caught up with existing housing needs.

The shell of the 20'11" x 32'11" unit is formed by seventeen rigid steel frames anchored to the

(Continued on Page 44)

**Mr. Brum of Denver, Colorado, prepared this article special for ARCHITECT & ENGINEER to show one trend of home building in the Inter-Mountain region.—ED.*

SUPER-HIGHWAY



AERIAL VIEW of new French highway leading from Saint-Cloud to Saint-Germain, first of postwar highways projects.

FP&IS Photo

The new super-highway, which is to provide a far more direct and speedy link between Paris, Brittany and Normandy, is now nearing completion. Engineers of the project predict that, if industrial shortages do not interfere with their supplies of concrete, it should be completely open to traffic within six months.

This new route is part of a general highway plan laid out back in 1935 when French engineers tackled the problem of supplanting certain picturesque but narrow roads with miles of broad,

modern highways. To minimize traffic congestion in the Paris area, the old St. Cloud bridge, which dates back to 1566, has been made over and a 60 foot-wide vaulted tunnel has been cut through the St. Cloud Hill to permit the passage of a large volume of traffic without marring the beauty of the famous park.

At Rocquencourt near Versailles, a clover leaf intersection of six one-way lanes will keep converging traffic running smoothly.

Comments On Use of Modular Design

By CHARLES CRESSEY, Architect

Apparently, unit planning and standardization are not nearly so modern as they are commonly thought to be.

The R.I.B.A. Journal for April, 1946, has the following comments by an English architect, Henry Elder, upon his return to England from special duties in Japan.

After giving his impressions on an unexpected absence of brilliant color, prevalence of gardens, copyism in city buildings, and the light construction of dwellings, Elder refers to motives.

Here there is a faithful following of traditions in building, to satisfy traditional methods of living,

however it is interesting to examine the principles used.

For dwellings the unit planning is dominant.

The module used in Japan is based more upon human requirements than structural limitations. Thus the unit is a floor mat, the size of which is that of the space required by a Nip asleep.

With slight variations, the standard is six by three feet. As all floors are covered with mats, beyond the kitchen, planning develops around this unit and individual rooms comply in size or shape.

Thus a room is of two mat, four and a half mat, or eight mat size.

The influence goes even further since dimensional lumber follows, including prefabrication, the unit room sizes. Framing is obtained ready cut for immediate use, and this has been going on for generations.

There is, however, considerable variety, especially in roofs. The latter are untrussed and clear-span framing to permit changes of partitions. Posts are at about six foot centers and framing is unbraced, though designed to resist earthquakes and typhoons. Resilience depends upon intricate joints between timbers. Roof beams are "trsbated," to carry purlins and members in direct bearing.

Walls are largely window or door panels, with infilling walls (4 feet thick) of mud or bamboo framing.

Light depends upon passage through white paper, not glass.

Plumbing is almost absent, and primitive. Heating also is elementary and chiefly by charcoal stoves.

The general quietness in color is enhanced by the slow movement of the people.

Mr. Elder concludes, somewhat obscurely, "Since 1923, American influence in design of anti-earthquake buildings has been considerable. It is therefore highly significant that American domestic architecture appears to have been affected by Japanese influence to an even greater extent."

This may refer to "horizontal" in countryside buildings.

FHA POLICY UNDER TITLE VI

Certain elements in the present home construction cost must be considered as temporary, reports Raymond M. Foley of the FHA.

"When the Veterans' Emergency Housing Program succeeds in making materials and labor readily available, these conditions should be eliminated and the need for Title VI loans from the standpoint of cost will have vanished," he told members of the Metropolitan Home Builders Association in Chicago recently.



View of rear south yard and west wing of the Ping Yuen Chinatown Project in San Francisco.

IN THE NEWS

FHA LOANS

More than 5000 lending institutions, plus 4000 branch offices throughout the country are qualified to make real estate repair, improvement, and conversion loans which are insured by the Federal Housing Administration.

Last year some 500,000 loans were made in the amount of \$190,000,000. FHA insured loans are available to property owners for remodeling and reconversion of existing structures. In line with the Veterans' Emergency Housing Program, loans up to \$5000 may be used to provide increased housing accommodations under priority ratings.

KAISER STEEL ACQUIRES EAGLE MOUNTAIN IRON MINE

The Iron and Steel Division of Kaiser Company, Inc., have acquired the Iron Chief Mine on Eagle Mountain, Riverside County, California, from E. T. Foley & Associates of Pasadena, California.

Drilling tests by the U. S. Bureau of Mines indicate the main body of the deposit covers an area seven miles long and based upon the present capacities of the Kaiser steel plant at Fontana, this is sufficient ore to keep the mill in operation for fifty years.

HOUSING APPROVED FOR SANTA BARBARA COLLEGE

Construction of dormitories for Santa Barbara College, University of California, with a total construction program of \$470,000 has been approved by the Board of Regents, according to James Corley, U. C. Comptroller.

The Board of Regents has allocated \$235,000 from a recent appropriation totaling \$4,400,000 for dormitories on various campuses, to the Mesa campus at Santa Barbara. Matched through gifts or the issue of revenue-bearing bonds, the amount is doubled.

Within a year or two the dormitories, based on student population, will be constructed in accordance with the master plan now being completed. This plan is for a long period of development reaching toward a beautiful and efficient campus, said Corley.

The housing problem is particularly acute, and the expected influx of a great number of veterans in September will offer a situation which local and State authorities are now trying to anticipate as much as possible.

ARCHITECT

New offices of Frederick Hodgdon, A.I.A., have been opened at 670 South Lafayette Park Place, Los Angeles, for the general practice of architecture.



RIGID FRAME STEEL BUILDINGS now available out of stock for immediate delivery . . . 40' 0" — 50' 0" — 60' 0" — 70' 0" — 80' 0" — 90' 0" or 100' 0" Spans, any length. Complete with corrugated Aluminum wall and roof covering. Call for particulars.

MANUFACTURERS OF:

Fabricated Structural Steel • Steel Buildings • Bridges • Barges • Dredges • Service Stations • Plate Work • Steel Storage Tanks • Steel and Sheet Metal Products • Miscellaneous Iron • Truck Tanks • Road Machinery.

Distributors of Steel Shapes, Plates and Sheets.

The latest development in modern steel buildings...

RIGID FRAME

- Fire resistive
- Strong
- Permanent
- Economical

INDEPENDENT IRON WORKS LTD.
EIGHTH AND PINE STS.  PHONE TEMPLEBAR 0160

OAKLAND, CALIFORNIA

DENVER ASSOCIATION OF HOME BUILDERS SURVEY

A recent survey by the Denver Association of Home Builders, shows that Denver's housing shortage could be eased if materials were available to complete the 1,834 units which are now in various stages of construction.

The survey, made by contacting every active builder in the city, determined that 738 units are at a complete standstill because of lack of material and labor.

Details of the survey were sent to Wilson Wyatt and the Colorado senators and congressmen. In the letter, the builders group reported that major barriers prevented completion of the housing units. First, that actual scarcity of materials was evident, and second, the inability to obtain the materials that are available because of certain government regulations.

In their letter to Wyatt and the state representatives, the association stated that the present housing situation could best be met by completion of the homes now under construction.

The survey checkup of the 110 active builders shows that the following materials are needed to complete construction of the 1,834 units:

Face brick	5,336,334
Cinder block (backing)	785,934
Backing brick	879,934
Sash (wood and steel)	9,264
Rock lath	sq. yds. 254,044
Dry wall board	sq. ft. 1,270,222
Nails	kegs 4,428
Dimension lumber	bd. ft. 4,281,000
Rough lumber	bd. ft. 3,672,366
Finish lumber	bd. ft. 348,079
Flooring	bd. ft. 1,160,301
Doors (outside)	2,136
Doors (inside)	11,817
Siding	bd. ft. 362,300

TYLE BORD BEING MARKETED

The first allotment of TYLE-BORD, a new highly finished, plastic, enamel-coated wall board, was received by Western Asbestos Company early in June according to Clarke E. Wayland, vice president of Western Asbestos Company, exclusive distributors for "Tyle-Bord" in northern California and western Nevada.

The first limited supply is expected to be followed by regular shipments that will soon approach market demand.

"Tyle-Bord," which is manufactured in Seattle, Washington, comes in two patterns: 6-inch block pattern and 12-inch streamline. Both patterns are made in soft pastel colors of Pacific Blue, Cascade Green, Shasta White, Mission Yellow, Alaska Ivory, and Carmel Coral. Sizes 4 by 4 foot; 4 by 6 foot, and 4 by 8 foot.

Western Asbestos Company is also exclusive distributors in northern California and western Nevada for "Colotyle" Corporation and "Colotrym" Company, both affiliates of the Tyle-Bord Company.

APPOINTED CHIEF

Col. Warren E. Carey of Los Angeles has been appointed Chief of the State Master Airport Planning Staff of the California State Reconstruction and Re-employment Commission by Governor Earl Warren.

A national authority on airports and air safety, Col. Carey will direct study of ways in which California can take advantage of the \$18,000,000 allotted to the State under U. S. Senate Bill 2, which has just been signed by President Truman.

ESTABLISHES OFFICE

Leon D. Lockwood, Architect, has opened offices in the Phelan Building, 760 Market Street, San Francisco, for the general practice of architecture. He desires newest catalogues.

E. K. WOOD LUMBER CO.

WE MANUFACTURE OR SUPPLY

- DOUGLAS FIR
- REDWOOD
- SUGAR OR PONDEROSA PINE
- SASH AND DOORS
- MILLWORK
- MASONITE TEMPERED PRESWOOD
- CONCRETE FORM PANELS
- CEMENT ASBESTOS BOARD
- INSULATION AND INSULATION BOARD
- INSULATION TILE AND PLANK
- PLASTER BOARD
- FIR-TEX INSULATION PRODUCTS
- TRIPLE-SEALED GYPLAP
- SISALKRAFT BUILDING PAPER
- ROOFING
- WOODLIFE WATER REPELLENT
- MASONITE CEL-U-BLANKET

DEPENDABLE QUALITY

LOS ANGELES
OAKLAND
SAN FRANCISCO

"GOODS OF THE WOODS"

A. I. A.

American Institute



ACTIVITIES

of Architects

CALIFORNIA COUNCIL OF ARCHITECTS:

John S. Bolles, President; Robert H. Orr, Vice-President, James H. Mitchell, Secretary-Treasurer; 369 Pine Street, San Francisco 4.

Washington State Chapter:

George W. Stoddard, President; Clifton J. Brady and Joseph H. Wohleb, Vice-Presidents Stephen H. Richardson, Secretary; J. H. Dillon De Hart, Treasurer; Offices 516 Central Building, Seattle 4, Washington.

Northern California Chapter:

Andrew T. Hass, President; E. Geoffrey Bangs, vice President; John S. Bolles, Secretary; Hervey Parke Clark, Treasurer; 369 Pine Street, San Francisco 4.

Southern California Chapter:

Charles O. Matcham, President; Adrian Wilson, Vice-President John Landon, Secretary; Albert C. Martin, Jr., Treasurer; Offices 3757 Wilshire Blvd., Suite 212, Phone Filtzroy 2393 or MUtual 4592. DIRECTORS, John Rex, Paul R. Hunter, and Weldon D. Becket.

SOUTHERN CALIFORNIA CHAPTER

In his letter to the Chapter for the May "Bulletin," President Charles O. Matcham, writes: "The enactment last month of regulations over the construction industry, commonly known as 'the freeze,' by bureaucratic agencies of the federal government, has aroused such vehement discussion within the architectural profession that there is little wonder that heated arguments should have taken place at the last meeting of the Chapter when a resolution was presented directed against such usurpation of authority.

"Discussions such as these are healthy. They bring to light the thinking of the profession as a whole; they offer opportunities for open debate on subjects which are, perhaps justly, controversial."

* * *

The May meeting was a joint meeting of the Chapter and the Producers' Council. Kemper Norland, who designed a studio for Radio KFI on Mt. Wilson, discussed the architectural considerations in television studios. Drawings of the building were displayed and several other television projects were mentioned in the discussion.

C. G. Pierce, district representative, G-E Company Transmitter Division, offered two short films: "Sightseeing at Home," and the "Story of FM," radio frequency modulation.

W. V. Dent, Westinghouse Company, gave a resume of the development of television and frequency modulation.

* * *

A delegation of five French architects, officially appointed by the French Government, who are making a tour of the principal cities of the United States for the purpose of studying phases of design, planning and building, recently viewed the large scale group housing program of Los Angeles.

* * *

The "Work Shop" series of lectures under the direction of Walter R. Hagedohm are progressing

with seven members of the Chapter completing eight lectures for the Los Angeles Board of Education.

* * *

WASHINGTON STATE CHAPTER

Charles H. Alden, F. A. I. A., and Editor-in-Chief of the Chapter's "Monthly Bulletin," was called to Los Angeles recently due to illness of his brother.

* * *

Chapter members heard D. W. Carswell, district manager of Civilian Production Administration, outline provisions of restriction order on commercial buildings; and Erwin L. Weber, M.E., discuss panel heating, at a recent meeting.

Committees working on "Building Code," "Maritime Conference," "Small House Service Bureau," "Mayor's Civic Arts Committee," "Civic Arts Center Buildings," and "Public Information," indicate progress is being made on all phases of various committee activities.

The Chapter instructed its Miami Convention delegate to support a proposal of the Oregon Chapter that the 1948 Convention be held at Sun Valley.

* * *

The "Tacoma Letter" has this to say about the recent government "freeze" order on building materials:

"We wish that someone would tell people that there is a freeze order trying to make itself heard somewhere around. Most of the populace is still beating in the various doors between themselves and the members of our sober profession and popping up with the query namely, "When do we build?"

* * *

SAN DIEGO CHAPTER A.I.A. viewed the Lorimer presentation "A Scotsman Looks at Modular Coordination" at their meeting April 17. The showing was handled by our sister Southern California Chapter, co-owners of the slide film record with President Paul Keenan (W. P. Fuller & Co.) presiding over the Council half of the session.

WITH THE ENGINEERS

Structural Engineers Association of Northern California

W. Adrian, President; William W. Moore, Vice-President; Franklin P. Ulrich, Sec-Treas.; John A. Blume, Ass't. Sec-Treas.; Offices 214 Old Mint Building, San Francisco, Phone GARfield 3890. DIRECTORS, H. M. Engle, Mark Falk, and M. V. Pregnoff.

American Society of Civil Engineers San Francisco Section

Theodore P. Dresser, Jr., President; Leon H. Nishkian and Sidney T. Harding, Vice-Presidents; John E. Rinne, Secretary-Treasurer; 225 Bush Street, San Francisco 20.

Puget Sound Council (Washington) Engineering & Technical Societies

R. E. Kistler, A. I. E. E., Chairman; A. L. Miller, A.S.C.E., Vice-Chairman; L. B. Cooper, A.S.M.E., Secretary; B. A. Travis, I.E.S., Treasurer; Offices, Seattle, Washington.

STRUCTURAL ENGINEERS ASSOCIATION OF NORTHERN CALIFORNIA

Prof. F. B. Farquharson, Director of the Engineering Experimental Station and professor of Civil Engineering at the University of Washington, Seattle, was the guest speaker at the regular monthly meeting of the Structural Engineers Association of Northern California in San Francisco on May 7.

He has made a five-year study of the Tacoma-Narrows Bridge, of its failure and the causes of the failure, and in an address, "Some Problems Involved in Designing a Suspension Bridge to Withstand Wind Action," advanced some corrective theories of his own. Newsreel films of the actual failure of the Tacoma Bridge were shown.

Following collapse of the bridge small scale models were made at the University of Washington and with the use of wind tunnels actual wind conditions which caused the bridge to fall were reproduced. These experiments were shown in motion pictures and lantern slides, enabling the engineers to see what actually happened when the wind blows at different angles and velocities.

Prof. Farquharson then explained his theory for the dampening of the vibrations of suspension bridges.

Discussions were led by Frederick W. Panhorst, Bridge Engineer, Department of Public Works for the State of California; Norman Raab, Steward Mitchell, Leon H. Nishkian, and Sidney Bambereger.

The meeting was presided over by Mark Falk, Director of the Structural Engineers Association of Northern California. Reports were made by Alvah Raymond, Construction Analyst, on the work of the Civilian Production Administration, and by O. C. Hansen, vice-president of the World Trade Center, proposed San Francisco development. Harry C. Vensano, director of public works for the

City and County of San Francisco, reported on progress of the city's new building code and requested further cooperation from the Structural Engineers, especially in the matter of lateral forces on buildings due to earthquakes.

The next meeting of the Association will be a joint meeting with the San Francisco Section, American Society of Civil Engineers. L. C. Bibber, welding engineer for the Carnegie-Illinois Steel Company will speak on the subject: "The Elements of Welded Design for Steel Structures."

LOUIS L. GRANDI, associate professor of electrical engineering at Texas A. & M., is teaching the semester in the department of engineering on the Los Angeles campus of the University of California.

IRRIGATION APPROVAL

Directors of the Lindsay-Strathmore Irrigation District, one of the oldest operating irrigation districts in California, have given final approval to a 40-year contract with the U. S. Bureau of Reclamation for the annual delivery of 30,000 acre-feet of water from the Friant-Kern Canal.

The district comprises some 15,000 acres in Tulare county and is devoted largely to the raising of oranges, olives, and grapes.

ARMY-NAVY BOARD HEARING ON S. F. BAY CROSSING

A joint Army-Navy Board will conduct a series of hearings in San Francisco about August 1, 1946, on the proposal to construct a second bay crossing from San Francisco to Alameda county.

Traffic on the present Oakland-San Francisco Bay Bridge has reached a point where it is obvious additional facilities will soon be needed.

Various types of construction are being advocated for the proposed crossing, including bridge and fill.

Members of the joint Army-Navy board include: Brigadier General Garrison H. Davidson, Colonel Edwin H. Marks, Colonel George Mayo, Commander Lewis N. Moeller, Captain F. C. Flugel, and Captain James E. Eaker.

EXPERT ON LUMBER

G. H. Collingwood, for the past six years chief forester of the National Lumber Manufacturers Association, Washington, D. C., has been appointed chief lumber specialist in the Materials Supply Branch of the National Housing Agency.

He will try and break the bottleneck of building supplies currently affecting the Veterans' Emergency Housing Program.

GOOD WOOD HOUSES

(Continued from Page 9)

items of framing lumber are customarily air-dried for several months at the mill or distributing yard. At present, however, a large part of the framing lumber is shipped as soon as cut, and the distributors take it direct from the freight car to the building site. Hence, it is nearly as green when delivered as when cut from the tree. Finishing lumber goes from the sawmill to remanufacturing plants where it is kiln-dried before it is made up into finished products. The larger, well-equipped planing mills cannot supply the demand for windows, doors, and interior finish, and plants not equipped with adequate kilns are producing these items from inadequately seasoned lumber.

When lumber dries, considerable shrinkage develops, and this shrinkage should take place before rather than after the material is assembled in a structure or finished article. Unequal shrinkage may cause the individual pieces to warp or twist, to check and split. Good seasoning practice at the mill minimizes these defects, but there is no adequate means of controlling or preventing such defects where unseasoned lumber is used in construction and the seasoning takes place after erection.

Defects that can be expected to develop in conventional construction resulting from the use of unseasoned framing lumber are principally the results of unequal shrinkage, which causes excessive and unsightly plaster cracks, distortion of door and window openings, binding of moving parts, doors that will not latch, openings and cracks that permit air infiltration, and floors that are not level. Shrinkage around chimneys, fireplaces, and plumbing pipes creates leaks and sometimes a fire hazard. Warping, twisting, checks, and splits also weaken the structure, and in some cases results in distortion of roof or walls; nails driven into unseasoned lumber loosen up later when the lumber dries. Unseasoned lumber also adds a decay hazard, particularly over basementless structures. Shrinkage of inadequately seasoned finish lumber causes open miter joints to warp and twist. Shrinkage of flooring causes open cracks between floor boards, creaking and noisy floors and stair treads. Blue stain present in exterior finish causes paint discoloration.

The defects naturally result in greatly increased maintenance costs, disfigurement that cannot be concealed, and dissatisfaction on the part of the owner with his investment. It may be expected that owners will not take pride in such homes, but will attempt to sell or dispose of them just as soon as better houses are available.

In producing prefabricated houses of wood the

Don't forget to . . .



Plan ahead for built-in telephone outlets



It's a wise economy to specify a number of telephone outlets in the houses you are building . . . even if only one telephone is all that is needed immediately.

Conduit is inexpensive to install during building . . . and built-in telephone outlets add real value to a home.



Your clients will appreciate your foresight in planning with an eye to future needs. Call or dial your local Telephone Business Office and ask for Architects' and Builders' Service.

The Pacific Telephone and Telegraph Company



GOOD WOOD HOUSES—Cont'd

same necessity for seasoned material is equally important. The parts must have practically no shrinkage from the time they are machined and assembled in shops until they are erected on the site; otherwise the units will not fit together properly. Unseasoned material does not have such stability. The covering parts of prefabricated floors and walls are generally glued to the framing members, and strong glue joints cannot be obtained with unseasoned material.

The influence of powerful agencies, both Governmental and private, will be required to get properly seasoned lumber back on the market again. It is to the interest of all agencies financing building construction to insist that the materials used be suitable for the purpose, and such agencies can play an important part in establishing suitable moisture content specifications and adequate policing to obtain compliance. It will be necessary to establish economic incentives by which it will be to the interest of manufacturers and dealers to distribute seasoned stock.

Pending the time when seasoned stock is again available the individual builders can help themselves by certain expedients that can be employed to obtain some degree of seasoning before the

building is plastered. For example: (1) Purchase framing lumber as far in advance of actual construction as possible and have it piled on stockers according to good piling practice. Sixty days for inch lumber and 90 days for 2-inch lumber will generally provide fairly well-seasoned stock. (2) Halting the construction after the building is framed, sheathed, and roofed and before it is lathed will result in comparatively rapid seasoning. It may take 60 days, however, to dry the stock to a well air-dried condition. (3) Since the vertical shrinkage of joists and plates is cumulative, there will be more evidence of shrinkage in the second floor than in the first floor of an all-frame house. On this basis, one-story houses will suffer less than two-story houses and owners might consider one-story houses when these can be made to suit their needs. (4) In some localities dry kilns can be found where the owners are willing to kiln dry stock for a fee. In a suitable kiln, framing lumber up to 2 inches thick can be adequately dried in about 1 week. (5) Order interior finish and trim from companies that are adequately equipped with dry kilns or that are in a position to obtain properly seasoned material.

Time and money expended to get dry lumber or to dry it before the house is enclosed will pay good dividends in reducing maintenance, increasing the value, and satisfaction of ownership of the completed structure.



BAXCO
CHROMATED ZINC CHLORIDE



CZC

PRESSURE TREATED LUMBER
● **PROTECTS AGAINST DECAY**
AND TERMITE ATTACK

Specify it in your home
Available through Lumber Dealers

LOS ANGELES
601 W. 5th Street
Phone Michigan 6294

SAN FRANCISCO
333 Montgomery Street
Phone DOuglas 3883

J.H. Baxter & Co.

AGENTS FOR WEST COAST WOOD PRESERVING CO. SEATTLE, WASH.

COLORADO PROPOSES STATE ARCHITECT

A proposal has been presented by several state legislators that Colorado employ its own staff of architects and draftsmen to handle the planning of construction to be done in the State.

The proposal has been offered by state representatives who claim the state would save fees on an estimated one and one-fourth million dollars in construction during the next ten years. Representative C. A. Fritts stated that a staff of an architect with possibly six assistants could be employed at a cost to the state of about \$30,000. This would mean, Mr. Fritts said, a savings to the state of about \$35,000 a year.

Roland L. Young, secretary to the state board of architect examiners, criticized the proposal by saying that he doubted the state would pay enough to hire a competent architect and that it wasn't generally understood that it required a number of specialists in each phase of construction to work on plans for modern buildings.

HEADLINE NEWS & VIEWS

The Goodyear Tire & Rubber Company have perfected for industrial use a "wire tire" which will ultimately be available for general use. A fine wire of high tensile strength is firmly bonded with rubber.

* * *

An eastern Polytechnic institute reports that of the first 1000 GI's receiving educational and vocation training only 7 per cent were interested in the building trades.

* * *

"We were told that in some building trades unions, the average age of the members was fifty years."—Prof. Harold N. Chamberlain, Troy, N. Y.

* * *

Clear, contrasty blueprints from pencil drawings comes from the application of Syton, a modified silica product, to the base paper before coating with light-sensitive materials.—Business Week.

* * *

The 9,656,000 net tons of steel ingots produced by Japan in their peak war year, 1943, could have been turned out by the steel mills of the United States in 38 days at the record rate of production in March, 1944.

* * *

The "real income" of the American people, at the start of April, 1946, was 83 cents or 17 cents on the dollar lower than a year earlier. Effect of the national coal and railroad strikes will be felt during the next few months—adversely.

* * *

"The speed with which the veterans' housing shortage can be overcome will depend on the speed with which restrictive government controls over the building industry can be related or removed."—Douglas Whitlock, chairman Advisory Board of the Producers' Council.

* * *

OPA's schedule of lumber manufacturing prices is based on a 75 per cent of maximum operating production. In other words the mills are required to do business on a 25 per cent operational loss. . . . No wonder lumber is scarce and prices are UP.

* * *

Some relief for southern California industries in need of sheet steel is seen in the new 50,000-ton-per-year mill being built in Maywood by the O'Keefe and Merritt Company, one of the larger appliance manufacturers on the Pacific Coast.



THE QUESTION BEFORE THE HOUSE

TOMORROW'S HOME will demand more electrical conveniences—an ever expanding list of new electrical appliances and improved home lighting.

Only through adequate wiring can electrical service be used to any desired extent with satisfactory, uninterrupted and economical operation.

Therefore, the question before building any house must be, "Is completely adequate wiring specified in the plans?"

Only by foreseeing the need for electrical adequacy and by providing for it in your specifications, can you be assured of thoroughly satisfied clients.

The home that is adequately wired for all present and future needs is sure to be modern for years to come, and will be worthy of your reputation as an architect.

NORTHERN CALIFORNIA ELECTRICAL BUREAU

1355 MARKET STREET
San Francisco 3, California

IN THE NEWS

OREGON BUILDING

Thirty-two private building projects aggregating an estimated cost of \$4,110,000 are planned for immediate construction, according to a report by Oregon's Postwar Readjustment and Development Commission.

A large scale building program for State institutions, aggregating more than \$9-million in estimated costs, has been drawn up by the Oregon State Board of Control and is announced by R. H. Mills, secretary.

Architects have been selected for \$5,418,000 worth of work at ten institutions, while construction projects totaling about \$3-million for which no architects have as yet been selected are planned for seven institutions.

The institutions at which work will be done, type of building, estimated cost and architect, are as follows:

Eastern Oregon State Hospital, Pendleton; Leslie D. Howell, architect, Portland; Admission hospital \$392,000 and Nurses' Home Addition, \$100,000.

State Penitentiary at Salem; Barrett & Logan, architects, Portland; Cell block, \$200,000 and Chapel remodeling \$90,000. Fairview Home, Patients' cottage, \$118,000 and Dormitory \$205,000.

Eastern Oregon TB Hospital, The Dalles; Jones & Marsh, architects, Portland; Dormitory \$110,000.

State Hospital Farm, Salem; Sutton, Whitney & Aandahl, architects, Portland; Ward building \$325,000.

State Hospital, Salem; Sutton, Whitney & Aandahl, architects, Portland; Ward building \$340,000; and Treatment hospital, Pietro Belluschi, architect, Portland, \$800,000.

Hillcrest School of Oregon, Salem; Stokes & Allyn, architects, Portland; School building \$173,000; Girls' dormitory \$150,000, and food and cold storage building \$30,000.

State Training School, Woodburn; Tom Burns, architect. Portland; School buildings, \$134,000, Boys' dormitory \$57,500, and Segregation cottage \$94,000.

School for the Deaf, and School for the Blind at Salem; Wolff & Phillips, architects, Portland; School dormitory \$250,000, and School buildings \$155,000.

C. L. HANMAN has been named Manager of Advertising and Sales Market Research for the Columbia Steel Company, San Francisco.

DOUGLAS FIR PLYWOOD

W. E. Difford, managing director of the Douglas Fir Plywood Association for the past eight years, resigned on July 1, 1946.

During his tenure with the Association Difford received national recognition for his promotion of the plywood industry and development of an all-year demand for plywood products.

Harrison Clark of Tacoma, Washington, assistant to Difford, has been named acting managing director by the Association's management committee.

W. P. DAY & ASSOCIATES, Architects and Engineers, have moved to 111 New Montgomery St., San Francisco.

APPLIANCE SERVICE CENTER

At Dallas, Texas, the General Electric Company's Appliance & Merchandising Department is establishing a combined appliance service center and attic ventilating fan factory in a 15,000 square foot building.

It is the Company's first appliance repair station in the southwest; will handle the servicing of small G-E appliances, and will stock a full line of parts for all G-E appliances.



LOS ANGELES
—●—
OAKLAND
SAN FRANCISCO

IN THE NEWS

NAMED ARCHITECT

Arthur Cobbledick, Palo Alto, California, architect, has been named landscape architect for the San Mateo County Fair Association and will work out building interiors as well as landscaping of the grounds.

SMALL BUSINESS

A Small Business Division has been created in the Reconstruction Finance Corporation to serve small business in view of their importance to the national economy, full employment and full production.

PLYWOOD SUBSIDY

Premium payments on peeler logs needed for the manufacture of plywood will amount to \$400 million in a plan announced by the NHA to stimulate production of plywood products for veterans' housing.

NEW WARDEN VALVE

Instantly shuts off flow of any fluid when pressure drops below predetermined level thereby protecting against pressure drops or ruptured pipe lines.

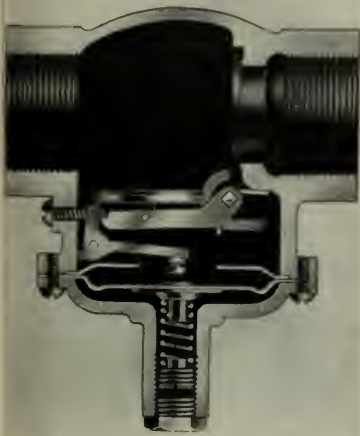

Easily installed in gas or oil supply lines for industrial furnaces, institutional heating plants, public utility supply systems, the new Warden Valve (manufactured by the Security Valve Company of Los Angeles) is available in sizes 1/2" to 8" diameter.

CHAS. W. ELIOT, Landscape architect, has moved into new offices at 720 S. San Rafael Avenue, Pasadena 2, California.

The ROCKET

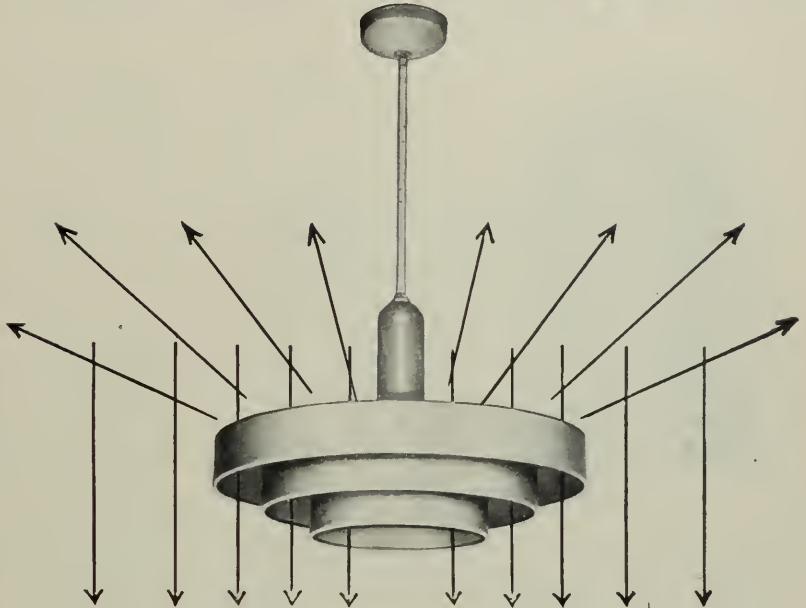

An improved principle in indirect lighting, providing a minimum of interference to the normal wide light distribution from a silvered bowl lamp, and minimum interception of reflected light. The three concentric, satin-aluminum finished flanged steel rings are set in rigid assembly that can't support dirt, paper wads or insects. Ideal for schools, offices, commercial installations. Write for bulletin and prices.

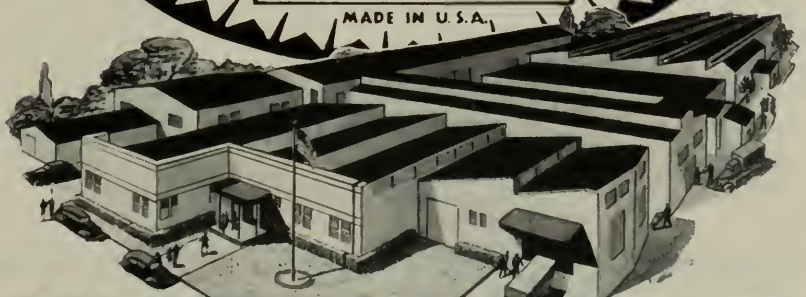
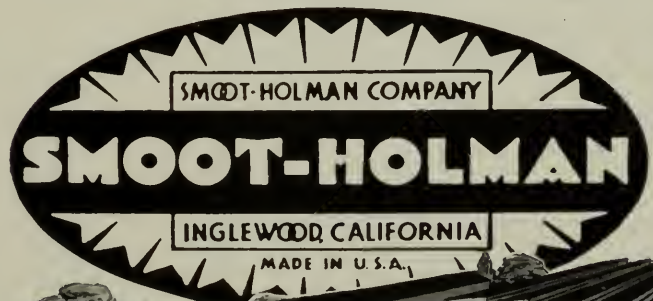

Offices in Principal Western Cities—Branch and Warehouse in San Francisco

PRODUCER'S COUNCIL PAGE

The National Organization of Manufacturers of Quality Building Materials and Equipment
affiliated with THE AMERICAN INSTITUTE OF ARCHITECTS

President, E. E. CATHCART
Johns-Manville Sales Corp.
116 New Montgomery St.

Vice-President, C. J. NICHOLAS
Bastian-Morley Co.
301 Brannan St.

Secretary, H. C. GALITZ
Westinghouse Electric Corp.
110 Sutter St.

Treasurer, E. P. LARSON
Celotex Corp.
675 Townsend St.

Edited by C. W. KRAFT, KRAFTILE CO., Niles, California

NORTHERN CALIFORNIA CHAPTER



Floyd E. Jennings

Meet another new member of the Chapter, Floyd E. Jennings, representing new Council member Ceco Steel Products Corp. Floyd saw the light of day on a farm near Ord, Nebraska, graduated from the University of Nebraska, noted in the middle west for its hard-driving "Cornhusker" football teams. He came to California from Kansas City, Missouri, to

open Ceco's San Francisco office in 1928 when people weren't beating down his door to get reinforcing steel. As steel fabricators Ceco also makes steel windows, steel joists, roof decks, metal frame insect screens and weatherstrip. Floyd heads up sales in this area as District Manager.

He is married, has a sixteen-year-old son, lives in Burlingame and particularly enjoys fishing.

CHAMBERLIN COMPANY of America, sporting two interested and active men in Council affairs, F. W. "Ted" Morse, Past-President of the Council and Frank E. Sansom, who has served as Vice President among many other duties, honored us with their presence at our May meeting upon the occasion of installing V. R. "Rev" Reynolds as San Francisco Branch Manager. "Rev" transferred from a similar position in Atlanta where he served as President of the new Atlanta Council Chapter. We will get better acquainted with "Rev" in another issue.

CORRECTION. The June meeting on "Packaged Kitchens" was put on through the courtesy of the American Central Manufacturing Corp. instead of the Norge Division of the Borg-Warner Corp. as previously announced. Both are new Council members represented locally by Leo J. Meyberg Co.

MODULAR COORDINATION IN SWEDEN. A very small one family house costs at least \$5,000 in Sweden. The annual income for an industrial worker is about \$1,000. This leads to difficulty in supplying houses for workers, particularly in industrial areas. As one means for reducing the cost of housing, the Swedish government collaborating with their standards Association is developing a system of dimensional coordination based on a ten centimeter module (3.937" or less than one-sixteenth difference from the 4" module).

Their time studies on Modular Masonry indicate, subject to further analysis, an approximate 40 per cent reduction in cost of field erection.

MODULAR MOMENTS

Question: Isn't the modular system a complicated affair involving fractions and radical new techniques?

Mr. Lorimer: No. In fact that is quite the reverse of the reality. According to architects who have adopted it the use of the modular system is simple, will not require any basic change, in the architect's present practices, except to simplify them and make them less costly.



USE QUALITY PRODUCTS



CONSULT AN ARCHITECT

IN THE NEWS

ARCHITECT FOR INSURANCE COMPANY

G. Harmon Gurney, New York City architect, has been named Chief Architect of the Housing Department recently established by the New York Life Insurance Company.

Establishment of a Housing Department was due to the increasing volume of work and growing importance of the Company's contemplated housing program, which already includes two projects under development. One is a 3,000 apartment unit on a 141 acre site at Queens, N. Y., and the other is a 150 apartment unit at Princeton, New Jersey.

KRAFTILE

To accommodate the increased activities of its stepped-up postwar program, office space is in the process of being doubled at the Niles, California, headquarters of the Kraftile Company, it was announced this week by C. W. Kraft, president of the building materials manufacturing and distributing firm.

"Our sales activity in many lines, including Quonset packaged steel buildings, has expanded rapidly and we have urgently needed the space," said President Kraft. He disclosed that Chester Root, architect, of the firm of Higgins and Root, San Jose, had been retained to design the larger office as a practical display of certain Kraftile products, including the adaptation possibilities of a standard Quonset model. According to the architect's plans, a Quonset "20" building is being erected on a 30-inch high brick wall and the present office structure is being incorporated into the over-all design by means of a brick and plate glass front.

RADIANT HEATING DISCUSSED

J. A. Cutler, president of the Johnson Service Company, Milwaukee, Wisconsin, manufacturers of automatic temperature control systems, recently told a group of engineers that the problem of applying automatic control to radiant heating systems has been solved.

Controlling space temperatures where heat emanates from pipe or tubing coils embedded in the floors, ceilings and walls is now possible through use of what Mr. Cutler terms DUO-STAT, which is a weather-compensated heat control.

Indefinite periods of temperature adjustment, due to atmospheric changes, are eliminated by the new instrument which readily records any exterior or interior heat variations.

FORMERER CORNICE WORKS

Manufacturers of

Hollow Metal Products • Interior Metal Trim
Elevator Fronts and Cabs
Metal Plaster Accessories • Sanitary Metal Base
Flat and Roll Metal Screens
Metal Cabinets • Commercial Refrigerators

269 POTRERO AVE.

SAN FRANCISCO, CALIF.

HEMLOCK 4100

STRUCTURAL STEEL

For Class A Buildings,
Bridges, etc.

JUDSON PACIFIC - MURPHY CORP.

1200 SEVENTEENTH STREET

SAN FRANCISCO

Plants: San Francisco - Oakland

SISALKRAFT

REG. U. S. PAT. OFF.

"More than a building paper"

THE SISALKRAFT CO.

205 West Wacker Drive

Chicago, Ill.

55 New Montgomery Street

San Francisco, Calif.

BASALITE

LIGHTWEIGHT CONCRETE
BUILDING UNITS

CHARACTER • ECONOMY • INSULATION
FIRE-SAFE • TERMITE PROOF • PERMANENCE

BASALT ROCK CO., INC.

NAPA, CALIFORNIA



Schools have learned the lesson of health-safety. Architects and school officials know there is one solution to the problem, insolar as drinking water is concerned . . . Halsey Taylor Drinking Fountains.

There is a type for every need, each with the original patented automatic stream control and two-stream projector. Write for catalog illustrating and describing the complete Halsey Taylor line for school installations.

THE HALSEY W. TAYLOR CO.,
WARREN, OHIO
West Coast Plant
Redlands, Calif.



**HALSEY
TAYLOR**

DRINKING FOUNTAINS

NEWS AND COMMENT ON ART

(Continued from Page 8)

this year, the acquisition of "St. John the Baptist" goes far towards giving San Francisco a truly representative collection of the works of the greatest masters of art.

The new painting came from the collection of Consul Felix Schlayer of Madrid and was formerly in the Convent of the Barefoot Carmelite Nuns of St. Joseph in the Province of Ciudad Real, Spain.

CALIFORNIA SCHOOL OF FINE ARTS

Whitney Atchley, noted eastern designer and ceramist, has joined the Summer faculty and will instruct day and night classes in ceramics. The six-week Summer Session will open June 24th.

"ART SURVIVES THE TIMES" STORY OF FRENCH ART

The revitalization of French culture, long inhibited by the Nazi occupation, is vividly documented in "Art Survives the Times," a one-reel black and white motion picture recently acquired from Les Actualites Francaises by Film Producers, Inc., of New York.

Keyed for better international understanding, art appreciation and the study of French culture, the picture is a vivid documentation of the creative life being restored in France today.

M. H. DeYOUNG MEMORIAL MUSEUM

A special course of four free lectures in art criticism is being given on Saturday afternoons at 3 o'clock by Charles Lindstrom, director of education.

Two of the series have already been given, "Vulgar Art and Fine Art" and "False Values," while the remaining lectures "Practical and Contemplative Vision" and "Art Judgment" will be given on June 15 and June 22, respectively.

AMERICAN ASSOCIATION OF MUSEUMS

Grace L. McCann Morley, San Francisco, has been elected President of the Western Branch of the American Association of Museums, after having served four years on the council.

The Western Branch covers a large part of Oregon, California, Washington, Nevada and Idaho.

ENGINEERING HEAD

H. L. Beohner and A. D. May have been appointed Technical Manager and Chief Mechanical Engineer respectively of the Permutit Company, New York water conditioning firm.

DESIGNED TO USE

In the development of your business . . . now and in the postwar era.

Many subscribers to **Architect's Reports** find these **ADVANCE** building surveys . . . giving name of project, location, architect, proposed cost and other pertinent information a "must have" service to their business planning.

Data furnished you **DAILY** at a cost of \$10 per month.

Phone EXbrook 7182 — Subscribe Today

ARCHITECT'S REPORTS

Published Daily by

ARCHITECT and ENGINEER, Inc.

68 Post Street, San Francisco

EXbrook 7182

ESTIMATOR'S GUIDE

BUILDING AND CONSTRUCTION MATERIALS

PRICES GIVEN ARE FIGURING PRICES AND ARE MADE UP FROM AVERAGE QUOTATIONS FURNISHED BY MATERIAL HOUSES TO SAN FRANCISCO CONTRACTORS. 2 1/2% SALES TAX ON ALL MATERIALS BUT NOT LABOR

All prices and wages quoted are for San Francisco and the Bay District. There may be slight fluctuation of prices in the interior and southern part of the state. Freight cartage, at least, must be added in figuring country work.

BONDS—Performance—\$10 per \$1000 of contract. Labor and materials, \$10 per \$1000 of contract.

BRICKWORK—

Common Brick—Per 1M laid—\$50.00 to \$60.00 (according to class of work).
 Face Brick—Per 1M laid—\$120 to \$150 (according to class of work.)
 Brick Steps—\$1.60 per lin. ft.
 Brick Veneer on Frame Bldg.—Approx. \$1.30 per sq. ft.
 Common Brick—\$19.00 per M, truckload lots, f.o.b. job.
 \$19.00 per M, less than truckload, plus cartage.
 Face Brick—\$40 to \$80 per M, truckload lots, delivered.
 Cartage—Approx. \$4.00 per M.

BUILDING PAPER—

1 ply per 1000 ft. roll..... \$3.50
 2 ply per 1000 ft. roll..... 5.00
 3 ply per 1000 ft. roll..... 6.25
 Brownskin, Standard, 500 ft. roll..... 5.00
 Sisalkraft, 500 ft. roll..... 5.00
 Sash cord com. No. 7..... \$1.20 per 100 ft.
 Sash cord com. No. 8..... 1.50 per 100 ft.
 Sash cord spot No. 7..... 1.90 per 100 ft.
 Sash cord spot No. 8..... 2.25 per 100 ft.
 Sash weights, cast iron, \$50.00 ton.
 Nails, \$3.42 base.
 Sash weights, \$45.00 per ton.

CONCRETE AGGREGATES—

The following prices net to Contractors unless otherwise shown.
 Gravel, all sizes—
 \$1.95 per ton at Bunker; delivered\$2.50

	Bunker	Del'd
Top Sand	\$1.90	\$2.50
Concrete Mix	1.90	2.45
Crushed Rock, 1/4" to 3/4"	1.90	2.50

Crushed Rock, 3/4" to 1 1/2"	1.90	2.50
Roofing Gravel	2.25	2.80
River Sand	2.00	2.45

Sand—

River Sand	2.00	2.45
Lapis (Nos. 2 & 4)	2.85	3.15
Olympia (Nos. 1 & 2)	2.85	3.10
Del Monte White84c per sack	

Cement—

Common (all brands, paper sacks), carload lots, \$2.42 per bbl. f.o.b. car; delivered \$2.72.
 Cash discount on carload lots, 10c a bbl., 10th Prox.; less than carload lots \$3.20 per bbl. f.o.b. warehouse or delivered.
 Cash discount 2% on L.C.L.

Atlas White	} 1 to 100 sacks, \$2.50 sack warehouse or del.; \$7.65 bbl. carload lots.
Calaveras White	
Medusa White	

Forms labor average \$350 per 1000 sq. feet.
 Average cost of concrete in place, 50c per cubic foot, exclusive of forms; \$15.00 per cubic yard. With forms \$1.60 per cubic foot.

DAMP-PROOFING and Waterproofing—

Two-coat work, \$3.50 per square.
 Membrane waterproofing—4 layers of saturated felt, \$7.00 per square.
 Hot coating work, \$2.50 per square.
 Medusa Waterproofing, \$3.50 per lb. San Francisco Warehouse.
 Tricocel waterproofing.
 (See representative.)

ELECTRIC WIRING—\$12 to \$15 per outlet for conduit work (including switches).

Knob and tube average \$3.00 per outlet. (Available only for priority work.)

ELEVATORS—

Prices vary according to capacity, speed and type. Consult elevator companies. Average cost of installing a slow speed automatic passenger elevator in small four story apartment building, including entrance doors, about \$6500.00.

EXCAVATION—

Sand, 60 cents; clay or shale \$1 per yard.

Trucks, \$20 to \$32 per day.

Above figures are an average without water. Steam shovel work in large quantities, less; hard material, such as rock, will run considerably more.

FIRE ESCAPES—

Ten-foot galvanized iron balcony, with stairs, \$150 installed on new buildings; \$160 on old buildings.

FLOORS—

Composition Floors, such as Magnesite, 50c per square foot.
 Linoflor—2 gages—\$1.25 to \$2.75 per sq. yd.
 Mastopave—90c to \$1.50 per sq. yd.
 Battleship Linoleum—available to Army and Navy only—1/8"—\$1.75 sq. yd.
 3/8"—\$2.00 sq. yd.
 Terazzo Floors—50c to 70c per sq. ft.
 Terazzo Steps—\$1.75 per lin. ft.
 Mastic Wear Coat—according to type—20c to 35c.

Hardwood Flooring—

Standard Mill grades not available.
 Victory Oak—T & G
 3/4 x 2 1/4".....\$143.25 per M. plus Cartage
 1/2 x 2"..... 122.00 per M. plus Cartage
 1/2 x 1 1/2"..... 113.50 per M. plus Cartage
 Prefinished Standard & Better Oak Flooring
 3/4 x 3 1/4".....\$180.00 per M. plus Cartage
 1/2 x 2 1/2"..... 160.50 per M. plus Cartage
 Maple Flooring
 3/4" T & G Clear \$160.50 per M. plus Ctg.
 2nd 153.50 per M. plus Ctg.
 3rd 131.25 per M. plus Ctg.
 Floor Layers' Wage, \$1.50 per hr.

GLASS—

Single Strength Window Glass.....20c per ft.
 Double Strength Window Glass.....30c per ft.
 Plate Glass, under 75 sq. ft.....\$1.00 per ft.
 Polished Wire Plate Glass..... 1.40 per ft.
 Rqh. Wire Glass..... .34 per ft.
 Obscure Glass..... .27 per ft.
 Glazing of above is additional.
 Glass Blocks.....\$2.50 per ft. set in place

HEATING—

Average, \$1.90 per sq. ft. of radiation, according to conditions.
 Warm air (gravity) average \$48 per register.
 Forced air, average \$68 per register.

IRON—Cost of ornamental iron, cast iron, etc., depends on designs.

LUMBER—All lumber at O.P.A. ceiling prices—

No. 1 Common.....	\$49.00 per M
No. 2 Common.....	47.75 per M
Select O. P. Common.....	52.75 per M

Flooring—

	Delvd.
V.G.-D.F. 8 & 8tr. 1 x 4 T & G Flooring.....	\$80.00
C 1 x 4 T & G Flooring.....	75.00
D 1 x 4 T & G Flooring.....	65.00
D.F.-S.G. 8 & 8tr. 1 x 4 T & G Flooring.....	61.00
C 1 x 4 T & G Flooring.....	59.00
D 1 x 4 T & G Flooring.....	54.00
Rwd. Plastic—"A" grade, medium dry.....	82.00
"B" grade, medium dry.....	78.50

Plywood—not available

	Under \$200	Over \$200
"Plyscord"— $\frac{3}{8}$ ".....	\$49.50	\$47.55
"Plywall"— $\frac{1}{4}$ ".....	45.15	43.30
3 ply— $\frac{2}{8}$ / $\frac{1}{4}$ ".....	48.55	46.60
"Plyform"— $\frac{3}{8}$ "—		
Unoiled.....	126.50	121.45
Oiled.....	127.90	122.75

Above prices delivered if quantity is sufficient to warrant delivery.

Shingles (Rwd. not available)—

Red Cedar No. 1—\$6.75 per square; No. 2, \$5.75; No. 3, \$4.45.
Average cost to lay shingles, \$3.00 per square.
Cedar Shakes—Tapered: $\frac{1}{2}$ " to $\frac{3}{4}$ " x 25"—\$8.95 per square.
Resawn: $\frac{3}{4}$ " to $1\frac{1}{4}$ " x 25"—\$10.65 per square.
Resawn: $\frac{3}{4}$ " to $1\frac{1}{4}$ " x 25"—\$10.65 per square.
Average cost to lay shakes, \$4.00 per square.

MILLWORK—Standard.

D. F. \$100 per 1000. R. W. Rustic \$100.00 per 1000 (delivered).
Double hung box window frames, average with trim \$6.50 and up, each.
Complete door unit, \$10.00.
Screen doors, \$3.50 each.
Patent screen windows, 25c a sq. ft.
Cases for kitchen pantries seven ft. high, per lineal ft., \$9.00 each.
Dining room cases, \$9.00 per lineal foot.
Rough and finish about 80c per sq. ft.
Labor—Rough carpentry, warehouse heavy framing (average), \$40.00 per M.
For smaller work average, \$40.00 to \$55.00 per 1000.

MARBLE—(See Dealers)

PAINTING—

Two-coat work.....	per yard 50c
Three-coat work.....	per yard 70c
Cold water painting.....	per yard 10c
Whitewashing.....	per yard 8c

PAINTS—

Two-coat work.....	50c per sq. yd.
Three-coat work.....	70c per sq. yd.
Cold water painting.....	per yard 10c
Whitewashing.....	8c per sq. yd.
Turpentine	\$1.03 per gal. in drum lots.
	\$1.08 per gal. in 5-gal. containers.
Raw Linseed Oil—	not available.

Boiled Linseed Oil—\$1.38 per gal. in drums. Available only to work with high priority—\$1.48 per gal. in 5-gal. containers.

Use replacement oil—\$1.86 per gal. in 1-gal. containers.

Replacement Oil—\$1.20 per gal. in drums. \$1.30 per gal. in 5-gal. containers.

A deposit of \$6.00 required on all drums.

PATENT CHIMNEYS—

6-inch.....	\$1.20 lineal foot
8-inch.....	1.40 lineal foot
10-inch.....	2.15 lineal foot
12-inch.....	2.75 lineal foot

PLASTER—

Neat wall, per ton delivered in S. F. in paper bags, \$17.60.

PLASTERING (Interior)—

	Yard
3 Coats, metal lath and plaster.....	1.50
Keene cement on metal lath.....	1.80
Ceilings with $\frac{3}{4}$ hot roll channels metal lath (lathed only).....	1.20
Ceilings with $\frac{3}{4}$ hot roll channels metal lath plastered.....	2.20
Single partition $\frac{3}{4}$ channel lath 1 side (lath only).....	1.20
Single partition $\frac{3}{4}$ channel lath 2 inches thick plastered.....	3.20
4-inch double partition $\frac{3}{4}$ channel lath 2 sides (lath only).....	2.20
4-inch double partition $\frac{3}{4}$ channel lath 2 sides plastered.....	3.85
Thermax single partition; 1" channels; $\frac{2}{4}$ " overall partition width. Plastered both sides.....	3.30
Thermax double partition; 1" channels; $\frac{4}{4}$ " overall partition width. Plastered both sides.....	4.40
3 coats over 1" Thermax nailed to one side wood studs or joists.....	1.65
3 coats over 1" Thermax suspended to one side wood studs with spring sound isolation clip.....	1.90
Note—Channel lath controlled by limitation orders.	

PLASTERING (Exterior)—

	Yard
2 coats cement finish, brick or concrete wall.....	\$1.00
3 coats cement finish, No. 18 gauge wire mesh.....	2.00
Lime—\$3.00 per bbl. at yard.	
Processed Lime—\$3.10 bbl. at yard.	
Rock or Grip Lath— $\frac{3}{8}$ "—20c per sq. yd.	
$\frac{1}{4}$ "—19c per sq. yd.	

Composition Stucco—\$1.80 to \$2.00 sq. yard (applied).

PLUMBING—

From \$100.00 per fixture up, according to grade, quantity and runs.

ROOFING—

"Standard" tar and gravel, 4 ply—\$8.00 per sq. for 30 sqs. or over.	
Less than 30 sqs. \$9.50 per sq.	
Tile, \$30.00 to \$40.00 per square.	
Redwood Shingles, \$7.50 per square in place.	
$5\frac{1}{2}$ #1-16" Cedar Shingles, $4\frac{1}{2}$ " Exposure.....	\$8.00 square

5/8 x 16"—#1 Cedar Shingles, 5" Exposure.....	\$9.00 square
4/2 #1-24" Royal Shingles, $7\frac{1}{2}$ " Exposure.....	\$9.50 square
Re-coat with Gravel \$4.00 per sq.	
Asbestos Shingles, \$23 to \$28 per sq. laid	
1/2 x 25" Resawn Cedar Shakes, 10" Exposure.....	\$10.50
3/4 x 25" Resawn Cedar Shakes, 10" Exposure.....	11.50
1 x 25" Resawn Cedar Shakes, 10" Exposure.....	12.50
Above prices are for shakes in place.	

SHEET METAL—

Windows—Metal, \$1.75 a sq. ft.
Fire doors (average), including hardware \$2.00 per sq. ft.

SKYLIGHTS—(not glazed)

Copper, 90c sq. ft. (flat).
Galvanized iron, 40c sq. ft. (flat).
Vented hip skylights 60c sq. ft.

STEEL—STRUCTURAL—

\$150 ton (erected), this quotation is an average for comparatively small quantities. Light truss work higher. Plain beams and column work in large quantities \$140 per ton.

STEEL REINFORCING—

\$100 to \$130 ton, set.

STONE—

Granite, average, \$6.50 cu. foot in place.
Sandstone, average Blue, \$4.00. Boise, \$3.00 sq. ft. in place.
Indiana Limestone, \$2.80 per sq. ft. in place.

STORE FRONTS (None available).

TILE—

Ceramic Tile Floors—\$1.00 to \$1.25 per sq. ft.
Cove Base—\$1.10 per lin. ft.
Glazed Tile Wainscot—\$1.25 per sq. ft.
Asphalt Tile Floor $\frac{1}{8}$ " & $\frac{3}{16}$ "—\$.18 to \$.35 per sq. ft. Light shades slightly higher.
Cork Tile—\$.40 to \$.75 per sq. ft.
Mosaic Floors—see dealers.
Lino-Tile, \$.35 to \$.75 per sq. ft.

Wall Tile—

Glazed Terra Cotta Wall Units (single faced) laid in place—approximate prices:
2 x 6 x 12.....\$1.10 sq. ft.
4 x 6 x 12.....1.25 sq. ft.
2 x 8 x 16.....1.20 sq. ft.
4 x 8 x 16.....1.40 sq. ft.

VENETIAN BLINDS—

40c per square foot and up. Installation extra.

WINDOWS—STEEL—

30c per square foot, \$5 for ventilators.

IN THE NEWS

ARCHITECT'S OFFICE

Angus McSweeney, A.I.A. Architect, has opened offices at 514 Mission Street, San Francisco, for the practice of architecture. He desires latest catalogues and building information.

BARN EQUIPMENT EXEMPT

Stanchions and stalls, hay or litter carriers, and milking machines may not be included in figuring the cost of new barns or remodeling jobs under the Veterans Housing order, according to an order issued recently by the Civilian Production Administration.

The order restricts expenditures on farm buildings, excluding the house, to \$1,000 except by special authorization by County Agricultural Conservation Committees.

ENLARGES OFFICES

Announcement has been made by Eckbo, Royston & Williams, landscape architects and planning consultants, of the opening of new offices at 121 Beale Street, San Francisco.

The firm is composed of Garrett Eckbo, Robert Royston and Edward A. Williams.

SITE PLANNER LANDSCAPE ARCHITECT

Civic Recreational Areas
Memorial Sites
Residential Grounds
Commercial Developments

Allan Himes Reid

244 Oxford Ave., Palo Alto
Phones: Palo Alto 2-4226
San Francisco: Garfield 5084

945 BUILDING TRADES WAGE SCALES (JOB SITES) NORTHERN CALIFORNIA

Six- and seven-hour day eliminated on all Government Work. A. F. L. - O. P. M. Agreement calls for eight-hour day.

NOTE: Predeterminations by the Department of Labor, as of July 1, 1944 (the wage-freezing date) have not yet been made in all of the counties listed. The wage scales shown are those being paid and in effect mostly by agreement between employees and their union.

CRAFT	San Francisco	Alameda and Contra Costa	Fresno	Marin	Sacramento	San Jose	San Mateo	Vallejo	Stockton
ASBESTOS WORKERS.....	1.50	1.50	1.25	1.50	1.50	1.25	1.50	1.50	1.25
BRICKLAYERS.....	1.87½	1.87½	1.75	1.87½	1.75	2.00	1.79-1/8	1.75	1.50
BRICKLAYERS, HODCARRIERS.....	1.40	1.40	1.05	1.40	1.05	1.50	1.35	1.50	1.14
CARPENTERS.....	1.50	1.50	1.50	1.43¾	1.37½	1.37½	1.43¾	1.50	1.37½
CEMENT FINISHERS.....	1.50	1.50	1.50	1.50	1.50	1.50	1.50	1.50	1.50
ELECTRICIANS.....	1.70	1.70	1.70	1.70	1.70	1.70	1.70	1.70	1.70
ELEVATOR CONSTRUCTORS.....	1.75½	1.75½	1.75½	1.75½	1.75½	1.75½	1.75½	1.75½	1.75½
ENGINEERS: MATERIAL HOIST.....	1.50	1.50	1.25	1.50	1.37½	1.62½	1.50	1.37½	1.25
PILE DRIVER.....	1.75	1.75	1.60	1.75	1.75	1.75	1.75	1.75	1.75
STRUCTURAL STEEL.....	1.75	1.75	1.60	1.75	1.75	1.75	1.75	1.75	1.60
GLASS WORKERS.....	1.40	1.40	1.12½	1.40	1.12½	1.21	1.40	1.40	1.40
IRONWORKERS: ORNAMENTAL.....	1.60	1.50	1.60	1.50	1.60	1.31¼	1.50	1.50	1.50
REINF. RODMEN.....	1.50	1.50	1.60	1.50	1.50	1.60	1.50	1.50	1.25
STRUCTURAL.....	1.75	1.75	1.75	1.75	1.75	1.75	1.75	1.75	1.37½
LABORERS: BUILDING.....	1.00	1.00	.90	.87½	.95	.90	.93¾	.90	.90
CONCRETE.....	1.00	1.00	.90	.87½	.95	.90	.93¾	.95	1.00
MATHERS.....	1.75	1.75	1.50	1.75	1.60	1.75	1.75	1.75	1.75
MARBLE SETTERS.....	1.50	1.50	1.50	1.50	1.50	1.50	1.50	1.50	1.50
MOSAIC & TERRAZZO.....	1.25	1.25	1.12½	1.25	1.15-5/8	1.12½			
PAINTERS.....	1.50	1.50	1.28-4/7	1.50	1.43	1.50	1.42-6/7	1.64-2/7	1.37½
PLEDRIVERS.....	1.54	1.54	1.54	1.54	1.54	1.54	1.54	1.54	1.54
PLASTERERS.....	1.75	1.83½	1.75	1.75	1.75	2.00	2.00	1.75	1.83-1/3
PLASTERERS' HODCARRIERS.....	1.50	1.60	1.40	1.50	1.68¾	1.50	1.75	1.50	1.50
LUMBERS.....	1.70	1.70	1.53-1/8	1.70	1.68¾	1.62½	1.70	1.70	1.50
COOFERS.....	1.50	1.50	1.25	1.37½	1.37½	1.37½	1.25	1.37½	1.37½
HEET METAL WORKERS.....	1.50	1.50	1.50	1.50	1.50	1.50	1.37½	1.50	1.50
SPRINKLER FITTERS.....	1.58	1.58	1.53-1/8	1.70	1.68¾	1.62½	1.70	1.70	1.50
TEAM FITTERS.....	1.75	1.75	1.53-1/8	1.70	1.68¾	1.62½	1.50	1.70	1.50
PHONESETTERS (MASONS).....	1.87½	1.87½	1.50	1.75	1.75	1.50	1.75	1.75	1.50
LESETTERS.....	1.50	1.50	1.37½	1.50	1.37½	1.50	1.50	1.50	1.37½

Prepared and compiled by

CENTRAL CALIFORNIA CHAPTER, ASSOCIATED GENERAL CONTRACTORS OF AMERICA

with the assistance and cooperation of secretaries of General Contractors Associations and Builders Exchanges of Northern California.

CLASSIFIED ADVERTISING

RATE: 8c PER WORD . . . CASH WITH ORDER

MINIMUM \$1.50 (3 Lines)

ARCHITECT'S REPORTS—A valuable advance news service giving building and construction information daily on projects in Northern California. Name, location, architect, proposed cost, etc., on individual slips. Ideal for securing new business leads. Hundreds of items, total monthly cost only \$10. Don't delay, subscribe today. ARCHITECT ENGINEER, Room 618, 68 Post Street, San Francisco, California. Phone DOUGLAS 311.

ARCHITECTS—A. McF. McSweeney, Architect, Room 927 Hearst Bldg., San Francisco. New offices. Desires catalogs.

BUSINESS OPPORTUNITY—A graduate ceramic engineer, 26 years experience in manufacture of face brick and building tile, wishes to contact a Building Contractor or Building Supply Company desirous of purchasing a face brick plant for own use. Will

operate same on commission per M basis. Thoroughly competent, can build new plant or recondition old, manager of brick and tile plants for last ten years. Employed at present, perfect health, age 45. INQUIRE BOX "A," ARCHITECT & ENGINEER magazine.

WANTED:—Architectural designer capable of taking charge of office, general practice. Excellent opportunity. Telephone HIGATE 6449, Oakland, California.

HOGAN LUMBER CO.

Wholesale and Retail

LUMBER

MILL WORK • SASH & DOORS

Office, Mill, Yard and Docks

SECOND AND ALICE STREETS • OAKLAND, CALIF.

Telephone GLencourt 6861

CLINTON CONSTRUCTION CO. OF CALIFORNIA

General Contractors

923 FOLSOM STREET • SAN FRANCISCO

SUtter 3440

MALOTT & PETERSON

ROOFING AND FLOORING
CONTRACTORS

20TH AND HARRISON STREETS

SAN FRANCISCO

Phone ATwater 1600

SANTA MARIA INN

SANTA MARIA, CALIFORNIA

FRANK J. McCOY, General Manager

FERNAND E. PIMENTEL, Manager

On the
Coast
Highway
between
San
Francisco
and
Los
Angeles



American
or
European
Plan
•
Old
English
Tap
Room

INTERMOUNTAIN ALL METAL HOME

(Continued from Page 26)

concrete foundation. The exterior surface is fashioned of crimped sheet metal siding. There is a four inch air space between the exterior and interior walls. The exterior siding surface is lined with heavy, waterproof building paper and the interior walls are composition boards arranged in panels. Roof insulation is provided by composition board in direct contact with the roofing panels. The unit is painted after erection and, while built as a permanent structure, can be disassembled for erection elsewhere.

The 20 x 14 living room has a sloping ceiling following the contour of the roof. The two bedrooms are 9 x 12, each with a 2 x 6 closet. The bathroom, 6 x 6, is equipped with shower stall, lavatory and water closet. Installations in the 6 x 14 kitchen include a combination kitchen sink and laundry tub, kitchen counter and shelves. The heating unit is a 40,000 B.T.U. output circulating gas heater. The automatic gas hot water heater is a 20-gallon unit.

CERAMIC SOCIETY FIELD UNIT INSPECTS NILES INDUSTRIES

Two major industries of Southern Alameda County recently came under the scrutiny of leading members of the Northern California Section of the American Ceramic Society, when the Kraftile Company plant at Niles and the Westvaco Chlorine Products Company plant at Newark played host to the inspecting field unit.

According to Graham Smith of the Kraftile Company, President of the Section, forty members of the Society studied the processing of heavy chemicals, gypsum, and magnesite at Westvaco, and then inspected the manufacture of a variety of structural building materials at Kraftile. Topping off the tour was a welcoming luncheon at the Kraftile plant.

The visit was a resumption of annual peacetime Spring field trips to view the plants and processes of member firms and other chemical industries of interest, having a bearing on construction and the veterans' housing program. Particularly interesting was the entry of the Kraftile Company into prefabrication structures with their dealership in Stran-Steel "Quonset" light weight packaged steel buildings.

OPEN OFFICES

William Koblik, Architect and Associates, announce the opening of offices at 211 California Fruit Building, Sacramento, California.

The firm will specialize in school designs, commercial, industrial, and residential architecture.

BOOK REVIEWS

COPPER TUBE FOR RADIANT HEATING. Chase Brass & Copper Co., Waterbury 91, Conn.

Booklet 71 pages designed to give the plumbing, heating and building trades information on the theory, broad principles and advantage of radiant heating and the practical problems involved in its installation. Many illustrations and designs. Non-technical language.

COLD STORAGE INSULATION MANUAL. Eagle-Picher Sales Company, Cincinnati, Ohio.

This 30-page, highly illustrated booklet contains a complete, reliable, factual presentation of the use of Mineral Wool for all types of cold storage and low temperature installations. The book is made up of three sections: (1) Characteristics of Eagle-Picher low temperature insulations, (2) Vapor barrier, and (3) Chart of temperatures and humidities.

WATERLINES. Key to Development of Metropolitan Los Angeles. Haynes Foundation, 2324 S. Figueroa Street, Los Angeles. Price 50c.

This 42-page report presents the story of past developments and the plans for new projects proposed by many different agencies, and is published under direction of The John Randolph Haynes and Dora Haynes Foundation, which has no plan of its own, but presents the plans sponsored by planning and other official agencies.

L. A. LIBRARY ACQUIRES CHAMBER MUSIC WORKS

The outstanding chamber music collection of the late Joseph Schnearer, Vienna-born physician and musician, has been acquired by the library on the Los Angeles campus of the University of California, it was announced by Dr. Lawrence C. Powell, librarian.

"This distinguished collection will supplement the great music library that came to the university a few years ago from the Federal Music Project," Dr. Powell pointed out.

Besides the works of standard composers, the collection contains chamber music by Verdi, Chopin, Rubinstein, Kornauth, Fibich, Hummel, and many others whose compositions are seldom heard.

Schnearer hoped to be a professional musician until an ear impediment forced him to switch to medicine. However, he was the friend of many Viennese musicians and his home was a distinguished chamber music salon. He came to the United States to escape the Nazis, first settling in Des Moines and later in Los Angeles.

"AMERICAN - MARSH" CONDENSATION UNIT

Pumping
Machinery
for
Every
Purpose

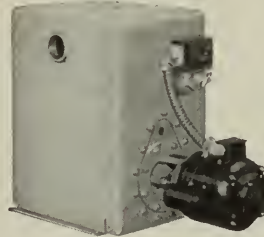

For Service
Call
DOuglas
6794
or
MUtual 8322

SIMONDS MACHINERY CO.
SAN FRANCISCO 816 FOLSOM
LOS ANGELES 455 EAST 4TH

VERMONT MARBLE COMPANY

Producers and Finishers
of
Domestic and Imported Marbles

Write for new pamphlet describing our
Marble Toilets and Showers

San Francisco and Los Angeles
San Francisco phone: SUTter 6747



The Most Complete Line of
STEELS and BUILDING MATERIALS
Made by a Single Producer



See Sweet's Catalog File or write us for
full information.

REPUBLIC STEEL CORPORATION
GENERAL OFFICES: CLEVELAND, OHIO

DENVER, COLORADO CONTINENTAL OIL BUILDING
LOS ANGELES, CALIFORNIA EDISON BUILDING
SALT LAKE CITY, UTAH WALKER BANK BUILDING
SAN FRANCISCO, CALIFORNIA RIALTO BUILDING
SEATTLE, WASH. WHITE-HENRY-STUART BUILDING

PACIFIC MANUFACTURING CO.

HIGH CLASS INTERIOR FINISH
QUALITY MILLWORK

142 SANSOME ST., SAN FRANCISCO
GARfield 7755

6820 MCKINLEY AVE., LOS ANGELES
THornwall 4196

BUILDERS EXCHANGE, OAKLAND

Real Estate Loans



F H A loans are readily available on existing homes up to 80% of the appraised value. You can buy a home and pay for it in small monthly installments like rent. For example, a 20-year loan of \$6000 would cost about \$49.56 per month, including taxes, insurance, principal and interest.

*Come in and talk with us
We can help you get the home
you want*

CROCKER FIRST NATIONAL BANK
OF SAN FRANCISCO
California's Oldest National Bank
ONE MONTGOMERY STREET
Member Federal Deposit Insurance Corporation

**Venetian Blinds
of
Metal or Wood
for
Homes and Offices**

**Installed and Serviced
by**

GUNN CARLE & CO.

20 POTRERO AVENUE
SAN FRANCISCO 3
UNderhill 5480

IN THE NEWS

ARCHITECT

Masten & Hurd, Architects, have moved into new quarters at 407 Sansome Street, San Francisco.

VETERAN LOAN PAYMENTS

Veterans who finance homes by using both a Federal Housing Administration insured mortgage and a VA guaranteed loan may arrange to have the monthly payments combined when the loans are made by the same lending institution.

PRIORITIES APPROVED

Applications for materials priorities involving 544,041 new dwelling units were approved by FHA, acting for CPA, between January 15 and May 17, 1946.

ELECTRONIC AIR FILTER

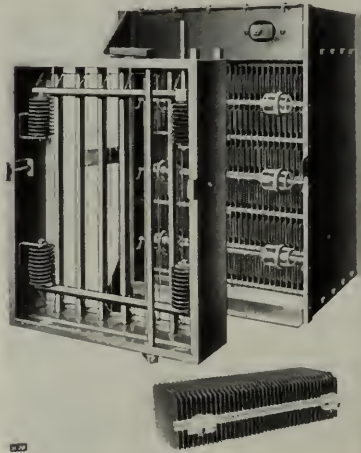

The Electric-Cell, new type electronic air filter with removable collector plate assemblies, is now being manufactured by the AMERICAN AIR FILTER CO., Louisville, Ky.

Standard sections are 2 and 3 inches in width with a capacity of 1,000 cfm per unit. As many sections as are needed are used. It is simple to install and easy to maintain as plate assemblies can be removed for cleaning and re-oiling.

ELMER F. STEIGELMAN
CIVIL ENGINEER

Structures of Steel, Wood
and Reinforced Concrete

Special Attention to
Architects' Requirements

690 Market Street
San Francisco, California
GARfield 0588

KYLE FORREST

Civil Engineer

Water Supply — Sanitation

Municipal — Private
Consultations — Investigations
Reports — Designs — Valuations
Supervision — Litigation

Ground Water Work a Specialty

Hydrologic studies — wells, de-
watering, underdrainage, founda-
tions, conservation, testimony.

1504 Russ Building
San Francisco 4
YUkon 0652

JOHN D. McLAUGHLIN

*Consulting Electrical
Engineer*

Electrical Designs
Industrial Power and
Lighting Layouts
Airport Lighting Design

SERVICES FOR
ARCHITECTS AND ENGINEERS

1641 Russ Building
San Francisco, California
Telephone EXbrook 5712

Scott Company

HEATING - - PLUMBING - - TILE



243 MINNA STREET
SAN FRANCISCO
Phone EXbrook 6741

G. P. W.
JENSEN & SON

Building Construction

320 Market Street, San Francisco

Phone: GARfield 2444

JOHN CASSARETTO
COMPANY

—Since 1886—And Still Active—

Building Materials

READY MIX CONCRETE
ROCK - SAND - GRAVEL - LIME
CEMENT - PLASTER - MORTAR
METAL LATH - WOOD LATH
STUCCO - WIRE NETTING

Service Unexcelled

Bunkers

Sixth and Channel, San Francisco

Phones: GARfield 3758 - 3760

MULLEN MFG.
COMPANY

BANK, STORE AND OFFICE
FIXTURES—CABINET WORK
OF GUARANTEED QUALITY
CHURCH SEATING

Office and Factory:

60-80 RAUSCH ST., Bet. 7th and 8th Sts.

San Francisco

Telephone UNDERhill 5815

THE TORMEY
COMPANY

GENERAL PAINTERS
AND DECORATORS

Phone UNDERhill 1913

563 FULTON STREET
San Francisco

IN THE NEWS

AGENCY MOVES

The West-Marquis, Inc., advertising agency has moved from 510 West 6th Street, to 1220 Wilshire Blvd., Los Angeles 14. The agency handles numerous accounts for leading industrial and manufacturing firms of the Pacific Coast states.

NEW "LIBERTY"
RATCHET DRILL-DRIVER

Development of the new Liberty Ratchet Drill-Driver by TECHTMANN INDUSTRIES, Milwaukee, Wisconsin, is designed for drilling between studs and joists or restricted spaces in buildings.

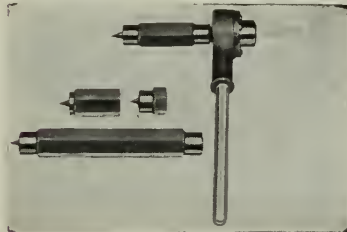

The compact head allows centering of holes within 1/4 inch of the nearest obstruction. Any standard wood bit can be used and steel drills can be used with an adapter chuck.

Any part can be readily replaced.

In actual use, holes up to 3 inches in diameter have been drilled without difficulty.

STANDARD OIL

Richmond refinery wharfing facilities will be modernized at an estimated cost of \$4,370,000. When completed the reconstructed wharf will be among the best of its kind.

GOOD CREDIT

Of the 1,144,440 home and housing project mortgages insured by the FHA during the past 12 years, only 4,083 mortgaged properties and mortgage notes have been acquired by the FHA from lending institutions. As of March 31, 1946, the FHA did not have a single property acquired under Title II in its possession.

Phone GARfield 1164

Thomas B. Hunter

Consulting Engineer

DESIGNER OF HEATING
AIR CONDITIONING
VENTILATING AND WIRING
SYSTEMS, MECHANICAL
AND ELECTRICAL EQUIP-
MENT OF BUILDINGS

41 SUTTER STREET
ROOM 710

San Francisco

California

ANDERSON
&
RINGROSE

General Contractors

320 Market Street, San Francisco

Phone GARfield 2245

DINWIDDIE
CONSTRUCTION
COMPANY

BUILDERS

CROCKER BUILDING
SAN FRANCISCO



HERRICK
IRON WORKS

STRUCTURAL STEEL
REINFORCING STEEL

18TH AND CAMPBELL STS.
OAKLAND, CALIF.
Phone GLancourt 1767

INDEPENDENT IRON WORKS

Steel Buildings
Service Stations
Steel Storage Tanks
Fabricated Plate Work
Steel & Sheet Metal Products
Fabricated Structural Steel
Steel Distributors

Eighth & Pine Sts. Oakland, 7

George F. Brayer

ELECTRICAL
CONTRACTOR

166 Seventh Street
San Francisco

Phone: MArket 1761

PITTSBURGH TESTING LABORATORY

Successors to
SMITH, EMERY & COMPANY

Testing and Inspecting
Engineers and Chemists

Structural Materials, Structures
Equipment, Pipe, Soils.

651 Howard St., San Francisco 5
EXbrook 1747

A. F. MATTOCK CO.

Builders

★

212 CLARA STREET
SAN FRANCISCO

Index to Advertisers

ALADDIN Heating Corp.	48
ANDERSON & Ringrose	47
ANGIER Sales Corporation	*
ARCHITECTS Reports	40
BASALT Rock Company	39
BAXTER & Company, J. H.	34
BRAYER, Geo. F.	48
CASSERETTO, John	47
CLARK, N., & Son	*
CLASSIFIED Advertising	43
CLINTON Construction Company	44
COLUMBIA Steel Co.	*
COLOTYLE Corporation	*
CROCKER First National Bank	46
DINWIDDIE Construction Company	47
FORDEKER Cornice Works	39
FORREST, Kyle	46
FULLER, W. P., Co.	5
GUNN, Carle & Company	46
HANKS, Inc., Abbot A.	48
HAWS Drinking Faucet Company	Back Cover
HERRICK Iron Works	47
HOGAN Lumber Company	44
HUNT, Robert W., Company	48
HUNTER, Thos. B.	47
IMPERIAL Brass Manufacturing Co.	*
INDEPENDENT Iron Works	29
JENSEN & Son, G. P. W.	47
JOHNSON Company, S. T.	*
JUDSON, Pacific-Murphy Corp.	39
KRAFTILE Company	*
KAWNEER Company	*
MALOTT & Peterson	44
MATTOCK, A. F.	48
MULLEN Mfg. Co.	47
MUELLER Brass Co.	2
NORTHERN California Electrical Bureau	35
OWENS Corning Fiberglas Co.	*
PACIFIC Coast Gas Association	Inside Front Cover
PACIFIC Manufacturing Company	45
PACIFIC Portland Cement Company	*
PACIFIC Telephone & Telegraph Co.	33
PARAMOUNT Built-in Fixture Co.	*
PARKER, Steffins & Pearce	*
PAYNE Furnace & Supply Co., Inc.	Inside Back Cover
PITTSBURGH Testing Laboratory	48
PORTLAND Cement Association	*
REID, Allan Himes	43
REMILLARD-Dandini Co.	48
REPUBLIC Steel Corporation	45
SANTA Maria Inn	44
SCOTT Co.	46
SIMONDS Machinery Company	45
SISALKRAFT Company	39
SMOOT-Holman Co.	37
STANLEY Works, Inc., The	*
STEIGELMAN, Elmer F.	46
SOULE Steel Co.	*
TAYLOR Co., Halsey W.	40
TIMBER Engineering Co., Inc.	*
TORMEY Company, The	47
UTILITY Appliance Corp.	*
U. S. STEEL	*
U. S. BONDS	1
VERMONT Marble Company	45
WESIX Electric Heater Co.	*
WESTERN Asbestos Company	*
WOOD, E. K., Lumber Company	30

* Indicates Alternate Months

REMILLARD - DANDINI Co.

Brick and
Masonry Products

★

633 BRYANT ST., SAN FRANCISCO
569 THIRD ST., OAKLAND

A L A D D I N Heating Corp.

Specializing in
QUALITY HEATING
EQUIPMENT

2222 San Pablo Avenue
OAKLAND
TWinoaks 1022

ABBOT A. HANKS, INC. Engineers & Chemists

INSPECTING — TESTING — CONSULTING
CONCRETE • STEEL • MATERIALS
CHEMICAL AND TESTING
LABORATORIES
• RESEARCH AND INVESTIGATION •

TESTS OF STRUCTURAL MATERIALS
DESIGN OF CONCRETE MIXES
SHOP AND ERECTION INSPECTION OF
STRUCTURES AND EQUIPMENT
INVESTIGATION OF STRUCTURES
AND MATERIALS
TESTS AND INVESTIGATION OF
FOUNDATION SOILS
FIRE RESISTANCE AND INSULATION
TESTS

624 Sacramento Street, San Francisco

Robert W. Hunt Company ENGINEERS

Inspection • Tests • Consultation

Schools and Other Structures
Are Built as Designed

When Construction Materials are
Inspected at point of Manufacture
and during Erection by

ROBERT W. HUNT COMPANY

Cement, Concrete, Chemical, Metallurgical,
X-Ray and Physical Laboratories

Chicago - New York - Pittsburgh
Los Angeles - All Large Cities
San Francisco, 251 Kearny Street

ARCHITECT AND ENGINEER

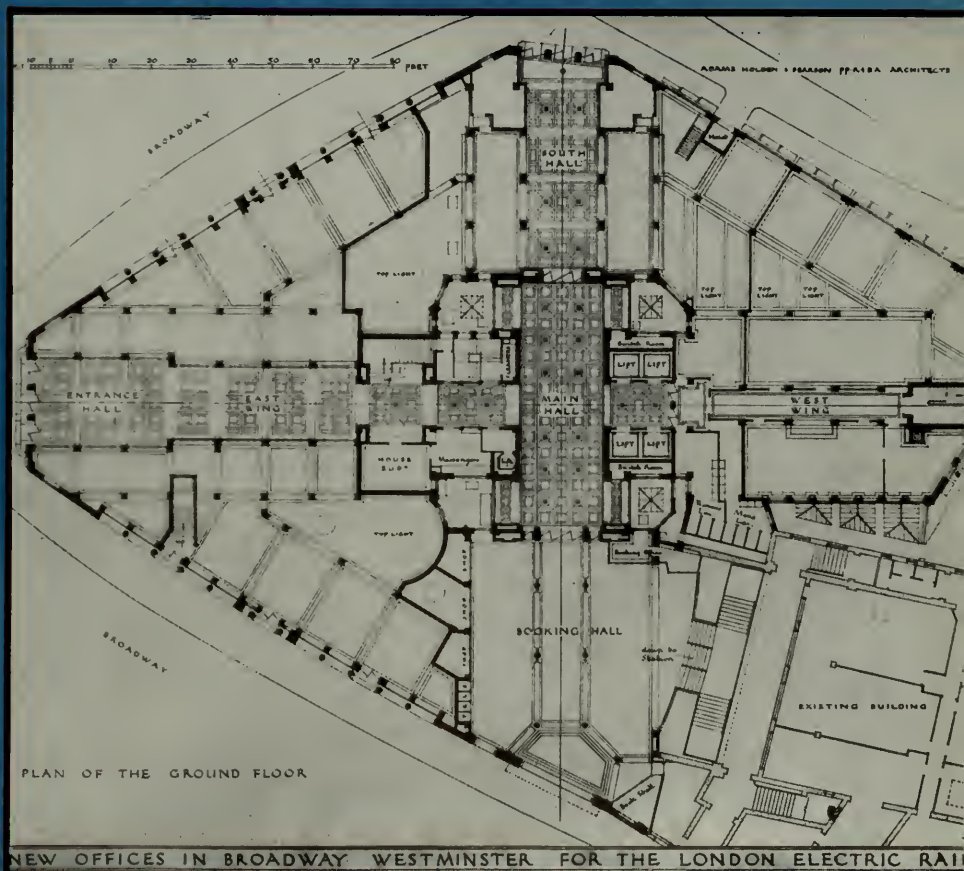

JULY

1946



... It Happened in San Francisco !

THE PROBLEM: Because executives in low-partitioned private offices of the Ray Oil Burner Company, San Francisco, had to shout to be heard above the noise of office machines in the adjoining main office, they were under a constant nervous strain.

THE SOLUTION: The company—one of the world's largest manufacturers of industrial, marine and domestic oil burners—consulted Western Asbestos Co., the Acousti-Celotex distributor and a member of the world's most experienced acoustical organization. They suggested that the block-long ceiling be covered with Acousti-Celotex, the famous perforated fibre tile that is the most widely used sound conditioning material.

THE RESULT: Management noted such an improvement that President Milton S. Rays says: "The

attractive Acousti-Celotex ceiling has hushed the noise of machines, typewriters, phone bells and voices to where it is scarcely noticeable. Our executives can now converse in their offices in ordinary tones. Office workers have become more contented, more accurate, more productive than ever before. Telephone conversations are more clearly understood."

Find out how Acousti-Celotex can solve *your* noise problem. A call or note will bring a trained expert to your desk.

WESTERN ASBESTOS CO.

Acoustical Engineers and Contractors

675 TOWNSEND STREET, SAN FRANCISCO 3, CALIFORNIA
OAKLAND • RICHMOND • SACRAMENTO



Sound Conditioning with
ACOUSTI-CELOTEX

REG. U.S. PAT. OFF.

ARCHITECT

Vol. 166

No. 1

AND ENGINEER

ARCHITECTS' REPORTS—Published Daily

Telephone DOuglas 8211

E. E. WILDER
Editor

MARK DANIELS, A.I.A.
Associate Editor

JOHN S. BOLLES, A.I.A.
Book Reviews

MICHAEL GOODMAN
Post-War Planning

L. E. NISHKAN
Consulting Editor

E. N. KIERULFF
Ass't Editor
"In the Service"



Contents for

JULY

COVER PICTURE: ST. JAMES PARK STATION, LONDON [See Page 21]

ARTICLES AND MISCELLANEOUS TEXT

EDITORIAL NOTES	4
NEWS AND COMMENT ON ART	6
SAN FRANCISCO'S PROPOSED BUILDING CODE	6
By ALBERT J. EVERS, Architect, A.I.A.	
A PROGRAM FOR URBAN PLANNING	10
SOME HEALTH HAZARDS WITH PAINT REMOVERS	11
By WALDEMAR SCHWEISHEIMER, M. D.	
HOUSING FOR THE SKYMASTERS	12
By CLIFFORD SMART, Engineer	
ARCHITECTURAL HOPES AND DIFFICULTIES IN BRITISH RE-PLANNING	16
COVER ILLUSTRATION	21
CALIFORNIA'S POSTWAR PUBLIC WORKS PROGRAM	22
A.I.A. ACTIVITIES	31
WITH THE ENGINEERS	32
HEADLINE NEWS & VIEWS	35
By E. H. W.	
IN THE NEWS	36, 37, 39, 43, 46, 47
PRODUCERS' COUNCIL PAGE	38
Edited by CHAS. W. KRAFT	
ESTIMATOR'S GUIDE, Building and Construction Materials	41
BUILDING TRADES WAGE SCALES	43
CLASSIFIED ADVERTISING	43
BOOK REVIEWS, Pamphlets and Catalogues	45
INDEX TO ADVERTISERS	45

ARCHITECT AND ENGINEER (Established 1905) is published on the 15th of the month by The Architect and Engineer, Inc., 86 Post St., San Francisco 4; Telephone EKbrook 7182. President, E. P. Kierulff; Vice-President and Manager, L. B. Fennerwood; Treasurer, E. N. Kierulff.

Los Angeles Office: Wentworth F. Green, 1709 West Eighth Street.

Entered as second class matter, November 2, 1905, at the Post Office in San Francisco, California, under the Act of March 3, 1879. Subscriptions (United States and Pan America) \$2.00 a year; \$3.00 two years; foreign countries \$3.00 a year; single copy 50c. ARCHITECTS' REPORTS are published daily from this office, Vernon S. Yellup, Manager.



EDITORIAL NOTES

TEAMWORK

Many phases of the current stress within the building industry, particularly as relates to sources of materials and supplies for construction of new homes, schools, municipal and industrial buildings, reminds us of that often used illustration entitled "Team-work" wherein is depicted two animals tied together with a rope which is of insufficient length to permit either to reach nearby food. The usual sequence of scenes show the animals developing "team-work" to the point where they eventually submerge individual desire and by working together are able to reach their objective.

Perhaps the cities of Portland and Eugene, Oregon, may be likened to the above. At least after due consideration they have "pooled" their supply of building materials and dealers with the result that objectives in the building and construction industry are being reached in these two Oregon cities.

* * *

The best way for the average American to fight inflation is to invest regularly his surplus earnings in U.S. Savings Bonds—and hold them.—Secretary of the Treasury Snyder.

* * *

CLASSIFICATION

Perry W. Swern, Chairman of the Public Action Committee of the Illinois Society of Architects, and a member of the American Hospital Association, stimulates some thinking on the subject of "Classification of Architects" in the May-June 1946 issue of the Society's MONTHLY BULLETIN.

"The recent action of the American Hospital Association and its formulization of an approved list of hospital architects coupled with efforts of the American Institute of Architects to formulate a roster of architects makes one stop, look and listen," Swern writes.

He continues "There is nothing wrong with the idea of a roster; It should have been done years ago, and if it is kept just a roster it will serve a much needed purpose. It must not in any way attempt to classify architects, group them or set one against the other.

"Fortunately The American Institute of Architects is supposed to, or is endeavoring to, represent the profession as a whole and should not take sides with any particular faction or group within or outside of its membership in the profession.

"We as architects all know that there is nothing that we can do to stop laymen, and any other organization that they may form, from passing

judgment upon the abilities and work of individual architects and we should not be disturbed when an organization like the American Hospital Association endeavors to evaluate the work of the architectural profession. It has been done in other classes of building and I do not believe any of us have been very seriously hurt by the procedure."

Mr. Swern has presented a rather broadminded view of a matter which undoubtedly has created considerable difference of opinion among members of the architectural profession.

Any "roster" or "classification" if not properly founded for the advantage of all persons involved, and if not administered with absolute equality, may easily become a serious barrier to the progress of individuals, profession, and industry, and may stimulate a breach in proper relationships between a profession and the Public.

Considerable advance study and caution should accompany any movement of this type.

* * *

The NHA has prepared a pamphlet as an aid to Veterans and prospective home buyers entitled "Before You Buy A Home", which warns of the dangers of inflation in housing prices. It contains 30 items which should be checked before buying or building a house.

* * *

GHOST TOWNS

In the interim between the Gold Rush days of '49, when mining camps sprang up throughout the West to herald the building of "cities", and the fabulous heydays of World War II, some progress was made in determining the ultimate disposition of "vacant" buildings.

The Ghost Town of the bonanza days will not be entirely repeated in Ghost Towns of the War, although it will probably take a considerable amount of elapsed time to completely erase all evidences of many wartime housing projects.

The fate of Vanport City, Oregon, whose nearly 40,000 population once made it the second largest city in Oregon, and the largest war housing project in the United States, is typical of most similar installations.

A grand total of some 9,942 housing units is slowly melting away. Only 4,039 remain. The balance have been "terminated" for re-use in other areas.

Eventually Vanport City will be entirely "terminated" and in the minds of many people will become a mythical city, but, it will never become a Ghost Town of the Gold Rush day vintage.

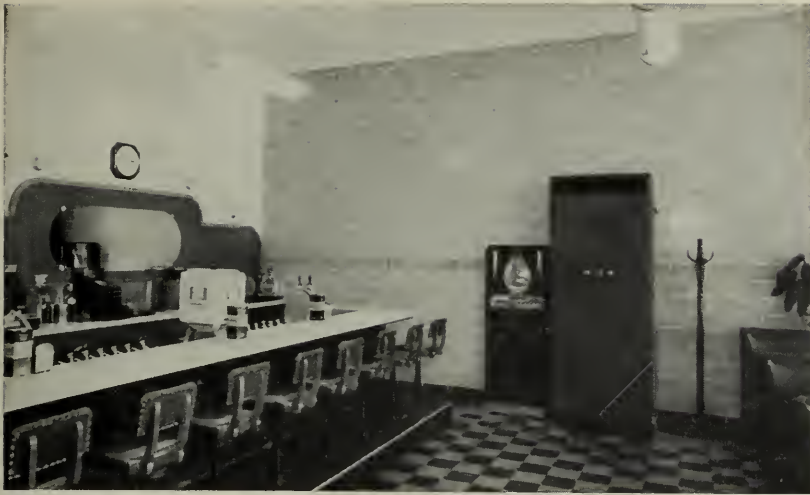

The pleasing color and texture of Salt Glazed tiled walls add sales appeal to the Blewett Dairy fountain and sales room.



A new store front was an important part of Blewett's remodeling program (Ray Stirm, Mason Contractor, and W. C. Hoegerman, General Contractor). Salt Glazed tile was specified because of its permanent attractiveness.

**Three Advantages You Can Count On
When You Specify**

KRAFTILE *Modular-Sized* SALT GLAZE STRUCTURAL TILE

1. *Economy of Construction*
2. *Permanent Attractiveness*
3. *Lower Maintenance Expense*

The "plus-values" of Kraftile Modular-Sized Salt Glazed Structural Tile are well illustrated in the new Blewett Dairy plant at Lodi. 4" and 2" thick Salt Glazed Units completed the walls and partitions. Modular tile sizes minimized cutting and fitting on the job, substantially reducing construction cost. The warm, variegated tones of the glazed tile add sales-appeal to the attractive store front and fountain sales room. Glass-smooth tiled walls give a sparkling-clean impression that builds customer satisfaction and confidence. And the walls are kept sparkling clean, easily and at minimum cost. Disinfectants and cleaning compounds cannot mar the beauty of Kraftile Salt Glazed Wall Units ... a fact that means continuing economy through the years.

For full information and complete A. I. A. file data, write:

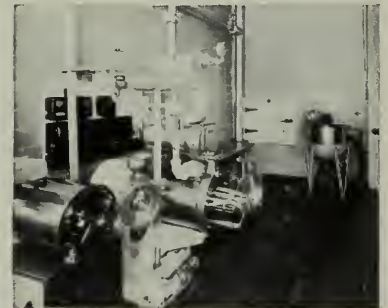

Sanitary tile walls and Kraftile-Nukem Acid-Proof Brick Floor make it easy to keep the ice cream room clean and sterile.



Scalding steam, cleaning compounds and milk acids in the milk room cannot mar the smooth, sanitary surface of the Kraftile Salt Glazed Tile walls and the acid-proof floors.

KRAFTILE COMPANY · NILES · CALIFORNIA

NEWS AND COMMENT ON ART

SAN FRANCISCO MUSEUM OF ART

The calender of exhibitions scheduled for the latter part of July and first part of August will include the following, according to Grace L. McCann Morley, Director:

WAR DRAWINGS by CORRADO CAGLI, through July 14; COLONIAL LATIN AMERICAN ARCHITECTURE, through July 14; AMERICAN WATERCOLORS — HISTORICAL DEVELOPMENT and BAY REGION STYLES, through July 14; WATERCOLORS by GRAHAM SUTHERLAND, July 9

to August 6; PEDRO FIGARI—Uruguayan Master of Color, July 9 to August 6; PHOTOGRAPHS by PAUL STRAND, July 16 to August 11; SEE YOUR WEST—Color Photographs, July 16 to August 4; WATERCOLORS by BART PERRY, July 9 to August 4; FIFTEEN LATIN AMERICAN PAINTERS, July 20 to August 4; SO YOU'RE GOING TO BUILD A HOUSE, July 16 to August 4; PRINTS by JOSEPH ALBERS of Black Mountain, July 9 to August 4.

MUSEUM ACTIVITIES

STUDIO WORKSHOP and SKETCH CLUB, Conducted by GEORGE HARRIS: Studio meetings for amateurs and professionals Wednesdays and Fridays 7:00 to 9:30 P. M.

BUDAPEST STRING QUARTET: six concerts, July 9 through August 13.

CURTAINS

By Dorothy Wright Liebes



Attractive Corral on flame color with self color fringe.

FILMS

KNOW YOUR WORLD SERIES and FAMOUS FILM SERIES, **SUSPENDED** until further notice.

CALIFORNIA SCHOOL OF FINE ARTS

The special series of classes for children will continue through July. Designed for students from pre-school through high school ages the classes combine drawing and painting with theatrical design. They are being held on Tuesday, Wednesday and Thursday.

Night classes in Photography will meet on Monday, Wednesday and Friday from 7 to 10 o'clock. This is a new department inaugurated at this year's Summer Session and is designed primarily as a refresher course for serious amateur and professional photographers.

Classes will open on June 24 and continue to August 2. They will be under the direction of Ansel Adams, assisted by Imogene Cunningham and Philip Fein.

CALIFORNIA PALACE OF THE LEGION OF HONOR

Thomas Carr Howe, Jr., director of the California Palace of the Legion of Honor, announces the following schedule of exhibitions and special events for the month of July:

EXHIBITIONS — **Watercolors** by John C. Young, opening July 16; **The Alma de Bretteville Spreckels Collection of Sculpture** by **Auguste Rodin**; **The Mildred Anna Williams Collection of Paintings, Sculpture, Tapestries and Furniture**; and the **Collis Potter Huntington Memorial Collection of 18th Cen-**

tury French Paintings, Sculpture, Tapestries, Furniture and Porcelain.

SPECIAL PROGRAMS

Organ Recital by Uda Waldrop, every Saturday and Sunday, 3 p. m. Organ Concert Broadcast at 3:30 p. m., Saturday, Station KSFO.

CHILDREN'S CLASSES

French Folk Festival for children, ages 7-14, every Wednesday in July and August, 2-4:30 p. m. French peasant life dances, songs, legends and costumes. Regular attendance required. Madelynne Greene, director of folk dancing. Other instruction under direction of Miss Katherine Parker and Lily Weil Jaffe.

FREE MOTION PICTURES: Each Saturday at 2:30 p. m.; Films with music.

July 20—"Schubert's Serenade"—Lillian Harvey; July 27—Six Musical Films: Bach, Faust, Hungarian Rhapsody, Liebestraum, Ave Maria, Archaic and Unusual Music.

GOOD FURNITURE ARRANGEMENT ADDS CHARACTER TO ANY HOME

As everyone interested in art knows, the composition or arrangement of the elements in a photograph or painting determines to a large degree the beauty and charm of a picture.

Similarly in the home, good arrangement of furniture builds character in the decorative motif. To obtain pleasing effects there should be balance and harmony for the room as a whole in respect to color, mass, form and line. Similar groupings of furniture are desirable on opposite walls. High and low pieces should be arranged to obtain agreeable perspective. Overcrowding should be avoided, and the size of pieces should be related in scale of the room. In visualizing the composition of a room, the effects of doors, windows and fireplaces should be studied carefully.

Furniture arrangement really is a problem of floor composition. In fact, the floor is the foundation of all sound home decoration. If the floor coverings are in good taste and the planning for the arrangement of furniture on the floor carried out thoughtfully, the room is virtually decorated. The draperies, wallpaper and other decorative accessories almost suggest themselves.

Equally important in the floor composition is, of course, the rug. In fine homes, large and small, hand-woven Oriental rugs, which come in a wide variety of patterns and sizes, are generally preferred. Their soft, warm tones and pleasing floral designs go well with both traditional and modern furniture, creating an atmosphere of comfortable, luxurious living. In the selection of rugs it is generally best to choose those which nearly cover the room—not more than a foot or so margin of

floor at the sides. Also, another rule to remember is that the fewer colors in a rug, the narrower is the choice of colors in wallpaper, draperies and upholstery.

LIGHTING INSTITUTE REOPENS

The well-known G-E Lighting Institute at Nela Park in Cleveland will be reopened during the week of August 5, following its being closed for five years.

Some thirty architects, designers, artists, and more than one hundred engineers, technicians and workmen have been remodeling the Institute which was originally constructed in 1923 in traditional Georgian design.

Under the direction of W. D. Riddle, architect, the redesigning represents a blend of modern techniques and traditional Georgian style.

Exhibits of modern store lighting practices will be a featured part of the new Institute, and immediately following its opening educational programs and lighting schools will be resumed.

NEW PIPE WAREHOUSE

Construction of a quarter-mile-long warehouse to speed delivery of small size pipe essential to housing and other important construction has been started at the National Tube Company's Lorain, Ohio, pipe mills.

The new building will house pipe racks, cranes, and other new equipment necessary to stock and ship the many different kinds of steel pipe in car-load lots required by the trade.

Contract for the warehouse was awarded the American Bridge Company.

STEEL EXPORT

Peak wartime year for export of iron and steel from the United States was in 1945 when 7,911,711 net tons were shipped to foreign countries, according to figures compiled by the American Iron and Steel Institute.

The figures, which include lend-lease tonnages, were 35,800,000 net tons for the five year period 1941-1945. The United Kingdom took 24 per cent and Canada 15.4, with Russia a close third with 14.6 per cent of iron and steel export.

PATENT SCAFFOLDING

The Patent Scaffolding Company, Inc., have moved into new office and warehouse facilities at 6931 Stanford Avenue, Los Angeles, California.

Gilbert K. Hardacre, manager commercial sales of the Public Service Company of northern Illinois, has been elected President of the Illuminating Engineering Society.

San Francisco's Proposed Building Code

By **ALBERT J. EVERS, Architect**
Chairman, Code Committee Northern California
Chapter, A. I. A.

The Chapter Committee on Building Codes was faced with an unexpected task by the rather sudden emergence of a proposed new building code for the City of San Francisco.

The San Francisco Department of Public Works, recognizing the need for a comprehensive review and codification of building laws, has undertaken to carry out the difficult task of drafting a new code under the guidance of Mr. H. C. Vensano, Director of that Department.

Distribution of the tentative draft began on or about March 5, 1946, to interested agencies and organizations, but reaching our Chapter at a somewhat later date, with an urgent request to review and make suggestions within a very short time to permit presentation to the San Francisco Supervisors early in May. This seemed an impossible program. The small Chapter committee was quickly reinforced by volunteers, and each one of the enlarged group was assigned to a portion of the draft document for individual review.

Liaison was established with the Structural Engineers Association, the Associated General Contractors, the Producers' Council, the Building Industry Conference Board, the Mechanical Engineers Association, and others.

Study and report by the Committee disclosed that sources of the proposed draft were as follows:

Appendix "A" of State Division of Architecture, 1945 American Standards. Minimum design loads,

American Standards (Steel),

Building Exits Code of National Fire Protection Association,

California Chamber of Commerce Code, Detroit Code,

Federal Housing Administration Requirements, Los Angeles Code,

National Lumber Association,

Proposed new San Francisco "Boiler Ordinance," New York Code,

Oakland Code (proposed),

The existing San Francisco Building Code,

State Housing Act,

Uniform Building Code,

Wood Handbook of U. S. Department of Agriculture,

The Chicago Code.

The Committee in its review found the draft to lack clarity while containing many overlapping and contradictory provisions, possibly due to the great number of sources. The membership was unanimous in the report which, under date of March 30, 1946, was rendered to the Board of Directors of the Chapter as follows:

"Your Code Committee has considered the proposed new Building Code for San Francisco. The Code, prepared by the Director of Public Works of San Francisco through the building Inspection Division, was distributed on or about Wednesday, March 13th and this Committee received its copy from the Secretary of the Chapter on Monday, March 18th.

"The task of review seemed too great for the small Committee membership of three and willing volunteers were quickly assembled into a temporary working committee which met at 4:00 p. m., March 19th, at the Chapter office. Present were Messrs. Collins, Weihe, Thomsen, Hertzka, Raney, Koue and Evers.

"At this meeting the Committee instructed the Chairman to invite William P. Day to review the engineering section of the Code, and each member present accepted a portion for review and comment. Mr. Day later accepted the responsibility and submitted a written report. Miss Boyter and Mr. Meyer offered to assist and also

reviewed a portion of the Code.

"A second meeting was held at the same place on Thursday, March 28th, with Messrs. Thomsen and Day not attending and Miss Boyter present.

"All the reviews were presented in brief, verbally, and handed to the Chairman in writing. The Committee, after discussion, adopted the following policy for recommendation to the Chapter:

1—The determination of the Department of Public Works to prepare and present for adoption a comprehensive Building Code is a most timely and commendable effort for which due credit and appreciation should be offered by the entire community.

2—The draft of the proposed code is, in form at least, a great improvement over existing laws for the reason that it assembles into one code the now scattered laws and ordinances regulating building. It is the opinion of the Committee, however, that it would be desirable to attempt a more radical revision for better results. The proposed new Code is in effect a reshuffling of existing laws, with additions from various laws and codes of other cities, governmental agencies and Insurance Underwriters. There are also some additions and changes which have been made by the authors of the proposed Code. The resultant draft seems to be a doubtful experiment in many ways. The Code is not sufficiently concise, contains too much matter of description and methods, instead of definitely establishing only minimum standards.

3—It is the recommendation of your Committee that the Pacific Coast Building Officials Conference Uniform Building Code, latest revision, be submitted for adoption with only such minor revisions as seem necessary or highly desirable.

4—It is also recommended that the cooperation of an advisory committee, composed of Architects, Engineers and Contractors representative of the entire building industry, be offered to the Director of Public Works to assist in policy matters regarding a new Building Code for San Francisco.

"The Committee, by these recommendations, is asking that the Chapter officially oppose the adoption of the draft of the Code as submitted and actively promote the preparation and submission of a more acceptable draft.

"The Committee and the Chairman wish to express their appreciation to the volunteers who have assisted in this work. May we have the Chapter's instruction for our further procedure, if any.

"Respectfully submitted,
COMMITTEE ON BUILDING CODE,
Albert J. Evers, Chairman,
A. Lewis Koue,
Vincent G. Raney."

This report was adopted by the Board of Directors, and on April 4, 1946, the policy of the Chapter, so established, was sent by letter to Mr. Vensano; several organizations and many individuals of the building industry have expressed concurrence.

In reaching the conclusion as to policy the Committee and the Directors were guided by principles which they consider as basic for modern legislation to govern building—herewith partially summarized:

1—Building legislation should not specify requirements higher or other than those minimums necessary for safety and health.

2—A code should not contain restrictive specifications which stipulate the means by which results are to be obtained, thus eliminating or prohibiting alternates, creating thereby monopolies of materials and methods.

3—Code requirements should not go beyond reasonable minimums. If buildings cost too much, growth and development of the community will be restricted. This is particularly important in such matters as safety from fire and from earthquakes.

4—Uniformity of codes provides an incentive for competitive development of alternate and better methods and materials to reach code objectives. Where cities in the same metropolitan areas have differing codes, these result in confusion for designers, builders and distributors—also an unjustifiable difference in public protection, and competition between communities on the basis of laxity of standards and cost of building.

5—It is not contended that the Pacific Coast building Officials Conference Uniform Building Code is actually the "ideal code." On the contrary it has probably many faults. There can be no doubt however that it is the best available, that it has widespread use, being adopted in whole or in part by 210 cities in California, over 400 in the nation and adopted in whole or in part by two States as a State Code. The efforts of all components of the Building Industry can be concentrated upon its gradual but certain improvement.

The Department of Works is reported to be preparing a revised draft of the proposed code. Meanwhile the Director of Works has informally expressed appreciation and interest in the recommendations of the Chapter which we hope will offset materially the form and substance of the new draft.

A Program For Urban Planning*

Urban planning is a matter of increasing importance in the life of this country. More properly we should say urban replanning, for we have entered into a period of replacement of the physical plants as well as conversion to a whole new approach to ways of living deriving from technological advances. This implies a new esthetic approach as well as a comprehension of new function. The part of the architect is clear.

In our opinion the present and immediately imperative needs of our cities cannot be lightly passed over. They are slowly disintegrating, they are on the verge of bankruptcy, and the piecemeal methods proposed for rehabilitation are hastening, not postponing, their collapse.

Our profession must take its part in these complex processes of urban planning—a part which is equal, but not superior, to the parts which must be taken by economists, lawyers, engineers, doctors and many others. We have, for the most part, seriously neglected our opportunities and evaded our responsibilities in this field. To assert, as many do, that the architect is inherently a "city planner" is as empty a boast as his often manifest disinterest in civic affairs is an abnegation of one of his prerogatives.

The objectives of the Committee on Urban Planning are therefore threefold:

1. To consolidate the interest and the activity of those architects who have, or wish to have, a part in the planning of their cities. This means stimulation at the local level.
2. To consolidate, under the leadership of The Institute, all the various techniques having to do with urban planning. This means action on the national level.
3. To carry out a two-fold educational program. One part of this program must deal with city-planning techniques as part of an architect's

training, so that he may understand his duties and responsibilities; the other must deal with the education of the public.

These are long-term efforts. The following immediate steps are proposed as a beginning:

1. This Committee shall send to all the Chapters a letter asking that members active in, or interested in, urban planning communicate with the Chairman. It may be pointed out that several chapters already have committees active in city planning and civic design. From the replies received, this Committee shall be reconstituted by the President, on a regional or other basis as the facts may warrant.
2. The Institute shall attempt to form a National **Conference** on Urban Planning. The Conference shall consist of delegates from all organizations interested in urban planning: Physical, economic, social, and governmental. The first step towards such a Conference should be the calling together of representatives of a number of the organizations in order to formulate the purposes and organization of the Conference.
3. a) The Institute should interest itself in the development and encouragement of courses in City Planning as part of the work of schools of architecture, particularly the graduate schools. These courses must be organized to bring together all students wishing to work in the field of city planning, no matter in which field they may have received a degree. It should also encourage, insofar as possible, the numerous "extra-curricular" groups of young men and women already working on these problems in many cities.
b) A sub-committee of this Committee should be appointed, first to make its own investigations and recommendations; and second, to work with The Institute's Committee on Education.
- c) A sub-committee of the Urban Planning

* Adopted by the American Institute of Architects at their Annual Convention in Miami, Florida.

(Continued on Page 44)

Some Health Hazards With Paint Removers

By **WALDEMAR SCHWEISHEIMER, M. D.**

The Journal of the American Medical Association recently gave space to a discussion of health hazards by paint removers. The question had arisen whether nitroparaffins contained in a certain paint remover used in the Air Corps were poisonous. The paint remover mentioned was composed of 25 per cent nitro-ethane, the remainder being ethyl alcohol, ethyl ketone, ethyl formate and toluene.

The Journal, through his experts, stated that all the constituents of this paint remover, with the exception of ethyl alcohol, may be harmful under some circumstances. Ethyl formate is a minor skin irritant; applied as part of a paint remover, it may decompose with the liberation of formic acid, which in concentrated strength is harmful to the skin and mucosa.

Methyl ethyl ketone in animal experiments was shown to be harmful to several internal organs as well as to the skin in stronger concentrations. However, this substance may not be regarded as highly dangerous as industrially used, since 1,000 parts per million air are believed to be within safe limits.

Nitroparaffins, including nitroethane, were shown to be harmful. Precautions are necessary for their safe handling, the Journal pointed out. A concentration of 0.1 per cent nitromethane vapor in air was assumed to be a dangerous concentration for man, while concentrations of 0.05 per cent in air were safe and tolerable in animal experiments. Danger from the use of nitroparaffins appeared to be limited to accidental ingestion (intake).

As for toluene,—which is much less dangerous than benzene,—the concentration should not exceed 200 parts per million in the atmosphere breathed by painters. In any large group, the Journal concluded, some skin trouble is almost inevitable, and systemic poisoning from toluene is likely if large areas of evaporation are provided or work occurs in confined areas.

Removing Old Paint

Thirty years ago, the U. S. Department of Labor, prepared a survey on the hazards of removing old paint, and it contains a still interesting remark of Prof. J. Stieglitz of the department of chemistry, University of Chicago. The problem was whether burning off old paint would cause the danger of lead poisoning. Burning off old paint was considered safer than chipping, English and German authorities spoke of the danger of poisoning from the fumes produced by burning off old lead paint,—a method which is not considered today to produce lead poisoning. The painter used a small gasoline flame which is hot enough to make the paint shrivel and curl up, but not hot enough to scorch it.

To the question whether this degree of heat would be sufficient to volatilize the lead, Prof. Stieglitz replied: "If the painter does not allow a flame to remain more than a moment in contact with the lead paint, I should consider the chance for the evaporation of lead to be extremely remote. The boiling point of lead is a bright red heat, and of lead chloride, which is its most volatile common salt, it is near that temperature (900° C. or 1652° F.) I believe, therefore, that the danger is minimal under those conditions. If, however, he allows the flame to play long enough on the surface to produce a decided smoke, the smoke could then carry mechanically lead particles with it."

More probable than lead poisoning from such fumes is that disagreeably smelling fumes from the heated oil cause a feeling of malaise and headache in the painter. Removing old paint by sandpapering,—or by chipping clean painted metal surfaces,—has some hazards according to the smallness of the inclosure in which the work is done. Even the use of artificial ventilation may not be sufficient in part of such cases.

Safe Paint Remover

When, in 1941, the industrial hygienist Adelaide Ross Smith, following a case report of poisoning by use of paint removers, outlined some general safety rules, the majority of paint removers still contained benzol (benzene.) It was always considered a dangerous substance for industrial use. Meanwhile conditions have changed. During the war years the use of toluene has increased remarkably, substituting for benzene. It is less dangerous than benzene since it has a high boiling point and thus evaporates freely. The concentration of free toluene fumes should never be more than 200 parts per million of air.

Paint and varnish solvents do not need to contain harmful chemicals. According to the safety

(Continued on Page 40)



44-PASSENGER DOUGLAS SKYMASTER in flight

Housing

for the

Skymasters

By **CLIFFORD SMART, Engineer**
The Austin Company

The speed and efficiency of the postwar aerial age are imposing a challenge to architects and engineers who design the ground facilities for the air lines.

An example is the new hangar and maintenance building of Western Air Lines at the Los Angeles Municipal Airport.

Contract to design and build this \$1,500,000 facility is held by The Austin Company, and actual construction has been under way since March. It is the first structure of its type on the Pacific Coast.

All of the major air lines are preparing to transfer their facilities from Lockheed Air Terminal at Burbank to the new \$25,000,000 Los Angeles Mu-

municipal Airport; but whereas most of the lines use Los Angeles merely as a turn-around spot, this is Western Air's home port and main repair base.

The assignment given to us called for creation of a huge service station, so to speak, in which the largest commercial planes in existence can be speedily and completely overhauled from propeller to empennage. The building must also house general operations offices, tremendous stock rooms, commissary, and other miscellaneous facilities requiring architectural resourcefulness and special planning.

Western Air Lines was allotted airport space for a building 300x600 feet in size less one corner cut off for a passageway. Huge as it is—roughly two city blocks long and one block wide—this is planned only as an intermediate facility. The municipal airport is being expanded to cover an area of 2400 acres and in about five years, when more ground is available, Western Air is expected to occupy from two to three times more space than at present.

The demand that this type of building makes upon the engineer is indicated by the wide variety of services that we had to provide for. The building will incorporate a complete sheet metal shop, paint shop, battery shop, upholstering shop, carpenter shop as well as shops for complete overhaul and repair of the huge aircraft engines, propellers, instruments, hydraulic gear, radios, and electrical accessories. Each area requires special study coordination with the men and equipment that will occupy it.

One piece of equipment that is at the moment presenting us with quite an installation problem is an engine parts washing machine. Western Air is considering two different types. The largest type, costing about \$60,000, would occupy a space 60x

100 feet, and would use water, steam, highly volatile cleaning solutions, sand blast, seed blast, and grit blast, and would necessitate a reclamation still and sump as well as two tanks of 500 and 1000-gallon capacities.

About 1800 tons of structural steel will be required for the basic framework of the building, and this will be enclosed with metal lath and plaster on both sides except in certain paint and oil storage areas, which will be of fireproof masonry. Two 130-foot neon signs will identify the air line.

It was desired in the new building to provide closed hangar space for the complete overhaul of two DC-6's at the same time. This in itself is a huge order. The 58-passenger DC6's are among the largest commercial planes being manufactured today, and it was necessary to design a 160-foot span for each of the two closed hangars.

The doors demanded special consideration, too. The big planes will roll through doors twenty-five feet high except for the tails, which are nearly forty feet high. We will accordingly provide motorized, side-sliding doors twenty-five feet high with a motorized center section forty feet high and hinged at the top. The assembly will have an electric interlock so that the sliding doors will not operate until the section at the top is shut.

In addition to the two closed hangars, there will be nose hangar space for quick, minor repairs and servicing. This space will be large enough to accommodate two DC-6's and will have a sixty-foot cantilever span with forty-foot anchor span and columns on forty-six foot centers. This arrangement will permit the largest luxury liner to nose in between the columns with plenty of working space around the four engines.

Each of the four hangars will be served by a



FRONT ELEVATION VIEW of Western Air Lines new hangar and home maintenance base at Los Angeles Municipal Airport. The building, 300 x 600 feet in size, embodies all the best ground features developed in two decades of pioneering the airways.

bridge crane located to pass over the engines, and monorails will serve various departments in handling heavy items.

Since airplanes are of such shape that there is lots of space around them in hangars, we decided to utilize some of this by tucking the commissary up under the roof of the nose-hangar sections between the trusses of the anchor span. The trusses will be arranged with portals for easy access from one bay to another, the web members of the trusses being designed for two 6x8 foot doors going through each truss.

The commissary will be most effective in this spot because the wide openings of the nose hangars will make it easily accessible for the hundred and one items such as silverware, linens, magazines, toilet articles and buffet supplies that are used aboard the Skymasters. It will be reached by stairs and elevator.

Everything about a building such as this must be strictly functional. The air lines sell speed. Western Air's newest planes cruise at five miles per minute, and it is important that every ground facility for them be streamlined for quick and easy loading, unloading, repairing and servicing.

For this reason the 60,000 square feet of stock room space that we will provide in this building presents problems not encountered in other types of business.

Western Air has asked storage space for thirty engines of 1200 to 2000 horsepower set up in readiness for immediate installation. Entire wings must also be stored as well as giant propellers weighing over 500 pounds.

These large items necessitate a 20-foot vertical clearance on the ground floor, and doors and passageways must be so arranged that they—

especially the wings—can be quickly and easily transported to wherever they are needed.

We have provided for two stock room areas, one on the ground floor and the other sharing the second floor with the general operations offices. Two freight elevators connect the different areas.

Although some of the offices will have windows, the plant in general is designed as a black-out plant. The large hangar area affords small chance for windows, and we felt that the lighting problem would be worked out more effectively with fluorescent lighting throughout. The lighting system is designed for an average of 50-foot-candles intensity at the working plane.

Since the airport is only a few miles from the ocean, it was not considered necessary to cool the air inside, but we have provided for an excellent heating and ventilating system capable of completely changing the air within the building every twenty minutes.

The offices on the second floor are designed around an open air patio or roof garden in which there will be umbrellas and other outdoor furniture for noon-time lounging. Wood paneling will be used in some of the offices together with acoustical ceilings. There will, however, be very little wood in the building due principally to shortages. We have to be opportunists nowadays in hooking on to whatever material is available.

The entire building will have an automatic sprinkler system, and there is space provided in the plans for a fire truck, gasoline truck, and general service truck.

Provisions have been made for a lunch room on the ground floor, and as might be expected of an air line terminal, there is an elaborate communications set-up.

In addition to the dial telephone system and

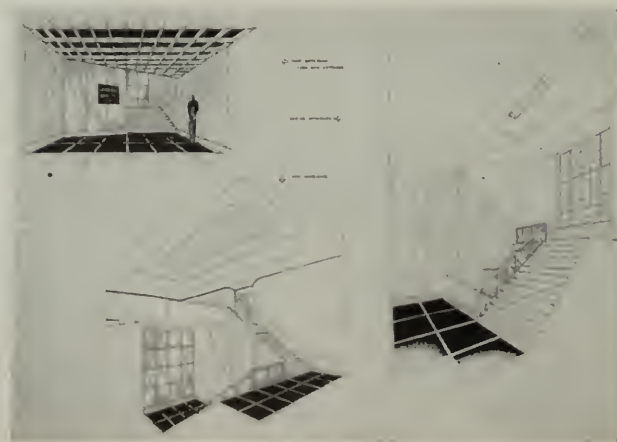

IN THE NEW AERIAL AGE of today barny structures of long ago are replaced with airline architecture embodying smartness and efficiency. This sketch shows three views of the lobby in Western Air Lines new maintenance building at the Los Angeles Municipal Airport.



REAR ELEVATION showing airport side of two closed hangars and two nose-hangars being built by Western Air at Los Angeles at a cost of \$1,500,000. Minor repairs to the luxurious DC-6's are made in the nose-hangars and overhaul jobs are done in the closed areas. Roof garden for employees is shown at top.

teletype service, which connects Western Air terminals in 38 cities, plans call for an elaborate dictograph system connecting offices of all executives and supervisors. This will enable them to talk to each other singly or in groups regardless of busy telephone lines.

We are also wiring for a public address system with provisions for piping music to certain areas when desired.

Every time our draftsmen pick up their pencils, they have to keep in mind the great demands for speed and convenience that this structure must meet.

The importance of streamlining every phase of the facility may be realized from the fact that every day fifty-six Western Air liners fly in and out of Los Angeles on schedule not to mention test and charter flights.

They roar in day and night from great distances, and many of them pause only twenty or thirty

minutes between flights. In that short time they must be cleansed throughout, carpets vacuumed, windows washed, supplies of all kinds checked and replenished, food carried aboard, and mechanical inspections and adjustments made if necessary.

At certain regular intervals, the planes are taken out of service and overhauled either partially or completely, and such operations must be done in a minimum length of time because planes pay no dividends on the ground.

How well we do our work in planning and building this structure will determine to a large extent the speed and efficiency with which the 750 people who will occupy the building can carry on their work.

Engineers and builders have their part in this new aerial age the same as the men who fly the planes at speeds of five miles per minute.



CITY OF LONDON showing much bombed St. Paul's Cathedral area.

Architectural Hopes And Difficulties In British Re-Planning

By MURIEL HARRIS, British Novelist

Recently Charles Holden, Architect, was appointed consultant for the town planning scheme for the City of Canterbury. Some weeks ago, jointly with Professor W. G. Holford, he was appointed consultant for the reconstruction of the City of London. To this distinguished architect, therefore, has been confided the replanning of what is virtually the heart of England.

The grievous damage caused by German bombing to Canterbury and to that historic square mile, known as the City of London, necessitated re-planning on a comprehensive scale.

Of the thirty-six historic halls of the City Livery Companies, twenty have been practically destroyed and two only remain intact. The palimpsest

of British, Roman and Saxon England in both cities can be deciphered by the experienced eye, and German bombing has meant that once again Canterbury and the City of London have to rise from their ashes in a modern form suitable for the needs of today. The City has to be sorted out, its world-wide interests agreed and, withal, its own particular flavor preserved; Canterbury, the seat of the first Christian King of Kent, the spot upon which British and Roman roads converged, has once more to be re-erected partly as a great National shrine of Britain's people.

Suitable Choice

The coupling of the name of Charles Holden with the two cities round which the ancient tradi-

tions of England have most been centered, is a wise choice. It would have been possible to choose a town-planner steeped only in the lore of the historic past and inevitably harking back to by-gone centuries. It would have been possible to have chosen the specialist who saw only in terms of convenient roads and railways. But it is Charles Holden's distinction to be able to penetrate behind the facade, see what is there and combine both past and present. "Clarification" is a favorite word of Holden's and a study of his own buildings gives the essence of what he means. To many, the University of London buildings, the Headquarters of London Transport at St. James's Park, the British Medical Association Building in the Strand, have a grim look, stripped as they are of every non-essential, of those adventitious aids which shoe-horn people into the belief that they have taste.

But the eye is an adventurous organ. There comes a time when it suddenly perceives that knife-edge of proportion, balance, complete suitability, which appears in Charles Holden's work. Because of this keen sense of pulsating life, the Headquarters of London Transport is perhaps the building which most readily yields visual pleasure. Its genesis is characteristic of the man. Given an awkward, unmanageable site upon which to erect a large building with a complex of functions, he imagined the office worker allowed to cut across the site to the station, instead of having to go around a blind corner where the station would be difficult to find. A line drawn along the route of the imaginary passenger, produced an outline shape, which, bisected, established the central axis of the future plan.

"I do not think," Holden says, "that I was ever

more excited in my life than when I realized the full possibilities of this cross-shaped plan—good light, no interference with neighbor lights, short corridors and a compact center, containing all services, complete with lifts and staircase communicating directly with all four wings."

This building, with its ground-plan shaped like a monoplane, is of course the most dramatic of several of London's Underground stations, including that at Piccadilly Circus, familiar to so many G. I. s during World War II. But the smaller stations also show this penetration back through the architectural form to the human beings for whom that form exists. The surface station at Sudbury Town, just opposite London, based on human requirements, has been carried out with complete directness and simplicity.

This is not to say that Holden disregards the human being's instinct for ornament; he only disregards ornament, put on to "prettify," which is not an integral part of the whole. Ornament must accent, emphasize what is there, lending variety. In this sense some of the window arrangement of London's University Building might be called ornament, in that he deliberately uses irregularity, setting his windows, musically speaking in four-five time. Railings are carefully chosen, not to dissemble, but to underline proportions. Texture, form, color of materials, all these work together in the interest of ornament and decoration.

Happiness In His Work

These are the principles on which Charles Holden proceeds in town-planning, distilled fresh every time so that they never have the rigidity of formulae. They help to solve the architect-engineering problem. With Holden, engineering does not

2,250,000 London homes were destroyed by enemy air bombs, and 80,500 Londoners killed or hospitalized during war.





**UNIVERSITY OF LONDON'S new buildings in Bloomsbury
designed by C. Holden, F.R.I.B.A.**

become something to which architecture is applied later, or architecture something which has to put up with engineering. And it is in these principles that this quiet man with the small grey beard, who is not unlike England's Plantagenet poet, Geoffrey Chaucer, too look at, has found happiness. He said of himself: "It has been my pleasure to give my life to work which has been a source of intense happiness to me from the beginning."

This happiness makes itself felt. Charles Holden never speaks unless he has something to say. He is a lion who has carried off the most coveted



**DR. CHARLES HOLDEN
F.R.I.B.A., M.T.P.I.**

distinction of the architectural profession—the Royal Gold Medal, who is a member of the Royal Fine Art Commission and a power in architectural England. During the bombing his tall buildings were used for warning of "Imminent Danger." He would stand in the street, when some of his friends would have liked to take shelter, gratified that his tower stood up well to enemy aerial bombardment. He has a genius for friendship, and trouble and affliction he regards as an episode in life. He thinks archi-

itects are lucky, in that their work compels them to keep in close contact with their follows—clients, contractors, clerks-of-the-works, foremen—all of whom, he maintains, contribute to the realization of architectural plans. He is himself an exquisite craftsman and has a "Holy of Holies" at home, stacked with tools and ordered like a Greek temple.

BRITISH HOUSING DIFFICULTIES

By JOAN LITTLEFIELD

Faced with the need for providing 750,000 homes with a labor force still only half its prewar strength of 1,000,000, and acute shortages of bricks, slates, glass and other essential materials, the British Government, aided by local authorities and architects, is yet trying to plan its housing program both practically and aesthetically.

The ribbon-building indulged in after the first World War is not to be repeated. Every effort is being made in the bombed areas and on new estates to design what is called a Neighborhood Unit, containing its own shops, school, community center, library, and clinic.

Many London boroughs have schemes ready to go into operation the moment men and materials are available. On a nine-and-three-quarter acre estate in Becher Street, Kensington, the local coun-

cil is to erect 302 dwellings, giving a density of 32.5 homes and 136 persons per acre.

There will be 20 houses of six rooms for the larger families up to eight persons; 48 four-room apartments for families of five; 24 larger four-room apartments which will accommodate six; 96 three-room apartments for four persons; and eighteen one-room apartments for single people. There will also be eight-story blocks, comprising 64 three-room apartments for four persons, and 32 two-room apartments for two. The buildings, planned in a north-south direction to receive both morning and afternoon sun, will be separated by grassed and tree-planted courtyards. By raising the mid-section of the two eight-story blocks by a floor-and-a-half above normal ground level, ample height is provided below for a social center, with tenants' club room in the front block, and a nursery playroom, with milkbar in the rear block. All the apartments have private balconies, and utility rooms with laundry appliances are provided in the three-story blocks.

Camden Town, St. Pancras, Hackney and Finsbury have similar plans, while near-country estates at Letchworth, Loughton and other places on the fringe of London are designed to include open

spaces, trees, playing fields. At Letchworth the proposed estate of 2,000 houses is based on a system of distributive and residential roads. The distributive roads become parkways and contain trees, undergrowth and roughly kept grass. The residential roads become garden closes and are staggered to avoid through traffic and wind funnels.

On the 558-acre site at Loughton, Essex, where the London County Council plans a \$20,000 scheme with permanent prefabricated steel houses, Loughton Hall, a mansion with six acres of gardens and a paddock of 7½ acres, will remain—as a community center.

There will also be schools, shops, churches, refreshment houses and a movie theater. Other plans include cottage estates at Chislehurst, in Kent, and Chessington, Surrey. On the former 3,500 homes will be built on 495 acres; on the latter between 6,000 and 7,000 cottages on 800 acres. At Harrow, they are erecting 1,114 pre-fabs., of which 502 will be permanent, semi-detached, three-bedroom buildings.

These are the big schemes. Meanwhile, the daily drive to provide immediate homes goes on. The nation-wide plan includes the building of per-

(Continued on Page 21)

LONDON TRANSPORT Headquarters building and famed St. James Park Station in London. Architect Charles Holden has utilized every opportunity in an awkward, unmanageable site in developing this compact transportation center.





THE BRAITHWAITE HOUSE

DETAILS IN CONSTRUCTION OF TWO POPULAR POSTWAR BRITISH HOMES

BRAITHWAITE HOUSE system is a light-framed structure of cold rolled sections. The frame is built up with ladder-like welded units 3 ft. 2 ins. and 6 ft. 4 ins. wide and of two-story height. The smaller of these units can be handled by two men and the larger by four men, and each is bolted to the adjoining unit. Alternative claddings are used, brick, asbestos cement, vitreous enamelled steel sheets, or even stone, according to local authorities' requirements. The plan is based on a 3 ft. 2 in. grid, but considerable flexibility of planning is possible. The system is applicable to detached, semi-detached or terrace houses and to flats of three stories. A number of alternative inner lining units will be tried out.

One of the most interesting points about the construction is the patent spring clip for fixing internal and external sheeting direct to the frame. These clips are in lengths up to 10 ft. 6 in. and hold fast when pushed into position. The floor and roof beams spaced at 3 ft. 2 in. centers are inverted U-shape members in light gauge steel. Various kinds of floors are possible. In the two prototype houses light-weight concrete slabs are used in the kitchens and stiffened plywood floor panels in the other rooms. The light-weight concrete slabs are 2½ in. thick and 3 ft. 2 in. square. The timber panels are 3 ft. 2 in. by 3 ft. 2 in. and 3 ft. 2 in. by 9 ft. 6 in.

(Continued from Page 19)

manent houses (mostly of the three-bedroomed variety); the erection of temporary houses (of the single-story, two-bedroomed type); the repairing and adapting of existing buildings and the re-quisitioning of empty houses; the conversion, where practicable, of wartime hutments and hostels for use as temporary dwellings, and the fullest employment of occupied houses, by voluntary sharing.

Much remains to be done, and it will be some time before housing ceases to be a problem. Meanwhile, critics would do well to remember that no houses were built in Britain between September 1939 and the summer of 1945; that of the 1939 total of 13,000,000 houses, one-third were destroyed by enemy action, 250,000 were seriously damaged, and 4,000,000 slightly damaged.

COVER ILLUSTRATION

Among the photographs furnished ARCHITECT & ENGINEER by the British Information Service for use in conjunction with the articles by Muriel Harris, and Joan Littlefield, on "Architectural Hopes and Difficulties in British Re-Planning," is the Plan of the Ground Floor of the headquarters building of the London Electric Railways and St. James' Park Station, London.

With its ground floor plan shaped like a monoplane, the structure was designed by Dr. Charles Holden, F.R.I.B.A., it is among the outstanding present-day buildings of the city.

The Orlit House

The prime member of the system is a 6¾ square precast concrete post or stanchion which is assembled with precast beams to form a reinforced concrete monolithic frame. The walls are formed by enclosing the stanchions in two layers of concrete in the form of thin slabs and blocks. The slabs are medium sized being in no case more than 4 ft. 0 in. in any one direction, permitting easy production, transport, easy handling and flexibility in planning. Stanchions are placed in sockets in a prepared foundation, plumbed, wedged and grouted. Beams are assembled and structural frame completed. The wall structure is independent of the structural frame, isolation being by means of felt strips placed between the frame and the slabs. Assembly of the slabs is by means of tie-wedge fixing, bolting and notching, facilitating quick and relatively fool-proof erection. Jointing vertically is by means of fibrous material soaked with bitumen embedded in grooves in the slabs. Horizontal jointing is by cement-gauged mortar.

The houses have floors and flat roofs of precast reinforced concrete channels, although the design allows the use of any proprietary concrete floor beams. Ceilings are of plaster board or fibre board fixed to the underside of the channels. Finish elsewhere are of familiar materials. Service pipes are grouped together as far as possible, and pipes, conduits, etc., are run in ducts contained within the wall.



THE ORLIT HOUSE



MODERN SCENIC HIGHWAYS in rugged mountains

California's Postwar Public Works Program

The largest agency of State government, the Department of Public Works, comprises four divisions. They are: Division of Highways, Division of Architecture, and Division of Water Resources,

and Division of Contracts and Rights of Way. Each has contributed in full measure to the planning and execution of Governor Earl Warren's Postwar Public Works Program.

DIVISION OF HIGHWAYS

Access Roads and Flight Strips

On January 2, 1943, when Governor Warren assumed the direction of State affairs for California the nation had just completed one year of war. At that time, and until the end of the war, activities of the Division of Highways under the necessary Federal limitations on construction were confined to the building of road facilities for access to army and navy establishments, to industrial plants engaged in war production, and to raw material sites.

As Governor Warren took over the reins of office, this wartime construction for Federal agencies continued to hold first place on the agenda of work by the Division of Highways. Of the total access road program of \$35,300,000, an amount of \$19,200,000 has been placed under contract since January 1943; this is 54 per cent of the entire program. Similarly, 35 per cent of the two and one-half million dollars in flight strips built by the State for the United States Air Forces were contracted during the current state administration.

Preparation for Postwar Period

While, during the war years the emphasis of the Division of Highways' operations was upon construction needed for the war effort and upon holding the line through expanded maintenance

and repair of road surfaces and bridges, officials of the State administration were looking ahead towards the resumption in the postwar years of extensive State highway development.

At the instance of the Governor, the 1943 session of the State legislature appropriated the sum of \$12,000,000 for surveys, preparation of plans, specifications and estimates and for the acquisition of rights of way for a postwar State highway construction program.

Preparation of the program was expedited and of the twelve million dollars, \$1,500,000 allocated for surveys and plans have been expended and over \$10,000,000 has been used for the purchase of necessary right of way.

State Highway Commission Reorganized

One of Governor Warren's first steps in planning in advance of the war's end a postwar highway construction program was to urge the 1943 legislature to reorganize the California Highway Commission by increasing the membership from five to seven and to free it of any possible future political control by providing for staggered terms of office of the six appointed members. Under the act passed by the legislature, the Director of Public Works is an ex officio member and chairman of the commission.

**TODAY'S
ROADS
and
HIGHWAYS,
like the story
of Rome,
were not built
in a day!**





THE INGENUITY AND SKILL OF EXPERIENCED ENGINEERS AND CONTRACTORS
is tested in the building of many miles of California's modern, safe, all-year highways.

On September 14, when the act reorganizing the commission had become operative, Governor Warren appointed six commissioners for terms expiring, respectively, on the 15th day of January, one in each of the years 1944 and 1946, and two in each of the years 1945 and 1947.

On the same day, the commissioners met in the office of the Governor, drew lots for long and short staggered terms, received their commissions and immediately were called into session by their chairman, Director of Public Works C. H. Purcell.

Without delay the new commission launched plans for a one hundred million dollar postwar highway building program, which it later expanded to \$123,000,000. One of its first official acts was to transfer into the State Highway Budget Fund the \$12,000,000 which had been appropriated by the legislature at the request of the Governor for highway plans and surveys and the acquisition of rights of way for postwar construction. The commission allocated \$10,500,000 for rights of way and \$1,500,000 for engineering surveys.

Thus, within a few hours after its members had been sworn into office, the newly organized California Highway Commission had embarked upon Governor Warren's postwar highway program

Postwar Highway Program Mapped

On November 18, 1943, the newly reorganized California Highway Commission began study and consideration of projects proposed for inclusion in such a program. On January 20, 1944, the Commission adopted a proposed three-year program and budgeted State highway funds, including the twelve million dollar legislative appropriation, for the preliminary engineering and right of way acquisition for the projects in the program.

The postwar program provided for improvement to more than 600 miles of State highways. A very considerable portion of the program involved urban freeway development with a large number of bridges and grade separations, there being 180 bridges and 150 grade separation structures. Of the latter, 25 are railroad grade separations and 125 separate the grades of two or more highways. The estimated construction cost of this three-year program is \$123,000,000.

With the passage by Congress in December, 1944, of the Federal Aid Highway act under which California is apportioned \$17,000,000 for Federal Secondary or Feeder roads for each of the first three postwar years, it became possible to determine definitely the size of the program. Immediately after V. J. Day, on September 24, 1945, the Highway Commission adopted a partial program for construction during the first postwar year. This initial program provided for construction of projects totaling \$40,000,000. Progress on this first year program is well advanced.

Postwar Highway Construction

As soon after V. J. Day as Federal approval was received for advertising of bids on California's Federal Aid and Federal Aid Urban programs, the State Highway Engineer, following the policy of the State administration, began publishing calls for bids on State highway construction projects. The first notices were published on November 9 and bids were opened on these first postwar projects on November 28, 1945.

From that date to June 26 bids had been opened on 167 construction projects. Of these, contracts have been awarded or are pending award on 155 jobs. In addition, there are advertisements outstanding for 17 projects, for which bids will be opened during July. The total value of these projects amounts to approximately \$46,000,000.

Projects included in the State's postwar program have been selected with immediate rehabilitation

and development of the State highway system as the primary object. The program will do much toward correcting the more critical deficiencies of inadequate bridges; of structural weakness in road bases and pavements; of highways with inadequate traffic capacity; of specific points of hazard or obstruction; and of the lack of required free-ways.

In addition to the \$12,000,000 appropriation for preparation of plans and right of way acquisition for the postwar State highway program, the 1943 session of the State Legislature also appropriated the sum of \$1,500,000 for surveys and preparation of plans for postwar improvement to county roads. Administration of these county aid funds was performed by the Division of Highways. These funds were apportioned among the 58 counties and proposed programs have been submitted by and approved for 55 counties.

Federal Aid Secondary Roads

The Federal Aid Highway Act of 1944 stipulated that \$150,000,000 in Federal funds were to be expended on a system of principal secondary or feeder roads selected by the State highway departments in cooperation with the Public Roads Administration and the county supervisors. Of the \$150,000,000, \$15,468,762 was allocated to the State of California for the first three postwar years.

The experience of the State with previous feeder road programs indicated that counties would have difficulty raising funds to match these Federal



WHETHER IT BE DESERT OR MOUNTAIN HIGHWAY the same care and attention is given the building of roadway foundations, thus assuring the maximum in durability and driving pleasure.

Aid Secondary funds. If the FAS program was to be a success in so far as county roads were concerned, it was imperative that other than county funds must be provided for matching. To provide these matching funds the Legislature passed and the Governor approved the County Highway Aid Act of 1945.

This Act appropriated \$12,000,000 to match FAS funds and stipulated that 87½% of Federal Aid Secondary funds apportioned to the State should be expended on the county road portions of the Federal Aid Secondary system. Federal and State funds allocated for the improvement of county roads on the FAS system total \$25,550,916.

Following the passage of the County Highway Aid Act, it was found that for California only about \$10,000,000 was required to match the Federal Aid Secondary funds. However, at the 1946 special session of the Legislature, the legislature passed and the Governor approved a clarifying amendment whereby all of the \$12,000,000 may be spent for matching purposes.

At the present time all but six counties have submitted programs for improvements on the FAS system which total \$18,000,000 involving 144 projects with a total mileage of 600 miles.

County projects estimated to cost \$1,210,000 have been advertised for bids by the Division of Highways. Three contracts totaling \$1,000,000 have been awarded.

In the selection of the system and the submission of programs, excellent cooperation with the counties has been obtained and, in view thereof, it is believed that a substantial proportion of the work will be placed under contract during this calendar year.

The California Federal Aid Secondary System as approved by the Commissioner of Public Roads totals 8947.4 miles, of which 3779.5 miles are State highways and 5167.9 miles are county roads.

DIVISION OF CONTRACTS AND RIGHTS OF WAY

While still engaged in the acquisition of rights of way for access roads for the Federal govern-

ment, the Right of Way Department of the Division of Highways was called upon to expand its activities to include the purchase of rights of way for the State's rapidly developing postwar highway construction program.

It is worthy of note that during the period January 1, 1943 to May 1, 1946, the Division of Highways through its Right of Way Department and in cooperation with other public agencies, as an aid to the war effort and, since VJ Day, in an effort to relieve the acute housing shortage problem, has, wherever possible, permitted occupants of housing facilities acquired in connection with its road building program to retain possession as tenants. Evictions were held to a minimum of necessity. The result is that the number of tenant-occupied State-owned buildings, which structures will be removed or wrecked as soon as the tenants can secure other housing facilities, has steadily increased. At present approximately 2400 rental units are being operated under the management of the Right of Way Department.

During the period January 1, 1943 to May 1, 1946, the Right of Way Department acquired a total of 7,527 parcels of property for right of way purposes at a cost of \$23,474,000. These transactions entailed the signing of 12,861 documents.

Included in this total are 55 parcels purchased for the Department of Finance (Property Acquisition Board) at a cost of \$1,493,000, 50 parcels at a cost of \$300,000 bought for access roads right of way since July 1, 1945, and 42 parcels at a cost of \$225,000 purchased for State highway projects other than those included in the postwar program.

DIVISION OF ARCHITECTURE

Advance Planning for Postwar Public Works Program

In the years 1943 and 1944, in addition to an appropriation of \$12,000,000 for use in making surveys and acquiring rights of way for postwar highway construction, there was appropriated \$3,250,000 to finance the preparation of plans and



STATE OPERATED FERRY BOAT SYSTEM

specifications for new buildings required by State agencies. At the 1946 special session, an omnibus appropriation of \$154,000,000 for State buildings was made by the legislature.

The 1943 legislature appropriated \$1,500,000 to the counties towards the cost of surveying new county roads and preparing plans for a \$58,000,000 construction program. At the 1945 session \$12,000,000 was allocated to the counties of the State to enable them to match \$15,000,000 of Federal Aid Secondary highway funds.

During the special legislative session in 1944, an appropriation of \$10,000,000 was made to assist the cities as well as the counties and various districts in acquiring sites and preparing plans and specifications for local public works projects. At the 1946 special session, the legislature appropriated \$90,000,000 toward the construction of these local public works.

The aggregate of the various programs—State highways and buildings, county roads, and the public works of local agencies—exceeds \$950,000,000, all planned for in advance of peacetime reconversion.

Activities of the Division of Architecture

Since January 1943, to the present time, the Division of Architecture, handicapped by lack of personnel, has accomplished a vast amount of work in connection with the Administration's post-

war building program.

It has prepared surveys, designs, and plans for construction, reconstruction, rehabilitation, and replacement of buildings and other facilities of State properties.

The total program now established for project plan preparation by the Division amounts to approximately \$154,000,000. Of this amount, the Division has been authorized to prepare project plans amounting to approximately \$70,000,000, of which 50% has been completed.

It has handled repairs, improvements, alteration and construction work on State properties, requiring for the most part Federal priority assistance or Federal approval, amounting to \$6,105,827.

It has conducted surveys and prepared reports and estimates of cost relating to essential alterations, repairs, improvements, minor construction, and other facilities on State-owned property.

Under the authority invested in it by law of supervising the construction of public school buildings, the Division has processed 496 projects having a construction valuation of \$23,567,845. Processing consists of checking and approving or rejecting plans and specifications and inspections and supervision during the progress of construction.

A total of 192 proposed City and County projects have been submitted to the Division by the Post-

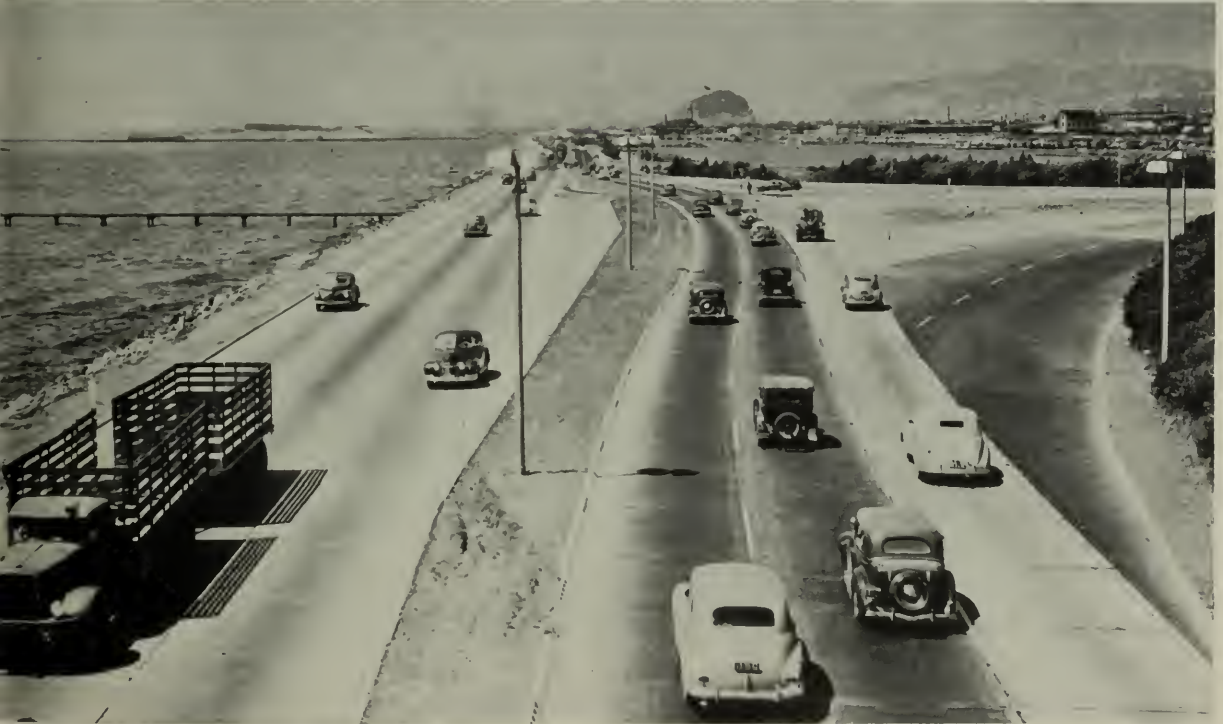

TRAFFIC SEPARATION CENTERS, such as this one on the East-Shore highway serving metropolitan Oakland, Berkeley, and Richmond, eases the "pressure" of traffic approaching and leaving the San Francisco-Oakland Bay Bridge.



NUMEROUS FREEWAYS such as this one in southern California, combined with lateral and bilateral local-service highways and scientifically designed "on" and "off" intersections, unite to make California's vast system of highways among the Nation's most outstanding.

war Public Works Review Board for comment as to cost estimate and practical nature in relation to allocation of matching funds for contract plans.

Under the administrative and advisory service the division has been called upon continually to furnish technical advice and perform technical services to State departments, boards, commissions, district agricultural associations, legislative committees and other agencies relating to postwar planning, office planning, appraisals, structural, mechanical and electrical problems, drainage conditions, site surveys, rate surveys, maintenance surveys, estimates of cost and quantities, Federal requirements and restrictions, and many more varying services apart from construction projects.

DIVISION OF WATER RESOURCES

Functions of the Division of Water Resources of the Department of Public Works include Sacramento-San Joaquin Water Supervision, action on applications to appropriate water, adjudication of water rights, the conducting of snow surveys in cooperation with other agencies, rendering water

master service, supervision of safety of dams, and maintenance and operation of Sacramento River Flood Control Project.

Activities of Division

In July 1944, an investigation was commenced of groundwater conditions in the Salinas Valley. An amount of \$26,000 was made available for the investigation, one-half of which was from the State Emergency Fund and one-half contributed by Monterey County. The report on the investigation will be finished by the end of the current fiscal year.

At the request of representatives of Modoc and Lassen counties, an investigation of the possibilities of development of additional sources of water in these counties was undertaken by the Division. The sum of \$7,500 was made available for the investigation from the State Emergency Fund, while an equal amount was contributed by local interests. The report on the investigation was completed in March 1945.

There was appropriated \$300,000 to cover the

cost of an investigation and report by the State Engineer on topographic mapping in California, and to finance the program of map production in cooperation with the Federal Government. An agreement has already been entered into with the U. S. Geological Survey providing for the mapping of 12,000 square miles, and it is expected that all funds available will be committed by agreement with Federal agencies to provide for the mapping program.

An appropriation of \$250,000 provided for an investigation of flood control requirements and sources of water supply in the mountainous areas of the State. Owing to the difficulty which is encountered in securing competent engineering assistance, it is believed this program may develop somewhat slowly.

Recognizing the importance of snow surveys in forecasting water supplies, the Legislature appropriated \$60,000 for the construction of shelter cabins and other facilities relating to snow surveys. Plans are being perfected and negotiations are under way so that construction may begin as soon as snow melts in the mountains.

On January 15, 1946, a contract in the amount of \$1,123,190 was signed for construction of Rector

Dam in Napa County, which is designed to store 4,400 acre-feet of water for use at State institutions. It is estimated that the dam will be completed by December 31, 1946. Chapter 57, Statutes of 1946, appropriated \$300,000 for construction of a pipeline to carry water from Rector Dam to the State institutions. Plans and cost estimates for the pipeline are in the course of preparation.

Early in the year 1944, work was started on a contract for the improvement of Alamitos Bay and Ocean Beach in Los Angeles. Approximately \$230,000 was spent on this project, \$100,000 of which was State funds.

Fourteen counties benefited by \$500,000 for flood damage repairs, caused by floods in 1943. The program included 31 projects.

An amount of \$21,000 was made available by Executive Order for construction of flood control works on the Santa Clara River at Saticoy. An additional \$14,000 was made available by the Division of Highways, and these State funds were matched by a \$35,000 contribution by the County of Ventura.

Early in 1945 an investigation was undertaken of the watershed of San Dieguito and San Diego rivers to determine if an additional water supply



"NO PASSING" Yellow Line Doomed: The YELLOW traffic line on California's State highways is being replaced by the uniform National system of highway signs and traffic control devices—two continuous parallel white lines where passing a vehicle is prohibited, and a combination solid white line where passing is permitted IF the broken line is in the driver's lane.

(Photo's Courtesy California Highways & Public Works)

for the city of San Diego is available from these sources. The State contributed \$20,000 toward the investigation and the city of San Diego contributed a like amount. Amounts of \$2,500 were made available by the State and the Fallbrook Public Utility District of San Diego County to cover the cost of an investigation and report on the availability of a supplemental water supply for the Utility District.

The 1945 Legislature passed an appropriation of \$100,000 to pay part of the cost of construction of protection works for the beach in the front of the city of Redondo Beach.

Governor Warren approved Legislation which provided the sum of \$500,000 for repair of property damaged by storm or flood. The projects have been approved.

\$10,000 was required as the result of higher prices to reconstruct the Stevens Bridge over Cache Creek in Yolo County. The county of Yolo contributed \$16,550 toward the project.

At Mission Bay in the city of San Diego, in what formerly was Mission Bay State Park, the sum of \$50,000 of State funds and a contribution of \$20,000 by the city of San Diego were expected for the construction of a fill by hydraulic dredging. This work was the initial unit of a long-range plan of extensive development of the Mission Bay area for commercial and recreational use.

An amount of \$52,300, one-half of which was State funds was expended during 1945 on construction of the stone groin on the beach of the Venice district of the city of Los Angeles. The groin was built to retain the sand on a section of beach where the city of Los Angeles had replenished the eroded beach by the addition of approximately 150,000 cubic yards of sand.

Approximately \$34,000 of State funds was expended for protection of the Founders Grove State Park in Humboldt County from the erosive action of the Eel River. The park contains the world's tallest trees. In 1945 an additional \$5,000 was made available for maintenance of the protective work.

Since January 1, 1943, \$200,112 has been appropriated to the Water Project Authority for furtherance of the Central Valley Project. Included in the activities carried on by the State Engineer under direction of the Water Project Authority are the following:

Preparation of a brief for immediate construction of Friant-Kern Canal, which was submitted to the War Production Board in November, 1943 making a study of and reporting upon the application of the excess lands provision of the Federal reclamation law to the Central Valley Project participation in the Central Valley studies of the Bureau of Reclamation; preparing a report on State

control of the Central Valley Project; making studies of disposal of water and power made available by Central Valley Project.

Chapter 1514, Statutes of 1945, created the State Water Resources Board, the duties of which include studying the flood control and water conservation problems of the State. Chapter 1487, Statutes of 1945, made available \$75,000 for the support of the Board during the 97th and 98th fiscal years. Governor Warren duly appointed the seven members of the Board, and its initial meeting was held November 1, 1945. In accordance with the Act, the State Engineer serves as Secretary and Engineer to the Board.

Governor Warren called a water conference to be held in Sacramento December 6 and 7, 1945, in order to familiarize himself and the Water Resources Board with the many and varied water problems of the State. The State Engineer was directed to plan and organize the conference, and money was provided from the State Emergency Fund to cover the cost. The detailed report on the conference has been prepared by the State Engineer and is now being distributed.

ARCHITECTURAL PORCELAIN ENAMELERS SET STANDARDS

Standard specifications covering the manufacture of architectural porcelain enamel have been officially approved and adopted by the Architectural Division of the Porcelain Enamel Institute, Washington, D. C.

The standards prescribe in general detail the proper materials and methods to be used in designing, fabricating and processing parts for architectural porcelain enamel, and were prepared by a special committee after long study and revision of several preliminary drafts.

ARCHITECT'S COMPETITION MINNESOTA VETERANS BUILDING

A competition to select a design and an Architect for the proposed Minnesota State Veterans Service building is being conducted by the Commission in charge of the project, and will close October 1946.

The building is to be erected on the grounds of the State Capitol in St. Paul. A total sum of \$2 million has been appropriated by the State Legislature for the purpose.

Prospective competitors should apply to John W. McConneloug, Secretary, State Veterans Service Building Commission, 1745 Court House, St. Paul 2, Minnesota. Applicants should request copy of program, give full particulars of their individual firm, and state in what States they are registered to practice Architecture.

A. I. A.

American Institute



ACTIVITIES

of Architects

CALIFORNIA COUNCIL OF ARCHITECTS:

John S. Bolles, President; Robert H. Orr, Vice-President, James H. Mitchell, Secretary-Treasurer; 369 Pine Street, San Francisco 4.

Washington State Chapter:

George W. Stoddard, President; Clifton J. Brady and Joseph H. Wohleb, Vice-Presidents Stephen H. Richardson, Secretary; J. H. Dillon De Hart, Treasurer; Offices 516 Central Building, Seattle 4, Washington.

Northern California Chapter:

Andrew T. Hass, President; E. Geoffrey Bangs, vice President; John S. Bolles, Secretary; Hervey Parke Clark, Treasurer; 369 Pine Street, San Francisco 4.

Southern California Chapter:

Charles O. Matcham, President; Adrian Wilson, Vice-President John Landon, Secretary; Albert C. Martin, Jr., Treasurer; Offices 3757 Wilshire Blvd., Suite 212, Phone Fltzroy 2393 or MUtual 4592. DIRECTORS, John Rex, Paul R. Hunter, and Weldon D. Becket.

WASHINGTON STATE CHAPTER

Members have resumed their program of visiting various industrial plants in connection with Chapter meetings.

On June 15th, the Douglas Fir Plywood Association Laboratory, the Wheeler-Osgood Manufacturing Plant and the Tacoma Lumber Fabricators Plant were inspected prior to the regular dinner meeting.

* * *

New members to the Chapter included: Theodore H. Damm and John I. Mattson (corporate); John C. Lindahl, John M. Morse, and Kenneth C. Helms (associates).

* * *

The proposed amendment to the Chapter By-Laws changing the date of the Annual Chapter Meeting from January to June was approved and goes to the Institute Board for approval.

* * *

The Small House Plans Bureau Committee, Mr. Wegg, chairman, reported the Bureau is organized efficiently and proceeding on a satisfactory business basis.

* * *

SOUTHERN CALIFORNIA CHAPTER

Following attendance at the Institute Convention in Miami, President Chas. O. Matcham "took an early morning plane to Havana and spent the day renewing acquaintance with old favorite haunts of years past. We (Mrs. Matcham) bumped into Sumner Spaulding toward the evening in an ice cream parlor and we three had dinner together. Later we met up in the National Hotel with Bill Harrison who was off to the theater.

"At midnight we hopped over to Yucatan, spending two days in Merida and a day en route to and in Chichen Itza to see the ruins of the civilization of the Mayans, Toltecs and Aztecs.

"Another past midnight flight brought us to Guatemala City... Wednesday evening we flew to Mexico City." Before leaving for Los Angeles,

President Charles expects to visit many points of interest in Mexico and as he writes "Perhaps I can bring home with me some ideas for the Chapter members which will make excusable my absence for a couple of weeks."

* * *

Twenty-two new members and seven new associates were introduced at the May meeting, making a total membership as of June 1, 1946 of 379 members.

* * *

Home Show Exhibit—Photographs of smaller homes at the Pan-Pacific Auditorium, July 12-21.

* * *

Miss Rita Miller, former secretary to the California Association, has been appointed assistant secretary of the Chapter, succeeding Miss Patton.

* * *

NORTHERN CALIFORNIA CHAPTER

President Hass has appointed Wayne Hertzka a member of the committee for the annual convention of the California Chapters of the A.I.A. tentatively scheduled for October at the Hotel Del Coronado. The convention called by the California Council of Architects replaces the statewide conventions of the State Association.

Vincent Palmer, Architect, Los Angeles, is General Chairman.

* * *

The San Francisco Architectural Club has formed a College of Architecture to augment the "on-the-job" training program now in effect in architects' offices. Ralph Pollack will conduct the first series on "drafting technique."

* * *

John Bakewell, Jr., Architect, has been named a member of the civilian committee for review of Civil Production Administration construction permit applications.

(Continued on Page 34)

WITH THE ENGINEERS

Structural Engineers Association of
Northern California

W. Adrian, President; William W. Moore, Vice-President; Franklin P. Ulrich, Sec-Treas.; John A. Blume, Ass't. Sec-Treas.; Offices 214 Old Mint Building, San Francisco, Phone GARfield 3890. DIRECTORS, H. M. Engle, Mark Falk, and M. V. Pregnoff.

American Society of Civil Engineers
San Francisco Section

Theodore P. Dresser, Jr., President; Leon H. Nishkian and Sidney T. Harding, Vice-Presidents; John E. Rinne, Secretary-Treasurer; 225 Bush Street, San Francisco 20.

Puget Sound Council (Washington)
Engineering & Technical Societies

R. E. Kistler, A. I. E. E., Chairman; A. L. Miller, A.S.C.E., Vice-Chairman; L. B. Cooper, A.S.M.E., Secretary; B. A. Travis, I.E.S., Treasurer; Offices, Seattle, Washington.

STRUCTURAL ENGINEERS ASSOCIATION OF NORTHERN CALIFORNIA

In an effort to secure funds for the Section of Seismology of the United States Coast and Geodetic Survey, Department of Commerce, to use in obtaining data on earthquakes, the Association has filed a request with Secretary of Commerce Henry A. Wallace.

The data compiled by the Section of Seismology is extremely helpful to structural engineers in designing structures to resist seismic forces and is

therefore of great importance to the general public, not only in terms of economical design of earthquake resistant buildings, but also from the standpoint of saving lives.

Such additional information as may be gathered together, is particularly important at this time when so many building codes are being modernized in expectation of a period of great construction activity.

* * *

Mr. Leon C. Bibber, nationally known welding engineer of the Carnegie-Illinois Steel Corporation, spoke before a joint meeting of the San Francisco Section of the American Society of Civil Engineers Association recently.

He emphasized the importance of design in construction and the flexibility of use of welding in building. The subject "The Elements of Welded Design" was well portrayed with lantern slides.

* * *

Ernest D. Francis has moved into new offices at 1012 J Street, Sacramento.

* * *

Henry J. Degenkolb has become associated with John J. Gould in the Financial Center Building, San Francisco.

* * *

ANNUAL CONVENTION — The annual State Convention of the Structural Engineers Association of California will be held in Fresno, October 11, 12, 13. C. D. Wailes, Jr., of the firm of Wailes-Bageman, Los Angeles, is chairman.

AMERICAN SOCIETY OF CIVIL ENGINEERS PICK KANSAS CITY FOR FALL MEETING

Kansas City, Missouri, has been awarded the 1946 Fall Meeting of the American Society of Civil Engineers, it has been announced by Col. William N. Carey, Secretary and Executive Officer, at the Society's national headquarters in New York.

Dates of the meeting are October 16-19, and some 800 members of the 93-year-old Society, oldest national engineering organization in the country, are expected to attend. Several technical sessions, at which water supply, sewage disposal, highways, airports, city planning and other civil engineering matters will be discussed, will mark the sessions. At a general meeting opening day, W. W. Horner, St. Louis consulting engineer, national president, will deliver an address. Tours of engineering and historic interest are being arranged for the visiting engineers and their families.

John C. Long, of the Kansas City construction company bearing his name, is president of the Kansas City local section of the Society, which will be host to the meeting. He heads a committee arranging for the sessions. Ernest E. Howard, Kansas City consulting engineer, is the national

GOOD CONSTRUCTION DEMANDS

3 HINGES TO A DOOR



Society's vice president in the district in which the meeting will be held, and is cooperating in making the arrangements.

ENGINEERS NAMED ON COLUMBIA BASIN PROJECT

H. A. Parker, irrigation engineer on the Columbia Basin project, has named the following engineers to help direct construction of the irrigation system:

Subdistrict One. Main Canal from South Coulee Dam to Long Lake, including the Bacon siphon and tunnel, Roger H. Robertson, resident engineer, and Elmer J. Nieham, assistant.

Subdistrict Two. Long Lake Dam and 6½ miles of main canal extending southwesterly from Long Lake Dam, Philip M. Noble, resident engineer, and Walter W. Brenner, assistant.

Subdistrict Three. West Canal, from the Division Works to the Soap Lake siphon, also a portion of the East Low Canal, Floyd S. Arnold, resident engineer, and H. M. Sheere, assistant.

Subdivision Four. Potholes Dam and reservoir, Raymond C. Pike, assistant. The resident engineer will be named later.

Subdivision Five. Pasco Pumping Unit, Charles W. Seeholzer, resident engineer, and Arthur F. Swanson, assistant.

Subdivision Six. Permanent improvements at Ephrata, Clarence F. Burk, resident engineer.

A.S.C.E. 1946 CONVENTION WILL BE HELD IN SPOKANE

The American Society of Civil Engineers will hold their 74th annual convention in Spokane, Washington, July 17, 18, and 19, preceded by a meeting of the national board of directors on July 15 and 16.

It will be the first annual national convention of the Society to be held since 1943, and the first ever to be held at Spokane.

W. D. Shannon, member of the national board of directors in charge of the district comprising Oregon, Washington, Idaho, Montana, Alaska, and British Columbia, said many members of the 94-year-old organization will be in attendance from all parts of the United States.

SCRAP METAL SHORTAGE

A grave shortage of scrap threatens to thwart the steel industry's attempt to regain high production levels, according to the American Iron and Steel Institute.

"Everyone should cooperate in getting scrap into the channels that serve steel mills without delay," declared Robert W. Wolcott, chairman of the Institute's committee on iron and steel scrap.

Strikes in the steel and coal industry are given as the major factors of the current shortages.



Just a reminder...

Built-in telephone outlets are inexpensive



It costs little to install conduit for a number of telephone outlets at the time a house is built...and it's a wise economy, even if only one telephone is needed immediately.

Future telephones can then be added without bringing exposed wires in along baseboards or molding.



Outlets add real value to a house. So plan ahead for them. Your

clients will appreciate your foresight. Call or dial your local Telephone Business Office and ask for free Architects' and Builders' Service.



The Pacific Telephone and Telegraph Co.



A. I. A. ACTIVITIES

(Continued from Page 31)

The June meeting of the Building Industry Conference Board was devoted to the relationship of the Architect to the General Contractor, with particular emphasis on bidding practice and segregated contracts. A special committee of Architects, Engineers and Contractors will be named to study and formulate a standard for bidding procedure. Wayne Hertzka, Architect, acted as Chairman of the meeting.

BUILDING COSTS ARE REPORTED IN SURVEY BY EAST-BAY ARCHITECTS

The East Bay Association of Architects has carried on a survey of home building costs under the guidance of A. Lewis Koue, Architect.

The survey classes houses in three major groups and considers factors such as room count, number of baths, type of heating, and nature of the site. The low figure of \$5.50 per square foot for a house of 2500 square feet appears to date from mid-1945. This price level is often quoted by multiple house builders today. Some Architects have noted costs on single residences as low as \$6.60 per square foot in the last few months, but the rule appears

to be in the neighborhood of \$8.00 to \$10.00 per square foot.

With prices on steel, plumbing, electrical products and lumber steadily rising and with labor obtaining increases there is a steady and substantial rise in commercial construction costs.

M. P. WILKINSON, Architect, has moved to 1012 North La Brea Avenue, Los Angeles, Calif.

VETERANS FINANCING COSTS REDUCES UNDER FHA PROGRAM

Veterans buying or building new homes will find their financing costs reduced under the current FHA program.

Maximum interest rate is now 4 per cent instead of the 4½ per cent on a FHA insured loan under Title VI of the National Housing Act. The FHA mortgage insurance premium of ½ of 1 per cent remains the same.

In the case of combined financing consisting of an FHA-insured loan for 80 per cent of FHA's replacement cost estimate and a Veterans' Administration loan for 20 per cent of purchase price, the total monthly payment to principal, interest, and mortgage insurance amounts to \$5.47 per \$1000.

F. H. SLOCOMBE, Architect, has moved to 1463 Trestle Glen Road, Oakland, California.

U. C. DORMITORY PROGRAM

The \$4,400,000 appropriated by the California Legislature for University of California dormitories has been allocated among the four major campuses with Berkeley receiving 55 per cent of the total, Los Angeles 36 per cent, Santa Barbara 6 per cent, and Davis 3 per cent.



The appropriation is to be matched by a similar amount to come from either federal or regents' funds, donations, or by issuance of bonds.

Building of the dormitories will begin as soon as possible.

TOM BURNS, Architect, and WYMAN K. BEAR, Associate Architect, are now located in new offices at 3604 Northeast Broadway, Portland, Oregon.

PLUMBING STANDARDS

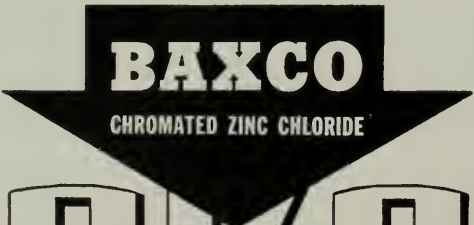
Emergency plumbing standards developed in collaboration with plumbers' organizations and applied in the war housing program in lieu of local plumbing codes are reported by the FHA to have saved an estimated \$12 million in the construction of some 500,000 dwelling units. Critical materials saved totaled roughly 67,500,000 pounds.

PRESSURE TREATED LUMBER
● **PROTECTS AGAINST DECAY
AND TERMITE ATTACK**

*Specify it in your home
Available through Lumber Dealers*

LOS ANGELES 601 W. 5th Street Phone Michigan 6294	SAN FRANCISCO 333 Montgomery Street Phone DOugles 3883
---	--

J. H. Baxter & Co.

AGENTS FOR WEST COAST WOOD PRESERVING CO. SEATTLE, WASH

HEADLINE NEWS & VIEWS

By E. H. W.

George Sommers, Sylvanic Electric Products' Pacific coast sales manager thinks: "Home owners are so steeped in the conventional incandescent lighting tradition that only thru the adoption of an entirely different residential lighting medium can they be jolted from their present disinterested and complacent attitude toward artificial illumination in any form."

* * *

Average six-room houses being built today are costing \$2,000 to \$3,000 more than they should because of a serious dislocation in the distribution of essential materials.—N. Y. Journal of Commerce survey.

* * *

Formal re-opening of the G-E Lighting Institute at Nela Park in Cleveland, Ohio, has been set for the week of August 5. Long recognized for its educational displays and demonstrations, the Institute has been completely rebuilt to incorporate the newest and most modern trends in lighting.

* * *

"In spite of shortages of skilled workers, critical materials and machinery parts, the wall and floor tile industry is currently running nearly double the 1945 rate, and will reach a rate of 88-million square feet by the end of the year."—Charles H. Burchenal, Tile Council of America.

* * *

Business and professional organizations of San Francisco have submitted recommendations to H. C. Vensano, director of public works of the City and County of San Francisco, for consideration in the city's new Building Code which will soon go before the Board of Supervisors for adoption.

* * *

The NHA reports that "Mayor's Emergency Housing Committees" have been established in more than 340 cities, covering 90 per cent of the country's major population centers. They are being assisted by more than 90 locality expeditors.

* * *

Portland and Eugene, Oregon, have set up a "pool" where all building materials in the area are recorded, thus permitting local builders to speedily locate dealers who can supply their needs.

* * *

Farm building construction, usually not subject to urban building codes and zoning controls, represents approximately 5 per cent of all construction.

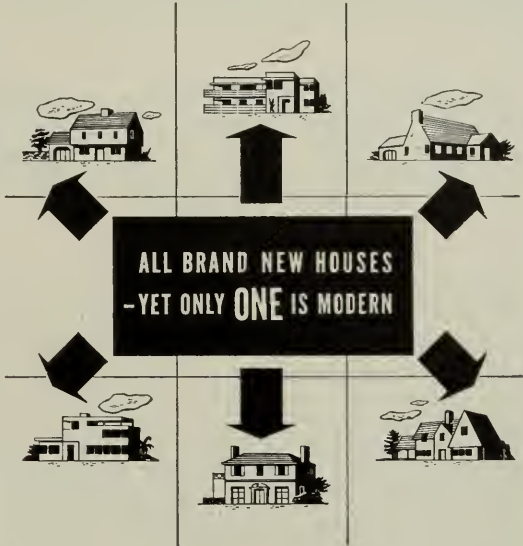

Homes may be as **new** as tomorrow, but they can not be **modern** unless they are wired to provide convenient, efficient electrical service for present and future needs.

New and improved lighting and a host of new appliances are on their way . . . and the wiring system in the modern home must permit its owner to plug in where and when wanted, with full power for satisfactory, economical operation.

Adequate wiring for a modern home means simply: plenty of conveniently placed outlets and switches, and enough circuits of large enough wire to handle electrical equipment for years ahead.

Adequate wiring means so much and costs so little. No other single item will do more to keep the home you design up-to-date, protect the owner's investment and give a greater return in better living.

Make sure the new homes you design are **modern**. Specify adequate wiring.

NORTHERN CALIFORNIA ELECTRICAL BUREAU

1355 Market Street San Francisco 3

IN THE NEWS

OREGON BUILDING

Thirty-two private building projects aggregating an estimated cost of \$4,110,000 are planned for immediate construction, according to a report by Oregon's Postwar Readjustment and Development Commission.

A large scale building program for State institutions, aggregating more than \$9-million in estimated costs, has been drawn up by the Oregon State Board of Control and is announced by R. H. Mills, secretary.

Architects have been selected for \$5,418,000 worth of work at ten institutions, while construction projects totaling about \$3-million for which no architects have as yet been selected are planned for seven institutions.

The institutions at which work will be done, type of building, estimated cost and architect, are as follows:

Eastern Oregon State Hospital, Pendleton; Leslie D. Howell, architect, Portland; Admission hospital \$392,000 and Nurses' Home Addition, \$100,000.

State Penitentiary at Salem; Barrett & Logan, architects, Portland; Cell block, \$200,000 and Chapel remodeling \$90,000. Fairview Home, Patients' cottage, \$118,000 and Dormitory \$205,000.

Eastern Oregon TB Hospital, The Dalles; Jones & Marsh, architects, Portland; Dormitory \$110,000.

State Hospital Farm, Salem; Sutton, Whitney & Aandahl, architects, Portland; Ward building \$325,000.

State Hospital, Salem; Sutton, Whitney & Aandahl, architects, Portland; Ward building \$340,000; and Treatment hospital, Pietro Belluschi, architect, Portland, \$800,000.

Hillcrest School of Oregon, Salem; Stokes & Allyn, architects, Portland; School building \$173,000; Girls' dormitory \$150,000, and food and cold storage building \$30,000.

State Training School, Woodburn; Tom Burns, architect. Portland; School buildings, \$134,000, Boys' dormitory \$57,500, and Segregation cottage \$94,000.

School for the Deaf, and School for the Blind at Salem; Wolff & Phillips, architects, Portland; School dormitory \$250,000, and School buildings \$155,000.

C. L. HANMAN has been named Manager of Advertising and Sales Market Research for the Columbia Steel Company, San Francisco.

DOUGLAS FIR PLYWOOD

W. E. Difford, managing director of the Douglas Fir Plywood Association for the past eight years, resigned on July 1, 1946.

During his tenure with the Association Difford received national recognition for his promotion of the plywood industry and development of an all-year demand for plywood products.

Harrison Clark of Tacoma, Washington, assistant to Difford, has been named acting managing director by the Association's management committee.

W. P. DAY & ASSOCIATES, Architects and Engineers, have moved to 111 New Montgomery St., San Francisco.

APPLIANCE SERVICE CENTER

At Dallas, Texas, the General Electric Company's Appliance & Merchandising Department is establishing a combined appliance service center and attic ventilating fan factory in a 15,000 square foot building.

It is the Company's first appliance repair station in the southwest; will handle the servicing of small G-E appliances, and will stock a full line of parts for all G-E appliances.



LOS ANGELES
—•—
OAKLAND
SAN FRANCISCO

IN THE NEWS

NAMED ARCHITECT

Arthur Cobblestick, Palo Alto, California, architect, has been named landscape architect for the San Mateo County Fair Association and will work out building interiors as well as landscaping of the grounds.

SMALL BUSINESS

A Small Business Division has been created in the Reconstruction Finance Corporation to serve small business in view of their importance to the national economy, full employment and full production.

PLYWOOD SUBSIDY

Premium payments on peeler logs needed for the manufacture of plywood will amount to \$400 million in a plan announced by the NHA to stimulate production of plywood products for veterans' housing.

NEW WARDEN VALVE

Instantly shuts off flow of any fluid when pressure drops below predetermined level thereby protecting against pressure drops or ruptured pipe lines.

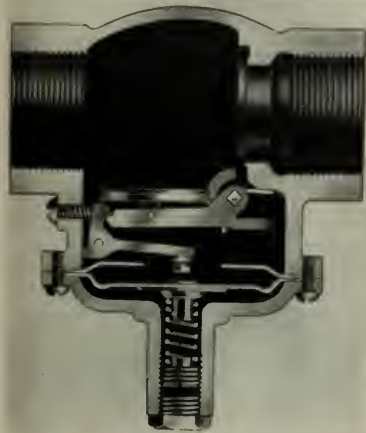

Easily installed in gas or oil supply lines for industrial furnaces, institutional heating plants, public utility supply systems, the new Warden Valve (manufactured by the Security Valve Company of Los Angeles) is available in sizes 1½" to 8" diameter.

CHAS. W. ELIOT, Landscape Architect, has moved into new offices at 720 S. San Rafael Avenue, Pasadena 2, California.

The ROCKET

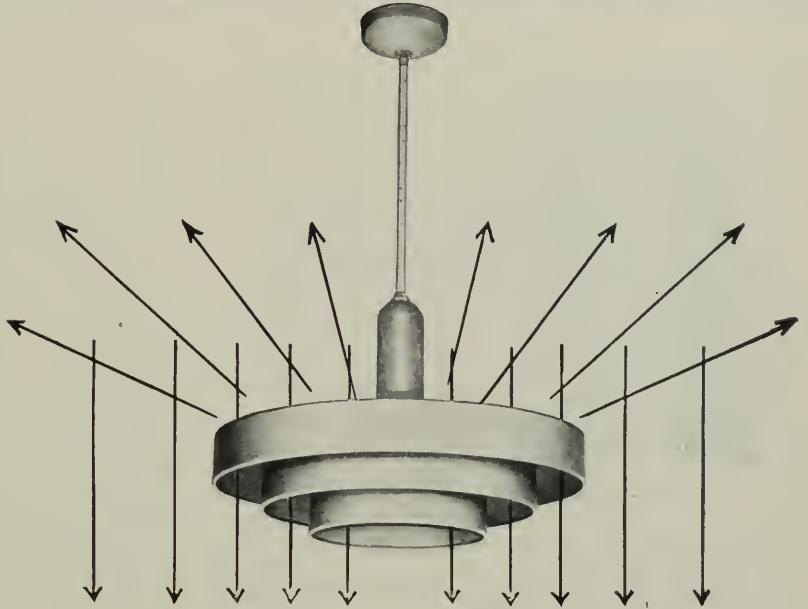

An improved principle in indirect lighting, providing a minimum of interference to the normal wide light distribution from a silvered bowl lamp, and minimum interception of reflected light. The three concentric, satin-aluminum finished flanged steel rings are set in rigid assembly that can't support dirt, paper wads or insects. Ideal for schools, offices, commercial installations. Write for bulletin and prices.

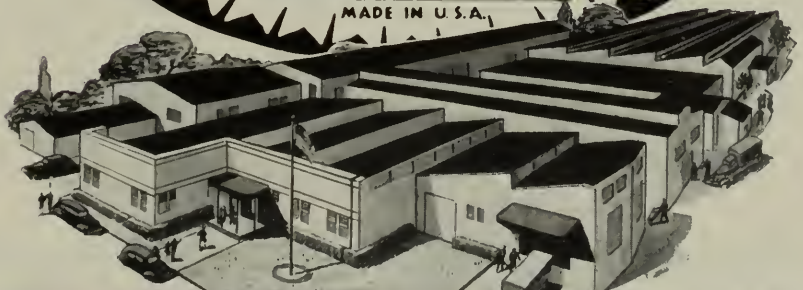

Offices in Principal Western Cities—Branch and Warehouse in San Francisco

PRODUCER'S COUNCIL PAGE

The National Organization of Manufacturers of Quality Building Materials and Equipment
affiliated with THE AMERICAN INSTITUTE OF ARCHITECTS

President, E. E. CATHCART
Johns-Manville Sales Corp.
116 New Montgomery St.

Vice-President, C. J. NICHOLAS
Bastion-Morley Co.
301 Brannan St.

Secretary, H. C. GALITZ
Westinghouse Electric Corp.
110 Sutter St.

Treasurer, E. P. LARSON
Celotex Corp.
675 Townsend St.

Edited by C. W. KRAFT, KRAFTILE CO., Niles, California

NORTHERN CALIFORNIA CHAPTER



V. R. "Rev" Reynolds

V. R. "Rev" Reynolds, new Branch Manager for Chamberlin Company of America (metal weather strips) comes from a similar position in Atlanta. No stranger to Council activities, energetic "Rev" (wonder if that stands for "r.p.m.") was one of the organizers of the new Atlanta Chapter and its second President, making him a valuable addition to our Chapter.

Another young man who headed west, "Rev" was born in Pawtucket, R. I., so it wasn't possible to start much farther east. He started as a salesman for Chamberlin in Hartford, Conn., in 1935 and has steadily climbed in the organization since.

He is married, has two boys age 10 and 12. Lives in San Francisco. He is a member of the Federation of Sales Executives and his favorite sport is baseball.

OUR CHAPTER is one of the few in the country that operates on a year-around basis. So don't forget, the first Monday in July and August are as good a time to meet and eat with the gang as any other months in the year.

IF YOU ARE AN ARCHITECT don't hesitate to show up at Room "A" Palace Hotel. Council members will be there to greet you. Interesting programs are planned throughout the summer. And—

IF YOU ARE LUCKY (no reflection) the Savings Bond drawing continues. Guests and members alike are eligible.

MODULAR COORDINATION IN FRANCE. Some while ago, we were advised that a system of modular coordination was developing in France. A review, Technical Articles, in this issue includes one on Technique, from which we quote:

"Plugging the module system of planning, M. Belancy-Bearm says it is not logical to standardize the parts of a building without developing some standard of measure for the whole, a module. One of the state bureaus has already supervised and published a sort of Sweet's Catalog and a Graphic Standards is in print. The dimensions and modules given in these publications are not mandatory, but it is to be hoped that architects will, in interest of national economy and recovery, use them almost exclusively."

MODULAR DESIGN AT U.C.L.A. Architect John C. Austin of Los Angeles is observing modular standards in the design of new buildings for the University of California Los Angeles Branch. Modular brick samples submitted by Gladding, McBean & Co. are $11\frac{1}{2} \times 3\frac{1}{2} \times 2\frac{3}{16}$ ". The building industry should be grateful for the pioneers who are bringing modular coordination into use.

MODULAR MOMENTS

Question: Won't modular coordination result in regimentation?

Mr. Lorimer: Actually, modular coordination always has been, always will, and can only be a purely voluntary measure, which has been pioneered and supported by the cooperation of forward looking architects and producers. Instead of constricting the genius of the architect, it gives him more time for the actual designing.



USE QUALITY PRODUCTS



CONSULT AN ARCHITECT

IN THE NEWS

DELTA-MENDOTA CANAL

Hubert H. Everist, Sr., of San Francisco will begin work on the great Delta-Mendota Canal, key link in the chain of watercourses comprising the irrigation system of the Central Valley Project, with construction of a 13-mile sector along the eastern slope of the Livermore hills.

His low bid was \$3,530,067.50.

The Canal is a concrete-lined river 100 feet wide and 15 feet deep which will carry Sacramento River water 120 miles into the San Joaquin valley to Mendota where a reservoir will feed water to the San Joaquin River lands, 4600 cubic feet of water per second can be accommodated at a canal grade of 4 inches to the mile.

I. E. S. MEDAL AWARD

The Illuminating Engineering Society medal which is awarded in recognition of meritorious achievement, and which has conspicuously furthered the profession, art, and knowledge of illuminating engineering, has been given to Eugene C. Crittenden, Chief of the Electrical Division, National Bureau of Standards, Washington, D. C.

Highest honor in the field of lighting, the medal was awarded to Crittenden for his contribution to the development and establishment of acceptable standards and units for the measurement of light.

ENGINEERING SERVICE CONSOLIDATES

The Acme Engineering Service of Portland, Oregon, and the Kelton & Perthou Company of Seattle, Washington, have consolidated under the name of the U. S. Appraisal Company.

Professional appraisal reports and valuation engineering service will be offered to industrial and commercial enterprises for insurance, financial and sale purposes.

Offices of the Company will be maintained in Seattle, Portland and San Francisco.

BACK FROM THE WARS

A. E. Ferguson has resumed his duties as western sales manager of the American Lumber and Treating Company, Los Angeles, after serving in the Pacific theater as Lt. Col. in the field artillery.

He will have charge of sales operations through Los Angeles and San Francisco for the states of California, Oregon, Washington, Idaho, Nevada, Utah, Arizona and New Mexico.

LESLIE I. NICHOLS, Architect, has moved to 145 Addison Avenue, Palo, Alto, California.

STRUCTURAL STEEL

For Class A Buildings,
Bridges, etc.

JUDSON PACIFIC - MURPHY CORP.

1200 SEVENTEENTH STREET
SAN FRANCISCO

Plants: San Francisco - Oakland

SISALKRAFT

REG. U. S. PAT. OFF.

"More than a building paper"

THE SISALKRAFT CO.

205 West Wacker Drive
Chicago, Ill.

55 New Montgomery Street
San Francisco, Calif.

BASALITE

LIGHTWEIGHT CONCRETE
BUILDING UNITS

CHARACTER • ECONOMY • INSULATION
FIRE-SAFE • TERMITE PROOF • PERMANENCE

BASALT ROCK CO., INC.
NAPA, CALIFORNIA

FORDERER CORNICE WORKS

Manufacturers of

Hollow Metal Products • Interior Metal Trim
Elevator Fronts and Cabs
Metal Plaster Accessories • Sanitary Metal Base
Flat and Roll Metal Screens
Metal Cabinets • Commercial Refrigerators

269 POTRERO AVE.
SAN FRANCISCO, CALIF. HEMLOCK 4100

SOME HEALTH HAZARDS WITH PAINT REMOVERS

(Continued from Page 11)

rule mentioned, a safe and effective paint remover can be made up as follows: Ethyl acetate and acetone in equal parts; paraffin—a small amount to promote adhesion. This was recommended as a substitute for the hazardous solvents in common use,—but it was apparently not effective enough to remove them actually from commercial use.

The report of Dr. Smith warns of chlorinated hydrocarbon paint removers. Mixtures of these substances are used in the field of paint and varnish solvents because they combine the two advantages of high solvent efficiency and non-inflammability. Such mixtures may be very complex chemically and may contain substances the influence of which on the body is hardly known. In fact, the paint remover used in the fatal case mentioned was not known in details even to the manufacturer; he stated that the mixture is so complex and the boiling points overlap to such an extent that an exact analysis had never been made. This solution was used on the interior of elevators with no special arrangements for ventilation and without respiratory protection.

The mixture contained chloroform, carbon tetrachloride and the higher chlorides of ethane, propane, butane and pentane. Of these, Dr. Smith

pointed out, chloroform is the least and tetrachloroethane the most poisonous substance,—the latter being considered to be four times as poisonous as chloroform. The conclusion of the report was that chlorinated hydrocarbon paint removers, no less than those containing benzol, have poisonous potentialities and should not be used without particular regard to ventilation.

Removing paint means frequently removing dust and germs contained in the wall dust. This is particularly true in redecorating walls of sick rooms or hospital rooms. Removing old paint from those walls brings the germs coughed out or sneezed out and dried, back into circulation. Painting by itself destroys many germs particularly as certain ingredients of paints are poisonous for bacteria.

GREAT CENTRAL VALLEY

Controversial issues in the development of the water resources of the Great Central Valley of California are analyzed in a 276-page report published by the Bureau of Agricultural Economics, entitled "History of Legislation and Policy Formation of the Central Valley Project."

The report traces water planning in California by Federal and State agencies from the Alexander investigation of 1873 to the adoption of the Central Valley Project Act of 1933. Policy development since approval of the project as a Bureau of Reclamation project in 1935 comprises the latter half of the report.

The material was drawn entirely from public records and is fully documented by reference to these records. Six appendices include important legislative and administrative acts and other basic documents significant for a study of the project's history.

VARLON INTRODUCED

A revolutionary stainproof wall covering called "VARLON" is being marketed this month by Varlon, Inc., a division of United Wallpaper, Inc., Chicago, Ill.

The new product is the result of nine years laboratory research and development and will permit the removal of almost any type of dirt, grease or stain by the simple application of soap and water.

Field tests, conducted for months in government office buildings, restaurants, theaters, and hotels, have proven that indelible stains such as lipstick, hot grease, crayon, and ink, require only soap and water for removal.

The new stainproof wall covering, according to the manufacturer, should not be confused with wallpaper.

DESIGNED TO USE

In the development of your business . . . now and in the postwar era.

Many subscribers to *Architect's Reports* find these ADVANCE building surveys . . . giving name of project, location, architect, proposed cost and other pertinent information a "must have" service to their business planning.

Data furnished you DAILY at a cost of \$10 per month.

Phone EXbrook 7182 — Subscribe Today

ARCHITECT'S REPORTS

Published Daily by

ARCHITECT and ENGINEER, Inc.

68 Post Street, San Francisco

EXbrook 7182

ESTIMATOR'S GUIDE

BUILDING AND CONSTRUCTION MATERIALS

PRICES GIVEN ARE FIGURING PRICES AND ARE MADE UP FROM AVERAGE QUOTATIONS FURNISHED BY MATERIAL HOUSES TO SAN FRANCISCO CONTRACTORS. 2½% SALES TAX ON ALL MATERIALS BUT NOT LABOR

All prices and wages quoted are for San Francisco and the Bay District. There may be slight fluctuation of prices in the interior and southern part of the state. Freight cartage, at least, must be added in figuring country work.

BONDS—Performance—\$10 per \$1000 of contract. Labor and materials, \$10 per \$1000 of contract.

BRICKWORK—

Common Brick—Per 1M laid—\$50.00 to \$60.00 (according to class of work).
 Face Brick—Per 1M laid—\$120 to \$150 (according to class of work.)
 Brick Steps—\$1.60 per lin. ft.
 Brick Veneer on Frame Bldg.—Approx. \$1.30 per sq. ft.
 Common Brick—\$19.00 per M, truckload lots, f.o.b. job.
 \$19.00 per M, less than truckload, plus cartage.
 Face Brick—\$40 to \$80 per M, truckload lots, delivered.
 Cartage—Approx. \$4.00 per M.

BUILDING PAPER—

1 ply per 1000 ft. roll.....\$3.50
 2 ply per 1000 ft. roll..... 5.00
 3 ply per 1000 ft. roll..... 6.25
 Brownskin, Standard, 500 ft. roll..... 5.00
 Sisalkraft, 500 ft. roll..... 5.00
 Sash cord com. No. 7.....\$1.20 per 100 ft.
 Sash cord com. No. 8..... 1.50 per 100 ft.
 Sash cord spot No. 7..... 1.90 per 100 ft.
 Sash cord spot No. 8..... 2.25 per 100 ft.
 Sash weights, cast iron, \$50.00 ton.
 Nails, \$3.42 base.
 Sash weights, \$45.00 per ton.

CONCRETE AGGREGATES—

The following prices net to Contractors unless otherwise shown.
 Gravel, all sizes—
 \$1.95 per ton at Bunker; delivered\$2.50

	Bunker	Del'd
Top Sand	\$1.90	\$2.50
Concrete Mix	1.90	2.45
Crushed Rock, ¼" to ¾".....	1.90	2.50

Crushed Rock, ¾" to 1½".....	1.90	2.50
Roofing Gravel	2.25	2.80
River Sand	2.00	2.45

Sand—

River Sand	2.00	2.45
Lapis (Nos. 2 & 4).....	2.85	3.15
Olympia (Nos. 1 & 2).....	2.85	3.10
Del Monte White84c per sack	

Cement—

Common (all brands, paper sacks), carload lots, \$2.42 per bbl. f.o.b. car; delivered \$2.72.
 Cash discount on carload lots, 10c a bbl., 10th Prox.; less than carload lots \$3.20 per bbl. f.o.b. warehouse or delivered.
 Cash discount 2% on L.C.L.

Atlas White	} 1 to 100 sacks, \$2.50 sack warehouse or del.; \$7.65 bbl. carload lots.
Calaveras White	
Medusa White	

Forms labor average \$350 per 1000 sq. feet.
 Average cost of concrete in place, 50c per cubic foot, exclusive of forms; \$15.00 per cubic yard. With forms \$1.60 per cubic foot.

DAMP-PROOFING and Waterproofing—

Two-coat work, \$3.50 per square.
 Membrane waterproofing—4 layers of saturated felt, \$7.00 per square.
 Hot coating work, \$2.50 per square.
 Medusa Waterproofing, \$3.50 per lb. San Francisco Warehouse.
 Tricocel waterproofing.
 (See representative.)

ELECTRIC WIRING—\$12 to \$15 per outlet for conduit work (including switches).

Knob and tube average \$3.00 per outlet. (Available only for priority work.)

ELEVATORS—

Prices vary according to capacity, speed and type. Consult elevator companies. Average cost of installing a slow speed automatic passenger elevator in small four story apartment building, including entrance doors, about \$6500.00.

EXCAVATION—

Sand, 60 cents; clay or shale \$1 per yard.

Trucks, \$20 to \$32 per day.

Above figures are an average without water. Steam shovel work in large quantities, less; hard material, such as rock, will run considerably more.

FIRE ESCAPES—

Ten-foot galvanized iron balcony, with stairs, \$150 installed on new buildings; \$160 on old buildings.

FLOORS—

Composition Floors, such as Magnesite, 50c per square foot.
 Linolor—2 gages—\$1.25 to \$2.75 per sq. yd.
 Mastopave—90c to \$1.50 per sq. yd.
 Battleship Linoleum—available to Army and Navy only—1/8"—\$1.75 sq. yd. 3/8"—\$2.00 sq. yd.
 Terazzo Floors—50c to 70c per sq. ft.
 Terazzo Steps—\$1.75 per lin. ft.
 Mastic Wear Coat—according to type—20c to 35c.
Hardwood Flooring—
 Standard Mill grades not available.
 Victory Oak—T & G
 3/4" x 2 1/4".....\$143.25 per M. plus Cartage
 1/2" x 2"..... 122.00 per M. plus Cartage
 1/2" x 1 1/2"..... 113.50 per M. plus Cartage
 Prefinished Standard & Better Oak Flooring
 3/4" x 3 1/4".....\$180.00 per M. plus Cartage
 1/2" x 2 1/2"..... 160.50 per M. plus Cartage
Maple Flooring
 3/4" T & G Clear \$160.50 per M. plus Ctg.
 2nd 153.50 per M. plus Ctg.
 3rd 131.25 per M. plus Ctg.
 Floor Layers' Wage, \$1.50 per hr.

GLASS—

Single Strength Window Glass.....	20c per	□ ft.
Double Strength Window Glass.....	30c per	□ ft.
Plate Glass, under 75 sq. ft.....	\$1.00 per	□ ft.
Polished Wire Plate Glass.....	1.40 per	□ ft.
Obscure Glass34 per	□ ft.
Glazing of above is additional.	.27 per	□ ft.
Glass Blocks	\$2.50 per	□ ft. set in place

HEATING—

Average, \$1.90 per sq. ft. of radiation, according to conditions.
 Warm air (gravity) average \$48 per register.
 Forced air, average \$68 per register.

IRON—Cost of ornamental iron, cast iron, etc., depends on design.

LUMBER—All lumber at O.P.A. ceiling prices—

No. 1 Common	\$49.00 per M
No. 2 Common	47.75 per M
Select O. P. Common	52.75 per M

Flooring—

	Delvd.
V.G.-D.F. B & Btr. 1 x 4 T & G Flooring	\$80.00
C 1 x 4 T & G Flooring	75.00
D 1 x 4 T & G Flooring	65.00
D.F.-S.G. B & Btr. 1 x 4 T & G Flooring	61.00
C 1 x 4 T & G Flooring	59.00
D 1 x 4 T & G Flooring	54.00
Rwd. Plastic—"A" grade, medium dry	82.00
"B" grade, medium dry	78.50

Plywood—not available

	Under \$200	Over \$200
"Plyscord"— $\frac{3}{8}$ "	\$49.50	\$47.55
"Plywall"— $\frac{1}{4}$ "	45.15	43.30
3 ply— $2\frac{1}{2}$ "— $\frac{1}{4}$ "	48.55	46.60
"Plyform"— $\frac{3}{8}$ "—		
Unoiled	126.50	121.45
Oiled	127.90	122.75

Above prices delivered if quantity is sufficient to warrant delivery.

Shingles (Rwd. not available)—

Red Cedar No. 1—\$6.75 per square; No. 2, \$5.75; No. 3, \$4.45.
Average cost to lay shingles, \$3.00 per square.
Cedar Shakes—Tapered: $\frac{1}{2}$ " to $\frac{3}{4}$ " x 25"—\$8.95 per square.
Resawn: $\frac{3}{4}$ " to $1\frac{1}{4}$ " x 25"—\$10.65 per square.
Resawn: $\frac{3}{4}$ " to $1\frac{1}{4}$ " x 25"—\$10.65 per square.
Average cost to lay shakes, \$4.00 per square.

MILLWORK—Standard.

D. F. \$100 per 1000. R. W. Rustic \$100.00 per 1000 (delivered).
Double hung box window frames, average with trim \$6.50 and up, each.
Complete door unit, \$10.00.
Screen doors, \$3.50 each.
Patent screen windows, 25c a sq. ft.
Cases for kitchen pantries seven ft. high, per lineal ft., \$9.00 each.
Dining room cases, \$9.00 per lineal foot.
Rough and finish about 80c per sq. ft.
Labor—Rough carpentry, warehouse heavy framing (average), \$40.00 per M.
For smaller work average, \$40.00 to \$55.00 per 1000.

MARBLE—(See Dealers)

PAINTING—

Two-coat work	per yard 50c
Three-coat work	per yard 70c
Cold water painting	per yard 10c
Whitewashing	per yard 8c

PAINTS—

Two-coat work50c per sq. yd.
Three-coat work70c per sq. yd.
Cold water painting.....per yard 10c
Whitewashing 8c per sq. yd.
Turpentine \$1.03 per gal. in drum lots.
\$1.08 per gal. in 5-gal. containers.
Raw Linseed Oil—not available.

Boiled Linseed Oil—\$1.38 per gal. in drums. Available only to work with high priority—\$1.48 per gal. in 5-gal. containers.

Use replacement oil—\$1.86 per gal. in 1-gal. containers.

Replacement Oil—\$1.20 per gal. in drums. \$1.30 per gal. in 5-gal. containers.

A deposit of \$6.00 required on all drums.

PATENT CHIMNEYS—

6-inch	\$1.20 lineal foot
8-inch	1.40 lineal foot
10-inch	2.15 lineal foot
12-inch	2.75 lineal foot

PLASTER—

Neat wall, per ton delivered in S. F. in paper bags, \$17.60.

PLASTERING (Interior)—

	Yard
3 Coats, metal lath and plaster	1.50
Keene cement on metal lath	1.80
Ceilings with $\frac{3}{4}$ hot roll channels metal lath (lathed only)	1.20
Ceilings with $\frac{3}{4}$ hot roll channels metal lath plastered	2.20
Single partition $\frac{3}{4}$ channel lath 1 side (lath only)	1.20
Single partition $\frac{3}{4}$ channel lath 2 inches thick plastered	3.20
4-inch double partition $\frac{3}{4}$ channel lath 2 sides (lath only)	2.20
4-inch double partition $\frac{3}{4}$ channel lath 2 sides plastered	3.85
Thermax single partition; 1" channels; $2\frac{1}{4}$ " overall partition width. Plastered both sides	3.30
Thermax double partition; 1" channels; $4\frac{1}{4}$ " overall partition width. Plastered both sides	4.40
3 coats over 1" Thermax nailed to one side wood studs or joists	1.65
3 coats over 1" Thermax suspended to one side wood studs with spring sound isolation clip	1.90

Note—Channel lath controlled by limitation orders.

PLASTERING (Exterior)—

	Yard
2 coats cement finish, brick or concrete wall	\$1.00
3 coats cement finish, No. 18 gauge wire mesh	2.00
Lime—\$3.00 per bbl. at yard.	
Processed Lime—\$3.10 bbl. at yard.	
Rock or Grip Lath— $\frac{3}{8}$ "—20c per sq. yd.	
$\frac{1}{2}$ "—19c per sq. yd.	

Composition Stucco—\$1.80 to \$2.00 sq. yard (applied).

PLUMBING—

From \$100.00 per fixture up, according to grade, quantity and runs.

ROOFING—

"Standard" tar and gravel, 4 ply—\$8.00 per sq. for 30 sqs. or over.
Less than 30 sqs. \$9.50 per sq.
Tile, \$30.00 to \$40.00 per square.
Redwood Shingles, \$7.50 per square in place.
5/2 #1-16" Cedar Shingles, $4\frac{1}{2}$ " Exposure\$8.00 square

5/8 x 16"—#1 Cedar Shingles, 5" Exposure\$9.00 square
4/2 #1-24" Royal Shingles, $7\frac{1}{2}$ " Exposure\$9.50 square
Re-coat with Gravel \$4.00 per sq.
Asbestos Shingles, \$23 to \$28 per sq. laid.
1/2 x 25" Resawn Cedar Shakes, 10" Exposure\$10.50
3/4 x 25" Resawn Cedar Shakes, 10" Exposure 11.50
1 x 25" Resawn Cedar Shakes, 10" Exposure 12.50
Above prices are for shakes in place.

SHEET METAL—

Windows—Metal, \$1.75 a sq. ft.
Fire doors (average), including hardware \$2.00 per sq. ft.

SKYLIGHTS—(not glazed)

Copper, 90c sq. ft. (flat).
Galvanized iron, 40c sq. ft. (flat).
Vented hip skylights 60c sq. ft.

STEEL—STRUCTURAL—

\$150 ton (erected), this quotation is an average for comparatively small quantities. Light truss work higher. Plain beams and column work in large quantities \$140 per ton.

STEEL REINFORCING—

\$100 to \$130 ton, set.

STONE—

Granite, average, \$6.50 cu. foot in place.
Sandstone, average Blue, \$4.00. Boise, \$3.00 sq. ft. in place.
Indiana Limestone, \$2.80 per sq. ft. in place.

STORE FRONTS (None available).

TILE—

Ceramic Tile Floors—\$1.00 to \$1.25 per sq. ft.
Cove Base—\$1.10 per lin. ft.
Glazed Tile Wainscot—\$1.25 per sq. ft.
Asphalt Tile Floor $\frac{1}{8}$ " & $\frac{3}{8}$ "—\$.18 to \$.35 per sq. ft. Light shades slightly higher.
Cork Tile—\$.40 to \$.75 per sq. ft.
Mosaic Floors—see dealers.
Lino-Tile, \$.35 to \$.75 per sq. ft.

Wall Tile—

Glazed Terra Cotta Wall Units (single faced) laid in place—approximate prices:
2 x 6 x 12\$1.10 sq. ft.
4 x 6 x 12 1.25 sq. ft.
2 x 8 x 16 1.20 sq. ft.
4 x 8 x 16 1.40 sq. ft.

VENETIAN BLINDS—

40c per square foot and up. Installation extra.

WINDOWS—STEEL—

30c per square foot, \$5 for ventilators.

ARCHITECT AND ENGINEER

IN THE NEWS

PREMIUM PAYMENTS

First of the "Premium Payments" setting up a system of incentive payments to manufacturers by the NHA, was issued to the manufacturers of structural clay products.

Covering production of common and face brick, structural clay tile, and structural facing tile, payments of \$5 for each 1000 standard brick equivalents produced in excess of established quotas will be made. Quotas will be established for each individual plant.

With a \$123 million postwar State highway construction program California is in need of from three to five hundred road engineers, according to George T. McCoy, state highway engineer.

AMERICAN STANDARDS CATALOG

A revised list of standards approved by the American Standards Association has been published, entitled "Catalog of American Standards."

The 845 standards listed, including 154 American War Standards, include definitions of technical terms, specifications for metals and other materials, dimensions, safety provisions for the use of machinery, methods of work and methods of test for the finished product.

The standards represent agreement on the part of maker, seller, and user groups as to the best possible practice at the time of approval. They are constantly revised to keep up with mechanical invention, developments of power and new uses of material.

The Economy Pumps, Inc., of Hamilton, Ohio, have acquired the Klipel Manufacturing Company of Chicago, manufacturer of pressure regulators, tank thermostat valves, etc.

BUILDING TRADES WAGE (JOB SITES) NORTHERN AND CENTRAL CALIFORNIA

ATTENTION: The following are the PREVAILING hourly rates of compensation as determined by the Wage Adjustment Board, or which have been determined by the United States Department of Labor—Revised to July 1, 1946. Wage scales shown are those being paid and in effect mostly by agreement between employees and their union.

CRAFT	San Francisco	Alameda and Contra Costa	Marin	Vallejo	San Mateo	San Jose	Stockton	Sacramento	Fresno
ASBESTOS WORKERS	1.75	1.75	1.75	1.75	1.75	1.75	1.75	1.75	1.75
BRICKLAYERS	2.05	2.05	2.05	2.05	2.05	2.05	1.75	2.05	2.00
BRICKLAYERS, HODCARRIERS	1.57 1/2	1.57 1/2	1.57 1/2	1.57 1/2	1.57 1/2	1.57 1/2	1.47 1/2	1.15	1.25
CARPENTERS	1.75	1.75	1.75	1.75	1.75	1.62 1/2	1.50	1.50	1.50
CEMENT FINISHERS	1.75	1.75	1.75	1.75	1.75	1.75	1.75	1.75	1.75
ELECTRICIANS	1.87 1/2	1.87 1/2	1.87 1/2	1.70	1.87 1/2	1.87 1/2	1.75	1.87 1/2	1.75
ENGINEERS: MATERIAL HOIST	1.60	1.60	1.60	1.60	1.60	1.60	1.60	1.60	1.60
PILE DRIVER	2.00	2.00	2.00	2.00	2.00	2.00	2.00	2.00	2.00
STRUCTURAL STEEL	2.00	2.00	2.00	2.00	2.00	2.00	2.00	2.00	2.00
GLASS WORKERS	1.58 1/2	1.58 1/2	1.58 1/2	1.58 1/2	1.58 1/2	1.21	1.40	1.37 1/2	1.37 1/2
IRONWORKERS: ORNAMENTAL	1.85	1.85	1.85	1.85	1.85	1.85	1.85	1.85	1.85
REINF. RODMEN	1.75	1.75	1.75	1.75	1.75	1.75	1.75	1.75	1.75
STRUCTURAL	2.00	2.00	2.00	2.00	2.00	2.00	2.00	2.00	2.00
LABORERS: BUILDING & CONCRETE	1.25	1.25	1.15	1.15	1.15	1.15	1.25	1.25	1.15
LATHERS	1.90	1.90	1.60	1.87 1/2	1.75	2.00	1.87 1/2	1.60	1.87 1/2
MARBLE SETTERS	1.75	1.75	1.75	1.75	1.75	1.75	1.75	1.75	1.75
MOSAIC & TERRAZZO	1.75	1.75	1.75	1.75	1.75	1.75	1.60	1.16	1.12 1/2
PAINTERS	1.75	1.75	1.75	1.64	1.75	1.75	1.60	1.60	1.50
PALEDRIVERS	1.86	1.86	1.86	1.86	1.86	1.86	1.86	1.86	1.86
PLASTERERS	2.00	2.00	1.75	2.00	2.05	2.00	2.00	1.87 1/2	1.87 1/2
PLASTERERS' HODCARRIERS	1.75	1.75	1.75	1.75	1.75	1.75	1.65	1.65	1.60
PLUMBERS	1.87 1/2	1.87 1/2	1.87 1/2	1.87 1/2	1.87 1/2	1.87 1/2	1.87 1/2	1.87 1/2	1.87 1/2
ROOFERS	1.50	1.62 1/2	1.50	1.62 1/2	1.25	1.37 1/2	1.50	1.50	1.50
SHEET METAL WORKERS	1.75	1.75	1.75	1.75	1.75	1.75	1.75	1.75	1.75
SPRINKLER FITTERS	1.58	1.58	1.58	1.58	1.58	1.58	1.58	1.58	1.58
STEAMFITTERS	1.87 1/2	1.87 1/2	1.87 1/2	1.87 1/2	1.87 1/2	1.87 1/2	1.87 1/2	1.87 1/2	1.87 1/2
STONESETTERS (MASONS)	2.05	2.05	2.05	2.05	2.05	2.05	1.75	2.05	2.00
TILESETTERS	1.80	1.75	1.75	1.75	1.75	1.75	1.37 1/2	1.37 1/2	1.37 1/2

Prepared and compiled by

CENTRAL CALIFORNIA CHAPTER, ASSOCIATED GENERAL CONTRACTORS OF AMERICA

with the assistance and cooperation of secretaries of General Contractors Associations and Builders Exchanges of Northern California.

CLASSIFIED ADVERTISING

RATE: 8c PER WORD . . . CASH WITH ORDER

MINIMUM \$1.50 (3 Lines)

ARCHITECT'S REPORTS—A valuable advance news service giving building and construction information daily on projects in Northern California. Name, location, architect, proposed cost, etc., on individual slips. Ideal for securing new business leads. Hundreds of items, total monthly cost only \$10. Don't delay, subscribe today. ARCHITECT & ENGINEER, Room 618, 68 Post Street, San Francisco, California. Phone DOuglas 8311.

ARCHITECTS—A. McF. McSweeney, Architect, Room 927 Hearst Bldg., San Francisco. New offices. Desires catalogs.

PHOTOGRAPHY—Keep a pictorial record of your building, or construction project. Pictures are of tremendous value to contractors, builders, engineers, architects. For Industrial-Publicity-Aerial photography, see

FRED MAE, Room 721-22 Hearst Bldg., San Francisco 3, California.

PRINTING—Printers, bookbinders. See us for commercial printing. Mercury Press, 942 Howard Street, San Francisco.

WANTED—Architectural designer capable of taking charge of office, general practice. Excellent opportunity. Telephone Hlgate 6449, Oakland, California.

A PROGRAM FOR URBAN PLANNING

(Continued from Page 10)

Committee should be approved by the Chairman to explore the question of education of the public. Much has already been done in this field, and the Committee's first function should be the promotion of local effort.

4. The Committee should keep track of and report on national legislation affecting urban planning so as to be able to recommend to the Chapters and to The Institute, official ac-

tion and attitudes to be taken with the press and at Congressional hearings.

5. A paid executive secretary to assist the Committee is an essential requisite for carrying out the program.

UTILITY APPLIANCE CORPORATION ACQUIRE GAFFERS & SATTLER

The Utility Appliance Corporation of Los Angeles, manufacturers of evaporative air coolers, fans, blowers and gas fired heating equipment, have acquired the firm of Gaffers & Sattler, Los Angeles, and the Occidental Stove Company of Irvington, California.

CLINTON CONSTRUCTION CO. OF CALIFORNIA

General Contractors

923 FOLSOM STREET • SAN FRANCISCO
SUTTER 3440

HOGAN LUMBER CO.

Wholesale and Retail

LUMBER

MILL WORK • SASH & DOORS

Office, Mill, Yard and Docks

SECOND AND ALICE STREETS • OAKLAND, CALIF.

Telephone **Glencourt 6861**

SANTA MARIA INN SANTA MARIA, CALIFORNIA

FRANK J. MCCOY, General Manager

FERNAND E. PIMENTEL, Manager

On the
Coast
Highway
between
San
Francisco
and
Los
Angeles



American
or
European
Plan
•
Old
English
Tap
Room



Parts for **UTILITY APPLIANCES** are die-formed on presses varying up to 375 tons pressure.

The newly acquired plants will be operated as divisions of Utility Appliance Corp., with existing production sales organizations, although executive operation will be consolidated in the Utility organization, and engineering facilities will be strengthened by consolidation of the three organizations.

Ben B. Breslow continues as president of Utility and Maurice Breslow as vice-president. George A. Sattler joins the board of directors.

SAFETY AWARDS

The Permanente Cement Company, Oakland, and the Union Oil Company of California have been awarded the Joseph A. Holmes Certificate of Honor for their outstanding safety record established during the years 1941 to 1946.

Permanente was cited for the record it established during the period August 15, 1942, to January 23, 1946, when it produced 5,510,565 tons of rock without a lost-time accident.

BOOK REVIEWS

PLASTIC PRIMER

The Dow Chemical Co., Midland, Michigan.

Sixteen page illustrated booklet on properties, fabrication and uses of Dow Plastics. Many developments perfected during the War which are new and will soon become available for general public use are shown in the booklet.

PRACTICAL GUIDE TO FLUORESCENT LAMPS.

Westinghouse Lamp Division, Bloomfield, New Jersey

The basic principles and operating characteristics of fluorescent lamps and auxiliaries are explained in this new 24-page booklet A-4759 issued by Westinghouse.

Essential structure and operation of the mercury vapor electric discharge tube with its phosphor coating is shown diagrammatically as is ballasts, starters and lampholders. Factors affecting lamp life and maintenance, voltage, radio interference, noise and vibration are also explained.

INCO SPRING EDITION. International Nickel Company, Inc., New York City, N. Y.

Contains variety of technical articles on new uses of Nickel and alloy. Well illustrated with charts and diagrams.

NEW WATER-REPELLENT GYPSUM SHEATING.

Gypsum Association, 211 W. Wacker Drive, Chicago 6, Illinois.

Booklet contains information on water-repellent gypsum sheating; its fire resistance, structural strength, durability, economy, and wind tightness. Also shown the application of brick veneer, wood siding, asbestos cement siding or shingles and stucco over gypsum sheathing. Illustrated.

OVER-ALL LIGHTING BY WAKEFIELD. The F. W.

Wakefield Brass Company, Vermilion, Ohio.

Catalog No. 46 presents engineering details of lighting equipment designed for offices, drafting rooms, stores, and school. Contains construction details with full dimensional data, light distribution curves, and tables for estimating lighting results. Illustrated.

WILLARD H. FRANCIS, Architect, has moved to 11450 Bolas, Los Angeles, California.

EDWIN D. MARTIN, Architect, has moved to P. O. Box 1101, Beverly Hills, California.

VERMONT MARBLE COMPANY

Producers and Finishers
of
Domestic and Imported Marbles

Write for new pamphlet describing our
Marble Toilets and Showers

San Francisco and Los Angeles

San Francisco phone: SUTter 6747



The Most Complete Line of
STEELS and BUILDING MATERIALS
Made by a Single Producer



See Sweet's Catalog File or write us for
full information.

REPUBLIC STEEL CORPORATION
GENERAL OFFICES: CLEVELAND, OHIO

DENVER, COLORADO CONTINENTAL OIL BUILDING
LOS ANGELES, CALIFORNIA EDISON BUILDING
SALT LAKE CITY, UTAH WALKER BANK BUILDING
SAN FRANCISCO, CALIFORNIA RIALTO BUILDING
SEATTLE, WASH. WHITE-HENRY-STUART BUILDING

PACIFIC MANUFACTURING CO.

HIGH CLASS INTERIOR FINISH
QUALITY MILLWORK

142 SANSOME ST., SAN FRANCISCO
GARfield 7755

6820 MCKINLEY AVE., LOS ANGELES
THornwall 4196

BUILDERS EXCHANGE, OAKLAND

"AMERICAN - MARSH" CONDENSATION UNIT

Pumping
Machinery
for
Every
Purpose

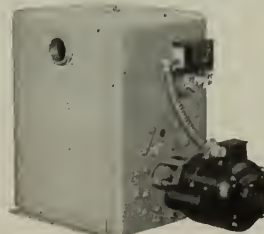

For Service
Call
DOuglas
6794
or
MUtual 8322

SIMONDS MACHINERY CO.
SAN FRANCISCO 816 FOLSOM
LOS ANGELES 455 EAST 4TH

Real Estate Loans



F H A loans are readily available on existing homes up to 80% of the appraised value. You can buy a home and pay for it in small monthly installments like rent. For example, a 20-year loan of \$6000 would cost about \$49.56 per month, including taxes, insurance, principal and interest.

*Come in and talk with us
We can help you get the home
you want*

CROCKER FIRST NATIONAL BANK
OF SAN FRANCISCO
California's Oldest National Bank
ONE MONTGOMERY STREET
Member Federal Deposit Insurance Corporation

Venetian Blinds
of
Metal or Wood
for
Homes and Offices

Installed and Serviced

by

GUNN CARLE & CO.

20 POTRERO AVENUE

SAN FRANCISCO 3

Underhill 5480

IN THE NEWS

BIG BUSINESS

Building permits for May, 1945, in Los Angeles totaled \$4,536,943. For May, 1946, the figure was \$21,705,304, or an increase of approximately 480 per cent.

ACTIVATED CARBON AIR RECOVERY PANELS

Designed for air conditioning systems where space is at a premium ACTIVATED AIR RECOVERY PANELS are receiving wide use in new construction, particularly in railway cars where recirculated air and fresh ventilation air is so essential.



DOREX Type G Panels consist of sturdy lightweight metal frames housing a battery of perforated tubes containing specially treated activated carbon. Complete information is available from W. B. Connor Engineering Corp., 114 East 32nd St., New York 16.

DIAL-ESE FAUCETS

A new line of non-drip faucets have been announced by the CRANE Company, Chicago.

Easy to operate, easy to repair, the faucets are known as "Dial-ese" and are featured with plastic handles and base coverings. Handles are produced in pearl-grey color, thus harmonizing with modern kitchen and bathroom fixtures.

IN OWN BUILDING

The Thoreson Construction Company have moved into their own building at 11336 Saticoy Street, North Hollywood, California.

LAMP DIFFUSER

The Fluor-O-Shield, manufactured by the CAMFIELD COMPANY of Grand Haven, Michigan, is a new decorative and inexpensive accessory for evenly diffusing fluorescent light and eliminating glare.

Stamped from one piece of aluminum it is finished in white baked enamel and fits all open type fixtures.

KYLE FORREST

Civil Engineer

Water Supply — Sanitation

Municipal — Private
Consultations — Investigations
Reports — Designs — Valuations
Supervision — Litigation

Ground Water Work a Specialty

Hydrologic studies — wells, dewatering, underdrainage, foundations, conservation, testimony.

1504 Russ Building
San Francisco 4
YUkan 0652

ELMER F. STEIGELMAN

CIVIL ENGINEER

Structures of Steel, Wood
and Reinforced Concrete

Special Attention to
Architects' Requirements

690 Market Street
San Francisco, California
GARfield 0588

Scott Company

HEATING . . PLUMBING . . TILE



243 MINNA STREET
SAN FRANCISCO
Phone EXbrook 6741

JOHN CASSARETTO COMPANY

—Since 1886—And Still Active—

Building Materials

READY MIX CONCRETE
ROCK - SAND - GRAVEL - LIME
CEMENT - PLASTER - MORTAR
METAL LATH - WOOD LATH
STUCCO - WIRE NETTING

Service Unexcelled

Bunkers

Sixth and Channel, San Francisco
Phones: GARfield 3758 - 3760

MULLEN MFG. COMPANY

BANK, STORE AND OFFICE
FIXTURES—CABINET WORK
OF GUARANTEED QUALITY
CHURCH SEATING

Office and Factory:

60-80 RAUSCH ST., Bet. 7th and 8th Sts.
San Francisco
Telephone UNDERhill 5815

THE TORMEY COMPANY

GENERAL PAINTERS
AND DECORATORS

Phone UNDERhill 1913

563 FULTON STREET
San Francisco

G. P. W. JENSEN & SON

Building Construction

320 Market Street, San Francisco

Phone: GARfield 2444

IN THE NEWS

NEW LIGHT FOR SCHOOLS

A new-type fluorescent indirect lighting unit is designed to provide a sky effect of evenly distributed, glareless light for schools, offices and drafting rooms. A feature is a translucent reflector molded to give virtually the same brightness as the ceiling.

FOR WATER TREATMENT

A simple device for adding MICROMET in just the right amounts to the water system when installed on the cold water intake line, and on the incoming line of a hot water tank, is being distributed by the NO-NO SPECIALTY COMPANY of Cleveland, Ohio.

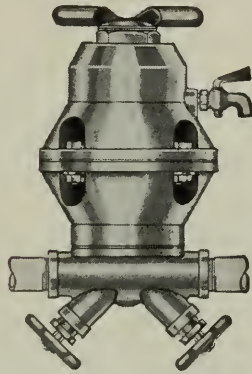

Distribution of the MICROMET FEEDER and MICROMET will be through plumbing supply jobbers and dealers, according to the Hot-stream Heater Company, who manufacture the products for the NO-NO Specialty Company.

DATA WANTED

Malcolm G. Smith, Architect, 686 22nd Avenue, San Francisco 21, desires building material and appliance firms to send him publications and catalogs of architectural materials and methods of construction.

LONG BEACH

Dedrick & Bobbe, Architects, have moved to 21 Atlantic Avenue, Long Beach 2, California.

C. J. RYLAND, Architect, has moved to new offices at Monterey, California, Box 847.

J. T. ZELLER, Architect, has moved to 115 N. Normandie, Los Angeles 4, California.

ANDERSON & RINGROSE

General Contractors

320 Market Street, San Francisco

Phone GARfield 2245

DINWIDDIE CONSTRUCTION COMPANY

BUILDERS

CROCKER BUILDING
SAN FRANCISCO



HERRICK IRON WORKS

STRUCTURAL STEEL
REINFORCING STEEL

18TH AND CAMPBELL STS.
OAKLAND, CALIF.
Phone GLencourt 1767

Phone GARfield 1164

Thomas B. Hunter

Consulting Engineer

DESIGNER OF HEATING
AIR CONDITIONING
VENTILATING AND WIRING
SYSTEMS, MECHANICAL
AND ELECTRICAL EQUIP-
MENT OF BUILDINGS

41 SUTTER STREET

ROOM 710

San Francisco

California

George F. Brayer

ELECTRICAL
CONTRACTOR

166 Seventh Street
San Francisco

Phone: MArket 1761

PITTSBURGH TESTING LABORATORY

Successors to
SMITH, EMERY & COMPANY

*Testing and Inspecting
Engineers and Chemists*

Structural Materials, Structures
Equipment, Pipe, Soils.

651 Howard St., San Francisco 5
EXbrook 1747

A. F. MATTOCK CO.

Builders

★

212 CLARA STREET
SAN FRANCISCO

INDEPENDENT IRON WORKS

Steel Buildings
Service Stations
Steel Storage Tanks
Fabricated Plate Work
Steel & Sheet Metal Products
Fabricated Structural Steel
Steel Distributors

Eighth & Pine Sts. Oakland, 7

Index to Advertisers

ALADDIN Heating Corp.....	48
ANDERSON & Ringrose.....	47
ANGIER Sales Corporation.....	*
ARCHITECTS Reports	40
BASALT Rock Company.....	39
BAXTER & Company, J. H.....	34
BRAYER, Geo. F.....	48
CASSERETTO, John	47
CLARK, N., & Son.....	*
CLASSIFIED Advertising	43
CLINTON Construction Company.....	44
COLUMBIA Steel Co.....	*
COLOTYLE Corporation	*
CROCKER First National Bank.....	46
DINWIDDIE Construction Company..	47
FORDERER Cornice Works.....	39
FORREST, Kyle	46
FULLER, W. P., Co.....	2
GUNN, Carle & Company.....	46
HANKS, Inc., Abbot A.....	48
HAWS Drinking Faucet Company.....	Back Cover
HERRICK Iron Works.....	47
HOGAN Lumber Company.....	44
HUNT, Robert W., Company.....	48
HUNTER, Thos. B.....	47
IMPERIAL Brass Manufacturing Co.....	*
INDEPENDENT Iron Works.....	48
JENSEN & Son, G. P. W.....	47
JOHNSON Company, S. T.....	*
JUDSON, Pacific-Murphy Corp.....	39
KRAFTILE Company	5
KAWNEER Company	*
MATTOCK, A. F.....	48
MULLEN Mfg. Co.....	47
MUELLER Brass Co.....	*
NORTHERN California Electrical Bureau	35
OWENS Corning Fiberglas Co.....	*
PACIFIC Coast Gas Association.....	*
PACIFIC Manufacturing Company.....	45
PACIFIC Portland Cement Company	1
PACIFIC Telephone & Telegraph Co.	33
PARAMOUNT Built-in Fixture Co.....	*
PARKER, Steffins & Pearce.....	*
PAYNE Furnace & Supply Co., Inc.....	*
PITTSBURGH Testing Laboratory.....	48
PORTLAND Cement Association.....	*
REMILLARD-Dandini Co.	48
REPUBLIC Steel Corporation.....	45
SANTA Maria Inn.....	44
SCOTT Co.	46
SIMONDS Machinery Company.....	45
SISALKRAFT Company	39
SMOOT-Holman Co.	37
STANLEY Works, Inc., The.....	32
STEIGELMAN, Elmer F.....	46
SOULE Steel Co.....	*
TAYLOR Co., Halsey W.....	*
TIMBER Engineering Co., Inc.....	*
TORMEY Company, The.....	47
UTILITY Appliance Corp.	*
U. S. STEEL	*
U. S. BONDS.....	Inside Back Cover
VERMONT Marble Company.....	45
WESIX Electric Heater Co.....	*
WESTERN Asbestos Company.....	Inside Front Cover
WOOD, E. K., Lumber Company.....	36

* Indicates Alternate Months

A L A D D I N Heating Corp.

Specializing in
QUALITY HEATING
EQUIPMENT

2222 San Pablo Avenue
OAKLAND
TWinoaks 1022

ABBOT A. HANKS, INC. Engineers & Chemists

INSPECTING — TESTING — CONSULTING
CONCRETE • STEEL • MATERIALS
CHEMICAL AND TESTING
LABORATORIES
• RESEARCH AND INVESTIGATION •

TESTS OF STRUCTURAL MATERIALS
DESIGN OF CONCRETE MIXES
SHOP AND ERECTION INSPECTION OF
STRUCTURES AND EQUIPMENT
INVESTIGATION OF STRUCTURES
AND MATERIALS
TESTS AND INVESTIGATION OF
FOUNDATION SOILS
FIRE RESISTANCE AND INSULATION
TESTS

624 Sacramento Street, San Francisco

Robert W. Hunt Company ENGINEERS

Inspection • Tests • Consultation

Schools and Other Structures
Are Built as Designed

*When Construction Materials are
Inspected at point of Manufacture
and during Erection by*

ROBERT W. HUNT COMPANY

*Cement, Concrete, Chemical, Metallurgical,
X-Ray and Physical Laboratories*

Chicago • New York • Pittsburgh
Los Angeles • All Large Cities
San Francisco, 251 Kearny Street

REMILLARD-DANDINI Co.

Brick and
Masonry Products

★

633 BRYANT ST., SAN FRANCISCO
569 THIRD ST., OAKLAND

ARCHITECT AND ENGINEER



AUGUST

1946



... It Happened in San Francisco!

THE PROBLEM: Because executives in low-partitioned private offices of the Ray Oil Burner Company, San Francisco, had to shout to be heard above the noise of office machines in the adjoining main office, they were under a constant nervous strain.

THE SOLUTION: The company—one of the world's largest manufacturers of industrial, marine and domestic oil burners—consulted Western Asbestos Co., the Acousti-Celotex distributor and a member of the world's most experienced acoustical organization. They suggested that the block-long ceiling be covered with Acousti-Celotex, the famous perforated fibre tile that is the most widely used sound conditioning material.

THE RESULT: Management noted such an improvement that President Milton S. Ray says: "The

attractive Acousti-Celotex ceiling has hushed the noise of machines, typewriters, phone bells and voices to where it is scarcely noticeable. Our executives can now converse in their offices in ordinary tones. Office workers have become more contented, more accurate, more productive than ever before. Telephone conversations are more clearly understood."

Find out how Acousti-Celotex can solve *your* noise problem. A call or note will bring a trained expert to your desk.

WESTERN ASBESTOS CO.

Acoustical Engineers and Contractors

675 TOWNSEND STREET, SAN FRANCISCO 3, CALIFORNIA
OAKLAND • RICHMOND • SACRAMENTO



Sound Conditioning with
ACOUSTI-CELOTEX

REG. U.S. PAT. OFF.

ARCHITECT

Vol. 166

No. 2

AND

ENGINEER

ARCHITECTS' REPORTS—Published Daily

Telephone DOuglas 8311

E. H. WILDER
Editor

MARK DANIELS, A.I.A.
Associate Editor

JOHN S. BOLLES, A.I.A.
Book Reviews

MICHAEL GOODMAN
Post-War Planning

L. H. NISHKIAN
Consulting Editor

E. N. KIERULFF*
Ass't Editor
*In the Service



Contents for

AUGUST

COVER PICTURE: Integrating house, garden and environs (See Page 34)

ARTICLES AND MISCELLANEOUS TEXT

EDITORIAL NOTES	4
NEWS AND COMMENT ON ART	6
DOUGLAS FIR PLYWOOD INDUSTRY, Annual Meeting	9
ASSOCIATED GENERAL CONTRACTORS MEET ON PRICE-WAGE ISSUES	11
RECORD TELEPHONE CONSTRUCTION ON WEST COAST	12
By C. E. ROGERS, General Operations Engineer, Pacific Telephone & Telegraph Company, San Francisco	
CALIFORNIA SUPREME COURT RENDERS DECISION IN "THE KENNEDY CASE"	21
\$14,000,000 HOTEL FOR LOS ANGELES	24
RAINBOW SPANS OF STEEL	26
By DAVID B. STEINMAN	
RADIANT HEATING	29
A.I.A. ACTIVITIES	31
WITH THE ENGINEERS	32
IN THE NEWS	37, 40, 44, 46, 47
HEADLINE NEWS AND VIEWS	36
By E. H. W.	
PRODUCER'S COUNCIL PAGE	38
Edited by CHAS. W. KRAFT	
ESTIMATOR'S GUIDE	41
BUILDING TRADES WAGE SCALE	43
NORTHERN AND CENTRAL CALIFORNIA	
CLASSIFIED ADVERTISING	43
BOOK REVIEWS, Pamphlets and Catalogues	45
INDEX TO ADVERTISERS	48

ARCHITECT AND ENGINEER (Established 1905) is published on the 15th of the month by The Architect and Engineer, Inc., 68 Post St., San Francisco 4; Telephone EXbrook 7182. President, K. P. Kierulff; Vice-President and Manager, L. B. Penhorwood; Treasurer, E. N. Kierulff.

Los Angeles Office: Wentworth F. Green, 6605 Hollywood Blvd., Los Angeles 28, Telephone HEmpstead 3171.

Entered as second class matter, November 2, 1905, at the Post Office in San Francisco, California, under the Act of March 3, 1879. Subscriptions United States and Pan America, \$3.00 a year; \$5.00 two years; foreign countries \$5.00 a year; single copy 50c.



SPECIALIZATION

A recent issue of the Southern California Chapter A. I. A. BULLETIN contained the following comment by Kemper Nomland in relation to the subject of "Specialization":

"The most fitting opening statement I can make to my brief remarks is, I am not a Specialist. In my opinion, Specialists in the field of Architecture endanger forward progress and slow down new ideas. Most of the Architects here will be happy to know that even our own conservative A. I. A. in Convention assembled is of the same opinion by a considerable majority, and you will have a detailed report about this at our June meeting. To me, this stand against advertised specialization is a most significant and encouraging sign. What our profession always needs is new blood with new and fresh ideas. These to be given every encouragement and help . . ."

* * *

WHO IS RIGHT?

Whenever legislative proposals are introduced in local, state, or national law making bodies which are of such controversial character that they stimulate thinking into action, there is likely to be an over emphasis in support of, or in opposition to, such measures.

There may be perfectly logical reasoning on the part of proponents and opponents, and there may be instances where through prejudice, lack of understanding, or outright selfishness, facts pertaining to the proposed legislation are not properly presented to the public.

Irrespective of the merit of controversial legislation, how is the average citizen going to distinguish between "Good" and "Bad" proposals?

In the case of the Wagner-Ellender-Taft Housing Bill (S. 1592) we had the National Housing Agency, through its director Wilson W. Wyatt, declaring the Bill "is absolutely essential to attainment of the goals of the Veterans Emergency Housing Program," and at the same time the Home Builders Institute was declaring "Now comes the show-down on the Government's proposed, permanent, tax financed, public housing program," while others said, "Don't let 'Social planners' tell you that they will take care of you with a 45-year program. You might have to wait 45 years."

In all instances we were advised to write or wire our "Congressman."

Perhaps that is the reason we are frequently told "there are three sides to every question—my side, your side, and the right side!"

WHY IT SHOULD BE SAID

"Architecture is the fine art which creates beautiful structures for human use; it is the primary planning profession. In it the merging of the traditional and often emotional past with the scientific present gives promise today of a more significant architecture than has ever before been achieved.

"It is an old profession and has accumulated a rich tradition and experience, coincident with the progress of civilization. To this are being added the contributions of current times through the constant evolutions of contemporary architecture.

"Architecture is everyone's profession for no one can escape it, He who understands it best enjoys it most. The profession now stands ready to render a unique service to humanity. Towards this human objective this booklet has been written by educators and practitioners representing various points of view. It is intended for everyone—whether student or teacher, practitioner or client, layman or amateur.

"Complete harmony between education, practice, examination, and registration is gained when all these factors are made clear and understandable to the profession and to the public."—"Architecture, A Profession and a Career." Published by American Institute of Architects.

* * *

NEIGHBORHOOD STATESMEN

With more than 200 Mayor's Emergency Housing Committees organized in metropolitan cities of the Nation, the program advocated by Wilson Wyatt, United States Housing Expediter, to stimulate "local" interest and action in solving many of the country's housing problems is well under way.

Practically every city, whether metropolitan or not, will find a revision of outmoded building codes a means of developing new building, as well as making possible the remodeling and repairing of numerous structures for greater utility uses during the acute shortages in building materials.

A logical study of "local" building codes, emergency housing, and long range community planning, which should incorporate State-wide and national planning trends, requires the serious cooperation of many groups and spheres of influence within the "city."

Here is a problem offering great opportunities to "Neighborhood Statesmen."

DEPENDABLE



**A
"PACIFIC
PRODUCT"**

Produced by

**PACIFIC PORTLAND
CEMENT COMPANY**

San Francisco • Los Angeles
Portland

Sold by

**YOUR BUILDING
MATERIALS DEALER**

UNIFORM - TIME TESTED



BIRTH OF A PEARL, by Jane Berlandina

(S. F. Museum of Art)

BIRTH OF A PEARL by Jane Berlandina is one of fifty paintings on view at the San Francisco Museum of Art, from August 6 to 25, in the exhibition entitled WOMAN WITH PEARLS. One of San Francisco's outstanding painters, Miss Berlandina is the sole representative of the West Coast in this collection of American paintings, which were jury selected from all parts of the country.

In reviewing the exhibition upon occasion of its first showing in New York the Art Digest lists BIRTH OF A PEARL ahead of all others as "one of the most imaginative works in the whole show."

WOMAN WITH PEARLS was sponsored by La Tausca Pearls—Heller-Deltah Company—under guidance of Artists for Victory. Nine awards, totaling \$4,500 in victory bonds were distributed. The exhibition is on a nationwide tour, and will have only three showings on the West Coast.

Jane Berlandina (Mrs. Henry Howard) has been in San Francisco since 1931. Born in Nice, France, she studied in Paris under Matisse and Dufy and had obtained considerable prominence before coming to this country in 1928. Her painting has frequently been exhibited in New York, at the Museum of Modern Art and the Whitney Museum

among other places; also at the Chicago Art Institute. Locally at the San Francisco Museum of Art, the De Young Museum and the Rotunda Gallery at the City of Paris.

Miss Berlandina has painted murals as well as oils and watercolors. Her works are included in the permanent collections of the Metropolitan Museum, the Palace of the Legion of Honor. The San Francisco Museum of Art owns two oils and four watercolors by her.

The work in the exhibition exemplifies Miss Berlandina's personal style of distinguished color and interesting semi-abstract forms, subtly related in space. By the introduction of the half emerging face it recalls earlier characteristic painting in which abstraction was less dominant, though it can be truthfully said that her style is an evolution continued consistently over a long period of time toward a more abstract approach to the problems of art in which she is interested.

MURAL UNVEILED

What is believed to be the largest continuous painting dealing allegorically with one subject matter in the country, was unveiled on July 1,

1946, on the main floor of Chicago's Furniture Mart. The title of the mural is "Romance of Furniture," a creation of the young artist Winfield N. Stampfe of Salt Lake City, Utah.

The mural graphically portrays vital phases of the furniture industry from material source to final delivery. It is 7 feet high and extends 66 feet on three walls, two of which are at right angles and the third is 60 degrees to the middle panel, forming a continuous unobstructed panorama.

"Romance of Furniture" was dedicated to the furniture industry by Mr. Delmar L. Kroehler, president of the Kroehler Manufacturing Company.

SAN FRANCISCO MUSEUM OF ART

The museum of the San Francisco Art Association, located in the War Memorial Building, Civic Center, has scheduled the following exhibitions and activities for the month of August.

EXHIBITIONS:

Painting by Jaqueline Lamba and sculpture by David Hare, through August 25; WOMEN WITH PEARLS, 50 paintings for a competition sponsored by Industry, through August 25; PAINTINGS by EMIL BISTRAM, through September 8; OILS AND WATERCOLORS by MARK ROTHKO, through September 8; PAINTINGS INSPIRED BY THE SOUTHWEST by AGNES SIMMS, through September 8 MODERN TEXTILE DESIGN from the Museum of Modern Art, through September 12.

MUSEUM ACTIVITIES: Special Lectures sponsored by the Women's Board: Experiments in Europe, with Monuments, Fine Arts and Archives by Thomas Carr Howe, Jr., Director of the Palace of the Legion of Honor, Thursday, 8:30 p. m., August 15; Budapest String Quartet: Sponsored by Mills College and the San Francisco Museum of Art. Final two Tuesday evening concerts, 8:30 p. m. Studio Workshop and Sketch Club: Studio meetings for amateurs and professionals with competent guidance at hand. Conducted by George Harris. Wednesdays and Fridays, 7:00 to 9:30 p. m.; Gallery Tours every Sunday at 3:30 p. m. by members of the Museum Staff.

FILMS: Know Your World—Free Movie Program, Saturdays and Sundays at 2:30 p. m.; Latin American Program—August 3 and 4; English Program—August 10 and 11; South Pacific Program—August 17 and 18; Holland Program—August 24 and 25; Chilean Program—August 31, Sept. 1.

CITY OF PARIS ART GALLERY

Beatrice Judd Ryan, curator of the City of Paris Rotunda Gallery and director of the Art in Action

Shop, announces the following exhibits and displays will be shown the latter part of August and first part of September:

ROTUNDA GALLERY, 4th Floor: August 9th to September 7th, Exhibition of paintings in tempera, oil, and watercolor, drawings, and etchings by REGINALD MARSH, of New York and Mills College.

ART IN ACTION SHOP, 5th Floor: August 5th to September 7th, Exhibition of Screen Prints (Serigraphs) by Eastern and Western artists.

Hand crafts by artists from the Pacific Coast suitably selected by experts for gift buying. Demonstrations of Hand Weaving (11:00 to 4:00 daily). Pottery thrown on the wheel (11:00 to 4:00, Tuesdays and Thursdays).

CALIFORNIA PALACE OF THE LEGION OF HONOR

Uda Waldrop, official organist of the California Palace of the Legion of Honor, will play the following organ programs during the latter part of August:

Saturday, August 17, 1946, 3 p. m.—The Shepherd's Carol, Frederick Chubb; Legende, Louis Vierne; Fantaisie, Theodore Dubois; Chorale, Joseph Boulnois; Berceuse, James H. Rogers; A Song of Sunshine, Roland Diggle; Phantom Waltz, "But Lately in the Dance," Arensky; March, Rebikoff; Carillon, Leo Sowerby; La Serenata, Gaetano Braga: **Sunday, August 18, 1946, 3 p. m.**—Song Without Words, Paul Fauchet; Preludio and Adagio, from Second Sonata, Guilman; Music of the Spheres, Rubinstein; Onward, Ye Peoples! Sibelius; Andantino (request), Cesar Franck; In Fancy Free, Fonteyn Manney; None but the Lonely Heart (request), Tschaikovsky; and Finale, Lemmens.

Saturday, August 24, 1946, 3 p. m.—Allegro from Sonata "Pascale," and Adoration, from Sonata "Pascale," Lemmens; The Grove of Palms, By the Ganges, and Incantation, from "In India" (Suite for the Organ), Spaulding Stoughton; Grand Choeur Dialogue, Gigout; Chanson Triste, Tschaikovsky; Romance, Rubinstein; The Lost Chord (request), Sullivan; Hymn to the Sun (request), Rimsky-Korsakoff: **Sunday, August 25, 1946, 3 p. m.**—Prelude, Coleridge-Taylor; Paraphrase from "Judas Machabee," Handel-Guilman; Elizabeth's Prayer, from Tannhauser, Wagner-Bossi; Prelude Chromatique, James Meale; Assyrian Shepherd, R. Deane Shure; Oriental Sketch, Arthur Bird; Arabesque No. 1, Debussy; In Folkstone (request), Grieg; Song Without Words—Op. 40, No. 6, Tschaikovsky.

Saturday, August 31, 1946, 3 p. m.—Prelude, Luard-Selby; Cantilene Pastorale, Guilman; An-

cante—from French Suite No. 5, Bach; Fuge in G Minor, Bach; Reverie (Traumerei), Richard Strauss—James H. Rogers; Scherzando (Humoresque), Widor—W. J. Westbrook; Lullaby, Gordon Phillips, Marche Triomphale, Op. 65, Karg-Elert; to the Setting Sun, Garth Edmundson; My Heart at Thy Sweet Voice—from the opera "Samson et Delila" (request), Saint Saens.

EXHIBITIONS

Exhibitions and special events announced by Thomas Carr Howe, Jr., for August include:

PAINTINGS by David Park, opening August 14; DRAWINGS by Edgar Eaylor, opening August 14; 100 PLATES OF HISTORICAL HORSE TRAPPINGS, by Marcile Stalter, opening August 14.

The Alma de Bretteville Spreckels Collection of Sculpture by Auguste Rodin.

The Mildred Anna Williams Collection of Paintings, Sculpture, Tapestries and Furniture.

The Collis Potter Huntington Memorial Collection of 18th Century French Paintings, Sculpture, Tapestries, Furniture and Porcelain.

The Gordon Blanding Collection which has as its nucleus eleven paintings by William Keith will be shown through the month of August.

SPECIAL PROGRAMS

Organ Recital by Uda Waldrop, every Saturday and Sunday, 3 p. m.; Organ Concert Broadcast at 3:30 p. m., Saturday, Station KSFO.

CHILDREN'S CLASSES

French Folk Festival for children, ages 7-14, every Wednesday in August, 2-4:30 p. m. French peasant life; dances, songs, legends and costumes. Madelynn Greene, director of folk dancing. Other instruction under direction of Miss Katherine Parker and Lily Weil Jaffe.

FREE MOTION PICTURES: Each Saturday at 2:30 p. m.

Films with music: August 17—Music of the Masters Series with Jose Iturbi, Coolidge Quartet, Mildred Dilling, Vronsky and Babin, Igor Gorin, Emanuel Feuermann; August 24—"Vernon and Irene Castle"—Fred Astaire, Ginger Rogers and Edna Mae Oliver; August 31—"It Started with Eve"—Deanna Durbin.

NEW LUCIEN LABAUDT MEMORIAL ART GALLERY AT SAN FRANCISCO

A new art gallery dedicated to the memory of the late LUCIEN LABAUDT, well-known San Francisco artist, was opened to the public on August 16, 1946.

Located at 1407 Gough Street, the gallery is

under the joint direction of Marcelle Labaudt, widow of the artist, and Johanne Bietry Salinger, associated with art movements in San Francisco for more than two decades.

Labaudt was killed in the crash of an Army bomber on December 12, 1943, while on his way from Burma to China on an assignment as a war staff artist for Life Magazine.

In opening the art gallery Mrs. Labaudt declared: "When the tragic news of Lucien's death reached me, I felt immediately that I would want to do something to perpetuate his name and all he stood for, and I thought then of a gallery."

All artists exhibiting at the opening show are former students of Labaudt.

The gallery is to be used as a complete cultural center and is available for intimate chamber music concerts, poetry readings, lectures and other such events.

NEW YORK MODERN ART GALLERY MODELS

J. J. Polivka, consulting engineer, Berkeley and San Francisco, is now engaged in interesting structural work and research on models for the Modern Art Gallery in New York, designed by Frank Lloyd Wright. The unusual structure in reinforced concrete (the boldest building of Wright's career) includes the eight-story ramp which is coiled in the shape of a longitudinal spiral. "This building," said Frank Lloyd Wright, "is built like a spring. When the first atomic bomb lands on New York, it will not be destroyed. It may be blown a few miles up into the air, but when it comes down it will bounce." Other structural problems assigned to Mr. Polivka by F. L. Wright are in conjunction with a 15-story glass tower building of S. C. Johnson & Son's new laboratory, Racine, Wisc. Mr. Polivka returned recently from Taliesin-West near Phoenix, Arizona, the artistic studio of Frank Lloyd Wright.

"A DECENT HOME"

The Housing Authority of the City of Los Angeles recently held an exhibit in the Los Angeles County Museum, Exposition Park, depicting the history and nature of the problem of sub-standard housing in Los Angeles.

A motion picture entitled, "More Than Shelter" and a lecture by Simon Eisner, planning architect of the Los Angeles City Planning Commission, emphasized the Los Angeles housing situation.

Douglas Fir Plywood Industry

ANNUAL MEETING SETS TEMPO FOR FUTURE ACTIVITIES OF ASSOCIATION

Although greater plywood production to speed the national housing program stands as the immediate objective of Northwest panel manufacturers, Douglas fir plywood producers have committed themselves to an expanded program of industry research and product promotion on a long-term basis, according to reports of the recent annual meeting of the Douglas Fir Plywood Association in Tacoma, Washington.

Prior to devoting their attention to the long-term research program intended to perpetuate and advance their industry, the panel makers heard Thomas B. Malarkey, president of the trade association, urge that the 33-factory industry increase operations to a three-shift, six-day-week basis to boost production for the veterans' housing program. His recommendation was spurred by government assurance that more timber will be made available to plywood manufacturers in the immediate future.

This assurance had come in the form of a report by Mathias W. Niewenhaus, director of forest products division of Civilian Production Administration, that a half dozen actions have been instituted to increase the log supply—long the bottleneck to increased plywood output. Niewenhaus was one of several CPA and NHA officials present at the plywood meeting.

\$250,000 Appropriated

Forceful evidence of the manufacturers' determination to continue apace the progress which has

characterized their industry for the past decade was presented in the disclosure that already \$250,000 has been appropriated to Plywood Research Foundation, founded a year and a half ago. While this organization is a separate corporation from the promotional association, it is maintained by



THOMAS B. MALARKEY
President, Douglas Fir Plywood Association

and for the same fir plywood manufacturers.

The foundation, which has Tacoma laboratories, was established to "develop new products which plywood firms can produce, devise means of utilizing wood waste, and improve the production and

properties of fir plywood." The report on the laboratory and the progress of research being undertaken there was given to the plywood makers by Dr. John Meiler, managing director of the research foundation.

The manufacturers reviewed for the first time the laboratory facilities as Dr. Meiler conducted the officials through the research headquarters. Not only did they witness the laboratory equipment in operation, but also viewed several samples of entirely new products.

Research Activities Listed

"To attain its objectives, the Plywood Research Foundation organization has perfected three methods of attack," Meiler explained. "First, the establishment of a laboratory to pursue pure research and product development; second, introduction of a plan that will capitalize on the inventive power of every worker within the industry in development of new products and processes, and third, use of license authorizations from individuals and firms already holding patents of value to plywood manufacturing."

The second phase of the research foundation program known as "PRF," there is established a method whereby every inventor in the industry can submit his ideas to the foundation for perfection and development with the foundation working in his behalf. Developmental expenses, patent fees and other expenses will be advanced against future royalties. The employee becomes the patent holder.

Log Shortage Felt

Because of the log shortage, Douglas fir plywood production now is at the rate of only about 1,200,000,000 square feet a year—about the same as last year but far below that of the 1942 peak. Half of the output is channeled by CPA into low-cost houses for veterans; the remainder can be sold without priority.

Malarkey re-stated the plywood manufacturers' contention that government alone holds the key to greater panel production because "government owns 65 per cent of the merchantable timber in Oregon and Washington"—the states producing two-thirds of the nation's construction plywood.

Industry Opposed

"Plywood makers long have fought the incentive payment proposal and remain unalterably opposed to the principle of subsidies," industry spokesman declared.

Niewenhaus announced, "Both the U. S. Forest Service and Department of Interior have promised, and have already commenced, accelerated timber cutting programs."

He pointed out also that the \$15 million which

was set aside from the veterans' emergency housing subsidy for access road building on federally owned forest lands will result in substantially more timber, although estimates not yet have been completed. The Washington state "tie-bid" deadlock, which has blocked sale of state-owned timber, is about to be broken, Niewenhaus reported. This, of itself, will unlock a billion feet of timber this year, he predicted.

Other speakers at the plywood industry meeting included E. W. Daniels, president of Harbor Plywood Corp. of Hoquiam and chairman of the industry management committee, and W. E. Difford, managing director of the plywood industry trade promotion association with Tacoma headquarters.

All association officers were re-elected for one-year terms. Thomas B. Malarkey, president; Arnold Koutonen, president of Olympia Veneer Company of Olympia, is vice president of the association; Herman E. Tenzler, president of Northwest Door Co. of Tacoma, is secretary; and J. P. Simpson, general manager of Buffelen Lumber & Mfg. Co.,



DR. JOHN MEILER
Managing Director, Douglas Fir
Plywood Association Foundation

also of Tacoma, is association treasurer.

Trustees of the all-industry board include: E. W. Daniels, J. R. Robinson, president of Robinson Mfg. Co. of Everett; Craig L. Spencer, president of Elliott Bay Mill Co. of Seattle, and Frost Snyder, president of Vancouver (Wash.) Plywood & Veneer Co., the only new board member.

LUMBER COMPANY SOLD

The Blessing and Giddens Mill and Lumber Company, one of the largest and oldest mills in Dallas, Texas, has been sold to the American Home Realty Company.

Facilities of the mill are to be devoted to speeding construction of the American Home Realty Company's \$25 million residential development in South Oak Cliff known as "Wynnewood."

Associated General Contractors Meet on Price-Wage Issues

The Governing and Advisory Boards of the Associated General Contractors of America, meeting in Denver, Colorado, on July 1 and 2, met the issue of removal of price and wage controls promptly and squarely by adoption of the following resolutions:

1. Pledged full efforts of the membership to prevention of unjustifiable increases in construction costs.

2. Welcomed removal of wage and price controls because it restores free competition and initiative to the industry, the most powerful force to stabilize and eventually reduce construction costs.

3. Gave assurance to the public that elimination of the controls will enable the industry to operate more efficiently and economically, after a period of adjustment.

4. Forecast an increase in production of construction materials, and in increase in construction activity.

5. Urged elimination of other governmental regulations which hamper operations of the industry and interfere with ability of the industry to fulfill the nation's construction needs.

6. Recommended to the members, chapters and branches that they do not enter into ill considered agreements or purchases, and that they demonstrate that a free, competitive industry is self-regulating and will curtail inflationary prices better than unenforceable attempts at a controlled economy.

In an interview President Warren S. Bellows, Houston, Texas, said that release of price and wage controls meant that the public would be able to buy construction services at stable lower prices sooner than if the OPA were continued.

In opening the meeting of the boards, Mr. Bellows announced that membership of the association exceeded 3,800, and was growing steadily.

He stressed the value of members of the association working in unity for solution of problems of the industry. He said:

"There are principles which influence all segments of our industry, whether we are building, highway or heavy contractors. The work of the association will prove far more effective if we attack our problems from the industry-wide and nationwide point of view, rather than if we attack them on the basis of selfish interests of small groups.

"Ours is an industry which serves the public. There is scarcely any form of progress or activity in this nation which does not require some form of construction. As contractors it is our duty to see to it that this construction is executed as efficiently, as economically and as promptly as possible. We must also work for adoption of policies by the government and the public which will enable us to operate most effectively."

Managing Director H. E. Foreman, Washington, D. C., in his reports to the board said:

"The point has been reached at which the construction industry is able to serve the public, not to the extent of its abilities, but to the extent permitted by government regulations.

"The present tendency is for governmental controls to increase rather than diminish.

"The greater the controls by the government over operations of the industry, the less efficient is the manner in which the industry can execute the projects which are vital to improvement and progress in all forms of American life.

"The time cannot be predicted at which the American people will make the decision that the federal government should no longer impede the national progress which depends upon construction.

"The extent to which this nation remains a de-

(Continued on Page 22)



NEW SOUTH THORNWALL CENTRAL OFFICE BUILDING—Los Angeles

The building is identical in design with exchange buildings being constructed in South Van Nuys and North Van Nuys. P. J. Walker & Company has the contract for the Van Nuys buildings, and R. J. Daum is building the South Terminal office. Donald B. Parkinson, Architect.

Record Telephone Construction on West Coast

By **C. E. ROGERS, General Operations Engineer,**
Administration Department, Pacific Telephone & Telegraph Company,
San Francisco, California

A construction program, far and away the largest and most varied ever undertaken in its 69 years of service to the West Coast, is now being pushed ahead by The Pacific Telephone and Telegraph Company throughout its Coast-wide territory.

As announced December last, the Company expects to spend \$400,000,000 for new construction in the immediate five-year period. The execution and speed of the entire program are dependent upon the flow of available manpower, materials, money and the level of business con-

ditions. The 1946 program, now well under way, will require, it is estimated, an all-time high expenditure of upwards of \$90,000,000 for new construction, compared with \$35,800,000 in 1945. Inclusive of materials reused, the gross plant additions for 1946 are estimated at well over \$100,000,000, more than double the corresponding 1945 gross figure.

Some of the highlights of this year's program are: more than 140 building projects; the addition of switching equipment for more than 270,000 new



HAYWARD, California

Telephone central office equipment was installed in this building while construction was in progress. Harry A. Thompson, Jr., Architect.

BELOW:

Excavation and work in progress for preparations for pouring concrete for the 10-story Grand Avenue telephone building in Los Angeles. The site of this new construction is next door to the present Mutual telephone building. Donald B. Parkinson, Architect.





SAN FRANCISCO:

The new Montrose central office building where installation of dial switching apparatus was being installed at the time the above photograph was taken. Harry A. Thomas, Jr., Architect.

central office lines; the addition of more than 200,000 circuit miles of toll and long distance network, bringing this network to more than 1,800,000 miles—a five-fold increase since the pre-Pearl Harbor days.

Expressing as it does a fundamental significance to every community throughout the Coast, the big five-year program will result in increasing the plant investment of the company by almost 50 per cent, bringing its total plant investment to an amount aggregating upwards of a billion dollars.

The above serves to underline an already familiar story, namely, that the West Coast is experiencing a period of tremendous growth. And in the telephone business, as elsewhere, building construction dovetails with the provision of new offices, installation of equipment, and maintenance of an expanding service.

A majority of telephone buildings are erected for the purpose of housing central-office equipment. The type and arrangement of central-office switchboards have a direct and important influence on the size, type and dimensions of the building, and the engineering work on buildings and

on central-office equipment are, therefore, closely associated.

In addition to the usual considerations in designing a building, plans are made for future equipment expansion by adding to the sides or rear; by provision of additional floors; or by a combination of such means.

In determining the location of a telephone building, the relationship of the central office in question to other central offices or exchanges in the same locality is considered. The site should be at the "wire center" of the area, within economical and practical distance from the telephones served. The safety and convenience of the operators must also be considered, particularly in the location of a manual office. Many of the operators come to work or leave at hours that differ from the regular business hours of other occupations, and it is essential that the district be such as to be safely traversed at all hours.

The general principles governing the engineering of additions to existing buildings are much the same as those for new installations, but the job is simplified by reason of the fact that the

major factors with respect to lot, building and equipment have already been determined.

Architectural features of telephone buildings are given a lot of thought and planning. Some standard requirements: the building should be good looking at reasonable cost; the design should be conservative so as not to become dated during its long period of service; it should conform in general to neighboring buildings; it should be pleasing in appearance without being too ornamental; the finish and facilities must be first-class.

Even normal requirements for meeting coast-wide telephone growth would have dictated a sizable building program and big equipment installation projects. In these unusual times, a tremendous amount of telephone construction and installation has been backed up for handling at the earliest possible moment, to fill orders for service. The extent of this backlog of applications for serv-

ice is seen in the fact that the 2,886,000 telephones in service as of May 31, 1946, included an unprecedented increase of 254,000 since V-J Day, of which 183,000 were added in the first five months of this year. New applications for service, totaling 340,000 for the first five months of this year, increased 107 per cent over the corresponding period of a year ago.

Of the 286,000 prospective subscribers at the first of the year, whose applications had been necessarily deferred due to shortage of facilities, 183,000, or 64 per cent, have been cared for. Due, however, to the time necessarily involved in the installation of complicated switchboards—in many instances new buildings are required to house them—together with the large number of new applications and the continued materials shortages affecting manufacturers' production, 299,000 applicants were still waiting for service in June of this year.

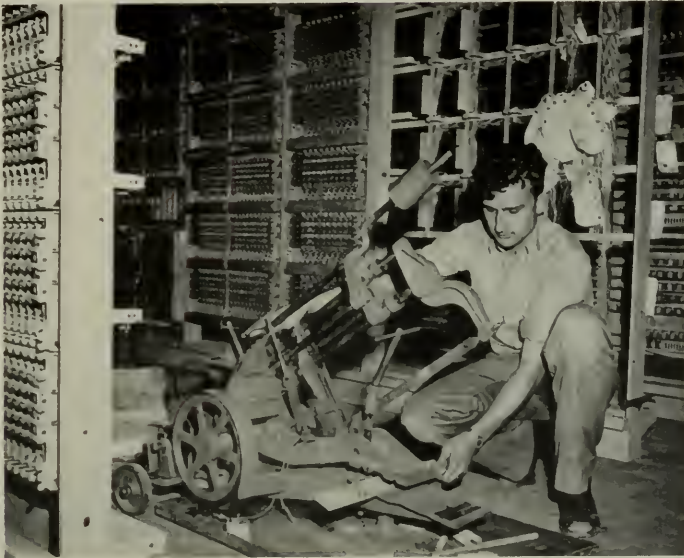

MODERN DIAL EQUIPMENT:

A step in the installation of intricate dial equipment which is going into many of the Pacific Telephone and Telegraph Company buildings now under construction.



REDWOOD CITY, California:

This new telephone building is in keeping with newer architectural trends in the San Francisco Peninsula area which represents predominantly residential and non-metropolitan construction. Installation of modern equipment was going on while the building was under construction. Harry A. Thomsen, Jr., Architect.



CABLE HUT:

Construction view of one of the coaxial cable repeater huts being constructed in southern California. The little structures are designed to withstand extremes of desert heat and cold and thus completely protect the telephone equipment they contain.

In order to further expedite telephone building construction, the necessity for being flexible and making substitutions in materials under present conditions, has been emphasized. For example, the size of steel beams has been adjusted to accord with what is available. Where bricks are scarce and hard to match, say in a building addition, some break in the building has been made where the color changes, or a vine or rain-spout located there. In some cases, it has even been necessary to construct the inner part of walls of cinder or tile blocks and face the exterior with temporary enclosure until bricks were available to permanently face the building. All such resorts to substitutions are an important factor in speeding the completion of the buildings, which is of the utmost importance in caring for the 1946-1947 period, during which material and labor shortage may continue.

The postwar telephone buildings are being planned to contain many innovations in the interests of added efficiency and pleasant working conditions. For example, the appearance and lighting of switchboard rooms will be improved over previous high standards by using more attractive paint colors on the walls, acoustic treatment of the ceiling, more attractive floor covering, Venetian blinds on windows, and covers on radiators. Fluorescent type lighting will be widely used.

Air conditioning has come in for much attention. As regards the telephone equipment spaces, air conditioning with cooling has been limited to locations where the humidity is high. In connection with the problem of dust and dirt control in dial offices, larger and larger ventilating systems have been resorted to in an effort to blow out the heat generated by the equipment while at the same time avoiding an influx of dirt. This has involved improvements in filtering. Dust is an enemy of dial switching equipment and other intricate telephone apparatus, and every possible safeguard is taken to keep it out. The size of the building is not governing in air conditioning; considerations being based on local conditions, including atmospheric dirt content and whether the building has any considerable human occupancy.

Telephone buildings under construction or planned for the coast, range from small coaxial repeater huts, costing about \$2500 each, to large downtown equipment buildings, such as the 10-story structure now going up on Grand avenue in Los Angeles, at a cost about \$2,200,000, and the 13-story building to be erected on Franklin street in Oakland, at a cost of \$2,800,000; to name two of the largest individual building jobs.

Telephone company engineers, in meeting pressing demands, are bucking time and material shortages by reversing usual procedures. Instead of

SEATTLE, Washington

Among extensive telephone equipment facilities being added to the East office in Seattle, is a new addition which is being constructed on the rear (left) of the building. Bebb and Jones, Architects.



drawing the plans and then buying materials, they have sometimes found it necessary to buy what was available and modify plans to conform. Basements are being excavated while architects complete plans. Equipment on hand before buildings are up is being installed as soon as the interior is finished and the outside made weather-tight.

Work on the two-story Montrose building on 19th avenue in San Francisco, has been going ahead on a double-shift basis, including week-ends. Night work was carried on by flood light. In order to make the building ready as soon as possible to receive equipment, the exterior brick walls were temporarily omitted, and the structure was enclosed in a four-inch brick curtain wall, water-proofed on the outside. Face bricks were laid later. Dial apparatus was being installed while construction proceeded.

Second-hand bricks were used for backing-up purposes on the new two-story building in Hayward. Face bricks will be placed later. In the rear of the building, temporary walls were erected

to allow for an addition, as soon as structural steel can be procured. In other words, the new building, which normally would have provided for several years, was outgrown before completion. This remarkable situation springs from seemingly endless acceleration of community growth.

The new 13-story Oakland building will house toll switching equipment, bringing to that city the distinction of being one of the eight regional toll centers in the country, and of taking an important part in a plan for nationwide dialing of long distance calls. In addition to the toll apparatus, the building will contain equipment urgently needed to supplement existing local dial offices. Part of the terminal equipment to be located in this new building will be housed in a temporary one-story concrete structure. The first floor of the toll center will be occupied by the telephone business office, and the second floor by a cafeteria, rest rooms, and locker rooms. Actual work on the site should be under way this summer with completion scheduled for some time next year.



INSTALLATION

of newest telephone equipment is hoisted through a window in the Montrose central office building in San Francisco, as exterior construction progresses, thus minimizing time in which equipment and building is put into public service.

A striking example of a telephone building reflecting all three of the usual considerations—functional utility, both immediate and with an eye to the future; architectural design blending with neighborhood, and exterior attractiveness—is the two-story South Thornwall building on South Vermont avenue in Los Angeles. Located in a residential area, this building measures 111 by 96 feet, is of steel frame construction with reinforced concrete walls, floors and roof slab, and designed for a future third and fourth story. The exterior is of finished concrete; plywood having been used for the forms throughout. The roof slab is covered with a composition roof. Exterior bases on two street frontages are of terra cotta, while the plain finished concrete exterior surfaces of a third street exposure are relieved by continuous windows of steel sash.

The entrance vestibule of the South Thornwall building is lined with ceramic veneer and interior walls are plastered. All equipment room ceilings

are made of exposed concrete, with ceilings of suspended plaster type in toilets and vestibule. All floors are of concrete, with asphalt tile in offices. Stair treads, halls, and vestibule floors are terrazzo. The building is a good example of the company's pressing need for floor space, as construction forces at one time were working ten hours a day, seven days a week to rush it to completion.

Three other buildings now under construction in Southern California follow the basic pattern of the South Thornwall building—two in Van Nuys and one in Burbank—now under construction, with one major exception. These buildings will be of reinforced concrete design instead of steel frame. The original plan of the company was to have them all steel frame construction, which is more adaptable to telephone requirements. However, due to pressure of the demand for more telephone



UNPACKING MODERN TELEPHONE EQUIPMENT

in a new Pacific Telephone and Telegraph Company central office building, preparatory to completion of the building, and placing the installation in service.

facilities in these cities and a question of obtaining steel delivery at the desired time, it was decided to go ahead with reinforced concrete construction. This change is not unusual, for many changes and improvisations are being made before and during construction to accelerate the completion date.

Probably the most unusual projects in the telephone company's current program is the erection of a series of 27 coaxial repeater huts, at seven- to eight-mile intervals, between Los Angeles and the California-Arizona border at Blythe. These 10 by 13-ft. buildings will house repeater equipment for the California section of the transcontinental coaxial cable scheduled to be placed in 1946. A large repeater station will be located at Blythe and the new Grand avenue building in Los Angeles will be the West Coast terminal of the coaxial cable, as well as a general purpose equipment building.

Other large jobs in progress include: a new

wing and basement for the Landscape central office on Solano avenue, Albany; a third story for the Kellogg central office on Fruitvale avenue, Oakland; a new dial central office on Almaden avenue, San Jose; a two-story reinforced concrete building in Bakersfield for business and district offices; an addition to the East central office, at 17th and East Pike, in Seattle; the Fairfax central office in Spokane, and building additions have been completed in Bellingham, Bremerton and Walla Walla. Two buildings are planned for Portland's east side, together with new buildings in Grants Pass and Seaside, and additions are scheduled for the East office in Portland, and for the Eugene and Klamath Falls buildings.

The telephone company not only retains architects and engineers to design buildings, but also, through the chief engineer's department, does a considerable amount of building designing and engineering.

NEWPORT BEACH, California:

New central office building which is located on the ocean front and embodies many characteristics of southern California architecture. The building contains numerous special features for employees who wish to spend leisure time on the beach. Donald B. Parkinson, Architect.



California Supreme Court Renders Decision in the "Kennedy Case"

The Supreme Court of the State of California recently made a decision of great interest to all engineers in the West. The citizens of San Francisco, in particular, should feel gratified that one element concerning their safety and the public welfare has been unanimously upheld by the Court. On July 5th, an opinion was rendered in the case of Clyde C. Kennedy vs. Harry D. Ross, Controller of the City and County of San Francisco, that completely clears all questions regarding the legality of the Director of Public Works of San Francisco in awarding contracts for the preparation of plans and specifications of professional engineers in private practice.

A review of the facts of this case is as follows:

On September 24, 1945, the Director of Public Works of the City and County of San Francisco entered into a written contract with Clyde C. Kennedy, consulting engineer of San Francisco, to furnish engineering and architectural plans, specifications, and estimates of cost for the construction of the proposed North Point Sewage and Sludge Treatment and Disposal Plant and appurtenant works and buildings to be located in the Islais Creek District, San Francisco, California. All architectural and engineering services were to be furnished by Mr. Kennedy and the assistants in his employ. The contract was approved by the Chief Administrative Officer of the City of San Francisco and by its City Attorney as to form. The Controller would not certify the contract without an expression from the Civil Service Commission as to its authority on endorsement of this contract. The Civil Service Commission referred the issue

to the City Attorney for a legal opinion as to the limits of its authority.

The Consulting Engineers Association of California, being deeply interested in the basic principles involved in this matter, as they directly affect the safety and welfare of the public, immediately took steps to help in its solution by retaining Mr. John L. McNab as attorney to assist in every possible legal manner. The opinion of the City Attorney was that the Civil Service Commission had no authority in the matter, and so advised the Controller, who then certified the contract, and Mr. Kennedy proceeded to fulfill his obligations.

On January 26, 1946, Clyde C. Kennedy completed the portion of the plans which called for his first payment. The Director of Public Works approved the plans and the claim, and a request for this payment of \$000,000 was presented to the Controller of the City of San Francisco. In the meantime, in December, 1945, a complaint was filed against the Controller to restrain him from making any payment under the Kennedy Contract, on the ground that the Contract had not been authorized by the Board of Supervisors, and that Mr. Kennedy had not been exempted by the Civil Service Commission pursuant to certain provisions of the Charter. The Controller then refused to make payment because of the filing of the Injunction Suit. A suit in mandamus was then filed by Mr. Kennedy for the collection of his first payment, and to establish the legality of his contract.

(Continued on Page 34)

mocracy will be determined in large measure by the success or failure of the forces operating to bring about permanent governmental controls of the construction industry."

Vice President F. W. Parrott, Sioux City, Iowa, in reporting as chairman of the Legislative Committee said:

"The accomplishments of the association in dealing with this subject are much greater than casual investigation will reveal. As unsatisfactory as many of the government regulations may be, it is well to note that by being constantly alert the staff has succeeded in eliminating or modifying many proposals before they became effective.

"This accomplishment was not only a benefit to members of the construction industry, but to the general public. Most of us believe that the general public will be much better served by a free, untrammelled operation of the construction industry than it will be by regulations which invariably decrease production and result in increased costs."

Discussions on labor relations, headed by committee chairman Carl B. Jansen, Pittsburg, and Assistant Managing Director J. D. Marshall, centered on the handling of wage stabilization within the industry in the event that wage and price controls were not renewed. The meeting opposed continuation of the Wage Adjustment Board for construction after expiration of wage and price control laws, and opposed re-enactment of such legislation. Mr. Marshall, an industry member of the Wage Adjustment Board, read a telegram which he had sent to the chairman of the board in which he emphatically dissented from a statement adopted by the board during his absence. The board had adopted a statement that price and wage controls were necessary under present economic conditions.

Wm. J. Barney, New York, Apprenticeship Committee, in his report strongly recommended programs which get apprentices working more quickly than regular programs but which do not cut down the total time of apprenticeship. He wrote: "This accelerated training is unquestionably the only answer in many communities to the immediate and pressing demand for more men on the work qualified to do at least the simpler craft operations."

Leo P. Richardson, Detroit, chairman, Specifications Committee, reported on progress made by a special subcommittee in working with the Bureau of Reclamation on means of lowering costs of

reclamation work, and of improving specifications and contract procedures. He also reported on similar work being undertaken by the Joint Cooperative Committee of the American Association of State Highway Officials and the A. G. C.

C. P. Street, Charlotte, N. C., chairman, Public Relations Committee, in reporting on the public relations program of the association, said: "The construction industry enjoys good public relations to the extent that it serves the public efficiently, economically, and promptly, and to the extent that the public believes it is being treated fairly. This makes it important for each general contractor to conduct his daily operations so that he both serves the public to the best of his abilities, and also takes steps to let the public know that he deserves their confidence."

Division Meetings

Each of the association's three divisions held separate meetings to discuss particular problems of various type of construction.

W. D. Shaw, New York, chairman, Building Contractors Division, reported that discussions had centered on the necessity for contractors to hold costs in line, on the need for attracting more manpower to the industry and of increasing the productivity of labor, and on use of escalator clauses. The division adopted a resolution asking that study be given to a program to attract workmen to the industry, and to give men a sense of pride and accomplishment in their work.

Morris E. DeWitt, Poplar Bluff, Mo., chairman, Highway Contractors Division, reported that discussion revealed that in most states the highway programs were progressing satisfactorily, and no outstanding difficulties were recorded. A general scarcity of skilled highway engineers was reported, due primarily to low salary scales. Concern was expressed over future ability of many states to finance their highway programs adequately. A report was made of the three 1946 meetings of the Joint Cooperative Committee, A.A.S.H.O.-A.G.C. Considerable discussion was given to problems under the federal-aid airport program.

Carl B. Jansen, Pittsburgh, chairman, Heavy Construction and Railroad Contractors Division, reported that contractors had confidence in their ability to man and equip jobs. Walter Young, chief engineer, Bureau of Reclamation, and other bureau officials attended the meeting which was devoted to a discussion on the use of escalator

clauses. The division recommended to the Executive Committee that continued study be given to such clauses.

Verne Warren, Spokane, Washington, reported to the board on the meeting of the A. G. C. Secretaries' Council, which was devoted to discussion of chapter management problems.

The Colorado Contractors Association, of which R. J. Lawrence is president and Earle W. Devalon managing director and the Colorado Building Chapter, of which Roger B. Mead is president and E. B. Tarpley executive secretary, assisted in arrangements for the meeting and provided entertainment.

OIL WELL SUPPLY COMPANY OPENS SAN FRANCISCO OFFICE

The establishment of a branch division sales office in San Francisco by the Oil Well Supply Company, has been announced by Warner F. Parker, California Division manager of the company.

The new office will service the increasing activity in foreign oil development by California producers, and in addition, will handle the domestic needs of the oil industry in the Northern California and San Francisco Bay area, according to Mr. Parker.

"Oilwell's" California division headquarters are located in Los Angeles with supply stores located in Los Angeles, Long Beach, Ventura, Avenal, Bakersfield and Taft.

In charge of the new branch division office in San Francisco is Randall D. Stone, formerly manager of the San Joaquin Valley district headquarters at Bakersfield.

The San Francisco office will be the present headquarters of H. L. Freeman, export representative of the company.

INDUSTRIAL VENTILATION RESEARCH PROGRAM

A long range research program has been inaugurated as a result of the common interest of the American Society of Heating and Ventilating Engineers and the U. S. Public Health Service in industrial ventilation.

A survey among 200 parties known to be interested in the subject brought 113 replies which indicated an almost universal desire for more dependable factual data on the design of industrial ventilation systems. Less than half those replying had any such data and only one in three was acquainted with any code or standard pertaining to the control of industrial atmospheric pollution by means of ventilation.

Using the results of the questionnaire as a guide,

a comprehensive long-range program of research was planned to provide quantitative data for the solution of industrial ventilation problems. Work on the program was started immediately and the first two studies have been completed at the A.S.H.V.E. Research Laboratory.

Another study deals with the nature of air flow in front of, and into suction openings. Data have been collected on the relationship of the centerline or axial velocity in front of suction openings to the volume rate of air flow on both unflanged and flanged hoods, and on hoods having large flat surfaces adjacent to one or more edges. The results of both studies will be published in the near future.

NEW SOURCES OF LUMBER TO BE DEVELOPED

The allotment of \$1,234,000 to Secretary of the Interior J. A. Krug for the construction of 222 miles of access roads to out-of-the-way timber lands on Indian reservations to boost production for the Veterans Emergency Housing Program by an estimated 17,070,000 board feet this year has been announced by Wilson W. Wyatt, Housing Expediter and Administrator of the National Housing Agency.

Since about 10,000 board feet of lumber is required for a six-room frame house, the additional lumber from Indian lands this year is the equivalent requirement for approximately 17,000 houses.

The roads, on eight reservations, will increase timber production by an additional 15,194,000 board feet in 1947, and all road projects will be under way within 30 days.

The access roads by reservations are: Navajo (Ariz.), 36 miles; Colville (Wash.), 20; Warm Springs (Ore.), 45; Yakima (Wash.), 50; Taholah (Wash.), 15; Klamath (Ore.), 20; Hoopa Valley, (Cal.), 8; Red Lake (Minn.), 28.

NEW ARCHITECTURAL QUARTERS

The firm of Dougan, Heims & Caine, Architects, have moved into new offices in the Terminal Sales Building, 1220 S. W. Morrison Street, Portland, Oregon.

L. L. Dougan, Bernard A. Heims, A. I. A., and Morton H. Caine, A. I. A., comprise the architectural firm.

SCRAP SHORTAGE ACUTE

The shortage of scrap has become more acute since many scrap dealers have held back sales in anticipation of increased prices, reports the Steel Scrap committee of the American Iron & Steel Institute.

\$14,000,000

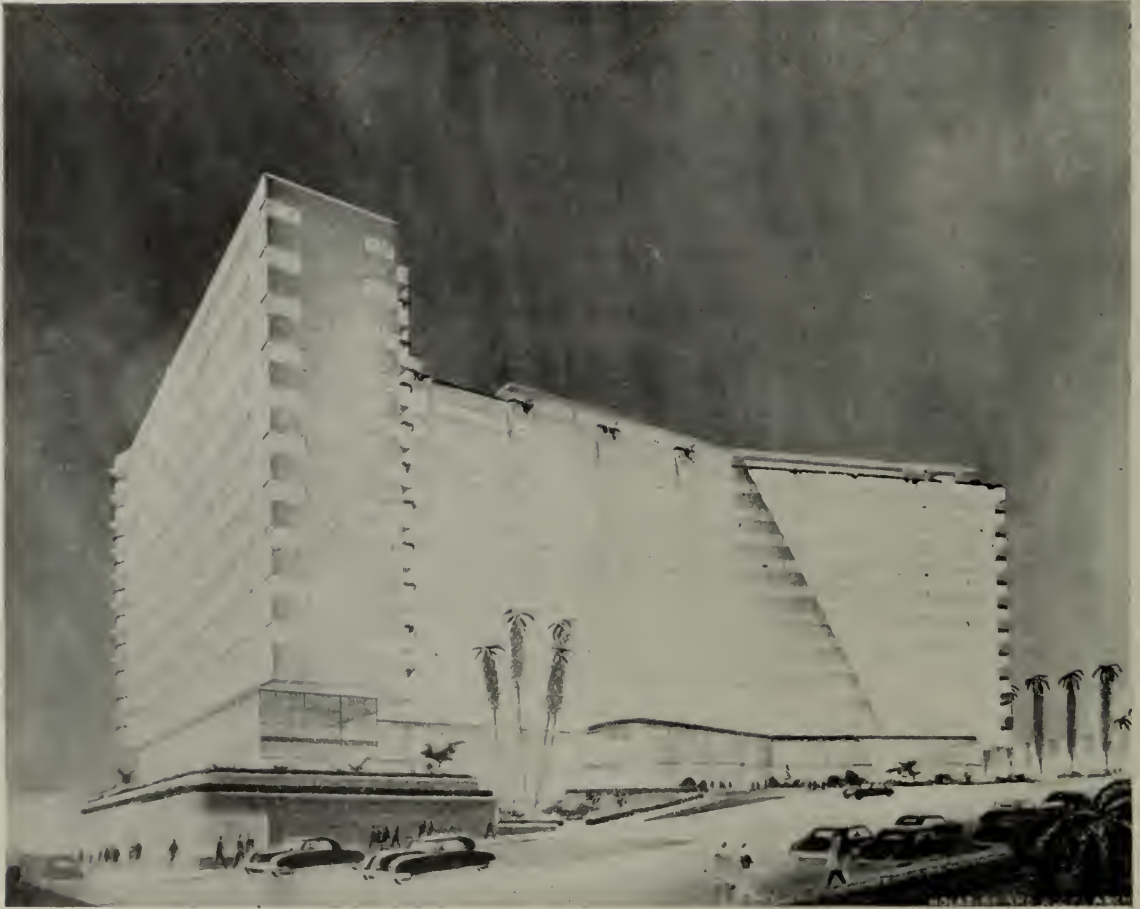

ARCHITECTS

Holabird and Root's conception of the new hotel to be constructed by Hotels Statler Company Inc., in Los Angeles at an estimated cost of \$14,000,000. It will be 13 stories in height and will have 1400 California styled guest rooms.

HOTEL

FOR

Los Angeles

A 1400-room hotel, to be constructed at an estimated cost of \$14,000,000, will be erected by Hotels Statler Company, Inc., on its recently acquired Los Angeles site on the west side of Figueroa Street from Wilshire Boulevard to Seventh Street, according to an announcement by John L. Hennessy, chairman of the board, and Arthur F. Douglas, president.

Furnishings for the guest and public rooms, the two officials stated, will cost an additional \$2,500,000.

No definite date has been set for starting work on the project, but from experiences in the construction of other Statler hotels, it is believed the Los Angeles unit will be ready for occupancy 18 months after the job is started.

The project will mean considerable employment for residents of Los Angeles and vicinity.

"In line with the Statler policy to use local associate architects, engineers and general contractors whenever possible," declared Douglas, "we believe our project will provide employment for many in and around Los Angeles. During the construction period, for example, we expect to have as many as 1500 men on our payroll. Since 60 per cent of construction costs today are wages, the Statler Company will pay out approximately \$8,400,000 in wages during the 18 months of construction."

Once the hotel is opened, it is expected there will be approximately 1200 men and women on the payroll. Virtually all will be recruited in the Los Angeles area.

The architects will take full advantage of the building code which will permit the hotel to be

13 stories in height. Architecture will be Californian, calling for full use of such popular Pacific Coast features as patios and terraces. The formal dining room, to be known as the California Room, will face a patio. Adjoining this room will be a cocktail lounge, also facing the same patio. In addition, there will be a Cafe Rouge which will be unique inasmuch as it will combine the semi-formal atmosphere of a dining room yet have coffee shop counter service.

Guest rooms will make a big step forward in hotel planning. Many will be living rooms by day and bedrooms by night. These living-bedrooms, first introduced in the Washington Statler, have proved very popular with the traveling public. Beds in these rooms are comfortable couches with full box springs and inner spring mattresses. The old hotel arrangement of bureau, desk and dressing table will be replaced by a single unit filling all three functions.

The Los Angeles Statler will include a number of new features. Windows, for example, will be large in order to make the best use of sunlight. All guest rooms will face a major thoroughfare. A large horizontal window will have venetian blinds and a ventilating sash at each end. By the window will be a comfortable seating group, a floor lamp and a coffee table. Each night table will house a four-channel radio and a lamp whose base serves as a telephone stand.

It is expected that present experiments with television will be completed before the opening of the Los Angeles hotel. These tests in television reception are being conducted daily by the Statler

(Continued on Page 30)



GOLDEN GATE BRIDGE

at San Francisco is the world's tallest and longest single span suspension bridge.

Rainbow Spans of Steel

By **DAVID B. STEINMAN**

A century and a half ago, the citizens of New York and Brooklyn began to dream of a bridge. The spirit of unbounded scientific progress was in the air. Nothing seemed impossible.

Thomas Pope, a local carpenter-shipbuilder, pro-

posed an arching span of timber high above the river in 1811. He built an impressive scale model and published a book poetically describing his bridge.

One showery day, according to the story, he

was the guest of Robert Fulton on one of the latter's newly-invented steamboats. As the vessel rounded the Battery, a rainbow spanned the river.

"See, there's your bridge, Pope," exclaimed Fulton. "Heaven favors you with a good omen."

The imaginative carpenter never did see his vision realized. But later in that century it came true. The great span was built—not in timber, but with the load hung from powerful cables of steel.

The Brooklyn Bridge, first to use steel for great spans, marked the beginning of an era of bridge-building that continues to unfold.

A 16th Century bridge designer, Palladio, recorded a belief that bridges should be "convenient, beautiful and durable." He expressed a timeless truth. Every bridge should be designed with the guiding and impelling thought to achieve beauty. **Strength, utility and beauty** must be combined. To these may be added a modern requirement—**efficiency**.

To build their famous aqueducts, the ancient Romans used thousands of tons of masonry in massive piers and arches to carry a small conduit for water supply. Today graceful, airy spans of steel, in seeming magic, carry thousands of tons of useful load.

Ponderous proportions are no longer the visual expression of power.

People have to live with the structures we build. Our works become a part of the landscape, to mar or to grace. If we are to be true to our trust, each structure we raise and each span we build must be a thing of uplift and inspiration.

The rainbow spans of tomorrow will have **simplicity of form, beauty of line, grace of proportion, harmony of color and radiant illumination**.

The two bridge types that most naturally yield beauty of form, line and proportion are the **arch** and the **suspension bridge**. Other types of bridges have been modified, strained or camouflaged to simulate them, but they are only a tacit tribute to recognized aesthetic superiority.

Contrasted with ordinary truss and girder spans, the arch contributes something dynamic—a feeling of a powerful thrust created in the span and carried down the curving arc to be resisted at the abutments. Of all arch forms the deck type is the most pleasing, because of its functional clarity.

As typified in the Henry Hudson Bridge, it yields a dominant, clear roadway line resting on the graceful curve of the supporting arch. The roadway represents the load to be carried, and it naturally and logically belongs above the arch. Otherwise, confusing intersection is produced. Because it represents the essential function of the structure, a clear, uninterrupted roadway line is an important element in bridge aesthetics.

The spandrel columns in a deck arch are also

functionally expressive. They introduce the fundamental principle of rhythm, with the elements of repetition, modulation and harmony. The effect is a rhythmic succession of beautiful notes—all combined in a melodic and harmonious composition.

Someone has aptly said that "architecture is frozen music."

To attain the most creative and inspiring beauty of composition in steel bridge design, the suspension type is ideal. The graceful curve of the cables is the most natural and therefore the most beautiful of all bridge outlines, and the vertical hangers, like the strings of a harp, are the most harmonious and satisfying form of filling members.

The dominant pylons divide the crossing into three spans of artistic proportion. Between the pierced towers the arching roadway slowly inclines upward to meet the swift downward sweep of the cables. The ensemble is a natural composition of power and symmetry.

Before the advent of steel it was necessary to build lofty bridge towers of masonry. The 19th Century bridges had to depend upon their stone towers for architectural character.

When steel came into use, some of the first designers to utilize it apparently missed its artistic possibilities and requirements. Steel towers and spans were built along strictly utilitarian lines and, in some mistaken ideas of economic design, seemed to go out of their way to violate every aesthetic intuition.

Then came attempts to secure architectural effects in steelwork through the addition of decorative details and ornamentation. That was the era of the heavily ornamented bridges, and of the "Beaux Arts" concept of artistic design. The architect left the main lines of the structure to the engineer, and the engineer gave the architect a free hand to add embellishments. But filigreed portals and finials could not disguise inartistic lines and awkward proportions.

We have now entered a third stage in the evolution of bridge design, in which the true artistic potentialities of steel are beginning to be realized—not by embellishment or decoration but by the development of structural forms that are inherently beautiful.

In 1928, to stimulate public and professional interest in the creation of beautiful spans, the American Institute of Steel Construction inaugurated a series of annual Artistic Bridge Awards. The 1929 award for the most beautiful bridge of the year went to the Mount Hope Bridge spanning Narragansett Bay—built "to take the Island out of Rhode Island."

The bracing of its towers was developed to yield an artistic composition, with lofty arched portals

above the roadway. The curving lines of the Gothic portals harmonize with the lines of the cables, in point and counterpoint.

In the George Washington Bridge, across the Hudson in New York, the strong aesthetic appeal is due largely to the natural grace and simplicity of the suspension type, expressed in this case by two high and sturdy towers and the great cables from which the slender floor system is suspended.

The setting for the St. Johns Bridge at Portland, Ore., challenged the designer to produce a span of matching beauty against the colorful panorama of city, river and valley below and peaks beyond. The selection of the suspension type, with its naturally graceful cable curve and harmonic composition, was the first step. Then in the lofty steel towers, the bracing naturally yielded a pointed arch high above the roadway, the lines of the arch harmonizing with the curving lines of the cables. The portal openings in the towers frame colorful views of green trees, blue sky and white clouds. The finial spires, carrying the aviation beacon lights, blend with the evergreen spires of the tree-tops in the background.

In this example of architecture in steel, beauty was secured without concealment, camouflage or ornamentation. The structural steel itself was planned for beauty of line, proportion, surface relief, light and shadow. And to all this was added color, the steel being painted a pleasing shade of verde green.

The bridge designer of this era has to be both engineer and artist combined. To a thorough understanding of structural design and function he must add a strong feeling, both innate and trained, for beauty of form, line and proportion.

In bridge after bridge, design engineers have now demonstrated that beauty can be secured without sacrificing utility or economy. They are directing their efforts toward producing the most beautiful designs in the steel itself, by developing forms that express the spirit of this metal—its strength, power and grace.

I think that no one, unless he is completely without feeling, can remain unmoved at the sight of a beautiful bridge. The arching span of steel, at once so delicate and strong, summons an an-

(Continued on Page 39)

A 16th Century Designer's Dream Comes True Today in Steel Bridges That Are Strong and Beautiful—"Poems Stretched Across a River"

MOUNT HOPE BRIDGE:

Across Mount Hope Bay between Bristol and Portsmouth, Rhode Island.



Radiant Heating



RADIANT HEATING DISCUSSED:

Northern California Chapter members of the Producer's Council hear Charles J. Nicholas (standing left), district manager of the Bastian-Morley Company, Inc., and Clyde E. Bentley, Engineer, discuss "Radiant Heating." Seated on Bentley's left is E. E. Cathcart, Council president and Sales Engineer of the Johns-Manville Sales Corporation, San Francisco.

LARGE ATTENDANCE AT FIRST OF SERIES OF MEETINGS ON PANEL HEATING

The first of a series of industry-consumer educational meetings devoted to the subject of design and installation of Radiant Heating was recently held in San Francisco, under sponsorship of the Northern California Chapter of the Producer's Council.

Charles J. Nicholas, district manager of the Bastian Morley Company, manufacturers of the new Basmor Boiler, served as chairman of the day.

In describing the many outstanding features of the Basmor Boiler, which is manufactured exclusively for the Crane Company, Nicholas pointed

out that Radiant Heating was a little known subject even by "heating experts," and that his company was developing a portable heating unit which would be available for use and demonstration through the Crane Company to groups interested in Radiant Heating.

Clyde E. Bentley, Engineer, spoke before the group on the subject "What the Consumer Gets When They Install a Radiant Heating Unit."

More than 85 members of the Chapter attended the meeting and because of the keen interest in meetings have been scheduled to further analyze and study the subject.

\$14,000,000 HOTEL FOR LOS ANGELES

(Continued from Page 25)

Company in its executive offices in Hotel Pennsylvania, New York.

Elaborate facilities are planned for such public functions as conventions, group meetings, banquets and luncheons. All the function space will be on one floor. The main ballroom will have a seating capacity of 1287. A foyer to this ballroom, which can be utilized as an assembly room, will seat another 416. There will be a secondary ballroom of 5000 square feet which, by special mechanical devices, can be made a part of the main ballroom. This ballroom will accommodate 746. There will be private banquet and dining rooms to accommodate as many as 300. Shops will be located on the Seventh and Figueroa Streets' sides of the lobby, in the arcade and in lobby passageways.

Below the ground level there will be garage accommodations for approximately 400 cars. There will be automobile driveways from at least two streets and guests may drive or send their cars to the underground garage from any entrance. An interior motor lobby will directly connect the garage with the hotel proper.

Guests arriving by automobile will be able to register and proceed to their rooms without having to pass through the main sections of the lobby. And guests using the dining rooms, cocktail lounge and the California Room will not be disturbed by the cross-current of incoming and outgoing guests.

The Los Angeles Statler will be the ninth link in the organization. Started in Buffalo in 1907.

BARRETT & HILP EXPAND

Barrett & Hilp, well-known construction organization, has opened a \$150,000 plant on 12 acres at South Hackensack, N. J., for the construction of precision-built homes within a radius of 80 miles.

R. H. Macy of New York, and L. Bamberger & Company of Newark, both of which have displays open to the public, will handle the sales of the houses to be built by Barrett & Hilp.

Joseph L. Rusch, vice president in charge of sales for the Alexander Summer Company of Teaneck, N. J., realtors, declared: "The coming of Barrett & Hilp will mean a tremendous speed-up in the rate of building houses in North Jersey, Connecticut, and New York."

According to company officials the houses will range from \$7500 to \$8500. Plant operations will be in charge of Stanley Brown.

NEW ROLLER GUIDES

SAVE ELEVATOR

The Elevator Safety Corporation, 165 Broadway, New York City, is accepting orders for the Elsco Safety Roller Guides for Elevators.

The Elsco Guide, designed for new installations or as a replacement for the old slipper type sliding shoes, shows savings in current consumption and maintenance costs of 24 per cent to 44 per cent, according to reports from present installations.

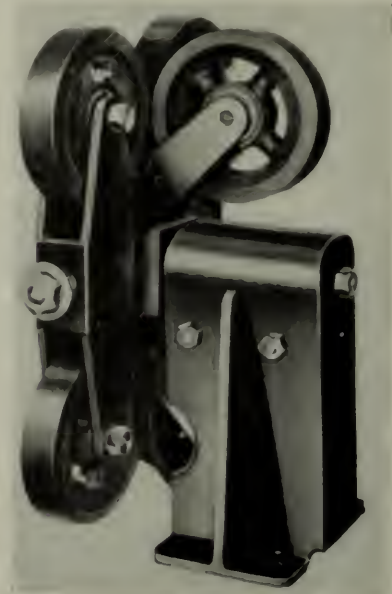

The Elsco Roller Guide contacts the guide rail with rollers mounted on compensating arms designed to yield automatically under varying conditions of use and yet to maintain constant contact with the rail. Elimination of friction results in savings in maintenance and current, and eliminates greasing of the rails with a consequent reduction of the fire hazard in the shaftway.

The stabilizing spring suspension eliminates rail joint knocks and absorbs rail inequalities, giving a smooth, gliding ride.

The Elsco Safety Roller Guides have been approved by the Board of Standards and Appeals of the City of New York for use up to 1200 feet per minute.

FOR RENT

Forty-six per cent of the housing units started during May will be offered for rent, the NHA reveals. This checks with surveys which indicate about half the veterans prefer to rent, rather than build homes.

A. I. A.

American Institute



ACTIVITIES

of Architects

CALIFORNIA COUNCIL OF ARCHITECTS:

John S. Bolles, President; Charles O. Matcham, Vice-President; James H. Mitchell, Secretary-Treasurer; 369 Pine Street, San Francisco 4.

Washington State Chapter:

George W. Stoddard, President; Clifton J. Brady and Joseph H. Wohleb, Vice-Presidents Stephen H. Richardson, Secretary; J. H. Dillon De Hart, Treasurer; Offices 516 Central Building, Seattle 4, Washington.

Northern California Chapter:

Andrew T. Hass, President; Hervey Parke Clark, Vice-

President; John S. Bolles, Secretary; Ernest Born, Treasurer; 369 Pine Street, San Francisco 4.

Central Valley Chapter (California):

Herbert E. Goodpaster, President; James A. Gillem, Vice-President; Frank V. Mayo, Secretary; Victor Galbraith, Treasurer; Offices 834 West Willow Street, Stockton.

Southern California Chapter:

Charles O. Matcham, President; Adrian Wilson, Vice-President John Landon, Secretary; Albert C. Martin, Jr., Treasurer; Offices 3757 Wilshire Blvd., Suite 212, Phone Fltzroy 2393 or Mutual 4592. DIRECTORS, John Rex, Paul R. Hunter, and Weldon D. Becket.

CALIFORNIA COUNCIL OF ARCHITECTS

The quarterly meeting of the California Council of Architects was held in Monterey on June 28 and 29. The Northern California Chapter was represented by delegates Andrew T. Hass, James H. Mitchell, and John S. Bolles as well as by Ernest Born, chairman of the Publications Committee, and Wayne S. Hertzka, chairman of the Council's Convention Committee.

Highlights of the meeting were the programs presented by Vincent Palmer on Ways and Means, and by Adrian Wilson, on Legislation. Both are members of the Southern California Chapter.

* * *

ERNEST BORN, 730 Montgomery Street, San Francisco 11, is now assembling material for the BULLETIN to be issued during August which will combine reports and activities of the five California Chapters of the American Institute of Architects.

NORTHERN CALIFORNIA CHAPTER

Highlights of the recent 78th annual convention at Miami Beach have been given members through the CHAPTER-BULLETIN. Complete reports being given by Andrew T. Hass, Chapter president, and Hervey Parke Clark, vice-president, both of whom (along with John S. Bolles, president California Council) were in attendance at the convention.

Considerable attention is being given San Francisco's proposed new building code, the Chapter committee of Albert J. Evers, chairman, A. Lewis Koue and Vincent G. Raney, working in close cooperation with city officials.

* * *

Considerable increase and change in Chapter membership has been effected in the past few months.

Plans for the joint meeting of the California Chapters to be held in Coronado on October 10, 11 and 12, 1946, are in charge of member Wayne S. Hertzka.

CENTRAL VALLEY CHAPTER

The territory of the Central Valley Chapter consists of all of northern and central California east of the Coast Range Mountains, including Shasta County on the north and Kern County on the south, together with the State of Nevada. With the territory so large, meetings have been held alternately in Sacramento and Stockton.

President Goodpaster presided at a recent special meeting in Fresno, with representative members from Fresno, Modesto, Sacramento and Stockton present. At this meeting non-members and allied draftsmen were invited and the aims of the Institute were outlined. David Horn stressed the need for further organization in the Fresno-Bakersfield area and regular meetings will soon be inaugurated in that area. Frank Mayo, the Chapter's delegate to the Miami convention, gave his report. On-the-job training was outlined and discussed.

Weekly luncheon meetings are held each Tuesday in Sacramento at the Lunchette, 1124 J Street. All visiting architects are invited to attend.

SOUTHERN CALIFORNIA CHAPTER

President Chas. O. Matcham, in conjunction with the possibilities of holding an Institute convention in Los Angeles, has indicated there is an unlimited opportunity for the profession to serve southern California by working out plans and having proper governmental agencies adopt a Master Plan of community planning.

(Continued on Page 43)

WITH THE ENGINEERS

Structural Engineers Association of
Northern California

W. Adrian, President; William W. Moore, Vice-
President; Franklin P. Ulrich, Sec-Treas.; John A.
Blume, Ass't. Sec-Treas.; Offices 214 Old Mint
Building, San Francisco, Phone GARfield 3890. DI-
RECTORS, H. M. Engle, Mark Falk, and M. V.
Pregnoff.

American Society of Civil Engineers
San Francisco Section

Theodore P. Dresser, Jr., President; Leon H.
Nishkian and Sidney T. Harding, Vice-Presidents;
John E. Rinne, Secretary-Treasurer; 225 Bush Street,
San Francisco 20.

Puget Sound Council (Washington)
Engineering & Technical Societies

R. E. Kistler, A. I. E. E., Chairman; A. L. Miller,
A.S.C.E., Vice-Chairman; L. B. Cooper, A.S.M.E.,
Secretary; B. A. Travis, I.E.S., Treasurer; Offices,
Seattle, Washington.

ENGINEERING MEETING

The National West Coast Transportation and
Maintenance meeting of the national Society of
Automotive Engineers will be held August 22, 23,
24, in Seattle, Washington.

The National Tractor Meeting of the Society of
Automotive Engineers is scheduled for September
11 and 12, in Milwaukee, Wisconsin.

ED S. BANTA has opened offices at 478 Jackson

Street, San Francisco, and will deal in construc-
tion materials.

W. P. DAY & ASSOCIATES have moved into
new offices at 111 New Montgomery Street, San
Francisco.

R. D. DALTON, for more than 20 years with
the Oakland Building Department, has opened
offices at 1723 Webster Street, Oakland, California,
for private practice.

WALTER T. NORRIS, formerly with the AISC in
San Francisco, has accepted a position with the
Pacific Iron and Steel Company in Los Angeles.

POPERT TAKES OVER

William H. Popert, in charge of Public Education
for the Structural Engineers Association of North-
ern California, and editor of the Association's
Structural Engineers News, is serving as Secre-
tary of the American Institute of Steel Construc-
tion, with offices in the Russ Building, San Fran-
cisco.

ADMINISTRATIVE DISTRICTS FORMED FOR CENTRAL VALLEY

Creation of two new administration districts in
the Central Valley Project have been announced
by the U. S. Bureau of Reclamation.

One will be at Merced, covering the central dis-
trict, which will be in charge of Jack W. Rodner,
engineer, and Irrigation Specialist. The other dis-
trict will have headquarters at Fresno and will
be in charge of Robert B. Cozzens, engineer, who
is well known in California.

OFFICERS ELECTED FOR FISCAL YEAR

The Oakland, California, Chapter of the Ameri-
can Society of Heating & Ventilating Engineers
recently elected the following officers to serve for
the year 1946-47:

James Gaynor, president Fred Kolb, vice-presi-
dent; Herb Hickman, secretary and Del Murphy,
treasurer.

S. W. Terry served as chairman of the nomi-
nating committee.

OPENS OFFICE

Sidney F. Bamberger and John Lyon Reid have
opened offices at 110 Market Street, San Fran-
cisco, under the firm name of Bamberger and Reid.
They will practice in the field of Architecture and
structural engineering.

HUNTINGTON BARKER, Architect, has moved
to 354 21st Place, Santa Monica, California.

*Built to
a definite
standard*

Every Halsey Taylor fountain is built to a
definite standard—that of health-safety.
Over the years Halsey Taylor Drinking
Fountains have met the most rigid re-
quirements in school installations, pro-
tecting pupils against the dangers of
contamination. Specify Halsey Taylor!
Ask for latest catalog.

THE HALSEY W. TAYLOR CO., WARREN, O.

S-4

HEALTH-SAFE DRINKING MOUND
FREE FROM CONTAMINATION



AMERICAN SOCIETY FOR METALS GRANTS NEW CHAPTER CHARTER

The American Society for Metals has granted a charter to thirty-seven metallurgists, physicists, chemists, engineers and technicians engaged in the atom bomb project for the formation of the Los Alamos (New Mexico), Chapter of the Society.

This will be the 69th ASM chapter within the United States and Canada and brings the Society's membership to more than 20,000.

W. H. Eisenman, national secretary, in announcing action of the Board of Trustees, stated, "in view of the stated permanency of the Los Alamos Atomic Bomb Laboratory project and because of the desire of many of its scientists for a chapter of the Society there, the Board of Trustees has unanimously approved the granting of this charter."

Los Alamos Chapter officers include Frank Kubosch, chairman; Harvey L. Slatin, vice chairman; James M. Taub, secretary, and Harold H. Hirsch, treasurer. Trustees are Walter F. Arnold, Gerald Tenney, William W. Wellborn, Eric R. Jette and Rex Peters.

INSTITUTE OF TECHNOLOGY ADDS DORMITORY FACILITIES

Nine buildings providing homes for 150 additional married war veterans studying at the Massachusetts Institute of Technology will soon be erected on the Institute's land west of Massachusetts Avenue and adjacent to Westgate, the housing project which is already occupied by 100 veterans and their families.

The Institute's dormitory facilities for unmarried undergraduate students are also being increased by reconverting one of the temporary war buildings into a dormitory which will provide well-equipped quarters for 600 men. This addition, which is to be ready in September, will give the Institute dormitory accommodations for 1300 undergraduates, while the Graduate House has accommodations for 450 advanced students.

The planning of the new housing units and their arrangement on the site has been handled by members of the staff of the Institute's School of Architecture and Planning under the direction of Dean William W. Wurster in collaboration with officials of the Federal Public Housing Authority.

ALFRED J. RYAN, Denver, Colorado, has been named chairman of a new Air Transport Division of the American Society of Civil Engineers. Other members include: H. Shifrin, St. Louis, Mo.; C. J. McCarthy, East Hartford, Connecticut, and George W. Burpee of New York.



Your clients will be pleased if you . . .

*Plan for a
number of
telephone
outlets*



Even if they'll only need one telephone immediately, your clients will see the wisdom of planning ahead for a number of built-in outlets.

Then future telephones can be added without bringing exposed wires in along the baseboards or molding. Telephone wire conduit is inexpensive to install during building, and it adds real value to a house.

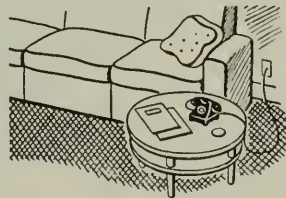

So work with an eye to the future. Call or dial your local Telephone Business Office and ask for Architects' and Builders' Service. This Service is at your disposal without charge.

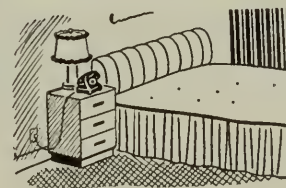

The Pacific Telephone and Telegraph Co.



COVER ILLUSTRATION

The cover photograph by Esther Born illustrates a near-perfect solution of the problem of integrating house, garden and environs. The site is a wide knoll in Marin County. The inevitable view of Mr. Tamalpais is retained without sacrificing the trees which give protection from glare and wind. The Architect, John S. Bolles, and the Landscape Architects, Williams and Eckbo, worked together to provide the owner with indoor and outdoor living. The house siding, terraced wall and the paving all utilize California's finest exterior materials—natural redwood.

CLOSES OFFICE

C. Sumner Greene, Architect, of Carmel, Calif., announces his retirement from the practice of architecture after a long and successful professional career.

CLARENCE O. PETERSON and WENDELL R. SPACKMAN, Architects, have moved into new offices at 593 Market Street, San Francisco, for the general practice of Architecture.

CALIFORNIA SUPREME COURT DECIDES "THE KENNEDY CASE"

(Continued from Page 21)

The Consulting Engineers Association of California so recognized the importance of this issue, to every member of the Association, that it assumed the full financial obligation for the conduct of the suit. It requested Mr. McNab to take every legal step for proper presentation of the case to court. Mr. Walter Hettman, Mr. Kennedy's personal attorney, worked with Mr. McNab throughout all legal proceedings.

Due to the emergency nature of the matter, and its importance to the citizens of San Francisco, the State Supreme Court, upon petition, consented to review the issue and render an opinion without the usual procedure of carrying it through the lower courts, and the case was presented on April 2, 1946. Other organizations became interested, resulting in the Municipal Conference of San Francisco requesting its attorneys, Sylvester McAtee and Allen G. Wright, to file a brief before the Supreme Court in support of Mr. Kennedy's case.

The opinion rendered by the Court, dated July 5, 1946, concludes with the statement: "No question is raised as to the power of the City under its charter to proceed in the matter of sewage reduction, treatment, and disposal (see City of Oakland v. Williams, 15, Cal. 2nd 542, at 550) and the record shows that since the adoption of the new Charter, the Department of Public Works, the Chief Administrative Officer, and the Board of Supervisors have so construed its provisions as not to require that contracts for expert and professional services be subject to the Civil Service provisions, or the procedure of competitive bidding. The practice has been for the Director of Public Works to make such contracts with independent contractors upon the approval of the Chief Administrative Officer and without advertising for bids. There is no language in the Charter which may be said to require a different method of procedure.

BAXCO
CHROMATED ZINC CHLORIDE

CZC

PRESSURE TREATED LUMBER
● **PROTECTS AGAINST DECAY
AND TERMITE ATTACK**

*Specify it in your home
Available through Lumber Dealers*

LOS ANGELES SAN FRANCISCO
601 W. 5th Street 333 Montgomery Street
Phone Mchigan 6294 Phone DOuglas 3883

J. H. Baxter & Co.
AGENTS FOR WEST COAST WOOD PRESERVING CO. SEATTLE, WASH.

From what has been said, it follows that the contract involved is valid and the petitioner is entitled to the relief sought."

The decision of the seven Supreme Court judges is unanimous, and so sweeping that there seems no question but that the safety and the public welfare of San Francisco citizens can be properly protected through the employment of engineers qualified to perform the special problems that may arise.

IN THE NEWS

ARCHITECT MOVES

HARRY M. MICHELSEN, A.I.A., announces the removal of his office from 405 Montgomery St. to 111 New Montgomery St., San Francisco.

A shortage of skilled workers in the building trades will delay the construction of veterans' homes as soon as the flow of building materials is stepped up, unless apprentice training is accelerated promptly in most parts of the country.—Douglas Whitlock, Advisory Board chairman, Producers' Council.

"Architecture as it is practiced in the public housing projects is a new art. It is not a simple study of housing planning, or relation of interior to exterior."—Jeannette Dyer Spencer, San Francisco Planning and Housing Association.

CLYDE F. TRUDELL, Architect, has moved from San Francisco to 188 Buckley Avenue, Sausalito, California.

DON B. WALLACE, president Don B. Wallace & Company, Detroit, Mich., mahogany importers, is importing CEDRO MACHO wood from Latin American countries to supplement the supply of mahogany.

G. F. MITCHELL, Civil Engineer, has moved to 926 South East Rex Street, Portland 2, Oregon.

SMITH, CARROLL & JOHNSON, Architects, have moved their Seattle, Washington, offices to 1408 East 45th Street, same city.

WHO WANTS A POWER-STARVED HOME?

Inadequate wiring makes even a brand-new home a disappointment to its owners.

If one appliance must be disconnected to plug in others, if lights frequently dim, if appliances heat slowly, if fuses burn out, if electricity is wasted—the home is definitely power-starved and the architect may be blamed for having failed to insist on adequate wiring.

The difference between a poor wiring job and an adequate wiring installation in a new home is very small, but means so much to future comfort and satisfaction.

Prevent power-starvation in the homes you plan by specifying large enough wire and plenty of outlets and circuits for all present and future needs.

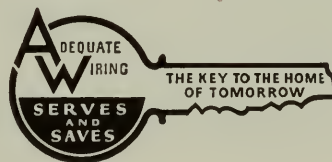

NORTHERN CALIFORNIA
ELECTRICAL BUREAU

1355 Market Street
San Francisco 3



WASHINGTON SOCIETY OF
LANDSCAPE ARCHITECTS

Seattle Landscape Architects have organized as the "Washington Society of Landscape Architects" to work more effectively as a group in furthering better design, construction and maintenance standards for garden owners and for all other landscape projects.

The immediate aims of the Society are to differentiate professionally trained Landscape Architects from members of other fields of gardening, to maintain high standards of professional practice, to collaborate with the other planning professions, and to study collectively all current problems of garden design and community planning.

The W. S. L. A. will have its headquarters in Seattle. The following officers have been elected for the coming year:

Cash M. Beardsley, President; Willard E. Morgan, Vice President; Roberta Wightman, Secretary-Treasurer. The following committee chairmen have been appointed: Noble Hoggson, Legislation and Publicity; Edwin W. Grohs, Architect & Engineer Representative; Otto E. Holmdahl, Nursery Liaison Representative; Mr. John Hanley, Education and Lectures; Linley Janzen, Civic Improvement; Robert J. Hansen, Membership.

HEADLINE NEWS & VIEWS

By E. H. W.

Page Mr. Bowles! A home in Glendale, California of course, sold for \$5,740 in 1941, \$8,950 in 1944, and \$16,800 in 1946.—Wall Street Journal statistics.

* * *

When the smoke of the OPA battle clears away, two factors will probably emerge very clearly: (1) that much of the hysteria about rising prices and run-away inflation was stimulated by OPA itself, and (2) the unqualified support of complete retention of OPA was strongly advocated by those engaged in Black Market operations.

* * *

Resumption of the Annual Joint Picnic of the Structural Engineers Association of Northern California and the Associated General Contractors—held on July 13th—is another indication that "conditions" are resuming some degree of normalcy. Prior to the WAR this was one of the outstanding "special events" of the year.

* * *

Plans for immediate construction of a \$500,000 three-level garage and service station at 6th Avenue and Olive Way in Seattle, Washington, has been announced.

Under consideration are four more "underground" parking garages in San Francisco. Looks like the lowly motorist who was surely the forgotten man recently is now getting a little attention.

* * *

New school construction continues to top the building list . . . if schoolroom facilities are to measure the degree of education of our "students"—America is going to get pretty smart.

* * *

Los Angeles is leading the West in value of building permits being issued; Denver is second Seattle, third; Long Beach, fourth; and San Francisco, fifth. In each city June, 1946, was ahead of June, 1945.

* * *

We would like to comment on the recent action of the Society of Industrial Designers, Inc., relative to an educational program—but, their "publicity" material is copyrighted . . . which goes to prove there IS something new under the sun, Copyrighted Publicity.

* * *

The \$25-million addition to the Columbia Steel Company's plant at Pittsburg, California, is progressing according to schedule, while several phases of the new construction are reported to be "very interesting" . . . too bad the "curbstone quarterbacks" can't watch and direct this job.

"GOODS OF THE WOODS"
E.K. WOOD LUMBER CO.
4710 SO. ALAMEDA

LOS ANGELES
—●—
OAKLAND
SAN FRANCISCO

IN THE NEWS

STEEL PRESIDENT RETIRES

J. Lester Perry, who rose from a steel plant clerk to the presidency of the Carnegie-Illinois Steel Corporation, retired on August 1, 1946.

NATIONAL HOUSING

A total of 675,721 houses and apartments were authorized for construction with priorities assistance under the Veterans Emergency Housing program from January 15, through June 28.

California, Oregon and Washington received 111,218, the largest number of any section.

APPOINTED

Farnes & Martig, Inc., Portland, Oregon, have been appointed sales and service representatives for Oregon, representing the Wheelco Instruments Company of Chicago, Illinois.

GIVEN AWARD

Dr. Edgar C. Bain, Pittsburgh, Pa., has been awarded the Albert Sauvour Achievement Award for 1946. He is vice president of the Carnegie-Illinois Steel Corporation in charge of metallurgy and research.

NATIONAL CONFERENCES

Plans for a series of nationwide home furnishing conferences this fall and winter have been developed by the National Retail Furniture Association.

Already more than 21 cities have been selected to participate in the program.

BOOM!

Three new atom smashers now being built at the University of California—the 4,000-ton cyclotron, the synchrotron, and the linear accelerator—will represent the most powerful and diversified array of atomic artillery the world has ever seen.

NAMED NHA DIRECTOR

Ross A. Gridley, Seattle, Washington, has been named director of the Construction Branch of the National Housing Agency. Aid to contractors in the building of houses under the VEHP is the objective.

WESTERN MADE



Quality LIGHTING FIXTURES

The West supports one of America's leading manufacturers of lighting equipment... producing quality fixtures bearing a nationally known label. With production concentrated on the Pacific Coast, Smoot-Holman Co. assures western users a dependable source of supply for all types of commercial and industrial incandescent and fluorescent lighting.

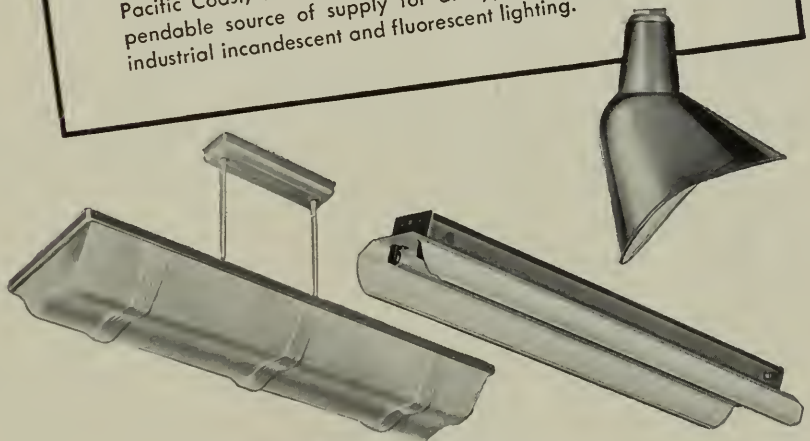

LOOK FOR THIS LABEL FOR THE FINEST IN INCANDESCENT AND FLUORESCENT LIGHTING

PRODUCER'S COUNCIL PAGE

The National Organization of Manufacturers of Quality Building Materials and Equipment
affiliated with THE AMERICAN INSTITUTE OF ARCHITECTS

President, E. E. CATHCART
Johns-Monville Sales Corp.
116 New Montgomery St.

Vice-President, C. J. NICHOLAS
Bostion-Marley Co.
301 Brannan St.

Secretary, H. C. GALITZ
Westinghouse Electric Corp.
110 Sutter St.

Treasurer, E. P. LARSON
Celatex Corp.
675 Townsend St.

Edited by C. W. KRAFT, KRAFTILE CO., Niles, California

NORTHERN CALIFORNIA CHAPTER



OTIS WINFIELD
Manager, The Kawneer Company

Otis Winfield is another man who got his Producers' Council start elsewhere—he was one of the organizers of the Dallas Chapter which he served as Chairman of the Entertainment Committee.

From Texas Otis went to Michigan at the outbreak of the war to take charge of the Rolling Division and thence out to California as Manager for The Kawneer Company at Berkeley. In this capacity he is credited with starting the "Main Street Modernization" idea that provided the stimulus for the Business Planning Institutes of the State Board of Education, an idea that has since spread to four other states and has the support of the Bank of America, P. G. & E., General Electric and a long list of building material manufacturers.

Otis hails from Norfolk, Virginia, came to California in September, 1944. He is married, has one daughter and lives in Berkeley.

His other organizations include Masonic Lodge, Elks, San Francisco Ad Club, Athens Athletic Club. His favorite sports and golf and hunting.

BEST MEETING in a long time in both attendance and presentation of a subject of timely interest was Charles Nicholas' program on "Radiant Heating" with Clyde Bentley sharing the speaking honors. This was a fine example of a presentation of collateral materials in an integrated story featuring the functions of the "Basmor" gas-fired

boiler, The Bell & Gossett pump and The Hoffman Indoor-Outdoor Control Thermostat.

JIM FOLLIN, Managing Director of the P. C. in Washington, D. C., has been invited out this way for the Architects State Convention tentatively set for October 10-12 in San Francisco by John Bolles, President. This will be Jim's first visit to the Coast Chapters since pre-war days.

MODULAR PLANNING BY NAVY. The Navy is developing modular designs for its buildings. A naval ordnance plant is under construction at White Oaks, a suburb of Washington, D. C., which was designed on a modular basis and is using approximately two million of the modular standard facing brick (3 courses to 8 inches). We have also learned that the U. S. Naval Hospital proposed for construction at Austin, Texas, is being designed for the use of modular clay products.

MODULAR MOMENTS

Question: Why are modular steel windows shown in catalogs in fractional sizes such as 3'-4 $\frac{7}{8}$ "", 5'-9 $\frac{7}{8}$ "", etc.?

Mr. Lorimer: Actually, steel windows are coordinated in multiples of 4" bar center to bar center. The older steel window catalog indication of exact required masonry opening was carried forward into the modular catalogs. 7/16" clearance is required between the edge bar center and the jamb face on each side of the window to permit of hinges and vent clearance. This has been the practice for 25 years. The window size in 4" multiple plus 7/16" plus 6/16" gives the catalogued dimensions of 5'0 $\frac{7}{8}$ "", etc.



USE QUALITY PRODUCTS



CONSULT AN ARCHITECT

RAINBOW SPANS OF STEEL

(Continued from Page 28)

cient dream in the heart of man—the dream of flight. It is as if the bridge itself lifted wings and soared from shore to shore.

There is the same feeling of lifted wings in the Gothic arch, which was, no doubt, one of the reasons it inevitably evolved from the sublime aspiration of the religious spirit. When we use the Gothic arch in steel tower bracing, it is simply because the pointed arch suits the material and the engineering design. The semicircular arch suggests Voussoir masonry—blocks of material in compression. But the pointed arch is the expression of flexural material; we have the prototype in the arcade formed by the interlacing branches of trees.

In fact, the Gothic arch is even more appropriately expressed in steel than in its original stone. It has found a more suitable material for its expression. In the lofty towers of a suspension bridge the pointed arch formed by the junction of the bracing, springing from the main trunks, is in contrapuntal harmony with the dominant theme supplied by the cables—graceful curves soaring upward and meeting in a point.

In addition to beauty of line the spans of tomorrow, like their rainbow prototype, will have brightness and warmth of color to satisfy a color-minded people.

Commencing with the Mount Hope Bridge in 1929, I introduced the idea of color in bridges, first using light tints of green and then, becoming bolder, verde and jade green. It seemed desirable to get away from the cold, somber coatings of black and battleship gray that had been the prevailing practice.

Other hues are being progressively ventured, as well as two-color and two-tone schemes for differentiation or emphasis of elements. When the George Washington Bridge was nearing completion, artists and laymen wrote letters to the press pleading that the red lead priming coat used during erection of the bridge be retained as the final color of the steelwork.

Illumination is a comparatively new but vigorous contribution to the aesthetic aspect of bridges. "Painting with light" will be an integral part of their design. With phosphorescent color and fluorescent radiance, unforgettable effects of luminous magic will be produced. At night the rainbow span will be an arc of radiant glow.

A bridge is the embodiment of the effort of human heads, hearts and hands. It is an expression of Man's creative urge. And, when viewed in the glow of sunset or the enchantment of moonlight, it is, indeed, "a poem stretched across a river."

SISALKRAFT

REG. U. S. PAT. OFF.

"More than a building paper"

THE SISALKRAFT CO.

205 West Wacker Drive
Chicago, Ill.

55 New Montgomery Street
San Francisco, Calif.

BASALITE

LIGHTWEIGHT CONCRETE
BUILDING UNITS

CHARACTER • ECONOMY • INSULATION
FIRE-SAFE • TERMITE PROOF • PERMANENCE

BASALT ROCK CO., INC.
NAPA, CALIFORNIA

FORDERER CORNICE WORKS

Manufacturers of

Hollow Metal Products • Interior Metal Trim
Elevator Fronts and Cabs
Metal Plaster Accessories • Sanitary Metal Base
Flat and Roll Metal Screens
Metal Cabinets • Commercial Refrigerators

269 POTRERO AVE.

SAN FRANCISCO, CALIF.

HEMLOCK 4100

STRUCTURAL STEEL

For Class A Buildings,
Bridges, etc.

JUDSON PACIFIC - MURPHY CORP.

1200 SEVENTEENTH STREET
SAN FRANCISCO

Plants: San Francisco - Oakland

IN THE NEWS

MASONITE CORPORATION PERSONNEL CHANGES

Several major changes in the executive sales personnel of the Masonite Corporation have been announced.

Robert T. Miller, for 20 years Chief Sales Engineer, has been appointed manager of the Industrial Division, and will have charge of all industrial activities. George Syversen has been named Chief Sales Engineer.

Donald E. Allen, assistant advertising manager, has been named Advertising Manager and Director of Public Relations, succeeding E. Howard Claypoole, resigned.

JOHN J. ROTH, Architect, has moved to 4543 Melbourne Avenue, Los Angeles 27, California.

NEW SEATTLE GARAGE

Standard of California has announced plans for immediate construction of a \$500,000 three-level garage and service station at 6th Avenue and Olive Way, Seattle, Washington.

DESIGNED TO USE

In the development of your business . . . now and in the postwar era.

Many subscribers to *Architect's Reports* find these ADVANCE building surveys . . . giving name of project, location, architect, proposed cost and other pertinent information a "must have" service to their business planning.

Data furnished you DAILY at a cost of \$10 per month.

Phone EXbrook 7182 — Subscribe Today

ARCHITECT'S REPORTS

Published Daily by

ARCHITECT and ENGINEER, Inc.

68 Post Street, San Francisco

EXbrook 7182

Topped by a super service station, the installation will include two underground levels for off-street parking with ramps for entrance and exits on both streets.

Scheduled for completion in January, 1947, the station will have a capacity of 300 cars, but it is estimated an average of 750 cars will be accommodated on an average business day.

Sound Construction and Engineering Company of Seattle are the contractors.

HAROLD W. HAWES, Architect, has moved to 407 Sansome Street, San Francisco.

ELECTED PRESIDENT

Carter and Galantin, Inc., a newly organized firm engaged in the design and production of mechanical devices in cardboard and metal for promotional advertising use, announces the election of Mr. Henry E. Carter as President, Mr. Joseph Galantin as Vice-President, and Mr. Ken Meyer as Secretary.

Mr. Carter, creator and producer of many mechanical devices and instruction manuals used by the Armed Forces, was formerly manager of the Stemar Company of Chicago, engaged in the same line of work.

Mr. Galantin has a long practical experience in offset and printing production gained as assistant manager of the Marquette Offset Corporation of Chicago.

L. R. BAILEY, Architect, has moved into new offices at 404 Lewis Building, Portland 4, Oregon.

PLANT COMPLETED

The Pemco Corporation have completed their new plant at Baltimore, Maryland, which was built for the purpose of producing glass and ceramic colors.

New manufacturing processes now permit the making of glass sulfide resistant colors in both enamel and satin matt finish.

J. Eugene Eagle, has been appointed head of the company's new sales and service organization.

GEORGE ADAMS, Architect, has moved to 216 West Los Feliz Road, Glendale, California.

SEEKS LITERATURE

The offices of James C. Gardiner & Associates, Puget Sound Bank Building, Tacoma 2, Washington, is seeking catalogues and manufacturers literature on new products.

ESTIMATOR'S GUIDE

BUILDING AND CONSTRUCTION MATERIALS

PRICES GIVEN ARE FIGURING PRICES AND ARE MADE UP FROM AVERAGE QUOTATIONS FURNISHED BY MATERIAL HOUSES TO SAN FRANCISCO CONTRACTORS. 2½% SALES TAX ON ALL MATERIALS BUT NOT LABOR

All prices and wages quoted are for San Francisco and the Bay District. There may be slight fluctuation of prices in the interior and southern part of the state. Freight cartage, at least, must be added in figuring country work.

BONDS—Performance—\$10 per \$1000 of contract. Labor and materials, \$10 per \$1000 of contract.

BRICKWORK—

Common Brick—Per 1M laid—\$50.00 to \$60.00 (according to class of work).
 Face Brick—Per 1M laid—\$120 to \$150 (according to class of work).
 Brick Steps—\$1.60 per lin. ft.
 Brick Veneer on Frame Bldg.—Approx. \$1.30 per sq. ft.
 Common Brick—\$19.00 per M, truckload lots, f.o.b. job.
 \$19.00 per M, less than truckload, plus cartage.
 Face Brick—\$40 to \$80 per M, truckload lots, delivered.
 Cartage—Approx. \$4.00 per M.

BUILDING PAPER—

1 ply per 1000 ft. roll.....\$3.50
 2 ply per 1000 ft. roll..... 5.00
 3 ply per 1000 ft. roll..... 6.25
 Brownskin, Standard, 500 ft. roll..... 5.00
 Sisalkraft, 500 ft. roll..... 5.00
 Sash cord com. No. 7.....\$1.20 per 100 ft.
 Sash cord com. No. 8..... 1.50 per 100 ft.
 Sash cord spot No. 7..... 1.90 per 100 ft.
 Sash cord spot No. 8..... 2.25 per 100 ft.
 Sash weights, cast iron, \$50.00 ton.
 Nails, \$3.42 base.
 Sash weights, \$45.00 per ton.

CONCRETE AGGREGATES—

The following prices net to Contractors unless otherwise shown.
Gravel, all sizes—
 \$1.95 per ton at Bunker; delivered\$2.50

	Bunker	Del'd
Top Sand	\$1.90	\$2.50
Concrete Mix	1.90	2.45
Crushed Rock, ¼" to ¾".....	1.90	2.50

Crushed Rock, ¼" to 1½".....	1.90	2.50
Roofing Gravel	2.25	2.80
River Sand	2.00	2.45

Sand—

River Sand	2.00	2.45
Lapis (Nos. 2 & 4).....	2.85	3.15
Olympia (Nos. 1 & 2).....	2.85	3.10
Del Monte White84c per sack	

Cement—

Common (all brands, paper sacks), carload lots, \$2.42 per bbl. f.o.b. car; delivered \$2.72.
 Cash discount on carload lots, 10c a bbl., 10th Prox.; less than carload lots \$3.20 per bbl. f.o.b. warehouse or delivered.

Cash discount 2% on L.C.L.
 Atlas White } 1 to 100 sacks, \$2.50 sack
 Calaveras White } warehouse or del.; \$7.65
 Medusa White } bbl. carload lots.

Forms labor average \$350 per 1000 sq. feet.
 Average cost of concrete in place, 50c per cubic foot, exclusive of forms; \$15.00 per cubic yard. With forms \$1.60 per cubic foot.

DAMP-PROOFING and Waterproofing—

Two-coat work, \$3.50 per square.
 Membrane waterproofing—4 layers of saturated felt, \$7.00 per square.
 Hot coating work, \$2.50 per square.
 Medusa Waterproofing, \$3.50 per lb. San Francisco Warehouse.
 Tricocel waterproofing.
 (See representative.)

ELECTRIC WIRING—\$12 to \$15 per outlet for conduit work (including switches).
 Knob and tube average \$3.00 per outlet. (Available only for priority work.)

ELEVATORS—

Prices vary according to capacity, speed and type. Consult elevator companies. Average cost of installing a slow speed automatic passenger elevator in small four story apartment building, including entrance doors, about \$6500.00.

EXCAVATION—

Sand, 60 cents; clay or shale \$1 per yard.

Trucks, \$20 to \$32 per day.

Above figures are an average without water. Steam shovel work in large quantities, less; hard material, such as rock, will run considerably more.

FIRE ESCAPES—

Ten-foot galvanized iron balcony, with stairs, \$150 installed on new buildings; \$160 on old buildings.

FLOORS—

Composition Floors, such as Magnesite, 50c per square foot.
 Linoflor—2 gages—\$1.25 to \$2.75 per sq. yd.
 Mastopave—90c to \$1.50 per sq. yd.
 Battleship Linoleum—available to Army and Navy only—1/8"—\$1.75 sq. yd. 3/8"—\$2.00 sq. yd.
 Terazzo Floors—50c to 70c per sq. ft.
 Terazzo Steps—\$1.75 per lin. ft.
 Mastic Wear Coat—according to type—20c to 35c.
Hardwood Flooring—
 Standard Mill grades not available.
 Victory Oak—T & G
 1½" x 2¼".....\$143.25 per M. plus Cartage
 1½" x 2"..... 122.00 per M. plus Cartage
 1½" x 1½"..... 113.50 per M. plus Cartage
 Prefinished Standard & Better Oak Flooring
 1½" x 3¼".....\$180.00 per M. plus Cartage
 1½" x 2½"..... 160.50 per M. plus Cartage

Maple Flooring
 1½" T & G Clear \$160.50 per M. plus Ctg.
 2nd 153.50 per M. plus Ctg.
 3rd 131.25 per M. plus Ctg.
 Floor Layers' Wage, \$1.87½ per hr. (Legal as of Jan. 21, 1946. Given us by Inlaid Floor Co.)

GLASS—

Single Strength Window Glass.....	20c per	□ ft
Double Strength Window Glass.....	30c per	□ ft.
Plate Glass, under 75 sq. ft.....	\$1.00 per	□ ft.
Polished Wire Plate Glass.....	1.40 per	□ ft.
Rgh. Wire Glass34 per	□ ft.
Obscure Glass27 per	□ ft.
Glazing of above is additional.		
Glass Blocks	\$2.50 per	□ ft. set in place

HEATING—

Average, \$1.90 per sq. ft. of radiation, according to conditions.
 Warm air (gravity) average \$64 per register.
 Forced air, average \$91 per register.

IRON—Cost of ornamental iron, cast iron, etc., depends on design:

LUMBER—All lumber at O.P.A. ceiling prices—

No. 1 Common.....	\$49.00 per M
No. 2 Common.....	47.75 per M
Select O. P. Common.....	52.75 per M

Flooring—

	Delvd.
V.G.-D.F. 8 & Btr. 1 x 4 T & G Flooring.....	\$80.00
C 1 x 4 T & G Flooring.....	75.00
D 1 x 4 T & G Flooring.....	65.00
D.F.-S.G. 8 & Btr. 1 x 4 T & G Flooring.....	61.00
C 1 x 4 T & G Flooring.....	59.00
D 1 x 4 T & G Flooring.....	54.00
Rwd. Plastic—"A" grade, medium dry.....	82.00
"B" grade, medium dry.....	78.50

Plywood—not available

	Under \$200	Over \$200
"Plyscord"—3/8".....	\$49.50	\$47.55
"Plywall"—1/4".....	45.15	43.30
3 ply—2/s—1/4".....	48.55	46.60
"Plyform"—5/8".....		
Unoiled.....	126.50	121.45
Oiled.....	127.90	122.75

Above prices delivered if quantity is sufficient to warrant delivery.

Shingles (Rwd. not available)—

Red Cedar No. 1—\$6.75 per square; No. 2, \$5.75; No. 3, \$4.45.
Average cost to lay shingles, \$3.00 per square.
Cedar Shakes—Tapered: 1/2" to 3/4" x 25"—\$8.95 per square.
 Resawn: 3/4" to 1 1/4" x 25"—\$10.65 per square.
 Resawn: 3/4" to 1 1/4" x 25"—\$10.65 per square.
Average cost to lay shakes, \$4.00 per square.

MILLWORK—Standard.

D. F. \$100 per 1000. R. W. Rustic \$100.00 per 1000 (delivered).
Double hung box window frames, average with trim \$6.50 and up, each.
Complete door unit, \$10.00.
Screen doors, \$3.50 each.
Patent screen windows, 25c a sq. ft.
Cases for kitchen pantries seven ft. high, per lineal ft., \$9.00 each.
Dining room cases, \$9.00 per lineal foot.
 Rough and finish about 80c per sq. ft.
Labor—Rough carpentry, warehouse heavy framing (average), \$40.00 per M.
For smaller work average, \$40.00 to \$55.00 per 1000.

MARBLE—(See Dealers)

PAINTING—

Two-coat work.....	per yard 50c
Three-coat work.....	per yard 70c
Cold water painting.....	per yard 10c
Whitewashing.....	per yard 8c

PAINTS—

Two-coat work.....50c per sq. yd.
Three-coat work.....70c per sq. yd.
Cold water painting.....per yard 10c
Whitewashing.....8c per sq. yd.
Turpentine \$1.03 per gal. in drum lots.
 \$1.08 per gal. in 5-gal. containers.
Raw Linseed Oil—not available.

Boiled Linseed Oil—\$1.38 per gal. in drums. Available only to work with high priority—\$1.48 per gal. in 5-gal. containers.

Use replacement oil—\$1.86 per gal. in 1-gal. containers.

Replacement Oil—\$1.20 per gal. in drums. \$1.30 per gal. in 5-gal. containers.
A deposit of \$6.00 required on all drums.

PATENT CHIMNEYS—

6-inch.....	\$1.20 lineal foot
8-inch.....	1.40 lineal foot
10-inch.....	2.15 lineal foot
12-inch.....	2.75 lineal foot

PLASTER—

Neat wall, per ton delivered in S. F. in paper bags, \$17.60.

PLASTERING (Interior)—

	Yard
3 Coats, metal lath and plaster.....	1.50
Keene cement on metal lath.....	1.80
Ceilings with 3/4 hot roll channels metal lath (lathed only).....	1.20
Ceilings with 3/4 hot roll channels metal lath plastered.....	2.20
Single partition 3/4 channel lath 1 side (lath only).....	1.20
Single partition 3/4 channel lath 2 inches thick plastered.....	3.20
4-inch double partition 3/4 channel lath 2 sides (lath only).....	2.20
4-inch double partition 3/4 channel lath 2 sides plastered.....	3.85
Thermax single partition; 1" channels; 2 1/4" overall partition width. Plastered both sides.....	3.30
Thermax double partition; 1" channels; 4 3/4" overall partition width. Plastered both sides.....	4.40
3 coats over 1" Thermax nailed to one side wood studs or joists.....	1.65
3 coats over 1" Thermax suspended to one side wood studs with spring sound isolation clip.....	1.90

Note—Channel lath controlled by limitation orders.

PLASTERING (Exterior)—

	Yard
2 coats cement finish, brick or concrete well.....	\$1.00
3 coats cement finish, No. 18 gauge wire mesh.....	2.00
Lime—\$3.00 per bbl. at yard.	
Processed Lime—\$3.10 bbl. at yard.	
Rock or Grip Lath—3/8"—20c per sq. yd.	
3/4"—19c per sq. yd.	

Composition Stucco—\$1.80 to \$2.00 sq. yard (applied).

PLUMBING—

From \$100.00 per fixture up, according to grade, quantity and runs.

ROOFING—

"Standard" tar and gravel, 4 ply—\$8.00 per sq. for 30 sqs. or over.
Less than 30 sqs. \$9.50 per sq.
Tile, \$30.00 to \$40.00 per square.
Redwood Shingles, \$7.50 per square in place.
5/2 #1-16" Cedar Shingles, 4 1/2"
Exposure.....\$8.00 square

5/8 x 16"—#1 Cedar Shingles, 5"
Exposure.....\$9.00 square
4/2 #1-24" Royal Shingles, 7 1/2"
Exposure.....\$9.50 square
Re-coat with Gravel \$4.00 per sq.
Asbestos Shingles, \$23 to \$28 per sq. laid.
1/2 x 25" Resawn Cedar Shakes,
 10" Exposure.....\$10.50
3/4 x 25" Resawn Cedar Shakes,
 10" Exposure.....11.50
1 x 25" Resawn Cedar Shakes,
 10" Exposure.....12.50
Above prices are for shakes in place.

SHEET METAL—

Windows—Metal, \$1.75 a sq. ft.
Fire doors (average), including hardware \$2.00 per sq. ft.

SKYLIGHTS—(not glazed)

Copper, 90c sq. ft. (flat).
Galvanized iron, 40c sq. ft. (flat).
Vented hip skylights 60c sq. ft.

STEEL—STRUCTURAL—

\$150 ton (erected), this quotation is an average for comparatively small quantities. Light truss work higher. Plain beams and column work in large quantities \$140 per ton.

STEEL REINFORCING—

\$100 to \$130 ton, set.

STONE—

Granite, average, \$6.50 cu. foot in place.
Sandstone, average Blue, \$4.00. Boise. \$3.00 sq. ft. in place.
Indiana Limestone, \$2.80 per sq. ft. in place.

STORE FRONTS (None available).

TILE—

Ceramic Tile Floors—\$1.00 to \$1.25 per sq. ft.
Cove Base—\$1.10 per lin. ft.
Glazed Tile Wainscot—\$1.25 per sq. ft.
Asphalt Tile Floor 1/8" & 3/8"—\$.18 to \$.35 sq. ft. Light shades slightly higher.
Cork Tile—\$.40 to \$.75 per sq. ft.
Mosaic Floors—see dealers.
Lino-Tile, \$.35 to \$.75 per sq. ft.

Wall Tile—

Glazed Terra Cotta Wall Units (single faced) laid in place—approximate prices:
2 x 6 x 12.....\$1.10 sq. ft.
4 x 6 x 12.....1.25 sq. ft.
2 x 8 x 16.....1.20 sq. ft.
4 x 8 x 16.....1.40 sq. ft.

VENETIAN BLINDS—

40c per square foot and up. Installation extra.

WINDOWS—STEEL—

30c per square foot, \$5 for ventilators.

ARCHITECT AND ENGINEER

"We must do something about it," he declared in presenting the situation to Chapter members.

* * *

Recordings of recent Institute convention subjects, a new feature with A.I.A. conventions, were presented members. These recordings may well be a method of obtaining complete reports on future conventions.

* * *

The membership committee notes an increase of members requesting membership applications in order to sponsor new men for Institute, Associate and Junior Associate classifications. Total membership is now 379.

* * *

The Committee for Veteran Training, Robert Fields, Jr., chairman, is in the process of setting up minimum requirements for the selection of veterans

who desire to enter the profession of Architecture, in conjunction with the Department of Industrial Relations of the State of California.

* * *

A long range program for guidance of the Chapter on legislative affairs has been submitted by Adrian Wilson, Legislative Chairman.

* * *

The Committee organized to issue the BULLETIN now consists of Jack Landon, Theodore Criley, Kemper Nomland, Harry MacDonald, Carleton Winslow, Jr., and Anthony Thormin now serving as Editor.

RECORD

The total number of dwelling units started in the first five months of 1946 under the VEH Program is nearly equal to all home construction during the previous two years. Some 406,000 units have been started during the first five months.

BUILDING TRADES WAGE (JOB SITES) NORTHERN AND CENTRAL CALIFORNIA

ATTENTION: The following are the PREVAILING hourly rates of compensation as determined by the Wage Adjustment Board, or which have been determined by the United States Department of Labor—Revised to July 1, 1946. Wage scales shown are those being paid and in effect mostly by agreement between employees and their union.

CRAFT	San Francisco	Alameda and Contra Costa	Marin	Vallejo	San Mateo	San Jose	Stockton	Sacramento	Fresno
ASBESTOS WORKERS.....	1.75	1.75	1.75	1.75	1.75	1.75	1.75	1.75	1.75
BRICKLAYERS.....	2.05	2.05	2.05	2.05	2.05	2.05	1.75	2.05	2.00
BRICKLAYERS, HODCARRIERS.....	1.57½	1.57½	1.57½	1.57½	1.57½	1.57½	1.47½	1.15	1.25
CARPENTERS.....	1.75	1.75	1.75	1.75	1.75	1.62½	1.50	1.50	1.50
CEMENT FINISHERS.....	1.75	1.75	1.75	1.75	1.75	1.75	1.75	1.75	1.75
ELECTRICIANS.....	1.87½	1.87½	1.87½	1.70	1.87½	1.87½	1.75	1.82½	1.75
ENGINEERS: MATERIAL HOIST.....	1.60	1.60	1.60	1.60	1.60	1.60	1.60	1.60	1.60
PILE DRIVER.....	2.00	2.00	2.00	2.00	2.00	2.00	2.00	2.00	2.00
STRUCTURAL STEEL.....	2.00	2.00	2.00	2.00	2.00	2.00	2.00	2.00	2.00
GLASS WORKERS.....	1.58½	1.58½	1.58½	1.58½	1.58½	1.21	1.40	1.37½	1.37½
IRONWORKERS: ORNAMENTAL.....	1.85	1.85	1.85	1.85	1.85	1.85	1.85	1.85	1.85
REINF. RODMEN.....	1.75	1.75	1.75	1.75	1.75	1.75	1.75	1.75	1.75
STRUCTURAL.....	2.00	2.00	2.00	2.00	2.00	2.00	2.00	2.00	2.00
LABORERS: BUILDING & CONCRETE.....	1.25	1.25	1.15	1.15	1.15	1.15	1.25	1.25	1.15
LATHERS.....	1.90	1.90	1.60	1.87½	1.75	2.00	1.87½	1.60	1.87½
MARBLE SETTERS.....	1.75	1.75	1.75	1.75	1.75	1.75	1.75	1.75	1.75
MOSAIC & TERRAZZO.....	1.75	1.75	1.75	1.75	1.75	1.75	1.60	1.16	1.12½
PAINTERS.....	1.75	1.75	1.75	1.64	1.75	1.75	1.60	1.60	1.50
PILEDRIVERS.....	1.86	1.86	1.86	1.86	1.86	1.86	1.86	1.86	1.86
PLASTERERS.....	2.00	2.00	1.75	2.00	2.05	2.00	2.00	1.87½	1.87½
PLASTERERS' HODCARRIERS.....	1.75	1.75	1.75	1.75	1.75	1.75	1.65	1.65	1.40
PLUMBERS.....	1.87½	1.87½	1.87½	1.87½	1.87½	1.87½	1.87½	1.87½	1.87½
ROOFERS.....	1.50	1.62½	1.50	1.62½	1.25	1.37½	1.50	1.50	1.50
SHEET METAL WORKERS.....	1.75	1.75	1.75	1.75	1.75	1.75	1.75	1.75	1.75
SPRINKLER FITTERS.....	1.58	1.58	1.58	1.58	1.58	1.58	1.58	1.58	1.58
STEAMFITTERS.....	1.87½	1.87½	1.87½	1.87½	1.87½	1.87½	1.87½	1.87½	1.87½
STONESETTERS (MASONS).....	2.05	2.05	2.05	2.05	2.05	2.05	1.75	2.05	2.00
TILESETTERS.....	1.80	1.75	1.75	1.75	1.75	1.75	1.37½	1.37½	1.37½

Prepared and compiled by
CENTRAL CALIFORNIA CHAPTER, ASSOCIATED GENERAL CONTRACTORS OF AMERICA
with the assistance and cooperation of secretaries of General Contractors Associations and Builders Exchanges of Northern California.

CLASSIFIED ADVERTISING

RATE: 8c PER WORD . . . CASH WITH ORDER

MINIMUM \$1.50 (3 Lines)

ARCHITECT'S REPORTS—A valuable advance news service giving building and construction information daily on projects in Northern California. Name, location, architect, proposed cost, etc., on individual slips. Ideal for securing new business leads. Hundreds of items, total monthly cost only \$10. Don't delay, subscribe today. ARCHITECT & ENGINEER, Room 618, 68 Post Street, San Francisco, California. Phone DOuglas 8311.

ARCHITECTS—A. McF. McSweeney, Architect, Room 927 Hearst Bldg., San Francisco. New offices. Desires catalogs.

PHOTOGRAPHY—Keep a pictorial record of your building, or construction project. Pictures are of tremendous value to contractors, builders, engineers, architects. For Industrial-Publicity-Aerial photography, see

FRED MAE, Room 721-22 Hearst Bldg., San Francisco 3, California.

WANTED—Architectural designer capable of taking charge of office, general practice. Excellent opportunity. Telephone Higate 6449, Oakland, California.

HELP WANTED—Male, engineer, licensed or unlicensed structural experience. Buttruss and McClellan Inc., 1013 East Eighth St., Los Angeles 21, Calif. Telephone TRinity 7347.

IN THE NEWS

SIMPLIFIED PRACTICE ASPHALT TILE

A proposed Simplified Practice Recommendation for Asphalt Tile is available to all interests for their consideration, comment and approval, according to the National Bureau of Standards, Washington, D. C.

The recommendations would establish simplified lists of sizes and colors of asphalt tile and cover

HOGAN LUMBER CO.

Wholesale and Retail

LUMBER

MILL WORK • SASH & DOORS

Office, Mill, Yard and Docks

SECOND AND ALICE STREETS • OAKLAND, CALIF.

Telephone *Glencourt 6861*

CLINTON CONSTRUCTION CO. OF CALIFORNIA

General Contractors

923 FOLSOM STREET • SAN FRANCISCO

SUtter 3440

SANTA MARIA INN SANTA MARIA, CALIFORNIA

FRANK J. McCOY, General Manager

FERNAND E. PIMENTEL, Manager

On the
Coast
Highway
between
San
Francisco
and
Los
Angeles



American
or
European
Plan
•
Old
English
Tap
Room

base which would be adequate for all ordinary use.

MARGARET FRITSCH, Architect, of Portland, Oregon, has moved into new offices at 500 Concord Building.

BLUEPRINT CLEANING

A new method of cleaning blueprint duplicating machine rolls by means of power brushing, to eliminate crystalline substances that form on them, has been announced by the Osborn Manufacturing Company, power brush manufacturers of Cleveland, Ohio.

A wheel brush equipped with .005-inch wire, mounted on a flexible shaft is used, or if the coating is heavy a .0095-inch wire can be used for the initial cleaning.

ERNEST J. KUMP, Architect, San Francisco, recently addressed the Southwestern School Plant Conference at Austin, Texas.

APPOINTED SALES MANAGER

Elmer J. Graebner has been named Sales Manager of the Cellufoam Products division, a position formerly held by John Bluhm who has been appointed General Manager of the plant.

Thorn C. Hulbert has been appointed Eastern Division sales manager with offices in New York City; Thomas G. Gaskin has been named Central Division sales manager, and Charles H. Smith has been named Pacific Coast Division sales manager.

JAMES W. CAREY, Construction Engineer, Seattle, Washington, has moved into new and enlarged offices at 1917 First Street.

LOUIS N. CRAWFORD, NOTED SANTA MARIA ARCHITECT, DIES

Louis N. Crawford, prominent California architect, died in a Santa Maria hospital early in July following a prolonged illness.

Among his outstanding work was the Santa Maria City Hall, Knights of Pythias building and school buildings at Orcott, El Camino, Fairlawn, Goleta, Vista Del Mar, San Luis Obispo high, and junior high schools.

He was a member of the firm of Crawford and Daniel, Architects, of Santa Maria.

W. S. CHINN, Architect, has moved into new offices at 503 Temple Place, Seattle 22, Washington.

BOOK REVIEWS

CASEMENT WINDOW OPERATORS. H. S. Getty Co., Inc., Philadelphia, Pa.

Have issued a new Catalog on Casement Window Operators and accessory hardware, covering entire line of internal and external operators for both metal and wood casement sash. Contains drawings, available finishes, and dimensions for easy reference.

CRANE PLUMBING & HEATING, For Low Cost Homes. Crane Company, Chicago, Illinois.

A new consumer booklet of 20 pages presenting to architect and contractor articles for use under the government's low-cost housing program. Contains photographs, descriptions and specifications for all Crane plumbing and heating equipment now in production.

THE ANSWER BOOK ON HOME HEATING: Air Conditioning Department, General Electric Co., Bloomfield, N. J.

Presents question of home heating and air conditioning in 28-page catalog format brochure. Many illustrations, diagrams, and written in understandable language.

HEATING THE MODERN HOME ELECTRICALLY: Electromode Corp'n, Rochester 2, New York.

New 20-page brochure No. 46-D discusses trend towards electrical home heating. Contains illustrations and complete specifications for Portable Heaters and Down-Flo Bilt-in-Wall Heaters. Of interest to electrical contractors, dealers, and power companies. Describes Electromode heating element which does away with fire, shock, or explosion hazards.

A ROMANCE OF STEEL IN CALIFORNIA

The Judson Pacific-Murphy Corporation of San Francisco and Oakland have just released to a select list of libraries their historical book entitled, "A Romance of Steel in California."

Starting with the founding of the Pacific Rolling Mill Company in San Francisco in 1886, the book follows the development of the iron and steel industry on the Pacific Coast up to the present time and then takes a look into the future of steel fabrication on the Pacific Coast.

Line drawings, illustrations, and reproductions from old newspapers and documents add considerably to the interest of the book, as well as making it valuable for reference purposes.

VERMONT MARBLE COMPANY

Producers and Finishers
of

Domestic and Imported Marbles

Write for new pamphlet describing our
Marble Toilets and Showers

San Francisco and Los Angeles

San Francisco phone: SUTter 6747



The Most Complete Line of
STEELS and BUILDING MATERIALS
Made by a Single Producer



See Sweet's Catalog File or write us for
full information.

REPUBLIC STEEL CORPORATION
GENERAL OFFICES: CLEVELAND, OHIO

DENVER, COLORADO CONTINENTAL OIL BUILDING
LOS ANGELES, CALIFORNIA EDISON BUILDING
SALT LAKE CITY, UTAH WALKER BANK BUILDING
SAN FRANCISCO, CALIFORNIA RIALTO BUILDING
SEATTLE, WASH. WHITE-HENRY-STUART BUILDING

PACIFIC MANUFACTURING CO.

HIGH CLASS INTERIOR FINISH
QUALITY MILLWORK

142 SANSOME ST., SAN FRANCISCO
Garfield 7755

6820 MCKINLEY AVE., LOS ANGELES
THornwall 4196

BUILDERS EXCHANGE, OAKLAND

"AMERICAN - MARSH" CONDENSATION UNIT

Pumping
Machinery
for
Every
Purpose

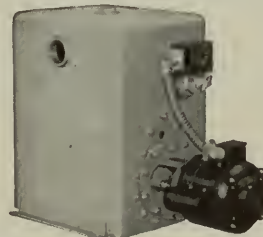

For Service
Call
DOuglas
6794
or
MUtual8322

SIMONDS MACHINERY CO.
SAN FRANCISCO 816 FOLSOM
LOS ANGELES 455 EAST 4TH

Real Estate Loans



F H A loans are readily available on existing homes up to 80% of the appraised value. You can buy a home and pay for it in small monthly installments like rent. For example, a 20-year loan of \$6000 would cost about \$49.56 per month, including taxes, insurance, principal and interest.

*Come in and talk with us
We can help you get the home
you want*

CROCKER FIRST NATIONAL BANK
OF SAN FRANCISCO
California's Oldest National Bank
ONE MONTGOMERY STREET
Member Federal Deposit Insurance Corporation

Venetian Blinds

of

Metal or Wood

for

Homes and Offices

Installed and Serviced

by

GUNN CARLE & CO.

20 POTRERO AVENUE
SAN FRANCISCO 3
UNDERHILL 5480

IN THE NEWS

PORTLAND CEMENT OFFICE

Opening of a district office in Denver, Colorado, by the Portland Cement Association has been announced. The office will be in charge of E. W. Thorson, as district engineer, and will serve as headquarters for the Association activities in Colorado and Wyoming.

Thorson holds a civil engineer degree from Iowa College, is a member of the American Concrete Institute, and an associate member of the American Society of Civil Engineers.

Completion of 26 new factories and 29 expansions of existing plants will bring 3,066 new jobs to Los Angeles county. New unit costs \$11,025,000 and expansions \$2,372,000.

CIVIC CENTER

Richmond, California, has voted \$3,850,000 in bonds for financing the construction of a civic center comprising a new city hall, library, auditorium, and hall of justice.

DRY CHEMICAL EXTINGUISHER

This new "ALL-OUT" dry chemical fire extinguisher is designed to combine high efficiency under most conditions with maximum protection to the user and to equipment installations.



Ejected under pressure, in a flat stream, that separates the flame from the burning material, a dense, fire smothering cloud is formed over a flaming area up to a distance of 18 feet.

It forms no toxic gases, is a non-conductor of electricity, harmless to finished surfaces and is easily carried. Manufactured by the ALL-OUT Fire Extinguisher Division of PRESSURELUBE, New York.

ELMER F. STEIGELMAN

CIVIL ENGINEER

**Structures of Steel, Wood
and Reinforced Concrete**

**Special Attention to
Architects' Requirements**

690 Market Street
San Francisco, California
GARfield 0588

KYLE FORREST

Civil Engineer

Water Supply — Sanitation

Municipal — Private
Consultations — Investigations
Reports — Designs — Valuations
Supervision — Litigation

Ground Water Work a Specialty

Hydrologic studies — wells, de-watering, underdrainage, foundations, conservation, testimony.

1504 Russ Building
San Francisco 4
YUkon 0652

Scott Company

HEATING . . PLUMBING . . TILE



243 MINNA STREET
SAN FRANCISCO
Phone EXbrook 6741

MULLEN MFG. COMPANY

BANK, STORE AND OFFICE
FIXTURES—CABINET WORK
OF GUARANTEED QUALITY
CHURCH SEATING

Office and Factory:
60-80 RAUSCH ST., Bet. 7th and 8th Sts.
San Francisco
Telephone UNDERhill 5815

IN THE NEWS

MAGNETIC OBSERVATORY

A new magnetic and seismological observatory will be placed in operation near Fairbanks, Alaska, next year by the U. S. Coast and Geodetic Survey, Department of Commerce.

COLUMBIA STEEL

Construction of Columbia Steel Company's new \$25,000,000 cold reduction steel sheet and tinplate mill at Pittsburg, California is proceeding on schedule, according to William A. Ross, president.

Preliminary grading has been completed and pouring of concrete foundations has started.

CANDLE POWER CLARIFIED

Technicians estimate that the amount of light used by the average family each month is equivalent to the rays of 1,000 pounds of candles.

LOS ANGELES PLANS

Los Angeles is adding four new buildings to its civic center; State office building, county administrative building, central police station, and administrative building for the bureau of power and light.

GREASE INTERCEPTER

Among the new products being offered is the Wade Hydra-Filter Grease Interceptor.

It embodies many improvements, simplicity of operation and maintenance.

Neurosis may be as contagious as smallpox, and should be avoided as assiduously, says a University of California psychiatrist.

DINWIDDIE CONSTRUCTION COMPANY

•
BUILDERS
•

CROCKER BUILDING
SAN FRANCISCO

THE TORMEY COMPANY

GENERAL PAINTERS
AND DECORATORS

Phone UNDERhill 1913

563 FULTON STREET
San Francisco



HERRICK IRON WORKS

STRUCTURAL STEEL
REINFORCING STEEL

18TH AND CAMPBELL STS.
OAKLAND, CALIF.
Phone GLencourt 1767

G. P. W.

JENSEN & SON

Building Construction

320 Market Street, San Francisco
Phone: GARfield 2444

JOHN CASSARETTO COMPANY

—Since 1886—And Still Active—

Building Materials

READY MIX CONCRETE
ROCK - SAND - GRAVEL - LIME
CEMENT - PLASTER - MORTAR
METAL LATH - WOOD LATH
STUCCO - WIRE NETTING

Service Unexcelled

Bunkers
Sixth and Channel, San Francisco
Phones: GARfield 3758 - 3760

ANDERSON & RINGROSE

General Contractors

320 Market Street, San Francisco
Phone GARfield 2245

**PITTSBURGH
TESTING LABORATORY**

Successors to
SMITH, EMERY & COMPANY

*Testing and Inspecting
Engineers and Chemists*

Structural Materials, Structures
Equipment, Pipe, Soils.

651 Howard St., San Francisco 5
EXbrook 1747

A. F. MATTOCK CO.

Builders



212 CLARA STREET
SAN FRANCISCO

**INDEPENDENT
IRON WORKS**

Steel Buildings
Service Stations
Steel Storage Tanks
Fabricated Plate Work
Steel & Sheet Metal Products
Fabricated Structural Steel
Steel Distributors

Eighth & Pine Sts. Oakland, 7

George F. Brayer

ELECTRICAL
CONTRACTOR

166 Seventh Street
San Francisco

Phone: Market 1761

Index to Advertisers

ALADDIN Heating Corp.....	48
ANDERSON & Ringrose.....	47
ANGIER Sales Corporation.....	*
ARCHITECTS Reports.....	40
ARCHITECT & ENGINEER.....	5
BASALT Rock Company.....	39
BAXTER & Company, J. H.....	34
BRAYER, Geo. F.....	48
CASSERETTO, John.....	47
CLARK, N., & Son.....	*
CLASSIFIED Advertising.....	43
CLINTON Construction Company.....	44
COLUMBIA Steel Co.....	*
COLOTYLE Corporation.....	*
CROCKER First National Bank.....	46
DINWIDDIE Construction Company..	47
FORDERER Cornice Works.....	39
FORREST, Kyle.....	46
FULLER, W. P., Co.....	1
GUNN, Carle & Company.....	46
HANKS, Inc., Abbot A.....	48
HAWS Drinking Faucet Company.....	Back Cover
HERRICK Iron Works.....	47
HOGAN Lumber Company.....	44
HUNT, Robert W., Company.....	48
HUNTER, Thos. B.....	47
IMPERIAL Brass Manufacturing Co.....	*
INDEPENDENT Iron Works.....	48
JENSEN & Son, G. P. W.....	47
JOHNSON Company, S. T.....	*
JUDSON, Pacific-Murphy Corp.....	39
KRAFTILE Company.....	5
KAWNEER Company.....	*
MATTOCK, A. F.....	48
MULLEN Mfg. Co.....	47
MUELLER Brass Co.....	*
NORTHERN California Electrical Bureau.....	35
OWENS Corning Fiberglas Co.....	*
PACIFIC Coast Gas Association.....	*
PACIFIC Manufacturing Company....	45
PACIFIC Portland Cement Company	1
PACIFIC Telephone & Telegraph Co.	33
PARAMOUNT Built-in Fixture Co.....	*
PARKER, Steffins & Pearce.....	*
PAYNE Furnace & Supply Co., Inc.....	*
PITTSBURGH Testing Laboratory.....	48
PORTLAND Cement Association.....	*
REMILLARD-Dandini Co.....	48
REPUBLIC Steel Corporation.....	45
SANTA Maria Inn.....	44
SCOTT Co.....	46
SIMONDS Machinery Company.....	45
SISALKRAFT Company.....	39
SMOOT-Holman Co.....	37
STANLEY Works, The.....	*
STEIGELMAN, Elmer F.....	46
SOULE Steel Co.....	*
TAYLOR Co., Halsey W.....	32
TIMBER Engineering Co., Inc.....	*
TORMEY Company, The.....	47
UTILITY Appliance Corp.....	*
U. S. STEEL.....	*
U. S. BONDS.....	Inside Back Cover
VERMONT Marble Company.....	45
WESIX Electric Heater Co.....	*
WESTERN Asbestos Company.....	Inside Front Cover
WOOD, E. K., Lumber Company.....	36

* Indicates Alternate Months

**ABBOT A. HANKS, INC.
Engineers & Chemists**

INSPECTING — TESTING — CONSULTING
CONCRETE • STEEL • MATERIALS
CHEMICAL AND TESTING
LABORATORIES
• RESEARCH AND INVESTIGATION •

TESTS OF STRUCTURAL MATERIALS
DESIGN OF CONCRETE MIXES
SHOP AND ERECTION INSPECTION OF
STRUCTURES AND EQUIPMENT
INVESTIGATION OF STRUCTURES
AND MATERIALS
TESTS AND INVESTIGATION OF
FOUNDATION SOILS
FIRE RESISTANCE AND INSULATION
TESTS

624 Sacramento Street, San Francisco

**Robert W. Hunt Company
ENGINEERS**

Inspection • Tests • Consultation
Schools and Other Structures
Are Built as Designed

*When Construction Materials are
Inspected at point of Manufacture
and during Erection by*

ROBERT W. HUNT COMPANY

*Cement, Concrete, Chemical, Metallurgical,
X-Ray and Physical Laboratories*

Chicago • New York • Pittsburgh
Los Angeles • All Large Cities
San Francisco, 251 Kearny Street

REMILLARD-DANDINI Co.

Brick and
Masonry Products



633 BRYANT ST., SAN FRANCISCO
569 THIRD ST., OAKLAND

**A L A D D I N
Heating Corp.**

Specializing in
QUALITY HEATING
EQUIPMENT

2222 San Pablo Avenue
OAKLAND
TWinoaks 1022

ARCHITECT AND ENGINEER



SEPTEMBER

1946

Teamed up

TO OFFER MORE ON ANY INSULATION JOB!



JOHNS-MANVILLE... through continual research since 1858 have developed a complete line of insulating materials of highest efficiency to meet all types of heated or refrigerated equipment

WESTERN ASBESTOS... for over 18 years associated with Johns-Manville, offer the vast practical experience gained in thousands of insulation installations of every conceivable type.



HERE IS A GREAT insulation-team with the combined experience of over 120 years. It is a team who through the development of new and improved materials, engineering skill and extensive field experience, and craftsmanship in application, have established themselves as the leading choice in the insulation field. If you have an insulation problem, Western Asbestos Co. is ready to offer you immediate service.

Contractors and Distributors for Johns-Manville Corporation

WESTERN ASBESTOS CO.

DISTRIBUTORS • ENGINEERS • CONTRACTORS

MAIN OFFICE: 675 TOWNSEND STREET, SAN FRANCISCO 3 • BRANCH OFFICES: OAKLAND AND SACRAMENTO

ARCHITECT

Vol. 166 No. 3

AND ENGINEER

ARCHITECTS' REPORTS—Published Daily
Telephone DOuglas 8311

WILDER
Editor

MARK DANIELS, A.I.A.
Associate Editor

JOHN S. BOLLES, A.I.A.
Book Reviews

MICHAEL GOODMAN
Post-War Planning

L. H. NISHKIAN
Consulting Editor

E. N. KIERULFF*
Ass't Editor
*In the Service



Contents for

SEPTEMBER

COVER: Looking towards the living room from the main garden illustrates the richness that can be obtained through the use of a great variety of plant forms properly organized. THE FISK GARDEN, Frances E. Lloyd, Architect; Garrett Eckbo, Landscape Architect. (See Article page 11.)

ARTICLES AND MISCELLANEOUS TEXT

EDITORIAL NOTES	4
NEWS AND COMMENT ON ART	7, 8, 9, 10
LANDSCAPE ARCHITECTURE, A Professional Adventure	11
in Use of Outdoor Space	
(GARRETT ECKBO, ROBERT ROYSTON, EDWARD A. WILLIAMS)	
OREGON'S BOOM REGION, Has Novel Ten-Year Pay-As-You-Go-Plan	24
By ARTHUR W. PRIAULX	
RADAR, Chapter I (To Be Completed Next Month)	28
A. I. A. ACTIVITIES	31
WITH THE ENGINEERS	32
IN THE NEWS	34, 37, 44, 46, 47
HEADLINE NEWS & VIEWS	36
By E. H. W.	
PRODUCER'S COUNCIL PAGE	38
Edited by CHAS. W. KRAFT	
ESTIMATOR'S GUIDE	41, 42
BUILDING TRADES WAGE SCALE	43
NORTHERN AND CENTRAL CALIFORNIA	
CLASSIFIED ADVERTISING	43
BOOK REVIEWS, Pamphlets and Catalogues	45
INDEX TO ADVERTISERS	48

ARCHITECT AND ENGINEER (Established 1905) is published on the 15th of the month by the Architect and Engineer, Inc., 68 Post St., San Francisco 4; Telephone EXbrook 4-1111. President, K. P. Kierulff; Vice-President and Manager, L. B. Penhorwood; Editor, E. N. Kierulff.

Los Angeles Office: Wentworth F. Green, 6605 Hollywood Blvd., Los Angeles 28, Telephone HEMpstead 3171.

Second class matter, November 2, 1905, at the Post Office in San Francisco, California, under the Act of March 3, 1879. Subscriptions United States and Panama, \$3.00 a year; \$5.00 two years; foreign countries \$5.00 a year; single copy 50c. ARCHITECTS' REPORTS are published daily from this office, Vernon S. Yallop, Manager.



PURELY AMERICAN

We have come to the sad realization that great as the fame of "Kilroy," popular phantom character of World War II was, there is another character in America whose popularity puts that of "Kilroy" to shame.

Few casual conversations, little official business, and no idle chatter is engaged in without the aid of, and reference to, this currently great American, popularly known and referred to as "THEY."

"THEY" are the people who have the greatest influence on your life; "THEY" are the people who permit you to do this or that; "THEY" are the people who won't let you do this, and place restrictions on you so that it is impossible for you to do any of the many things desired; "THEY" set the rules and regulations by which you live.

Unlike "Kilroy" who gained his fame because he "WAS here," "THEY" are with us all the time.

* * *

CHICAGO . . . AVERAGE CITY

A rapidly developing national program of "Community Planning" is encompassing the foresighted thinking of civic leaders throughout the rural areas with the multi-complexities of metropolitan cities.

There is obviously unfolding at the present time a national plan of "Planning" which dovetails one area with another, one city with another, and one State with another, until a basic over-all Master Plan for the Nation is easily recognized.

Of major consideration in any Master Plan is shifting of population and disposition of existing structures. Neither can be ignored.

Transportation, parking of vehicles, business districts, parks and landscaping, industrial sites, educational and religious facilities, homesites, are all a vital part of the Planning pattern.

Chicago's population in 1930 was 3,376,438, ten years later it was 3,396,808, an increase of 20,370. Since there was a gain of 30,000 in negro population, there must have been a loss of 10,000 white population. In 1940 there were 42,123 fewer children under five years of age than in 1930, and in 1940 there were 98,621 more persons 60 years and over than in 1930.

Fifty per cent of the homes occupied in Chicago were built before 1895, and the average monthly rental of these homes in 1940 was \$24.99.

These ratios are approximate in national application.

The dislocation of thousands of individuals and families during and as a part of "the War," will have a tremendous influence on any "Plan," and many industrialists, already recognizing the advantages of cheap land, fresh air, and family op-

portunities for workers, are turning their "Planning" to non-concentrated industrial areas.

It is very evident that "Community Planning" must be done by those who have vision, BUT, are not visionary.

* * *

POLITICAL WOODSHEDS

We have been anticipating the announcement of a new and extensive governmental construction project designed to erect innumerable "woodsheds" in localities representing the centers of our national political life.

These particular "woodsheds," irrespective of any architectural thought, would be patterned in principle, at least, after the "woodsheds" of our boyhood recollection, which, if memory serves us right were solely designed as a suitable place for escorting us for a good pants warming.

Our general observation of "things" is that there are going to be a lot of political pants warmed this Fall, and we question whether the heating process will emanate from radiation of the comforts of nicely padded swivel chairs.

* * *

THE DRAMA OF ARCHITECTURE

Turpin C. Bannister, A. I. A., and Dean of the School of Architecture and Arts, Alabama Polytechnic Institute, writing in the book "Architecture—A Profession and a Career" which was published by The American Institute of Architects, has the following to say about "The Drama of Architecture":

"Men are construction animals. There is scarcely a human activity that does not presuppose a building. The lowliest denizen of Jungletown knocks together his packing-box hovel; the robber has his lair; the artisan, his shop; the chieftain, his council house; and the rudest hamlet its shrine. We ourselves today contribute more than a third of all our productive effort for buildings—for dwellings, stores, factories, warehouses, schools, institutions, theaters, churches, tombs, and the multitude of necessary structures that shelter ourselves and our possessions. In terms of employment and expenditure that section of American industry which fabricates buildings is exceeded only by agriculture and by transportation."

After pointing to numerous examples of outstanding architectural accomplishment, Dean Bannister closes his article with the question, "Will our successors be enriched and inspired by our own architectural legacies?"

To Architects belongs a special opportunity, because, as we can see about us daily, the art of architecture is the art of living.



**WE START THE FINISH RIGHT....
TO MAKE IT END THE WAY IT'S WANTED**



smooth as a baby's cheek—
and baked on to stay!"

That's the way the Plant Superintendent likes to see fluorescent fixtures line off the line. His sensitive fingers and critical eye tell him his production figures are "right on the line, friend; your stuff is KO."

PRODUCTION FINISHES

Many leading Western wood and metal finishers specify Fuller for production profit, buyer appeal, buyer satisfaction.

There are many ways to bake a finish on metal. Whether the curing schedule requires five minutes or an hour, by gas or electric oven or by infra-red tunnel (illustrated), Fuller formulates a finish to fit.

Our synthetics, we are told, give better covering, better "mileage," higher gloss, more durable wear.

Such properties, important to water heaters, fixtures, refrigerators, air con-

ditioning units, stoves and such, indicate the Fuller laboratory technique—look beyond the production line to a useful life for every Fuller-finished product.

In the general paint application field, too, Fuller always formulates in terms of final service, because *use* is the final proof of quality.

Whatever your surface protection or beautifying problem, we believe we can solve it. We've solved some tough ones. We're still on our mettle! W. P. Fuller & Co. Factories: San Francisco, Los Angeles, Portland. Branches, warehouses in principal Western cities.

FULLER
Industrial **FINISHES**



MAINTENANCE FINISHES

Protection for equipment, plant machinery, buildings, offices, plus "Color Engineering"—Fuller products fit, suit, serve and save.

AIRCRAFT FINISHES

Millions of war flight-hours proved Fuller Aircraft Finish quality. Now available for private planes. See your Airport Refinisher.

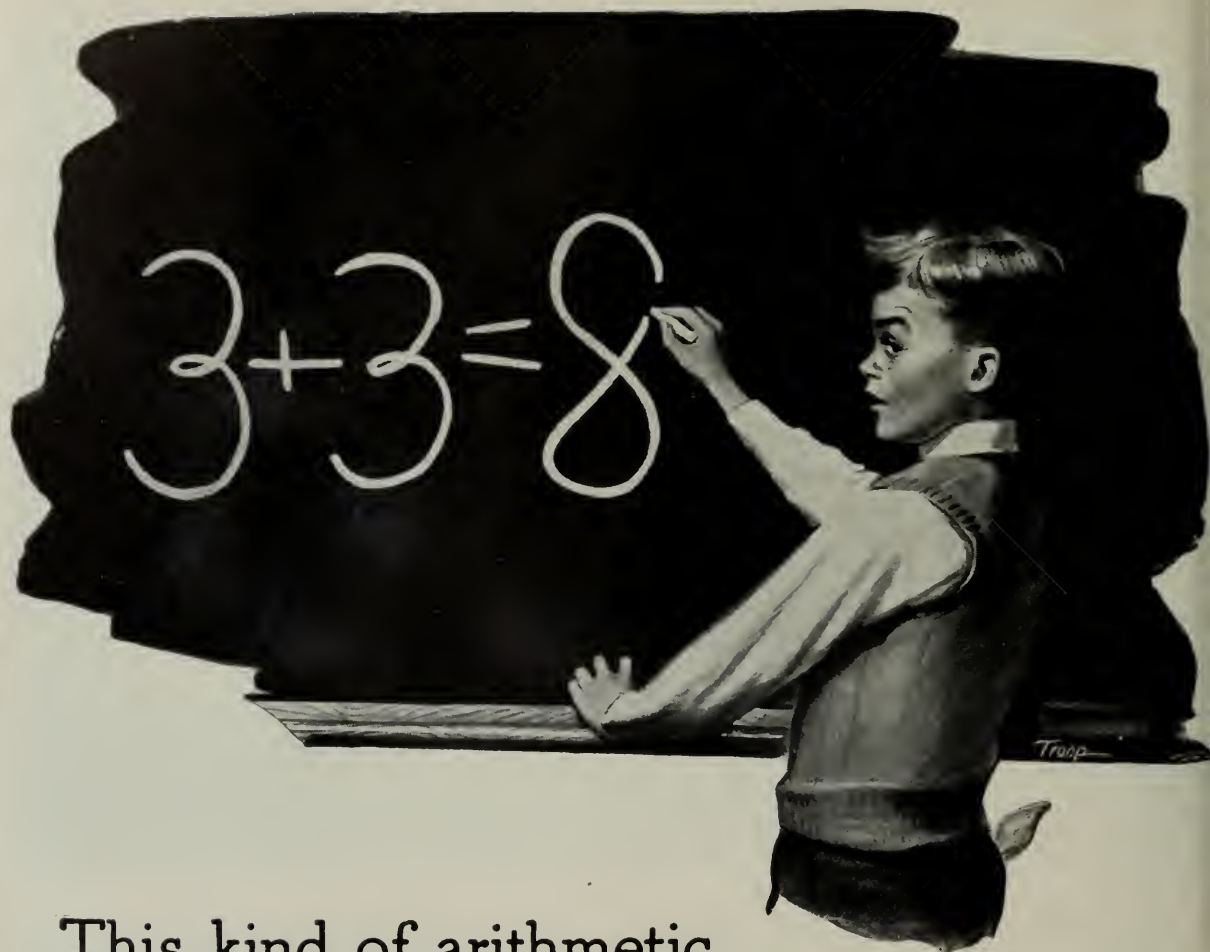

This kind of arithmetic may put Johnny through college

Here's how it works out:

**\$3 put into U. S. Savings Bonds today will
bring back \$4 in 10 years.**

Another \$3 will bring back another \$4.

So it's quite right to figure that 3 plus 3 equals
8 . . . or 30 plus 30 equals 80 . . . or 300 plus
300 equals 800!

It will . . . in U. S. Savings Bonds. And those

bonds may very well be the means of helping
you educate your children as you'd like to have
them educated.

So keep on buying Savings Bonds—available
at banks and post offices. Or the way that mil-
lions have found easiest and surest—through
Payroll Savings. Hold on to all you've bought.

You'll be mighty glad you did . . . 10 years
from now!

SAVE THE EASY WAY... BUY YOUR BONDS THROUGH PAYROLL SAVINGS

*Contributed by this magazine in cooperation
with the Magazine Publishers of America as a public service*



NEWS AND COMMENT ON ART



TEHUANTEPEC PASS

Charcoal drawing by DIEGO RIVERA

The above TEHUANTEPEC PASS charcoal drawing by DIEGO RIVERA forms a part of the Bender Collection of the San Francisco Museum of Art.

Diego Rivera is included in the Exhibition of Latin-American Drawings which forms part of the September exhibition schedule. The San Francisco Museum of Art owns a large number of Rivera's original drawings, some of which are studies for murals. Diego Rivera was born in 1886 in Guanajuata, a rich mining district of Mexico, of mixed Spanish-Indian heritage.

Diego Rivera is well represented in the United States by murals in San Francisco and Detroit. Many of the best Mexican easel paintings and drawings are in American collections. The United States is responsible for much of the fame of Mexican painting. The patronage of our museums, collectors, critics and dealers have provided a solid basis for prestige.

Beginning his art studies at an early age in Mexico, Rivera then traveled extensively in Italy, Spain, France and the U. S. S. R.

His Mexican frescoes are in the Ministry of Education in Mexico City, in Chapingo and Cuernavaca. He was last in San Francisco in 1930 and 1931.



TEXTILES . . . Woven in ART-IN-ACTION Shop, City of Paris
Decorated Bowl (right) by KATHRYN UHL BALL
Plates by ANTHONY PRIETO

Textiles & Pottery

By **BEATRICE JUDD RYAN**

The American Craftsman, now the war is ended, must be ready to meet the challenge of production from abroad. He must make his place so secure through the high standard of his techniques and the creative quality of his works that the American buyer cannot again entertain the idea that all crafts of interest must come from Europe.

The acid test of household goods as with the individual is through daily contact with the creature, and in the household crafts, the standard of character is based on form, color, design, and texture—all qualities that when intimately seen and felt teach one to reject the vulgar. Therefore, the merchandising of original pieces of pottery, weaving, and metal work by fine craftsmen is, I believe, as much an educational contribution in its way as the

exhibits offered by museums, colleges, and schools. Indeed, there is a distinct need for someone to carry through to ownership if the taste of the public is to be stimulated and the department store, rather than the exclusive shop, has the advantage of wider contacts.

The old idea of giving the public what they want, meaning the inferior, has been found unsound. The buying public when exposed to the best demands the best. Of course, there will always be a group whose judgment is based on price, and unfortunately these more often than not have the funds to spend. However, I know from first hand knowledge that there is a large public innately sensitive to what is fine, some of whom have never consciously thought about art. These people, if given

the freedom of choice, purchase an original piece of hand craft rather than a more flamboyant objet d'art.

The American way of life is active and direct—not a background for objets d'art as such, but there is an increasing demand for the useful to be beautiful. As life has been stepped up it is stripped of the unessential and what remains grows in importance. With the trend decidedly away from the ornamental without function, our American craftsmen will have to turn their talents in that direction, and here in California where pottery has excelled, this is already being done as instanced in the work of many of our artist craftsmen as seen in the recent Fifth Annual Pacific Coast Ceramic Exhibition held in the Art-in-Action Shop of the City of Paris in San Francisco.

CALIFORNIA PALACE OF THE LEGION OF HONOR

Thomas Carr Howe, Jr., director, announces the following schedule of exhibitions and special events at the California Palace of the Legion of Honor during the month of September, 1946:

Exhibitions—

MEMORIAL EXHIBITION of the Paintings of Jules Pages, opening September 13; PAINTINGS by Peter Miller, opening September 13; PAINTINGS by Bert Pumphrey, opening September 13; MUSEUM AIDS IN THE PUBLIC SCHOOLS, opening September 19. An exhibition demonstrating what

the museum offers to schools, consisting of panels, exhibitions and all kinds of circulating material made up by the Educational Department of the Museum. It is offered to any public school teacher who feels that this kind of correlation can be used in her classes and has already been of great value to social science, history, language and art departments. Although the exhibition is planned especially for public school teachers, the panels will be of great interest to the general public.

The Alma de Bretteville Spreckels Collection of Sculpture by Auguste Rodin.

The Mildred Anna Williams Collection of Paintings, Sculpture, Tapestries and Furniture.

The Collis Potter Huntington Memorial Collection of 18th Century French Paintings, Sculpture, Tapestries, Furniture and Porcelain.

Special Programs—

Organ Recital by Uda Waldrop every Saturday and Sunday at 3 p. m. Organ concert broadcast at 3:30 p. m., Saturday (Station KSFO).

Educational Activities—

There will be no classes, either for adults or children, during the month of September.

On October 5 the Saturday Morning Children's Classes resume at their usual hour of 10:30 - 11:45. Also on the same date, the Saturday Afternoon Adult Classes in Painting resume and will be held from 2 p. m. to 4 p. m.

FREE MOTION PICTURES each Saturday at

(Continued on next Page)

POTTERY Exhibited in ART-IN-ACTION Shop

Pottery by LAURA ANDRESON (Deep bowl on right won Prize in Pacific Coast Ceramic Show, City of Paris.)



2:30 p. m. GREAT FILMS OF OUR TIMES, September 21, "The House Across the Bay" (George Raft, Joan Bennett and Walter Pidgeon); September 28, "The Lady Vanishes," an Alfred Hitchcock Production.

SAN FRANCISCO MUSEUM OF ART

The following schedule of Exhibitions and Museum activities have been announced for September:

Exhibitions—

PAINTINGS, by HAITIAN PRIMITIVES, Aug. 27 to Sept. 15; JEAN HELION, Paintings, Sept. 10 to Oct. 6; COLOR ETCHINGS AND PROOFS, by STANLEY WILLIAM HAYTER, Sept. 10 to Sept. 24; GEORGE HARRIS, Ten Years in Retrospect, Sept. 17 to Oct. 6; HANS HOFMANN, Paintings, Sept. 17 to Oct. 6; BAY REGION ART FOR MUSEUM MEMBERS, Sept. 18 to Oct. 6; LATIN AMERICAN DRAWINGS, Sept. 24 to Oct. 20.

Museum Activities—

THE WOMEN'S BOARD OF THE SAN FRANCISCO MUSEUM OF ART continues. MUSEUM THURSDAY GALLERY TALKS AND DISCUSSION, at 2:30 o'clock, followed by tea for members and their guests in the Members' Room. A series of MUSEUM THURSDAY EVENING LECTURES is planned, details to be announced.

WHAT PRICE FREEDOM FOR THE ARTIST, Lecture and Discussion Course, Series 4, by NORA LEE ROHR, Assistant Curator, Department of Education, Sept. 16 through Oct. 7 on Monday evenings at 8 o'clock.

STUDIO WORKSHOP AND SKETCH CLUB, Studio Meetings with competent guidance, conducted by GEORGE HARRIS, Wednesdays and Fridays at 7 to 9:30 p. m.

CHILDREN'S SATURDAY MORNING ART SESSIONS, Conducted by NORA LEE ROHR and assistants. For children, ages 6 to 15. Starting September 21, 10 to 11:30 a. m.

GALLERY TOURS, by members of the staff, Sundays at 3:30 p. m.

FILMS, "KNOW YOUR WORLD SERIES," Saturdays and Sundays at 2:30 p. m. FAMOUS FILM SERIES, Tuesday, September 3, at 8 p. m. ABSTRACT AND SURREALIST FILMS, Friday, September 27.

AESTHETICS OF PHOTOGRAPHY

The California School of Fine Arts is conducting an evening course for advanced amateurs and professional photographers who desire a new approach in contemporary techniques.

Flash techniques, sensitometry, and landscape subjects are being handled by Ansel Adams; portraiture is being handled by Imogene Cunning-

ham; and architectural photography is being covered by Alma Lavinson.

Minor White is teaching the history of photography and composition.

ROTUNDA GALLERY ART IN ACTION SHOP

Beatrice Judd Ryan, curator of the City of Paris Rotunda Gallery and director of the Art-In-Action Shop, announces the following activities for September:

Rotunda Galley: 4th Floor, City of Paris, San Francisco. Exhibition of Oils, Watercolors, Sculpture, and Decorative Screens, by Ruth Armer, Erle Loran, Jacques Schnier, and Emmy Lou Packard, from September 11 to October 5.

Art-In-Action Shop: 5th Floor. The Pacific Coast Textile Exhibition and Sale. Fifth annual Pacific Coast textile exhibition, exhibits selected and awards made by a jury from the work of textile artists from Portland, Oregon, to San Diego, California.

Textile exhibition from September 18 to October 31.

ARCHITECTURAL MODELS GIVEN UNIVERSITY OF CALIFORNIA

A unique collection of some 80 architectural models, given to the California Palace of the Legion of Honor in 1924 by Mrs. A. B. Spreckels and the late Mr. Spreckels, who purchased them from the French government, has been presented as a permanent loan to the University of California. Placed in the Architecture Building and in other suitable buildings these models will be used for research and teaching by the architecture department and sculpture classes.

Four large vans were needed to transport this valuable collection of plaster reproductions, chiefly of medieval and 18th century subjects. Included are details from such famous cathedrals as Versailles, Chartres, Rheims and Notre Dame. There are pedestals, friezes, figures, fountains, torchieres, panels, finials, capitals, lintels, fragments and other details. Pieces range in size from small pieces of sculpture to cathedral doors some 15 feet high.

REFRIGERATION EXPOSITION

New developments in equipment and design in air conditioning for homes, apartments, and buildings will be exhibited at the Fourth All-Industry Refrigeration and Air Conditioning Exposition scheduled for Cleveland, Ohio, October 29 to November 1.

It will be the first time a complete showing of air conditioning and refrigeration has been held since 1941.

Landscape Architecture

A PROFESSIONAL ADVENTURE IN USE OF OUTDOOR SPACE

Mutual friendship, similar professional views and aspirations combined to produce the comparatively new firm of landscape architects and planning consultants, Eckbo, Royston & Williams.

All three are graduates of the division of landscape design of the University of California. For years they have had such a mutual respect for each other's ideas and work that they decided some time ago upon eventual collaboration in their chosen profession as opposed to competition. The end of the war last fall made their association possible. Williams came out of the shipyard to join forces with Eckbo who had kept his own office open throughout the war. Then Royston came back from the Pacific to complete the team.

They now have active offices in San Francisco and Los Angeles. This raises the population of Paso Robles about once a month when the three get together at the halfway point to discuss their work and future activities. Eckbo is in charge of the Los Angeles office and Royston and Williams take care of the northern business of the firm. The Paso Robles get-together is necessary, they say, to continue and extend the original idea of their association which is based upon the premise that three minds are better than one if the best each one has to offer is brought to the fore. The way they put it is that their work as individuals will continually improve and the work they produce as a firm will therefore consistently reach a higher level of service for their clients if they criticize each other's work in a constructive way.

Their principle of work is: **Work**—They like their work and like to work. **Provide the best possible service**—They believe in thoroughness, attention to detail and recognize that quantity without quality is nothing. **Get recognition for good work**—They don't believe in hiding their light under a bushel. They feel very seriously that unless they produce the best quality work that they will not have a place in their profession.

A summary of their previous training and experience brings out the wide service they can give.

Eckbo, Royston & Williams feel that their theoretical ideas about landscape design are in tune with the best modern thinking in the fields of housing, planning and architecture. They don't look upon gardens, parks and playgrounds as things in themselves attached to houses or communities of houses. To them, the house and garden is inter-related living area, some of which is enclosed by walls and roofs, some of which is open. Since they don't design houses they believe in close collaboration with the architect at all stages of the development of the house so that the living spaces which include both indoor and outdoor spaces are properly arranged with respect to each other as well as wind, views and sun.

This design collaboration is carried on by architects, engineers and land planners in larger scale public or industrial work.

In the same key they think of parks and playgrounds as the outdoor living spaces of the community and therefore vital as such to the general health and welfare of its inhabitants. The extension of this idea is that the community should be designed around the outdoor living areas rather than around the streets, sewer lines, gas, water, and electric mains as is now the custom. They feel that the present method places the service elements in an over-emphasized position in the community planning picture, the logical outcome of which is the standard pattern of streets and lots with parks, playgrounds, shopping areas and schools placed by sheer necessity rather than in any logical relation to the community needs. Where their professional predecessor, Frederick Law Olmstead, helped win the battle for the large city parks in the last century, Eckbo, Royston & Williams hope to help win public acceptance of the greenbelt and the planned community as a 20th century necessity.

They don't look upon landscape design as exterior decoration but as organization of the outdoor space for the use of people.

(Continued on Page 23)

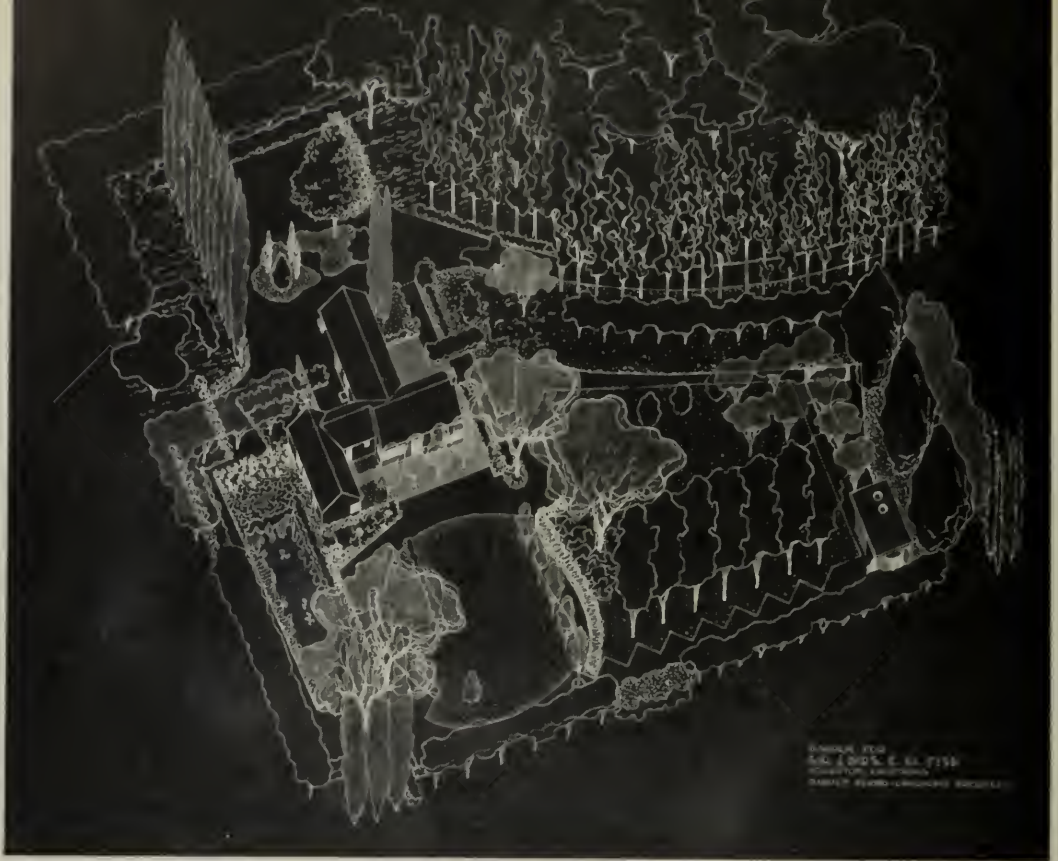

ISOMETRIC shows overall development of the Fisk Garden with organization of the garden spaces carried out by use of trees and shrubs of different structure and character. (Following photographs show details of the garden spaces indicating richness, variety and boldness of Eckbo's planting designs.)



(Imogen Cunningham, Photo)

GARRETT ECKBO

LANDSCAPE ARCHITECT

Garrett Eckbo has received more attention in the profession both here and abroad than any other contemporary. After completion of his training at the University of California he won a national scholarship competition which took him to Harvard for a Master's degree. It is interesting to note that Williams placed second in that competition which speaks well of their Berkeley training. Before returning to California, Eckbo did special research work in recreation planning for the United States Housing Authority, and worked with Norman Bel Geddes in the design of the Landscape treatment of the General Motors exhibit at the New York World's Fair. In association with Kastner and Berla, Architects, he designed the North Court of the Federal Building at the San Francisco Inter-

(Continued on Page 14)

The Fisk Garden

At right is shown the forecourt background of poplar trees with pepper trees faced with elaeagnus.

BELOW: Shows the development of the main garden area with paving and lawn shaded by oaks.



View at right shows the use of different plant forms in the forecourt—Irish yews, cryptomeria, and sycamore grouped in planting island.

Garrett Eckbo, Landscape Architect

Francis E. Lloyd, Architect



(M. Halberstadt, Photos)

GARRETT ECKBO—Landscape Architect

national Exposition. Returning to California he became Landscape Architect for the Farm Security Administration, then in the process of developing rural communities for the migrant farm workers throughout the West. Here in collaboration with the architectural and engineering staff members, Eckbo's bold conception of site planning and indoor-outdoor and service relationships keyed the designs. In private practice, Eckbo has re-

ceived wide recognition for his landscaping of housing projects and private homes, many of his works having been published both here and abroad. His fresh theoretical contributions to the field of garden design in the form of articles for both popular and professional magazines have had a profound affect on professional thinking in the fields of gardening and planning.



THE FARM WORKERS' COMMUNITY, Shafter, California: Comprises thirty one-family houses and two duplexes developed in 1941 adjacent to forty single family houses and a three hundred family migrant camp developed earlier. The illustration shows the lots used for subsistence farming, buildings, roads, the park and the community planting. This planting is broken down into large, medium and small trees and large and small shrubs. The park designed for a minimum budget is light and playful. Careful attention was paid to provide shade as well as open space for various types of recreation both active and passive for all age groups. The planting is freer and richer than the general clean pattern of rural open space organization.



Landscape Architect: GARRETT ECKBO

ROBERT E. ALEXANDER, Architect

A COMMUNITY CHURCH: Designed to serve residents of a present rental housing project and a contemplated home development on adjacent properties in Baldwin Hills, Los Angeles, California. Landscape planning and architectural design combined to meet the present and future requirements. Parking space provides one space for every four chapel seats. A spacious paved entrance serves as an outdoor lobby, while sloping down to the chapel floor, a ramp affords a feeling of intimacy with the garden and permits clear visibility for overflowing seating in the social hall at a higher level. The minister's study is near the platform and convenient to the street.

**ISOMETRIC of
Entrance to
Garden Court**

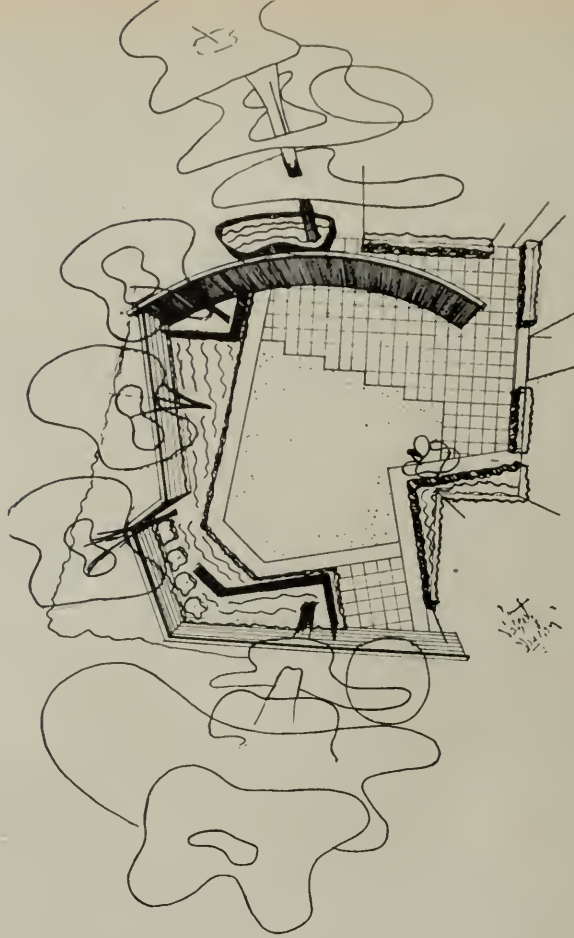

**Robert Platt
Oakland
California**



ROBERT ROYSTON

LANDSCAPE ARCHITECT

Almost three years of service in the United States Navy as a Lieutenant in charge of construction and repairs aboard ship only temporarily took Robert Royston's mind away from his profession. He saw action in the initial landings in the Aleutian, Tarawa, Kwajalein, Saipan, and Okinawa battles. These engagements took him through the entire north, central and southern Pacific areas and the best proof of his boundless enthusiasm and imagination are his sketches and models of house and garden projects done under shipboard conditions during wartime. After his graduation from the University of California he worked for Thomas D. Church, well-known San Francisco Landscape Architect. In this capacity he assisted in the design, site planning and construction of many gardens and housing projects. One of the largest of

(Continued on Page 18)



THE ABOVE illustration shows the court in its present state of completion; the lower forward wall is redwood bark with a finished redwood cap painted similar to the house exterior. Paving and planting intergration. This forward court, which utilizes space normally left open to the public, solves the problem of entrance access and privacy thus permitting maximum land use to the owner.

BELOW: Shows curved screen detail of split grape-stakes stained grey with light yellow cap reflecting colors used on interior of house.

IRWIN M. JOHNSON, Architect



ROBERT ROYSTON—Landscape Architect

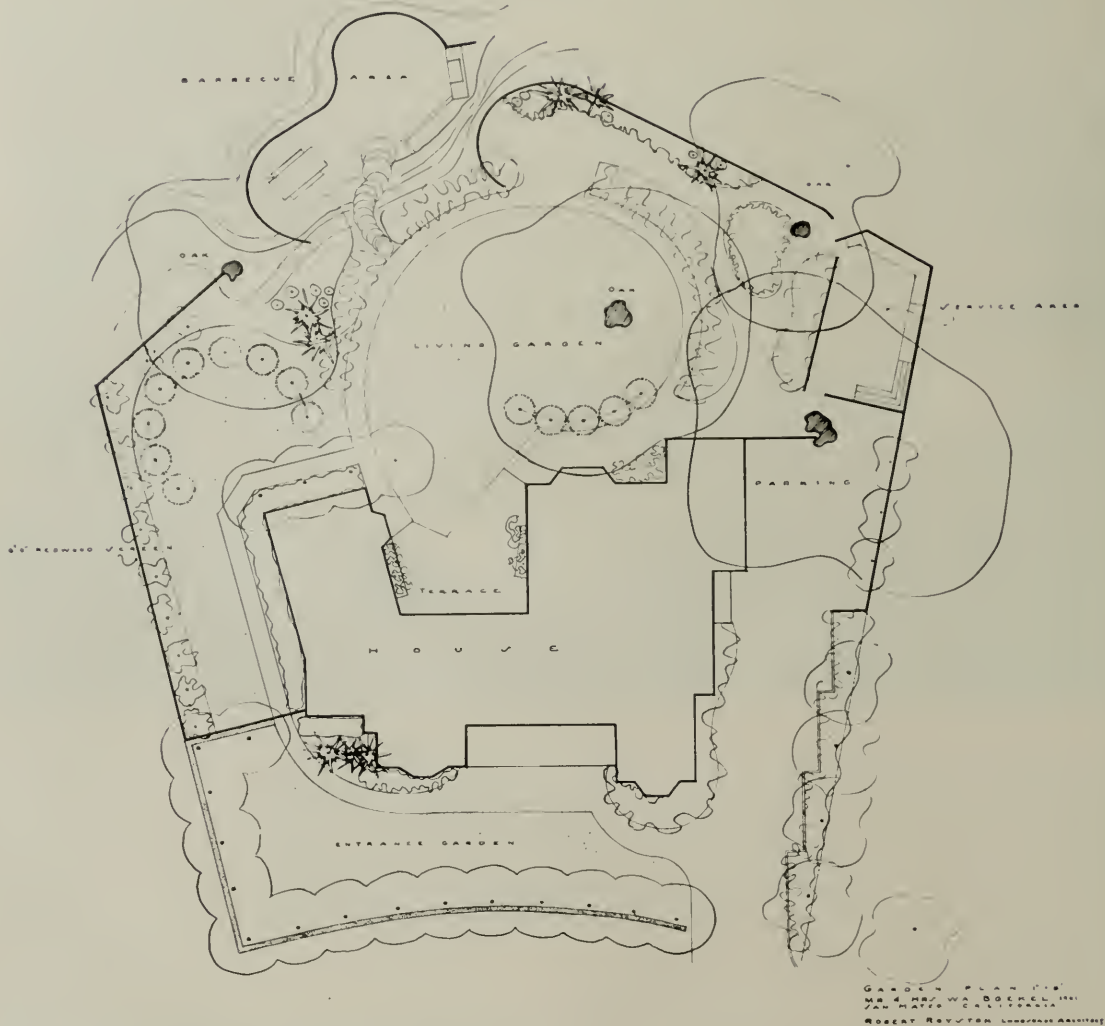

these was the Merced Housing Project of the Metropolitan Life Insurance Company. Royston's imaginative designs are without equal in the eyes of his associates. His work has the richness and vitality of a painting coupled with a sureness and practical quality that can only be gained from experience and continual testing in actual practice of one's theories.

← View towards House and Sun-Deck



The William Boekel Garden San Mateo

Garden plan shows the space organization; use of redwood screens and flowing ground forms define and relate space for outdoor living.



TOP VIEW: Spacious barbecue area with related physical and natural elements.

CENTER: Garden entrance, row of hawthornes and low brick wall define this area, presenting inviting space from house and street.

LOWER: Private sun and shade areas blended with garden screens and plant materials.



JOHN E. FENNACY
Architect

A Cooperative Community

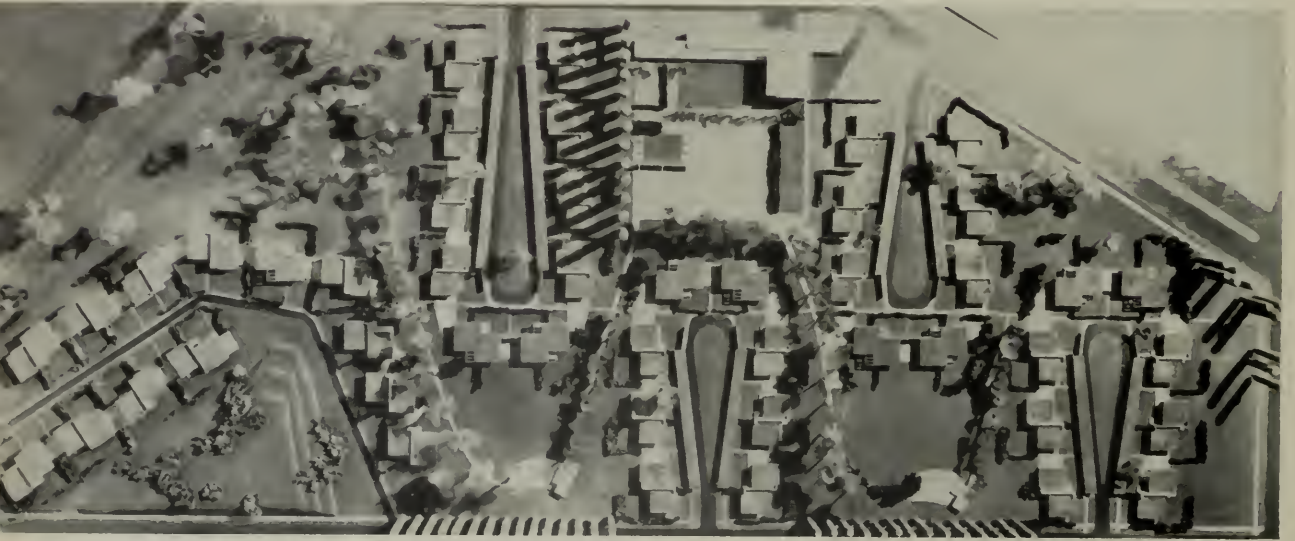

JOSEPH ALLEN STEIN, Architect

EDWARD WILLIAMS

Landscape Architect



Edward Williams has had a tremendously varied experience in the fields of gardening and planning. While working for the San Mateo County Recreation and Planning Commissions he designed parks, playgrounds and highway planting installations, as well as taking a part in the preparation of the Post War Program of Public Works the county is now embarked upon. This program has served as a model for other counties and communities. He has had particular experience in zoning, transit surveys, the various phases of master planning and general planning administration. His work in the field of private practice has been equally varied. After his graduation from the University of California he worked with E. L. Kiler, Landscape Architect of Palo Alto, on the development of the outdoor amphitheater and arboretum at Stanford

(Continued on Page 22)

COOPERATIVE COMMUNITY—Illustration Opposite Page

Joseph Allen Stein, San Francisco Architect, and Edward Williams collaborated in the development of "A Cooperative Community." Standardized housing unit in duplex form with masonry party walls was designed by Stein to show the many possibilities for fulfilling varied living patterns within a largely prefabricated house.

Significant things about the general community development are as follows: 1. Each house adjoins property owned and maintained by the community as a park: 2. A system of walks connects each house to the community center and to the three small playgrounds located in the larger park areas, providing limitless area for safe use of wheel toys by children: 3. A community center with nursery school, meeting hall and maintenance headquarters combined with a large outdoor play space: 4. Interspersed throughout the community are four small park areas, three of which include small developed play areas for children, complete with shelter, swings, slides and sand boxes: 5. Most houses are grouped around four cul de sacs which enter from the main thoroughfares bounding it and provide complete division between public access and private living areas: 6. A new departure is the use of long car shelters along the street front which create added privacy for the living areas.

ROSS GRAMMAR SCHOOL

The problem was to create a fitting entrance to the new school and the kindergarten playground visible in the illustration beyond the brick wall. The site was flat and poorly drained which necessitated the depression of part of it as a water collection point (see picture lower right) with catch basin connected to drain line underground. The earth taken from the depressed area was used to build up a low mound providing a contrasting elevation and added interest.

The planting is simple and subordinated to the existing trees which provide a natural feeling of area and space. The resulting arrangement has dignity, order, color and life—a proper school setting.

EDWARD WILLIAMS & GARRETT ECKBO, Landscape Architects

Carl F. Gromme, Architect



EDWARD WILLIAMS — Landscape Architect

University, parks, street tree and underpass developments for the City of Palo Alto and numerous private gardens and estates. Subsequent work in association with Butler Sturtevant, San Francisco Landscape Architect, included subdivision design, private gardens and estates and larger work at Principia College, University of Washington and Del Monte. In 1940 he carried on private practice

in San Francisco and in collaboration with Eckbo designed many private gardens. One of the best examples of their work in collaboration is the landscaping of the Ross Grammar School. His versatility is best witnessed by his war experience during which he rose from draftsman to head the mechanical engineering section at Western Pipe and Steel.

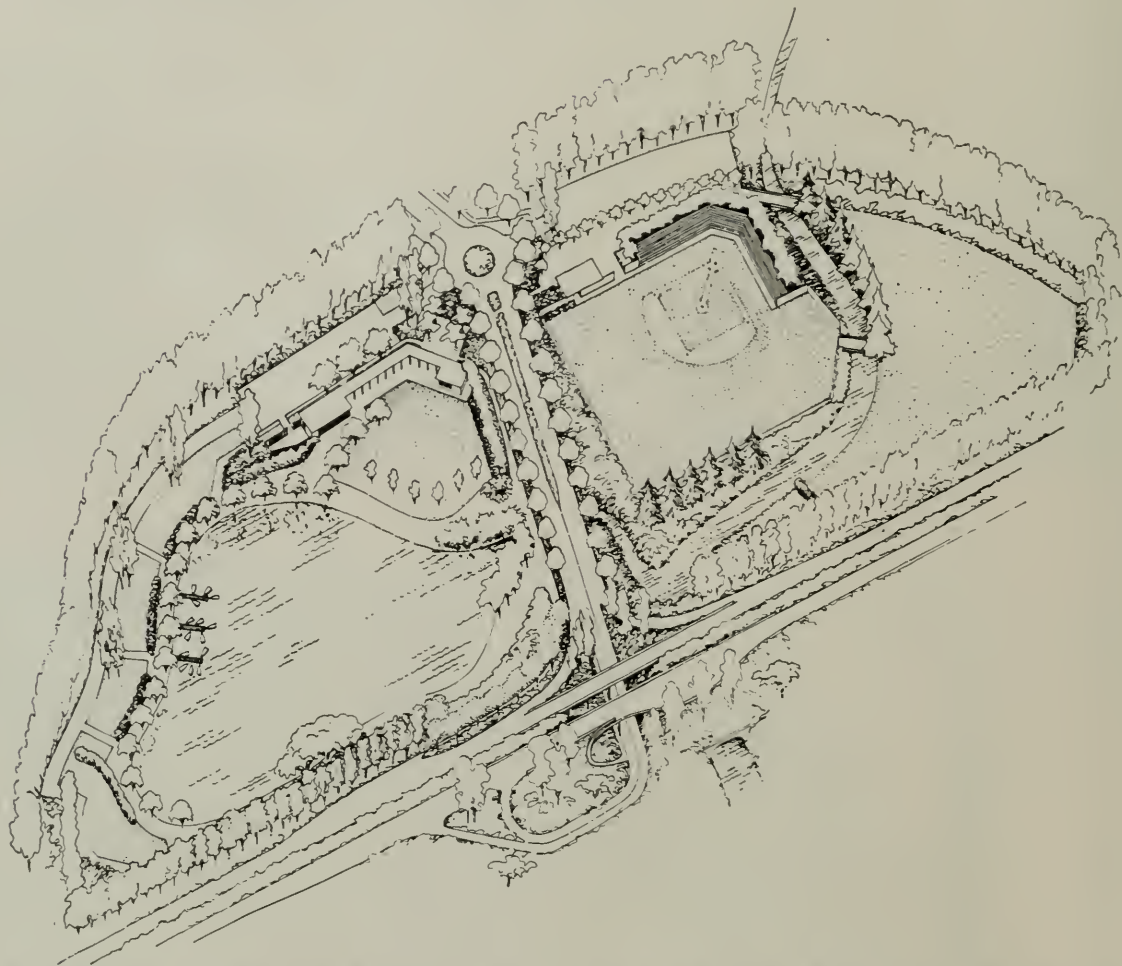

BRISBANE LAGOON PARK

Construction of the Brisbane Lagoon Park was held up by the war, but will in the future provide a sorely needed community center for the town of Brisbane just south of San Francisco on the San Francisco Bay.

The park area lies on both sides of the main access road to the town from the Bayshore highway, therefore provision of a grade separation structure is included in the plans.

The site was originally part of the bay cut off by the Bayshore Highway. Subsequent filling has provided space for the park. A part of the lagoon is being kept as a bird sanctuary and lake for small boats.

A community library connected to a community social hall by means of a long covered passage. In back of the passage is the automobile parking space.

The Brisbane entrance road forces the division of the park into two halves. This is capitalized on to divide the active and passive recreational uses. The north half of the park is planned to include a baseball diamond which already in an undeveloped state is much used. Bleachers, club house and car parking area will eventually be added.

The southern half of the park containing lagoon, library and social hall will fulfill the less active community needs.

Principle object of the park planting is to break up strong prevailing winds and give the park privacy from the Bayshore Highway and intersecting road. Strong growing trees and shrubs requiring little maintenance are used for this purpose.

(Continued from Page 11)

They recognize that organization of outdoor space is achieved by the use of various materials ranging from highly refined structural materials to rough materials. Single materials or colors are not important in themselves, but in relation to other materials and colors. Materials should not be used for their own sake but to form spaces for people to use and enjoy. One of the distinguishing things about their work is the way they bridge the gap between the refined materials of the architecture and the unrefined materials of the landscape through the extension of the materials of the architecture into its surroundings through the use of trellises, walls, fences, paving and shelters.

Plant materials, they feel, are the most important things in the garden after people and should not be used just decoratively but in a structural way principally.

They recognize in the use of plant material a tremendous challenge to the designer and choose their materials on the basis of culture, ultimate size, shape, kind of texture of foliage, color of foliage, flowers, bark, fruit and fragrance.

You will rarely find a clipped hedge in an Eckbo, Royston & Williams garden since they believe in choosing the plant that can grow to maturity in the space allowed without trimming or clipping. In the arrangement of plant material they feel that it is important to achieve a relation between a geometric plan to fit the architecture and space requirements and the free natural growth of the plant materials. Therefore, they use plants in a structural way as an artist uses color and as an architect uses his materials.

They state their place in society thus:

"Man needs the outdoors.

The outdoors needs organization and modification to fit man needs."

That's where they come in.

While the bulk of the firm's work is in the metropolitan regions of San Francisco and Los Angeles they have a scattering of work to the north around Napa and throughout the central and coastal valleys. A New York estate job testifies to the carrying power of Eckbo's reputation. To most landscape architects the private garden is the foundation of his professional practice and this is true of Eckbo, Royston & Williams. They have quite a few interesting garden projects in San Francisco, some of which are under construction at the present time. Their larger gardens are mainly in the East Bay, Marin County, and Los Angeles suburban areas. The shortage of housing

and difficulties of building have brought in quite a few remodel and extension problems, one of which is an extensive addition to an estate near Napa built in 1906. Some of their work which reflects the times is the preparation of sites now for later building construction when materials are more available. With this intention last winter they moved many large trees into the treeless site of one of their client's future home near Saratoga. As a result of proper handling and excellent maintenance the trees have already recovered from the operation and are growing rapidly to provide the shade and background for the house and garden that will come later.

Among their commercial work the firms lists three stores including a community market center in Los Angeles, complete with parking areas and garden patio.

They are redesigning an old San Francisco nursery, which dates from the Panama Pacific Exposition and doing a lumber yard and office building in Los Angeles.

Recently completed were the designs for the complete landscape development including the private gardens of two subdivisions near Los Angeles. Held in abeyance for the time being are two large cooperative housing projects during the planning of which the firm will be working in collaboration with architects, land planners and engineers. These projects will be complete community developments including shopping, recreation and school areas. Eckbo, Royston & Williams feel that the building industry is not solving the problems presented by the family that can afford only a small house. They feel that the housing cooperative movement can provide part of the solution to this problem through sensible standardization, elimination of the wasteful use of land and duplication of services.

The firm is striving to become more integrated in the San Francisco and Los Angeles regions to the point where their combined talents in park and recreation planning will be made more use of. In this way, they hope to partially overcome the fluctuations of the private home garden business.

While carrying on their regular business the firm hopes to be able in the near future to write a book which will expand and illustrate the theories they have concerning the fields of landscape design, site and recreation planning. A complete theoretical work for the profession has not been published for many years and basic design thinking has undergone radical changes during that time.



(Cascade Air Photo)

OREGONS' BOOM REGION Has Novel Pay-As-You-Go Plan

By **ARTHUR W. PRIAULX**

Virtually every city along the Pacific Coast from the Canadian line to the Mexican border is experiencing an unprecedented growth, in some cases bordering on a boom. With this population increase come headaches and challenges to city and suburban planners and officials to chart new and workable programs for sound and orderly development of our western metropolitan areas.

Leadership is needed and it looks like the West might well profit from the spectacular ten-year plan perfected and now in operation in the Eugene-Springfield-Lane county area of Oregon. Since 1940 this lumber capital of the world with its 208 sawmills and its billion feet of lumber production

annually, has suffered from growing pains. New industries, woodworking and remanufacturing plants, chemical and agricultural processing plants and a host of large and small factories have converged on this land of ample timber resources and cheap power.

This great influx of people and industry created problems that former easy-going Eugene never had anticipated. But in the citizenry of this area were men of sound judgment and excellent vision, who knew they were faced with a toughy and decided something had to be done and it had to be accomplished by the people then running the

(Continued on Page 26)

See Photo



Oregon's boom spot, Eugene-Springfield area, where ten-year plan of co-ordinated building is making history. Lower foreground is business district of Eugene, and in lower right one of headache-spots where newcomers are building homes faster than streets, roads, sewers and utilities can be installed. Upper center is Springfield business area and city surrounding it which has trebled in population in five years. Along the beautiful Willamette river, running diagonally through the mile-high aerial photograph is another headache spot where residential districts are mushrooming and industrial areas springing up, to cause problems for these doughty ten-year planners to solve.



Left: \$3,000,000 Willamette Valley Wood Chemical plant covering 13 acres will make 190 proof ethyl alcohol from wood waste. Is located in heart of Springfield industrial area.

Right: VERTICAL AERIAL VIEW of section of Eugene rapidly expanding manufacturing problems in zoning, taxation, streets, water mains, etc., successfully solved through voluntary planning council.



OREGONS' BOOM REGION—A Novel Plan

affairs of the cities, schools, county and other public agencies, with the help of volunteers from the ranks of civic leaders. They set to work.

In five years they have become the talk of the Northwest.

Briefly, the Eugene-Springfield ten-year plan is a co-ordinated program joined in by all county, municipal and school tax levying groups under the general advisory direction of the Central Lane Planning Council. The object of the plan is to so arrange and time tax demands that an accurate forecast of tax levies can be projected through the decade without having an excessive load in any one year, and the end result is aimed at keeping ad valorem tax bills on a fairly even keel.

This ten-year plan is based on area planning and area cooperation. It is in effect now a proven prescription for municipal growing pains. There was no law in Oregon enabling all tax levying groups to coordinate their efforts, and by the same token there was no law that prohibited such action. But Eugene and Lane County public officials knew that some overall plan must be worked out if city, county and school needs were to be met intelligently without oppressive loads on real estate.

The Central Lane Planning Council early started urging a pay-as-you-go program for financing all

the urgently needed projects hastened by the demands of a population skyrocketed (and this without war industries) from 35,000 in the Eugene metropolitan area in 1940 to close to 70,000 in 1946. They were faced likewise with the promise by Bonneville Administration economists and researchers that Eugene area would have by 1960 about 150,000 people.

For twenty years Eugene hadn't built a school. County and city buildings were fifty years old, obsolete and inadequate to meet twice the load originally intended. Suburban developments for miles in every direction from Eugene needed roads, bridges, water, sanitary facilities. An expanding industrial traffic created highway headaches, required more mileage for new manufacturing districts. Children needed recreation and playground facilities double and treble anything previously conceived. Municipal utilities were confronted with tremendously increased demand for services, for water and electricity.

How was this all to be done from public monies without overloading real estate? How were these vitally needed improvements to be built without floating a large public debt? Could these projects be given a priority status, voluntarily arrived at in conference between city, county and school



A view of Eugene's River Road District, a suburban area settled almost as thickly as most cities, with problems of sanitation, utilities, roads, streets and schools, solved by joint action of the several taxing bodies working with Central Lane Planning Council.

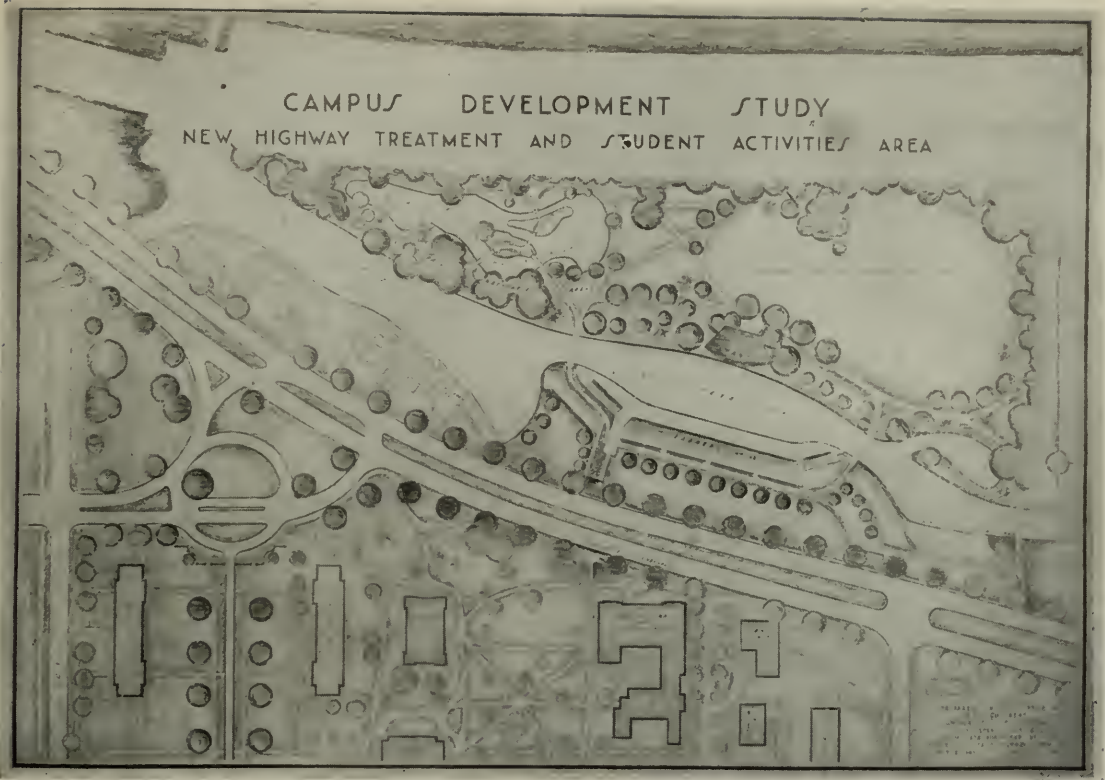

When relocation of the Southern Pacific railroad tracks through Eugene was demanded because of realignment problems connected with industrial expansion, the beautiful University of Oregon campus was threatened with trouble, until Lane Planning Council stepped into the breach, helped get university, city, state highway and railroad leaders together, finally worked out what promises to be one of the beauty spots in Oregon with mill race, highway, railroad and campus all landscaped and dovetailed into workable plan for utility and attractiveness.

officials, so that no two large expenditures would fall in one year? Civic leaders thought it could be done.

First, a complete survey was made of overdue school plant additions and improvements needed and for new school buildings for newcomer's children. A junior high school had to be built, and by adding during these good years, a 7.5 mill levy for two years no bonded debt was needed. A new high school is seriously needed, so for the past three years \$100,000 annually has been levied and impounded, and in two more years the entire \$500,000 will be in hand before actual construction on the building starts, thus saving interest load. Dr. Henry Gunn, Eugene city school superintendent, detailed his school building needs for a full decade ahead. He planned so that when the 5.5 mill levy for the high school had been completed, the same levy would remain for construction of several new structures to replace out-dated grade school buildings.

Pay-as-you-go sounds good to Eugene City, for

fresh in the minds of most citizens is the fact that they recently completed paying for a city hall built fifty years ago, and now virtually obsolete. Through City Manager Deane Seger, city's requirements have been co-ordinated with school needs so that no heavy levy for schools is asked of the taxpayers. County Judge Clinton Hurd saw the soundness of such a program and projected county needs on a similar basis. A \$500,000 fund for county roads and bridges is being sandwiched into the tax bill in such a manner that cash will be on hand when needed, but no bonds will be required and neither will county levies for these purposes fall in a year when city and school needs are great.

Springfield city, mushroomed from a town of 3800 in 1940 to well over 10,000 today and still growing at a rapid rate, has more than its share of headaches, and its city council and mayor, encouraged by the results of their next door city, and the county are about to pool their community tax problems with those of the area to create in this

(Continued on Page 40)



BEACH UMBRELLA

Typical of American radar equipment which smashed both German and Japanese armed might—light-weight, portable antenna used as a reflector in sending out short wave radio pulses and as a receiver to "catch" wave echoes reflected by enemy targets. Designed for beachhead use complete unit weighs only 400 pounds. Can be dismantled into four units of 100 pounds and has a range of about 80 miles.

(Westinghouse Photo)

R A D A R

Radar proved to be one of the most sensational and valuable weapons in the Allied armor of World War II. It detected Japanese planes 32 minutes before they struck at Pearl Harbor. It guided our torpedo planes to their targets in the devastating attack on Jap warships at Truk. It helped shoot down an estimated 60 per cent of the "buzz bombs" that rained on London in mid-1944. It swept the skies above the beaches of Anzio and Normandy, keeping the German Luftwaffe at a safe distance and directing our anti-aircraft bat-

teries with deadly accuracy when enemy planes did appear.

There were millions of radar units of every kind in operation on all fronts. They built a protective screen around our vast fleet of warships and merchant marine. They flew with our carrier planes, our fighter craft, our big bombers and patrol planes. They were floated ashore as our troops stormed new beachheads. They rode with our Marines as they island hopped their way to Japan. They stood guard all along our coastline and in every Allied city or town vulnerable to air attack.

Yet the "secret" of this powerful weapon is a principle so simple that it can be understood by any grade school pupil. The mountaineer shouting across a canyon and receiving back an echo from some distant cliff wall is illustrating a form of sound radar. The bat who emits high-pitched sounds and then guides itself by their echoes from the walls of a dark cave is also using sound radar.

In the same way, radar units work on the "echo" principle. A powerful beam of ultra-short radio

EDITOR'S NOTE: In the belief that the subject of RADAR is of keen interest to everyone, because of the many odd and interesting uses to which wartime radar developments will be applied to peacetime adaptations, the FIRST of a two-part article is presented herewith. The article will be completed in the OCTOBER issue of ARCHITECT & ENGINEER.

waves is projected from a transmitter. This beam, backward many millions of times in a single second. probing through all points in space, eventually meets with a target; an enemy ship, plane or land installation. The portion of the beam striking a target literally bounces back to its starting point, just as the mountaineer's voice returns to him from the cliff wall.

At the radar base, the wave echo is picked up by sensitive receivers, amplified and recorded on various indicators which tell range, angle of elevation and compass direction of the target. And all this happens with the speed of light—186,000 miles a second.

Yet, even though the basic principle of radar is simple, the engineering and development work that brought it to full stature as a potent weapon stands as one of the most remarkable achievements of American science. At the war's beginning in 1939, radar was not far removed from the stages of experiment and theory. Yet in two years' time it had been vastly improved, simplified and designed for mass production on a huge scale. What in normal times would have taken from ten to fifteen years of development work was compressed by American engineering ingenuity into a space measured in months.

Beam Pierces Fog, Night, Storm

The "seeing eye" of radar is a beam of ultra-short radio waves that pierces fog, night and storm for distances of hundreds of miles. These waves are produced in an electronic generator which literally "shakes" or oscillates incoming current to produce frequencies of many millions of cycles—that is, the waves move forward and

Ultra-short waves are a key factor in radar, because they travel in a straight line from the transmitter to the target and back again, thus assuring that the exact position of the target is recorded by the receivers. The longer radio waves used by commercial broadcasting systems, on the other hand, do not travel in a straight line, but tend to curve around the surface of the earth.

The waves are fired in short bursts from the radar antenna, which consists of two short lengths of copper conductor protruding from a dish-shaped reflector much like the one in your automobile headlight. The reflector, used to focus the radar beam so that all its energy is projected outward, is rotated in a complete circle for surface search and up and down in a 90 degree arc for aircraft detection.

The size and location of radar antennas vary with the job they must perform. On airplanes they are usually slung under the wing, are small, compact and sometimes streamlined with a shell-like plastic covering. On warships they are mounted near the crow's nest atop the ship and resemble a large bed-spring. Some antennas are truck-mounted or portable; still others must be located atop high towers to overcome land obstructions.

Radar transmission and reception is roughly similar to ordinary broadcasting and receiving. The main difference is that in radio a signal from the broadcasting tower is picked up by many home sets scattered throughout the country, while in radar the transmitting and receiving stations are located in the same place.

RADAR MAP

Southwest tip of Wales shown at night on cathode-ray tube of "H2S" apparatus in an R. A. F. plane. It was taken direct from the glowing, continuously moving green patterns seen on the radar receiver during a test flight. Britain spent \$36,000,000 in 1940 on Radar development.

(British Information Service Photo)

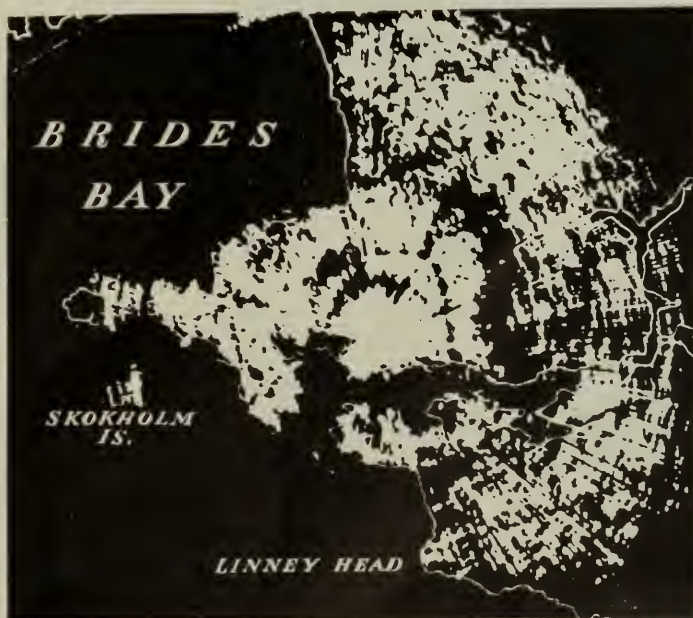

In fact, a single antenna is commonly used in radar to do both jobs of sending and receiving. First, a short burst of energy is sent out from the antenna while it is hooked up to the transmitter. Then after a fraction of a second of silence the receiver picks up the return signal.

The outgoing radar beam is a tremendous burst of energy, very often more powerful than the maximum output of the nation's largest radio stations. This is necessary because the beam, as soon as it leaves the antenna, is dispersed through hundreds of square miles of space in search of a target.

In contrast, the duration of this vast burst of energy is measured in millionths of seconds, depending upon the estimated range of targets. Since the beam travels with the speed of light—186,000 miles a second—the outgoing signal must be timed accurately so as not to interfere with the return echo from a target.

For example, if the shortest range desired is 327 yards, then the radar beam would travel to and from the target in two millionths of a second, since electro-magnetic waves move at the rate of 327 yards every millionth of a second. Hence, the duration of the outgoing burst of energy must be no more than one millionth of a second, in order not to interfere with the return signal.

The duration of silence between outgoing signals is determined by the longest range desired. If this is 327,000 yards, for example, the beam would have to travel twice this distance, or 654,000 yards, to reach the target and return. At 327 yards every millionth of a second, it would take the beam 2,000 times a millionth of a second, or one five-hundredth of a second for the round trip. Hence, the interval of silence between outgoing signals must be less than one five-hundredth of a second; otherwise, the weak returning signal would be lost in the strong, transmitted beam.

In searching for a target, the path of the beam is rotated rapidly through all points in space, exactly as a flashlight is used to probe the surrounding darkness. If the radar beam strikes a target, some of it is reflected back to the receiver. Here one device keeps in step with the rotating reflector and indicates the direction of the beam at the instant it reaches the target. Another device measures the time it took the beam to travel to the target and back again. Since radar waves always travel at the same speed, this measurement appears on the indicator in terms of miles or yards.

Although the energy in the outgoing radar beam is tremendous, the return signal is ordinarily many millions of times weaker. First, the beam is dispersed through hundreds of square miles of space. Second, only a small portion of the spreading rays strike the target, and of these a still smaller portion rebound to the receiver. Third, on the return journey also the beam fragment is still further dispersed throughout space, so that by the time it reaches home it is literally a mere shadow of its former self.

If, for example, 100,000 watts of short-wave energy were projected by a radar antenna at a target 1,000 feet away, the effective power in the region of the target might be only .8 of a watt per square foot.

This tiny fraction of power is still further weakened on its return journey. Assuming that 50 square feet of the target is struck by the beam and reflects it back to the receiver, then the amount of power making the homeward trip is 50 times .8 or 40 watts. This fragment is in turn dispersed throughout the 1,000 feet of space, so that by the time it reaches the receiving antenna its power density has been reduced to 1/300,000th of a watt per square foot.

If the antenna is three square feet in area, then the total power entering the receiver would be three times 1/300,000th of a watt, or 1/100,000th of a watt. In short, the returning signal is 10 billion times weaker than the original burst of energy. Yet sensitive receivers pick it up, electronic amplifiers increase its volume and its message is easily read by the radar operator.

(Continued on Page 39)





CALIFORNIA COUNCIL OF ARCHITECTS:

John S. Bolles, President; Charles O. Matcham, Vice-President; James H. Mitchell, Secretary-Treasurer; 369 Pine Street, San Francisco 4.

Washington State Chapter:

George W. Stoddard, President; Clifton J. Brady and Joseph H. Wohleb, Vice-Presidents; Stephen H. Richardson, Secretary; J. H. Dillon De Hart, Treasurer; Offices 516 Central Building, Seattle 4, Washington.

Northern California Chapter:

Andrew T. Hass, President; Hervey Parke Clark, Vice-

President; John S. Bolles, Secretary; Ernest Born, Treasurer; 369 Pine Street, San Francisco 4.

Central Valley Chapter (California):

Herbert E. Goodpaster, President; James A. Gillem, Vice-President; Frank V. Mayo, Secretary; Victor Galbraith, Treasurer; Offices 834 West Willow Street, Stockton.

Southern California Chapter:

Charles O. Matcham, President; Adrian Wilson, Vice-President; John Landon, Secretary; Albert C. Martin, Jr., Treasurer; Offices 3757 Wilshire Blvd., Suite 212, Phone Fltroy 2393 or Mutual 4592. DIRECTORS, John Rex, Paul R. Hunter, and Weldon D. Becket.

CENTRAL VALLEY CHAPTER (California)

The widespread scope of activities being undertaken by national officers of the A.I.A. in behalf of the architectural profession, as exemplified at the recent national convention in Florida, were described to Chapter members by Secretary Frank Mayo at the July meeting. Mayo was in attendance at the Florida meeting.

Efforts of President Herb Goodpaster to activate Architects in the lower San Joaquin Valley by luncheon and sub-chapter meetings are reported as being quite successful, judging from the number of applications for new membership which have been received.

**MODERNIZATION OF BUILDING
CODES MAKES PROGRESS**

Major progress in modernization of building codes by cities throughout the Nation was reported recently with the announcement that leading municipalities from coast to coast have ruled that factory-fabricated Stran-Steel Quonsets meet adjusted local code requirements.

The announcement was made by the Great Lakes Steel Corporation, Stran-Steel Division, through their Northern California territorial distributor, the Kraftile Company of Niles, California, and further declared the firm was continuing to manufacture the war-developed, round-roofed buildings for peacetime uses. The peacetime structures feature new architectural and construction methods which enable mass production, minimize use of critical materials and simplify erection. They were previously unrecognized by most building codes because the local regulations were based on specifications worked out years before steel, plastics, plywood and other modern materials were in use.

Recently-granted approvals, the announcement said, include those by New York City, Los An-

geles, Detroit, and the State of Ohio. The Quonset materials and construction methods were subjected to thorough tests prior to issuance of these authorizations.

Separate but similar approval has been awarded recently by the New York City Board of Standards and Appeals to Stran-Steel framing, the nailable steel building material used in conventional light construction as well as for Quonset framework.

It is to be noted, the announcement said, that these new approvals of factory-fabricated materials were granted in the class of permanent construction, as distinguished from temporary and restricted actions which have placed thousands of Quonset emergency housing units in hundreds of cities.

Scores of other cities have issued permits authorizing erection of Quonsets individually. In still other cases, Quonsets have been adapted to meet existing building codes by providing the structures with masonry fronts or other features as required.

CHARLES KRUEGEL, Architect, has moved to 1011 East Howard, Glendale, California.

MERRILL W. BAIRD, Architect, has moved to 947 N. Isabel, Glendale, California.

ALBERT H. LARSEN, Architect, has moved to 80 Finger Avenue, Redwood City, California.

LEFFLER B. MILLER, Architect, has moved to 1240 Rose Street, Berkeley, California.

JOHN B. ANTHONY, Architect, has moved to 178 Grand Avenue, Oakland, California.

C. O. GILLAM, Architect, has moved to P. O. Box 669, Yuma, Arizona.

WITH THE ENGINEERS

Structural Engineers Association of Northern California

W. Adrian, President; William W. Moore, Vice-President; Franklin P. Ulrich, Sec-Treas.; John A. Blume, Ass't. Sec-Treas.; Offices 214 Old Mint Building, San Francisco, Phone GARfield 3890. DIRECTORS, H. M. Engle, Mark Falk, and M. V. Pregnoff.

American Society of Civil Engineers
San Francisco Section

Theodore P. Dresser, Jr., President; Leon H. Nishkian and Sidney T. Harding, Vice-Presidents; John E. Rinne, Secretary-Treasurer; 225 Bush Street, San Francisco 20.

Puget Sound Council (Washington)
Engineering & Technical Societies

R. E. Kistler, A. I. E. E., Chairman; A. L. Miller, A.S.C.E., Vice-Chairman; L. B. Cooper, A.S.M.E., Secretary; B. A. Travis, I.E.S., Treasurer; Offices, Seattle, Washington.

SAN FRANCISCO SECTION

AMERICAN SOCIETY OF CIVIL ENGINEERS

A technical program was presented members recently when Frank M. Stead, Chief, Division of Environmental Sanitation, State Department of Public Health, discussed "Current Trends in Public Health Engineering." Many problems outside the fields of water supply and waste disposal were included in Stead's remarks.

WILLIAM H. BRADY, Consulting Engineer and Lecturer in the College of Engineering, University

★ FOR BETTER SERVICE

Remember that

KRAFTILE is WESTERN HEADQUARTERS

For these well-known products:

★ **GEMCO** Insulation Hangers, Hanger Supports, Anchor Nails and Bolts.

★ **MINWAX** Waterproofings, Dampproofings, Caulkings, Waxes and Wood Finishes, Brick and Cement Coatings.

★ **RAYBESTOS** Safety Decking.

★ **STRAN-STEEL** Quonset "Packaged" Steel Buildings.

★ **KRAFTILE** Acid Brick, Ceramic Facing, Glazed Structural Wall Units, Patio Tile, Quarry Tile, Swimming Pool Overflow Gutter.

★ **MIRACLE** All-Purpose Adhesives.

★ **NUKEM** Acid-Proof Materials and Construction.

For complete information and prompt service, phone or write

KRAFTILE COMPANY

Niles, California

Niles 3921

San Francisco — 50 Hawthorne Street, DOuglas 3780

of California, recently addressed the Junior Forum on the subject, "An Example of More Effective Engineering Instruction."

MEMBERSHIP of the Section is now 741, according to J. E. Rinne, Secretary-Treasurer.

RICHARD S. CHEW and HARRY A. COX, Engineers, have moved into new offices in the Mills Building, San Francisco.

ANNUAL CONVENTION SEA, Santa Barbara, October 11, 12, 13. Be sure to attend.

ENGINEERING MEETING

The annual fall meeting of the National Aeronautic and Aircraft Engineering display of the National Society of Automotive Engineers will be held in Los Angeles, California, on October 3, 4, 5, 1946.

The National Transportation & Maintenance meeting of the Society of Automotive Engineers is scheduled for October 16 and 17, in Chicago.

ENGINEERING AND ARCHITECTURAL EXTENSION COURSES ARE PLANNED

Cooperating for a second year with the Southern California Chapter A.I.A., University of California Extension this fall will launch an expanded program of engineering and architectural courses, a majority of which will be designed as refresher work for professional men and women.

University classes starting in mid-September will meet at the extension center, 813 South Hill Street, Los Angeles, and on the University Campus. A full schedule of courses is available on request from University of California Extension, Los Angeles 24.

RECEIVES METAL SOCIETY AWARD

The American Society for Metals has announced that Dr. Rufus E. Zimmerman has been elected to receive the Society's Medal for the Advancement of Research for 1946.

Dr. Zimmerman is vice president in charge of research and technology of the United States Steel Corporation of Delaware, with offices in New York and Pittsburgh.

The medal was first awarded in 1943.

Actual award of the plaque and medal will be made on November 21, 1946, during the National Metal Congress and Exposition in Atlantic City.

NEW MANUALS AISC READY SOON

William H. Popert, acting representative for the American Institute of Steel Construction, Inc., advises that the new manuals will be available some

time in October. The price, as usual, will be \$2. Orders may be sent to the AISC office, 1227 Russ Building, San Francisco.

MOVES OFFICE

Elmer F. Steigelman, Civil Engineer, has moved his offices from 690 Market Street, San Francisco, to 577 14th Street, Oakland, California. He specializes in industrial design, surveying, and subdividing.

APPOINTED EXECUTIVE

BY BETHLEHEM STEEL

William J. McClung, for the past fifteen years connected with the Lackawanna, New York, plant of the Bethlehem Steel Company, where he has served as assistant to the general manager since March, 1945, has been appointed general manager of the Bethlehem Pacific Coast Steel Corporation's steel plants and mill depots.



WILLIAM J. McCLUNG
General Manager

He will be in charge of plants in Seattle, South San Francisco and Los Angeles, and mill depots at Seattle, Portland, San Francisco and Los Angeles, with headquarters at the South San Francisco plant.

A native of Phoenix, Arizona, McClung was graduated from the University of Southern California and started in the employ of Bethlehem Steel Company in 1930.

NEW FHA BULLETIN

A revised edition of the FHA Bulletin "Principles of Planning Small Houses" has just been printed and is available free to architects and builders at local FHA field offices.

Chief purpose of the Bulletin (Technical Bulletin No. 4) is to stimulate and encourage the designing of modest type homes at reduced cost without sacrifice of comfort and convenience, or sound construction and reasonable maintenance expense.

FHA recommends to those who contemplate building at minimum expense that designs of the house and appurtenances be the product of competent architects.

MASTEN & HURD, Architects, have moved from 407 Sansome Street to 526 Powell Street, San Francisco.



Just a reminder...

Built-in telephone outlets are inexpensive



It costs little to install conduit for a number of telephone outlets at the time a house is built...and it's a wise economy, even if only one telephone is needed immediately.

Future telephones can then be added without bringing exposed wires in along baseboards or molding.



Outlets add real value to a house. So plan ahead for them. Your

clients will appreciate your foresight. Call or dial your local Telephone Business Office and ask for free Architects' and Builders' Service.



The Pacific Telephone and Telegraph Co.



IN THE NEWS

TIME CONTROL SWITCHES

Meeting the need for special Time Switches, the Automatic Temperature Control Company of Philadelphia, Pa., has just issued BULLETIN T-55 which shows many adaptations of time switch control.

The Standard Line, covering a wide range of types and models; the Complete Systems, designed for special control characteristics and panels and combinations, and the Low Cost Time Switches, which are for special needs and original equipment manufacture, are all shown and explained in the Bulletin. Copies are available from the manufacturer upon request, 34 East Logan Street, Zone 44.

RECORD EMPLOYMENT

An estimated total of 3,338,000 civilian employment in California for June established a new 1946 high. Every type of employment (except governmental) increased, according to the California State Reconstruction and Re-employment Commission, which predicted an all-time high in employment for September.

PERSONNEL PROMOTIONS AT SMOOT-HOLMAN COMPANY

Changes in the Smoot-Holman organization in Inglewood, Calif., have just been announced by C. E. Smoot, President. William Holman has been



Mr. William Holman

appointed Vice President and Works Manager; L. A. Hobbs is now Vice President and General Sales Manager; Fred M. Smoot is Secretary and Thos. S. Baker, Treasurer. The names of Fred M. Smoot and L. A. Hobbs have also been added to the firm's Board of Directors, in addition to their duties at the plant.

Mr. Hobbs has been appointed a member of the OPA Lighting Fixture Industry Advisory Committee and is dividing his time between the West Coast and Washington, D. C. In addition to the main office and plant in Inglewood, Smoot - Holman maintains branch offices at San Francisco and Seattle. The firm manufactures a complete line of industrial and commercial lighting equipment, including fluorescent and incandescent luminaires, flood lights and reflectors.



Mr. L. A. Hobbs

BAXCO
CHROMATED ZINC CHLORIDE

CZC

PRESSURE TREATED LUMBER
● **PROTECTS AGAINST DECAY AND TERMITE ATTACK**

Specify it in your home
Available through Lumber Dealers

LOS ANGELES 601 W. 5th Street Phone Michigan 6294	SAN FRANCISCO 333 Montgomery Street Phone DOuglas 3883
---	--

J. H. Baxter & Co.

AGENTS FOR WEST COAST WOOD PRESERVING CO., SEATTLE, WASH.

CORRUGATED TRANSITE PROVES VALUE IN MARINE WAREHOUSE

Construction of the warehouse building for the U. S. Marine Corps, Depot of Supplies, at 3rd Street in the Islais Creek area of San Francisco in 1943, at the peak of the war effort, was more than just another standard warehouse in design.

Six hundred feet long the building was divided into three main storage areas by the installation of fire-walls of corrugated Transite at intervals of 200 feet.

From the time of construction, the warehouse was used as a general storage depot for materials awaiting trans-Pacific shipment with considerable use for the storage of ammunition.

On May 29, 1946, the warehouse contained a capacity of munitions when fire of unknown origin broke out in one of the sections. In the particular area where the fire started 100,000 rounds of 50-calibre ammunition, incendiaries, tracers, armor

piercing bullets and cans of highly inflammable cosmoline were stored.

The entire area was ablaze in a matter of minutes with shells bursting and flames leaping the height of the building creating heat of great intensity.



(U. S. Marine Corps Photo)

TRANSITE walls following fire.

In less than an hour the fire was brought under control and in two hours the fire was out.

Officials state that control of the fire and limiting of it to the one storage section in which it started, was due to the fire wall of corrugated transite.

Combustible materials stored in the remainder of the warehouse were unharmed. Had the fire spread beyond this wall, officials predict it would have moved into adjacent warehouses and instead of a \$50,000 loss would have mounted into hundreds of thousand of dollars.

The corrugated Transite installation was made by Western Asbestos Co., distributors for this material.

WHEELER OSGOOD OFFICIALS PURCHASE DOOR COMPANY

In one of the Pacific Northwest's largest financial transactions in many years, management officials of the Wheeler Osgood Company, the world's largest manufacturer of doors, purchased the company.

The sale puts ownership of the Wheeler Osgood Company in the hands of N. O. Cruver, W. M. MacArthur, Lionel J. Phillips, Paul M. Smith and L. J. Woodson, management officials of the company for many years.

Cruver, 29 years with Wheeler Osgood and formerly vice president and general manager, becomes president and treasurer. MacArthur, 20 years with the company, becomes a vice president,

Let's Talk Wiring

The growth in the use of electricity in the home has been steady and amazing. But, average wiring capacity has never quite been able to catch up, and few homes have truly enjoyed the most efficient and convenient use of appliances and lighting equipment.

Now, as we are about to begin a new era in building, there is an opportunity to "start from scratch"—to provide complete electrical adequacy for homes of the future.

These homes, from year to year, will demand an ever expanding list of appliances — appliances which can provide satisfactory and economical service, only if the wiring system is adequate for the job.

Make sure each house you plan will be modern, electrically, for years to come by specifying:

1. *Wiring of sufficient size.*
2. *Enough convenience outlets for future appliances and lighting needs.*
3. *Enough circuits to distribute the electrical load properly.*

NORTHERN CALIFORNIA ELECTRICAL BUREAU

**1355 MARKET STREET
SAN FRANCISCO 3**



as does Phillips, who has been with the company for 27 years. Smith, with 18 years service, becomes secretary, and Woodson is now president of the Nicolai Door Sales Company, a wholly-owned subsidiary of the Wheeler Osgood Company.

Cruver predicted a great future for the Wheeler Osgood Company: "We are mass producing more and better products. Our nationwide sales and distribution organization is putting these products into the hands of builders.

"We must manufacture millions of doors for the many millions of homes to be built in the next 10 years. We must rebuild jobbers' inventories to prewar levels.

"We have faith and confidence in the future of America and in the Wheeler Osgood Company—and the tremendous part it must play in building better products for better homes, for a better America."

The Wheeler Osgood Company was founded in 1889 in Tacoma. Today, its plants and grounds cover over 21 acres, and its sales and distribution organization is nationwide. Over 700 people are employed in the Tacoma plant.

A. C. ZIMMERMAN, Architect, has moved to 2439 Hyperion Avenue, Los Angeles, California.

HEADLINE NEWS & VIEWS

By E. H. W.

Los Angeles city officials declare "Architects are subject to the tax"—Professions and Occupation License Tax which became effective August 31st. Wonder why OPA hasn't put a ceiling on taxes!

* * *

Membership in the Southern California Chapter, A. I. A., has increased more in the first seven months of 1946 than it did in the entire year of 1945.

* * *

A Pacific Slope Architect told us his business was "Kaleidoscopic"—we looked it up in the dictionary, too.

* * *

The great State of Oregon is toying legislatively with a zoning program intended to eliminate "objectionable" construction—what would our politicians do without their "toys"?

* * *

Topic of a recent Radio Network program, "What Is Holding Back Construction?" We're gullible, what is?

* * *

Representing over \$260 million in mortgages and bank loans, more than 37,000 San Francisco families hope to build the house of their dreams within four years—San Francisco Housing Authority report. (Well, it doesn't cost anything to dream, or does it?)

* * *

"From where I sit," a veteran writes, "It looks like it will be a cold day before I get my new house built." A cursory examination disclosed the fact that he was "sitting" in a nice, comfortable steam-heated apartment—the lucky guy.

* * *

The California State Board of Harbor Commissioners has announced a contemplated improvement to Fishermen's Wharf, renowned tourist attraction and focal point of the commercial fishing industry in San Francisco, which will total approximately \$2,000,000.

* * *

Albert R. Williams, Architect of San Francisco, is designing a \$1,000,000 department store building for Roos Bros., Inc., to be constructed in San Jose, California.

* * *

"Planning Your Home for Better Living—Electrically," is the title of a new and extensively color-illustrated booklet recently published by the Home Bureau of the General Electric Company. An exceptionally nice piece of promotion.

"GOODS OF THE WOODS"
E.K. WOOD LUMBER CO.
4710 SO. ALAMEDA

LOS ANGELES
—●—
OAKLAND
SAN FRANCISCO

IN THE NEWS

JOHN J. EASTERLY, Architect, has moved his offices from Berkeley, California, to 1006-A Lincoln Street, Watsonville, California.

SPEAKER

Commodore John D. Small, CPA administrator, will address the annual Producer's Council meeting in New York City on September 25, 1946.

His subject will be the general economic outlook for construction.

TRADE NAME

United States Plywood Corporation's construction material made by bonding a thin wood veneer to metal, known as Decorative Armorply, has been changed to "FLEXMETL. The hardwood veneer is only 1/85 to 1/28 of an inch thick.

REQUESTS DECONTROL OF REINFORCED STEEL

Suspension from price control of reinforcing steel bars to increase production of this important construction item has been requested by the Associated General Contractors of America.

The request was supported by approximately 4000 general contractors who perform more than 70 per cent of the nation's contract construction. Present production is 50 per cent below domestic needs.

ATOMIC ENERGY

The University of California's scientific laboratory at Los Alamos, where the atom bomb was constructed, is now given over to pure research looking toward peacetime uses of atomic energy.

TRAVEL

Seventy-eight thousand, nine hundred twenty-seven visitors, traveling in 24,588 automobiles, have entered Lassen Volcanic National Park up to September 1, 1946. This compares with 28,074 persons and 7,961 vehicles for the same period of last year.

A Japanese navy torpedo plane has been given to the College of Engineering on the Los Angeles campus of the University of California for study by students.

The West's Outstanding Lighting Equipment

Users know from experience that the Smoot-Holman label is an assurance of quality. Look for it whenever you select lighting equipment, and be assured of outstanding service and trouble-free performance.

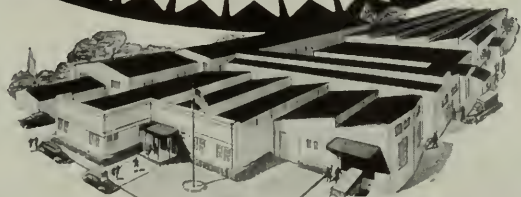

Offices in Principal Western Cities—Branch and Warehouse in San Francisco

PRODUCER'S COUNCIL PAGE

The National Organization of Manufacturers of Quality Building Materials and Equipment
affiliated with THE AMERICAN INSTITUTE OF ARCHITECTS

President, E. E. CATHCART
Johns-Manville Sales Corp.
116 New Montgomery St.

Vice-President, C. J. NICHOLAS
Bostion-Morley Co.
301 Brannon St.

Secretary, H. C. GALITZ
Westinghouse Electric Corp.
110 Sutter St.

Treasurer, E. P. LARSON
Celotex Corp.
675 Townsend St.

Edited by C. W. KRAFT, KRAFTILE CO., Niles, California

NORTHERN CALIFORNIA CHAPTER



MR. O. R. EQUAL
"—two-faced little weasel"

Roofing Specs" in January "Architectural Forum."

"This two-faced little weasel is a recognized menace to the architectural profession. His guise is 'open bidding' but unless check-reined, he is likely to burrow into and undermine both value and performance. Beware of Mr. O. R. Equal . . . one sure way of exterminating him is to keep him OUT of the specifications."

Quoting this "ad" further, "Exact building specifications encourage fair bidding practices and promote good construction."

Our thanks to the Barrett Division, Allied Chemical & Dye Corporation, for permission to use this material.

TOO MANY HOLIDAYS. For the first time in many years, the Chapter passed up a monthly meeting, Labor Day on the first Monday and then, Admission Day a week later put a preferred Monday meeting so late in September that it was decided to pass it up until October.

For want of a better thumb-nail sketch this month, we run old O. R. Equal. But get this, straight—he's no pin-up boy of the Producers' Council and certainly no friend of the Architect or the Public.

Back in 1937, the Barrett Company described him thusly in an "ad" entitled "A Good Place to Stop Leaks is in the

OCTOBER 7th is our next meeting—so don't forget.

SEMI-ANNUAL MEETING of the Producers' Council, Inc., now becomes the Fall Meeting. The volume of work handled by the Council has developed to the point where two full scale general membership meetings per year are necessary. The Spring meeting coincides with the AIA Annual Convention and is held in conjunction with it, with emphasis on attendance at the Architects' sessions. Election of officers and directors of the Council are now held at the Fall Meeting which will be in New York this year on September 25th and 26th.

MODULAR MOMENTS

Question: Why are modular windows shown in catalogs in fractional sizes such as 3' 4 $\frac{7}{8}$ ", 5' 0 $\frac{7}{8}$ ", etc.?

Mr. Lorimer: Actually, steel windows are coordinated in multiples of 4" bar center to bar center. The older steel window catalog indication of exact required masonry opening was carried forward into the modular catalogs. $\frac{7}{16}$ " clearance is required between the edge bar center and the jamb face on each side of the window to permit of hinges and vent clearance. This has been the practice for 25 years. The window size is 4" multiple plus $\frac{7}{16}$ " plus $\frac{7}{16}$ " gives the cataloged dimensions of 5' 0 $\frac{7}{8}$ ", etc.



USE QUALITY PRODUCTS



CONSULT AN ARCHITECT

RADAR

(Continued from Page 30)

The heart of the radar receiver is an electron "gun"—called the cathode ray tube—which fires a stream of electrons against a fluorescent screen to make a luminous spot. The position of this spot on the screen is controlled by a series of four electrically-charged plates inside the tube which can make the spot move up and down or from side to side.

Each time the radar transmitter sends out a burst of power, the luminous spot starts moving across the fluorescent screen in a straight line. When a signal is reflected from the target, it bounces back to the antenna where the receiver picks it up, amplifies it and increases it on the vertical deflection plates. This causes the spot to deflect sharply upward, revealing the presence of a target in the form of an inverted "V," called a "pip."

The time that elapses between the start of the cathode ray beam and the appearance of a "pip"

(Continued on Page 43)



RADAR ELECTRONIC TUBES: These became the "eyes" of America's armed forces during the recent war and will take their place in postwar science.

BASALITE

LIGHTWEIGHT CONCRETE
BUILDING UNITS

CHARACTER • ECONOMY • INSULATION
FIRE-SAFE • TERMITE PROOF • PERMANENCE

BASALT ROCK CO., INC.
NAPA, CALIFORNIA

FORDERER CORNICE WORKS

Manufacturers of

Hollow Metal Products • Interior Metal Trim
Elevator Fronts and Cabs
Metal Plaster Accessories • Sanitary Metal Base
Flat and Roll Metal Screens
Metal Cabinets • Commercial Refrigerators

269 POTRERO AVE.

SAN FRANCISCO, CALIF.

HEMLOCK 4100

STRUCTURAL STEEL

For Class A Buildings,
Bridges, etc.

JUDSON PACIFIC - MURPHY CORP.

1200 SEVENTEENTH STREET
SAN FRANCISCO

==== Plants: San Francisco - Oakland ====

SISALKRAFT

REG. U. S. PAT. OFF.

"More than a building paper"

THE SISALKRAFT CO.

205 West Wacker Drive
Chicago, Ill.

55 New Montgomery Street
San Francisco, Calif.

OREGON BOOM REGION

(Continued from Page 27)

hot spot of expansion in Oregon a sound tax and development program which already is the envy of many northwestern cities.

How well has this program worked out? Since 1940 Eugene, Springfield, Lane County, city and suburban school districts and the Eugene Water Board (serving the Eugene area with both water and the nation's lowest domestic cost electric energy) have retired bond issues and paid off debts. These districts have taxed themselves in the "good years" and yet have kept the millage rate to a safe level—under 76 mills. The City of Eugene in that period has adopted a city manager plan and has become 50 per cent self-supporting from income other than direct taxes.

Funds for a new sewage disposal plant amounting to \$375,000 have already been collected over a period of years at the rate of 25 cents monthly from each water user. The tax picture for the taxpayer in Eugene this year will look something like this: John Doe Citizen will receive a bill for 76 mills. Included in this is 21 mills, voted in 1943 and 1945, for cash construction reserves—13 mills for new schools 6 mills for sewers and 2 mills for the county's postwar road and bridge program. Officials say that with the inflated dollar this millage rate is about equal to a 50-mill levy in normal times, not excessive. The entire tax program,

evolved from this area-pooling of requirements for a fast-growing region, is sound and is something that this community is mighty proud of, for it shows civic courage and intelligence of a high order.

Although this ten-year plan contemplates a fairly steady tax load for a decade ahead it has some ideal features of flexibility. In some instances very low interest-bearing bonds have been issued, but they are serial bonds, not deferred, payable beginning a year after issuance. Combined with the continuing levies for construction reserves they give this Eugene-Springfield area an unusually flexible tax structure which can be retracted to meet sudden depressions.

To show how easily this voluntary co-ordination of public taxing activities functions when a definite period of projection of public needs is outlined by each taxing group for a period of ten years, a check of the combined budget estimates for the decade discloses certain points of value to each group charged by law with operating and financing its particular activity. The two-year, two-mill county road and bridge levy expires in 1946, so then is the time to step in with a similar levy for county courthouse or roads. In 1949-50-51 the combined city and school levies takes a dip, thus highlighting the general period as a likely one for the county to step in without upsetting the general equilibrium of the millage picture.

Public officials offer no hope to taxpayers of this district for a lower tax load for the next ten years than at present, and for an area experiencing such phenomenal growth, with needs for a vastly expanded and improved public plant, this is not considered news, but the real news is the fact that this great public plant expansion program will be realized without a disastrous peaking of tax burdens, in a safe and sane and orderly manner.

They do promise one thing, however, that there will be no more deadly, high-interest-rate bond issues, dragging along from one generation to another, as hard to pay off as for a dead horse. Citizens recall that when the bond issue on a Eugene grade school building was finally paid off around 1940, the building had long since been worn out and torn down.

Eugeneans operate this ten-year plan just like they would their home family finances, figuring that if it is smart for a family to pay cash, pay for things as they go, and only buy just as much as you can afford, with extra expenses allowed in good times, that the same sound philosophy can be applied to public business.

PABCO APPOINTMENTS

Norman L. Favours has been appointed central district sales manager for the PABCO Company, according to a recent announcement by J. E. Holbrook, vice president of the company.

DESIGNED TO USE

In the development of your business . . . now and in the postwar era.

Many subscribers to **Architect's Reports** find these ADVANCE building surveys . . . giving name of project, location, architect, proposed cost and other pertinent information a "must have" service to their business planning.

Data furnished you DAILY at a cost of \$10 per month.

Phone EXbrook 7182 — Subscribe Today

ARCHITECT'S REPORTS

Published Daily by

ARCHITECT and ENGINEER, Inc.

68 Post Street, San Francisco

EXbrook 7182

ESTIMATOR'S GUIDE

BUILDING AND CONSTRUCTION MATERIALS

PRICES GIVEN ARE FIGURING PRICES AND ARE MADE UP FROM AVERAGE QUOTATIONS FURNISHED BY MATERIAL HOUSES TO SAN FRANCISCO CONTRACTORS. 2 1/2% SALES TAX ON ALL MATERIALS BUT NOT LABOR

All prices and wages quoted are for San Francisco and the Bay District. There may be slight fluctuation of prices in the interior and southern part of the state. Freight cartage, at least, must be added in figuring country work.

BONDS—Performance—\$10 per \$1000 of contract. Labor and materials, \$10 per \$1000 of contract.

BRICKWORK—

Common Brick—Per 1M laid—\$50.00 to \$60.00 (according to class of work).

Face Brick—Per 1M laid—\$120 to \$150 (according to class of work.)

Brick Steps—\$1.60 per lin. ft.

Brick Veneer on Frame Bldg.—Approx. \$1.30 per sq. ft.

Common Brick—\$19.00 per M, truckload lots, f.o.b. job.

\$19.00 per M, less than truckload, plus cartage.

Face Brick—\$40 to \$80 per M, truckload lots, delivered.

Cartage—Approx. \$4.00 per M.

BUILDING PAPER—

1 ply per 1000 ft. roll.....	\$3.50
2 ply per 1000 ft. roll.....	5.00
3 ply per 1000 ft. roll.....	6.25
Brownskin, Standard, 500 ft. roll.....	5.00
Sisal kraft, 500 ft. roll.....	5.00
Sash cord com. No. 7.....	1.20 per 100 ft.
Sash cord com. No. 8.....	1.50 per 100 ft.
Sash cord spot No. 7.....	1.90 per 100 ft.
Sash cord spot No. 8.....	2.25 per 100 ft.
Sash weights, cast iron, \$50.00 ton.	
Nails, \$3.42 base.	
Sash weights, \$45.00 per ton.	

CONCRETE AGGREGATES—

The following prices net to Contractors unless otherwise shown.

Gravel, all sizes—		
\$1.95 per ton at Bunker; delivered		\$2.50
	Bunker	Del'd
Top Sand	\$1.90	\$2.50
Concrete Mix	1.90	2.45
Crushed Rock, 1/4" to 3/4".....	1.90	2.50

Crushed Rock, 3/4" to 1 1/2".....	1.90	2.50
Roofing Gravel	2.25	2.80
River Sand	2.00	2.45

Sand—

River Sand	2.00	2.45
Lapis (Nos. 2 & 4).....	2.85	3.15
Olympic (Nos. 1 & 2).....	2.85	3.10
Del Monte White84c per sack	

Cement—

Common (all brands, paper sacks), carload lots, \$2.42 per bbl. f.o.b. car; delivered \$2.72. Cash discount on carload lots, 10c a bbl., 10th Prox.; less than carload lots \$3.20 per bbl. f.o.b. warehouse or delivered.

Cash discount 2% on L.C.L.

Atlas White	} 1 to 100 sacks, \$2.50 sack warehouse or del.; \$7.65 bbl. carload lots.
Calaveras White	
Medusa White	

Forms labor average \$350 per 1000 sq. feet. Average cost of concrete in place, 50c per cubic foot, exclusive of forms; \$15.00 per cubic yard. With forms \$1.60 per cubic foot.

DAMP-PROOFING and Waterproofing—

Two-coat work, \$3.50 per square. Membrane waterproofing—4 layers of saturated felt, \$7.00 per square. Hot coating work, \$2.50 per square. Medusa Waterproofing, \$3.50 per lb. San Francisco Warehouse. Tricocel waterproofing. (See representative.)

ELECTRIC WIRING—\$12 to \$15 per outlet for conduit work (including switches).

Knob and tube average \$3.00 per outlet. (Available only for priority work.)

ELEVATORS—

Prices vary according to capacity, speed and type. Consult elevator companies. Average cost of installing a slow speed automatic passenger elevator in small four story apartment building, including entrance doors, about \$6500.00.

EXCAVATION—

Sand, 60 cents; clay or shale \$1 per yard.

Trucks, \$20 to \$32 per day.

Above figures are an average without water. Steam shovel work in large quantities, less; hard material, such as rock, will run considerably more.

FIRE ESCAPES—

Ten-foot galvanized iron balcony, with stairs, \$150 installed on new buildings; \$160 on old buildings.

FLOORS—

Composition Floors, such as Magnesite, 50c per square foot.

Linoflor—2 gages—\$1.25 to \$2.75 per sq. yd.

Mastipave—90c to \$1.50 per sq. yd.

Battleship Linoleum—available to Army and Navy only—1/8"—\$1.75 sq. yd. 2/8"—\$2.00 sq. yd.

Terazzo Floors—50c to 70c per sq. ft.

Terazzo Steps—\$1.75 per lin. ft.

Mastic Wear Coat—according to type—20c to 35c.

Hardwood Flooring—

Standard Mill grades not available.

Victory Oak—T & G	
3/4" x 2 1/4".....	\$143.25 per M. plus Cartage
1/2" x 2".....	122.00 per M. plus Cartage
1/2" x 1 1/2".....	113.50 per M. plus Cartage
Prefinished Standard & Better Oak Flooring	
3/4" x 3 1/4".....	\$180.00 per M. plus Cartage
1/2" x 2 1/2".....	160.50 per M. plus Cartage

Maple Flooring

3/4" T & G Clear	\$160.50 per M. plus Ctg.
2nd	153.50 per M. plus Ctg.
3rd	131.25 per M. plus Ctg.

Floor Layers' Wage, \$1.87 1/2 per hr. (Legal as of Jan. 21, 1946. Given us by Inlaid Floor Co.)

GLASS—

Single Strength Window Glass.....	20c per	□	ft
Double Strength Window Glass.....	30c per	□	ft.
Plate Glass, under 75 sq. ft.....	\$1.00 per	□	ft.
Polished Wire Plate Glass.....	1.40 per	□	ft.
Rgh. Wire Glass34 per	□	ft.
Obscure Glass27 per	□	ft.
Glazing of above is additional.			
Glass Blocks	\$2.50 per	□	ft. set in place

HEATING—

Average, \$1.90 per sq. ft. of radiation, according to conditions.

Warm air (gravity) average \$64 per register.

Forced air, average \$91 per register.

IRON—Cost of ornamental iron, cast iron, etc., depends on design.

LUMBER—All lumber at O.P.A. ceiling prices—

No. 1 Common \$49.00 per M
 No. 2 Common 47.75 per M
 Select O. P. Common 52.75 per M

Flooring—

Delvd.
 V.G.-D.F. 8 & Btr. 1 x 4 T & G Flooring..... \$80.00
 C 1 x 4 T & G Flooring..... 75.00
 D 1 x 4 T & G Flooring..... 65.00
 D.F.-S.G. 8 & Btr. 1 x 4 T & G Flooring..... 61.00
 C 1 x 4 T & G Flooring..... 59.00
 D 1 x 4 T & G Flooring..... 54.00
 Rwd. Rustic—"A" grade, medium dry..... 82.00
 3 to 20 feet
 "B" grade, medium dry..... 78.50
 6 to 20 feet

Plywood—not available

	Under \$200	Over \$200
"Plyscord"— $\frac{3}{8}$ "	\$49.50	\$47.55
"Plywall"— $\frac{1}{4}$ "	45.15	43.30
3 ply— $2\frac{1}{2}$ — $\frac{1}{4}$ "	48.55	46.60
"Plyform"— $\frac{5}{8}$ "		
Unoiled	126.50	121.45
Oiled	127.90	122.75

Above prices delivered if quantity is sufficient to warrant delivery.

Shingles (Rwd. not available)—

Red Cedar No. 1—\$6.75 per square; No. 2, \$5.75; No. 3, \$4.45.

Average cost to lay shingles, \$3.00 per square.
 Cedar Shakes—Tapered: $\frac{1}{2}$ " to $\frac{3}{4}$ " x 25"—\$8.95 per square.

Resawn: $\frac{3}{4}$ " to $1\frac{1}{4}$ " x 25"—\$10.65 per square.
 Resawn: $\frac{3}{4}$ " to $1\frac{1}{4}$ " x 25"—\$10.65 per square.
 Average cost to lay shakes, \$4.00 per square.

MILLWORK—Standard.

D. F. \$100 per 1000. R. W. Rustic \$100.00 per 1000 (delivered).

Double hung box window frames, average with trim \$6.50 and up, each.

Complete door unit, \$10.00.

Screen doors, \$3.50 each.

Patent screen windows, 25c a sq. ft.

Cases for kitchen pantries seven ft. high, per lineal ft., \$9.00 each.

Dining room cases, \$9.00 per lineal foot.

Rough and finish about 80c per sq. ft.

Labor—Rough carpentry, warehouse heavy framing (average), \$40.00 per M.

For smaller work average, \$40.00 to \$55.00 per 1000.

MARBLE—(See Dealers)

PAINTING—

Two-coat workper yard 50c
 Three-coat workper yard 70c
 Cold water painting.....per yard 10c
 Whitewashingper yard 8c

PAINTS—

Two-coat work50c per sq. yd.
 Three-coat work70c per sq. yd.
 Cold water painting.....per yard 10c
 Whitewashing 8c per sq. yd.
 Turpentine \$1.03 per gal. in drum lots.
 \$1.08 per gal. in 5-gal. containers.
 Raw Linseed Oil—not available.

Boiled Linseed Oil—\$1.38 per gal. in drums. Available only to work with high priority—\$1.48 per gal. in 5-gal. containers.

Use replacement oil—\$1.86 per gal. in 1-gal. containers.

Replacement Oil—\$1.20 per gal. in drums. \$1.30 per gal. in 5-gal. containers.

A deposit of \$6.00 required on all drums.

PATENT CHIMNEYS—

6-inch\$1.20 lineal foot
 8-inch 1.40 lineal foot
 10-inch 2.15 lineal foot
 12-inch 2.75 lineal foot

PLASTER—

Neat wall, per ton delivered in S. F. in paper bags, \$17.60.

PLASTERING (Interior)—

	Yard
3 Coats, metal lath and plaster.....	1.50
Keene cement on metal lath.....	1.80
Ceilings with $\frac{3}{4}$ hot roll channels metal lath (lathed only).....	1.20
Ceilings with $\frac{3}{4}$ hot roll channels metal lath plastered.....	2.20
Single partition $\frac{3}{4}$ channel lath 1 side (lath only).....	1.20
Single partition $\frac{3}{4}$ channel lath 2 inches thick plastered.....	3.20
4-inch double partition $\frac{3}{4}$ channel lath 2 sides (lath only).....	2.20
4-inch double partition $\frac{3}{4}$ channel lath 2 sides plastered.....	3.85
Thermax single partition; 1" channels; $2\frac{1}{4}$ " overall partition width. Plastered both sides.....	3.30
Thermax double partition; 1" channels; $4\frac{3}{8}$ " overall partition width. Plastered both sides.....	4.40
3 coats over 1" Thermax nailed to one side wood studs or joists.....	1.65
3 coats over 1" Thermax suspended to one side wood studs with spring sound isolation clip.....	1.90

Note—Channel lath controlled by limitation orders.

PLASTERING (Exterior)—

	Yard
2 coats cement finish, brick or concrete wall.....	\$1.00
3 coats cement finish, No. 18 gauge wire mesh.....	2.00
Lime—\$3.00 per bbl. at yard.	
Processed Lime—\$3.10 bbl. at yard.	
Rock or Grip Lath— $\frac{3}{8}$ "—20c per sq. yd.	
$\frac{1}{2}$ "—19c per sq. yd.	

Composition Stucco—\$1.80 to \$2.00 sq. yard (applied).

PLUMBING—

From \$100.00 per fixture up, according to grade, quantity and runs.

ROOFING—

"Standard" tar and gravel, 4 ply—\$8.00 per sq. for 30 sqs. or over.
 Less than 30 sqs. \$9.50 per sq.
 Tile, \$30.00 to \$40.00 per square.
 Redwood Shingles, \$7.50 per square in place.
 5/2 #1-16" Cedar Shingles, $4\frac{1}{2}$ " Exposure\$8.00 square

5/8 x 16"—#1 Cedar Shingles, 5" Exposure \$9.00 square
 4/2 #1-24" Royal Shingles, $7\frac{1}{2}$ " Exposure \$9.50 square
 Re-coat with Gravel \$4.00 per sq.
 Asbestos Shingles, \$23 to \$28 per sq. laid
 1/2 x 25" Resawn Cedar Shakes,
 10" Exposure \$10.50
 3/4 x 25" Resawn Cedar Shakes,
 10" Exposure 11.50
 1 x 25" Resawn Cedar Shakes,
 10" Exposure 12.50
 Above prices are for shakes in place.

SHEET METAL—

Windows—Metal, \$1.75 a sq. ft.
 Fire doors (average), including hardware \$2.00 per sq. ft.

SKYLIGHTS—(not glazed)

Copper, 90c sq. ft. (flat).
 Galvanized iron, 40c sq. ft. (flat).
 Vented hip skylights 60c sq. ft.

STEEL—STRUCTURAL—

\$150 ton (erected), this quotation is an average for comparatively small quantities. Light truss work higher. Plain beams and column work in large quantities \$140 per ton.

STEEL REINFORCING—

\$100 to \$130 ton, set.

STONE—

Granite, average, \$6.50 cu. foot in place.
 Sandstone, average Blue, \$4.00. Boise, \$3.00 sq. ft. in place.
 Indiana Limestone, \$2.80 per sq. ft. in place.

STORE FRONTS (None available).

TILE—

Ceramic Tile Floors—\$1.00 to \$1.25 per sq. ft.
 Cove Base—\$1.10 per lin. ft.
 Glazed Tile Wainscot—\$1.25 per sq. ft.
 Asphalt Tile Floor $\frac{1}{4}$ " & $\frac{3}{8}$ "—\$.18 to \$.35 per sq. ft. Light shades slightly higher.
 Cork Tile—\$.40 to \$.75 per sq. ft.
 Mosaic Floors—see dealers.
 Lino-Tile, \$.35 to \$.75 per sq. ft.

Wall Tile—

Glazed Terra Cotta Wall Units (single faced) laid in place—approximate prices:
 2 x 6 x 12.....\$1.10 sq. ft.
 4 x 6 x 12..... 1.25 sq. ft.
 2 x 8 x 16..... 1.20 sq. ft.
 4 x 8 x 16..... 1.40 sq. ft.

VENETIAN BLINDS—

40c per square foot and up. Installation extra.

WINDOWS—STEEL—

30c per square foot, \$5 for ventilators.

RADAR

(Continued from Page 39)

is automatically a measure of the range of the target. Since the speed of the beam to and from the target is always the same, then the screen can be marked off in miles or yards, and the range of the target read directly.

When a target is detected, it appears as a bright spot on the screen, from which can be read the range in miles and the operator can also ascertain the true bearing angle of the enemy ship, plane or land installation. Not only moving targets, but islands, coastlines, buoys and lighthouses are revealed by the luminous beam on the screen.

To get the relative bearing in respect to the heading of the ship, an electrically-coupled mechanism links the rotating antenna with a calibrated dial and the relative bearing of the ship with the target is read directly. If, for example, a ship is heading northeast at an angle of 45 degrees from true north and a target is located on the scope at 70 degrees

true bearing, then the relative bearing of the target with respect to the heading of the ship would be 70 degrees minus 45 degrees, or 25 degrees.

Still another indicator, electro-mechanically connected to one of the cathode-ray scopes, enables the radar operator to read the range of a target on a gauge. If, for example, the target is a fast-approaching plane, the operator by turning a handwheel in synchronization with the cathode-ray scope can "track" the plane mile by mile as it nears the detection system.

If the target is an airplane, the radar unit will give angle of elevation and slant range of the craft. This is possible because the angle at which the antenna is tilted when a flying target is located exactly duplicates the angle of elevation of the aircraft. Similarly, the exact distance from the antenna to the target is a measure of the time it takes the beam to reach the plane and return. Since this speed is constant, it is read from indicators in terms of yards or miles.

(To be continued next month)

BUILDING TRADES WAGE (JOB SITES) NORTHERN AND CENTRAL CALIFORNIA

ATTENTION: The following are the PREVAILING hourly rates of compensation as determined by the Wage Adjustment Board, or which have been determined by the United States Department of Labor—Revised to July 1, 1946. Wage scales shown are those being paid and in effect mostly by agreement between employees and their union.

CRAFT	San Francisco	Alameda and Contra Costa	Marin	Vallejo	San Mateo	San Jose	Stockton	Sacramento	Fresno
ASBESTOS WORKERS.....	1.75	1.75	1.75	1.75	1.75	1.75	1.75	1.75	1.75
BRICKLAYERS.....	2.05	2.05	2.05	2.05	2.05	2.05	1.75	2.05	2.00
BRICKLAYERS, HODCARRIERS.....	1.57½	1.57½	1.57½	1.57½	1.57½	1.57½	1.47½	1.15	1.25
CARPENTERS.....	1.75	1.75	1.75	1.75	1.75	1.75	1.50	1.50	1.50
CEMENT FINISHERS.....	1.75	1.75	1.75	1.75	1.75	1.75	1.75	1.75	1.75
ELECTRICIANS.....	1.87½	1.87½	1.87½	1.70	1.87½	1.87½	1.75	1.82½	1.75
ENGINEERS: MATERIAL HOIST.....	1.60	1.60	1.60	1.60	1.60	1.60	1.60	1.60	1.60
ENGINEERS: PILE DRIVER.....	2.00	2.00	2.00	2.00	2.00	2.00	2.00	2.00	2.00
ENGINEERS: STRUCTURAL STEEL.....	2.00	2.00	2.00	2.00	2.00	2.00	2.00	2.00	2.00
GLASS WORKERS.....	1.58½	1.58½	1.58½	1.58½	1.58½	1.21	1.40	1.37½	1.37½
IRONWORKERS: ORNAMENTAL.....	1.85	1.85	1.85	1.85	1.85	1.85	1.85	1.85	1.85
IRONWORKERS: REINF. RODMEN.....	1.75	1.75	1.75	1.75	1.75	1.75	1.75	1.75	1.75
IRONWORKERS: STRUCTURAL.....	2.00	2.00	2.00	2.00	2.00	2.00	2.00	2.00	2.00
LABORERS: BUILDING & CONCRETE.....	1.25	1.25	1.15	1.15	1.15	1.15	1.25	1.25	1.15
LATHERS.....	1.90	1.90	1.60	1.87½	1.75	2.00	1.87½	1.60	1.87½
MARBLE SETTERS.....	1.75	1.75	1.75	1.75	1.75	1.75	1.75	1.75	1.75
MOSAIC & TERRAZZO.....	1.75	1.75	1.75	1.75	1.75	1.75	1.60	1.16	1.12½
PAINTERS.....	1.75	1.75	1.75	1.64	1.75	1.75	1.60	1.60	1.50
PILEDRIVERS.....	1.86	1.86	1.86	1.86	1.86	1.86	1.86	1.86	1.86
PLASTERERS.....	2.00	2.00	1.75	2.00	2.05	2.00	2.00	1.87½	1.87½
PLASTERERS' HODCARRIERS.....	1.75	1.75	1.75	1.75	1.75	1.75	1.65	1.65	1.40
PLUMBERS.....	1.87½	1.87½	1.87½	1.87½	1.87½	1.87½	1.87½	1.87½	1.87½
ROOFERS.....	1.50	1.62½	1.50	1.62½	1.25	1.37½	1.50	1.50	1.50
SHEET METAL WORKERS.....	1.75	1.75	1.75	1.75	1.75	1.75	1.75	1.75	1.75
SPRINKLER FITTERS.....	1.58	1.58	1.58	1.58	1.58	1.58	1.58	1.58	1.58
STEAMFITTERS.....	1.87½	1.87½	1.87½	1.87½	1.87½	1.87½	1.87½	1.87½	1.87½
STONESETTERS (MASONS).....	2.05	2.05	2.05	2.05	2.05	2.05	1.75	2.05	2.00
FILESETTERS.....	1.80	1.75	1.75	1.75	1.75	1.75	1.37½	1.37½	1.37½

Prepared and compiled by

CENTRAL CALIFORNIA CHAPTER, ASSOCIATED GENERAL CONTRACTORS OF AMERICA

with the assistance and cooperation of secretaries of General Contractors Associations and Builders Exchanges of Northern California.

CLASSIFIED ADVERTISING

RATE: 8c PER WORD . . . CASH WITH ORDER

MINIMUM \$1.50 (3 Lines)

ARCHITECT'S REPORTS—A valuable advance news service giving building and construction information daily on projects in Northern California. Name, location, architect, proposed cost, etc., on individual slips. Deal for securing new business leads. Hundreds of items, total monthly cost only \$10. Don't delay, subscribe today. **ARCHITECT**

& **ENGINEER**, Room 618, 68 Post Street, San Francisco, California. Phone DOuglas 8311.

PHOTOGRAPHY—Keep a pictorial record of your building, or construction project. Pictures are of tremendous value to contractors, builders, engineers, architects. For Industrial-Publicity-Aerial photography, see

FRED MAE, Room 721-22 Hearst Bldg., San Francisco 3, California.

ARCHITECTS—A. McF. McSweeney, Architect, Room 927 Hearst Bldg., San Francisco. New offices. Desires catalogs.

PRINTING—Printers, bookbinders. See us for commercial printing. Mercury Press, 942 Howard Street, San Francisco.

IN THE NEWS

PLUMBING TRAP APPROVED BY NEW YORK CITY BOARD

The New York City Board of Standards and Appeals recently approved the newly designed Kwiklean Sanitary Plumbing Trap which is manufactured by the Bethlehem Industrial Corporation of New York.

CLINTON CONSTRUCTION CO. OF CALIFORNIA

General Contractors

923 FOLSOM STREET • SAN FRANCISCO
SUtter 3440

HOGAN LUMBER CO.

Wholesale and Retail

LUMBER

MILL WORK • SASH & DOORS

Office, Mill, Yard and Docks
SECOND AND ALICE STREETS • OAKLAND, CALIF.
Telephone GLencourt 6861

SANTA MARIA INN

SANTA MARIA, CALIFORNIA

FRANK J. MCCOY, General Manager
FERNAND E. PIMENTEL, Manager

On the
Coast
Highway
between
San
Francisco
and
Los
Angeles



American
or
European
Plan
•
Old
English
Tap
Room

Embodying several changes from the conventional type trap, Kwiklean is being manufactured in the "P" type as illustrated, and will later be

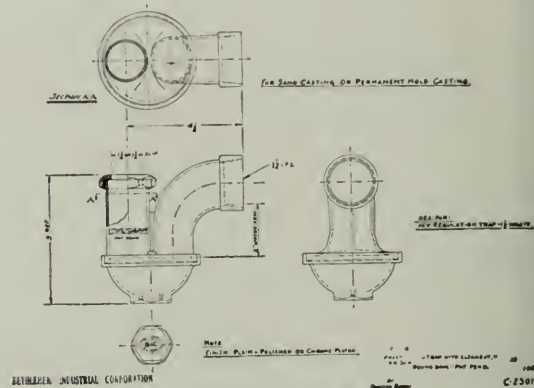

TWIKLEAN Plumbing Trap

available in a combination sink and tray model which will be particularly advantageous where dishwashing machines and garbage disposal units are installed.

Made of brass castings, precision machined with heavy chrome-plate finish, Kwiklean products will be given national distribution through jobbers to the plumbing and hardware trade.

APPOINTED DISTRIBUTOR

The firm of Fowler & Jewell of Los Angeles, California, has been named Pacific Coast representative for the Koiled Kord division of Kellogg Switchboard and Supply Company of Chicago.

Products include a line of patented rubber covered electric cord sets permanently moulded in a spiral shape.

POPE & BURTON, Architects, have moved to 11310 Burnham, Los Angeles, California.

CLYDE W. WOODS, Civil Engineer, has moved to P. O. Box 620, North Hollywood, California.

BOOK REVIEWS

PLANNING YOUR HOME FOR BETTER LIVING
 . . . Electrically. General Electric Company,
 Bridgeport, Conn. Price 25 cents per copy.

A 64-page, profusely illustrated, full-color publication for people who are thinking seriously of building or remodeling a house. Covers kitchens, laundries, lighting, wiring, electronics, heating and air conditioning.

ALLOYS, Catalog D-2. Alloy Metal Wire Company, Inc., Prospect Park, Penn.

A new catalog D-2, issued by the Alloy Metal Wire Company of Prospect Park, Penn., contains sizes, weights, tolerances and other information helpful in writing specifications and ordering. Includes many illustrations and tables on wire, rod, strip used in springs, wire cloth fastenings, paper mills, jewelry, mechanical and electrical application.

MANUAL OF DESIGN FOR ARC WELDED STEEL STRUCTURES. Air Reduction Sales Company, Dept. MD, 60 East 42nd Street, New York City 17. Price, \$2.00.

A 300-page definitive book compiled by LeMotte Grover, M., Am. Soc. C. E., widely recognized in the field of structural welding. Covers fundamentals of design, materials, inspection, estimating and engineering control of welding and related operations.

Pointed, concise, and complete the Manual is based upon standards of the American Welding Society, the American Institute of Steel Construction, and on reports of the Welding Research Council of the Engineering Foundation.

ENDURING SANITATION WITH HOSPITAL EQUIPMENT. Republic Steel Corporation, Cleveland 4, Ohio.

Well illustrated two-color booklet, "Enduring Sanitation With Hospital Equipment of Republic Enduro Stainless Steel," just issued by the Republic Steel Corporation of Cleveland, Ohio. Describes in detail use of stainless steel in modern hospitals, care and cleaning. Includes section on architectural applications.

E. F. Seagrave, for many years associated with the Paraffine Companies, Inc., and recently central district sales manager, has entered the building materials distribution field with general offices in Reno, Nevada.

PACIFIC MANUFACTURING CO.

HIGH CLASS INTERIOR FINISH
 QUALITY MILLWORK

142 SANSOME ST., SAN FRANCISCO
 Garfield 7755

6820 McKINLEY AVE., LOS ANGELES
 THornwall 4196

BUILDERS EXCHANGE, OAKLAND

"AMERICAN - MARSH" CONDENSATION UNIT

Pumping
 Machinery
 for
 Every
 Purpose

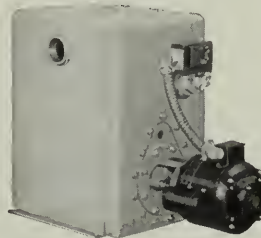

For Service
 Call
 DOuglas
 6794
 or
 MUtual 8322

SIMONDS MACHINERY CO.
 SAN FRANCISCO 816 FOLSOM
 LOS ANGELES 455 EAST 4TH

VERMONT MARBLE COMPANY

Producers and Finishers
 of
 Domestic and Imported Marbles

Write for new pamphlet describing our
 Marble Toilets and Showers
 San Francisco and Los Angeles
 San Francisco phone: Sutter 6747



The Most Complete Line of
 STEELS and BUILDING MATERIALS
 Made by a Single Producer



See Sweet's Catalog File or write us for
 full information.

REPUBLIC STEEL CORPORATION
 GENERAL OFFICES: CLEVELAND, OHIO

DENVER, COLORADO CONTINENTAL OIL BUILDING
 LOS ANGELES, CALIFORNIA EDISON BUILDING
 SALT LAKE CITY, UTAH WALKER BANK BUILDING
 SAN FRANCISCO, CALIFORNIA RIALTO BUILDING
 SEATTLE, WASH. WHITE-HENRY-STUART BUILDING

Real Estate Loans



F H A loans are readily available on existing homes up to 80% of the appraised value. You can buy a home and pay for it in small monthly installments like rent. For example, a 20-year loan of \$6000 would cost about \$49.56 per month, including taxes, insurance, principal and interest.

*Come in and talk with us
We can help you get the home
you want*

CROCKER FIRST NATIONAL BANK
OF SAN FRANCISCO
California's Oldest National Bank
ONE MONTGOMERY STREET
Member Federal Deposit Insurance Corporation

Venetian Blinds

of

Metal or Wood

for

Homes and Offices

Installed and Serviced

by

GUNN CARLE & CO.

20 POTRERO AVENUE

SAN FRANCISCO 3

Underhill 5480

IN THE NEWS

GENERAL ARMSTRONG

Brigadier General Donald Armstrong has joined the staff of the American Standards Association, following his retirement from the U. S. Army after 36 years of outstanding service.

THRUSH FLOW VALVE

Streamline in design with a positive method of controlling circulation on a hot water heating system to improve room temperature control, this new THRUSH FLOW CONTROL VALVE has been developed by the H. A. Thrush & Company of Peru, Indiana.

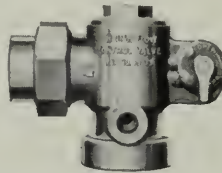

An exclusive feature of the valve is the opening provided beneath the seat to direct the air and gases to the Thrush Pressure Tank before they are circulated in the system, thus permitting the selection of as many different temperature zones as are required.

CHINA BOUND

Fred O. Jones, Chief geologist for the U. S. Bureau of Reclamation's Columbia River Basin Project, has signed a contract to supervise geological investigations for the Chinese Government's giant Yangtze Gorge Dam. He is a graduate of the Colorado State College, 1933.

PLASTIC ROOF PAINT

A plastic roof paint which provides exceptional protection from fire, termites and the weather, has been placed on the market by the SENTRY PRODUCTS CORP'N, Inglewood, California.

ELECTRIC EYE THERMOSTAT

A new era in the temperature control field is introduced by the TEMPMASER THERMOSTAT, a product of the CROWN CONTROLS COMPANY of New Bremen, Ohio.

Use of the "electric eye" signal gives a true picture of damper position at all times. It is compact and manufacturer guaranteed.

Civilian employment in California reached an estimated total of 3,338,000 in June, 52,000 more than in May, and a new high for 1946.

ANDERSON & SIMONDS, Architects, have moved from 339 15th Street, Oakland, to 2800 Park Blvd., same city.

J. EARL TRUDEAU, Architect has moved to 317 W. Main Street, Alhambra, California.

Scott Company

HEATING . . . PLUMBING . . . TILE



243 MINNA STREET

SAN FRANCISCO

Phone EXbrook 6741

KYLE FORREST

Civil Engineer

Water Supply — Sanitation

Municipal — Private
Consultations — Investigations
Reports — Designs — Valuations
Supervision — Litigation

Ground Water Work a Specialty

Hydrologic studies — wells, de-watering, underdrainage, foundations, conservation, testimony.

1504 Russ Building

San Francisco 4

YUkon 0652

ELMER F. STEIGELMAN

CIVIL ENGINEER

Structural Design,

Surveying and

Subdivisions

577 FOURTEENTH STREET

OAKLAND, CALIFORNIA

TWinoaks: 4191

THE TORMEY COMPANY

GENERAL PAINTERS
AND DECORATORS

Phone UNderhill 1913

563 FULTON STREET
San Francisco

IN THE NEWS

REORGANIZED

Ernest J. Kump, A.I.A. Architect, and Mark Falk, Structural Engineer, have announced the return of their former partner, Lt. Col. Charles H. Franklin, AUS, Corps of Engineers, and the formation of the firm of FRANKLIN, KUMP & FALK.

Offices for the practice of Architecture and Engineering will be located at 9 Main Street, San Francisco, California.



HERRICK IRON WORKS

STRUCTURAL STEEL
REINFORCING STEEL

18TH AND CAMPBELL STS.
OAKLAND, CALIF.
Phone GLencourt 1767

G. P. W.
JENSEN & SON

Building Construction

320 Market Street, San Francisco
Phone: GARfield 2444

MAGNI-FOCUSER EYE LOUPES

This new instrument, manufactured by the EDROY PRODUCTS CO., New York, incorporates all of the quality and optical advantages of the regular MAGNI-FOCUSER used in many trades, professions, hobbies, and other types of precision work.



In addition it has the advantage of a hi-power auxiliary lens which drops down in front of one eye to provide extra magnification when needed. When not in use it flips up out of the way.

Initial production will be in focal lengths from 14" to 8" and from 4" to 2", and will be designated Models 13, 15, 17, according to power of the lens.

AMERCOAT COATING COMPARISON CHART

A comprehensive 8-page technical bulletin, giving complete factual, condensed, information on the AMERCOAT line, has just been published by the AMERICAN PIPE & CONSTRUCTION CO., of Los Angeles, California.

Chart shows characteristics and properties of Amercoat plastic coatings and is a ready guide for application methods on steel, concrete and wood.

A downturn of California employment is forecast for October because of usual seasonal declines in crop harvesting and in food manufacturing.

Phone GARfield 1164

Thomas B. Hunter

Consulting Engineer

DESIGNER OF HEATING
AIR CONDITIONING
VENTILATING AND WIRING
SYSTEMS, MECHANICAL
AND ELECTRICAL EQUIP-
MENT OF BUILDINGS

41 SUTTER STREET
ROOM 710
San Francisco California

Basalt Rock Co., Inc.

Ready Mixed Concrete

Building Materials

Basalite Products

SIXTH & BERRY STREETS
SAN FRANCISCO
PHONE: GARFIELD 3758

ANDERSON & RINGROSE

General Contractors

320 Market Street, San Francisco
Phone GARfield 2245

MULLEN MFG. COMPANY

BANK, STORE AND OFFICE
FIXTURES—CABINET WORK
OF GUARANTEED QUALITY
CHURCH SEATING

Office and Factory:
60-80 RAUSCH ST., Bet. 7th and 8th Sts.
San Francisco
Telephone UNderhill 5815

DINWIDDIE CONSTRUCTION COMPANY

BUILDERS

CROCKER BUILDING
SAN FRANCISCO

A. F. MATTOCK CO.

Builders

★

212 CLARA STREET
SAN FRANCISCO

INDEPENDENT IRON WORKS

Steel Buildings
Service Stations
Steel Storage Tanks
Fabricated Plate Work
Steel & Sheet Metal Products
Fabricated Structural Steel
Steel Distributors

Eighth & Pine Sts. Oakland, 7

George F. Brayer

ELECTRICAL
CONTRACTOR

166 Seventh Street
San Francisco

Phone: MArket 1761

PITTSBURGH TESTING LABORATORY

Successors to
SMITH, EMERY & COMPANY

Testing and Inspecting
Engineers and Chemists

Structural Materials, Structures
Equipment, Pipe, Soils.

651 Howard St., San Francisco 5
EXbrook 1747

Index to Advertisers

ALADDIN Heating Corp.....	48
ANDERSON & Ringrose.....	47
ARCHITECTS Reports	40
ARCHITECT & ENGINEER.....	6
BASALT Rock Company, Napa	39
BASALT Rock Company, San Francisco	47
BAXTER & Company, J. H.....	34
BRAYER, Geo. F.....	48
CLARK, N., & Son.....	*
CLASSIFIED Advertising	43
CLINTON Construction Company.....	44
COLUMBIA Steel Co.....	*
CROCKER First National Bank.....	46
DINWIDDIE Construction Company..	47
FORDERER Cornice Works.....	39
FORREST, Kyle	46
FULLER, W. P., Co.....	5
GUNN, Carle & Company.....	46
HANKS, Inc., Abbot A.....	48
HAWES Drinking Faucet Company.....	Back Cover
HERRICK Iron Works.....	47
HOGAN Lumber Company.....	44
HUNT, Robert W., Company.....	48
HUNTER, Thos. B.....	47
IMPERIAL Brass Manufacturing Co.....	*
INDEPENDENT Iron Works.....	48
JENSEN & Son, G. P. W.....	47
JOHNSON Company, S. T.....	*
JUDSON, Pacific-Murphy Corp.....	39
KRAFTILE Company	32
KAWNEER Company	*
MATTOCK, A. F.....	48
MULLEN Mfg. Co.....	47
MUELLER Brass Co.....	2
NORTHERN California Electrical Bureau	35
PACIFIC Coast Gas Association.....	Inside Back Cover
PACIFIC Manufacturing Company.....	45
PACIFIC Portland Cement Company	1
PACIFIC Telephone & Telegraph Co.	33
PARAMOUNT Built-in Fixture Co.....	*
PAYNE Furnace & Supply Co., Inc.....	*
PITTSBURGH Testing Laboratory.....	48
PORTLAND Cement Association.....	*
REMILLARD-Dandini Co.	48
REPUBLIC Steel Corporation.....	45
SANTA Maria Inn.....	44
SCOTT Co.	46
SIMONDS Machinery Company.....	45
SISALKRAFT Company	39
SMOOT-Holman Co.	37
STANLEY Works, The.....	30
STEIGELMAN, Elmer F.....	46
SOULE Steel Co.....	*
TAYLOR Co., Halsey W.....	*
TIMBER Engineering Co., Inc.....	*
TORMEY Company, The.....	47
UTILITY Appliance Corp.....	*
U. S. STEEL.....	*
U. S. BONDS.....	6
VERMONT Marble Company.....	45
WESIX Electric Heater Co.....	*
WESTERN Asbestos Company.....	*
WOOD, E. K., Lumber Company.....	Inside Front Cover
	36

* Indicates Alternate Months

Robert W. Hunt Company

ENGINEERS

Inspection • Tests • Consultation

Schools and Other Structures
Are Built as Designed

*When Construction Materials are
Inspected at point of Manufacture
and during Erection by*

ROBERT W. HUNT COMPANY

*Cement, Concrete, Chemical, Metallurgical,
X-Ray and Physical Laboratories*

Chicago - New York - Pittsburgh
Los Angeles - All Large Cities
San Francisco, 251 Kearny Street

REMILLARD-DANDINI Co.

Brick and
Masonry Products

★

633 BRYANT ST., SAN FRANCISCO
569 THIRD ST., OAKLAND

ALADDIN Heating Corp.

Specializing in
QUALITY HEATING
EQUIPMENT

2222 San Pablo Avenue
OAKLAND
TWinoaks 1022

ABBOT A. HANKS, INC. Engineers & Chemists

INSPECTING — TESTING — CONSULTING
CONCRETE • STEEL • MATERIALS
CHEMICAL AND TESTING
LABORATORIES
• RESEARCH AND INVESTIGATION •

TESTS OF STRUCTURAL MATERIALS
DESIGN OF CONCRETE MIXES
SHOP AND ERECTION INSPECTION OF
STRUCTURES AND EQUIPMENT
INVESTIGATION OF STRUCTURES
AND MATERIALS
TESTS AND INVESTIGATION OF
FOUNDATION SOILS
FIRE RESISTANCE AND INSULATION
TESTS

624 Sacramento Street, San Francisco

ARCHITECT AND ENGINEER

ADOBE HOUSES



OCTOBER

1946

FIXTURE-FINISHING FOREMEN can't play hunches!

Fuller Finishes help them keep fast production on the profit side



It's a tough, fast-stepping business—fixture finishing! Every contract different, exacting, in a hurry! Whether it's counters, bars, desks, display cases, tables, shelving, rails, wainscoting, stands, cabinets or special furnishings, Mr. Foreman's got to *know in advance* that he can come up with the decorative effect specified on any wood, metal, composition or plastic; move fast enough to avoid tying up his shop, and complete the job on the profit side.

Fixture Finishing is another spe-

cialty field where Fuller's laboratory cooperation pays; where Fuller's man-on-your-job contact helps keep fast production on schedule, and profitable.

It's as true in other fields Fuller serves. Every Fuller formulation is job-tested for correct application and use-proved for unquestioned service—in your plant, on your equipment, in or on your business building or in or on your home.

W. P. Fuller & Co. Factories, San Francisco, Los Angeles, Portland. Branches, warehouses in principal Western cities.

FULLER
Industrial **FINISHES**



PRODUCTION FINISHES

Fuller Industrial Finishes do double duty: Meet production demands; give products durability and sales appeal.

MAINTENANCE FINISHES

Whatever the surface, there's a Fuller product exactly formulated to protect it or beautify it.

AIRCRAFT FINISHES

War-improved, flight-famed Fuller Aircraft Finishes now available for private plane use. See your Airport Refinisher.

ARCHITECT

Vol. 167

No. 1

AND ENGINEER

ARCHITECTS' REPORTS—Published Daily
Telephone DOuglas 8311

E. H. WILDER
Editor

MARK DANIELS, A.I.A.
Associate Editor

JOHN S. BOLLES, A.I.A.
Book Reviews

MICHAEL GOODMAN
Post-War Planning

L. H. NISHKIAN
Consulting Editor

E. N. KIERULFF*
Ass't Editor
*In the Service



Contents for

OCTOBER

COVER: KEMPER CAMPBELL RANCH—Front Terrace Overlooking Mojave River
(See Page 21)

ARTICLES AND MISCELLANEOUS TEXT

EDITORIAL NOTES	4
NEWS AND COMMENT ON ART	6, 7, 8, 9
WINDOW BOXES	10
By ALBERT WILSON, Botanist and Garden Consultant	
ADOBE HOUSES	12
By JOHN WINFORD BYERS, A.I.A.	
AIRPORT CONVERSION PROJECT	26
By FREDERICK K. DuPUY, Airport Engineer	
IN THE NEWS	37, 43, 46, 47
A. I. A. ACTIVITIES	31
WITH THE ENGINEERS	32
KRAFTILE COMPANY INAUGURATES Packaged Stran-Steel Framing	34
HEADLINE NEWS AND VIEWS	36
By E. H. W.	
PRODUCERS COUNCIL PAGE	38
Edited by CHAS. W. KRAFT	
ESTIMATORS GUIDE, Building and Construction Materials	41
BUILDING TRADES WAGE SCALE, Northern and Central California	43
CLASSIFIED ADVERTISING	43
BOOK REVIEWS, Pamphlets and Catalogues	45
INDEX TO ADVERTISERS	48

ARCHITECT AND ENGINEER (Established 1905) is published on the 15th of the month by The Architect and Engineer, Inc., 68 Post St., San Francisco 4; Telephone EXbrook 82. President, K. P. Kierulff; Vice-President and Manager, L. B. Penhorwood; Treasurer, E. N. Kierulff. Los Angeles Office: Wentworth F. Green, 6605 Hollywood Blvd., Los Angeles 28, Telephone HEmpstead 3171.

Registered as second class matter, November 2, 1905, at the Post Office in San Francisco, California, under the Act of March 3, 1879. Subscriptions United States and Panama, \$3.00 a year; \$5.00 two years; foreign countries \$5.00 a year; single copy 50c. ARCHITECTS' REPORTS are published daily from this office, Vernon S. Yallop, Manager.



BUILDING CODES

When a city, county, or state desire to enact legislation for the establishment, or revision, of perhaps out-dated building codes the job can become complicated or simple.

Complicated if those in charge of adopting a building code attempt to set themselves up as "experts" and write into ordinance, or law, non-professional interpretations of Architectural, Engineering and Construction principles.

Simple if the beginning point of consideration is the UNIFORM BUILDING CODE, plus the professional suggestions of experienced Architects, Engineers, and Contractors.

* * *

THE TWENTIETH-CENTURY ARCHITECT

William W. Wurster, A. I. A., writing for "Architecture, a Profession and a Career," official document of the American Institute of Architects, says:

"The task of the true architect has always included more than structural dimensions. There has never been a time when a building was an isolated phenomenon shorn of its relationship with the community's social and economic needs. It is true this broad concept has not always been fulfilled and at times it has even been obscured as the goal. The difference between the twentieth-century architect and his predecessor is possibly the very attempt by today's group to keep this goal in sight.

"Architecture does truly mirror change, and changing conditions force upon us a recognition of their presence. Architecture, the art and science of building, offers solutions that must meet these changing conditions and satisfy them. . . . This is all well illustrated by the success of free contemporary architecture on the West Coast, . . . There are numerous architects who have not consciously used an eclectic form for many years. It was fortunate that the climate, the new taste for outdoor living, and an informal society freed clients from rigid preconceptions.

"Architecture, including all its techniques and aesthetics, has been called a 'social art,' which implies that it should not be solely the self-expression of the architect. . . . A test of the true architect is whether he is serving the best interests of the client, and not imposing whims of his own.

"All of this sums up to the fact that when buildings are built which boldly meet the needs—physical, economic, and social, as well as aesthetic—we then have a great period. Such can never come when we follow the forms of the past and try to fit them to the content of today. Our twen-

tieth-century architect is prepared to meet the challenge of these human needs. In this talent and this kind of thinking lies the hope of a truly great period of our own."

* * *

GOOD ADVICE

Vincent Palmer, A. I. A., Architect of Los Angeles, recently told members of the Northern California Chapter, A. I. A., "Young architects owe it to their profession, as well as to themselves, to become a part of, and take an active interest in the activities of their local A.I.A. chapter; while the older architects have the same responsibility, because through their experience they can contribute much and at the same time learn a lot from the younger men."

Architect Palmer's remarks contain a great deal of truth, and with numerous problems confronting the architectural profession, any one engaged in the practice of Architecture can well afford to devote a certain amount of time, thought and effort to the A.I.A.—local and national program.

* * *

LITTLE CONSOLATION!

A magic word throughout the civilized world of today is . . . AMERICA—A great nation representative of a people whose tremendous war and civil production capacities not only surprised Hitler and Tojo, but were a major factor in turning back their bid for world mastery. AMERICA the great is now staggering under war-won peacetime conditions.

National harmony and traditional tranquility which made AMERICA a magic word, has been replaced with pitched battles between competitive labor organizations seeking the "right" to "strike" against business and industry.

Highly organized, nation wide strikes against management, against governmental representatives, against constitutionally established judicial agencies; together with vast organizations within government which are steeped in party tradition, inefficiency, and red tape have replaced the recent war-era of economic progress.

The "experts" say this is "an adjustment period," that "things will level off," and that once again AMERICA will exemplify the coordinated forces of labor and industry which reached such a high degree of perfection during World War II.

In the meantime, the only consolation seems to be that everyone in AMERICA is in the same fix . . . high taxes, high costs, high handed UN-American tactics.

America finds a new, easy way to save

OUT of the war has come one blessing—a lesson in thrift for millions of those who never before had learned to save.

Enrolled under the Payroll Savings Plan in thousands of factories, offices, and stores, over 27 million American wage earners were purchasing "E" Bonds alone at the rate of about 6 billion dollars worth a year by the time V-J Day arrived.

With War Bond Savings automatically deducted from their wages every week, thrift was "painless" to these wage earners. At the end of the war, many who never before had bank accounts could scarcely believe the savings they held.

The moral was plain to most. Here was a new, easy way to save; one as well suited to the future as to the past. Result: Today, millions of Americans are continuing to buy, through their Payroll Savings Plan, not War Bonds, but their peacetime equivalent—*U. S. Savings Bonds*.

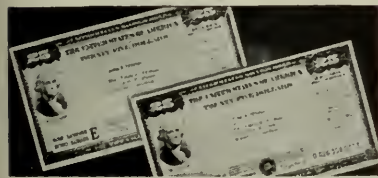

From war to peace! War Bonds are now known as U. S. Savings Bonds, bring the same high return—\$25 for every \$18.75 at maturity.



Out of pay—into nest eggs! A wage earner can choose his own figure, have it deducted regularly from earnings under Payroll Savings Plan.



New homes to own! Thousands of new homes, like this, will be partially paid for through Bonds wisely accumulated during the next five to ten years.



Keeping cost of living in check! Buying only needed plentiful goods and saving the money which would bid up prices of scarce goods keeps your cost of living from rising. Save automatically—regularly.

Weekly Savings	SAVINGS AND INTEREST ACCUMULATED	
	In 1 Year	In 10 Years
\$ 2.75	\$195.00	\$2,162.45
6.25	225.00	2,607.54
7.50	300.00	4,229.02
9.28	487.76	5,416.97
12.50	650.00	7,217.20
15.00	780.00	8,460.42
18.75	975.00	10,828.74

Savings chart. Plan above shows how even modest weekly savings can grow into big figures. Moral: Join your Payroll Savings Plan next payday.

SAVE THE EASY WAY...
BUY YOUR BONDS
THROUGH PAYROLL SAVINGS

*Contributed by this magazine in co-operation
with the Magazine Publishers of America as a public service.*



NEWS AND COMMENT ON ART

CALIFORNIA SCHOOL OF FINE ARTS

Association Member John R. Baxter has been selected 1946 winner of the James D. Phelan Award in Sculpture. Robert J. Furrer, former student at the California School of Fine Arts, has been appointed alternate.

* * *

CLAIRE FLAKENSTEIN has returned from a six-weeks East-Coast trip where she spent some time in photographing New England Architecture, viewing the primitive collections of the Brooklyn Museum, and inspecting contemporary work shown at the Phillips Memorial Gallery in Washington, D.C.

She has been commissioned to design the decor and costume for Mary O'Donnell's Broadway dance concert next spring (they will be exhibited within the next few months at the Architectural League in New York). Designing of the format and dance movement vignettes for a piano work, "Theme and Variations" by the young American composer Ray Green, is another commission received while East.

* * *

66th ANNUAL Exhibition of Painting and Sculpture awards have been announced by the Art Association.

Those offered in former annuals and listed again

PAINTING



An interesting piece of work by **MARILYN MILLER**, student at the California School of Fine Arts in San Francisco

for this year are the Anne Bremer Memorial Prize for painting (which has been raised from \$200 to \$300), the Emanuel Walter Purchase Prize of \$300, the Anna Elizabeth Klumpke Prize of \$250 for portrait or figure painting, the Artists' Fund Prize and Edgar Walter Memorial Prize for sculpture, both for the amount of \$50, and the Museum Purchase Prize.

In addition to these regular awards, four new ones are being offered: the \$500 S.F.A.A. Special Prize for the most distinguished work in the show; a \$250 award for painting, open only to members of the Association, donated anonymously; the \$100 William I. Gerstle Prize for figure composition in painting; and a second \$100 award by an anonymous donor for painting, open to members and non-members alike. Dates for the exhibition are October 10 to November 3.

M. H. DE YOUNG MEMORIAL MUSEUM — San Francisco

October activities scheduled for the M. H. De-Young Memorial Museum, Golden Gate Park, San Francisco, as announced by Dr. Walter Heil, director, include:

Exhibitions—

LE THEATRE DE LA MODE; CONTEMPORARY ECCLESIASTICAL ART, FRENCH; FRENCH RE-

VIEWS AND MAGAZINES (closing October 20).
VICTORIAN APPAREL (opening October 1).

Courses and Lectures—

PAINTING FOR PLEASURE: A course for adults who have never drawn before or for those who wish a condensed review of the basic devices of art. Conducted by Charles Lindstrom.

A studio class for those who have completed the first course or who are already competent amateur painters will continue at the same hour. Conducted by Miriam Sweeney.

Children's Classes—

Classes in drawing, painting and clay modeling for children from 5 to 10 years. Saturday mornings from 10:30 to 11:30.

Class in drawing and sketching for children from 10 to 15 years. Saturday afternoons at 2:00. Children's Classes conducted by Miriam Sweeney.

Library—

Open daily from 10:00 to 5:00. Closed on Sundays.

SAN FRANCISCO MUSEUM OF ART

The Women's Board are planning a Rental Gallery, under the direction of Mrs. Drew Chidester, Chairman of the Gallery; Mr. William Gaw, Chairman of the Artists Committee, and Dr. Grace L. McCann Morley, Advisor.

Painting and sculpture are offered for individuals to take home for a maximum time of three months.

For the time being the Rental Gallery is limited to members of the Museum and the Art Association.

* * *

CURRENT EXHIBITIONS

Selected Latin American Drawings, an exhibition assembled by the Council of Inter-American Cooperation in New York under a grant from the Department of State, represents about 40 artists with much of the material never having been shown before.

ACTIVITIES

"Museum Thursdays," a series of art talks followed by general discussions, arranged by the WOMEN'S BOARD.

Children's Saturday morning art sessions, ages 6 to 14, conducted by Nora Lee Rohr and assistants, 10 to 11:30 a.m.

Studio Workshop and Sketch Club, Wednesday and Friday, respectively, conducted by George Harris, 7:30 to 9:30 p.m.

Gallery Talks by members of the staff on current exhibitions each Sunday at 3:30 p.m.

CALIFORNIA PALACE OF THE LEGION OF HONOR

Leah Rinne Hamilton, whose exhibition of paintings opened at the California Palace of the Legion of Honor, October 11, is a San Franciscan whose work has won numerous prizes in exhibitions of local artists during the past five years. In the San Francisco Art Association Annuals she has won the Anne Bremer and Artist Fund prizes and has received many other awards. In addition to local exhibitions she has also exhibited at the Carnegie Institute in Pittsburgh, the Art Institute of Chicago, the Corcoran Art Gallery in Washington, D. C., and in many museums throughout California.

Mrs. Hamilton's subject matter deals primarily with landscapes, but her scenes are abstracted and stylized into magnificent patterns of color and light.

Also at the California Palace of the Legion of Honor is an exhibition of paintings by August Mosca, a winner of one of the silver medals in the Legion's First Spring Annual held last April.

Mr. Mosca was born in Naples in 1909, and at an early age was brought to America. In 1924 he attended the Yale School of Fine Arts. Two years later he went to New York City in order to study at the Art Students' League. In 1932 and 1933 he traveled in Europe, studying the old masters, later studying the work of Picasso, Braque, Mondrian and Stella. Mr. Mosca has participated in the following national exhibitions: 1943, 117th Annual Exhibition—National Academy, New York; 1944, First Annual Pepsi-Cola Show, "Portrait of America"; 1944, Tomorrow's Masterpieces; and 1946, First Spring Annual Exhibition—California Palace of the Legion of Honor. He has had many one-man shows throughout the East.

"The Modern Imagination," a free course of lectures for adults, by Dr. Jermayne MacAgy, at the California Palace of the Legion of Honor, began October 2. The course provides an analysis of the ways that contemporary painters produce their pictures. Public invited.

PORTLAND ART MUSEUM

Regular students at the Museum Art School have resumed their fall class schedules with enrollment reaching maximum capacity in both advanced and beginner classes.

Evening classes are being offered under joint sponsorship with the Portland Extension Center and represent about 240 students.

Saturday children's classes for students 7 to 17 years have been resumed.

The Sunday afternoon concerts have been re-

(Continued on Page 9)



1st PRIZE PRINTED TEXTILES won by Virginia Ball Hendershot; screen textiles. The white wool rug shown is by Kamma Zethraus and received honorable mention.

5th ANNUAL PACIFIC COAST TEXTILE EXHIBITION
Art-in-Action Shop • City of Paris

FIRST AWARD won by Constance Tydeman; woven textiles showing gold table cloth in metal and rayon.



PORTLAND ART MUSEUM

(Continued from Page 7)

sumed following the usual summer vacation. Held in the Art Museum each Sunday afternoon at 3 o'clock, under the direction of Henri Arcand, October's schedule includes: Mrs. H. K. Miller, soprano, October 20; Mr. and Mrs. Lowell Townsend, two piano, October 27.

PORTLAND MUSEUM TO BUY EXPRESSIONISTS

With the closing of the large summer exhibition of contemporary paintings and prints, the Portland Art Museum announces two important purchases: "Tuileries Gardens, Paris" by Oskar Kokoshka; "Ladies in Spanish Costume" by Max Beckmann.

The work of Oskar Kokoshka was startlingly new and striking in 1908 when it was first exhibited in Vienna. Born in 1886, he was a member of the group which made the name of old Vienna synonymous with the charm and friendliness which Germans call "gemutlichkeit." His was also a revolutionary generation; and numbered among its members the architect Adolph Loos, the composer Gustav Mahler, as well as the psychiatrist Sigmund Freud.

Kokoshka was a leader of the turbulent German group called "expressionists" who looked upon art as an expression of the emotions and tensions of the artist's soul rather than as a portrayal of external reality.

Kokoshka was wounded in the first world war, through which he served as an officer in the Austrian army. Since 1934 he has been a staunch anti-Nazi, and soon came into disfavor because he espoused the cause of the persecuted Jews, even though he himself is not one of them. Thus his paintings became "verboten" and were unceremoniously sold abroad to raise funds for the Nazi coffers.

The present painting was done in 1927, and represents a more serene phase of the artist's later development. Kokoshka is at present living in England and is attempting to raise money by the sale of his paintings for the relief of his starving compatriots in Austria and Czechoslovakia.

An even more violent anti-Nazi than Kokoshka, Max Beckmann spent the war years in voluntary exile in Amsterdam. The first exhibition of the artist's work since 1941 was held last may in New York, and our picture arrived from Europe just too late to be shown. Announcement has recently been made by the University of Iowa that they also have purchased a Beckmann canvas.

Born in Leipzig, 1884, Beckmann is also a member of the German Expressionist group. Generally,

however, his work is less Germanic and more moderate than Kokoshka's, and our painting's heavy monumental figures seem more akin to the school of Paris.

SAN FRANCISCO WOMEN ARTISTS

Closing dates for entries to their 21st Annual Exhibition were set for early in October. The 1946 Exhibition will open on November 8.

MILLS COLLEGE ART GALLERY

The fall schedule of events at the Mills College Art Gallery will include:

Drawings and Water Colors from the 15th century to the present day, from October 6 to October 25; and the art work of Oakland public schools from kindergarten to high school.

Public Lectures, by "The Friends of the Mills College Art Gallery," include, "Master Drawings," by Dr. Alfred Neumeyer, Mills College, on Sunday, October 13, 3 p.m.; "Child Growth in Art," by Miss Alice Schoelkopf, art supervisor, Oakland public schools, Friday, November 8, 8 p.m.; and on Friday, November 29, at 8 p.m., Henry Schaefer-Simmern, University of California, will speak on "Unfolding of Artistic Activity."

11th NATIONAL CERAMIC EXHIBITION

The San Francisco Museum of Art was the receiving center of the northern Pacific area for work to be exhibited at the 11th National Ceramic Exhibition, scheduled for November 3 to December 15 at the Syracuse Museum of Fine Arts.

Mr. Carlton Ball, of the California School of Fine Arts, is chairman of the San Francisco Regional Jury, being assisted by Jermayne MacAgy and Herbert Sanders, with Dr. Grace L. McCann Morley serving as advisor.

Of particular interest to Bay Area artists is the announcement that Richard Gump, San Francisco, is offering a \$500 prize for the piece of best ceramic design suitable for mass production. This brings the total awards to \$2000.

The 11th Annual National Ceramic Exhibition is the first to be held in Syracuse since the war.

San Franciscans will have an opportunity to see the Annual Exhibition when it comes to the San Francisco Museum of Art next August.

LA TAUSCA ART COMPETITION ANNOUNCED

One hundred of America's outstanding artists have been nominated to compete for \$6,400 in cash awards in the 1947 La Tausca Art Competi-

(Continued on Page 36)

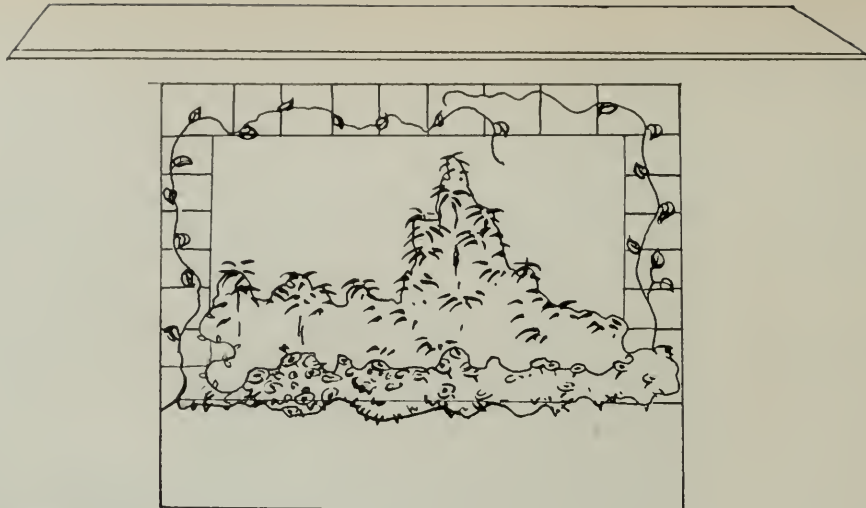

BOX holding frame for vine.

Window Boxes

By ALBERT WILSON

Botanist and Garden Consultant

**Garden Authority of the National Broadcasting Company,
KPO, San Francisco**

What materials can a window box be made of? Good redwood lasts for decades. Use screws instead of nails, and metal angles at the corners. Decorative terra cotta boxes and cement ones with fancy glazed tiles are likewise serviceable.

The inside measurements for a window box should be six to eight inches deep, and ten to twelve inches wide. This allows depth for the roots to explore the available soil. The outside measurements may be fourteen inches wide and one inch shorter than the window space. For very large windows the boxes may be in sections. To make the boxes really last, line them with galvanized iron, sealed tight with solder.

All boxes must provide ample drainage. In the bottom near both ends make holes. Small boxes will get along with one hole, best in the middle. Drill holes as big as a good sized cork, insert a pipe, and solder it to the lining, then lay flat over each hole a piece of coarse galvanized screen. Then with some of this same galvanized screen

make two cylinders five inches in diameter, and five inches high, like a carton without top or bottom. Fill these with course crushed rock; then place them resting one end over the screens above the holes; and the drain will never stop up.

Just what kind of soil is best for the window box? Mix two parts of fresh soil, one part of leaf mold, one part of sand, and a dash of peat to act as a sponge. Mix with this one half pound of bone meal. Use no bulky manure because it is not bulk but richness that you want here. Some professionals prefer a well balanced commercial fertilizer and to the average box would add one half pound, especially if annuals are to be grown.

Window boxes have special climates, according to the compass. Therefore plants must be selected with a definite knowledge of the varying exposures to sunlight, or the varying trials of wind and cold. For example: on the windy side a good aid to the plants is to press the soil, and use a deeper box so that the roots can have a firmer

anchorage, and a mulchtop dress will stop drying out. Thus aided, any of the plants, annuals or perennials, can take what ever the sun throws at them.

What is the schedule for watering a window box? It's windy up around those boxes on all sides of the house, and if we don't keep watch, everything will dry out. Soak thoroughly, and then be vigilant for dry soil, especially when the box has been newly planted. Once in a while water over head to keep down soot and dust and to discourage insects too.

What about fertilizer? You don't have to fertilize annuals because their soil was prepared with fertilizer to begin with. The permanents, such as Boxwood, dwarfed Junipers and Ivy, need an annual application of bone meal or commercial fertilizer. To make sure the fertilizer gets down to the lowest roots, punch holes with a spike down to the bottom, and then fill them with fertilizer, and soak immediately with plenty of water. Or use a good soupy cow manure. Just soak it in water for three or four days, thin it down, and pour it all over the soil. This is particularly good for the evergreens and flowering perennials.

Of course the day comes when the box fills up with roots, just as they do in a pot, and then the thing to do is pitch in pull out, prune back roots, provide clean drainage material, and new soil, and reset the plants. While you are doing this you may of course have plants in pots which you may wish to plunge into the box firming them outside in a cushion of peat or humus.

I have saved the selection of plants to the last, though of course in the work it has to come before these other matters. Not all plants can grow in the window box. Some plants lose their foliage too early in the season. Some can only grow big. Some have maurauding roots which will not be confined. Examples are privet, eucalyptus and acacia. We have to leave out all of these and many more.

We have to think of blooms, foliage, shape and size. Some plants hang, like the Asperingeri fern, and should be put in the front of the box. Some stand up rigid like the boxwood and should be put in the back; and others bush out giving the feeling of fatness and sparkle, like Genista, and belong in the middle.

Window boxes may serve as the whole garden to an apartment; they must move with the seasons. For color, in summer use masses of annuals with a long flowering period, like petunias, ageratum, lobelias, perhaps a white Chiffon daisy, a bronze calceolaria, and sweet peas for a curtain. And dwarf sweet peas called by some "Cupid" make a uniform growth of about eight inches high and each plant about a foot in diameter go well in window

boxes as they both droop and intertwine with their neighbors. Fall can have its contribution too, with chrysanthemums, grown in pots, and plunged in the box. In frost free districts the dwarf Salvia can be carried almost into the very heart of winter. And for winter you can have little spruces, holly trees, and berry plants. For next spring you can get daffodils, grape hyacinths, and the showy ranunculas, tulips, primroses, forget-me-nots, mixed with anemones, and pansies; in fact there are dozens of these bright spring flowers.

Along Lake street in San Francisco since my childhood I've enjoyed a window box with dwarf grown Cedars of Lebanon; they always look attractive; another window box I've known for years has nothing but the prostrate Chinese juniper; it's like a little green carpet out in front of the window. Recently as I drove around San Francisco, I saw a fine box planted to nothing but pink and white fibrous-rooted begonias. And everywhere were the trailing ivy geraniums, pink, rose, and lavender, tumbling over the boxes or solid colors of the various common garden geraniums. These are the easiest and simplest. Then there were several facing the afternoon sun, filled with petunias. But in my own city, for I am a native-born here, house after house stood with barren window boxes; just painted and left empty. That shouldn't be. It's not what they do in some cities. I've heard in Switzerland window boxes are the pride of every house, so I called on my friend Otto Meerly who hails from there. The light of happy memories came into his eyes. "Everybody has window boxes at home," he said. "Every house, every store, apartment, hotel, even schools and churches have them." There were not only flowers, but beautiful boxes of strawberries, lettuce, radishes and the decorative kohlrabi. For Otto reminded me not everyone could afford the luxury of flowers. Then there's the window box of the English Cottage; in Germany, Austria, Scandinavia, even in South Africa, and in South America, homes have window boxes. Especially for the stores, hotels and apartment buildings the architect designs for these window boxes. The main object of the boxes is often to decorate the rocky face of the buildings, for example those facing the beautiful lakes of Switzerland. These window boxes also bring color and interest to the empty face of the buildings; they become a drawing card for bees, butterflies and tourists.

Otto Meerly told me that in Europe promenade sidewalks exist in many of the resort towns, and these walks are as wide as our streets here. There is no business permitted to crowd onto the sidewalk, and these promenades face the beautiful lake, and sycamore, linden, and horse chestnut

(Continued on Page 40)



ENTRANCE DETAIL: Adobe residence of Mr. Louis Bradbury, Santa Monica Canyon, California.

Tiles around door are imported from Spain.

John W. Byers, A.I.A.
Architect

ADOBE HOUSES

By **JOHN WINFORD BYERS, A.I.A.**
Architect

Due to the difficulty of getting lumber, and the high cost of building in general, there has been of late a definite renaissance of interest in adobe construction. This interest seems to run in cycles, as some twenty years ago, and for no special discernible reason, people were very much interested in having an adobe house. At that time a special column of questions and answers was run in the Los Angeles Examiner on subject, and a large real estate concern developed whole tracts in so-called adobe construction—so-called because it was in no sense a true use of that material. The walls were of the usual stud frame, and the adobe often as thin as four or six inches, used merely as filler walls. These filler walls probably had some heat and sound insulation value, but the

construction was so flimsy, and so impermanent that the idea did not persist for long.

Under present building restrictions, such work would not be tolerated at all. The City of Los Angeles requires a bond beam of reinforced concrete entirely around the perimeter of the building, with a minimum 17" exterior wall composed of two courses of bricks 8" wide, and a 1" joint between; 18 gauge 1" mesh hardware cloth laid horizontally every fifth course; bond beam with four 3/4" reinforcing rods, and a 2 x 6 redwood plate above, bolted with 1/2" x 6" bolts every four feet. Besides all this, they may require vertical steel flanking door and window openings, anchored into the foundation below and the bond

(Continued on Page 15)



ABOVE: Street view of the Louis Bradbury adobe house. Note lateral roof ridges which divide rather yellow field tiles into panels. Raised ridges are of gun metal for contrast.

JOHN BYERS, ARCHITECT

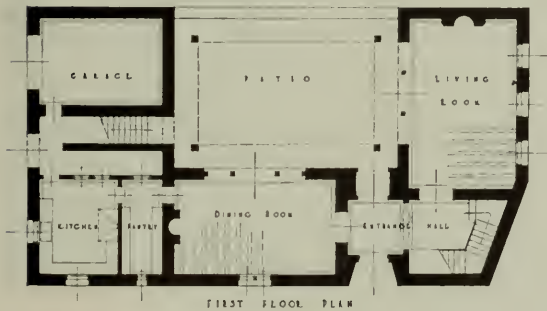
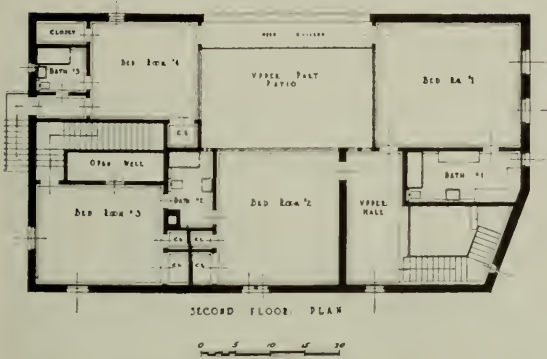

LEFT: First and second floor plan. The finished work closed the outside wall of the patio up to the level of the second floor gallery, and a door from the garage opens into the patio.



ABOVE: Ignacio del Valle adobe at Saugus, California, where the romantic story of Ramona was written by Helen Hunt Jackson. A replica of this adobe was made by Architect John Byers for the Riviera in Los Angeles.

BELOW: Another view of the Ignacio del Valle adobe showing a portion of the rear patio.



(Continued from Page 12)

beam above. Also, the City of Los Angeles will require that the building, however small, will need to be engineered for earthquake resistance.

Los Angeles County is a little more lenient, and will accept a 2 x 10 redwood plate with ½" x 18" bolts down through the adobes three feet O.C. This in lieu of the concrete bond beam, and up to maximum ceiling heights of 8' 6".

* The usual structural design of adobe buildings, however, follows the general requirements for any other type of masonry construction. The low allowable stresses in the material simply emphasizes the need for an unyielding foundation, amply reinforced bond beam and adequate diaphragm or horizontal truss system. The extensive tests required by modern building codes assure reasonable uniformity in the bricks and when they are laid up in cement mortar, a sound and homogeneous structure should result.

In most adobe construction, the wall section is governed by its flexural strength, spanning vertically between the foundation and bond beam. A bearing wall of minimum thickness (16 inches), weighs 160 pounds per square foot, resulting in high bending moments under seismic loading. The low tensile strength of the material limits the height of unreinforced walls, of reasonable thickness, to

* ACKNOWLEDGMENT of the Author is extended to the firm of PARKER, ZEHNDER & ASSOCIATES, Consulting Engineers of Los Angeles, California, for their cooperation in preparing the technical information contained in the following four paragraphs.

the minimum plate height for residential construction. If operating under one of the more restrictive building codes, which require continuous inspection of masonry if it is assumed to carry any tensile stress, it may be more economical to provide sufficient reinforcement to carry the tension, rather than to provide continuous inspection. In walls which are otherwise unreinforced, it is recommended that a nominal amount of horizontal and vertical reinforcement be provided around all openings and at wall intersections.

Where wall heights are much in excess of eight feet, a reinforced section will generally be the more economical. The same assumptions and formulas are used for design as in reinforced concrete. The value of E, the modulus of elasticity, varies considerably, but an average value of 200,000 is generally used. In reinforced wall construction it is necessary to deviate from the traditional single tier wall, in order that passage may be provided for the vertical reinforcement while still satisfying the bond requirement for staggered joints. For moderate wall heights (approximately 8 to 12 feet) the use of a single tier of reinforcement at the center of the section is generally the most economical. For the infrequent case where the wall height exceeds 12 feet, the use of a double tier of reinforcement is recommended to increase the effective depth of the section, although this type of construction requires the use of two brick sizes.

There need be no concern over the durability or safety of an adobe structure which meets all the

(Continued on Page 17)

RANCHO LA BREA: Here is the original ranch house, as restored, on the once great "Rancho La Brea," one of the large Spanish grants of early times. Note how modern are the lines of the building, reflecting both the old and new in California architecture. Located on Third, near Fairfax, the property is now owned by E. P. Gilmore, and is about 150 years old.





Maynard
Parker,
Photos

FRONT TERRACE showing dining alcove off living room

Curtis Peck adobe

San Fernando Valley, California

DINING ALCOVE INTERIOR as seen from the living room. Large windows offer wide sweeping view of San Fernando Valley.



(Continued from Page 15)

requirements of a modern building code. The fundamental consideration in the design and erection of any building is that it act as a unit, so that its horizontal bracing system will be effective in distributing lateral forces. This is particularly important in the case of adobe construction, but fortunately may be achieved by the usual methods of good construction practice.

There is a common belief that adobe is a cheap method of construction, as cheap as dirt in fact. This is a fallacy, as the engineering costs, the steel, the bond beam, and the extra heavy footing and foundation walls increase the cost over that of ordinary stud and stucco very considerably. It is not fair, however to compare, in costs, an 18" adobe wall with a 6" stud and stucco wall. The appeal of adobe would be for those people who really want a house in the simple picturesque feeling of the early California adobes, such as are seen in the towns of Monterey and Santa Barbara, and generally scattered about California.

This type of house can only be arrived at successfully if one builds them much in the manner of the old days one hundred years or so ago. The adobes should be made by hand, and laid up

preferably by Mexican labor. The tiles, both on the floor and on the roof should be really hand made and not machine extruded. They can only be done economically if the adobe bricks are made right at the building site with the soil at hand. Usually there is enough dirt for this purpose obtainable from the excavation under the house and for the basements and foundation trenches. Almost any dirt at all with the proper admixtures will make a good enough adobe, except decomposed granite. If the soil contains too much gravel, the practice is to have the Mexicans sift the gravel out of the dirt by the simple device of throwing it against a screen standing up at an angle. This dirt is mixed with straw for a binder preferably, and sometimes a few loads of clay may be required to give the mixture the proper consistency. In the early days the Mexicans used anything at hand, dried grass, very small twigs, or the straw bedding that came out of the horses' stalls, mixed with manure as it might be.

The old timers piled the material up in a small cone and poured water into a sort of a volcanic spot at the top and worked the whole thing down with a hoe and their bare legs, as the volcano burst and the water trickled down the sides. They used a small litter of wood with two handles at opposite sides for two men to carry about two



REAR COURT and swimming pool of the CURTIS PECK adobe house

ADOBE GUEST HOUSE

Miles Berne, Photo



At the residence of P. G. Winnett, Santa Monica

bricks at a time. This contraption was called a parigueta. The bricks were often as large as 4 x 14 x 20, and would weigh at least 50 pounds or more when wet. This parigueta was taken by two men over to a crude frame of two compartments made of 1 x 4's, and lined with sheet metal and lying on the ground, called the adobero. When the bricks were sufficiently set up, this frame was wiggled free and picked up for the next batch of two bricks, and of course one could have as many frames on the job as needed. When the Mexicans were working by the piece, two of them could make about 400 of these bricks a day. When working by the day, they could make 200.

It is better, in engaging Mexican labor, to arrange that everything be done by contract, what they call "hecho y puesto," that is, made and laid in the wall. This makes it their concern that the bricks be taken care of during the drying process, and if they are wasteful of material in cutting around door and window openings, it is at their expense. If a Mexican wants a little piece of adobe brick, he will not pick up any one of the small pieces scattered around the ground, but will pick up a 4 x 14 x 20 brick weighing 50 pounds and whack off a corner to use, throwing the rest of the brick back on the ground. Another good reason for the "hecho y puesto" method is that you know

precisely what your bargain includes by the simple count of the adobes in the wall measure at so much a thousand.

The various progressive steps by which costs creep up under other arrangements are more or less as follows: You meet your Mexican and you make your bargain, we'll say at a prewar price of 5c a brick, the dirt to be available at the building site. Before you get started, you find that your brick has gone up to 6c because there is a process called "nivelar," which means the cost of leveling off the ground on which the adobes are to be spread. This is a sensible requirement, and O.K. So the adobes are made and laid out on the ground. You can't use them without moving them, and without their being dried on the under side, so you discover there is another penny a brick involved in turning them up on their edge to expose them to the sun on their bottom side. This is called "cantear," but when you "cantear," you will find there is a big blob of mud sticking to the under side of the adobe. This has to be cut off by hand with a hatchet, and is called "limpear," or to clean, and costs another cent. Then they have to be ricked up, which is "atrincherar," and finally, if it looks like rain, you have to go into "protejer" for protection, which ups it another

(Continued on Page 20)



Mrs. E. W. Zimmers ... adobe

Santa Monica, California

ABOVE: By contrast
an "Adobe" holds
great appeal.

RIGHT: Rear Court
of the Zimmers
home. Note empha-
sis of extended
eaves.



ADOBE HOUSES . . .

(Continued from Page 18)

penny, all of which brings your 5c brick by gradual stages up to a 10c brick.

The possibility of rain, however, need not be too fearsome, as a well-made adobe brick will stand a terrific amount of water without disintegration. The Kemper Campbell house on the Mojave Desert, shown here, was made from dirt at the site with no water proofing admixture of any sort, and not even a coat of white wash, and is now about thirteen years old, with no sign of disintegration whatsoever. This is not, however, to decry the use of the American Bitumuls Company product, which is not only required by the Building Department, but should be used wherever adobe structures are considered. The company will make a laboratory test of the bricks as manufactured for a sample, and will issue a license to that particular person who is buying their product to be used as a water proofing admixture. Bricks so treated will stand any rain or any reasonable water test indefinitely, and the use of such a mixture will materially reduce the cost of the structure, in that such walls need

not have any protective coating other than a brush coat for appearance.

For those who really like their adobes to be in evidence, interior plaster may be omitted entirely, as there are products on the market which will give a perfectly white covering which will not brush off on the clothing, or allow the asphalt of the Bitumuls to burn through. If, however, the adobe interior walls are to be plastered, this should only be done over hog wire, as it is very difficult to get a proper adherence. The Mexicans were fond of using a lime plaster because it went on very evenly, was very white, and if it fell off shortly it could always be put back, and it very often did fall off without much delay. Some of the older houses, however, have had so many coats of white wash put on, one over the other, over a period of years, that they have perfect cohesion with the mud walls.

The early houses were laid up in mud mortar, as everybody in California knows, and mud plastered often by the simple direct method of patting the mud on the walls with the bare hands. The

(Continued on Page 24)



**INTERESTING COBBLESTONE
fore-court of the offices of
Architect John Winford Byers,
A.I.A., in Santa Monica, Cali-
fornia.**

**Many of the famous "Adobes"
designed by Mr. Byers re-
ceived their initial inspiration
amid these surroundings.**

**Note the pigeons in the center
of the court.**

ARCHITECT AND ENGINEER



GENERAL VIEW of the ranch house before additions were added for guests

Kemper Campbell Ranch

on the Mojave Desert, Victorville, California



AN ADDITIONAL adobe unit now joins the two buildings shown here



**KEMPER
CAMPBELL**

**Adobe
Ranch
House**

**Victorville,
California.**

ABOVE: Corner of main building . . .
rafter ends showing are old railroad
ties.

RIGHT: Front terrace overlooking a
veritable forest of Joshua and Cotton-
wood trees and the mysterious Mojave
River.



Living Room Detail

STAIRWAY from end of the living room leading to interior balcony and upper bed rooms.



FIREPLACE at opposite end of the living room. Book shelves at left beneath balcony.

ADOBE HOUSES . . .

(Continued from Page 20)

early attempts to make the exterior plaster stick to the walls was supposed to be accomplished by driving little bits of broken brick or sharp stones or shells into the mud joints to serve as a bond. This was called "rajuela," and was a very laborious process indeed.

Persons not sympathetic to adobe, and wishing to use it merely as a building material, turn out some terrible looking structures. Also, those who believe they can make their own adobes and lay up their own walls and get a proper effect, to say nothing of getting by the Building Departments, are really off to a bad start. Even all Mexicans cannot make good adobes, any more than every housewife can make good bread, although both Mexican and housewife believe they can. Poorly made adobes will crack in the sun as they are drying, and if they topple over from the "cantear" position, will break in two. A good one, however, even those weighing 50 pounds, can be dropped

from a man's hands without breaking, although this is not a necessary crucial test.

The true adobe should have either a split shake roof or a hand-made tile roof. The shakes, as one sees them about California, were often of the very thin variety, about 1/4" x 6" and 36" long, exposed from 12 to 18 inches to the weather. These were probably not so good since they curl in the heat and leak, and the tile is a much more practical and attractive roof. These tiles, to be in character, should definitely be hand made. The old Mexicans here were supposed to have shaped the tiles over their thighs, thus giving the tapered shape. The modern Mexicans, however, use a wood block shaped like the thigh and called a lapida, which serves the same purpose.

The early tiles took on a very agreeable color, as they were not very hard burned, and the rain and air more easily penetrated. Most of these early tiles, lovely as they were in color and texture, would not pass the present day Building Department requirements. An Italian in Santa Barbara used to make the nearest to the old type tiles of

**Kemper
Campbell
adobe
ranch
house,
Victorville,
California**



**Showing
rear
covered
terrace
to
garage**

Dining Room

Furniture and all furnishings are designed to carry out the feeling and atmosphere of the adobe home.



anyone in this part of the country. His method of mixing the mud was interesting. He hollowed out in the ground a large sized concave bowl about 40 to 50 feet in diameter, with a snubbing post in the center, from which extended a long yard arm the radius of his circle. On this radius, acting as a shaft, rode a large iron-rimmed bull wheel which looked as if it had come off one of the pioneer covered wagons. A horse was hitched to the end of the yard arm, and as he went round and round the circle, the bull wheel slipped haphazard up and down the shaft, and mixed the adobe mud, water and straw, or what not, with which the bowl was kept supplied.

Often tiles of this character were burned in simple up-draft kilns, made of adobes in the shape of a box with an open top and arches at the bottom, through which was fed a fire of wood, eucalyptus poles, scrap, or anything combustible and obtainable. The top of the open box kiln was covered with a two- or three-inch layer of manure, which seemed to have a property of keeping the heat in.

One of the disappointing uses of adobe in the

hands of present day workmen is their lack of feeling for the material which they are using. Plasterers, plastering over an addition to an old adobe structure, will so utterly fail to copy the texture of the existing plaster on the old building that you could take a 6H pencil and clearing mark off the line of demarcation between the two. Fountains and garden walls also miss the spirit of the thing, and the patio paving, and all the other various items which, assembled by a sympathetic hand, can produce a charming result, are done very badly, becoming simply ludicrous, as for instance the little trick of putting in a little bunch of common brick in the adobe wall and exposing the same with the plaster carefully and painstakingly held back—all this to simulate the destructive passage of time. The best result, and particularly in this material, is to go about it directly, no false roofs, no false chimneys, every rafter, every timber doing its work and nothing more; no curlicues, no funny little mouldings, just straight walls surrounding squares or rectangular spaces, good and thick, with shutters inside or out to shut off the light, and wide terrace roofs supported on simple wooden posts or adobe columns.

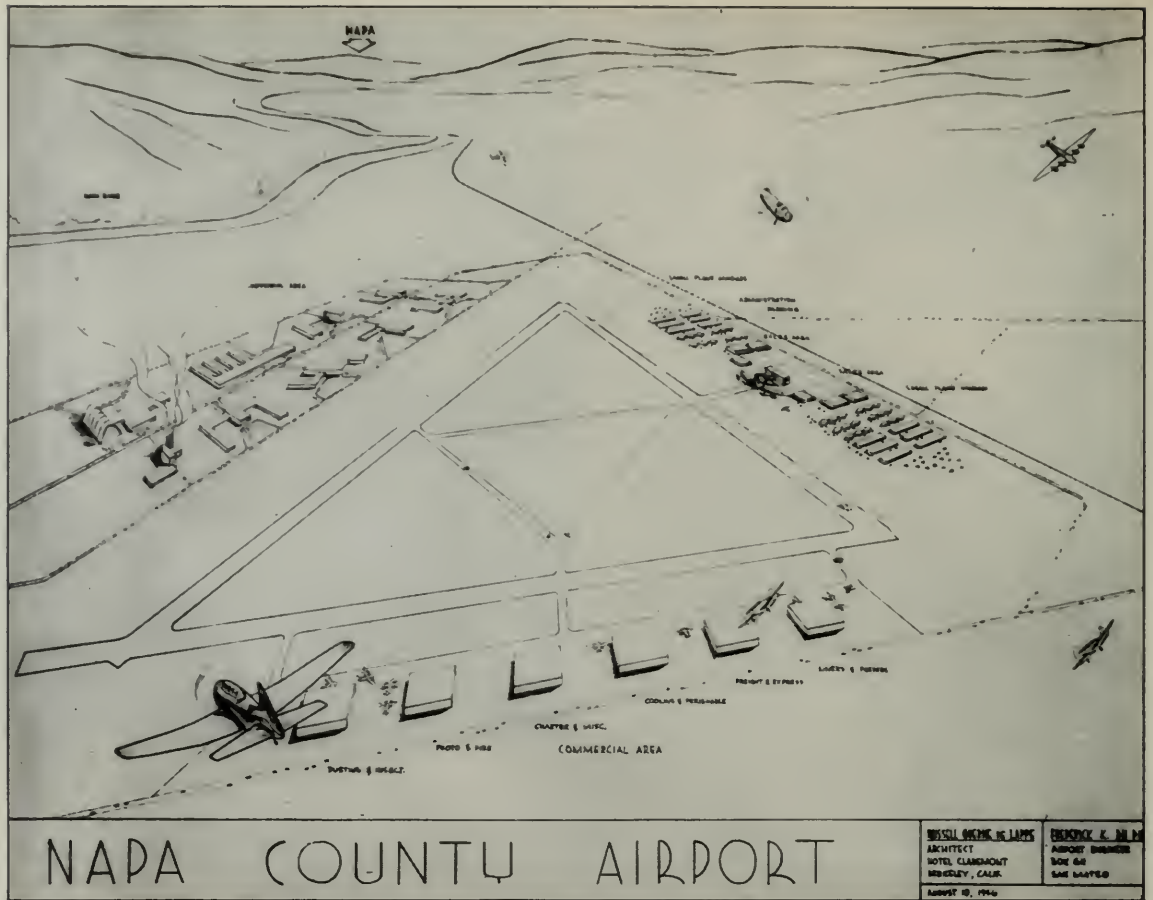

Airport Conversion Project

Government Constructed Airfield Is Obtained by Napa County, California,
 Officials for Commercial Expansion

By **FREDERICK K. DUPUY**
 Airport Engineer

One of the least publicized and yet most extensive military supervised construction programs throughout the Nation during the recent war was the development of facilities for the training of aircraft pilots, building of airports, emergency flight strips, aircraft supply and maintenance and repair bases, and focal points for Army, Navy, Marine Corps, and Coast Guard flight services which projected the United States Air Corps activities into every part of the world.

Many of these wartime developed projects will be retained for the active use of a large military air force; other facilities have served their useful purposes and as surplus will be abandoned; while still others will be adjusted and converted into peacetime use for commercial air lines and nu-

merous private enterprises.

In the latter group, and probably among the most outstanding examples on the West Coast where wartime airport facilities are being converted into practical peacetime uses, is the Napa County Airport located about midway between the great U. S. naval base of Mare Island at Vallejo, California, and the rapidly growing industrial, commercial, and agricultural center city of Napa, California.

While the "surplus" airports are located all over the United States, the majority of them are situated along the Atlantic and Pacific Coast states and in the areas where there is a maximum of good flying weather.

Because of favorable year 'round weather condi-

tions and its proximity to the tremendous industrial, agricultural and commercial regions of the San Francisco-Oakland Metropolitan Bay Area; the expansive San Joaquin and Sacramento Valleys, and the extensive redwood and pine lumbering regions of north coastal California, the Napa County Airport is strategically located for peacetime use.

Military operations differ considerably from civilian flying, therefore each surplus military airport has to be redesigned for efficient commercial use and adjusted to best serve the individual problem of the community.

No stock pattern can be used as the original service airport, although generally speaking they contain certain uniform characteristics such as an over-all of approximately 600 acres; two or three concrete paved runways, and represent an investment of between one and three million dollars. The Napa County Airport, for example, represents an investment of well over \$1,500,000 in land and improvements.

The recently enacted National Airport Program provides, among other things, matching Federal funds for authorized civilian airport projects with the ultimate purpose of the Act being to provide a complete network of adequate civilian airports throughout the United States.

Therefore each community that inherits a surplus airport, and later receives matching Federal funds for improvements, will have to adopt a definite long range plan of expansion and development with a County Master Airport Plan based upon present and future civilian aerial traffic.

Realizing this necessity, Napa County and city officials, led by Thomas Maxwell, chairman Board of Supervisors, together with civic groups and organizations; representatives of the State of California, the U. S. Government (including Army, Navy, Marine Corps, and Coast Guard), and the Civil Aeronautics Authority have combined in consideration of the possibilities of converting the Napa airfield into a long range, practical, post-war civilian use.

The result of preliminary investigation was the appointment of the Napa County Aviation Committee, with Lowell Edington, youthful and efficient member of the Napa County Board of Supervisors, as general chairman.

After some consideration of the project, it was recognized that the need included an engineering study to correctly envision the future civilian use of the airport and to design a long range master airport plan that would develop economically and

progressively, and my services were secured for the working out of such a project.

Taking advantage of the services of Russell G. deLappe, A.I.A. Architect and Planning Consultant of Napa County, different layouts, building design and arrangements, and many conveniences that are required for an airport designed to cater to small privately owned pleasure aircraft (exclusive of freight and passenger lines), a Master Airport Survey was made.

In his report on the subject, Architect deLappe says:

"Economic stability on the national level is a prerequisite to economic stability on the local level. This basic concept underlies all planning undertaken by Napa County. . . . The County's program to complete a Master Airport Plan follows two other closely related programs namely, to remove the highway bottleneck at the Third Street Bridge, which is a handicap to up-state traffic, and to straighten and widen the Napa River, which has proven its national worth in serving the shipbuilding operations of the Basalt Rock Company during the war.

"It is interesting to observe that all three programs provide for improvement in the three essential lanes of traffic—land, sea and air. With these avenues of transportation refined to an optimum degree, the opportunities for a ready flow of trade are furthered, not only within the State but along the coast and in the Orient."

Outlining three specific objectives, deLappe continues: "To reveal in visual form the optimum number of natural airport sites throughout the County which should be planned to supplement the Class IV airport which was built between Napa and Vallejo during the war at an investment of over \$1,500,000; to investigate the full potential for appropriate use of the existent Class IV field in serving the locality to meet present and expanded future needs; and to help in rounding out the delineation of a non-depression workpile."

While aerial traffic patterns vary for the various types of aircraft which will use the field, and this in turn vitally affects the location and classes of various airport abuildings, there is no measuring stick which an airport designer can say is complete in all instances.

However, the Napa County Airport has been designed to serve both Napa and Vallejo, and all the territory within a radius of forty miles. The present plan will take care of all the anticipated air traffic for the next twenty-five years, and includes such items as privately owned light aircraft; sales, parts, agencies and repairs; photographic work and fire

control; charter, main and feeder lines; schools, dusting and insecticide; air shipment of perishable agricultural products; and air freight, mail and express.

Evidence that the fundamental points of the project are sound is indicated by the fact that the Napa County Master Airport Plan is now being used as a model report on airport reconversion throughout the State by the California Airport Commission.

Improvements already completed include a temporary administration building; authorization for two private companies to erect hangars for aircraft sales purposes; a machine and repair shop; and facilities for educational training purposes, representing an investment of approximately \$80,000.

There has been set aside in budget provisions, for a permanent administration building and other physical improvements, about \$400,000, while a total of more than \$1,000,000 will be spent in improvements during the next 10 to 15 years.

WAR MEMORIALS

The California Palace of the Legion of Honor, in San Francisco, gracefully crowning the summit of a high hill, overlooking the Pacific Ocean and the Golden Gate, has been declared by world travelers to be more beautiful than the Taj Mahal.

Built and given to the City of San Francisco by Alma de Bretteville Spreckels and her late husband, Adolph B. Spreckels, the structure was dedicated in 1924 as a memorial to the 3,600 California heroes who died in France in World War I.

An exact replica of the well-known edifice in Paris, the Hotel de Salm, in which are the offices of the Legion d'Honneur, California's great Palace of the Legion of Honor has become a center of art and education, with its galleries filled with priceless paintings, sculpture, tapestries and other treasures. Its little theater and specially designed organ afford opportunities for frequent plays, concerts and for popular cinemas.

A Triumphal Arch, surrounded by colonnades, constitutes the entrance to the Palace and extends into the spacious Court of Honor, surrounded by Ionic columns. In the center of the Court is Rodin's "Thinker." Inside the building, a marble rotunda gives access to the nineteen large galleries on the

main floor, and to two courts where semi-tropical plants and flowers abound. The lower floor contains a tea room, additional galleries and lecture rooms and offices.

It is eminently fitting in a building of French design that many of its collections and exhibitions are also French. Mrs. Spreckels, herself a member of the distinguished French family of de Bretteville, has long been a patron of art. The benefactions of the Spreckels family to the museum have been very extensive. Two entire galleries are devoted to Mrs. Spreckels' collection of Rodin sculptures, of which there are approximately one hundred pieces, many of them selected by the great master himself, and said to be the most important assembled outside of the Rodin Museum in Paris. Thirty original plaster studies and a number of drawings by Rodin comprise a group presented to the museum by Adolph Spreckels, Jr.

Other works of art which attest to the magnanimous public spirit of the museum's founders are the works of Theodore Riviere, comprising almost completely the life work of the great artist; a remarkable collection of medals by the late Pierre Roche, eighty in number, commemorating the history of the first World War; French porcelain; and a group of nearly one hundred and fifty bronzes by the late Arthur Putnam, who was California's best-known animal sculptor.

The California Palace of the Legion of Honor contains many important gifts, particularly those made by the French Government when the museum was opened, and including a series of Gobelintapestries representing the life of Jeanne d'Arc, a collection from the National Sevres factory, photographs and valuable books on art for the Library.

More recent gifts are rare paintings, sculpture, tapestries and furniture in the Collis Potter Huntington Memorial Collection and the Mildred Anna Williams Collection, both of which contain superb examples of French furniture and tapestries, with the latter collection also including paintings from leading masters of the principal European schools from the 16th to the 19 centuries.

Members of the Board of Trustees are Paul Verdier, president, James B. Black, Alexander de Bretteville, O. K. Cushing, Mrs. Errol MacBoyle, William Wallace Mein, Mrs. John Rosekrans, Mrs. Adolph B. Spreckels and Adolph B. Spreckels, Jr.



TOP (left to right): Dr. Jaro J. Polivka, Mrs. W. W. Wolf, Mr. W. W. Wolf, Mr. E. A. Verner, Mrs. E. A. Verner, Mr. G. A. Sedgwick and Mrs. G. A. Sedgwick. BOTTOM: Mrs. Andrew T. Hass, Mr. Andrew T. Hass, Mrs. William Adrian, Mr. William Adrian, Mrs. William Moore, and Mr. William Moore.

STRUCTURAL ENGINEERS ASSOCIATION OF NORTHERN CALIFORNIA ENTERTAIN

At the San Francisco Engineers Club last month, The Structural Engineers Association of Northern California held their annual Ladies Night. Over one hundred members of the Association, their wives and guests attended. Guests introduced by Mr. William Adrian, President, included Mr. Andrew T. Hass, President, Northern Chapter American Institute of Architects; Mrs. Hass; Mr. John S. Bolles, President, California Council of Architects; Mr. E. H. Wilder, Editor, Architect and Engineer; Mrs. Wilder; and Mr. John M. Server, Jr., Editor,

Western Construction News; and Mrs. Server. Members introduced themselves, and in turn presented their wives.

Movies were shown by Mr. Adrian, which were taken by him during a recent trip to Death Valley, and then introduced Mr. William Nien who spoke on "Death Valley Scotty." At one time Mr. Nien resided in the "Castle" built by Death Valley Scotty, and during that time received the opportunity to gather many interesting facts about the Castle, Death Valley, and Scotty himself.

A. I. A.

American Institute



ACTIVITIES

of Architects

Arizona Chapter:

James Macmillan, President; Arthur T. Brown, Secretary, 740 N. Country Club Road, Tucson, Arizona.

Central Valley of California:

Herbert E. Goodpastor, President; Frank V. Mayo, Secretary, 307 Exchange Building, Stockton 2, California.

Colorado Chapter:

Raymond H. Ervin, President; James M. Hunter, Secretary, 2049 Broadway, Boulder, Colorado.

Montana Chapter:

Ralph H. Cushing, President; H. C. Cheever, Secretary, Montana State College, Bozeman, Montana.

Northern California Chapter:

Andrew T. Hass, President; John S. Bolles, Secretary, 369 Pine Street, San Francisco 4, California.

Oregon Chapter:

Francis Jacobberger, President; J. D. Annand, Secretary, 401 Central Building, Portland 5, Oregon.

San Diego Chapter (California):

H. Louis Bodmer, President; Louis J. Gill, Secretary, 203 Granger Building, San Diego, California.

Santa Barbara Chapter (California):

Roy C. Wilson, President; Miss Lutah M. Riggs, Secretary, 240 Middle Road, Santa Barbara, California.

CALIFORNIA COUNCIL OF ARCHITECTS:

John S. Bolles, President; Charles O. Matcham, Vice-President; James H. Mitchell, Secretary-Treasurer; 369 Pine Street, San Francisco 4.

Southern California Chapter:

Charles O. Matcham, President; John Landon, Secretary, Chapter Headquarters 3757 Wilshire Blvd., Los Angeles 5, California.

Spokane Chapter (Washington):

Noel E. Thompson, President; Kenneth D. Storment, Secretary, Hutton Building, Spokane 8, Washington.

Utah Chapter:

George Cannon Young, President; Theodore R. Pope, Secretary, 29 South State Street, Salt Lake City 1, Utah.

Washington State Chapter:

George W. Stoddard, President; Stephen H. Richardson, Secretary, 516 Central Bank Building, Seattle, 4, Washington.

Hawaii Chapter:

Kenneth W. Roehrig, President; James Morrison, Secretary, 334 Federal Bldg., Honolulu, T. H.

SOUTHERN CALIFORNIA CHAPTER

The proposed plan of "community planning," strongly advocated by President Chas. O. Matcham, is beginning to take shape and within the near future details may be announced.

Veterans On-Job Training Program is progressing on the suggested two-year program, with Chapter co-ordinating activities in accord with newly developed state-wide objectives.

* * *

The annual Outing and Joint Meeting of the A.I.A. and Producer's Council was held in September at the Uplifters Club in Santa Maria. A good crowd . . . good eats . . . a good time.

* * *

Membership continues to gain under able guidance of Chairman Gable. Total membership now stands at 406.

* * *

The City Professional Tax will become delinquent October 31, 1946.

* * *

The Lecture Committee has been busy filling requests for speakers to appear at store, AIA, and school programs.

WASHINGTON STATE CHAPTER

Inaugurating a new series of specially prepared discussions with outstanding representatives of allied professions, Chapter members heard Mr. Calmar McCune present a most interesting story of the American Bar Association at the regular September meeting.

* * *

Frederick T. Ahlson, Robert B. Hopkins and Harry T. Broman have been extended Corporate

Memberships in the Institute with assignment to the Washington State Chapter.

* * *

Roland G. Pray, Charles A. Miller, Ernest Weber, Wallace R. Stout and Raymond H. Peck have been included as new Chapter Associates.

* * *

James W. O'Brien, Jr., Edward L. Cushman, Garneth R. Moe, Arthur E. W. Dodds, Edward L. Turner and Robert S. Laney are now Junior Associates of the Chapter.

* * *

Ed. Turner has been appointed chairman of a liaison committee to work with the School of Architecture, University of Washington.

* * *

B. Marcus Priteca and A. Gordon Lumm, Chapter members, have been appointed members of the Washington State Board of Architect Examiners.

* * *

License to practice Architecture in the State of Washington has been granted Robert A. Hanson, Edward K. Mahlum, B. F. McAdoo, C. G. Forssen, G. W. Hazen, R. H. Stradling, Jr., I. E. Cummings, H. M. Bowe, A. V. Peterson, D. A. Hall, R. H. Ross, O. W. Olson, and F. A. Long.

NORTHERN CALIFORNIA CHAPTER

San Francisco's proposed Building Code; employee-employer relations; "On the Job Veteran's Training" program; a national Roster and Register of Architects for Public Works projects; and the Annual California Council AIA Convention in Coronado on October 10-12, highlighted the regular September meeting of the Northern California Chapter AIA.

(Continued on Page 44)

WITH THE ENGINEERS

Structural Engineers Association of Northern California

W. Adrian, President; William W. Moore, Vice-President; Franklin P. Ulrich, Sec.-Treas.; John A. Blume, Ass't. Sec.-Treas.; Offices 214 Old Mint Building, San Francisco, Phone GARfield 3890. DIRECTORS, H. M. Engle, Mark Falk, and M. V. Pregnof.

American Society of Civil Engineers San Francisco Section

Theodore P. Dresser, Jr., President; Leon H. Nishkian and Sidney T. Harding, Vice-Presidents; John E. Rinne, Secretary-Treasurer; 225 Bush Street, San Francisco 20.

Puget Sound Council (Washington) Engineering & Technical Societies

R. E. Kistler, A. I. E. E., Chairman; A. L. Miller, A.S.C.E., Vice-Chairman; L. B. Cooper, A.S.M.E., Secretary; B. A. Travis, I.E.S., Treasurer; Offices, Seattle, Washington.

ENGINEERING MEETING

The National Fuels and Lubricants meeting of the National Society of Automotive Engineers will be held on November 7 and 8, in Tulsa, Oklahoma.

OIL RESEARCH

The National Research Council has announced the appointment of Dr. Claude E. ZoBell, associate professor of microbiology at University of California's Scripps Institution of Oceanography, La Jolla, as chairman of a committee to coordinate

research work in the nation on the application of microbiology to petrology.

A. V. SAPH, JR., has been appointed chairman of the STRUCTURAL ENGINEERS Association of Northern California, committee on public information, with John G. Little being named a member of the committee.

WALKER L. DICKEY is now located with Myron C. Gould, Industrial Engineer, 701 Sansome Street, San Francisco.

STRUCTURAL ENGINEERS ASSOCIATION OF NORTHERN CALIFORNIA

A member meeting of the Structural Engineers Association of Northern California was held Tuesday night, October 1, at El Jardin Restaurant, San Francisco. Announcement of the Convention to be held at Santa Barbara was made by Lloyd White.

The proposed schedule of fees to apply on various types of work performed by the structural engineers was presented by Henry C. Powers. John A. Blume told of the action taken by the Association in connection with the proposed new Building Code for the City and County of San Francisco. The engineering features of Article 23 of the proposed Building Code dealing with the subject of lateral forces, were discussed by M. V. Pregnof, R. S. Chew and L. H. Nishkian, and followed by comments from many members of the Association.

As chairman of the Committee on Public Education, A. V. Saph, Jr., described the new work being done by the Association in public education. Action on the subjects presented will receive further consideration at the meeting November 3.

H. J. Brunner, president of the American Automobile Association, reported on his 30,000-mile automobile trip through Latin America where he endeavored to stimulate interest in the Automobile Association, as well as to advise the engineers in those countries of the effects of earthquakes on tall buildings.

Vice President William W. Moore presided in the absence of President William Adrian.

THE RICHMOND WORKS

Under the direction of Howard I. Detro, the American Radiator and Standard Sanitary Corporation will operate a plumbing supply plant at Richmond, California, on a newly acquired 5½ acre site.

A new plant is to be constructed at an estimated cost of three and a half million dollars, it will cover approximately 200,000 square feet and is expected to be in operation in 1947.

Back they come

protected by America's outstanding fountains!



Many schools and colleges will open the new semester with improved drinking water systems featuring Halsey Taylor equipment. Architects and school authorities recognize the superior hygienic protection afforded by Halsey Taylor Drinking Fountains, whether for new construction or replacements of obsolete systems. Write for catalog.

The Halsey W. Taylor Co., Warren, O.
West Coast Plant,
Redlands, Calif.

HALSEY TAYLOR

Drinking Fountains

CENTRAL COAST COUNTIES ASSOCIATION

Ralph Wyckoff, Architect, and Gifford E. Sobey, Architect, of San Jose, were elected Chairman and Secretary, respectively, of the Central Coast Counties Association of architects.

Representing architects in Santa Clara, Santa Cruz, Monterey and San Benito counties, the objective of the newly organized group is to study social and civic improvements in the field of city and county planning, zoning, parking, playgrounds, and to promote a better understanding of the architectural profession.

The Association will meet every third Wednesday of the month.

NATIONAL METAL CONGRESS

The 28th Annual National Metal Congress and Exposition will be held in Atlantic City's Municipal Auditorium for five days beginning November 18.

Meeting jointly with the NMCE will be the American Society for Metals, the Iron and Steel Division and the Institute of Metals Division of the American Institute of Mining and Metallurgical Engineers, the American Welding Society and the American Industrial Radium and X-Ray Society.

It will be the first time in five years that the event has been held, and is expected to register an attendance in excess of 25,000 executives.

DEEP WELL PUMP PROTECTION

A new method of protecting deep well turbine pumps from lowering water levels has been announced by the AUTOMATIC CONTROL COMPANY of St. Paul, Minnesota.

It is called PROTECTROL and automatically stops pumps when water ceases pumping for any reason, and must be manually reset regardless of primary control operation.

Installed on the pump discharge side of the check valve in the pump house, PROTECTROL is available in two styles: Class 1, which includes an alarm system, and Class 2, without alarm.

AFTER AWHILE ROOM

A unique merchandising display room with the casual open-air character of the California outdoors has been designed by Harwell Hamilton Harris, Architect of Los Angeles, for Pat Premo sportswear designer.

Natural redwood boards panel the walls and redwood rounds in various sizes pave the floor. Frosted glass is used to cut out street sounds and sights and let in light, color being introduced in drapes, rug and upholstered pieces.

Colorful greenery, burnished copper accessories and frosted mirrors make up the rest of the fittings. The showroom will accommodate 34 visitors.



Your clients will be pleased if you...

*Plan for a
number of
telephone
outlets*



Even if they'll only need one telephone immediately, your clients will see the wisdom of planning ahead for a number of built-in outlets.

Then future telephones can be added without bringing exposed wires in along the baseboards or molding. Telephone wire conduit is inexpensive to install during building, and it adds real value to a house.

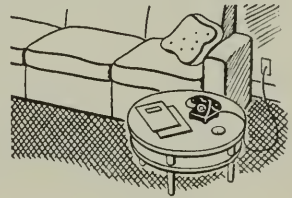

So work with an eye to the future. Call or dial your local Telephone Business Office and ask for Architects' and Builders' Service. This Service is at your disposal without charge.

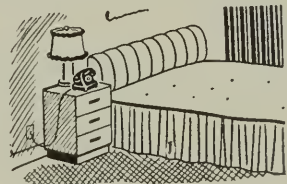

The Pacific Telephone and Telegraph Co.





"KRAFTILE" PACKAGED STEEL FRAME HOME COMPLETED

Kraftile Company Inaugurates "Packaged" Stran-Steel Framing

Inauguration of a complete "packaged" steel framing service—involving distribution of the new Stran-Steel pre-cut framing in the San Francisco-Oakland Bay Area, operation of a pre-assembly welding plant, and truck delivery of ready-to-erect units to the job site—was announced this week by C. W. Kraft, president of the Kraftile Company, Niles, California, one of the nation's largest distributors of products manufactured by the Stran-Steel Division of the Great Lakes Steel Corporation.

"Packaged steel framing has proved to me that it offers the ideal combination of ready availability, speed erection, and permanent value for today's home builders," stated Kraft.

He referred to the results witnessed by a large group of builders, building officials and California Stran-Steel dealers recently near Pittsburg, California, when an 8-man crew demonstrated the easy erection of Stran-Steel packaged framing at an event co-sponsored by Kraftile under the auspices of Stran-Steel Division. The crew placed complete exterior wall and roof framing, including floor joists for a 24 x 36 ft. house, in 51 minutes. Roof trusses, side wall and end wall panels had previously been assembled from the pre-cut "packaged" parts by arc welding in simple jigs. It is this pre-assembly function which Kraftile has developed as a highlight of its new service as distributor.

Solid experience, with the distribution of Stran-Steel's other headliner product, the Quonset "pack-

aged" steel buildings, stands behind the Kraftile plans. During the past seven months, 321 Quonset buildings have been sold in the San Francisco-Oakland Bay Area by Kraftile. Jos. Peebles directs



STRAN-STEEL PRE-CUT FRAMING in place. Inspecting framing for 24-foot by 36-foot home recently erected at Pittsburg demonstration are, Chas. W. Kraft, President (left), Joe Peebles, Manager, Kraftile's Stran-Steel Division, and Jim Crawford, Vice President and Sales Manager of Kraftile Company.

ales of the Stran-Steel Division of Kraftile Company, under the supervision of Jas. Crawford, Kraftile's vice president and director of sales.

At the recent Pittsburg demonstration, features of the "packaged" framing were shown in detail. They added up to the fact that the new product is, in effect, "metal wood" and will hasten the construction of small homes. Utmost flexibility in architectural design and floor plan is permitted because the steel framing is provided with a nailing groove," making possible the use of any collateral material by the conventional application methods. Because of the clear-span roof truss design, interior partitions are non-bearing and can be placed to accommodate any desired floor plan. Window and door openings can be placed anywhere in side or end walls, to within 2 feet of corners. The all-steel framing and floor joists remove the possibility of subsequent shrinkage, warping, or sagging, resulting in a sound structure with permanent value at minimum upkeep and repair expense.

Standard "packages," it was made known, consist of all studs, joists, channel plates, bridging and other parts required, accurately cut to length, painted, punched and ready for pre-assembly by arc welding. Standard width of framing is 24 ft. with a 28-ft. length minimum. The length can be increased in multiples of 2 feet to any length desired. Kraftile's pre-assembly service will furnish fully welded roof trusses, side wall and end wall panels. Under this system of purchase, a builder could frame several houses a day with a normal sized crew.

EXPORT CONTROL OF BUILDING MATERIALS

More than 50 items of building materials and equipment essential to the Veterans Emergency housing program have been placed under export control during the period immediately preceding September 20.

Thirty-two items were placed under control, effective August 20, and 19 others, all iron and steel commodities, were added as of September 11. This brings to more than 150 the number of items now under control.

BUILDING MATERIALS OUTLOOK

The outlook for increased production of building materials, methods of lowering building costs, and the effect of governmental controls on construction were highlighted subjects at the recent annual meeting of the Producers' Council in New York City.

Opinion varied as to eventual solution of the questions, although consensus agreed virtual elimination of governmental restrictions was essential.

Full Power To Act

In planning homes of tomorrow — whether they be new or re-modeled . . . be sure to prepare them for your clients' fullest enjoyment of electrical living.

Make certain you specify wiring adequate to serve all their needs . . . so they may connect and operate properly the electrical servants they have now, and the marvelous new ones they are sure to want.

Provide that full power in future homes you design by specifying plenty of outlets, switches and circuits, and large enough wire to deliver full power now and in the years to come.

Only with adequate wiring will all electrical appliances have FULL POWER TO ACT . . . efficiently, economically, conveniently.

NORTHERN CALIFORNIA ELECTRICAL BUREAU

1355 MARKET STREET
SAN FRANCISCO 3



NEWS & COMMENT ON ART

(Continued from Page 9)

tion, according to Ernest B. Heller, president of the Heller-Deltah Company, sponsor of the contest.

Selection of the competing artists was made by an Invitation Jury composed of artists and museum directors including: Aaron Bohrod; Gladys Rockmore Davis; Stuart Davis; Philip Guston; Leon Kroll; Fletcher Martin; Eugene Speicher; Max Weber; Alfred H. Barr, Jr., Museum of Modern Art; Perry T. Rathbone, City Art Museum of St. Louis.

The competition has been designed as a "contest by artists for artists to stimulate the best expression of American art without regard to subject or treatment."

Each member of the Invitation Jury has nominated ten or more artists representing the foremost art creators working in America today.

The prizes will be cash awards, not purchase prizes, and will be distributed as follows: First prize, \$2,000; second prize, \$1,500; third prize, \$1,000; fourth prize, \$750; fifth prize, \$500; sixth prize, \$250; seventh, eighth, ninth and tenth prizes to be known as "honorable mentions," \$100 each.

The closing date for receipt of entry blanks will be October 15, 1946, and contestants will be required to ship or deliver their paintings no later than December 1, 1946.



"GOODS OF THE WOODS"
E.K. WOOD LUMBER CO.

LOS ANGELES

Branch Offices

HOLLYWOOD	SIERRA MADRE	UPLAND
PASADENA	TEMPLE CITY	LA VERNE
LONG BEACH	WHITTIER	SAN PEDRO
RIVERSIDE	ONTARIO	INDIO

OAKLAND
SAN FRANCISCO

HEADLINE NEWS & VIEWS

By E. H. W.

With great fan-fare, publicity, and beating of the tom-toms, OPA announces it is "quietly" investigating large scale price rackets in lumber, used cars, and other fields . . . firemen tell us it doesn't make any difference how loud you blow a siren going to a fire—it takes action to put the fire out.

* * *

There are approximately two million stores in the United States today in need of lighting which will benefit the store owner and the buyer.—F. C. Winkler, Development Engineer, Westinghouse Electric Corporation.

* * *

By 1950 approximately 17 million women 14 years and older are expected to be holding down jobs in industry. Between 500,000 and 1,000,000 more than there would have been without a war. During the peak of the war, one out of three workers in the Nation was a woman.

* * *

After reading a news item from Sacramento relative to a non-resident obtaining a California driver's license, who are we to question such an eminent authority on the subject of the motorist "being bilked" as the State director of motor vehicles.

* * *

No one has a good answer to the question "What's wrong with the stock market" . . . could be governmental inefficiency interfering with industry.

* * *

A Stockton, California, building is constructed with bales of hay for walls . . . let's hope the "Wolf" isn't just around the corner.

* * *

Government restrictions on the construction industry is holding back job producing construction and is interfering with training of an adequate number of apprentices in certain crafts and trades to meet the backlog of commercial and industrial construction in the future.—H. E. Foreman, managing director, Associated General Contractors of America.

* * *

The American Society for Metals has announced preliminary plans for holding its Western Metal Congress and Exposition in the San Francisco-Oakland area for six days beginning March 22, 1947 . . . we understand the event will be held in the Oakland Civic Auditorium.

* * *

SUCCESS is a journey, not a destination.

IN THE NEWS

ENGINEERING DRAWING

Included in the University Extension classes at the University of California at Berkeley are eight classes in "Engineering Drawing."

DONNELL E. JAEKLE, Architect, has moved to 201 South Market Street, San Jose.

SULLIVAN AIR WINCH

The Sullivan Division of the JOY MANUFACTURING CO., Michigan City, Indiana, have announced a new, small, lightweight, air-powered hoist.

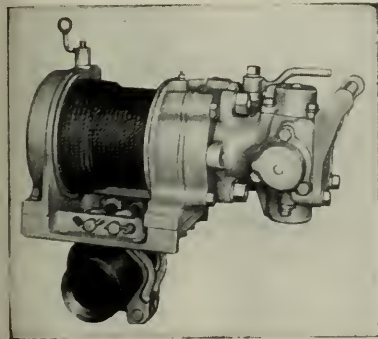

Capable of lifting 500 lbs., the "AIR WINCH" AW-80 weighs only 85 pounds, has a rope capacity of 150 feet of 1/4-in. rope, is 18 inches long, 9 1/2 inches high and 11 inches wide. It is powered with a four-cylinder, reversible, piston type air motor. Can be mounted in any position. Complete information Bulletin No. 76-H.

ROBERT W. HUNT COMPANY ENGINEERS

The Robert W. Hunt Company, Engineers, with general offices in Chicago, and branch office in San Francisco, announce that D. W. McNaugher, Jr., Vice President, has also been appointed treasurer; and that S. C. Sexauer, Assistant Secretary, has been named Secretary of the Company.

H. DENMAN SCOTT, Architect, has moved to 1273 Westwood Boulevard, Los Angeles, California.

ARCHITECTS MOVE

The firm of BIRGE M. CLARK & WALTER STROMQUIST, Architects, are now located in their own office building at 321 Channing Avenue, Palo Alto, California.

New!

TURRET-TYPE FLUORESCENT LUMINAIRE

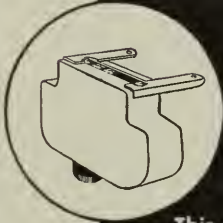

*using the new
Twin Turret
Lampholder*

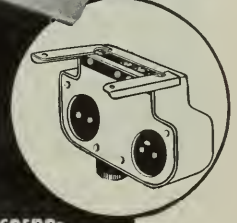

This new SMOOT-HOLMAN fixture incorporates the new turret lampholder which holds the lamps firmly in place without additional safeguards. The lamps are quickly inserted by depressing either face of the turret with one end of the lamp until the other end clears the opposite face and slips into place. The turret lampholder permits use of the new Jack Rabbit, for split-second starting. The luminaire itself is crafted according to Smoot-Holman quality and conforms to the new 9A RLM specification. Overall length 49 1/4", width 11 1/4", height 7".

Catalog No. NET - 2461

SMOOT-HOLMAN COMPANY

SMOOT-HOLMAN

INGLEWOOD, CALIFORNIA

MADE IN U.S.A.



Offices in Principal Western Cities—Branch and Warehouse in San Francisco

PRODUCER'S COUNCIL PAGE

The National Organization of Manufacturers of Quality Building Materials and Equipment
affiliated with THE AMERICAN INSTITUTE OF ARCHITECTS

President, E. E. CATHCART
Johns-Manville Sales Corp.
116 New Montgomery St.

Vice-President, C. J. NICHOLAS
Bastian-Marley Co.
301 Brannon St.

Secretary, H. C. GALITZ
Westinghouse Electric Corp.
110 Sutter St.

Treasurer, E. P. LARSON
Celotex Corp.
675 Townsend St.

Edited by C. W. KRAFT, KRAFTILE CO., Niles, California

NORTHERN CALIFORNIA CHAPTER



WAYNE I. RAWLINGS
Vice President and General Manager
Harbor Plywood Corp. of Calif.

Another newcomer to Chapter activities is Wayne I. Rawlings, Vice President and Manager of Harbor Plywood Corporation of California. Wayne's firm is a new member of the Council, joining as a Regional Member.

Wayne grew up in and with the plywood industry, seeing it go from 153 million feet in 1925 to 1 billion 425 million in 1945. During this time he worked his way from a warehouse of his Company in 1926 to the "front office" in 1945.

He dates the Golden Gate International Exposition—up to that time the largest concentration of plywood on any one project—as the beginning of recognition of plywood as a structural material.

Wayne hails from Illinois, came to San Francisco in 1922, got his schooling at San Francisco School of Business Administration.

He is married, has one son, lives in San Francisco. He is a Past Master of Golden Gate Lodge No. 30, F. & A. M. His favorite sports are golf and hunting.

CHUCK KRAFT attended the Fall Meeting of the Council in New York, September 25-26. As a sign of the times, Chuck reports that emphasis was placed on Marketing and Public Relations.

COUNCIL BUILDING PRODUCTS DIRECTORY is ready for distribution. This will be handled by direct mail from the Washington Office supplied

mented by Chapter distribution through its members.

MODULAR MOMENTS

Question: Is not that 7/16" clearance from the bar center to the brick face more than the half joint which the brickwork would normally provide at a coordinated window?

Mr. Lorimer: Yes. It is 3/16" to 1/4" more, and is generally achieved by crowding slightly a few vertical joints on either side of the window. The solid-section steel windows are the only type of coordinated window that require any such compromise or adjustment. Double-hung windows in steel and wood, and certain aluminum sash require no such adjustment.

This completes our little series of questions and answers on Modular Planning, covering questions most often asked of A. Gordon Lorimer, Chief, Bureau of Architecture, City of New York. Questions, of course, will arise from time to time as to application of the principles of Dimensional Coordination to specific situations. Please do not hesitate to call on the Technical Information Committee of this Chapter for assistance.

MODULAR PLANNING is here. "A62 Guide for Modular Coordination," by Myron W. Adams, is an important manual giving the techniques of modular coordination. This book, containing 280 pages and 300 drawings and illustrations, can be had at \$10.00 per copy from

Modular Service Association
110 Arlington Street
Boston 16, Mass.

The chapters are:

- | | |
|---------------------------|----------------------------------|
| 1. The Standard Basis | 7. Windows |
| 2. Modular Masonry | 8. Doors |
| 3. Structural Facing Tile | 9. Glass Block |
| 4. Custom Masonry | 10. Skeleton Frame |
| 5. Floors | 11. Stairs |
| 6. Wood Frame | 12. Examples of Working Drawings |

(Continued on Next Page)

USE QUALITY PRODUCTS



CONSULT AN ARCHITECT

PRODUCERS COUNCIL PAGE

(Continued from Opposite Page)

OTHER INTERESTING BULLETINS

The ASA Standards Council has approved publication of "American Standard Sizes of Clay and Concrete Modular Masonry Units—A62.3-1946." Copies may be obtained at 25 cents each from the American Standards Association, 70 East Forty-fifth Street, New York 17, N. Y.



Bulletin No. 3, issued by T. I. Coe, Technical Secretary, A.I.A., includes a liberal review under the heading "Modular Coordination Is Moving Forward."

FURTHER INFORMATION on specific products dimensionally coordinated is available from manufacturers in a growing flood of technical data.

INVENTIVE GENIUS OF LOCK INDUSTRY DIES

The passing of Walter R. Schlage, 63, in San Francisco recently brought to a close a long life of inventive genius in the lock making industry of America.

A poor immigrant boy from Germany in 1902, Schlage settled in the San Francisco Bay Area in 1906 and from a meager beginning in a machine shop rose through the development of electric, push-pull knob, tilting knob lock, and the cylindrical lock mechanism to the presidency of the Schlage Lock Company, internationally known.

He was one of those few inventors who live to enjoy the profit and recognition of his own inventions.

LITTLE IS NAMED DEAN OF UNIVERSITY OF OREGON SCHOOL OF ARCHITECTURE

Sidney Wahl Little, associate professor in the School of Architecture and Arts in Alabama Polytechnic Institute and recognized practicing architect, has been named Dean of Oregon's School of Architecture and Allied Arts, according to an announcement by Dr. Harry K. Newburn, University President.

Dean Little received his education at Cornell University, Ithaca, N. Y., where his baccalaureate degree was granted; at Tulane University, where he received his master of architecture degree; at the University of Pennsylvania; the Ecole Beaux Arts at Fontainebleau, France, awarded him a diploma; a certificate was awarded him by the

FORDERER CORNICE WORKS

Manufacturers of

Hollow Metal Products • Interior Metal Trim
Elevator Fronts and Cabs
Metal Plaster Accessories • Sanitary Metal Base
Flat and Roll Metal Screens
Metal Cabinets • Commercial Refrigerators

269 POTRERO AVE.

SAN FRANCISCO, CALIF.

HEMLOCK 4100

STRUCTURAL STEEL

For Class A Buildings,
Bridges, etc.

JUDSON PACIFIC - MURPHY CORP.

1200 SEVENTEENTH STREET

SAN FRANCISCO

Plants: San Francisco - Oakland

SISALKRAFT

REG. U. S. PAT. OFF.

"More than a building paper"

THE SISALKRAFT CO.

205 West Wacker Drive

Chicago, Ill.

55 New Montgomery Street

San Francisco, Calif.

BASALITE

LIGHTWEIGHT CONCRETE
BUILDING UNITS

CHARACTER • ECONOMY • INSULATION
FIRE-SAFE • TERMITE PROOF • PERMANENCE

BASALT ROCK CO., INC.

NAPA, CALIFORNIA



PRESSURE TREATED LUMBER
● PROTECTS AGAINST DECAY
AND TERMITE ATTACK

Specify it in your home
Available through Lumber Dealers

LOS ANGELES
 601 W. 5th Street
 Phone MIchigan 6294

SAN FRANCISCO
 333 Montgomery Street
 Phone DOuglas 3883

J. H. Baxter & Co.

AGENTS FOR WEST COAST WOOD PRESERVING CO. SEATTLE, WASH.

VALUABLE
NEWS SERVICE

Building material dealers, contractors, engineers, and financial institutions find ARCHITECT'S REPORTS highly valuable in the operation of their business.

ISSUED DAILY at a total cost of \$10 per month these handy, individual slip-reports give ADVANCE news on construction projects in Northern California . . . listing name of project, location, architect, proposed cost and other pertinent information.

DON'T DELAY! SUBSCRIBE TODAY!

ARCHITECT'S REPORTS

Published Daily by

ARCHITECT and ENGINEER, Inc.

68 Post Street, San Francisco

EXbrook 7182

American University in Florence, Italy. He has traveled widely in Europe.

Chiefly a designer and a design critic, he is considered outstanding in his field.

Dean Little was recently discharged from the army with a brilliant record of service.

CALIFORNIA CORRUGATED CULVERT

The California Corrugated Culvert Company, a wholly owned subsidiary of The American Rolling Mill Company, was taken over by the Calco Division of Armco Drainage & Metal Products, Inc., on October 1, 1946.

The new organization, which is also a wholly owned subsidiary of The American Rolling Mill Company, will continue business from the Berkeley, California, plant with the same personnel.

VETERANS EMERGENCY HOUSING

During the month ending September 10, 14,664 emergency temporary accommodations were added to the veterans' temporary housing supply.

Including war housing and low-rent housing, more than 300,000 veterans, servicemen and their families now live in public housing, according to NHA officials.

WINDOW BOXES

(Continued from Page 11)

trees provide the shade. But these trees are trained first for the comfort of the tourists using the promenade: they provide shade; second the trees are trimmed so those in the apartments and hotel rooms above may still enjoy the view of the lake and distant mountains. Then the window boxes, filled with seasonal flowers in spring and summer and with little cedars and spruces in winter, can be enjoyed by all.

I used to take my garden class up to Russian Hill to the little home of the late Arthur Francis Lundberg. He had come back from a European sojourn thrilled with window box ideas. It was just the thing for him because his house stood on bare rock, not a bucket of soil there, only what he brought up himself. He built window boxes on all sides. On the north he planted ferns. On the west under a pepper tree he had seasonal things: tuberous rooted begonias in summer, primroses in spring; on the south and east he elaborated into miniature gardens. With dwarf plants, succulents, little cypress trees, and scraggly veronicas, he built up miniature Chinese and Japanese gardens; and bits of Venice and Naples—with pools for gold fish, little bridges, garden lamps, and at night especially the effect was enchanting.

ESTIMATOR'S GUIDE

BUILDING AND CONSTRUCTION MATERIALS

PRICES GIVEN ARE FIGURING PRICES AND ARE MADE UP FROM AVERAGE QUOTATIONS FURNISHED BY MATERIAL HOUSES TO SAN FRANCISCO CONTRACTORS. 2 1/2% SALES TAX ON ALL MATERIALS BUT NOT LABOR

All prices and wages quoted are for San Francisco and the Bay District. There may be slight fluctuation of prices in the interior and southern part of the state. Freight cartage, at least, must be added in figuring country work.

BONDS—Performance—\$10 per \$1000 of contract. Labor and materials, \$10 per \$1000 of contract.

BRICKWORK—
Common Brick—Per 1M laid—\$50.00 to \$60.00 (according to class of work).
Face Brick—Per 1M laid—\$120 to \$150 (according to class of work).
Brick Steps—\$1.60 per lin. ft.
Brick Veneer on Frame Bldg.—Approx. \$1.30 per sq. ft.

Common Brick—\$19.00 per M, truckload lots, f.o.b. job.
\$19.00 per M, less than truckload, plus cartage.
Face Brick—\$40 to \$80 per M, truckload lots, delivered.
Cartage—Approx. \$4.00 per M.

BUILDING PAPER—
1 ply per 1000 ft. roll.....\$3.50
2 ply per 1000 ft. roll..... 5.00
3 ply per 1000 ft. roll..... 6.25
Brownskin, Standard, 500 ft. roll..... 5.00
Stralkraft, 500 ft. roll..... 5.00
Sash cord com. No. 7.....\$1.20 per 100 ft.
Sash cord com. No. 8..... 1.50 per 100 ft.
Sash cord spot No. 7..... 1.90 per 100 ft.
Sash cord spot No. 8..... 2.25 per 100 ft.
Sash weights, cast iron, \$50.00 ton.
Nails, \$3.42 base.
Sash weights, \$45.00 per ton.

CONCRETE AGGREGATES—
The following prices net to Contractors unless otherwise shown.
Gravel, all sizes—
\$1.95 per ton at Bunker; delivered\$2.50
Bunker Del'd
Top Sand\$1.90\$2.50
Concrete Mix 1.90 2.45
Crushed Rock, 1/4" to 3/4"..... 1.90 2.50

Crushed Rock, 3/4" to 1 1/2"..... 1.90 2.50
Roofing Gravel 2.25 2.80
River Sand 2.00 2.45

Sand—
River Sand 2.00 2.45
Lapis (Nos. 2 & 4)..... 2.85 3.15
Olympia (Nos. 1 & 2)..... 2.85 3.10
Del Monte White84c per sack

Cement—
Common (all brands, paper sacks), carload lots, \$2.42 per bbl. f.o.b. car; delivered \$2.72.
Cash discount on carload lots, 10c a bbl., 10th prox.; less than carload lots \$3.20 per bbl. f.o.b. warehouse or delivered.
Cash discount 2% on L.C.L.

Atlas White } 1 to 100 sacks, \$2.50 sack
Calaveras White } warehouse or del.; \$7.65
Medusa White } bbl. carload lots.
Forms labor average \$350 per 1000 sq. feet.
Average cost of concrete in place, 50c per cubic foot, exclusive of forms; \$15.00 per cubic yard. With forms \$1.60 per cubic foot.

DAMP-PROOFING and Waterproofing—
Two-coat work, \$3.50 per square.
Membrane waterproofing—4 layers of saturated felt, \$7.00 per square.
Hot coating work, \$2.50 per square.
Medusa Waterproofing, \$3.50 per lb. San Francisco Warehouse.
Tricocel waterproofing.
(See representative.)

ELECTRIC WIRING—\$12 to \$15 per outlet for conduit work (including switches).
Knob and tube average \$3.00 per outlet. (Available only for priority work.)

ELEVATORS—
Prices vary according to capacity, speed and type. Consult elevator companies. Average cost of installing a slow speed automatic passenger elevator in small four story apartment building, including entrance doors, about \$6500.00.

EXCAVATION—
Sand, 60 cents; clay or shale \$1 per yard.

Trucks, \$20 to \$32 per day.
Above figures are an average without water. Steam shovel work in large quantities, less; hard material, such as rock, will run considerably more.

FIRE ESCAPES—
Ten-foot galvanized iron balcony, with stairs, \$150 installed on new buildings; \$160 on old buildings.

FLOORS—
Composition Floors, such as Magnesite, 50c per square foot.
Linoflor—2 gages—\$1.25 to \$2.75 per sq. yd.
Mastipave—90c to \$1.50 per sq. yd.
Battleship Linoleum—available to Army and Navy only—1/8"—\$1.75 sq. yd.
3/8"—\$2.00 sq. yd.
Terrazzo Floors—50c to 70c per sq. ft.
Terrazzo Steps—\$1.75 per lin. ft.
Mastic Wear Coat—according to type—20c to 35c.

Hardwood Flooring—
Standard Mill grades not available.
Victory Oak—T & G
3/4" x 2 1/4".....\$143.25 per M. plus Cartage
1/2" x 2"..... 122.00 per M. plus Cartage
1/2" x 1 1/2"..... 113.50 per M. plus Cartage
Prefinished Standard & Better Oak Flooring
3/4" x 3 1/4".....\$180.00 per M. plus Cartage
1/2" x 2 1/2"..... 160.50 per M. plus Cartage
Maple Flooring
3/4" T & G Clear \$160.50 per M. plus Ctg.
2nd 153.50 per M. plus Ctg.
3rd 131.25 per M. plus Ctg.
Floor Layers' Wage, \$1.87 1/2 per hr. (Legal as of Jan. 21, 1946. Given us by Inlaid Floor Co.)

GLASS—
Single Strength Window Glass.....20c per □ ft
Double Strength Window Glass.....30c per □ ft.
Plate Glass, under 75 sq. ft.....\$1.00 per □ ft.
Polished Wire Plate Glass..... 1.40 per □ ft.
Rgh. Wire Glass34 per □ ft.
Obscure Glass27 per □ ft.
Glazing of above is additional.
Glass Blocks\$2.50 per □ ft. set in place

HEATING—
Average, \$1.90 per sq. ft. of radiation, according to conditions.
Warm air (gravity) average \$64 per register.
Forced air, average \$91 per register.

IRON—Cost of elemental iron, cast iron, etc., depends on design.

LUMBER—All lumber at O.P.A. ceiling prices—

No. 1 Common.....	\$49.00 per M
No. 2 Common.....	47.75 per M
Select O. P. Common.....	52.75 per M

Flooring—

	Delvd.
V.G.-D.F. 8 & Btr. 1 x 4 T & G Flooring.....	\$80.00
C 1 x 4 T & G Flooring	75.00
D 1 x 4 T & G Flooring	65.00
D.F.-S.G. 8 & Btr. 1 x 4 T & G Flooring	61.00
C 1 x 4 T & G Flooring	59.00
D 1 x 4 T & G Flooring	54.00
Rwd. Rustic—"A" grade, medium dry.....	82.00
3 to 20 feet	
"8" grade, medium dry.....	78.50
6 to 20 feet	

Plywood—not available

	Under \$200	Over \$200
"Plyscord"— $\frac{3}{8}$ "	\$49.50	\$47.55
"Plywall"— $\frac{1}{4}$ "	45.15	43.30
3 ply— $\frac{2}{8}$ — $\frac{1}{4}$ "	48.55	46.60
"Plyform"— $\frac{3}{8}$ "—		
Unoiled	126.50	121.45
Oiled	127.90	122.75

Above prices delivered if quantity is sufficient to warrant delivery.

Shingles (Rwd. not available)—

Red Cedar No. 1—\$6.75 per square; No. 2, \$5.75; No. 3, \$4.45.
Average cost to lay shingles, \$3.00 per square.
Cedar Shakes—Tapered: $\frac{1}{2}$ " to $\frac{3}{4}$ " x 25"—\$8.95 per square.
Resawn: $\frac{3}{4}$ " to $1\frac{1}{4}$ " x 25"—\$10.65 per square.
Resawn: $\frac{3}{4}$ " to $1\frac{1}{4}$ " x 25"—\$10.65 per square.
Average cost to lay shakes, \$4.00 per square.

MILLWORK—Standard.

D. F. \$100 per 1000. R. W. Rustic \$100.00 per 1000 (delivered).
Double hung box window frames, average with trim \$6.50 and up, each.
Complete door unit, \$10.00.
Screen doors, \$3.50 each.
Patent screen windows, 25c a sq. ft.
Cases for kitchen pantries seven ft. high, per lineal ft., \$9.00 each.
Dining room cases, \$9.00 per lineal foot.
Rough and finish about 80c per sq. ft.
Labor—Rough carpentry, warehouse heavy framing (average), \$40.00 per M.
For smaller work average, \$40.00 to \$55.00 per 1000.

MARBLE—(See Dealers)

PAINTING—

Two-coat work	per yard 50c
Three-coat work	per yard 70c
Cold water painting.....	per yard 10c
Whitewashing	per yard 8c

PAINTS—

Two-coat work	50c per sq. yd.
Three-coat work	70c per sq. yd.
Cold water painting.....	per yard 10c
Whitewashing	8c per sq. yd.
Turpentine \$1.03 per gal. in drum lots.	
\$1.08 per gal. in 5-gal. containers.	
Raw Linseed Oil—not available.	

Boiled Linseed Oil—\$1.38 per gal. in drums. Available only to work with high priority—\$1.48 per gal. in 5-gal. containers.

Use replacement oil—\$1.86 per gal. in 1-gal. containers.

Replacement Oil—\$1.20 per gal. in drums. \$1.30 per gal. in 5-gal. containers.

A deposit of \$6.00 required on all drums.

PATENT CHIMNEYS—

6-inch	\$1.20 lineal foot
8-inch	1.40 lineal foot
10-inch	2.15 lineal foot
12-inch	2.75 lineal foot

PLASTER—

Neat wall, per ton delivered in S. F. in paper bags, \$17.60.

PLASTERING (Interior)—

3 Coats, metal lath and plaster	Yard \$2.25
Keene cement on metal lath	2.70
Ceilings with $\frac{3}{4}$ hot roll channels metal lath (lathed only)	1.80
Ceilings with $\frac{3}{4}$ hot roll channels metal lath plastered	3.30
Single partition $\frac{3}{4}$ channel lath 1 side (lath only)	1.80
Single partition $\frac{3}{4}$ channel lath 2 inches thick plastered	4.80
4-inch double partition $\frac{3}{4}$ channel lath 2 sides (lath only)	3.30
4-inch double partition $\frac{3}{4}$ channel lath 2 sides plastered	5.75
Thermax single partition: 1" channels; $\frac{2}{4}$ " overall partition width. Plastered both sides	4.95
Thermax double partition: 1" channels; $\frac{4}{4}$ " overall partition width. Plastered both sides	6.60
3 coats over 1" Thermax nailed to one side wood studs or joists	2.45
3 coats over 1" Thermax suspended to one side wood studs with spring sound isolation clip	2.85
Note—Channel lath controlled by limitation orders.	

PLASTERING (Exterior)—

2 coats cement finish, brick or concrete wall.....	Yard \$2.00
3 coats cement finish, No. 18 gauge wire mesh	3.00
Lime—\$4.00 per bbl. at yard.	
Processed Lime—\$4.15 per bbl. at yard.	
Rock or Grip Lath— $\frac{3}{8}$ "—30c per sq. yd.	
$\frac{1}{2}$ "—29c per sq. yd.	

Composition Stucco—\$2.70 to \$3.00 sq. yard (applied).

PLUMBING—

From \$100.00 per fixture up, according to grade, quantity and runs.

ROOFING—

"Standard" tar and gravel, 4 ply—\$8.00 per sq. for 30 sqs. or over.	
Less than 30 sqs. \$9.50 per sq.	
Tile, \$30.00 to \$40.00 per square.	
Redwood Shingles, \$7.50 per square in place.	
$\frac{5}{2}$ #1-16" Cedar Shingles, $\frac{4}{2}$ " Exposure	\$8.00 square

5/8 x 16"—#1 Cedar Shingles, 5" Exposure	\$9.00 square
4/2 #1-24" Royal Shingles, 7/2" Exposure	\$9.50 square
Re-coat with Gravel \$4.00 per sq.	
Asbestos Shingles, \$23 to \$28 per sq. laid	
1/2 x 25" Resawn Cedar Shakes, 10" Exposure	\$10.50
3/4 x 25" Resawn Cedar Shakes, 10" Exposure	11.50
1 x 25" Resawn Cedar Shakes, 10" Exposure	12.50
Above prices are for shakes in place.	

SHEET METAL—

Windows—Metal, \$1.75 a sq. ft.
Fire doors (average), including hardware \$2.00 per sq. ft.

SKYLIGHTS—(not glazed)

Copper, 90c sq. ft. (flat).
Galvanized iron, 40c sq. ft. (flat).
Vented hip skylights 60c sq. ft.

STEEL—STRUCTURAL—

\$150 ton (erected), this quotation is an average for comparatively small quantities. Light truss work higher. Plain beams and column work in large quantities \$140 per ton.

STEEL REINFORCING—

\$100 to \$130 ton, set.

STONE—

Granite, average, \$6.50 cu. foot in place
Sandstone, average Blue, \$4.00. Boise \$3.00 sq. ft. in place.
Indiana Limestone, \$2.80 per sq. ft. in place.

STORE FRONTS (None available).

TILE—

Ceramic Tile Floors—\$1.00 to \$1.25 per sq. ft.
Cove Base—\$1.10 per lin. ft.
Glazed Tile Wainscot—\$1.25 per sq. ft.
Asphalt Tile Floor $\frac{1}{8}$ " & $\frac{3}{8}$ "—\$.18 to \$.35 per sq. ft. Light shades slightly higher.
Cork Tile—\$.40 to \$.75 per sq. ft.
Mosaic Floors—see dealers.
Lino-Tile, \$.35 to \$.75 per sq. ft.

Wall Tile—

Glazed Terra Cotta Wall Units (single faced laid in place—approximate prices:
2 x 6 x 12..... \$1.10 sq. ft.
4 x 6 x 12..... 1.25 sq. ft.
2 x 8 x 16..... 1.20 sq. ft.
4 x 8 x 16..... 1.40 sq. ft.

VENETIAN BLINDS—

40c per square foot and up. Installation extra.

WINDOWS—STEEL—

30c per square foot, \$5 for ventilators.

IN THE NEWS

WASHINGTON STATE LAND COMMISSION

Edmund F. Cardin of Tacoma, Washington, a timberman for 33 years, has been appointed liaison officer between the NHA and the Washington State Land Commission, with offices in Olympia.

Under agreement the Federal Government will compensate the State for added expenses incurred in doubling the amount of state-owned timber offered for sale between now and the end of 1947. It is estimated three billion board feet will thus become available.

ANNUAL PABCO MEETING

At the annual meeting of stockholders of the Paraffine Companies, Inc., recently held in San Francisco, the following officers and directors were re-elected:

Bruce F. Brown, C. C. Gibson, W. H. Lowe, J. B. McCargar, Robert W. Miller, R. S. Shainwald, D. J. Murphy, Silas H. Palmer, Herman Phleger, Henry Rosenfeld, and R. H. Shainwald, directors.

Officers included: R. S. Shainwald, Chairman of the Board; W. H. Lowe, President; R. H. Shainwald, Executive Vice-President; C. C. Gibson, Vice-President and Treasurer; J. E. Holbrook, Vice-President in Charge of Sales; F. M. Tussing, Vice-President, Manufacture; R. R. Marsh, Vice-President, Overseas Trade; and A. W. Brown, Secretary.

HEATING AND VENTILATING EXPOSITION SCHEDULED

The 7th International Heating and Ventilating Exposition has been set for next January 27-31, in Cleveland, Ohio.

Expansion in the manufacture of heating and ventilating equipment, a number of inventions, air conditioning and industrial refrigeration will be exhibited by a large number of manufacturers during the exposition.

BUILDING TRADES WAGE (JOB SITES) NORTHERN AND CENTRAL CALIFORNIA

ATTENTION: The following are the PREVAILING hourly rates of compensation as determined by the Wage Adjustment Board, or which have been determined by the United States Department of Labor—Revised to July 1, 1946. Wage scales shown are those being paid and in effect mostly by agreement between employees and their union.

CRAFT	San Francisco	Alameda and Contra Costa	Marin	Vallejo	San Mateo	San Jose	Stockton	Sacramento	Fresno
	ASBESTOS WORKERS.....	1.75	1.75	1.75	1.75	1.75	1.75	1.75	1.75
BRICKLAYERS.....	2.05	2.05	2.05	2.05	2.05	2.05	1.75	2.05	2.00
BRICKLAYERS, HODCARRIERS.....	1.57 1/2	1.57 1/2	1.57 1/2	1.57 1/2	1.57 1/2	1.57 1/2	1.47 1/2	1.15	1.25
CARPENTERS.....	1.75	1.75	1.75	1.75	1.75	1.62 1/2	1.50	1.50	1.50
CEMENT FINISHERS.....	1.75	1.75	1.75	1.75	1.75	1.75	1.75	1.75	1.75
ELECTRICIANS.....	1.87 1/2	1.87 1/2	1.87 1/2	1.70	1.87 1/2	1.87 1/2	1.75	1.82 1/2	1.75
ENGINEERS: MATERIAL HOIST.....	1.60	1.60	1.60	1.60	1.60	1.60	1.60	1.60	1.60
PILE DRIVER.....	2.00	2.00	2.00	2.00	2.00	2.00	2.00	2.00	2.00
STRUCTURAL STEEL.....	2.00	2.00	2.00	2.00	2.00	2.00	2.00	2.00	2.00
GLASS WORKERS.....	1.58 1/2	1.58 1/2	1.58 1/2	1.58 1/2	1.58 1/2	1.21	1.40	1.37 1/2	1.37 1/2
IRONWORKERS: ORNAMENTAL.....	1.85	1.85	1.85	1.85	1.85	1.85	1.85	1.85	1.85
REINF. RODMEN.....	1.75	1.75	1.75	1.75	1.75	1.75	1.75	1.75	1.75
STRUCTURAL.....	2.00	2.00	2.00	2.00	2.00	2.00	2.00	2.00	2.00
LABORERS: BUILDING & CONCRETE.....	1.25	1.25	1.15	1.15	1.15	1.15	1.25	1.25	1.15
LATHERS.....	1.90	1.90	1.60	1.87 1/2	1.75	2.00	1.87 1/2	1.60	1.87 1/2
MARBLE SETTERS.....	1.75	1.75	1.75	1.75	1.75	1.75	1.75	1.75	1.75
MOSAIC & TERRAZZO.....	1.75	1.75	1.75	1.75	1.75	1.75	1.60	1.16	1.12 1/2
*PAINTERS.....	1.75	1.75	1.75	1.64	1.75	1.75	1.60	1.60	1.50
PILEDRIVERS.....	1.86	1.86	1.86	1.86	1.86	1.86	1.86	1.86	1.86
PLASTERERS.....	2.00	2.00	1.75	2.00	2.05	2.00	2.00	1.87 1/2	1.87 1/2
PLASTERERS' HODCARRIERS.....	1.75	1.75	1.75	1.75	1.75	1.75	1.65	1.65	1.40
PLUMBERS.....	1.87 1/2	1.87 1/2	1.87 1/2	1.87 1/2	1.87 1/2	1.87 1/2	1.87 1/2	1.87 1/2	1.87 1/2
ROOFERS.....	1.50	1.62 1/2	1.50	1.62 1/2	1.25	1.37 1/2	1.50	1.50	1.50
SHEET METAL WORKERS.....	1.75	1.75	1.75	1.75	1.75	1.75	1.75	1.75	1.75
SPRINKLER FITTERS.....	1.58	1.58	1.58	1.58	1.58	1.58	1.58	1.58	1.58
STEAMFITTERS.....	1.87 1/2	1.87 1/2	1.87 1/2	1.87 1/2	1.87 1/2	1.87 1/2	1.87 1/2	1.87 1/2	1.87 1/2
STONESETTERS (MASONS).....	2.05	2.05	2.05	2.05	2.05	2.05	1.75	2.05	2.00
TILESETTERS.....	1.80	1.75	1.75	1.75	1.75	1.75	1.37 1/2	1.37 1/2	1.37 1/2

Prepared and compiled by

CENTRAL CALIFORNIA CHAPTER, ASSOCIATED GENERAL CONTRACTORS OF AMERICA

with the assistance and cooperation of secretaries of General Contractors Associations and Builders Exchanges of Northern California.

CLASSIFIED ADVERTISING

RATE: 10c PER WORD . . . CASH WITH ORDER

MINIMUM \$2.50

ARCHITECT'S REPORTS—A valuable advance news service giving building and construction information daily on projects in Northern California. Name, location, architect, proposed cost, etc., on individual slips. Ideal for securing new business leads. Hundreds of items, total monthly cost only \$10. Don't delay, subscribe today. ARCHITECT & ENGINEER, Room 618, 68 Post Street,

San Francisco, California. Phone DOuglas 8311.

PHOTOGRAPHY—Keep a pictorial record of your building, or construction project. Pictures are of tremendous value to contractors, builders, engineers, architects. For Industrial-Publicity-Aerial photography, see FRED MAE, Room 721-22 Hearst Bldg., San Francisco 3, California.

ENGRAVING—Good engravings are essential to a satisfactory job of printing reproduction. For the best, see Poor Richard Photo Engraving Co., 324 Commercial St., San Francisco.

PRINTING—Printers, bookbinders. See us for commercial printing. Mercury Press, 942 Howard Street, San Francisco.

A.I.A. ACTIVITIES

(Continued from Page 31)

Hervey P. Clark, AIA, Chapter Vice-president, presided in the absence of President Andrew T. Hass, AIA.

Wm. Moore and Wm. Popert discussed earthquake provision of the proposed new San Francisco Building Code, as presented to the San Francisco board of supervisors by the Northern California Structural Engineers Association; while Vincent G. Rainey, AIA, reporting for A. J. Evers, AIA, chairman of the Chapter's Building Code Committee, told of the work being done by the Architects in connection with the drafting of the new code.

HOGAN LUMBER CO.

Wholesale and Retail

LUMBER

MILL WORK • SASH & DOORS

Office, Mill, Yard and Docks

SECOND AND ALICE STREETS • OAKLAND, CALIF.

Telephone GLencourt 6861

CLINTON CONSTRUCTION CO. OF CALIFORNIA

General Contractors

923 FOLSOM STREET • SAN FRANCISCO

SUtter 3440

SANTA MARIA INN SANTA MARIA, CALIFORNIA

FRANK J. McCOY, General Manager

FERNAND E. PIMENTEL, Manager

On the
Coast
Highway
between
San
Francisco
and
Los
Angeles



American
or
European
Plan
•
Old
English
Top
Room

Vincent Palmer, AIA, Los Angeles, and Chairman of the Annual Convention Committee, outlined the Coronado program which will include many items of vital importance to the Architectural profession.

Elmore Hutchinson and Milton Morris presented details of an employee-employer situation confronting members of the Bay Area Civil Engineers Association.

No action was taken relative to the Chapter's previous stand as being opposed to national Roster and Register of architects qualified for Federal public works program.

Ernest Born, AIA, Chapter treasurer, reported 15 new members.

J. Francis Ward, AIA, was program chairman of the meeting.

NEW AIA MEMBERS

Southern California Chapter: New members to receive certificates in the Southern California Chapter recently included: M. L. Barker, Marcus P. Miller, Edward D. Cowley, Kenneth Neptune, Jerome C. DeHetre, G. Lawrence Ott, Harold A. Edmondson, Theodore L. Pletsch, James R. Friend, Griswold W. C. Raetze, Henry J. Jefferson, Walter E. Saxton, Ilton E. Loveless, Lloyd A. Steffgen, Glenn C. McAlister, Save M. Stoshitch, and Harold W. Underhill, Institute Members. Junior Associates included Lionel T. Chadwick, Philip J. Graff, and Robert W. Hall.

Northern California Chapter: New members granted certificates in the Northern California Chapter recently include: Jan Reiner, Lawrence G. Thomson, John F. Beuttler, John M. Evans, Harold W. Hawes, Leonard S. Mosias, William Symonds, Lloyd A. Rasmussen, Howard E. Sweeting, Wilton Smith, George P. Simonds, Curtis Tobey, Oscar R. Thayer, Keith E. Ponsford, Clarence O. Peterson, Francis J. McCarthy, Paul H. Hammarberg, William B. Glynn, W. Roland Gibbs, James H. Anderson.

BOARD OF ARCHITECTURAL EXAMINERS

The California Board of Architectural Examiners report result of the June written examinations as follows:

Examinees taking all or partial written examination totaled 180; 75 or 42 per cent passed to eligibility of oral examination. Out of State architects applying for license numbered 73; 15 were granted licenses, 14 were held pending oral examination, and 44 applicants remained "pending."

At the regular August meeting of the Board it was recommended that the Architect's license fee for 1937 be fixed at \$5.00, and that starting with the June, 1947, written examination, an additional 4-hour examination in "Planning Composition" be added to the requirements for California license.

BOOK REVIEWS

G - E ARC - WELDING ELECTRODES.

Victor Equipment Company, 844 Folsom Street,
San Francisco 7, California.

A comprehensive 102-page book representing data obtained by General Electric in one of the finest electrode development laboratories in the world in collaboration with users who are continually striving to improve their welded products.

Contents include photographs, specifications, charts, tables, design and many other factors dealing with the subjects of how welding electrodes are made; tentative specifications of AWS and ASTM; description of G-E Electrodes; operating data; and engineering data.

WESTERN PINE CAMERA VIEWS For Home Builders: Western Pine Association, Portland 4, Oregon.

New and completely revised edition of booklet that has long been popular as a source of information and ideas for the use of pine wood in home building and remodeling.

More than 73 illustrations showing exteriors, halls and stairs, living rooms, dining rooms, bedrooms, kitchens, dens and playrooms are shown in the 24-page booklet.

File copies sent to architects without cost upon request to the Western Pine Association.

YEOMANS Water Supply and Booster Systems: Yeomans Brothers Company, 1433 N. Dayton Street, Chicago 22, Illinois.

New 16-page catalog, BULLETIN 1500 (A.I.A. File No. 29-D-5) with complete data on determining head and capacity requirements, selecting the proper system and pumping equipment, typical piping and pump installations.

FORMSTONE For Your Home.

The Lasting Products Company, Baltimore 23, Maryland.

Many illustrations in color showing use of FORMSTONE for new construction and renovation of exteriors and interiors, are contained in this new 24-page booklet.

Treatment applies to homes, stores, restaurants, night-clubs, offices, lounges, dens and club cellars. Particles of multicolored natural stone are permanently imbedded under air pressure into the plastic form and hand sculptured into individual stones.

"AMERICAN - MARSH"

CONDENSATION UNIT

Pumping
Machinery
for
Every
Purpose

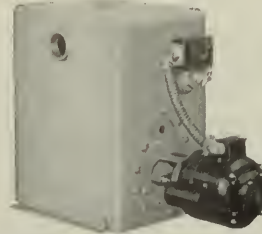

For Service
Call
DOuglas
6794
or
MUtual8322

SIMONDS MACHINERY CO.

SAN FRANCISCO
816 FOLSOM

LOS ANGELES
455 EAST 4TH

VERMONT MARBLE COMPANY

Producers and Finishers
of

Domestic and Imported Marbles

Write for new pamphlet describing our
Marble Toilets and Showers

San Francisco and Los Angeles

San Francisco phone: SUTter 6747



The Most Complete Line of STEELS and BUILDING MATERIALS Made by a Single Producer



See Sweet's Catalog File or write us for
full information.

REPUBLIC STEEL CORPORATION
GENERAL OFFICES: CLEVELAND, OHIO

DENVER, COLORADO CONTINENTAL OIL BUILDING
LOS ANGELES, CALIFORNIA EDISON BUILDING
SALT LAKE CITY, UTAH WALKER BANK BUILDING
SAN FRANCISCO, CALIFORNIA RIALTO BUILDING
SEATTLE, WASH. WHITE-HENRY-STUART BUILDING

PACIFIC MANUFACTURING CO.

HIGH CLASS INTERIOR FINISH
QUALITY MILLWORK

142 SANSOME ST., SAN FRANCISCO
GARfield 7755

6820 MCKINLEY AVE., LOS ANGELES
THornwall 4196

BUILDERS EXCHANGE, OAKLAND

IN THE NEWS

ELSA M. BUSSARD, Architect, has moved to 1273 Westwood Boulevard, Los Angeles, California.

SQUIRREL CAGE MOTOR

One of the "tried and proven" pieces of equipment during the past few years was the Type OG Standard Squirrel Cage Induction electric motor manufactured by THE LOUIS ALLIS CO., of Milwaukee, Wisconsin.



A Bulletin, No. 720, is now available which gives complete information on the motor, its uses, construction, etc.

Venetian Blinds

of
Metal or Wood
for
Homes and Offices

Installed and Serviced

by

GUNN CARLE & CO.

20 POTRERO AVENUE

SAN FRANCISCO 3

Underhill 5480

IN SAN FRANCISCO

Wilson W. Wyatt, National Housing Administrator, spoke before members of the American Legion National Convention in San Francisco on October 3.

GLASS PRICE UP

An increase in factory prices of window glass amounting to approximately 18 per cent, as approved by OPA, has been announced by the Pittsburgh Plate Glass Company. Substantially similar increases in jobbing prices will become effective.

Heavy wage increases throughout the industry are given as the reason for the price increases.

CLAYTON VAN WAGNER, Architect, has moved his offices to 901 Financial Center Building, Oakland, California.

NAMED ADVERTISING MANAGER

Ebbe C. Anderson has been appointed Advertising and Research Manager for the P. & F. Corbin Company, New Britain, Connecticut, national manufacturers and distributors of locks and builders hardware.

NEW FLOOR FURNACE

A new dual floor furnace has been introduced by ROYAL HEATERS, Inc., Alhambra, California.



Model D-45000

Hidden below floor level, it is of shallow flat-bed construction and can be easily installed without basement or pit. Both pilot and burner valves are equipped with safety locks. Only pure warm air is circulated—all air for combus-

tion is taken from the outside. Has the AGA Seal of Approval, easy to install, inexpensive.

BRUSHLESS AUTO PAINT

The TIZ-NU Corporation, Los Angeles, California, announces a new automobile paint that can be applied with a piece of cheesecloth, dries in one hour to a flint-like hardness that will not crack, peel, or crumble.

GEORGE ADAMS, Architect, has changed his address from 216 W. Los Feliz, to P. O. Box 712, Glendale 5, California.

KYLE FORREST

Civil Engineer

Water Supply — Sanitation

Municipal — Private
Consultations — Investigations
Reports — Designs — Valuations
Supervision — Litigation

Ground Water Work a Specialty

Hydrologic studies — wells, de-watering, underdrainage, foundations, conservation, testimony.

1504 Russ Building

San Francisco 4

YUkon 0652

ELMER F. STEIGELMAN

CIVIL ENGINEER

*Structural Design,
Surveying and
Subdivisions*

577 FOURTEENTH STREET

OAKLAND, CALIFORNIA

TWinoaks: 4191

Scott Company

HEATING . . PLUMBING . . TILE

★

243 MINNA STREET

SAN FRANCISCO

Phone EXbrook 6741

G. P. W.
JENSEN & SON

Building Construction

320 Market Street, San Francisco
Phone: GARfield 2444

Basalt Rock Co., Inc.

Ready Mixed Concrete

Building Materials

Basalite Products

SIXTH & BERRY STREETS
SAN FRANCISCO
PHONE: GARFIELD 3758

MULLEN MFG. COMPANY

BANK, STORE AND OFFICE
FIXTURES—CABINET WORK
OF GUARANTEED QUALITY
CHURCH SEATING

Office and Factory:
60-80 RAUSCH ST., Bet. 7th and 8th Sts.
San Francisco
Telephone UNDERhill 5815

THE TORMEY COMPANY

GENERAL PAINTERS
AND DECORATORS

Phone UNDERhill 1913

563 FULTON STREET
San Francisco

IN THE NEWS

NEW SAFETY DOOR SIGNAL

An entirely new device, the DOR-SIGNAL BLINKER Safety Control, prevents door collisions.

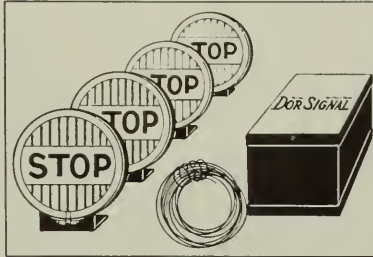

The signal lights inside and outside automatically, no additional work for checker or doorman. Easily installed on AC or DC circuits, fool proof operation, it is a product of the P. M. COMPANY, 222 South 12th Street, Newark 7, New Jersey.

MILTON CAUGHEY, Architect, has moved to 2738 Westwood Boulevard, Los Angeles, California.

EXHAUST FAN

For ventilating, a new exhaust fan for installation in a window opening has been announced by the EMERSON ELECTRIC MFG. CO., St. Louis 3, Missouri.

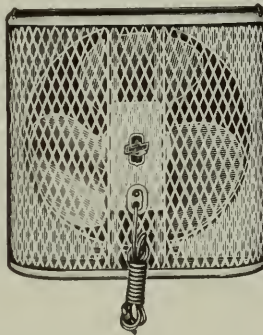

Set on window sill, attached by two screws to jam, driven by capacitor motor. Blades are of sheet aluminum. Dimension 29 x 9 x 24 inches.

AN INFRA-RED "PLUMBER"

If the kitchen sink is stopped up, turn the rays of an infra-red heat lamp on the grease trap—or put a heaping tablespoonful of soda down the drain, then pour in a half glass of vinegar.

Phone GARfield 1164

Thomas B. Hunter

Consulting Engineer

DESIGNER OF HEATING
AIR CONDITIONING
VENTILATING AND WIRING
SYSTEMS, MECHANICAL
AND ELECTRICAL EQUIP-
MENT OF BUILDINGS

41 SUTTER STREET
ROOM 710

San Francisco

California

ANDERSON & RINGROSE

General Contractors

320 Market Street, San Francisco
Phone GARfield 2245

DINWIDDIE CONSTRUCTION COMPANY

BUILDERS

CROCKER BUILDING
SAN FRANCISCO



HERRICK IRON WORKS

STRUCTURAL STEEL
REINFORCING STEEL

18TH AND CAMPBELL STS.
OAKLAND, CALIF.
Phone GLencourt 1767

INDEPENDENT IRON WORKS

Steel Buildings
Service Stations
Steel Storage Tanks
Fabricated Plate Work
Steel & Sheet Metal Products
Fabricated Structural Steel
Steel Distributors

Eighth & Pine Sts. Oakland, 7

George F. Brayer

ELECTRICAL
CONTRACTOR

166 Seventh Street
San Francisco

Phone: Market 1761

PITTSBURGH TESTING LABORATORY

Successors to
SMITH, EMERY & COMPANY

*Testing and Inspecting
Engineers and Chemists*

Structural Materials, Structures
Equipment, Pipe, Soils.

651 Howard St., San Francisco 5
EXbrook 1747

A. F. MATTOCK CO.

Builders

★

212 CLARA STREET
SAN FRANCISCO

Index to Advertisers

ALADDIN Heating Corp.....	48
ANDERSON & Ringrose.....	47
ARCHITECTS Reports	40
BASALT Rock Company, Napa.....	39
BASALT Rock Company, San Francisco	47
BAXTER & Company, J. H.....	40
BRAYER, Geo. F.....	48
CLARK, N., & Son.....	*
CLASSIFIED Advertising	43
CLINTON Construction Company.....	44
COLUMBIA Steel Co.....	*
DINWIDDIE Construction Company..	47
FORDEKER Cornice Works.....	39
FORREST, Kyle	46
FULLER, W. P. Co.....	Inside Front Cover
GUNN, Carle & Company.....	46
HANKS, Inc., Abbot A.....	48
HAWS Drinking Faucet Company.....	Back Cover
HERRICK Iron Works.....	47
HOGAN Lumber Company.....	44
HUNT, Robert W., Company.....	48
HUNTER, Thos. B.....	47
IMPERIAL Brass Manufacturing Co.....	*
INDEPENDENT Iron Works.....	48
JENSEN & Son, G. P. W.....	47
JOHNSON Company, S. T.....	*
JUDSON, Pacific-Murphy Corp.....	39
KRAFTILE Company	1
KAWNEER Company	*
MATTOCK, A. F.....	48
MULLEN Mfg. Co.....	47
MUELLER Brass Co.....	2
NORTHERN California Electrical Bureau	35
PACIFIC Coast Gas Association.....	Inside Back Cover
PACIFIC Manufacturing Company.....	45
PACIFIC Portland Cement Company *	
PACIFIC Telephone & Telegraph Co.	33
PARAMOUNT Built-in Fixture Co.....	*
PAYNE Furnace & Supply Co., Inc.....	*
PITTSBURGH Testing Laboratory.....	48
PORTLAND Cement Association.....	*
REMILLARD-Dandini Co.....	48
REPUBLIC Steel Corporation.....	45
SANTA Maria Inn.....	44
SCOTT Co.	46
SIMONDS Machinery Company.....	45
SISALKRAFT Company	39
SMOOT-Holman Co.....	37
STANLEY Works, The.....	*
STEIGELMAN, Elmer F.....	46
SOULE Steel Co.....	*
TAYLOR Co., Halsey W.....	32
TIMBER Engineering Co., Inc.....	*
TORMEY Company, The.....	47
UTILITY Appliance Corp.....	*
U. S. STEEL.....	*
U. S. BONDS.....	5
VERMONT Marble Company.....	45
WESIX Electric Heater Co.....	*
WESTERN Asbestos Company.....	*
WOOD, E. K., Lumber Company.....	36

* Indicates Alternate Months

REMILLARD-DANDINI Co.

Brick and
Masonry Products

★

633 BRYANT ST., SAN FRANCISCO
569 THIRD ST., OAKLAND

ALADDIN Heating Corp.

Specializing in
QUALITY HEATING
EQUIPMENT

2222 San Pablo Avenue

OAKLAND

TWinoaks 1022

ABBOT A. HANKS, INC. Engineers & Chemists

INSPECTING — TESTING — CONSULTING
CONCRETE • STEEL • MATERIALS
CHEMICAL AND TESTING
LABORATORIES

• RESEARCH AND INVESTIGATION •

TESTS OF STRUCTURAL MATERIALS
DESIGN OF CONCRETE MIXES
SHOP AND ERECTION INSPECTION OF
STRUCTURES AND EQUIPMENT
INVESTIGATION OF STRUCTURES
AND MATERIALS
TESTS AND INVESTIGATION OF
FOUNDATION SOILS
FIRE RESISTANCE AND INSULATION
TESTS

624 Sacramento Street, San Francisco

Robert W. Hunt Company ENGINEERS

Inspection - Tests - Consultation
Schools and Other Structures
Are Built as Designed

*When Construction Materials are
Inspected at point of Manufacture
and during Erection by*

ROBERT W. HUNT COMPANY

*Cement, Concrete, Chemical, Metallurgical,
X-Ray and Physical Laboratories*

Chicago - New York - Pittsburgh
Los Angeles - All Large Cities
San Francisco, 251 Kearny Street

ARCHITECT AND ENGINEER

THE HERRICK HOSPITAL, Berkeley, California

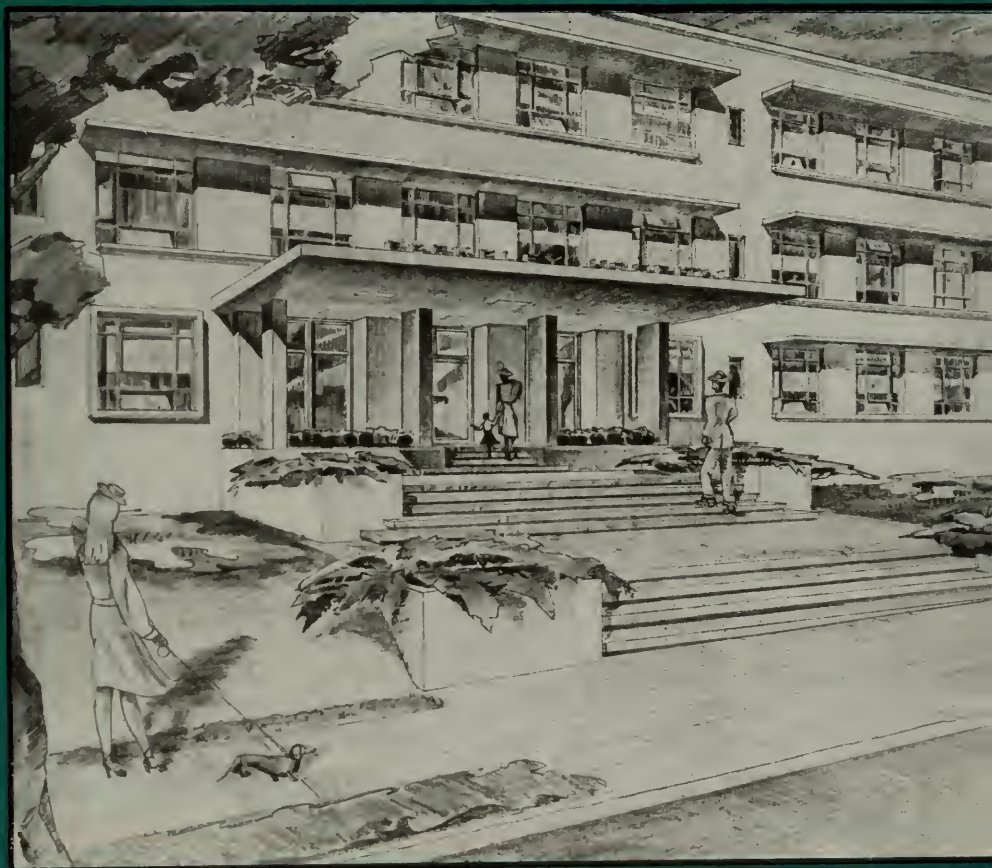

NOVEMBER

1946

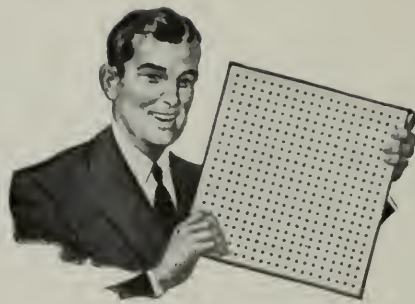

OVER 1000 YEARS of Combined Acoustical Experience

... At Your Service Through Western Asbestos Co.
Your Acousti-Celotex Distributor

MORE THAN 1000 years of combined experience, gained in over 100,000 installations—this is the great reservoir of practical knowledge available to you *only* through the Acousti-Celotex* Distributor Organization of which Western Asbestos Co. is your representative.

This knowledge has been gained in good company. For the nationwide Acousti-Celotex group has collaborated with hundreds of architects in effecting solutions to noise quieting problems.

Every day the men of this organization are helping to solve such problems as:

- How to diagnose acoustical and noise quieting difficulties . . .
- How to reduce distracting noise to a gentle hush . . .
- How to design architecturally for optimum acoustics . . .
- How to be sure of mechanical perfection in the proper acoustical material and its application . . .
- How to make sure of the acoustical installation's perfect appearance and continued satisfactory performance through the years.

Every man in this nationwide organization is hand picked. He is thoroughly trained in sound-conditioning practice. As a result, when you turn a job over to him, you know it will be trouble-free.

No matter how much or how little assistance you may need, Western Asbestos Co. is willing and able to help you without obligation. This extra service in no way affects their ability to compete on the smallest or the largest job you may have. That service is the unwritten *plus value* that goes with every specification for Acousti-Celotex.

A phone call or a note will bring a trained sound-conditioning expert to you from Western Asbestos Co.'s staff.

WESTERN ASBESTOS CO.

DISTRIBUTORS • ENGINEERS • CONTRACTORS

SAN FRANCISCO: 675 TOWNSEND STREET, HEMLOCK 4884

OAKLAND: LATHAM SQUARE BUILDING, TEMPLEBAR 7474

SACRAMENTO: 1224 EYE STREET, SACRAMENTO 2-8993

FRESNO: 1837 MERCED STREET, FRESNO 3-3277



Sound Conditioning with
ACOUSTI-CELOTEX

* Perforated Fibre Tile REG. U. S. PAT. OFF. SINCE 1923

• ARCHITECT

Vol. 167 No. 2

AND ENGINEER

ARCHITECTS' REPORTS—Published Daily

Telephone DOuglas 8311

E. H. WILDER
Editor

MARK DANIELS, A.I.A.
Associate Editor

JOHN S. BOLLES, A.I.A.
Book Reviews

MICHAEL GOODMAN
Post-War Planning

L. H. NISHKIAN
Consulting Editor

E. N. KIERULFF*
Ass't Editor
*In the Service

★
Contents for

NOVEMBER

COVER: THE HERRICK HOSPITAL, Berkeley, California

(See Page 16)

ARTICLES AND MISCELLANEOUS TEXT

EDITORIAL NOTES	4
NEWS & COMMENT ON ART	7
CALIFORNIA COUNCIL OF ARCHITECTS, First Annual Convention, Coronado	8
"WHERE DO WE GO FROM HERE" Address by JAMES R. EDMUNDS, JR., National President of the A.I.A. Delivered at Coronado	9
BEVERLY DRIVE PROFESSIONAL BUILDING EARL HEITSCHMIDT & CHARLES O. MATCHAM, Architects	11
STATUES FOR HOSPITALS KING GEORGE V. MEMORIAL HOSPITAL, Sydney, Australia	12
THE HERRICK HOSPITAL, Berkeley, California By EDWIN H. WILDER; James F. M'Guinness and Edmund J. Resing, Architects	16
A.I.A. ACTIVITIES	31
WITH THE ENGINEERS	32
HEADLINE NEWS & VIEWS By E. H. W.	36
IN THE NEWS	37, 43, 44, 46
PRODUCERS' COUNCIL PAGE Edited by CHAS. W. KRAFT	38
ESTIMATOR'S GUIDE	41
BUILDING AND CONSTRUCTION MATERIALS BUILDING TRADES WAGE SCALE	43
NORTHERN AND CENTRAL CALIFORNIA	
CLASSIFIED ADVERTISING	43
BOOK REVIEWS, Pamphlets and Catalogues	45
STATEMENT OF OWNERSHIP, etc.	47
INDEX TO ADVERTISERS	48

ARCHITECT AND ENGINEER (Established 1905) is published on the 15th of the month by The Architect and Engineer, Inc., 68 Post St., San Francisco 4; Telephone EXbrook 7182. President, K. P. Kierulff; Vice-President and Manager, L. B. Penhorwood; Treasurer, E. N. Kierulff.

Los Angeles Office: Wentworth F. Green, 6605 Hollywood Blvd., Los Angeles 28, Telephone HEmpstead 3171.

Entered as second class matter, November 2, 1905, at the Post Office in San Francisco, California, under the Act of March 3, 1879. Subscriptions United States and Pan America, \$3.00 a year; \$5.00 two years; foreign countries \$5.00 a year; single copy 50c. ARCHITECTS' REPORTS are published daily from this office, Vernon S. Yallop, Manager.



EDITORIAL NOTES

HAPPY BIRTHDAY

Several hundred architects and their wives, representing the five California Chapters of the American Institute of Architects comprising the California Council of Architects, gathered together in Coronado, recently, for their first annual convention.

Meetings and forum discussions were of a technical nature pertaining to the architectural profession, however, even to the most casual observer it was obvious that officers and directors of the various Chapters and the Council had devoted considerable time and thought to the program of the convention and to the activities of their groups during the past year.

* * *

WHAT IS AN ARCHITECT?

Writing in "Architecture—A Profession and a Career," H. Daland Chandler, F.A.I.A. of Boston, Massachusetts, says: "You live in a house, you work in a building, you enjoy an hour of relaxation in a theater; wherever the orbit of your life runs you are, if you consider it, framed and buttressed by the hand of the architect. To the setting of your daily activities some architect has given of his skill and imagination in order to make that environment suitable and pleasant for you to do the special task you have to do in it. . . ."

"How necessary is it then in contemplating the construction of a building to choose a good architect, to recognize the indispensable ingredients that make for goodness.

"In the first place the good architect is born with an innate creative desire, with a vision of the beauty of construction, its mass and proportion, the harmony and balance of its many elements, the play of light and shade and color. And with these endowments he must submit himself to an arduous schooling to train his imagination, develop his sensitivity, acquire knowledge of building materials and methods, and accumulate experience that will enable him to interpret and analyze the prospective owner's dreams and, translating them on paper, fashion them into a three-dimensional solid of stone and metal and wood, all within the financial limits imposed upon him by the problem. He must be enthusiastic yet cautious, responsive yet patient, resourceful, and master of the politic approach.

"To a building project the architect brings acquisitions and a range of services that cannot be matched by any other factor in the operation. . . . He is his client's professional adviser and

representative; he plans, he specifies, obtains bids, draws contracts, supervises the progress of the work, oversees construction accounts; he is, in a word, the administrative head of a complex operation carried out by many hands. He must indeed be a man of many talents. . . ."—Excerpts printed by permission The American Institute of Architects, Washington, D. C.

* * *

INDUSTRIAL EXPANSION

It has been freely predicted by many that eastern manufacturing interests, attracted to the Pacific Coast during the war, would remain and extend their activities into peacetime economy of the West Coast, and at the same time prepare for eventual expansion into the near East.

That such predictions are not idle chatter, or wishful thinking, is indicated by a recent report of the Industrial Department of the San Francisco Chamber of Commerce, which says in part:

"Over \$32-million will be invested in northern California industrial developments as announced for July, 1946, representing 48 expansions costing \$25,937,750 and 59 new ventures estimated at \$6,683,630.

"The total northern California industrial development to August 1, 1946, represents \$92,779,653 in investment and 689 projects."

This vast industrial expansion program can be applied to the entire Pacific Coast area, and is the basis for thinking that the architectural, engineering, and construction industries can anticipate a long period of progress.

* * *

A SOUND INVESTMENT

At the first annual state-wide convention of the California Council of Architects, recently held at Coronado, California, initial steps were taken for the formation of a long term program of public education on the important functions of the architectural profession.

In establishing and putting into effect such an educational program the architects of California are unquestionably laying a solid foundation for the building of unlimited favorable public reaction.

By fostering practical architectural design in all building; by retaining a proper balance between functional and modernistic principles, and by cooperative recognition of all phases and factors of the construction industry by means of a definite, carefully worked out educational program, much will be done to stimulate individuals and the public at large, to seek the sound counsel and professional service of the qualified architect.

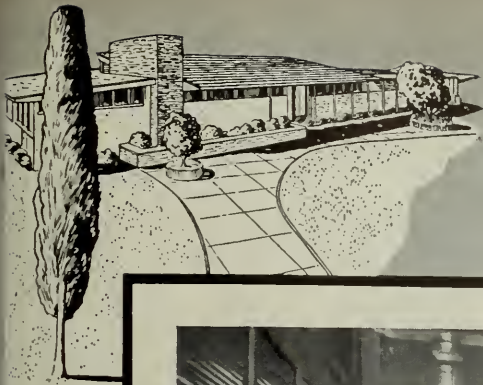

America's newest kitchen Features GAS



*Experimental model refrigerator, specially built, not available for purchase.

Lovely singing star, Gloria Warren demonstrates appliances in the "New Freedom Gas Kitchen" of the Fritz B. Burns Experimental Home, Los Angeles.

Designed as a completely mechanized work center, this "dream kitchen" scoffs at Tradition, forecasts features to come. Note, for instance, the appliances which are specially built to fit new concepts of design. ★ The gas range is a "cook-on-the-back, work-on-the-front" model, flush with cabinets and wall, its top a section of the continuous work surface. ★ The gas refrigerator, too, carries out this flush-with-work-surface design, and is equipped with pull-out drawers. ★ The newly-designed hydraulic dishwasher

is supplied by a gas water heater which assures ample hot water for *every* household need. ★ Significantly, gas fuel was chosen for all these essential services in this *home of the future*. The fast, dependable fuel is the *most modern!*

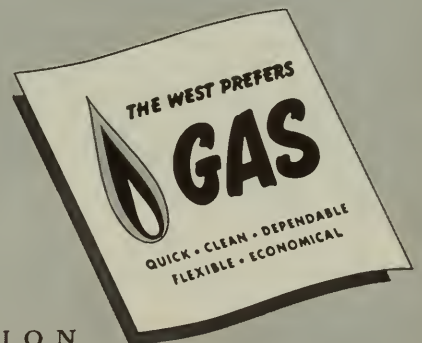



HAWS Model No. 7A . . . vitreous china wall drinking fountain with bubbler protecting cowl . . . chrome-plated brass raised anti-squirt angle stream head with self-closing automatic stream control valve . . . all working parts accessible without detaching unit from wall.



Service and Safety with HAWS!

You can trust with your life the services of a modern hospital and its equipment. They know best how to safeguard and protect health and provide for the patient's comfort.

HAWS Sanitary Drinking Fountains were conveniently installed throughout the new Berkeley General Hospital to provide refreshing drinking water for the employees of the hospital, the visitors and the doctors.

This recently completed building was designed by Resing and McGuinness, Architects, and built by Willis F. Lynn, General Contractor. HAWS Drinking Fountains were installed by F. W. Spencer and Son, Plumbing Contractors.

Specify and insist upon HAWS Sanitary Drinking Water Fountains and Coolers in the buildings that you are planning. There is a model and design for every particular need . . . write for the HAWS catalog today.

***HAWS* Drinking Fountains**

HAWS DRINKING FAUCET CO.

1808 Harmon Street — Since 1909 — Berkeley 3, California

AGENTS AND SALES REPRESENTATIVES IN ALL PRINCIPAL CITIES

NEWS AND COMMENT ON ART

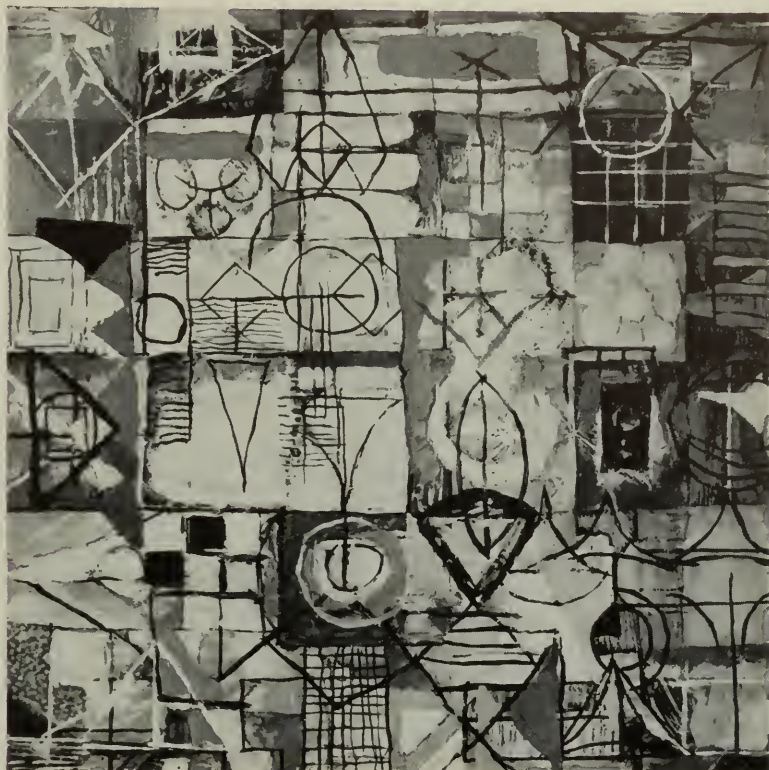

COXCOMB

by ELLWOOD GRAHAM,

oil painting

Ellwood Graham was awarded the only Art Association Purchase Prize given in the 66th Annual for any medium. Graham is closely associated with the Monterey art world and originally came to California to paint a 1400 foot tempera mural for the Ventura postoffice. He has exhibited at the De Young Museum, The Palace of the Legion of Honor, and the San Francisco Museum of Art in San Francisco.

SAN FRANCISCO MUSEUM OF ART—Exhibitions and activities during the month of November will include: Bay Area Prints; Cartoons by Corka; Art in Cinema; and the 21st Annual Exhibition of San Francisco Women Artists, showing painting, graphic arts, ceramics, textiles and photography. Activities will include a Flower and Table Decoration Course (Wednesdays at 2:30); Studio Workshop and Sketch Club and Gallery Talks by staff members.

* * *

DE YOUNG MUSEUM—During November will present an exhibition of paintings by Marsden Hartley, 1877-1943. The rock landscapes of New England and the coast of Maine are among his favorite subjects. He participated in many important shows throughout the United States prior to his death. Other exhibitions will include: Four Centuries of Houses, U.S.A.; Face of the Orient; Victorial Apparel. Chinese Lowestoft Porcelain, and Ceramics by the Association of San Francisco Potters. Art Classes, Children's Classes and tours for school groups are also offered.

BENDER GRANTS-IN-AID WINNERS—Winners of the 1946-47 Albert M. Bender Grants-in-Aid are Richard C. Diebenkorn, San Francisco, and Oliver

Lawrence, Palo Alto. Each will receive \$1200 to carry on individual projects for the ensuing year.

* * *

CALIFORNIA SCHOOL OF FINE ARTS—Clyford Still, artist and instructor of national reputation, has been added to the teaching staff.

* * *

CALIFORNIA PALACE OF THE LEGION OF HONOR—FINE ARTS UNDER FIRE, an exhibition of Historic Monuments in War areas (Photographs). Thomas Carr Howe, Jr., Director, has been awarded the cross of Chevalier of the Legion of Honor in recognition of his services in restoring looted art to France. Exhibitions and Events for November include: Paintings by John Little, Karl Priebe, Carol Blanchard and the work of Marguerite and William Zorach. Adult lecture courses each Wednesday morning; Children's Classes on Saturday; Organ Recitals, and free motion picture.

* * *

PORTLAND ART MUSEUM—A new series of gallery talks for children has been undertaken by Charlotte Baker Montgomery each Saturday. November exhibitions include "The Eskimo and His Art," and "The Children's Zoo." Sunday concerts are being continued.

California Council Of Architects

Hold First Annual Convention at Coronado

Culminating a period of reorganization and formulation of the architectural profession into the national program of the American Institute of Architects, California's five A.I.A. Chapters comprising the California Council of Architects held their first annual convention in Coronado at the Hotel del Coronado on October 10, 11, and 12.

Establishment of a program of public education; opposition to needless regulation of the construction industry by governmental agencies; and a warning that the architectural profession is not in

a "healthy" condition by James R. Edmunds, Jr., Baltimore, Maryland, President of the American Institute of Architects, highlighted the three-day conference at which more than 375 architects, their wives, and guests attended.

John S. Bolles, President of the Council; Charles O. Matcham, President of the Southern California Chapter; H. Louis Bodmer, President, San Diego Chapter; Andrew T. Hass, President, Northern California Chapter; Roy C. Wilson, President, Santa Barbara Chapter; and Herbert E. Goodpastor, President of the Central Valley Chapter, presided at various public meetings and Council conferences, which considered many subjects of keen importance to the architects of California.

James R. Edmunds, Jr., national president of the Institute; Samuel E. Lunden, national vice-president, and Earl T. Heitschmidt, regional director of the A.I.A., presented nationwide architectural plans and programs to convention delegates.

Serious business sessions were held on Thursday afternoon, Friday morning and afternoon, and Saturday morning, while numerous social and special entertainment features, arranged by the convention chairman, Vincent Palmer, assisted by Wayne S. Hertzka of San Francisco, consisted of an informal get-together on Thursday evening together with a very interesting program devoted to the history of Coronado, with Harley E. Knox, mayor of San Diego, and K. B. (Kit) Carson, mayor of the City of Coronado, sharing honors.

The "Ladies' Luncheon" on Friday, with Mrs. Mario Corbett, President, Women's Architectural League of San Francisco, and Mrs. Chester H. Treichel, President of the Women's Architectural League, East Bay Section, outlining the activities



JOHN S. BOLLES, A.I.A.
President of the
California Council of Architects

of their group, was the highlight of the women architects' participation.

The "President's Reception and Dinner" on Friday evening, and the numerous tours, tournaments, boat ride and "Sportsmen's Dinner" on Saturday evening, combined to fill the three days with ample relaxation from the pressure of business conferences.

During the business sessions, considerable attention was given to OPA regulations "which are rules and not laws," but which have prevented normal progress in the construction industry; public educational programs; construction industry cooperation in all matters pertaining to legislative and governmental regulations; and technical developments within the architectural profession.

Program speakers included John S. Bolles, President of the Council, who discussed the program of "Unification"; Earl T. Heitschmidt spoke on "Current Events," emphasizing abuses of the OPA; Hervey P. Clark conducted a forum on "California Living," assisted by Gregory Ain; Adrian Wilson, whose subject was "Legislation—Friend or Foe"; Vincent Palmer, "Architecture—Your Profession"; Ernest J. Kump, Herbert Powell and Charles D. Gibson discussed "School House Planning"; and Paul R. Hunter led a round table devoted to new materials in which E. E. Cathcart, President, Producers' Council, San Francisco, participated.

Among the resolutions presented and adopted for action were: one designed to have one or more architects appointed to the Advisory Board of the State Fire Marshal; approval of the California Council of Architects appointment of an architect to serve as member of a group to consider and prepare amendments to the State Housing Act for

adoption by the 1947 State Legislature, the work to be carried out under supervision of the State Housing Commission.

Recommendations that a five-man board be appointed by the Council to work with State Department of School House Planning in all matters pertaining to architectural practice in school house planning; approval of a state-wide legislative program; sponsor a committee to study and recommend housing legislation; urged Congress to withdraw all wartime restrictive regulations; opposed the Wagner-Ellinder-Taft bill before Congress; and adopted the following relative to veterans on the job training:

"Whereas: The California Council of Architects, in collaboration with the Northern California and Southern California Chapters of the American Institute of Architects has prepared a program for On-the-Job Training for Veterans, embodying the policy that interested architectural firms each apply individually for approval as a training institution, and

"Whereas: Said Council has also considered creating a committee to enforce and regulate the enactment of a program adopted by individual architects, and

"Whereas: Said Council has presented this convention on Saturday, October 12, 1946, with an outline of this program, copy of which is attached hereto,

"No, Therefore Be It Resolved, That this Convention declare it is the sense of this meeting that it approves the adoption of a uniform Veterans' Training Program by individual architectural firms acting as training institutions, but it opposes the Council creating a committee to enforce and regulate any program."

Where Do We Go From Here?

Address of

JAMES R. EDMUNDS, JR.

Baltimore, Md., National President of the American Institute of Architects, Friday evening, October 11, 1946, at the 19th state-wide convention of the California Council of Architects, Hotel del Coronado, Coronado, California.

Architecture is not in a healthy state. True, we are all swamped with work, but how much of all these projects is under construction or even likely to be in the near future?

This condition of affairs cannot go on indefinitely. Our clients will not much longer continue to employ our services for the design of projects

which they are not permitted to build. This is to warn you if you need warning that our present happy state of "full employment" is nearing its end unless something is done about the dreadful condition in which the construction industry finds itself.

Architecture is but a part of the construction industry and must live or die with it. Our industry is being strangled by forces which a few years ago we considered "none of our business."

We know now that these forces **are** our concern, and what we can do to control and direct them properly should be undertaken, and at **once**. Indeed we may be already too late.

We find ourselves in the same boat with the little Negro boy who, after vainly chasing a streetcar for two blocks, pulled up out of breath on the curb. A kindly old gentleman said, "Sonny, you didn't run fast enough." "Uh, uh," gasped the little boy, "I kin run fast, but I didn't **start soon enough.**"

We in the design professions have but recently become fully conscious of our position in the construction industry, and of the latter's important place in our national economy. We have but more recently recognized our responsibility therein and made some effort to shoulder it. This, through the Construction Industry Advisory Council set up by the United States Chamber of Commerce. On the Council are represented all phases of the construction industry; labor, general contractors, subcontractors, manufacturers and distributors of construction materials, real estate boards, operational builders, the lending agencies and the design professions—the A.S.C.E., the A.S.M.E., and A.I.A.

Much of what I have to say now represents the collective thinking of all of these phases of the industry, which under present conditions is presented with so many vexing problems. We must act in unison if they are solved. Architects are numerically weak, but by engaging the help of the entire industry are potentially strong.

All of us in the industry today will freely admit that it is in very bad shape. Demand for construction is at an all-time high, production at an all-time low. The war disrupted our industry; it is short of labor, it is critically short of most kinds of material. We believe that the policy of government in relation to these bottlenecks is neither realistic nor (and here I express my own private opinion) entirely honest of purpose.

We have a right to be heard when we speak to those who have been delegated authority by the executive to restrict procedure in our industry, ostensibly for the purpose of quickly producing homes to meet the existing critical shortage.

The restrictive order of Mr. Wilson Wyatt, issued with the power of the Executive under the Second War Powers Act, contains many features with which the construction industry does not see eye to eye.

It is that industry which must build the nation's homes, including new homes for our veterans. We in that industry are just as anxious as any to see them built in the shortest possible time.

We recognize that the responsibility for providing these rests in large part on our shoulders. Also that we can not build the maximum number until the present obstacles to building have been removed.

We have opposed some of the plans proposed by the Federal government in connection with the home building program; but that opposition on

our part was a sincere effort to prevent conditions and controls which in our considered opinion would hold back veterans' home building, rather than expedite it.

Through the C.I.A.C. we did speak our mind to Mr. Wyatt and his cohorts, but as we say at home, "He paid us no mind," Even at the risk of being thought an "I told you so," I should like to point out that our prior criticism of Wyatt's complex scheme has been amply justified by later experience.

He had tried everything except the single most important step leading to recovery of construction's ability to produce—abolition of the OPA.

This lies within his power insofar as it controls prices of building products. For reasons of his own he has consistently refused. OPA said it could control prices; subsequent experience shows that it cannot; that experience has also shown great disruption to industry, our own providing perhaps the worst example.

Until the stranglehold of OPA is removed there can be no real volume of construction.

Since this bureaucratic dictator will not "see the light" and is seemingly guided more by political expediency than sound economics, the only course left open is to appeal to a higher power. Not the Chief Executive, not the Congress, but to those who are responsible for their being in office.

Where does government get its power to control? From the people. What, then, is the most important job that faces you? To inform the people, get them to support policies which will permit you to do your job of rebuilding America.

I realize this is a large "order" and hard to fill. It is a public relations job of great magnitude and difficulty. Nevertheless, it behooves our industry to undertake it and it behooves us as architects to assume our share of the work or more if need be.

(Mr. Edmunds here quoted from an article by Felix Morley in the September number of "Our Nation's Business," referring to the absence of conscience in governmental operations.)

Enough of Wyatt and the OPA. (I'm as tired of 'em as you are.) But great as would be the relief from the death of OPA this will not cure all of our ills. We have still other and just as serious troubles of which by far the most critical is that of construction cost.

The cost of building has risen greatly in many communities as compared with prewar levels, and I find no one who is not alarmed by that fact. The cold truth is that it has risen more than the cost of most other goods and commodities with which this industry must compete for the buyer's dollar.

True, individual incomes have risen sharply as a result of wage increases and record employ-

(Continued on Page 33)



MEDICAL BUILDING FOR MR. VICTOR M. ORSATTI • BEVERLY HILLS, CALIF. •
 EARL HEITSCHMIDT AND CHARLES O. MATCHAM ARCHITECTS 417 SO. HILL ST. LOS ANGELES CALIF. 10 9-45

BEVERLY DRIVE PROFESSIONAL BUILDING

Located at 300 South Beverly Drive, Beverly Hills, California, this building was designed by Earl Heitschmidt and Charles O. Matcham, Architects, to include a convenient basement garage plus a parking lot at the rear of the building.

Construction is of reinforced concrete, Type I, fireproof throughout.

The first floor will be occupied by a prescription pharmacy at the corner of Beverly Drive and Brighton Way. The south half of the building will be occupied by a laboratory. The three upper floors will be devoted solely to physicians, surgeons, and dentists.

Stanton-Reed Company are the general contractors.

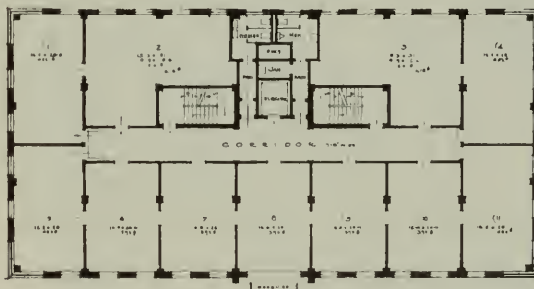

TYPICAL FLOOR PLAN

STATUES

For Hospitals

Three statues—Maternity, the Surgeon and King George V—complementing the advanced architecture of the ultra-modern King George V Memorial Hospital for Mothers and Babies at Sydney, Australia, have just been completed by Andor Meszaros, former Hungarian sculptor who recently became an Australian citizen after living in the Commonwealth for the last six years.

Meszaros constructed the first statue, Maternity, on the spot where it was to stand. With his wife posing, he first prepared a 12-inch plaster model, later making one half-scale.

He collected the tools he needed from different parts of Australia. Many of the necessary implements were difficult to obtain because imports were limited during wartime, and he improvised when he could not find exactly what he needed. Because of these difficulties the plaster model took two

months to complete, the actual carving four and a half months. Often he worked into the night in the tin hut that was built around the statue in the hospital grounds.

Norman Carter, artist and foundation member of the Australian Academy of Art, said of "Maternity": "So far as public statues in this city are concerned, it strikes a new note by the revised conception of its treatment and by the manner in which the idea itself is expressed. The sculptor has wisely avoided a sentimental approach to the motherhood idea, and has produced a work which by-passes the present day boring use of the word 'modern'. It is founded on traditions that are almost as ancient as maternity itself."

When it was decided that the second statue should be of a surgeon, Meszaros attended operations to watch surgeons at work.



SCULPTOR ANDOR MESZAROS

At work putting the final touches on his statue "The Surgeon," which is constructed of Hawkesbury sandstone, also known as Sydney freestone.

Australian Official Photos



THE SURGEON

This is a plaster model of "The Surgeon," controversial statue by Andor Meszaros, which was unveiled at the King George V Memorial Hospital for Mothers and Babies at Sydney, Australia.

The statue was constructed of Hawkesbury sandstone on the site on which it now stands.

The material presented certain difficulties as it contains a black coal material separating the layers, allowing an easy break in one direction but an irregular break in another.

As the stone sits in the open air the layers had to be arranged horizontally to meet weather conditions.



KING GEORGE V. Plaster model of statue to be carried out in white marble and to stand outside the Memorial Hospital to Mothers and Babies, Sydney, Australia.

Andor Meszaros, Sculptor

"At the first operation I attended I noticed that the older surgeons were businesslike, apparently thoroughly composed and detached," the sculptor related subsequently. "Then I saw a younger surgeon, in the act of pulling on his gloves, pause for a moment and draw in his breath as if to gear himself for the step he was about to take. It was only for a fleeting instant, but that was the moment I wished to express. I have portrayed decision; not indecision. I believe that every surgeon must at some time quail inwardly at the task before him. The greater he is, the more he must realize his possible inferiority."

The plaster model of "The Surgeon" was rejected at first by doctors as showing timidity and

tension, emotions, they maintained, a good surgeon would not feel. They changed their minds, however, after the sculptor argued that:

"Any surgeon who is about to perform an operation must feel a tremendous sense of responsibility, for he is taking a human life into his hands. You cannot tell me that tension does not exist. The operation is conducted for the most part in silence, broken only by the surgeon's staccato requests for instruments. But when the main work has been done, the clamps removed and the sutures made, the doctors begin to talk of the races or politics. That is their immediate reaction to the cessation of tension."

The third statue, that of King George V, was

M A T E R N I T Y



FRONT VIEW of the statue of *Maternity*, by Andor Meszaros, on the grounds of the King George Memorial Hospital for Mothers and Babies.

carved from a block of white marble chosen personally by Meszaros from the Ulam Quarry, near Rockhampton, Queensland. Ulam marble is very fine-grained and somewhat translucent. It hardens with time and weathers well. Meszaros did a "rough-cut" at the quarry to make sure that there were no discolorations which might appear on the

subject's face when the outer layers of marble were hewn away.

The small-scale plaster model for the statue of King George V was remarked "a very good likeness" by the late King's son, His Royal Highness the Duke of Gloucester, Governor General of Australia.



THE HERRICK HOSPITAL (Formerly Berkeley Hospital) James F. M'Guinness and Edmund J. Resing, Architects

THE HERRICK HOSPITAL BERKELEY, CALIFORNIA

An Institution Representing the Most Modern
Trend in Hospital Planning and Construction

By EDWIN H. WILDER

Aside from the fact that we derive a great deal of pleasure from viewing a new commercial, or industrial building, or a new home, the factors

which impressed us most about the newly constructed Herrick Hospital in Berkeley, California, are the pleasing simplicity of architectural design

THE HERRICK HOSPITAL . . .

and the obvious thoroughness of planning for the every day routine functions of the institution.

Every inch of space in the new building, located at Dwight Way and Milvia streets, has a definite use; every department and inter-department activity proceeds smoothly in coordination with, but without dependence, of one another; incoming patients and outgoing patients, visitors, emergency accident cases, and all of the thousand-and-one

details connected with a large metropolitan area hospital are carried on seemingly without effort.

We were conscious of the fact that during our recent visit, numerous patients were being admitted while others were being discharged, a foot injury was being cared for in the emergency section; an operation was being performed with care and dispatch in surgery; the spacious maternity suite was functioning as designed, and in the adjoining nursery several babies were enjoying their first days of life surrounded by a whole building of great activity which proceeded with an absolute minimum of effort and confusion.

We realized that this building containing such a diversity of activity with such complete smoothness of function was not something that just "happened." Instead it represented the result of the combined efforts of James F. M'Guinness and Edmund J. Resing, architects of San Francisco who prepared the plans and specifications; John J. Gould, structural engineer; Lyle E. Patton, electrical engineer; James Gayner, mechanical engineer; Willis F. Lynn, general contractor of Berkeley, and Alfred E. Maffly, superintendent of the hospital who served as hospital consultant to the above and to numerous sub-contractors, equipment dealers and manufacturers.

The first and major problem confronting the architects was to design a modern building which would incorporate as much of the existing hospital facilities as could be utilized in planning for the future, and at the same time would permit construc-

THE HERRICK HOSPITAL

Formerly the
Berkeley General Hospital

Architects: Resing & M'Guinness
Landscape Architect: Harry W. Shepherd
General Contractor: Willis F. Lynn
Pneumatic Dispatch System: Lamson Corporation
Tiling: Fox Tile Company
Nurses' Call, Public Address and Lighting
Fixtures: Matson Electrical Equipment Co.
Plastering: William Makin
Steelforms: Steelform Contracting Co.
Painting and Decorating: Pacific Painting & Decorating Co.
Steam Heating, Ventilating and Air Conditioning: W. A. Aschen.
Masonry and Glass Blocks: Harold B. Petersen
Plumbing: F. W. Spencer & Son
Photographs by James Stevenson Studios.



FRONT VIEW DRAWING of new Herrick Hospital unit now completed.

Plastering by Wm. Makin

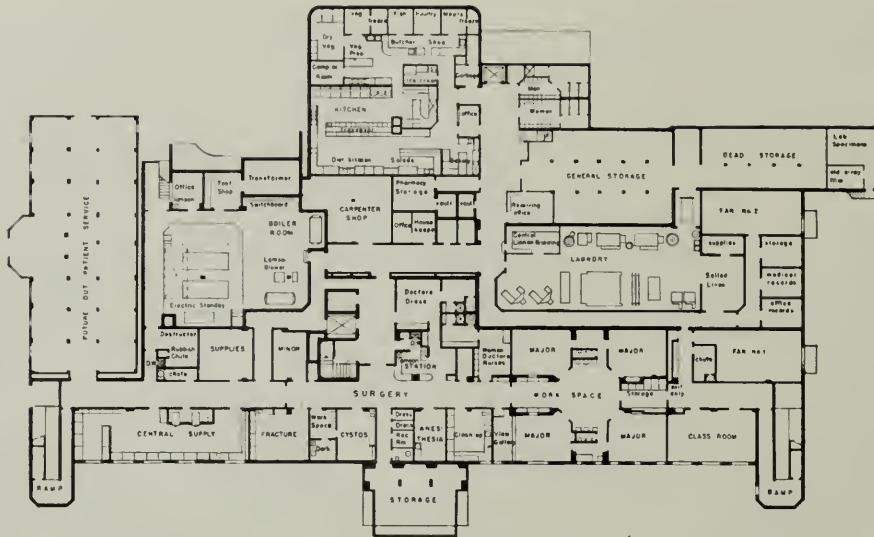

GROUND FLOOR PLAN—Showing unique location of surgery and accessories including anesthesia, fracture, supply, work space; and storage, heating plant, laundry and kitchen.

tion without disrupting the existing facilities which were being taxed to maximum capacity.

Also during the construction period it was necessary to extend the communications system, administrative, and later actual hospital facilities from the old building without interruption, and this required considerable planning in advance.

As a result of a thorough study of building traffic a five-door control plan was adopted. The front door to be used by patients, visitors and the public, a loading platform and ramp at the rear of the building with a double door operated by an electric eye to serve as an emergency hospital and ambulance entrance, a special entrance adjacent to a reserved automobile parking area to be used by doctors, an employee entrance, and an entrance for tradesmen and delivery of materials and supplies.

Each of the five doors has a specific and individual function to perform and each of the doorways is under strict supervision twenty-four hours each day.

All departments of the hospital were designed to function as an individual factor, yet each is correlated and the entire building is under complete supervision of the administrative offices at all times through an elaborate pneumatic tube system which provides for the transmission of messages, records and drugs quickly from department to department. A radio call system is also in use throughout the entire hospital.

In making the initial announcement of the project, which now stands completed at an approximate cost of \$750,000, exclusive of land and equipment, Ivadell Herrick Henderson, president of the Board, stated the building program was being

(Continued on Page 22)

... THE HERRICK HOSPITAL

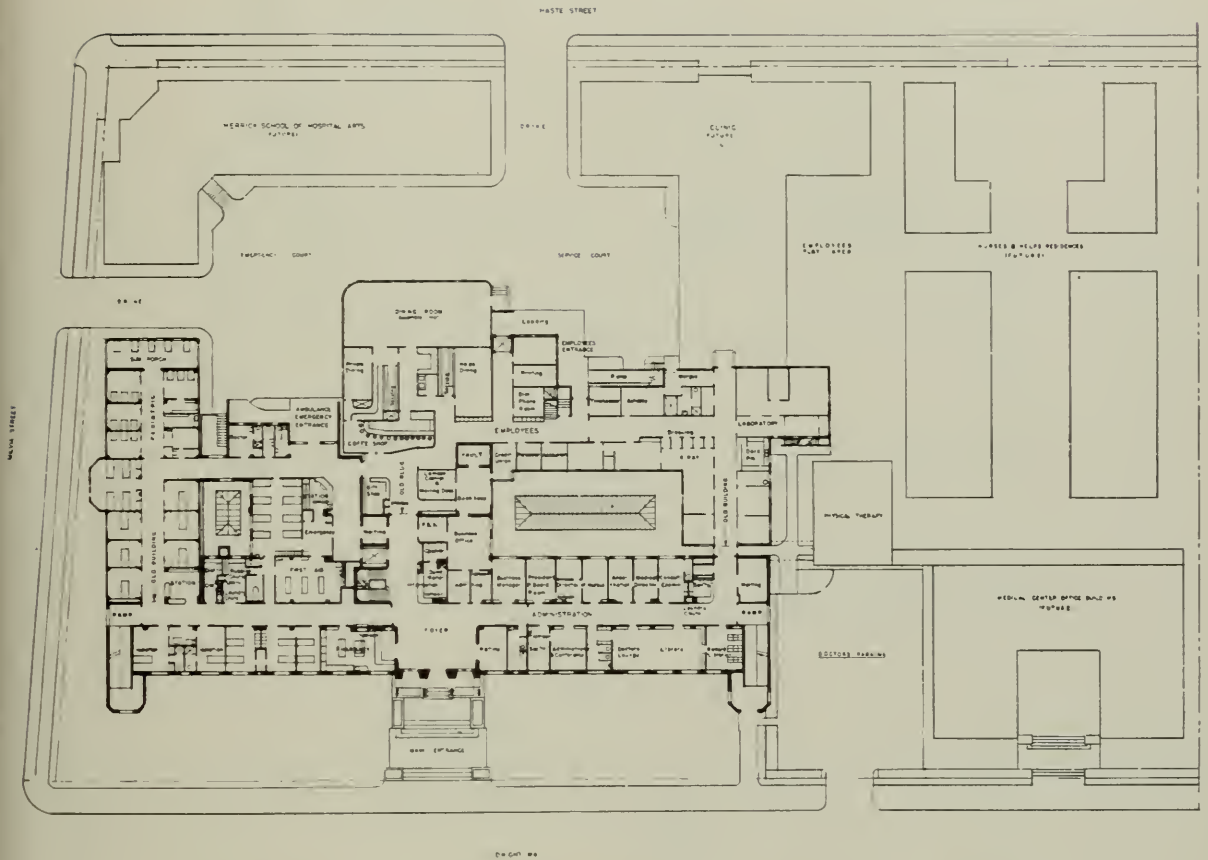

OVERALL PLAN—In addition to the new building unit now being completed, a Master Plan calls for the erection of numerous buildings surrounding the main Herrick Hospital to form a complete Medical Center.

The plan also shows first floor location of Administration offices, emergency and first aid, coffee shop, isolation, laboratories and the five "traffic entrances" to the building which are under staff control twenty-four hours each day.



SECOND FLOOR PLAN—Showing Maternity facilities compactly arranged independent of Nursery and rooms; Diet kitchen, nurses' station, and utility.

BELOW is THIRD FLOOR PLAN—With in-patients' quarters and nurses' station, also utility facilities and ramps at either end of building which extend from Ground Floor to Roof.

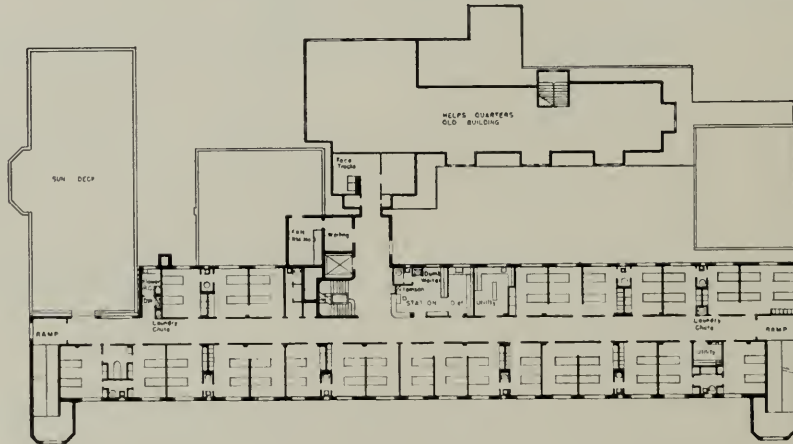

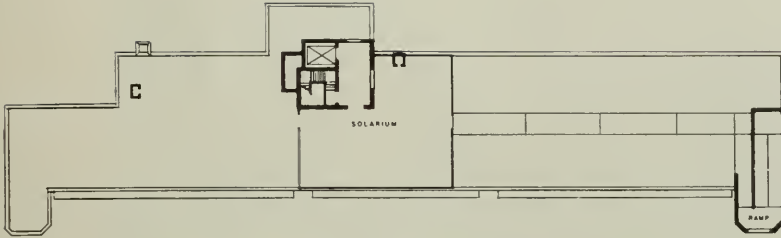

ROOF PLAN—Containing Solarium, and also designed for use as a helicopter landing for the future.

BASEMENT—Showing general location of heating plant.

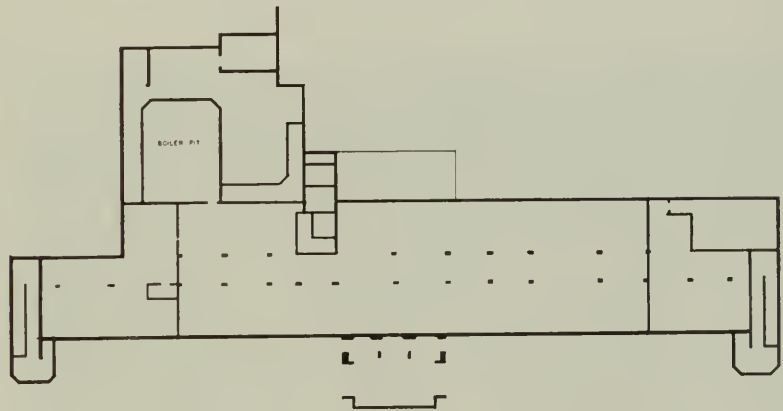

THE HERRICK HOSPITAL . . .

(Continued from Page 18)

undertaken by means of a loan and grant of the Federal Works Agency supplemented by a loan from doctors and friends of the hospital and funds which had accumulated in the hospital building fund, and was in response to the tremendous shortage of hospital beds in the community due to recent population increases.

When the entire program of expansion is completed and equipped, the hospital and proposed Berkeley Medical Center will represent an investment well in excess of \$1,250,000.

The complete hospital and contingent facilities have been dedicated to the health of the people of the area and surrounding communities as a tribute, and memorial, to the late Dr. Leroy Francis Herrick who founded the institution in 1904.

The newly completed section is outstanding in design and arrangement of facilities and will serve as the main building. It is a four story, plus solarium on the roof and sub-basement, reinforced concrete building of some 254' 6" in length and from 42 feet to 102 feet in width. It utilizes a comparatively recently built concrete wing of one of the

older buildings and at the same time ties in with the balance of the existing structures.

The frame of the building, reinforced concrete footings and columns, is designed for addition of more stories as required to keep pace with the growth of the community served, and one of the very unusual features of the building is that it was designed by the Architect to serve as a helicopter landing field on the flat roof. All roughing in for utilities is carried through the present roof.

The patients' elevator leads to the roof, as do the ramps, so that it will be possible to land patients on the roof with air ambulances of the future and wheel the patients into the hospital either via the ramps or via the elevator. The new era helicopter doctor will also find the roof landing field a convenient hospital entrance after making his rounds of calls in the surrounding territory.

One hundred and fifty patients' beds are added by the building which brings the capacity of the hospital to 250 beds, plus 50 bassinets for newborn babies. Thus some relief for the shortage of hospital facilities in the area has been provided.

Complete facilities for surgical, obstetrical and medical hospital patients have been provided, with the Architects inaugurating a unique location

SURGERY is finished with green tile walls, sound proof ceilings, electric shock grounded floors, large surgical luminaire and all of the modern equipment.





MATERNITY DELIVERY is finished in oatmeal tile walls, sound proof ceilings, surgical luminaire and every needed facility.

of the surgery department. Most hospitals have adopted the policy of locating their operating rooms on the top floor in order to obtain a maximum amount of sunlight, fresh air, and to reduce the amount of street noises.

With the advent of modern air conditioning, special lighting, and soundproofing, it is believed that the top floor of a hospital can best be used for bright and airy sickrooms, or for areas where patients can enjoy the sunshine, and natural outdoor air.

As a result a suite of eight operating rooms, completely air-conditioned and scientifically lighted, with humidity control and all the accessories contingent to a modern surgery has been located on the ground floor. The ground floor has an area of 13,716 square feet, excluding ramps.

Four of the surgery rooms have been designed and equipped for major operations, two are available for special types of surgery, one is for minor surgery and another is completely equipped for

administering anesthetics. Each operating room is finished in green ceramic tile, 7' 5" above the floor, a special soft hue developing a feeling of coolness as well as being easy on the eyes, and each room is equipped with a surgical luminaire which hangs from the ceiling and can be moved into any desired position by the doctor, assistant or nurse. This fixture has a 350-watt lamp plus a special reflector to concentrate the light and eliminates any shadows, representing some 3000 foot-candles at the point of operation. The amount of light is comparable to what is considered excellent working light in the average office of 50 to 75 foot-candles.

The walls of operating rooms forming the outer, or street side of the building, have been finished in glass blocks, which permit unobstructed filtration of light into the room, but retain room temperatures at the desired levels.

In preparation for future use in educational programs, student and nurse training, and scientific observation purposes, one of the operating rooms

THE HERRICK HOSPITAL . . .

has been designed with a glass sheltered balcony overlooking the operating table.

Ceilings of all rooms are sound proofed with acoustical plaster on metal lath and the floors and all equipment have been grounded to prevent any electrical spark. Even the light fixtures, air-conditioning vent outlet, and other possible "friction" points have been grounded for electrical shock and made spark proof, and to further decrease the possibility of creating static the humidity of the rooms is maintained at 55 degrees.

While much of the newest equipment was not in place, Superintendent Maffly pointed out that all installations were to be of stainless steel, and latest types of refrigeration and sterilizing equipment already on hand indicated considerable improvement in design and working satisfaction of the newer types of equipment.

The obstetrical suite, which is located on the third floor plan, includes two delivery rooms, three labor rooms and facilities for fifty maternity patients. Walls of the delivery rooms are finished in oat-meal" colored tile, and here again highly developed modern lighting, sound treatment of ceilings, air conditioning, and stainless steel equip-

ment has been used. Again brick glass windows have been used to permit light from the outside, yet retaining the ability to control room temperatures as desired.

An innovation in the maternity suite is a "Father's Room," where the anxious paternal member of the family is made as comfortable as possible awaiting the arrival of the new member of the family. By means of a microphone and loud speaker, fathers can be informed by the nurse center and doctor of developments, and can be told of the baby's weight, hear baby's cry, and in general keep in touch with many of the developments which normally keep expectant fathers on the lope throughout the hospital and in everybody's way.

Immediately adjoining the maternity suite is the nursery where large shatter-proof glass windows provide an interesting view of bassinets, babies, nurses and a great array of gadgets essential to the care and welfare of tomorrow's civic, industrial and professional leaders as well as the future mothers of America.

Bed facilities of the new building include several modern advancements. Ward rooms are semi-



VIEW of portion of Maternity Delivery showing use of oatmeal colored tile on portion of wall for equipment protection.

**INTERMEDIATE
TUBE STATION**



Tube Stations such as this one enable the tubes to do double duty since carriers can be sent to the Central Tube Desk from more than one point on the same line.

partitioned for comfort of the patients and connecting wash-room facilities serve a maximum of two ward rooms. Special design, special fixtures and fittings, and localized utility facilities are provided for use in cases where patients must be segregated, for observation or treatment.

One wing of the ground floor contains a new specially arranged emergency hospital which is used by the Berkeley, north and west Oakland, Emeryville and Albany areas.

Entrance to the emergency hospital is from a loading platform, and/or ramp, through double doors operated by a magic eye for speed and safety. A nurses' station, surgery, first aid rooms, and emergency wards provide facilities for treating eleven accident victims at one time, and to provide for immediate expansion in case of an abnormal disaster, the emergency hospital is so designed that it can be enlarged to provide emergency care for 100 additional patients. Beds and equipment for disaster purposes have been stored at the hospital by the Berkeley War Council and are immediately available at any time in case of need.

To show the need for providing ample emer-

gency equipment, Mr. Maffly, hospital superintendent, informed us that during 1945 there were 7500 emergency accident victims treated in the emergency hospital, of which more than 300 were brought from the El Cerrito and Richmond areas, and from the nearby communities of Orinda, Lafayette and Walnut Creek.

The building also has a medical library, a doctors' lounge, consulting rooms, centralized admitting and administrative offices and a pharmacy designed to serve the patients, the public, and the hospital. One portion of the pharmacy is for the public, while special provision has been made for service to the hospital in-patients.

Although the building is fireproof construction there are two enclosed ramps, 15' 5" wide by 14' 11" long, one at each end of the building, to provide immediate evacuation of the hospital in event of disaster. The ramps go from the ground floor, where emergency exits have been provided, to the roof and comply in every respect to the newest trends in building code requirements which specify that hospitals have exit ramps rather than stairs.

(Continued on Page 28)

... THE HERRICK HOSPITAL

Lamson Message Carrying Tubes Speed the Handling of Records and Papers

The new addition to Berkeley Hospital at Berkeley, California, has formed a building with a layout that approaches a "figure 8." To make a complete circuit through the corridors from a given point in this building would entail a walk of 1,000 feet—nearly one-fifth of a mile.

In a busy hospital, such as this one, it is easy to imagine the traffic in corridors and elevators required to carry written messages, histories, prescriptions and drugs to all sections of the building.

To eliminate this confusion and speed operations, Alfred E. Maffly, Superintendent at Berkeley Hospital, explained that a system of pneumatic tubes had been installed making it possible to send important papers—even drugs themselves—from department to department silently, at the rate of 30 feet per second. For example, a nurse on any of the four floors can dispatch a prescription through the tubes to the pharmacy. Supervisors' rooms are always in close touch with the admitting rooms, the central supply and the nurses' stations for rapid, silent transfer of messages and orders. "Complete History" files can be sent anywhere in the hospital in a few moments.



FRONT OFFICE

In the front office, carriers are dispatched and received quietly, due to Lamson's double valve terminals.

**SUPERINTENDENT'S
OFFICE**

Note how sending and receiving terminals are cleverly concealed to blend with the interior treatment of the building.



The tube system is known as a 4-inch system, which means that the tubes through which the carriers move are four inches in diameter. The system consists of 25 receiving and 30 sending stations with provision for nine additional lines to serve future building expansion. This expansion program will include tube stations across the street in doctors' offices, in a dental building, and in a school for nurses. When this expansion project is completed, the tube lines will be run underground, connecting the various departments in the new structure with the Central Tube Desk in the present building for swift service throughout all buildings.

All the lines terminate at the Central Tube Desk, located on the first floor. Carriers have indicating rings used to designate their destination, which the sender sets before dispatching the carrier in the tube. When the carrier arrives at the Central Tube Desk, the operator looks at the number on the indicating ring and redispaches the carrier by tube to its destination.

Below is a list of the departments which are connected in the tube network:

Engineer's Office

Laundry
Central Supply
Supervisor
Record Librarian
Secretaries' Offices
Nurses' Stations on all floors
Admitting Room
Information
Pharmacy

The tube system at Berkeley Hospital was manufactured and installed by Lamson Corporation. It is what may well be termed an "All Purpose" system in that the carriers are large enough to accommodate the full range of paperwork from single paper transmission to bulky history records and drugs. Typical of other well-known hospitals using similar system are: Mayo Clinic, Rochester, Minn.; St. Mary's Hospital, Rochester, Minn.; University of Chicago Hospital, Chicago, Ill.; Strong Memorial Hospital, Rochester, N. Y.; Charity Hospital, New Orleans, La.; Jefferson Hospital, Philadelphia Pa.; Massachusetts General Hospital, Boston, Mass.; New York Hospital, New York, N. Y.



GREEN TILE recessed drinking fountain installation at the new Herrick Hospital, Berkeley, California.

(Continued from Page 25)

The ramps are of sufficient width to provide for the passing of hospital beds and in case of need, nurses will be able to roll patient beds out of rooms and down the ramp to the outside.

In keeping with its well conceived design, the building is equipped with every modern device to care for the sick. As previously mentioned the entire building is air conditioned and humidity controlled with automatic control. Germicidal lamps, glass brick, instrument autoclaves, attractive use of flexwood in the main floor lobby, halls and a portion of the stairway, and a complete system of master control clocks all combine to add to the convenience and comfort of the hospital.

Patients are able to speak directly with their nurses by loudspeaker at the bedside. This saves the nurses many needless steps, permits a faster contact and adds greatly to the comfort of the patient. The system also enables the nurse to listen in on the room, to learn if patient is restless, or how they react to treatment, thereby giving the doctor a more thorough knowledge of the patient's condition at all times.

By means of special transmitters in the surgery, delivery and labor rooms, doctors are able to issue special instructions to nurses or supervisors while engaged in operations, and throughout the entire hospital an audible call system is provided for locating a doctor at a moment's notice.

Pure air and correct temperature is assured by an extensive air conditioning system, wherein a large electric fan draws fresh air from the outside at the rate of 13,000 cubic feet per minute, forces it through cleansing filters and delivers into a chamber where a gas fired heater raises the temperature to a pre-determined minimum. From this chamber the air passes into 24 ducts which carry it into the surgery and other rooms. Each duct contains a special heater and special refrigerator equipment so that air may be heated or cooled according to the individual requirements in each room served. All of these devices are automatically thermostat controlled.

Proper circulation of air throughout the new building is provided by an exhaust fan which draws the used air from the various rooms and discharges it into the atmosphere. A smaller air conditioning unit similarly serves the maternity suite.

The Berkeley Hospital was founded in 1904 by the late Dr. Leroy Francis Herrick in one of the

city's old mansion homes with facilities for twenty patients, and is one of the pioneer medical institutions of the Oakland-San Francisco Metropolitan Bay area.

Mrs. Iva dell Herrick Henderson, daughter, is President of the Board, and Alfred E. Maffly, University of California School of Business Administration graduate, is the hospital administrator. He is assisted by H. N. Chesebrough, business manager.

The Herrick Hospital is a non-profit corporation and was dedicated in 1935 by Dr. Herrick's estate to the health of the community as a memorial to the founder. It is approved by the American College of Surgeons and the American Medical Association.

Mr. Alfred E. Maffly is a recognized hospital administrator and advisor, having attained extensive recognition in the fields of business administration, teaching profession, and educational administration prior to becoming associated with the hospital in 1933. He is a member of the board of trustees Association of California Hospitals, and is a member of the American College of Hospital Administrators, as well as being active in civic affairs of Berkeley and Alameda County.

In addition to the services for surgical, medical, maternity and emergency bed patients, the Berkeley Hospital, which has recently been renamed

Interior and Exterior

PLASTERING

Berkeley General Hospital

By

WILLIAM MAKIN

Since 1907

**Quality Plastering • Plain and Ornamental
Waterproof Stucco**

2141 Livingston Street, Oakland, Calif.

Phone: ANdover 2743



Berkeley General Hospital, Berkeley, California

WILLIS F. LYNN
CONSTRUCTION

1040 Folger Street, Berkeley, California
Telephone BERkeley 6044

"The Herrick Hospital," maintains an out-patient clinic for those who cannot afford to pay the full price of medical and hospital care. This clinic is supported by the Berkeley Hospital Guild and other philanthropic groups.

The hospital has taken an active part in the Emergency Maternity and Infant Care program, a Federal sponsored program under which free maternity care was provided for the wives of soldiers and sailors of our armed forces. This program is financed from funds of the Children's Bureau and is administered by the California State Board of Health.

Several thousand soldiers' and sailors' wives have been taken care of under this program and their babies have been born at the hospital under the B. M. I. C. program without cost to the parents.

The new hospital building, built at an approximate cost of \$8.85 a square foot, is the first of a unit planned as a Berkeley medical center which is to include a nursing school building, a new out-patient clinic building, an auditorium and class rooms for educational objectives of the community in the promotion of public health, and buildings to house doctors' offices.

Additional land adjacent to the present hospital grounds required to house these additional facilities has already been acquired by the hospital.

The Berkeley Medical Center as planned by the Board of Trustees, comprising Ivadell Herrick Henderson, President; Carolyn Herrick Nicholas, and Louis A. Martin, M. D., is designed to combine complete facilities for the prevention, diagnosis and treatment of disease for both hospital patients and ambulatory patients. Plans, of which the present new building is but the first step, also include a complete hospital teaching program to educate medical interns and resident physicians in medical specialties, and to teach nurses, hospital technicians, and attendants, as well as the public, a fuller health program.

Steam Heating, Ventilating Air Conditioning

Berkeley General Hospital

Installed by

W. A. ASCHEN

3000 E. 16TH STREET, OAKLAND

KE 4-0122

Another Outstanding Fox Installation



ALL TILE WORK IN BERKELEY GENERAL HOSPITAL by FOX TILE COMPANY

Photo at left shows interior of typical surgery room. . . . Below:
Close-up of utility room and adjoining surgery . . . wall finish is
Gladding McBean hospital green Hermosa tile.



FOX TILE COMPANY

3247 East Fourteenth Street, Oakland, California

A. I. A.

American Institute



ACTIVITIES

of Architects

Arizona Chapter:

James Macmillan, President; Arthur T. Brown, Secretary, 740 N. Country Club Road, Tucson, Arizona.

Central Valley of California:

Herbert E. Goodpastor, President; Frank V. Mayo, Secretary, 307 Exchange Building, Stockton 2, California.

Colorado Chapter:

Raymond H. Ervin, President; James M. Hunter, Secretary, 2049 Broadway, Boulder, Colorado.

Montana Chapter:

Ralph H. Cushing, President; H. C. Cheever, Secretary, Montana State College, Bozeman, Montana.

Northern California Chapter:

Andrew T. Hass, President; John S. Bolles, Secretary, 369 Pine Street, San Francisco 4, California.

Oregon Chapter:

Francis Jacobberger, President; J. D. Annand, Secretary, 401 Central Building, Portland 5, Oregon.

San Diego Chapter (California):

H. Louis Bodmer, President; Louis J. Gill, Secretary, 203 Granger Building, San Diego, California.

Santa Barbara Chapter (California):

Roy C. Wilson, President; Miss Lutah M. Riggs, Secretary, 240 Middle Road, Santa Barbara, California.

CALIFORNIA COUNCIL OF ARCHITECTS:

John S. Bolles, President; Charles O. Matcham, Vice-President; James H. Mitchell, Secretary-Treasurer; 369 Pine Street, San Francisco 4.

Southern California Chapter:

Charles O. Matcham, President; John Landon, Secretary, Chapter Headquarters 3757 Wilshire Blvd., Los Angeles 5, California.

Spokane Chapter (Washington):

Noel E. Thompson, President; Kenneth D. Stormont, Secretary, Hutton Building, Spokane 8, Washington.

Utah Chapter:

George Cannon Young, President; Theodore R. Pope, Secretary, 29 South State Street, Salt Lake City 1, Utah.

Washington State Chapter:

George W. Stoddard, President; Stephen H. Richardson, Secretary, 516 Central Bank Building, Seattle, 4, Washington.

Hawaii Chapter:

Kenneth W. Roehrig, President; James Morrison, Secretary, 334 Federal Bldg., Honolulu, T. H.

WASHINGTON STATE CHAPTER

A recent Chapter meeting was devoted to a panel discussion and review of the Institute's "Principles of Professional Practice," with various members appointed to lead subjects under review.

* * *

NEW CHAPTER ASSOCIATES include Marshall W. Perrow and Ross F. Copeland.

* * *

TACOMA members journeyed to Seattle recently to hear James R. Edmunds, Jr., President of the Institute, discuss industry subjects at an informal breakfast conference at the Seattle Tennis Club.

Silas Nelson, program chairman, is producing some excellent meetings for the Tacoma Chapter: Veterans' Housing, color slides on Frank Lloyd Wright's "Taliesin" in Wisconsin, and City Planning Commission proposals.

SOUTHERN CALIFORNIA CHAPTER

Attention was called to a resolution adopted at the Miami Convention relative to Veterans Housing: "Resolved, as the sense of the meeting, That this meeting disapproves the Veterans Emergency Housing Program on the ground that it is based on political expediency, is unsound economics, and will not result in the production of much needed housing for veterans."

Subsequent developments have substantiated the failure of the program.

The Chapter's Urban Planning committee has been very active and is coordinating their program with national trends towards "entire city" planning, rather than just certain areas.

Robert E. Alexander has been appointed co-chairman of the A.I.A. Committee on Urban Planning, covering the eleven western states, Alaska and Hawaii.

* * *

The Chapter Honor Awards Program, scheduled for this month, will be the first in eight years, George Allison, committee chairman announces. Judges are three prominent non-Chapter members. Awards will be presented at the December meeting.

CENTRAL CALIFORNIA CHAPTER

Central Valleys Chapter, A.I.A., quarterly meeting was held in Sacramento, September 27th; present were representatives from Stockton, Modesto, and Fresno. Considering the distances traveled by these Architects to attend this meeting shows that the San Joaquin members are vitally interested in the new organization.

Herb Goodpastor was unable to preside at the meeting, as his presence was requested as representative from this area to the California Council meeting at Santa Maria on the same day.

Among business discussed, the most important subject was the instructing of representatives on problems to be brought up at the State Convention.

First was: with the adoption of the uniform code by the cities and counties that the Architects' clause be inserted limiting the amount of construction costs which could be done without a licensed Architect or Engineer.

Secondly that the Architects be represented in the Uniform Building Code Conference.

Of Sacramento concern that may interest Archi-

(Continued on Page 40)

WITH THE ENGINEERS

Structural Engineers Association of Northern California

W. Adrian, President; William W. Moore, Vice-President; Franklin P. Ulrich, Sec.-Treas.; John A. Blume, Ass't. Sec.-Treas.; Offices 214 Old Mint Building, San Francisco, Phone GARfield 3890. DIRECTORS, H. M. Engle, Mark Falk, and M. V. Pregnoff.

American Society of Civil Engineers San Francisco Section

Theodore P. Dresser, Jr., President; Leon H. Nishkian and Sidney T. Harding, Vice-Presidents; John E. Rinne, Secretary-Treasurer; 225 Bush St., San Francisco 20.

Puget Sound Council (Washington) Engineering & Technical Societies

R. E. Kistler, A. I. E. E., Chairman; A. L. Miller, A.S.C.E., Vice-Chairman; L. B. Cooper, A.S.M.E., Secretary; B. A. Travis, I.E.S., Treasurer; Offices, Seattle, Washington.

ANNUAL MEETING OF THE STRUCTURAL ENGINEERS ASSOCIATION OF CALIFORNIA

A joint convention of the Structural Engineers Association of Northern California and the Structural Engineers of Southern California was held at Santa Barbara October 11, 12 and 13.

This was the first meeting of the two groups since the beginning of the war, and over 150 structural engineers and their wives attended. The President of the Structural Engineers Association of Southern California, Ernst Maag, presided at all meetings and at the banquet. A golf tournament

★ FOR BETTER SERVICE

Remember that

KRAFTILE is WESTERN HEADQUARTERS

For these well-known products:

★ **GEMCO** Insulation Hangers, Hangar Supports, Anchor Nails and Bolts.

★ **MINWAX** Waterproofings, Dampproofings, Caulkings, Waxes and Wood Finishes, Brick and Cement Coatings.

★ **RAYBESTOS** Safety Decking.

★ **STRAN-STEEL** Quonset "Packaged" Steel Buildings.

★ **KRAFTILE** Acid Brick, Ceramic Facing, Glazed Structural Wall Units, Patio Tile, Quarry Tile, Swimming Pool Overflow Gutter.

★ **MIRACLE** All-Purpose Adhesives.

★ **NUKEM** Acid-Proof Materials and Construction.

For complete information and prompt service, phone or write

KRAFTILE COMPANY

Niles, California

Niles 3921

San Francisco — 50 Hawthorne Street, DOUGLAS 3780

was held Friday, October 11, while Saturday, October 12, was an intensive and interesting business session lasting all day. At the banquet Saturday evening, William Jeffers, past president of the Union Pacific Railroad, was the guest of honor and principal speaker. His topic was "A Structural Analysis of the American Foundation." This was the largest convention ever held by the Structural Engineers Association, and was considered a pronounced success.

SAN FRANCISCO SECTION AMERICAN SOCIETY OF CE

The October 15th meeting was devoted to a "Symposium on the Aviation Industry," led by James M. Kite, Plant Engineer of Consolidated Vultee Aircraft Corporation, who spoke on "The Trend in Planes and Engines"; Arthur J. Hook, Assistant Regional Administrator of the C.A.A., who spoke on "The Requirements of Airports, Such as Strengths and Sizes of Landing Strips," and J. G. Bastow, whose subject was "The Management Aspects of Airports." Mr. Bastow is Assistant Manager and Assistant Chief Engineer of the Port of Oakland.

* * *

New Members: Rex A Daddisman, Erik Rettig, George E. Schumann, and Earl H. Thouren. Associate Members include George T. Dean, Louis Graham, L. J. Meszaros, and Harold C. Shandrew. Junior Members: S. F. Burmeister, Arve H. Dahl, Bernard B. Gordon, Otto Hoefler, Edward E. Kadel, F. H. Karstedt, Frank E. McClure, T. E. Newman, H. T. Osborne, T. W. Power, and George E. Wade. Total membership is now 757.

* * *

Student Chapters: Enrollment at the University of California, College of Engineering, is approximately 3500; while at Stanford University the engineer enrollment is in excess of 1170 students.

ENGINEERING MEETING

The National Air Transport Engineering meeting of the Society for Automotive Engineers will be held in Chicago, Illinois, on December 2, 3 and 4.

NORTHERN CALIFORNIA STRUCTURAL ENGINEERS ASSOCIATION MEET

The regular November meeting was devoted to a consideration of an adjusted dues schedule; minimum fees schedule for engineering services; industry labor problems, and reports on the annual meeting of the Structural Engineers Association of California held in Santa Barbara recently.

Thirty-three members reported attending the Santa Barbara conference.

Where Do We Go From Here?

(Continued from Page 10)

ment, but that does not enable us to sit back and do nothing. Building costs must come down. Otherwise we face a drastic reduction in the demand for construction. Call it a buyer's strike or what you will, the fact remains that the construction industry cannot hope for prosperity if it must continue to operate at today's costs.

This problem is one that demands the co-operation and close attention of everyone concerned with building. And I mean everyone, including labor.

The increased cost of building is no secret. It is beginning to receive nation-wide attention, not to say notoriety. Something will be done to remedy the situation. And if we in the industry are unable to offer some solution, I know and you know that the Federal government will step in and try to take over. That is a possibility which must be averted because, judging by the record of the past, government would accomplish but little except to pyramid the confusion and chaos which now characterizes our controlled construction industry. Governmental intervention is no answer to reduction of building costs.

Fortunately, there is reason to expect that two factors currently contributing to the high cost of building may disappear before long. The black market which is adding 15 per cent and more to the cost of many structures being erected today. We can assume that the black market will disappear when the supply of building materials becomes large enough to meet the demand, although I hazard no prediction as to when that happy day will arrive.

An increased supply of materials also would bring an end to the delays on the site, which are adding heavily to building costs today. When we can complete a small home or store building in three or four months, instead of the six to eight or more required today, builders' costs automatically will go down, but not enough.

Before talking further about how to reduce costs, I should like to ask the question: Why have they increased so greatly? Why has the cost of building jumped 60 per cent or more in some localities?

Is it because manufacturers of building products are making fabulous profits? No, they earn no more, by and large, than they did before the

Don't forget to . . .



Plan ahead for built-in telephone outlets



It's a wise economy to specify a number of telephone outlets in the houses you are building . . . even if only one telephone is all that is needed immediately.

Conduit is inexpensive to install during building . . . and built-in telephone outlets add real value to a home.



Your clients will appreciate your foresight in planning with an eye to future needs. Call or dial your local Telephone Business Office and ask for Architects' and Builders' Service.

The Pacific Telephone and Telegraph Company



STEELEFORMS

Steeltube Construction
Towers

Heavy Duty Swinging
Scaffolds

OUR STEELFORMS USED IN
BERKELEY GENERAL HOSPITAL

STEELFORM CONTRACTING CO.

SAN FRANCISCO • SEATTLE • LOS ANGELES

BAXCO

CHROMATED ZINC CHLORIDE

CHZC

PRESSURE TREATED LUMBER

● **PROTECTS AGAINST DECAY
AND TERMITE ATTACK**

*Specify it in your home
Available through Lumber Dealers*

LOS ANGELES
601 W. 5th Street
Phone Mlchigan 6294

SAN FRANCISCO
333 Montgomery Street
Phone DOuglas 3883

J. H. Baxter & Co.

AGENTS FOR WEST COAST WOOD PRESERVING CO. SEATTLE, WASH.

WHERE DO WE GO FROM HERE?

war, and some are making no profits. Is it because financing charges have increased? No, interest rates are well below prewar levels. Is it because architects and engineers are making excessive fees? No, they are still doing business at the same old rates.

Is it because material dealers are getting rich at the expense of the builder and owner of new construction? That cannot be the answer, when most dealers have little or nothing to sell and operate under OPA ceilings which limit their markups.

No, the cause of higher building costs lies elsewhere and I think we should place it where it belongs. This is at the door of labor and at the door of the Federal government. With full realization that I am entering upon controversial ground, I wish to state that a full 90 per cent—and this is conservative—a full 90 per cent of the increased cost of building is attributable to labor and government.

Government has contributed to our higher costs through higher taxes and ill-advised and inept efforts to control the economy and the construction industry, which have reduced material production and encouraged work stoppages.

Labor has contributed the greater share of the increased cost through higher wage levels all along the line and, what is far worse, through its own reduced productivity, and through strikes in the building and related industries. I do not refer alone to the wages paid on the building site. Those are not the only wage increases which affect cost. We must take into account also the higher wages being paid in the mines and quarries, in manufacturing and transporting building products, and in the production of raw materials and supplies used in the manufacture of building materials and equipment.

Thus, it is the nation's labor force, which so eagerly awaits new homes, that is primarily responsible for the high cost of providing those homes. That is an inescapable fact and it's high time they knew it.

Let me make plain that I am in no sense objecting to or criticizing the higher wage rates labor is receiving today. I could wish they be twice as much. But you know and I know, and some few enlightened labor leaders also know, that labor cannot simultaneously receive higher wages and deliver less effort on the job.

To be fair it must be acknowledged the lower productivity of labor is in small part due to delayed arrival of materials on the job, which results in temporary idleness, but it is also true that labor is delivering less work per hour when materials are available.

Labor, which is enjoying unprecedented wage rates in manufacturing and building, can maintain those rates and enjoy reasonably steady year-round employment for all in its ranks only by restoring its work output to prewar levels and then going on to step up its productivity still further.

If that does not come about, labor itself will be the chief victim of its own shortsightedness. Not only will it be unable to obtain homes at reasonable prices—it will also bring about a reduction in building volume which will mean widespread unemployment in the building trades and elsewhere.

I offer no plan for selling this point of view to labor. I merely state that until labor does see the light, aided by whatever reasonable concessions that can be made by employers, we cannot expect and will not see any large reduction in the cost of construction.

Some way must be found of convincing labor that greater work output per man-hour and the use of labor-saving methods and equipment will work to the benefit of labor in terms of greater total annual income and steadier employment over the years.

To be specific, restrictive labor practices and refusal to take advantage of on-site labor-saving devices must go. As a case in point, there is the painters' opposition of the spray gun, which in many instances will do a finer job in less time and with less material than can be done with a brush. I could cite you others equally indefensible and absurd, all of which contribute to the present trouble.

Moreover, all of us in the construction industry must work together to persuade the Federal government and the Congress that controls which defeat their purpose are worse than no controls at all, and that if controls must continue in force, steps must be taken to apply them with greater wisdom than is apparent today or has been exercised in the past.

No one in the building industry contends however, that opportunities to reduce building costs are confined to the field of labor. There is much that all of us can do. The architect must concentrate on reasonable economy to a greater extent than ever before. It will be necessary to eliminate some of the luxuries in building while costs remain high, although there must be no let-down in the underlying quality of construction.

Already there has been too great a let-down in quality. Nails are scarce and expensive, so fewer nails are used per house. We see green lumber and makeshift substitutes that greatly impair the quality of the all too few homes we are able to complete for our veterans.

(Continued on page 39)

MODERN IS AS MODERN DOES

As an architect, you realize that homes not wired for the most convenient and efficient use of electricity cannot be called modern, even though they are new.

Your client may not realize how much his future comfort depends on a full measure of electricity for improved home lighting and an ever-expanding list of new electrical appliances; he may not understand that the difference is so small between a good wiring job and a poor one . . . until you tell him.

But when the house is built and occupied, he will remember, with increasing satisfaction, your thoughtfulness in insisting on a wiring installation completely adequate for modern living.

NORTHERN CALIFORNIA ELECTRICAL BUREAU

1355 MARKET STREET
SAN FRANCISCO 3



The New
Berkeley General Hospital
Is Electrically
Equipped Throughout

Nurses' Call and Public Address System
and
Lighting Fixtures

installed by

MATSON ELECTRICAL EQUIPMENT CO.

Industrial Electrical Construction

3781 BROADWAY, OAKLAND

HUmboldt 1294



LOS ANGELES

Branch Offices

HOLLYWOOD	SIERRA MADRE	UPLAND
PASADENA	TEMPLE CITY	LA VERNE
LONG BEACH	WHITTIER	SAN PEDRO
RIVERSIDE	ONTARIO	INDIO

OAKLAND
SAN FRANCISCO

HEADLINE NEWS & VIEWS

By E. H. W.

The board of directors of the United States Steel Corporation met in regular session in San Francisco recently . . . the "Ayes" of many manufacturers are turning towards the "West" these days

* * *

Sixteen surplus balloons, "without engines," were placed on sale recently by the OAD in Washington . . . guess the balloons were "gassed" up all right for there certainly isn't any shortage of hot air in the capital city, although motive power may be missing.

* * *

G. E. Morris, Superintendent of Building for the City of Los Angeles, contends that "State Laws Hamper Building Construction." He says, "The effect of State laws on local jurisdiction is becoming a problem of general application to architects and engineers." Many simple Acts passed by the Legislature see daylight through voluminous arbitrary rules and regulations of some Bureau or Board.

* * *

THE BIG PUSH IS ON

Wilson W. Wyatt, NHA Housing Expediter, and John D. Small, Civilian Production Administrator, were among "the prominents" attending the recent American Legion national convention in San Francisco. Wyatt's junket, to a veterans' meeting and just prior to the fall election, couldn't have possibly been in the interest of stimulating votes! Perhaps the "WET Bill" isn't as cut and dried as some think.

* * *

HOW LONG IS A PIECE OF ROPE?

A few wears ago it was the NRA. Now it is the OPA, CPA, FHA and dozens of other alphabetical designations which all add up to the same conclusion—a tremendous national political influence, which will wage a mighty fight for perpetuation.

The answer—to the alphabet gyrations? Well, you guess . . . but, as to the rope, well that's from beginning to end—perhaps NRA to OPA, who knows.

* * *

PLASTICS SHOW

The Society of Plastic Engineers will hold a plastic show and exhibition in Chicago on January 28 to February 2, 1947. The event will be held in conjunction with the Society's annual convention.

IN THE NEWS

INDUSTRIAL DESIGNERS

Raymond Loewy, New York, has been elected president of the Society of Industrial Designers for the ensuing year. Harold Van Doren has been named vice-president Egmont Arens, secretary, and Ray Patton, treasurer. Professional education and a Code of Practice for the professions are among major objectives of the group.

NEW HOME VALUES UP

Values of new homes built in 310 cities totaled \$374,702,407 in 1945, which represents a gain of 72.5 per cent over the preceding year.

Volume of home building gained only 25.8 per cent, and was 161,728 new dwelling units less than the peak year of 1941.

NAMED VICE-PRESIDENT

J. P. Cunningham, West Coast specialist in the application of insulation, has been named vice-president of the Industrial Insulation Corporation of Fresno, California, according to a recent company announcement.

He will have charge of engineering and application.

NEW DAMPER DIFFUSES AIR

Simplified, lightweight aluminum air volume damper known as the KNO-DRAFT high velocity air diffusers, manufactured by the W. B. CONNOR ENGINEERING CORP., 114 E. 32nd Street, New York.

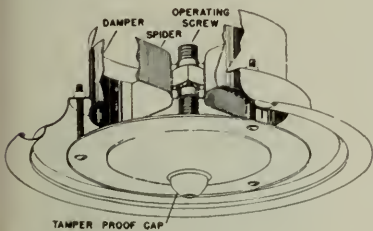

The cylindrical damper is raised or lowered by turning the extended shank of the operating screw. Any air volume may thus be quickly and easily obtained. Complete handbook available by writing manufacturer.

JOSEPH COPP, Jr., Landscape Architect, has moved to 8649 Sunset Blvd., Los Angeles 4, California.

The West's Outstanding Lighting Equipment

Users know from experience that the Smoot-Holman label is an assurance of quality. Look for it whenever you select lighting equipment, and be assured of outstanding service and trouble-free performance.

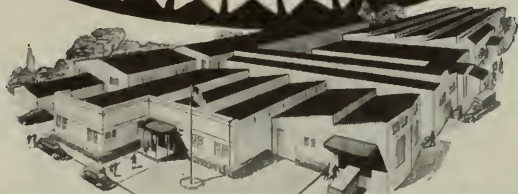
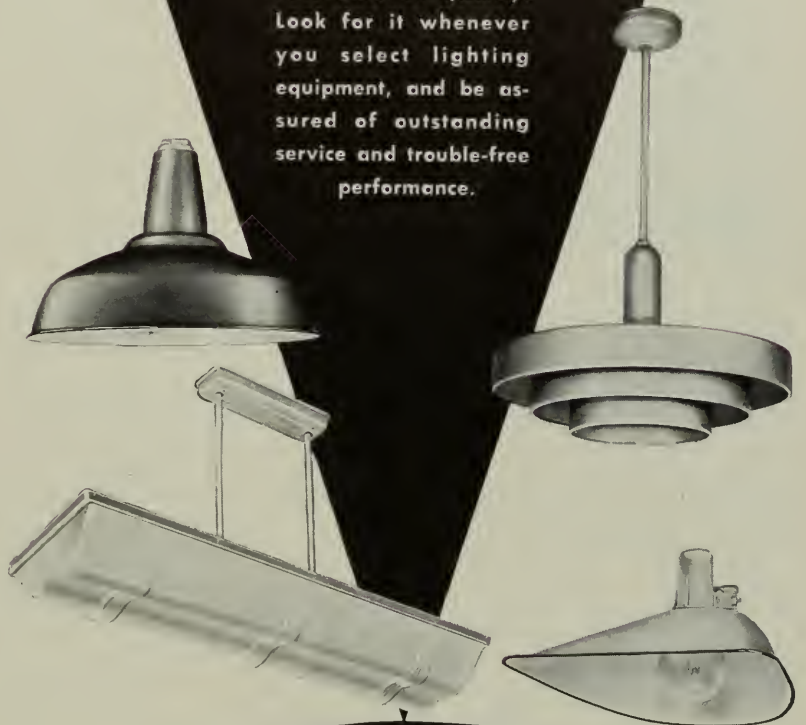

Offices in Principal Western Cities—Branch and Warehouse in San Francisco

PRODUCER'S COUNCIL PAGE

The National Organization of Manufacturers of Quality Building Materials and Equipment
affiliated with THE AMERICAN INSTITUTE OF ARCHITECTS

President, E. E. CATHCART
Johns-Manville Sales Corp.
116 New Montgomery St.

Vice-President, C. J. NICHOLAS
Boston-Morley Co.
301 Brannon St.

Secretary, H. C. GALITZ
Westinghouse Electric Corp.
110 Sutter St.

Treasurer, E. P. LARSON
Celatex Corp.
675 Townsend St.

Edited by C. W. KRAFT, KRAFTILE CO., Niles, California

NORTHERN CALIFORNIA CHAPTER



C. T. Hallsted
American Lumber & Treating Co.

It's been quite a while since we've had an opportunity to pry into the life of a local boy on this "Page" but "Clint" is it. He was born in Sacramento, graduated from "Cal" where he majored in Forestry, studied Engineering and Business Administration. Being a young man, service to his country claimed a large part of his attention in recent years including pre-Pearl Harbor service in Naval Intelligence, followed by duty on mine-sweepers, sub-chasers and a Navy Transport. Clint ended the war as a Lieutenant Commander.

Clint joined American Lumber & Treating Company out of college in 1939, serving his apprenticeship in the mills. Prior to the war he served as Sales Representative in their Los Angeles office, now operates in a similar capacity from San Francisco.

He is married, has a boy and girl, lives in Oakland. His other organizations are Alpha Delta Sigma (National Advertising) and San Francisco Lumbermen's Club. His favorite sports are hunting, fishing and tennis.

SILVER JUBILEE of the Council was celebrated by the admission of Chapter 25 (Florida) in Jacksonville. Novel in the new Chapter's set-up is the fact that it covers the state with branches in Miami and Tampa. Suggestion has been made that the Chapter presidency be rotated between the three cities.

KANSAS CITY NEXT on the list of Chapters. Soon to become No. 26.

MEANWHILE Chapter 1 is not standing still. Introduced at our October 7th meeting were six

new members: Harry E. Goss, J. A. Zurn Mfg. Co.; Don L. Braley, U. S. Plywood Corp.; Arthur C. Staat, Natural Gas Equipment, Inc.; Wm. C. Thieleman, Pioneer Division, Flintkote Co.; B. F. Wade, California Redwood Association; James H. Moscrip, L. Sonneborn Sons, Inc. Total membership now 42 companies and divisions.

BUILDING INDUSTRY CONFERENCE BOARD continues to receive our full support: Chapter members took an active part in the 2nd All-Day Conference held October 22nd for the purpose of developing information on the construction industry of interest to the public.

VETERANS' HOSPITAL MODULAR, a 500-bed Veterans' Hospital in the Omaha area is being planned in modular dimensions by the architects, Ellerbe & Co., St. Paul. Steps are being taken now to acquaint the U. S. Corps of Engineers and the Architectural Consultants to the program with the benefits of modular coordination, and it may be that this Omaha job is merely a forerunner of a sizable program of modular construction.

AGC BLESSING ON MODULAR STANDARDS. The Associated General Contractors of America, Inc., at a meeting in Denver on July 2, 1946, endorsed the first two American Standards on modular coordination. The importance of support by building contractors increases as modularly designed jobs are submitted for bids and advance to the construction stage.

UNIFORM CODES AS \$ SAVERS. Adoption of a modernized uniform building code by cities throughout the country would result in large savings to taxpayers and reduce construction costs as much as 5 to 10 per cent, according to Albert H. Baum, building commissioner of St. Louis, Mo.



USE QUALITY PRODUCTS



CONSULT AN ARCHITECT

WHERE DO WE GO FROM HERE?

(Continued from Page 35)

Furthermore, it is high time we went beyond the talking stage with respect to modernization of building codes, elimination of restrictive practices other than those of labor, and with research. The amazing progress which has been made in the adoption of dimensional co-ordination should serve to stimulate our efforts in other directions. Five years ago, dimensional co-ordination was little more than a dream. Today, through the efforts of the Basic Foundation, the Producers' Council and the A.I.A., co-ordinated dimensions are a reality, partly because the wartime lull gave more time to work out the details and change over manufacturing processes, but mostly because we finally got down to work. We can make the same headway on these other problems if we decide to come to grips with them.

Progress is being made on building codes but even with the support of several influential governmental agencies, this is but little more than a good start. If each of us in his own community would lend his support to code revision, we could get somewhere.

The lack of progress in research is exceedingly disappointing. Great opportunities for reducing costs lie before us in the development of new methods of using materials in combination, but the facilities for co-ordinated research so far are entirely lacking. Those who object so vociferously to governmental encroachment in this field might well come forward with an adequate substitute in the form of a privately sponsored research program. The United States Chamber of Commerce is developing a plan which will offer this opportunity. If we wait too long, government is likely to step in and take over one more segment of private enterprise.

The fact is that the building industry as a whole is "on the spot." It is in no sense responsible for the greater part of the increase in building costs, nor for the shortage of housing, nor for the failure to provide other needed industrial and commercial restrictions; nevertheless, industry must come forward with a workable answer to these problems if it wishes to regain and continue to enjoy maximum freedom of enterprise.

The spirit of government control is in the air. Large groups of our people seemingly know no other answer to any problem than expanded governmental participation. They may well rush us off our feet unless we find the answer to our problems in the immediate future.

The precedents for governmental control have been established. The pattern is set. The public,

STRUCTURAL STEEL

For Class A Buildings,
Bridges, etc.

JUDSON PACIFIC - MURPHY CORP.

1200 SEVENTEENTH STREET
SAN FRANCISCO

Plants: San Francisco - Oakland

SISALKRAFT

REG. U. S. PAT. OFF.

"More than a building paper"

THE SISALKRAFT CO.

205 West Wacker Drive
Chicago, Ill.

55 New Montgomery Street
San Francisco, Calif.

BASALITE

LIGHTWEIGHT CONCRETE
BUILDING UNITS

CHARACTER • ECONOMY • INSULATION
FIRE-SAFE • TERMITE PROOF • PERMANENCE

BASALT ROCK CO., INC.

NAPA, CALIFORNIA

FORDERER CORNICE WORKS

Manufacturers of

Hollow Metal Products • Interior Metal Trim
Elevator Fronts and Cabs
Metal Plaster Accessories • Sanitary Metal Base
Flat and Roll Metal Screens
Metal Cabinets • Commercial Refrigerators

269 POTRERO AVE.

SAN FRANCISCO, CALIF.

HEMLOCK 4100

GOOD CONSTRUCTION DEMANDS

3 HINGES TO A DOOR

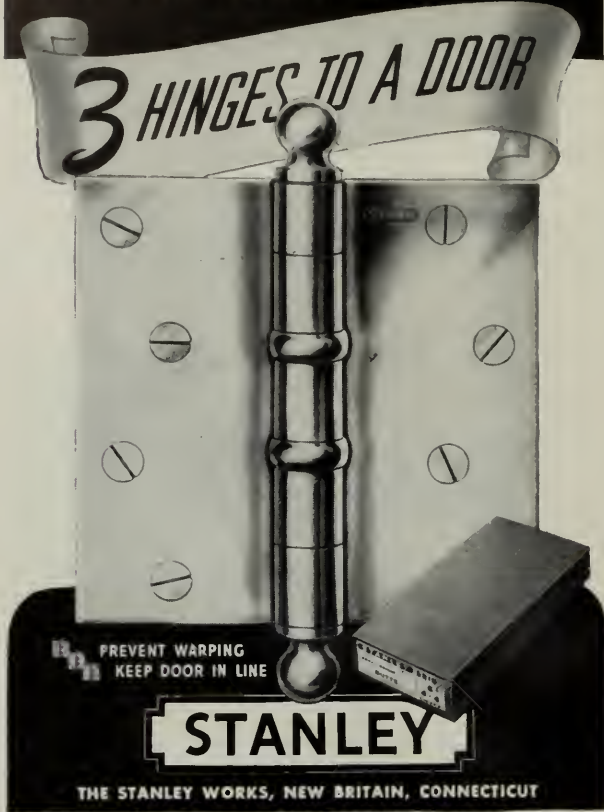

VALUABLE NEWS SERVICE

Building material dealers, contractors, engineers, and financial institutions find ARCHITECT'S REPORTS highly valuable in the operation of their business.

ISSUED DAILY at a total cost of \$10 per month these handy, individual slip-reports give ADVANCE news on construction projects in Northern California . . . listing name of project, location, architect, proposed cost and other pertinent information.

DON'T DELAY! SUBSCRIBE TODAY!

ARCHITECT'S REPORTS

Published Daily by

ARCHITECT and ENGINEER, Inc.

68 Post Street, San Francisco

EXbrook 7182

WHERE DO WE GO FROM HERE?

which necessarily is inadequately informed regarding the complex economic problems which confront it, and our Congress, which is compelled by the need of the day to give insufficient thought and study to the many crises which arise, are becoming impatient, are both inclined to believe that industry somehow is at fault. They have not yet learned that government, which is more at fault, will unquestionably do a worse job than industry. We can avert the threat of a controlled building industry only by coming up with a satisfactory substitute for governmental action.

In the face of the greatest demand for new building at all times, and with billions of private funds available to pay for the needed construction, it will be a sad commentary on its own collective ingenuity if our industry finds itself permanently shackled by high costs and governmental domination.

Not only do we need millions of new homes and other buildings—there is also the task of rebuilding our decadent cities. The American Institute of Architects intends to play its full part in planning a solution to this highly complex problem, in co-operation with other national professional organizations, but here again excessive building cost is a stumbling block. We face a tremendous job of public education before real progress is possible. This must be attacked with full resolution, vigor, and endurance until we accomplish our ends.

Let me say that I have full confidence in the ability of private construction industry to find its way out of the dilemma which it faces, though I am not so certain that we will get our "steam up" in time to avoid some unfortunate developments.

We may have to experience anguish before we rise to our opportunities and responsibilities. But if we devote to the problem of cost reduction and constructive planning the same zeal and energy that we spend attacking those who seek to impede and encompass us, we will astound even ourselves by our accomplishments, not alone in the interest of our own profession or that of our great industry, but in that of the public common good!

A.I.A. ACTIVITIES

(Continued from Page 31)

sects in other localities:

The Sacramento Architects have formed a Small House Committee, consisting of Gordon Stafford, Silvio Barovetto and William Koblik. They are in the process of creating an Architects' Small House Bureau. Standard sheets, etc., will soon be distributed, an exhibit is being planned, and the possibility of a model home is in the preliminary.

ESTIMATOR'S GUIDE

BUILDING AND CONSTRUCTION MATERIALS

PRICES GIVEN ARE FIGURING PRICES AND ARE MADE UP FROM AVERAGE QUOTATIONS FURNISHED BY MATERIAL HOUSES TO SAN FRANCISCO CONTRACTORS. 2½% SALES TAX ON ALL MATERIALS BUT NOT LABOR

All prices and wages quoted are for San Francisco and the Bay District. There may be slight fluctuation of prices in the interior and southern part of the state. Freight cartage, at least, must be added in figuring country work.

BONDS—Performance—\$10 per \$1000 of contract. Labor and materials, \$10 per \$1000 of contract.

BRICKWORK—

Common Brick—Per 1M laid—\$50.00 to \$60.00 (according to class of work).

Face Brick—Per 1M laid—\$120 to \$150 (according to class of work.)

Brick Steps—\$1.60 per lin. ft.

Brick Veneer on Frame Bldg.—Approx. \$1.30 per sq. ft.

Common Brick—\$19.00 per M, truckload lots, f.o.b. job.

\$19.00 per M, less than truckload, plus cartage.

Face Brick—\$40 to \$80 per M, truckload lots, delivered.

Cartage—Approx. \$4.00 per M.

BUILDING PAPER—

1 ply per 1000 ft. roll	\$4.25
2 ply per 1000 ft. roll	6.25
3 ply per 1000 ft. roll	7.75
Brownskin, Standard, 500 ft. roll	6.00

BUILDING HARDWARE—

Sash cord com. No. 7	\$1.20 per 100 ft.
Sash cord com. No. 8	1.50 per 100 ft.
Sash cord spot No. 7	1.90 per 100 ft.
Sash cord spot No. 8	2.25 per 100 ft.
Sash weights, cast iron, \$50.00 ton.	
Nails, \$3.42 base.	
Sash weights, \$45.00 per ton.	

CONCRETE AGGREGATES—

The following prices net to Contractors unless otherwise shown.

Gravel, all sizes—		
\$1.95 per ton at Bunker; delivered	\$2.50	
	Bunker	Del'd
Top Sand	\$1.90	\$2.50
Concrete Mix	1.90	2.45
Crushed Rock, ¼" to ¾"	1.90	2.50

Crushed Rock, ¾" to 1½"	1.90	2.50
Roofing Gravel	2.25	2.80
River Sand	2.00	2.45

Sand—

River Sand	2.00	2.45
Lapis (Nos. 2 & 4)	2.85	3.15
Olympia (Nos. 1 & 2)	2.85	3.10
Del Monte White84c per sack	

Cement—

Common (all brands, paper sacks), carload lots, \$2.42 per bbl. f.o.b. car; delivered \$2.72. Cash discount on carload lots, 10c a bbl., 10th Prox.; less than carload lots \$3.20 per bbl. f.o.b. warehouse or delivered.

Cash discount 2% on L.C.L.

Atlas White }
Calaveras White } 1 to 100 sacks, \$2.50 sack
Medusa White } warehouse or del.; \$7.65
bbl. carload lots.

Forms labor average \$350 per 1000 sq. feet.

Average cost of concrete in place, 50c per cubic foot, exclusive of forms; \$15.00 per cubic yard. With forms \$1.60 per cubic foot.

DAMP-PROOFING and Waterproofing—

Two-coat work, \$3.50 per square.

Membrane waterproofing—4 layers of saturated felt, \$7.00 per square.

Hot coating work, \$2.50 per square.

Medusa Waterproofing, \$3.50 per lb. San Francisco Warehouse.

Tricocel waterproofing.

(See representative.)

ELECTRIC WIRING—\$12 to \$15 per outlet for conduit work (including switches).

Knob and tube average \$3.00 per outlet. (Available only for priority work.)

ELEVATORS—

Prices vary according to capacity, speed and type. Consult elevator companies. Average cost of installing a slow speed automatic passenger elevator in small four story apartment building, including entrance doors, about \$6500.00.

EXCAVATION—

Sand, 60 cents; clay or shale \$1 per yard.

Trucks, \$20 to \$32 per day.

Above figures are an average without water. Steam shovel work in large quantities, less; hard material, such as rock, will run considerably more.

FIRE ESCAPES—

Ten-foot galvanized iron balcony, with stairs, \$150 installed on new buildings; \$160 on old buildings.

FLOORS—

Composition Floors, such as Magnesite, 50c per square foot.

Linoflor—2 gages—\$1.25 to \$2.75 per sq. yd.

Mastipave—90c to \$1.50 per sq. yd.

Battleship Linoleum—available to Army and Navy only—1/8"—\$1.75 sq. yd. 3/8"—\$2.00 sq. yd.

Terazzo Floors—50c to 70c per sq. ft.

Terazzo Steps—\$1.75 per lin. ft.

Mastic Wear Coat—according to type—20c to 35c.

Hardwood Flooring—

Standard Mill grades not available.

Victory Oak—T & G

1 1/2" x 2 1/4"\$143.25 per M. plus Cartage

1/2" x 2" 122.00 per M. plus Cartage

1/2" x 1 1/2" 113.50 per M. plus Cartage

Prefinished Standard & Better Oak Flooring

1 1/2" x 3 1/4"\$180.00 per M. plus Cartage

1/2" x 2 1/2" 160.50 per M. plus Cartage

Maple Flooring

1 1/2" T & G Clear \$160.50 per M. plus Ctg.

2nd 153.50 per M. plus Ctg

3rd 131.25 per M. plus Ctg.

Floor Layers' Wage, \$1.87 1/2 per hr. (Legal as of Jan. 21, 1946. Given us by Inlaid Floor Co.)

GLASS—

Single Strength Window Glass.....20c per ft

Double Strength Window Glass.....30c per ft.

Plate Glass, under 75 sq. ft.....\$1.00 per ft.

Polished Wire Plate Glass..... 1.40 per ft.

Rgh. Wire Glass34 per ft.

Obscure Glass27 per ft

Glazing of above is additional.

Glass Blocks\$2.50 per ft. set in place

HEATING—

Average, \$1.90 per sq. ft. of radiation, according to conditions.

Warm air (gravity) average \$64 per register.

Forced air, average \$91 per register.

IRON—Cost of ornamental iron, cast iron, etc., depends on design.

LUMBER—All lumber at O.P.A. ceiling prices—

No. 1 Common.....\$49.00 per M
 No. 2 Common.....47.75 per M
 Select O. P. Common.....52.75 per M

Flooring— Delvd.
 V.G.-D.F. B & Btr. 1 x 4 T & G Flooring....\$80.00
 C 1 x 4 T & G Flooring.....75.00
 D 1 x 4 T & G Flooring.....65.00
 D.F.-S.G. B & Btr. 1 x 4 T & G Flooring.....61.00
 C 1 x 4 T & G Flooring.....59.00
 D 1 x 4 T & G Flooring.....54.00
 Rwd. Rustic—"A" grade, medium dry.....82.00
 3 to 20 feet
 "B" grade, medium dry.....78.50
 6 to 20 feet

Plywood—not available
 Under \$200 Over \$200
 "Plyscord"— $\frac{3}{8}$ ".....\$49.50 \$47.55
 "Plywall"— $\frac{1}{4}$ ".....45.15 43.30
 3 ply— $2\frac{1}{2}$ — $\frac{1}{4}$ ".....48.55 46.60
 "Plyform"— $\frac{5}{8}$ "—
 Unoiled.....126.50 121.45
 Oiled.....127.90 122.75

Above prices delivered if quantity is sufficient to warrant delivery.

Shingles (Rwd. not available)—
 Red Cedar No. 1—\$6.75 per square; No. 2, \$5.75; No. 3, \$4.45.
 Average cost to lay shingles, \$3.00 per square.
 Cedar Shakes—Tapered: $\frac{1}{2}$ " to $\frac{3}{4}$ " x 25"—\$8.95 per square.
 Resawn: $\frac{3}{4}$ " to $1\frac{1}{4}$ " x 25"—\$10.65 per square.
 Resawn: $\frac{3}{4}$ " to $1\frac{1}{4}$ " x 25"—\$10.65 per square.
 Average cost to lay shakes, \$4.00 per square.

MILLWORK—Standard.

D. F. \$100 per 1000. R. W. Rustic \$100.00 per 1000 (delivered).
 Double hung box window frames, average with trim \$6.50 and up, each.
 Complete door unit, \$10.00.
 Screen doors, \$3.50 each.
 Patent screen windows, 25c a sq. ft.
 Cases for kitchen pantries seven ft. high, per lineal ft., \$9.00 each.
 Dining room cases, \$9.00 per lineal foot.
 Rough and finish about 80c per sq. ft.
 Labor—Rough carpentry, warehouse heavy framing (average), \$40.00 per M.
 For smaller work average, \$40.00 to \$55.00 per 1000.

MARBLE—(See Dealers)

PAINTING—

Two-coat workper yard 50c
 Three-coat workper yard 70c
 Cold water painting.....per yard 10c
 Whitewashingper yard 8c

PAINTS—

Two-coat work50c per sq. yd.
 Three-coat work70c per sq. yd.
 Cold water painting.....per yard 10c
 Whitewashing8c per sq. yd.
 Turpentine \$1.03 per gal. in drum lots.
 \$1.08 per gal. in 5-gal. containers.
 Raw Linseed Oil—not available.

Boiled Linseed Oil—\$1.38 per gal. in drums. Available only to work with high priority—\$1.48 per gal. in 5-gal. containers.

Use replacement oil—\$1.86 per gal. in 1-gal. containers.
 Replacement Oil—\$1.20 per gal. in drums, \$1.30 per gal. in 5-gal. containers.
 A deposit of \$6.00 required on all drums.

PATENT CHIMNEYS—

6-inch\$1.20 lineal foot
 8-inch1.40 lineal foot
 10-inch2.15 lineal foot
 12-inch2.75 lineal foot

PLASTER—

Neat wall, per ton delivered in S. F. in paper bags, \$17.60.

PLASTERING (Interior)—

	Yard
3 Coats, metal lath and plaster.....	\$2.25
Keene cement on metal lath.....	2.70
Ceilings with $\frac{3}{4}$ " hot roll channels metal lath (lathed only).....	1.80
Ceilings with $\frac{3}{4}$ " hot roll channels metal lath plastered.....	3.30
Single partition $\frac{3}{4}$ " channel lath 1 side (lath only).....	1.80
Single partition $\frac{3}{4}$ " channel lath 2 inches thick plastered.....	4.80
4-inch double partition $\frac{3}{4}$ " channel lath 2 sides (lath only).....	3.30
4-inch double partition $\frac{3}{4}$ " channel lath 2 sides plastered.....	5.75
Thermax single partition; 1" channels; $2\frac{1}{4}$ " overall partition width. Plastered both sides.....	4.95
Thermax double partition; 1" channels; $4\frac{3}{4}$ " overall partition width. Plastered both sides.....	6.60
3 coats over 1" Thermax nailed to one side wood studs or joists.....	2.45
3 coats over 1" Thermax suspended to one side wood studs with spring sound isolation clip.....	2.85

Note—Channel lath controlled by limitation orders.

PLASTERING (Exterior)—

	Yard
2 coats cement finish, brick or concrete wall.....	\$2.00
3 coats cement finish, No. 18 gauge wire mesh.....	3.00
Lime—\$4.00 per bbl. at yard. Processed Lime—\$4.15 per bbl. at yard. Rock or Grip Lath— $\frac{3}{8}$ "—30c per sq. yd. $\frac{1}{2}$ "—29c per sq. yd.	

Composition Stucco—\$2.70 to \$3.00 sq. yard (applied).

PLUMBING—

From \$100.00 per fixture up, according to grade, quantity and runs.

ROOFING—

"Standard" tar and gravel, 4 ply—\$8.00 per sq. for 30 sqs. or over.
 Less than 30 sqs. \$9.50 per sq.
 Tile, \$30.00 to \$40.00 per square.
 Redwood Shingles, \$7.50 per square in place.
 5/2 #1-16" Cedar Shingles, $4\frac{1}{2}$ " Exposure\$8.00 square

5/8 x 16"—#1 Cedar Shingles, 5" Exposure\$9.00 square
 4/2 #1-24" Royal Shingles, $7\frac{1}{2}$ " Exposure\$9.50 square
 Re-coat with Gravel \$4.00 per sq.
 Asbestos Shingles, \$23 to \$28 per sq. laid
 1/2 x 25" Resawn Cedar Shakes, 10" Exposure\$10.50
 3/4 x 25" Resawn Cedar Shakes, 10" Exposure11.50
 1 x 25" Resawn Cedar Shakes, 10" Exposure12.50
 Above prices are for shakes in place.

SHEET METAL—

Windows—Metal, \$1.75 a sq. ft.
 Fire doors (average), including hardware \$2.00 per sq. ft.

SKYLIGHTS—(not glazed)

Copper, 90c sq. ft. (flat).
 Galvanized iron, 40c sq. ft. (flat).
 Vented hip skylights 60c sq. ft.

STEEL—STRUCTURAL—

\$150 ton (erected), this quotation is an average for comparatively small quantities. Light truss work higher. Plain beams and column work in large quantities \$140 per ton.

STEEL REINFORCING—

\$100 to \$130 ton, set.

STONE—

Granite, average, \$6.50 cu. foot in place.
 Sandstone, average Blue, \$4.00. Boise, \$3.00 sq. ft. in place.
 Indiana Limestone, \$2.80 per sq. ft. in place.

STORE FRONTS (None available).

TILE—

Ceramic Tile Floors—\$1.00 to \$1.25 per sq. ft.
 Cove Base—\$1.10 per lin. ft.
 Glazed Tile Wainscot—\$1.25 per sq. ft.
 Asphalt Tile Floor $\frac{1}{8}$ " & $\frac{3}{8}$ "—\$.18 to \$.35 per sq. ft. Light shades slightly higher.
 Cork Tile—\$.40 to \$.75 per sq. ft.
 Mosaic Floors—see dealers.
 Lino-Tile, \$.35 to \$.75 per sq. ft.

Wall Tile—

Glazed Terra Cotta Wall Units (single face) laid in place—approximate prices:
 2 x 6 x 12.....\$1.10 sq. ft.
 4 x 6 x 12.....1.25 sq. ft.
 2 x 8 x 16.....1.20 sq. ft.
 4 x 8 x 16.....1.40 sq. ft.

VENETIAN BLINDS—

50c per square foot and up. Installation extra.

WINDOWS—STEEL—

30c per square foot, \$5 for ventilators.

ARCHITECT AND ENGINEER

IN THE NEWS

PERMANENTE DIVISION MANAGER

E. H. Kendall, Berkeley, California, has been appointed division manager for Permanente's new Seattle, Washington, plant, which was placed in operation on October 25th.

Kendall has been associated with the cement industry since 1933, when he was employed on the construction of the Golden Gate Bridge at San Francisco.

HIGH COSTS OF BUILDING

A full 90 per cent of the increased cost of building is attributable to labor and the government, James R. Edmunds, Jr., president of the American Institute of Architects, recently told members of the Producers' Council.

"Building costs have risen 50 to 60 per cent in many communities, as compared to prewar level,

and those costs must come down," Edmonds said.

Higher taxes, and unsuccessful attempts to control the "Economy" by the government has reduced materials production and encouraged work stoppages, and thus increased building costs, Edmonds charges.

NAMED SAN FRANCISCO HOUSING AUTHORITY GENERAL MANAGER

Arthur G. Long, who has been serving as assistant executive director, has been named to the newly established position of General Manager of the San Francisco Housing Authority.

The position has been created to better align responsibilities and activities of the several divisions within the organization.

OPENS NEW OFFICE

W. Sidney Orme, Architect, has opened new offices in Burbank, California, for the general practice of architecture, consulting, and engineering calculations.

BUILDING TRADES WAGE (JOB SITES) NORTHERN AND CENTRAL CALIFORNIA

ATTENTION: The following are the PREVAILING hourly rates of compensation as determined by the Wage Adjustment Board, or which have been determined by the United States Department of Labor—Revised to July 1, 1946. Wage scales shown are those being paid and in effect mostly by agreement between employees and their union.

CRAFT	San Francisco	Alameda and Contra Costa	Marin	Vallejo	San Mateo	San Jose	Stockton	Sacramento	Fresno
ASBESTOS WORKERS	1.75	1.75	1.75	1.75	1.75	1.75	1.75	1.75	1.75
BRICKLAYERS	2.05	2.05	2.05	2.05	2.05	2.05	1.75	2.05	2.00
BRICKLAYERS, HODCARRIERS	1.57½	1.57½	1.57½	1.57½	1.57½	1.57½	1.47½	1.15	1.25
CARPENTERS	1.75	1.75	1.75	1.75	1.75	1.62½	1.50	1.50	1.50
CEMENT FINISHERS	1.75	1.75	1.75	1.75	1.75	1.75	1.75	1.75	1.75
ELECTRICIANS	1.87½	1.87½	1.87½	1.70	1.87½	1.87½	1.75	1.82½	1.75
ENGINEERS: MATERIAL HOIST	1.60	1.60	1.60	1.60	1.60	1.60	1.60	1.60	1.60
PILE DRIVER	2.00	2.00	2.00	2.00	2.00	2.00	2.00	2.00	2.00
STRUCTURAL STEEL	2.00	2.00	2.00	2.00	2.00	2.00	2.00	2.00	2.00
GLASS WORKERS	1.58½	1.58½	1.58½	1.58½	1.58½	1.21	1.40	1.37½	1.37½
IRONWORKERS: ORNAMENTAL	1.85	1.85	1.85	1.85	1.85	1.85	1.85	1.85	1.85
REINF. RODMEN	1.75	1.75	1.75	1.75	1.75	1.75	1.75	1.75	1.75
STRUCTURAL	2.00	2.00	2.00	2.00	2.00	2.00	2.00	2.00	2.00
LABORERS: BUILDING & CONCRETE	1.25	1.25	1.15	1.15	1.15	1.15	1.25	1.25	1.15
LATHERS	1.90	1.90	1.60	1.87½	1.75	2.00	1.87½	1.60	1.87½
MARBLE SETTERS	1.75	1.75	1.75	1.75	1.75	1.75	1.75	1.75	1.75
MOSAIC & TERRAZZO	1.75	1.75	1.75	1.75	1.75	1.75	1.60	1.16	1.12½
PAINTERS	1.75	1.75	1.75	1.64	1.75	1.75	1.60	1.60	1.85
PILEDRIVERS	1.86	1.86	1.86	1.86	1.86	1.86	1.86	1.86	1.86
PLASTERERS	2.00	2.00	1.75	2.00	2.05	2.00	2.00	1.87½	1.87½
PLASTERERS' HODCARRIERS	1.75	1.75	1.75	1.75	1.75	1.75	1.65	1.65	1.40
PLUMBERS	1.87½	1.87½	1.87½	1.87½	1.87½	1.87½	1.87½	1.87½	1.87½
ROOFERS	1.50	1.62½	1.50	1.62½	1.25	1.37½	1.50	1.50	1.50
SHEET METAL WORKERS	1.75	1.75	1.75	1.75	1.75	1.75	1.75	1.75	1.75
SPRINKLER FITTERS	1.58	1.58	1.58	1.58	1.58	1.58	1.58	1.58	1.58
STEAMFITTERS	1.87½	1.87½	1.87½	1.87½	1.87½	1.87½	1.87½	1.87½	1.87½
STONESETTERS (MASON)	2.05	2.05	2.05	2.05	2.05	1.75	1.75	2.05	2.00
TILESETTERS	1.80	1.75	1.75	1.75	1.75	1.75	1.37½	1.37½	1.37½

Prepared and compiled by

CENTRAL CALIFORNIA CHAPTER, ASSOCIATED GENERAL CONTRACTORS OF AMERICA

with the assistance and cooperation of secretaries of General Contractors Associations and Builders Exchanges of Northern California.

CLASSIFIED ADVERTISING

RATE: 10c PER WORD . . . CASH WITH ORDER

MINIMUM \$2.50

ARCHITECT'S REPORTS—A valuable advance news service giving building and construction information daily on projects in Northern California. Name, location, architect, proposed cost, etc., on individual slips. Ideal for securing new business leads. Hundreds of items, total monthly cost only \$10. Don't delay, subscribe today. **ARCHITECT & ENGINEER**, Room 618, 68 Post Street,

San Francisco, California. Phone DOuglas 8311.

PHOTOGRAPHY—Keep a pictorial record of your building, or construction project. Pictures are of tremendous value to contractors, builders, engineers, architects. For Industrial-Publicity-Aerial photography, see **FRED MAE**, Room 721-22 Hearst Bldg., San Francisco 3, California.

ENGRAVING—Good engravings are essential to a satisfactory job of printing reproduction. For the best, see **Poor Richard Photo Engraving Co.**, 324 Commercial St., San Francisco.

PRINTING—Printers, bookbinders. See us for commercial printing. **Mercury Press**, 942 Howard Street, San Francisco.



**CLINTON
CONSTRUCTION CO.**
OF CALIFORNIA

General Contractors

923 FOLSOM STREET • SAN FRANCISCO
SUtter 3440

HOGAN LUMBER CO.
Wholesale and Retail
LUMBER

MILL WORK • SASH & DOORS

Office, Mill, Yard and Docks
SECOND AND ALICE STREETS • OAKLAND, CALIF.
Telephone GLencourt 6861

SANTA MARIA INN
SANTA MARIA, CALIFORNIA

FRANK J. McCOY, General Manager
FERNAND E. PIMENTEL, Manager

On the
Coast
Highway
between
San
Francisco
and
Los
Angeles



American
or
European
Plan
•
Old
English
Tap
Room

**SILVER ANNIVERSARY BANQUET OF
THE PRODUCERS' COUNCIL RECENTLY
HELD IN NEW YORK CITY**

Commemorating the Silver Anniversary, 1921-1946, of the Producers' Council, the Fall meeting recently brought together leading manufacturers of building materials and equipment from all parts of the nation.

James R. Edmunds, Jr., national A.I.A. President; L. C. Hart, outgoing Producers' Council President, and Douglas Whitlock, Advisory Board Chairman; and others are seated at the table at left.

**FOLD-UP DINETTE SET
FOR G-I HOMES**

Combining utility with space saving, this set serves as a double duty unit for the compact G. I. home or kitchenette apartment.



As a kitchen table it provides a sturdy well proportioned 25 inch by 40 inch white porcelain top; converted into a dinette set, two upholstered benches are swung out offering comfortable seating for four people. Two additional people may be accommodated at the table ends.

A built-in dual electrical outlet serves several table appliances with but one cord to the wall.

BOOK REVIEWS

PUBLIC HOUSING DESIGN: Federal Public Housing Authority, Government Printing Office, Washington, D. C. Price \$1.25 each.

A decade's experience in the design and construction of low-rent housing development is contained in this 300-page book. It covers the entire scope of community development from preliminary surveys through planning and actual construction to final landscaping.

DIESEL ENGINE COOLING SYSTEMS. Binks Manufacturing Co., 3114 Carroll Avenue, Chicago 12, Ill.

A 20-page reference booklet on diesel engine efficiency and lower operating costs; profusely illustrated with diagrams, blueprints, and pictures, showing water jacket scale, overheating, and data on breakdowns and insurance rates. Copy free.

THE ACTION OF EMBECO IN CONCRETE AND MORTARS. The Master Builders Co., 7016 Euclid Avenue, Cleveland 3, Ohio.

A 34-page booklet discussion of shrinkage of concrete and mortar; its important influence on durability and serviceability, and the principal factors affecting its control and elimination.

Includes Embeco use for machinery and heavy equipment grouting, cement gun work, and patching and repairing concrete. Graphs, charts, technical data, included. Copy free.

METAL LATH SPECIFICATIONS—for Better Plastering and Concrete Stucco. Metal Lath Manufacturers Association, Engineers Building, Cleveland, Ohio.

Revised for 1946 giving latest recommendations on usages and applications. Contains 21 specifications including Simplified Practice Recommendation R3-44, Metal Lath and Metal Plastering accessories.

A.I.A. File No. 20-B-1.

G-E LAMP BULLETIN LD-1 — Incandescent, Mercury, Fluorescent. General Electric Lamp Department, Nela Park, Cleveland, Ohio. Cost 40c.

New 76-page technical treatise by C. E. Weitz. Contains data gathered from bulletins and articles issued by Company on latest lamp developments and their practical application to a host of fields in commerce, industry, and home. Illustrated, photos, diagrams and charts.

VERMONT MARBLE COMPANY

Producers and Finishers
of
Domestic and Imported Marbles

Write for new pamphlet describing our
Marble Toilets and Showers

San Francisco and Los Angeles
San Francisco phone: SUTTER 6747



The Most Complete Line of
STEELS and BUILDING MATERIALS
Made by a Single Producer



See Sweet's Catalog File or write us for
full information.

REPUBLIC STEEL CORPORATION
GENERAL OFFICES: CLEVELAND, OHIO

DENVER, COLORADO CONTINENTAL OIL BUILDING
LOS ANGELES, CALIFORNIA EDISON BUILDING
SALT LAKE CITY, UTAH WALKER BANK BUILDING
SAN FRANCISCO, CALIFORNIA RIALTO BUILDING
SEATTLE, WASH. WHITE-HENRY-STUART BUILDING

PACIFIC MANUFACTURING CO.

HIGH CLASS INTERIOR FINISH
QUALITY MILLWORK

142 SANSOME ST., SAN FRANCISCO
GARfield 7755

6820 MCKINLEY AVE., LOS ANGELES
THornwall 4196

BUILDERS EXCHANGE, OAKLAND

"AMERICAN - MARSH" CONDENSATION UNIT

Pumping
Machinery
for
Every
Purpose

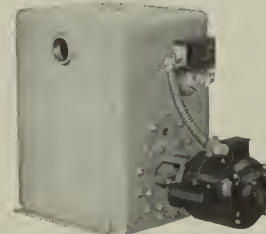

For Service
Call
DOuglas
6794
or
MUtual 8322

SIMONDS MACHINERY CO.
SAN FRANCISCO 816 FOLSOM
LOS ANGELES 455 EAST 4TH

**Everything in Painting
and Decorating**

YEARS OF FRIENDLY SERVICE
DISTINGUISHED FOR DURABLE and
ECONOMICAL CRAFTSMANSHIP

No Job
to
Large



No Job
to
Small

A recent example of our work:
BERKELEY GENERAL HOSPITAL
(Pictured in this issue)

**Pacific
Painting & Decorating**

BILL BLUMERT

Since 1908

5414 Telegraph Ave., Oakland
Phone: OL. 0978

Venetian Blinds

of

Metal or Wood

for

Homes and Offices

Installed and Serviced

by

GUNN CARLE & CO.

20 POTRERO AVENUE
SAN FRANCISCO 3
UNderhill 5480

IN THE NEWS

JAMES A. GILLEM, Architect, announces his new mailing address as 724 36th Street, Sacramento, California.

NEW DRAFTING PENCIL

A new, aluminum drafting pencil known as the **ELASTICHUCK** has been placed on the market by the **ELASTICHUCK SALES COMPANY**, Inglewood, California.



Features include a rubber collet in neck of chuck which grips lead and "cushions" against undue pressure. The hardened steel chuck cannot be damaged when sharpening leads against file or sandpaper. Uses all standard drawing leads.

PRE-FABRICATED

Volume production of pre-fabricated homes of aluminum and plastics for temperate climates is announced by the Consolidated Aircraft Corporation of San Diego.

The company is planning to enter the building field with volume produced houses which will cost about \$7,000 to \$8,000 exclusive of the lot.

LATEST IN BED LAMPS

A bed-wide fluorescent tube built into the headboard is being planned as the latest in bed reading lamps.

Nine hundred radio broadcasting stations in the United States daily serve more than 50 million receiving sets.

**MASONRY WORK
& GLASS BLOCKS**

BERKELEY GENERAL HOSPITAL

— by —

HAROLD B. PETERSEN

1237 St. Charles Street

ALAMEDA

Phone: LA 2-0964

P L U M B I N G

installed in

Berkeley General Hospital

by

F. W. SPENCER & SON

149 Gough Street, San Francisco

Phone HEmlock 3340

ELMER F. STEIGELMAN

CIVIL ENGINEER

**Structural Design,
Surveying and
Subdivisions**

577 FOURTEENTH STREET

OAKLAND, CALIFORNIA

TWinoaks: 4191

KYLE FORREST

Civil Engineer

Water Supply — Sanitation

Municipal — Private
Consultations — Investigations
Reports — Designs — Valuations
Supervision — Litigation

Ground Water Work a Specialty

Hydrologic studies — wells, de-
watering, underdrainage, founda-
tions, conservation, testimony.

1504 Russ Building

San Francisco 4

YUkon 0652

Basalt Rock Co., Inc.

Ready Mixed Concrete

Building Materials

Basalite Products

SIXTH & BERRY STREETS

SAN FRANCISCO

PHONE: GARFIELD 3758

MULLEN MFG. COMPANY

BANK, STORE AND OFFICE
FIXTURES—CABINET WORK
OF GUARANTEED QUALITY
CHURCH SEATING

Office and Factory:

60-80 RAUSCH ST., Bet. 7th and 8th Sts.
San Francisco
Telephone UNderhill 5815

THE TORMEY COMPANY

GENERAL PAINTERS
AND DECORATORS

Phone UNderhill 1913

563 FULTON STREET
San Francisco

G. P. W. JENSEN & SON

Building Construction

320 Market Street, San Francisco
Phone: GARfield 2444

STATEMENT OF THE OWNERSHIP, MAN- AGEMENT, CIRCULATION, ETC., RE- QUIRED BY THE ACT OF CONGRESS OF AUGUST 24, 1912 AND MARCH 3, 1933.

Of the Architect and Engineer, published
monthly at San Francisco, Calif., for October
1, 1946.

State of California)
City and County of San Francisco } SS.

Before me, a notary public in and for the
state and county aforesaid, personally ap-
peared L. B. Penhorwood, who, having been
duly sworn according to law, deposes and says
that she is the Business Manager of The Archi-
tect and Engineer, and that the following is
to the best of her knowledge and belief, a true
statement of the ownership, management (if
daily paper, the circulation), etc., of the afore-
said publication for the date shown in the
above caption, required by the Act of August
24, 1912, as amended by the Act of March 3,
1933, embodied in section 537, Postal Laws and
Regulations, printed on the reverse of this
form, to wit:

1. That the names and addresses of the pub-
lisher, editor, managing editor, and business
managers are:

Publisher, The Architect and Engineer, Inc.,
68 Post St., San Francisco, Calif.

Editor: Edwin H. Wilder, 68 Post St., San
Francisco, Calif.

Managing Editor—None.

Business Manager, L. B. Penhorwood, 68
Post St., San Francisco, Calif.

2. That the owner is: (If owned by a cor-
poration, its name and address must be stated
and also immediately thereunder the names
and addresses of stockholders owning or
holding one per cent or more of total amount
of stock. If not owned by a corporation, the
names and addresses of the individual owners
must be given. If owned by a firm, com-
pany, or other unincorporated concern, its
name and address, as well as those of each
individual member, must be given.)

The Architect and Engineer, Inc., 68 Post
St., San Francisco, Calif.

K. P. Kierulff, 68 Post St., San Francisco,
Calif.

E. N. Kierulff, 68 Post St., San Francisco,
Calif.

L. B. Penhorwood, 68 Post St., San Fran-
cisco, Calif.

F. W. Jones, 1153 McKinley Ave., Oakland,
Calif.

V. S. Yallop, 68 Post St., San Francisco,
Calif.

E. J. Cardinal, 942 Howard St., San Fran-
cisco, Calif.

Sewall Smith, Lafayette, Calif.

3. That the known bondholders, mortgagees,
and other security holders owning or holding
one per cent or more of total amount of bonds,
mortgages, or other securities are: (If there
are none, so state.)
None.

4. That the two paragraphs next above, giv-
ing the names of the owners, stockholders, and
security holders, if any, contain not only the
list of stockholders and security holders as they
appear upon the books of the company but
also, in cases where the stockholder or security
holder appears upon the books of the company
as trustee or in any other fiduciary relation,
the name of the person or corporation, for
whom such trustee is acting, is given; and
that the said two paragraphs contain state-
ments embracing affiant's full knowledge and
belief as to the circumstances and conditions
under which stockholders and security holders
who do not appear upon the books of the com-
pany as trustees, hold stock and securities in a
capacity other than of a bona fide owner; and
this affiant has no reason to believe that any
other person, association, or corporation has
any interest direct or indirect in the said stock,
bonds, or other securities than as so stated by
him.

5. That the average number of copies of each
issue of this publication sold or distributed,
through the mails or otherwise, to paid sub-
scribers during the twelve months preceding
the date shown above is: (This information is
required from daily publications only.)

L. B. Penhorwood, Business Mgr.

Sworn to and subscribed before me this 26th
day of September, 1946.

(Seal) CHAS. F. DUSENBERG
Notary Public in and for the City and County
of San Francisco, Calif.

(My commission expires May 23, 1949.)

Scott Company

HEATING - - PLUMBING - - TILE

★

243 MINNA STREET

SAN FRANCISCO

Phone EXbrook 6741

DINWIDDIE CONSTRUCTION COMPANY

BUILDERS

CROCKER BUILDING
SAN FRANCISCO



HERRICK IRON WORKS

STRUCTURAL STEEL
REINFORCING STEEL

18TH AND CAMPBELL STS.
OAKLAND, CALIF.
Phone GLencourt 1767

Phone GARfield 1164

Thomas B. Hunter

Consulting Engineer

DESIGNER OF HEATING
AIR CONDITIONING
VENTILATING AND WIRING
SYSTEMS, MECHANICAL
AND ELECTRICAL EQUIP-
MENT OF BUILDINGS

41 SUTTER STREET
ROOM 710

San Francisco

California

George F. Brayer

ELECTRICAL
CONTRACTOR

166 Seventh Street
San Francisco

Phone: Market 1761

PITTSBURGH TESTING LABORATORY

Successors to
SMITH, EMERY & COMPANY

*Testing and Inspecting
Engineers and Chemists*

Structural Materials, Structures
Equipment, Pipe, Soils.

651 Howard St., San Francisco 5
EXbrook 1747

A. F. MATTOCK CO.

Builders

★

212 CLARA STREET
SAN FRANCISCO

INDEPENDENT IRON WORKS

Steel Buildings
Service Stations
Steel Storage Tanks
Fabricated Plate Work
Steel & Sheet Metal Products
Fabricated Structural Steel
Steel Distributors

Eighth & Pine Sts. Oakland, 7

Index to Advertisers

ALADDIN Heating Corp.....	48
ARCHITECTS Reports	40
ASCHEN, W. A.	30
BASALT Rock Company, Napa.....	39
BASALT Rock Company, San Francisco	47
BAXTER & Company, J. H.	34
BRAYER, Geo. F.	48
CLASSIFIED Advertising	43
CLINTON Construction Company.....	44
COLUMBIA Steel Co.	*
DINWIDDIE Construction Company..	47
FORDERER Cornice Works.....	39
FORREST, Kyle	46
FOX TILE Co.	30
FULLER, W. P. Co.	*
GUNN, Carle & Company.....	46
HANKS, Inc., Abbot A.	48
HAWS Drinking Faucet Company.....	6
HERRICK Iron Works.....	47
HOGAN Lumber Company.....	44
HUNT, Robert W., Company.....	48
HUNTER, Thos. B.	47
IMPERIAL Brass Manufacturing Co.....	*
INDEPENDENT Iron Works.....	48
JENSEN & Son, G. P. W.	47
JOHNSON Company, S. T.	*
JUDSON, Pacific-Murphy Corp.	39
KAWNEER Company	*
KRAFTILE Company	32
LAMSON Corporation	Back Cover
LYNN, Willis F.	29
MAKIN, William	29
MATSON Electrical Equipment Co....	36
MATTOCK, A. F.	48
MULLEN Mfg. Co.	47
MUELLER Brass Co.	2
NORTHERN California Electrical Bureau	35
PACIFIC Coast Gas Association.....	5
PACIFIC Manufacturing Company.....	45
PACIFIC Portland Cement Company..	1
PACIFIC Paint & Decorating Co.	46
PACIFIC Telephone & Telegraph Co. 33	
PARAMOUNT Built-in Fixture Co.	*
PAYNE Furnace & Supply Co., Inc.	*
PETERSEN, Harold F.	46
PITTSBURGH Testing Laboratory.....	48
PORTLAND Cement Association.....	*
REMILLARD-Dandini Co.	48
REPUBLIC Steel Corporation.....	45
SANTA Maria Inn.	44
SCOTT Co.	47
SIMONDS Machinery Company.....	45
SISALKRAFT Company	39
SMOOTH-Holman Co.	37
SPENCER, F. W. & Son.	40
STANLEY Works, The	40
STEIGELMAN, Elmer F.	46
STEELFORM Contracting Co.	34
TAYLOR Co., Halsey W.	*
TIMBER Engineering Co., Inc.	*
TORMEY Company, The.....	47
UTILITY Appliance Corp.....	*
U. S. STEEL	*
U. S. BONDS.	Inside Back Cover
VERMONT Marble Company.....	45
WESTERN Asbestos Company	Inside Front Cover
WOOD, E. K., Lumber Company.....	36

* Indicates Alternate Months

A L A D D I N

Heating Corp.

Specializing in
QUALITY HEATING
EQUIPMENT

2222 San Pablo Avenue

OAKLAND

TWinoaks 1022

ABBOT A. HANKS, INC. Engineers & Chemists

INSPECTING — TESTING — CONSULTING
CONCRETE • STEEL • MATERIALS
CHEMICAL AND TESTING
LABORATORIES
• RESEARCH AND INVESTIGATION •

TESTS OF STRUCTURAL MATERIALS
DESIGN OF CONCRETE MIXES
SHOP AND ERECTION INSPECTION OF
STRUCTURES AND EQUIPMENT
INVESTIGATION OF STRUCTURES
AND MATERIALS
TESTS AND INVESTIGATION OF
FOUNDATION SOILS
FIRE RESISTANCE AND INSULATION
TESTS

624 Sacramento Street, San Francisco

Robert W. Hunt Company ENGINEERS

Inspection • Tests • Consultation

Schools and Other Structures
Are Built as Designed

*When Construction Materials are
Inspected at point of Manufacture
and during Erection by*

ROBERT W. HUNT COMPANY

*Cement, Concrete, Chemical, Metallurgical,
X-Ray and Physical Laboratories*

Chicago • New York • Pittsburgh
Los Angeles • All Large Cities
San Francisco, 251 Kearny Street

REMILLARD-DANDINI Co.

Brick and
Masonry Products

★

633 BRYANT ST., SAN FRANCISCO

569 THIRD ST., OAKLAND

ARCHITECT AND ENGINEER



DECEMBER

1946

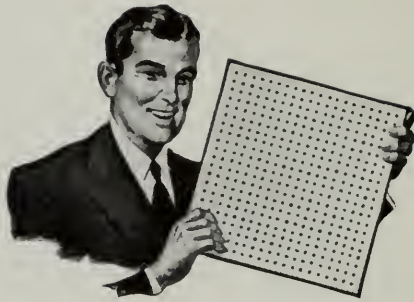

OVER 1000 YEARS of Combined Acoustical Experience

... At Your Service Through Western Asbestos Co.
Your Acousti-Celotex Distributor

MORE THAN 1000 years of combined experience, gained in over 100,000 installations—this is the great reservoir of practical knowledge available to you *only* through the Acousti-Celotex* Distributor Organization of which Western Asbestos Co. is your representative.

This knowledge has been gained in good company. For the nationwide Acousti-Celotex group has collaborated with hundreds of architects in effecting solutions to noise quieting problems.

Every day the men of this organization are helping to solve such problems as:

- How to diagnose acoustical and noise quieting difficulties . . .
- How to reduce distracting noise to a gentle hush . . .
- How to design architecturally for optimum acoustics . . .
- How to be sure of mechanical perfection in the proper acoustical material and its application . . .
- How to make sure of the acoustical installation's perfect appearance and continued satisfactory performance through the years.

Every man in this nationwide organization is hand picked. He is thoroughly trained in sound-conditioning practice. As a result, when you turn a job over to him, you know it will be trouble-free.

No matter how much or how little assistance you may need, Western Asbestos Co. is willing and able to help you without obligation. This extra service in no way affects their ability to compete on the smallest or the largest job you may have. That service is the unwritten *plus value* that goes with every specification for Acousti-Celotex.

A phone call or a note will bring a trained sound-conditioning expert to you from Western Asbestos Co.'s staff.

WESTERN ASBESTOS CO.

DISTRIBUTORS • ENGINEERS • CONTRACTORS

SAN FRANCISCO: 675 TOWNSEND STREET, HEMLOCK 4884

OAKLAND: LATHAM SQUARE BUILDING, TEMPLEBAR 7474

SACRAMENTO: 1224 EYE STREET, SACRAMENTO 2-8993

FRESNO: 1837 MERCED STREET, FRESNO 3-3277



Sound Conditioning with
ACOUSTI-CELOTEX

* Perforated Fibre Tile REG. U.S. PAT. OFF.
SINCE 1923

ARCHITECT

Vol. 167 No. 3

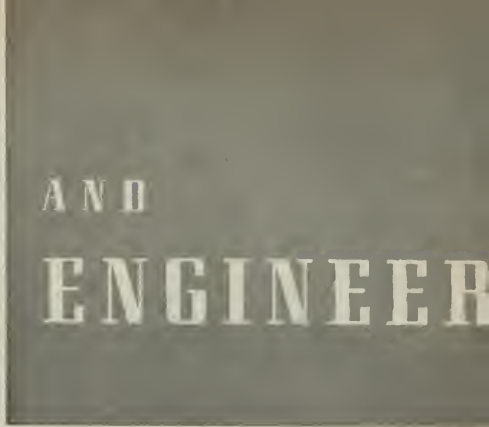

ARCHITECTS' REPORTS—Published Daily
Telephone DOuglas 8311

E. H. WILDER
Editor

MARK DANIELS, A.I.A.
Associate Editor

JOHN S. BOLLES, A.I.A.
Book Reviews

MICHAEL GOODMAN
Post-War Planning

L. H. NISHKIAN
Consulting Editor

E. N. KIERULFF*
Ass't Editor
*In the Service



Contents for

DECEMBER

COVER PICTURE: Season's Best Greetings to all.

ARTICLES AND MISCELLANEOUS TEXT

EDITORIAL NOTES	4
NEWS AND COMMENT ON ART	6
PROGRESS IN DESIGN, James F. Lincoln Arc Welding Foundation	8
SUPERSTITION AND COLOR IN INTERIOR DECORATING	9
By DR. W. SCHWEISHEIMER	
ALUMINUM HOUSE IS BUILT IN TWO HOURS	10
MODERN ARCHITECTURAL DESIGN FOR SACRAMENTO	12
The Joseph Magnin New Store; Gruen & Krummeck, Architects	
THE PENINSULA OF SAN FRANCISCO	14
By MARK DANIELS, A.I.A.	
HILLSBOROUGH, CALIFORNIA HOME	18
Mr. and Mrs. George E. Madding; Angus McSweeney, A.I.A., Architect	
ARCHITECT UNDERTAKES PLANNING PROGRAM FOR REBUILDING LONDON'S HOMES; J. H. Forshaw, Architect	22
By THOMAS HODGES	
RADAR IS NOT NEW	24
A.I.A. ACTIVITIES	29
WITH THE ENGINEERS	30
HEADLINE NEWS & VIEWS	34
By E. H. W.	
IN THE NEWS	35, 44, 45
PRODUCER'S COUNCIL PAGE	36
Edited by CHAS. W. KRAFT	
ESTIMATOR'S GUIDE, Building and Construction Materials	39
BUILDING TRADES WAGE SCALES, Northern and Central California	41
CLASSIFIED ADVERTISING	41
BOOK REVIEWS, Pamphlets and Catalogues	43
INDEX TO ADVERTISERS	46
PRINCIPAL ARTICLES AND ILLUSTRATIONS—1946: INDEX	47

ARCHITECT AND ENGINEER (Established 1905) is published on the 15th of the month by The Architect and Engineer, Inc., 68 Post St., San Francisco 4; Telephone EXbrook 7182. President, K. P. Kierulff; Vice-President and Manager, L. B. Penhorwood; Treasurer, E. N. Kierulff.
Los Angeles Office: Wentworth F. Green, 6605 Hollywood Blvd., Los Angeles 28, Telephone HEmpstead 3171.

Entered as second class matter, November 2, 1905, at the Post Office in San Francisco, California, under the Act of March 3, 1879. Subscriptions United States and Pan America, \$3.00 a year; \$5.00 two years; foreign countries \$5.00 a year; single copy 50c.



• EDITORIAL NOTES •

PROVED

Further evidence, and proof, that the West Coast is receiving national attention in the industrial field is the recent announcement that the Western Metal Congress and Exposition will be resumed early in 1947, and that the event will be held in Oakland, California.

Sponsors include the American Society for Metals which deals in technical matters of particular interest to metal trades, aviation, petroleum, chemical, mining, and general manufacturing industries.

* * *

THE FUNCTION OF THE ARCHITECT

Branson Van Leer Gamber, F.A.I.A., of Detroit, in writing for "ARCHITECTURE, A Profession and a Career," a book which has been published in the interests of the Architectural profession by The American Institute of Architects, Washington, D. C., points out that:

"The architect holds a position of trust and responsibility, not only to his client, but to those with whom he works, and to the community. He is, first of all, an artist, but he is also realistic and practical. While he cannot know all the details of the many professions and types of business with which he comes in contact, he must be generally acquainted with their methods and activities.

"He must be familiar with many phases of engineering, and should have a thorough knowledge of construction and of the use and adaptability of building materials and equipment. His broad training qualifies him to work intelligently and in harmony with landscape architects, interior decorators, craftsmen, and engineering and equipment specialists.

"The architect will endeavor to learn all he can about his client, so that he may understand and more readily solve his problems. A thorough knowledge of facts and figures, of the client's preferences and prejudices, and of other relevant factors are required for thorough and mutual understanding between the architect and his client.

"The architect should first visit the property. If none has been acquired, he will provide valuable assistance in selecting the proper site.

"During the preliminary study and preparation of sketches, frequent conferences are desirable. . . . After approval of preliminary sketches and estimates, working drawings and specifications are prepared. . . . Building codes must be considered, and also other ordinances and regulations. . . . As the owner's agent he examines and compares the bids. . . . He advises and assists the owner in

awarding contracts, and prepares the contract documents.

"As construction proceeds the architect's duties are numerous. He carefully supervises the work, both in the field and in his office. . . . Accurate progress records are kept . . . the architect approves materials, selects colors, inspects and approves equipment, selects hardware, lighting fixtures and many other items.

"He must check carefully to determine that all items of work have been satisfactorily completed, that all conditions and requirements of the contract have been fulfilled, and that all required certificates and guarantees are delivered to the owner.

"The architect's services, as outlined above, should result in a satisfied client, who possesses a building of which he is proud and which is an asset to the community."

* * *

EDUCATION NEEDED

Why it is that in our Nation, endowed with so much general and scientific knowledge about so many subjects, there is a woeful lack of understanding by many educators, economists, and the public at large of the "profit" factor in today's commercial and industrial enterprise?

"Wall Street," "Big Business," "Corporations," and "Profits" are synonymous in the minds of many people, and frequently we hear it said that were it not for the tremendous "profits" of industry the American way of life would more nearly approach the utopian, Russian, or Communistic level of perfection.

The facts are that Soviet Russia, for example, runs her socialistic economy on the highest profit margin of any industrial country in the world.

"The profit in the Russian automobile industry," declares Peter F. Drucker, Professor of Economics, Bennington College, "is three times as high as it is in Detroit."

While a recent poll taken by a prominent research foundation indicates that most Americans believe "profit" takes as much as 25 per cent of the price paid for a service or product, the average heavy industry "profit" from sale of goods and service is between 3 and 4 per cent. Wages average about 40 per cent, or ten times that of "profit."

With pending "wage adjustments" and State and National legislation facing American industry, it should be remembered that at present there are no high margins of profit, and any appreciable increase in wages or costs of doing business will automatically result in increased consumer costs.



UNCLE



AUNT



GRANDMA



GRANDPA



FATHER



MOTHER



BROTHER



SISTER



NEPHEW



NIECE



SON



DAUGHTER

What one gift would please them all?

No matter what their tastes . . . their hobbies . . . their likes or dislikes . . . there's *one* gift that will please them, each and every one. That gift is a United States Savings Bond.

This Christmas, put at least one Savings Bond under the tree for someone you love.

Contributed by this magazine in co-operation with the Magazine Publishers of America as a public service.



NEWS AND COMMENT ON ART

STILL LIFE

Oil

by AMEDEE OZENFANT

To be seen at the San Francisco Museum of Art during the month of December. It is representative of one of many trends in contemporary art advocated by Ozenfant emphasizing picture surface.



BALINESE GIRL

Drawing

by MAURICE STERNE

One of the Albert M. Bender Collection being featured by the San Francisco Museum of Art during December.

It is a charcoal drawing on paper, signed and dated 1914 and is one of five drawings of that period by Sterne, a style which established his reputation when shown in Europe.

Maurice Sterne was in San Francisco during 1936 and 1937.

... NEWS AND COMMENT ON ART

SAN FRANCISCO MUSEUM OF ART

The December calendar of activities will include:

EXHIBITIONS: Selections from the Albert M. Bender Collection of oils, watercolors, sculpture, and graphic arts. CHILDREN'S ART from Australia, and BAY AREA ART for Museum members in the Rental Gallery.

ACTIVITIES: The KNOW YOUR WORLD SERIES will continue through December, however, other regularly scheduled events will not be conducted during the Holiday Season, but will be resumed the first of the year.

CALIFORNIA SCHOOL OF FINE ARTS

Enrollments in the Spring Term which opens on January 6, 1947, are now being taken.

Because of the popularity of both day and evening classes, applications for enrollment should be made at once.

* * *

A San Francisco branch of the Midtown Galleries of New York has been opened in San Francisco under the direction of Jack Kleiser and Nancy Porter. Original paintings, drawings and sculpture by contemporary American artists, as well as prints of modern paintings, are on display at the gallery, located at 609 Sutter Street.

* * *

Miss Pele de Lappe has been appointed director of the Gregor Duncan Art Gallery at the California Labor School, San Francisco.

* * *

Charles Howard, active artist member now in England, had a large retrospective showing of his work recently at the Nierendorf Galleries in New York City.

ROTUNDA GALLERY—CITY OF PARIS

Exhibitions scheduled during December in the Rotunda Gallery include Paintings and Sculpture by Caroline Martin, Raymond Puccinelli and Zou-rab Tchkotoua.

Provocative presents products by California artists are displayed in the Art In Action Shop. These include Handwrought Jewelry, Handwoven and Screen-printed textiles and original signed Ceramics.

ADVERTISING ART EXHIBIT

The second annual exhibition of Pacific Coast Advertising Art has been scheduled for February 10 to 21, 1947, in the Barker Brothers Auditorium in Los Angeles.

Sponsored by the Art Directors Club of Los Angeles, entry blanks may be secured from Wil-

liam Black, exhibition secretary, 1027 Wilshire Blvd., Los Angeles.

M. H. DE YOUNG MEMORIAL MUSEUM

Exhibitions and events scheduled during the month of December will include the following:

EXHIBITIONS: U. S. A. Houses, 1607-1946; Group showing of PAINTINGS by Milton Avery, Marsden Hartley, Karl Knaths, Abraham Rattner and Max Weber; CHINESE LOWESTOFT PORCELAIN, lent by the Metropolitan Museum of Art; and CERAMICS by the Association of San Francisco Potters.

EVENTS: Class in Drawing for young people, 10 to 15 years of age, each Saturday afternoon; Children's Class, age 5 to 10 years, each Saturday morning. Both classes will observe a Holiday Recess, December 21 to 28.

PORTLAND ART MUSEUM

For the first time in nearly ten years, a selection of Japanese color prints from the Mary Andrews Ladd collection has been placed on display. The exhibition concentrates on 18th Century artists, including Moronobu, Shunsho, Utamaro and Sharaku.

CALIFORNIA PALACE OF THE LEGION OF HONOR

Thomas Carr Howe, Jr., Director, has announced the following schedule of exhibitions and special events for December:

EXHIBITIONS: Vanguard Prints; Original Miniature Paintings Illustrating the Canterbury Tales, by Arthur Szyk; Education in Great Britain; Arthur Sachs collection of Old and Modern Masters, Tapestries and the Decorative Arts; Painting and Sculpture sponsored by the Society for Sanity in Art; the Alma de Bretteville Spreckels collection of Sculpture by Auguste Rodin; the Mildred Anna Williams collection of Paintings, Sculpture, Tapestries and Furniture; and the Collis Potter Huntington Memorial Collection of 18th Century French Paintings, Sculpture, Tapestries, Furniture and Porcelain.

EDUCATIONAL ACTIVITIES include Children's Classes, age 4-12, each Saturday morning at 10:30, under direction of Katharine Parker and Lilly Weil Jaffe.

The Painting Class for Adults each Saturday afternoon at 2:30, under direction of Rex Mason.

Organ Recital by Uda Waldrop, each Saturday and Sunday at 3 p. m.; and free Motion Pictures each Saturday afternoon at 2:30.

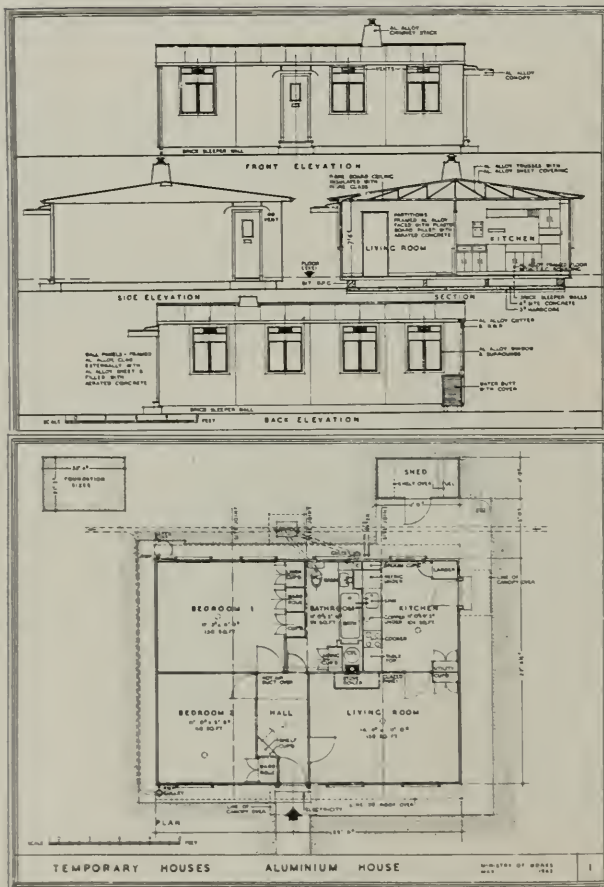

Aluminium Built In

TOP LEFT shows the completed home ready for occupancy. Constructed of surplus aircraft aluminium, it is known in England as the "AIROHS" temporary housing program.

ELEVATION and FLOOR PLAN of the house. Designed for replacement with the traditional English brick house within 10 years, it will serve 30 years with reasonable maintenance.

More than 4,500,000 homes in England were destroyed or damaged during the War.



House Is Two Hours

UPPER RIGHT shows sections of the home being lowered onto brick foundation. The houses leave the factory in four sections with electric wiring and plumbing in place ready for connecting.

BUILT-IN wardrobes, cupboards, fixtures; two-fuel constant hot-water system heats the living room, large and small bedrooms and kitchen.

The completed house costs approximately \$5,400.

(British Information Service Photos)





GRUEN & KRUMMECK, Architects

Modern Architectural Design For Sacramento

The Joseph Magnin New Store

The Joseph Magnin Store, the store Sacramento women wanted and 50,000 Sacramento women helped build, located at 10th and K Streets, Sacramento, California, was officially opened recently.

It occupies a frontage of 100 feet by 100 feet and was constructed at an approximate cost of \$400,000.

Two and a half stories in height the store has a total selling space of 30,000 square feet. It is entirely windowless above the first floor; indirect lighting being used to simulate daylight.

The street floor is flanked on two sides by display windows running the width and length of the store, invisibly braced to present an unbroken exterior, while recesses under the upper stories form an air-conditioned arcade.

A sports shop will occupy a glassed-in section of the roof.

One of the first considerations in planning the store was to make window shopping as agreeable

and comfortable as possible, therefore Gruen and Krummeck, architects and designers, drew their plans to create a shaded area setting the windows back behind a row of columns, thus making it possible for people to look at the merchandise displayed in the shade.

Another feature are aluminum venetian blinds which extend around the arcade and raise and lower automatically with the sun. The arcade extends eight feet deep to a solid sheet of glass the full height of the arcade itself.

Two entrance doors are of glass, giving the feeling of a solid glass front.

The lower part of the building is in a fine maroon-colored Tennessee marble. The upper part is cement with vertical strips of stainless steel. The building is rounded at the top rather than squared off, giving the impression that the stainless steel strips continue on over.

The store has two floors and a mezzanine. The first floor is seventeen feet high and is a rounded



INTERIOR—

Main floor, showing unique use of center counters, which seem to "grow from the floor."

The two main counters on the first floor are particularly distinguished in their construction. They have been effectively designed to give the appearance of growing out of the floor and continuing vertically to form the counters. Both of these are done in bronze.

The second floor opens onto a spacious foyer which is a free-form shape. The walls are done in green and black stripes with a black carpet. Fixtures are green enamel, and all the lighting is recessed.

The air-conditioning units are the results of the very latest developments in air-conditioning. This is an important feature because of the summers in Sacramento, and the customer may attribute the freshness of the air to the fact that it is being continually washed and purified.

The designers, Gruen and Krummeck, have planned and executed work from coast to coast, and are well known for their treatment of materials and colors.

oblong shaped room. In the center of the room is suspended a massive lighting cove supported by two pillars. This lighting cove contains fluorescent, cold-cathode and incandescent lighting.

The floor is pink terrazzo and the walls are covered with light brown walnut flexwood. The fixtures are in Honduras mahogany, bleached a light grey.

The architects have tried to create a style which is contemporary, without using the so-called principle of modernistic design.

RECESSED LIGHTING, on upper floor





San Mateo, California

English Style HIGH SCHOOL

The Peninsula of San Francisco

By MARK DANIELS, A.I.A.

Few cities have the possibility for future growth and development so clearly defined as has San Francisco. The great New York City with her development predicted as north along the Hudson River still was able to expand in other directions due to the narrowness of waterways that otherwise might have forced her growth more rapidly to the north.

Not so with San Francisco. Developments to the north and east have taken place, but they were originally started as independent settlements and not as a result of San Francisco's expansion. At last the city has reached the point where it must expand without interruption, which means by land, if possible. Hemmed in as it is on the north, east and west by salt water, only an insurmountable

obstacle can stop her growth to the south, in which path is only the range of the Guadalupe Hills (called mountains by some) which are now bypassed by boulevards and railways and yet may be tunneled.

Until recently this stretch of thirty-odd miles south of the city has been allowed to develop its own way except in isolated spots and communities. Finally, some far-seeing lovers of San Francisco realized that developing a home on one of San Francisco's twenty-five foot lots was all but impossible and they moved to one of the good and unspoiled locations to the south which soon became known as the "Peninsula." Hillsborough, Burlingame and San Mateo, along with three or four other older communities, quietly heralded the beauties of the Peninsula until it now is all but a mecca of home lovers.

But there are many beautiful spots in this area other than the half dozen that have tirelessly preached the merits of the Peninsula for so many years, and the alert real estate operators have begun developing them, unfortunately most of them on a hit or miss plan. There has been little or no coordinated effort to establish a style to the

landscape or architecture, with the exception of a few large projects where the operators have seen the hand writing on the wall. Many other possibilities in as many other districts are fallow fields awaiting the magic touch of an operator with the town planning instinct.

From the southern boundary of San Francisco to Palo Alto lies a territory like a scalloped fringe, running back into the foothills of the coastal mountains, following valleys sheltered from the coastal winds. Some of these protected areas have become noted as health retreats. In fact many government and private sanitoriums have located in this belt and they are usually full to capacity. The station of Belmont is the point of debarkation for at least six well-known sanitoriums and just beyond is the famous, huge army Dibble Hospital, now known as "Stanford Village." And so, added to the charm of a good place in which to live, an unspoiled district as a whole, an area of some two hundred square miles lies ready for residential development attended by adequate and profitable commercial growth. With the cities of Burlingame, Hillsborough, San Mateo and Redwood City and a few others, well and long established, there is little to hinder a wholesome and rapid growth of

**BURLINGAME,
CALIFORNIA
HIGH
SCHOOL**

**Good example of
non-modern school
architecture.**





WHOLE BLOCKS of four and five room veteran houses rise in Hillsdale, San Mateo County, California.

many new towns and communities. True, the beautiful homes of Burlingame and Hillsborough tend to discourage other ventures in home building under present conditions, but they really should encourage others by showing what can be done in this beautiful territory.

Several projects have been started on sufficient scale to give promise of worthy accomplishment. The Crystal Springs Development Company, owned by Messrs. Schmidt and Royce, will start breaking ground on their 864-acre tract to the west of San Mateo where they expect to start their first unit of 500 G.I. homes in the next thirty days. Just south of San Mateo, David D. Bohannon is well under way with his mammoth project of Hillsdale. There is already a station called by that name and the several hundred occupied houses there foretell a future town of real importance.

Contiguous to Hillsdale on the south, Conway and Culligan's Laurel Village has also developed to several hundred houses. While they are mostly small and of the G.I. type they occupy a pleasing slope of the hills and are beginning to present a more or less ambitious scheme.

Many of these new places are predicated upon the dire necessity for G.I. homes and nothing pretentious should be expected, but they can develop charm when properly planned. Most of the last two named places are devoted to four and five room so-called California type houses, but there are occasional departures in style and size. Moorish seems to be creeping in, perhaps due to the resemblance of the general terrain to that of Algeria.

Heretofore there has been a general feeling that the "Peninsula" was too remote from San Francis-



IN HILLSDALE the architectural style leans toward the better class of California small country homes.

SAN
CARLOS,
CALIFORNIA



A modern home where the MOORISH Style architecture seems to be "creeping into" the general design.

co, both in distance and time, but the railroad and bus lines are rapidly altering such conditions and it is a foregone conclusion that high speed traffic, freeways, and other modern methods will soon supply Peninsula residents transportation comparable with that between downtown and western and southern suburbs. At Redwood City the rolling land stretches several miles to the west and embraces some of the most beautiful building sites, with commanding views, in the county. David D. Bohannon has taken advantage of the opportunity to develop this large area and is now grading roads and installing utilities in what seems to be

destined to be the desideratum in fine residential acreage. No parcel is to be less than an acre in area and consistent building restrictions are contemplated.

More lengthy and detailed comments on the advantages of the Peninsula would be tautological and beyond the purpose of this article. The merits of the districts are, to say the least, fully set forth in the publications of the various chambers of commerce in San Mateo and Santa Clara counties. The purpose here is to present a brief, undetailed picture of what, in time, undoubtedly will be the major residential area of the city of San Francisco.



COMMERCIAL BUILDINGS have taken on a new and modern outlook.



ENTRANCE

ANGUS McSWEENEY, A.I.A., Architect

The HILLSBOROUGH
CALIFORNIA HOME *of*
Mr. and Mrs. George E. Madding

... MADDING, HILLSBOROUGH HOME

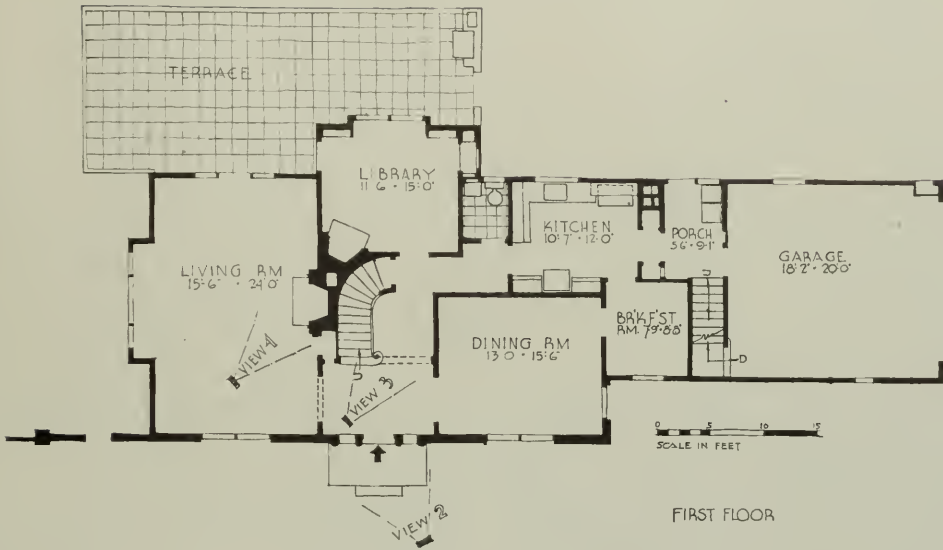

This beautiful San Francisco Peninsula home of Mr. and Mrs. George E. Madding, located in the Uplands, Hillsborough, California, is an excellent example of a modern home done in the traditional Colonial manner by Angus McSweeney, A.I.A., Architect of San Francisco.

Located on a large lot, outdoor living space was no problem, and ample space and living facilities were easily provided for within the home, as these two plans illustrate.





ENTRANCE

ANGUS McSWEENEY, A.I.A., Architect

The HILLSBOROUGH
CALIFORNIA HOME *of*
Mr. and Mrs. George E. Madding

... MADDING, HILLSBOROUGH HOME

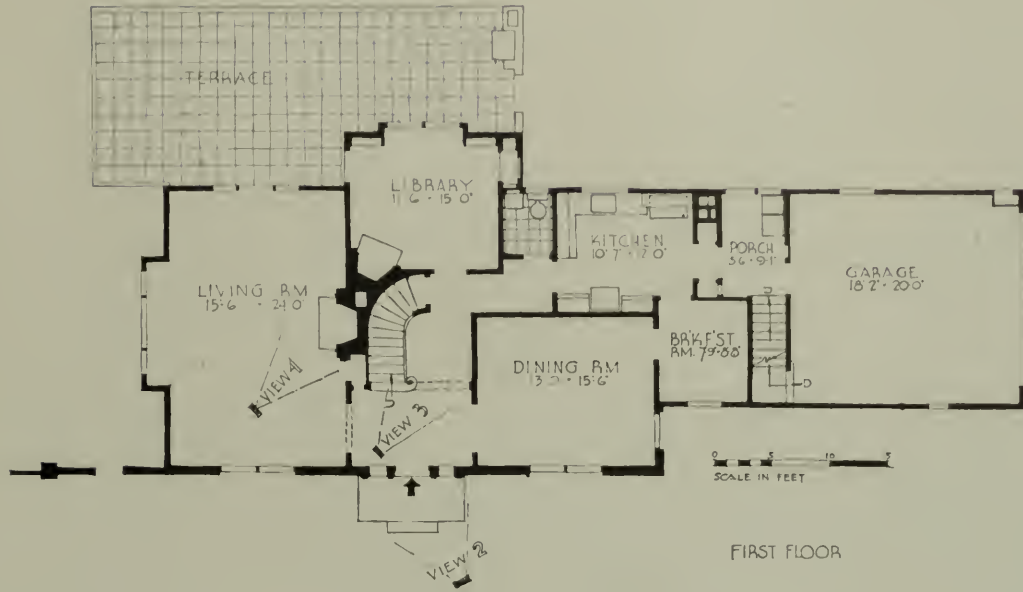

This beautiful San Francisco Peninsula home of Mr. and Mrs. George E. Madding, located in the Uplands, Hillsborough, California, is an excellent example of a modern home done in the traditional Colonial manner by Angus McSweeney, A.I.A., Architect of San Francisco.

Located on a large lot, outdoor living space was no problem, and ample space and living facilities were easily provided for within the home, as these two plans illustrate.



MADDING, HILLSBOROUGH HOME . . .



The owners desired a Colonial house having dignity, yet one with a straightforward simple design.

The home has a much larger appearance than it actually is through placing the garage doors on the side of the house so they are not visible from the front.

The well designed Colonial motif is carried out in the interior architectural features.

. . . MADDING, HILLSBOROUGH HOME



A spiral effect front stairs and well placed rear stairs is designed for the comfort and convenience of the occupants, and at the same time provides for perfect circulation of air throughout the house at all times. Heat for the cooler days is provided by a forced hot-air gas furnace.

The general construction is a heavy wood frame with painted wood rustic, brick veneer, and stucco finish.

Windows are double hung, while the floors are of oak. All of the interior finish is Oregon pine painted, except the library which has been done in knotty pine and is finished in the natural.

MADDING, HILLSBOROUGH HOME . . .



All of the rooms are large, while closet space is ample and careful consideration was given to the placing of all furniture and furnishings.

A garden extends alongside the living room and around to the rear of the house where the barbecue is located in close proximity to the kitchen.



ARCHITECT

Undertakes Planning Program For Re-Building of London's Homes

By **THOMAS HODGES**

Housing is the most urgent among all the tasks of social reconstruction being undertaken in Britain today, so that the appointment of J. H. Forshaw as Chief Architect and Housing Consultant to the Ministry of Health is an event of great importance. The



J. H. FORSHAW, Architect

Ministry is the department chiefly responsible for Britain's housing policy and its fulfilment, and the Ministry's architect, who shoulders this vast task, has to be a person of unusual ability and courage. No other architect in the country will be subjected to such searching scrutiny, both by the people of Britain and by his professional colleagues, but it is significant of the respect with which Forshaw is held that his appointment has been welcomed universally.

He goes to the Ministry of Health in his fiftieth year after a distinguished career spent almost

entirely in public service—for the Liverpool City Council, the Miners' Welfare Commission and, for five years during the recent world war, for the London County Council. In Britain, as in many countries, there is a continuous friendly argument between those who suggest that employment in government departments allows no scope for imaginative and truly creative work, and those who suggest that the vast tasks and responsibilities of public service and departmental employment can be the finest possible stimulant that an architect could desire. Whatever argument may be produced on either side, there is no doubt that every architect in Britain would agree that Forshaw seems to have found stimulus enough in his work for government and local government authorities and that his thirteen years work as architect to the Miners' Welfare Fund has enormously increased the prestige of government architecture. Of all the architecture in Britain between the wars of 1914-18 and 1939-45, none maintained such a high level of design and technical competence over such a large body of work.

(Continued on Page 38)



Colliery buildings in Lancashire, designed by J. H. Forshaw.

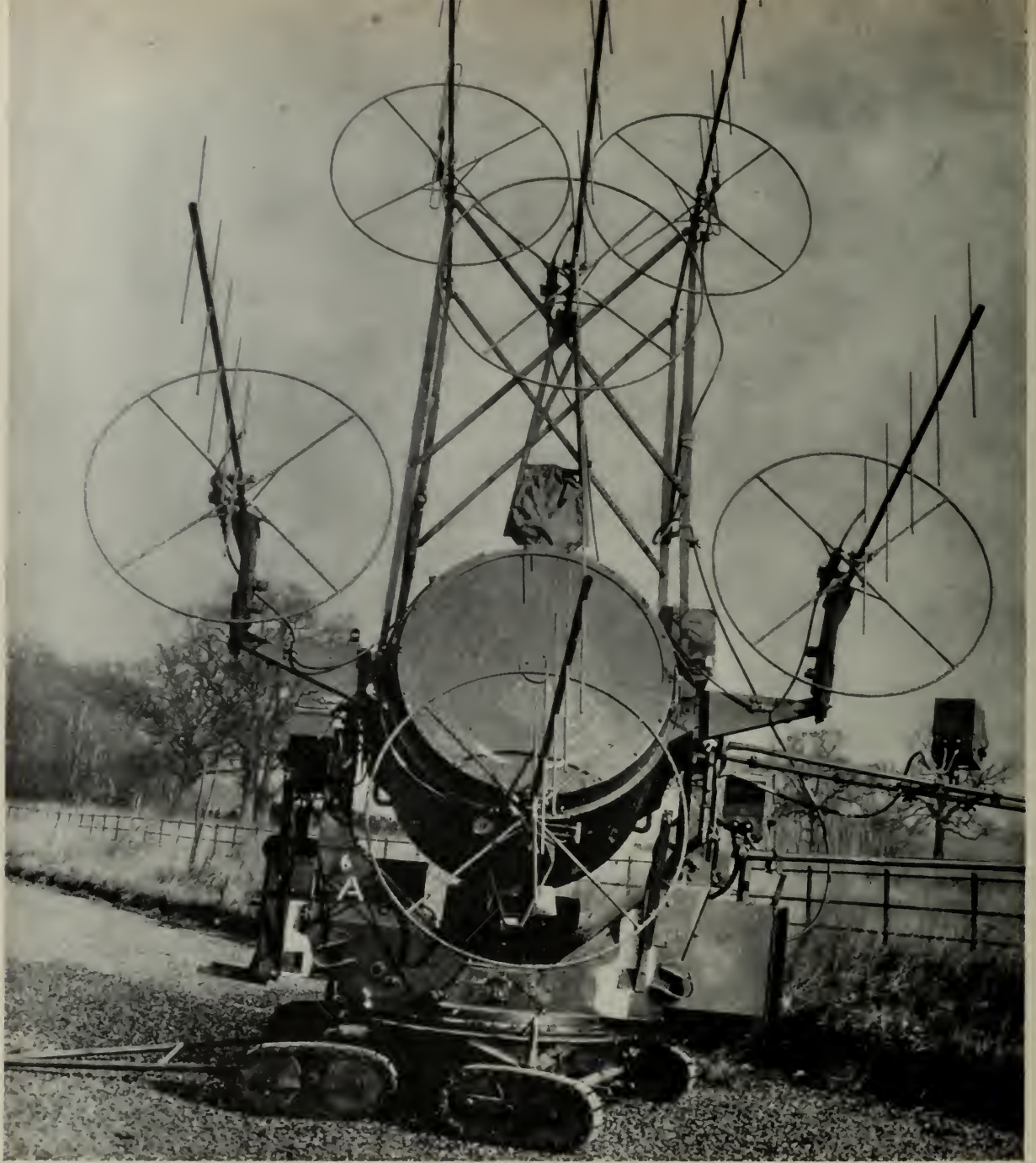

GIANT SEARCHLIGHT CONTROLLER very effective in England during the War.

RADAR IS NOT NEW

While radar has come into its own only in recent years, methods of detecting distant and invisible targets were used as long ago as the last war. One method depended on the chance pick-up of radio signals from the target itself—an enemy ship, for example, communicating with its base. But this

proved highly unreliable, since if the ship were not broadcasting, detection was impossible.

Another method was the use of giant mechanical "ears" to pick up the sound of approaching planes. But since this was limited by the speed of sound—700 miles an hour, about twice the velocity of a

fast bomber—the presence of a speedily approaching plane could not be revealed soon enough.

Radar is vastly superior to both these methods. First, radar does not depend upon any signal—radio, sound, or light—originating at the target; it sends out and receives back its own signal. Second, because radar waves travel with the speed of light, they can detect a target a score of miles away in less time than it takes to wink an eye. Third, radar is effective for long distances and is relatively unhampered by clouds, fog, rain, smoke or snowstorms.

The basic principle of radar was first noted in 1922 by Dr. A. Hoyt Taylor of the Naval Research Laboratory, and from that time he and his associates were engaged in the secret development of the discovery.

Since the early 1930's the Army had been carrying on intensive experiments in the development of radar for aircraft detection; in fact had designed its own power supply equipment, antennas and other vital parts. The big need, however, was for a radio tube powerful enough to send out waves that could spot aircraft targets 200 miles or more away.

Late in 1937, the Signal Corps Laboratories at Fort Monmouth, N. J., asked Westinghouse to produce such a revolutionary tube and to deliver 10 of them within 13½ months. The assignment of designing the new radar tube was given to Ilia E. Mouromtseff, Russian-born Westinghouse electronics engineer who in 1933 had beamed ultra-short radio waves experimentally from an East Pittsburgh, Pa., roof-top and had detected automobiles that passed along the Lincoln Highway opposite the plant there. The engineer was not aware of it at that time, but his early experiments pro-

vided him with his basic theoretical information for radar tube design.

Together with U. S. Army Signal Corps engineers, Mr. Mouromtseff and his assistants tackled the job.

"It took us 84 tries and a lot of sweat to build those first tubes," says Mr. Mouromtseff, "but we finished the original contract on time, thanks mainly to the assistance of the Signal Corps engineers and to my associates, George M. Dinnick and W. G. Moran."

Tube of Radical Design

To produce a tube that would generate thousands of watts at tremendous high frequencies, the engineers had to violate nearly every known rule about radio tube design. Production engineers took one look at the new design and doubted that it could work. Veteran glass blowers stated the design was impossible to make in any quantity. But months later the tube was in mass production and these men were helping to speed its output.

With Westinghouse engineers assisting, the Army ran approximately 40 field tests to put the tube and the radar set through all conceivable paces. These tests were conducted behind blinds on a hill near Atlantic Highlands, N. J., within earshot of the Atlantic Ocean surf. Even the armed guards who admitted the men to the trials were unaware of the confidential character of the activity.

Gasoline Tanks as Targets

To test the accuracy of the radar set, gasoline tanks at the end of Staten Island and the Empire State Building were used as targets. A radar beam was "squirted" at these fixed targets, whose direct

Ilia E. Mouromtseff (right), electronics engineer for Westinghouse, and G. R. Severance are shown beaming radio waves in demonstration.



EDITOR'S NOTE: This is the second and final article on the subject of RADAR. The first appeared in the September 1946 issue of ARCHITECT & ENGINEER.

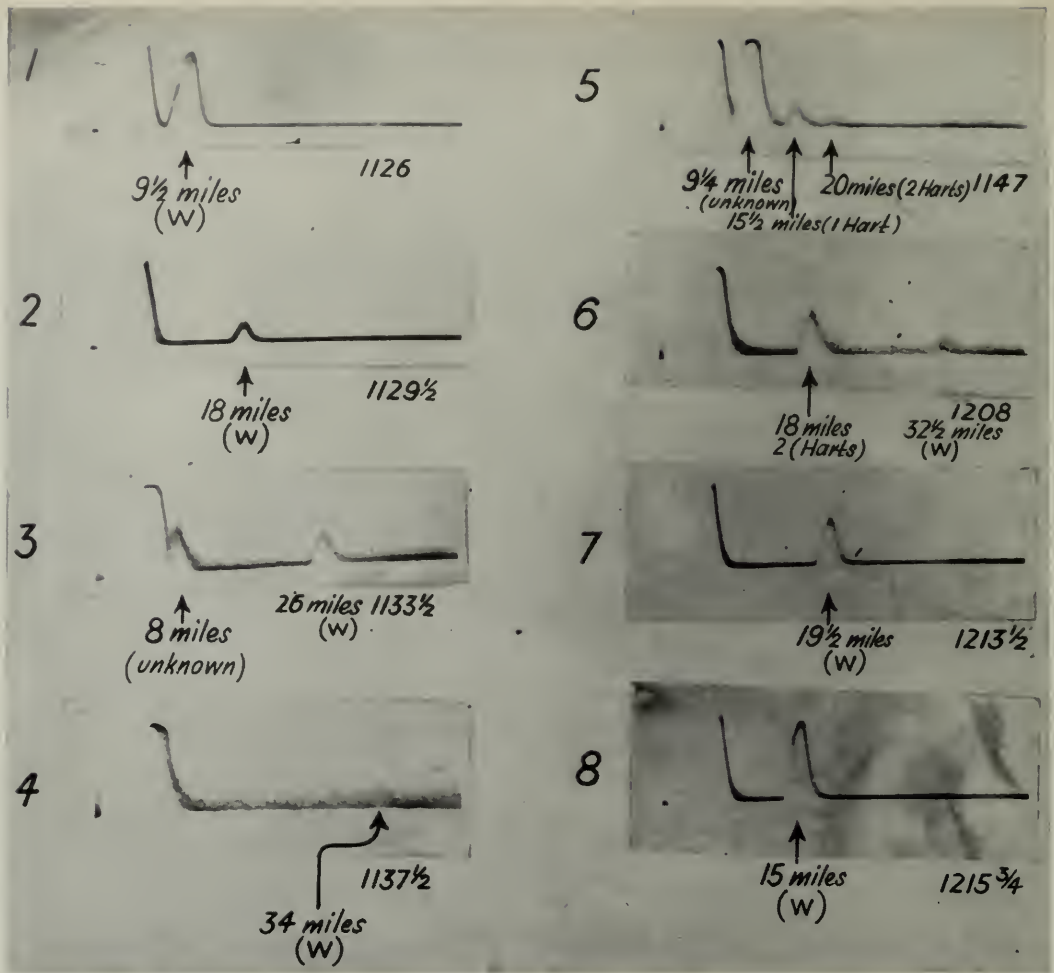

Copy of original British photographic radar record made on a cathode ray tube trace. The time of each photographic exposure is given on the right-hand side. The "echa" caused by a Wallace aircraft (W) on its outward journey is clearly visible (at increasing distances) in 1 to 4, and on its return journey (at decreasing distances) in 6 to 8. Nos. 5 and 6 indicate a formation of three Hawker Hart aircraft which came into the radar view uninvited.

air range was known, and calibrations were made on the basis of their electronic echoes.

Later, the tests were conducted at night with the help of big Army searchlights. An Army pilot was instructed to take off and put his plane through as many circus maneuvers as he chose. During this time the shutters of the searchlight were kept closed. At the end of five minutes they were opened and the light, which had been rotated in unison with the radar "eye," was turned on in full brilliance. The plane, appearing in the middle of the searchlight beam, proved the accuracy of the radar set's blind calculations.

What had happened was that the radar beam, capable of piercing darkness, fog, and rain with equal facility, had kept a constant "bead" on the plane, no matter what evasive tactics he used. All the while the plane was darting around in the darkness above, engineers were watching his movements in the form of a moving bright spot

on the fluorescent screen of an electronic oscilloscope.

Test in Below Zero Weather

Some of the tests at Atlantic Highlands were conducted in 18 below zero weather. Some had unusual results. On one occasion, those in charge of the trials recognized a double image on the fluorescent screen and concluded that the equipment was out of balance. But a check with the Coast Guard established that the plane on which a radar "fix" had been made meantime was joined by another plane for a side-by-side ride into Mitchell Field, N. Y., from a point over the New England shoreline.

Another time, a "fix" was made on a test plane flying above Montauk Point, Long Island. Suddenly the electronic bright spot increased greatly in intensity, much to the wonderment of observers. Radio contact was established with the pilot who cleared up the mystery by explaining that he had

just banked his ship preparatory to turning around and heading back home—a movement that greatly increased the radar “echo” since more of the plane’s surface was exposed to the radar waves in the vertical banking position.

Guarded Panama Canal

After passing all tests the new tube was incorporated into a complete long-range radar set for detection of aircraft. And more than a year before Pearl Harbor, the set was standing guard at the Panama Canal. Sea captains approaching the Canal were amazed to see U. S. patrol planes flying out to observe them long before their presence had been made known by customary radio communication. They did not know it, but they had been “betrayed” by long-range radar detection.

A little more than a year later a radar set, employing the revolutionary new tube, detected and located Japanese planes more than 30 minutes before they reached Pearl Harbor.

One of the richest radar sets in battle experience is the unit that saw action on the beachheads of Anzio and Normandy and in London during the “buzz-bomb” terror of mid-1944. This is the unit which feeds its information to a battery of electronically-operated anti-aircraft guns and enables them to fire at speeding aircraft with deadly accuracy.

The complete radar unit is built into a ten-ton, two wheel trailer which can be transported to any

desired spot and “stripped” for action in a matter of minutes. The transmitter, receiver, and all the delicate control equipment are housed within the truck’s steel body. The unit’s antenna, a dish-shaped reflector resembling a giant sieve, is raised to operating position above the roof of the truck by means of an elevator.

When the radar set is on the hunt for enemy aircraft, the dish-shaped antenna is rotated in a complete circle about seven times a minute. At the same time it “nods” up and down in any selected 30 degree arc, so that the radar beam probes the sky in a cork screw fashion that covers every point in space.

If the beam spots an enemy plane, it bounces back from the target to the antenna where sensitive receivers pick it up, amplify it and record it on indicators inside the truck. In a very brief interval, the radar observer can read the plane’s altitude, angle of elevation, its distance on a slant from the radar unit and its compass direction.

This information is fed electrically to the anti-aircraft battery. Here an electronic “brain” digests the radar data, makes adjustments for wind velocity, powder temperature, speed of aircraft and other factors; then directs the firing of a salvo of shells at the target.

Once the target is fixed, the antenna is locked on the target and the radar beam follows the enemy plane like a pointing finger, no matter what evasive tactics it takes. The electronic brain makes

Beamed from the reflector at center to a piece of metal held by the man at left, the waves are deflected back to the fluorescent tube causing it to light with almost normal brilliance although not attached to an electrical circuit. Dotted line indicates path of the radar waves from transmitter to reflector to target. (Westinghouse Photo)



any changes necessary to keep the guns on the target and automatically feeds this information to the gun director.

Among the most accurate of the Army's fire-control equipment, this radar unit gives range of the target to within 10 yards and compass direction and elevation to within 1/30th of a degree of absolute accuracy. It is estimated that at least 60 per cent of the buzz-bombs aimed at London in mid-1944 were shot down with the aid of this unit.

In the early stages of the Anzio beachhead battle, American troops were equipped with radar sets which detected and located German planes, but did not direct anti-aircraft fire. The Luftwaffe showed its defiance by formation bombing of American troops and installations.

Then the combined radar-gun director units were moved in, and on the next bombing raid the Germans lost nine out of twelve attacking planes. They made a few more attacks, but the results were so devastating that they finally gave up, except for scattered raids.

With the scarcity of enemy flying targets, the radar units were put to other useful tasks. One of the most successful of these was to guide our dive-bombers in precision attacks on enemy gun positions. First, reconnaissance patrols spotted the enemy strong point and fixed its location accurately on a map. Then a dive-bomber, in radio communication with the radar base, took off for the target.

The bomber's course was tracked by a radar beam fixed on the plane, enabling the radar observer to follow his every move and direct him by radio to the exact position of the target. The pilot was then told when to dive, when to release his bombs and when to pull out.

Still other use to which this versatile radar unit was put included the tracking of meteorological balloons at night to get wind velocity and the plotting of coastlines.

On D-Day about 40 of these units went ashore with invading Allied troops. Sealed in grease and asphalt to make them water-tight, the big ten-ton sets were rolled off landing barges and towed ashore. The unit is given a large part of the credit for helping clear the skies of the German Luftwaffe during the attack.

For duty in the Pacific area, Westinghouse made a smaller version of this unit. Housed in a four-wheel trailer weighing approximately half as much as its bigger brother, the unit was specially sealed to protect its vital equipment from water and the harmful moisture of tropical atmospheres.

Another veteran of many battles is the radar unit manufactured for installation aboard carrier-based and patrol planes. The unit enables the plane to sweep the sky ahead of it with two radar

beams projected from antennas located under the wing on either side of the fuselage. Rotated hydraulically, the rake-like antennas provide a beam with a total sweep of 140 degrees on a horizontal plane and 90 degrees in a vertical plane.

The pilot views the target through a single indicator located on his instrument board. This is equipped with four separate ranges, from 150 miles down to 5,000 yards, any of which the pilot can select by the flip of a switch. The pilot first sweeps the horizon in the maximum range for target-searching. Having located a target, he gradually reduces the range to get an ever-closer view of the enemy plane or ship.

The unit is especially effective in guiding torpedo planes. In the devastating attack on Japanese ships in the harbor at Truk, our pilots dropped their deadly "fish" with one eye on the radar indicator. For this purpose a special torpedo-release line was added to the indicator, enabling the pilot to read ranges as close as 200 yards to the target.

The unit was also used to direct the fire of 75 mm. cannon aboard B-24 Liberator bombers. When the Japs made attempts to land reinforcements at various islands under American attack, for example, the big bombers employed their radar "sights" to play havoc with enemy landing barges.

Not only was the unit employed to detect enemy targets, but also to locate the parent aircraft carrier or landing field and thus guide the plane back under complete radio silence.

As the tempo of the sea-and-air war in the Pacific increased, air sorties were made around the clock, at night as well as by day. Hence, there was need of a radar device which would enable our night fighters to "see" and attack enemy planes in pitch darkness. Westinghouse engineers, working jointly with scientists at the Massachusetts Institute of Technology, developed such a unit.

Made of special lightweight materials and weighing only 300 pounds, the unit is fitted compactly into the interior of the plane near the pilot's cockpit, except for the antenna which is slung under the wing.

The antenna, protected by a shell-like plastic covering, spins around 1,200 times a minute to send a broad sweeping radar beam, 120 degrees in width, in search of enemy planes. When a target is located, it is reflected back to the antenna and recorded on a single indicator on the pilot's instrument board.

The unit enables the pilot to fire at an enemy plane in pitch blackness. First, the pilot searches the area for a target on the 65-mile range. When he has located one, he heads his plane in that direction, decreasing the range of his indicator as he draws closer to the target. At a distance of one-

(Continued on Page 31)

A. I. A.

American Institute



ACTIVITIES

of Architects

Arizona Chapter:
James Macmillan, President; Arthur T. Brown, Secretary,
740 N. Country Club Road, Tucson, Arizona.

Central Valley of California:
Herbert E. Goodpastor, President; Frank V. Mayo, Secretary,
307 Exchange Building, Stockton 2, California.

Colorado Chapter:
Raymond H. Ervin, President; James M. Hunter, Secretary,
2049 Broadway, Boulder, Colorado.

Montana Chapter:
Ralph H. Cushing, President; H. C. Cheever, Secretary,
Montana State College, Bozeman, Montana.

Northern California Chapter:
Andrew T. Hass, President; John S. Bolles, Secretary, 369
Pine Street, San Francisco 4, California.

Oregon Chapter:
Francis Jacobberger, President; J. D. Annand, Secretary,
401 Central Building, Portland 5, Oregon.

San Diego Chapter (California):
H. Louis Bodmer, President; Louis J. Gill, Secretary, 203
Granger Building, San Diego, California.

Santa Barbara Chapter (California):
Roy C. Wilson, President; Miss Lutah M. Riggs, Secretary,
240 Middle Road, Santa Barbara, California.

CALIFORNIA COUNCIL OF ARCHITECTS

John S. Bolles, President; Charles O. Matcham, Vice-
President; James H. Mitchell, Secretary-Treasurer; 369
Pine Street, San Francisco 4.

Southern California Chapter:
Charles O. Matcham, President; John Landon, Secretary,
Chapter Headquarters 3757 Wilshire Blvd., Los Angeles 5,
California.

Spokane Chapter (Washington):
Noel E. Thomson, President; Kenneth D. Storment, Secre-
tary, Hutton Building, Spokane, Washington.

Utah Chapter:
George Cannon Young, President; Theodore R. Pope, Secre-
tary, 29 South State Street, Salt Lake City 1, Utah.

Washington State Chapter:
George W. Stoddard, President; Stephen H. Richardson,
Secretary, 516 Central Bank Building, Seattle 4, Washing-
ton.

Hawaii Chapter:
Kenneth W. Roehrig, President; James Morrison, Secretary,
334 Federal Bldg., Honolulu, T. H.

SOUTHERN CALIFORNIA CHAPTER

The Veterans' on-the-job training program has been put into effect in many offices. Firms desiring information may secure it from the Chapter office.

CARLTON MONROE WINSLOW, for many years a prominent figure in Southern California's architectural profession, passed away October 16th of a heart attack. He served as Director of the Chapter and was President of the Los Angeles County Art Commission for several years. For his work as a church designer he was made a Fellow by the A.I.A.

ROBERT VINCENT DERRAH, immediate Past President of the Chapter, succumbed to a heart ailment on October 9th. It was during his term that the California Council of Architects became a reality. Prior to serving as President he was Treasurer of the Chapter and was active in the architectural profession since coming to Southern California in 1922.

The regular November meeting, under chairmanship of Robert Alexander, featured Charles P. Bennett, Director, Los Angeles Planning Commission, speaking on "Progress on Master Plan of Housing and Urban Rehabilitation of Los Angeles"; John C. Austin, Chairman, Public Works Committee, who spoke on "Planning for Public Works"; Eugene Weston, Chairman, Urban Rehabilitation Committee, on "Planning for Urban Rehabilitation"; Simon Eisner, Chairman, Regional Planning Committee,

whose subject was "Planning for the Region"; and Sumner Spaulding, Chairman, Civic Center Committee, speaking on "Planning for Civic Center."

* * *

Werner Ruchti, long time head of the Regional Planning Office, is now Director of Planning for the City of Long Beach.

TIMOTHY L. PFLUEGER, San Francisco architect who became internationally known as a designer of large buildings, and underground garages, died of a heart attack in San Francisco on November 20, 1946.

He began his career as an office boy in the firm of James R. Miller, later receiving his education in the Beaux Arts Architectural School, and by the drafting board route worked up to a full partnership.

The Telephone Building, 450 Sutter Building, Union Square Garage, Stock Exchange Building, Metropolitan Life Building, San Francisco Junior College, all in San Francisco, were designed by the firm. He was consulting architect on the Golden Gate Bridge, San Francisco-Oakland Bay Bridge and the Golden Gate International Exposition on Treasure Island.

Many projects throughout the State and West were handled by the firm, while numerous extensive undertakings were in the process of formulation at the time of Pflueger's death.

WITH THE ENGINEERS

Structural Engineers Association of Northern California

William W. Moore, President; John A. Blume, Vice President; Franklin P. Ulrich, Sec.-Treas.; Offices 214 Old Mint Bldg., San Francisco, Phone GARfield 3890. DIRECTORS, Mark Falk, M. V. Pregnoff, and R. D. Dewell.

American Society of Civil Engineers

San Francisco Section

Theodore P. Dresser, Jr., President; Leon H. Nishikian and Sidney T. Harding, Vice Presidents; John E. Rinne, Secretary-Treasurer; 225 Bush St., San Francisco 20.

Puget Sound Council (Washington)

Engineering & Technical Societies

R. E. Kistler, A. I. E. E., Chairman; A. L. Miller, A.S.C.E., Vice-Chairman; L. B. Cooper, A.S.M.E., Secretary; B. A. Travis, I.E.S., Treasurer; Offices, Seattle, Washington.

STRUCTURAL ENGINEERS ASSOCIATION OF NORTHERN CALIFORNIA

One of the best attended meetings of the year was held by the Structural Engineers Association of Northern California in San Francisco during November.

Among important subjects discussed were: Co-operation with the California State Builders Exchange; expansion of the U. S. Coast Guard and Geodetic Survey on the West Coast; structural engineering education, and the proposed schedule of fees for structural engineers.

★ FOR BETTER SERVICE

Remember that

KRAFTILE is WESTERN HEADQUARTERS

For

- ACID Brick
- ACID-PROOF Jointing Compounds
- ACID-PROOF Floor and Tank Construction
- CERAMIC Facing
- GLAZED Structural Wall Units
- PATIO Tile
- QUARRY Tile
- QUONSET Packaged Steel Buildings
- STRAN-STEEL Framing
- SWIMMING POOL Overflow Gutter

For complete information and prompt service, phone or write

KRAFTILE COMPANY

Niles, California

Niles 3611

San Francisco — 50 Hawthorne Street, DOuglas 3780

The meeting was presided over by William Adrian, president.

J. A. SONNE is now connected with Kistner, Curtis & Wright of Los Angeles.

JACK Y. LONG COMPANY has moved into new offices in Oakland, California.

GEORGE McKEE is instructing in two classes at the University of California Extension Division, Oakland. Subject: "Structural Detailing and Design."

AMERICAN INSTITUTE OF STEEL CONSTRUCTION

At the recent national convention of the American Institute of Steel Construction held in Colorado, California, Alden G. Roach of the Consolidated Steel Corporation of Los Angeles; J. Philip Murphy of the Judson Pacific-Murphy Corporation of San Francisco; and Ferdinand Schmitz, Jr., of the Pacific Car & Foundry Company of Seattle, Washington, were elected directors for a three-year term.



J. PHILIP MURPHY
AISC Director

It was the first time in the history of the Institute that the West Coast has been recognized by

election of more than one member to the Board of Directors, and is indicative of the growing importance of West Coast steel industry.

RESEARCH ORGANIZATION FORMED

Representative of some 200 companies and associations engaged in the manufacture of building materials and equipment have formed a new fact finding and economic research organization to be known as the Building Products Institute.

Douglas Whitlock, formerly chairman of the Advisory Board of the Producers' Council, has been named chairman of the group.

Miles L. Colean, former assistant Administrator of the Federal Housing Administration, has been retained as the Institute's economic consultant.

Office of the new organization will be maintained in Washington, D. C.

MEMBERSHIP GROWS

Membership in the National Association of Home Builders has expanded during the past year from 8,000 to 11,500.

RADAR IS NOT NEW

(Continued from Page 28)

half mile from the enemy plane, the pilot then throws a switch changing the indicator from "search" to "gun air."

If the target is still in the field of the radar beam, a bright spot with a small pair of wings will appear in the center of the indicator. The pilot then steers his plane to bring the ends of the wings in exact alignment with two parallel lines etched on the indicator. When they reach this point, the pilot knows he is within 250 yards of the enemy plane and in perfect firing position. He then squeezes the triggers of his guns and veers quickly off to one side.

The vast American fleet that roamed the Pacific, convoyed troops and materials across the Atlantic, and stood guard against submarines along our coastline, was protected by a radar network capable of detecting enemy planes, submarine or surface ships hundreds of miles away.

To develop and produce a radar unit that would have universal application on all ships, the Navy early in 1942 appointed Dr. J. A. Hutchison to supervise the job on an industry-wide basis. The engineering and manufacturing facilities of several large producers of radio and other electronic equipment were pooled for this task.

This radar unit is one of the largest and most elaborate manufactured. The beam is projected from a rectangular antenna that resembles a giant bed-spring and is located near the crow's nest atop the ship. High-frequency radio waves are projected from the surface of the antenna to produce a large, broad beam, much like that which a rectangular mirror studded with electric lights would emit.

The antenna is rotated in a complete circle at relatively slow speeds. Because of the broad surface of the antenna and the terrific radio energy projected, targets as far away as 200 miles can be detected. This gives ample time to prepare for attack, to send out planes to intercept the enemy, or to radio information to other parts of the fleet or convoy.

Numerous indicators on the unit virtually "pin-point" the target for the radar observer, giving range, true and relative bearing, and angle of elevation if the target is an airplane. The most important of these is an electronic instrument on which is indicated information concerning targets, islands, coastlines, buoys and lighthouses. In addition, it records range and true bearing of the target.

When a target is located, the radar observer first sees it in the form of an inverted "V" or "pip"

Select locations for built-in telephone outlets now!



Specify that telephone conduit be installed during construction. Adds little to building cost—adds real value to house.



Even though only one telephone is needed initially, plan others for client's future convenience.

Convenience of well-placed telephone outlets will be appreciated year after year.



Additional telephones may be added in future without tearing up the flooring or running wires along baseboards.



Call your local Telephone Business Office.
Ask for free Architects' and Builders' Service.

The Pacific Telephone and Telegraph Co.



**A Name*
to Know
for Efficiency
and Economy
in ROOF TRUSSES**

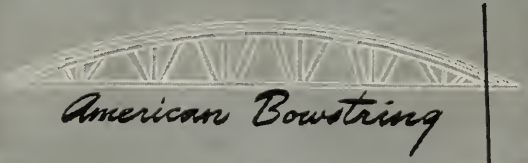

For sound, efficient roof truss engineering and construction, Builders and Architects in the East and Mid-West know and rely upon American. Now yours to command throughout the Far West, are American's quarter-century background and complete facilities.

When you write or phone concerning your roof truss job, state load, length of span, number required, spacing. Let us submit you an estimate - today!

REGISTER YOUR NAME now for new catalog and stress data - soon off the press.



***American
ROOF TRUSS CO.**

282 W. Santa Barbara Avenue • Los Angeles 37, California
Phone ADams 1-4379
and 6850 Stony Island Avenue • Chicago 49, Illinois

on the screen of a cathode-ray tube called the "A" scope. As the target approaches (assuming that it was first detected 200 miles away) the range of the "A" scope is shifted successively from the 200 to the 80, 20 and 4 mile scales in order that the range may be read accurately. By an electro-mechanical connection synchronized with the "A" scope, the observer can read the range from a gauge.

The unit is used not only to detect and locate targets, but also to guide our ships through fog, storms, night or dangerous waters. For this purpose an indicator provides a guide for navigation.

As radar underwent swift development, the manner and kinds of applications to specific tasks multiplied almost as rapidly. One of the latest achievements in this field was the design of a radar unit which determines the absolute altitude of aircraft and thus guides our interceptor planes to a "rendezvous" with enemy bombers or fighters. Westinghouse started production on this unit in mid-1944.

Called a ground-located height-finder, the unit is mounted atop a tower, which is located on the side or top of a hill for most effective operation. The antenna, a giant dish-shaped reflector, is housed in a pre-fabricated dome-shaped structure called a radome.

To pick up targets, the antenna is rotated slowly in a complete circle at the same time that it "nods" up and down in a 95 degree arc. The unit is capable of detecting small fighter planes at a distance of 65 miles, and large bombers 120 miles away.

Once an enemy plane is located, electrical computers in the unit go to work to figure the absolute altitude of the craft. Then from data furnished by the radar indicators, the plane's speed, compass direction, range and flying course are determined. This information is radioed to our interceptor pilots who are told that if they fly at a given speed and in a specified direction, they will make contact with the enemy bomber or fighter at a pre-determined "rendezvous."

If the enemy plane changes course or altitude suddenly, this variation is instantly recorded on the radar indicators. New computations are automatically made and the information radioed to the interceptors, which change their course accordingly.

The unit is equipped with eight specially-designed indicators. One indicator gives range on a broad scale; another presents a greatly expanded view of the first for more accurate range determination; a third called the "target spot indicator" literally pin-points the target for the radar observer. Other indicators include an altimeter, range, bearing and angle of elevation dials.

To aid the U. S. Marine Corps in its advance to-

ward Tokyo, Westinghouse developed a portable radar set that can be easily set up at advance positions to warn of approaching enemy planes. The entire unit can be dismantled and packed into four containers weighing no more than 100 pounds each.

The operations "room" is a tent made of special rainproof and fire-resistant material with space for the operator and all equipment except an engine generator. To search for enemy aircraft, the antenna is raised to a height of about 15 feet above the ground. It is then rotated slowly in a complete circle to search the surrounding area. The unit is capable of detecting planes at distances up to 80 miles and surface vessels at even greater ranges.

Uses Are Many

Most wartime applications of radar are readily convertible to peacetime use. Instead of tracking down enemy planes, ships, or installations, peacetime radar will be used to guide pilots safely over "unfriendly" mountainsides to steer ships through fog-ridden, dangerous waters, and to aid in traffic control at busy airports.

A radar set in the control tower of an airport, for example, will give the operator a complete picture not only of all planes approaching the field, but also of their position in relation to landing strips, obstructions, and other planes. This information, radioed to incoming pilots, will enable the operator to control large numbers of planes with great speed and accuracy.

The possibility of aircraft crashing against mountainsides or other lofty obstructions would be greatly lessened by the use of radar, because its beam is capable of penetrating the deepest fog, the most blinding snowstorm. A warning of the obstruction—its height and distance from the pilot—would be flashed to the pilot in ample time to avoid a collision.

High-Frequency Horizons Widened

Not only has the development of radar made astonishing progress during the war, but it has given enormous impetus to research in related fields. The rapid advances made in radio tubes capable of generating large amounts of power at extremely high frequencies, for example, will bring better frequency modulation radio and television equipment after the war, because the frequencies required in these sets are first cousins to those used in radar equipment.

Furthermore, the use of high-frequency radio waves in industry is growing daily and should increase greatly in the postwar era. One of the most spectacular applications of these waves for industrial heating helped speed production of tin at a time when Japanese seizure of supply sources became a serious threat.

The two fields in which high-frequency energy plays a paramount role are induction heating and

(Continued on Page 38)

WHO WANTS A POWER-STARVED HOME?

Inadequate wiring makes even a brand-new home a disappointment to its owners.

If one appliance must be disconnected to plug in others, if lights frequently dim, if appliances heat slowly, if fuses burn out, if electricity is wasted—the home is definitely power-starved and the architect may be blamed for having failed to insist on adequate wiring.

The difference between a poor wiring job and an adequate wiring installation in a new home is very small, but means so much to future comfort and satisfaction.

Prevent power-starvation in the homes you plan by specifying large enough wire and plenty of outlets and circuits for all present and future needs.

NORTHERN CALIFORNIA ELECTRICAL BUREAU

1355 MARKET STREET
SAN FRANCISCO 3



BAXCO

CHROMATED ZINC CHLORIDE

CZC

PRESSURE TREATED LUMBER

● **PROTECTS AGAINST DECAY
AND TERMITE ATTACK**

Specify it in your home

Available through Lumber Dealers

LOS ANGELES

601 W. 5th Street
Phone MIchigan 6294

SAN FRANCISCO

333 Montgomery Street
Phone DOuglas 3883

J. H. Baxter & Co.

AGENTS FOR WEST COAST WOOD PRESERVING CO. SEATTLE, WASH.



LOS ANGELES

Branch Offices

HOLLYWOOD
PASADENA
LONG BEACH
RIVERSIDE

SIERRA MADRE
TEMPLE CITY
WHITTIER
ONTARIO

UPLAND
LA VERNE
SAN PEDRO
INDIO

OAKLAND SAN FRANCISCO

HEADLINE NEWS & VIEWS

By E. H. W.

"The period of its greatest activity in the Nation's history lies ahead of the construction industry."—H. E. Forman, Managing Director, Associated General Contractors of America.

* * *

"The Producers' Council will devote its principal attention during the next year to the problem of increasing production of building materials and equipment, improving and streamlining the distribution system, and developing means of lowering the cost of building."—Tyler S. Rogers, President.

* * *

"Poor housing for any segment of the population not only serves as a health hazard, but it is a most important psychological factor which determines in a large measure the desires and interests of a citizenry in sharing the responsibility of good government."—Dr. William M. Thomas, member San Francisco Housing Commission.

* * *

Importance of the aviation industry may be recognized by the fact that it is estimated 50,000 people will find employment permanently at New York City's new Idlewild Airport which represents an investment of some \$200,000,000.

* * *

Public and inner-industry interest in eventual home building projects is evident by the announcement that exhibition space at the National Association of Home Builders convention scheduled for Chicago, next February 23-27, has been "Sold Out."

* * *

In a recent address, William K. Jackson, President of the U. S. Chamber of Commerce, declared "We must show that we already are doing what others can only promise..."

* * *

"The United States is embarking on a program of sub-standard, unsafe housing which in many cases will be the slums of tomorrow."—Prof. D. Kenneth Sargent, Syracuse (N. Y.) University.

* * *

In commenting on his company's policy of continuing expansion plans for steel plants in Seattle, South San Francisco, and Los Angeles, H. H. Fuller, President of Bethlehem Pacific Coast Steel Corp., stated: "We welcome competition and believe in it along with the free system of private enterprise which it engenders and under which this country has become the greatest in the world."

IN THE NEWS

PACIFIC TUBE

Sale to the Pacific Tube Company of Los Angeles, of the government owned facilities operated by that company during the past three years, was announced by the War Assets Administration recently.

The company produces cold drawn seamless steel tubing, welded steel tubing and cold drawn bar stock.

NEW GLASS

A new form of PLEXIGLAS designed to filter ultra-violet radiations, which cause sunburn, has been announced by Rohm & Haas Company of Philadelphia.

It can be worked with ordinary wood or metal working tools, or formed by softening with heat.

APPOINTED BY AISC

C. M. Corbit, Jr., has been appointed to fill the newly created post of District Engineer for Southern California, American Institute of Steel Construction.

Elmer E. Gunnette has been appointed District Engineer for Washington, Oregon and Idaho.

William H. Popert has been appointed District Engineer for the northern and central California areas, a position he has filled since July 1st.

LANDSCAPE ARCHITECT

Lloyd Jorgensen, landscape architect, has been assigned to the Tahoe National Forest, according to a recent announcement by Guerdon Ellis, supervisor of Tahoe Forest.

He will have charge of surveying and laying out camp sites, summer home areas and recreational grounds.

JOINS HERRICK IRON

S. A. Soderstrand is now Structural Engineer with the Herrick Iron Works, Oakland, California.

New!

TURRET-TYPE FLUORESCENT LUMINAIRE



*using the new
Twin Turret
Lampholder*

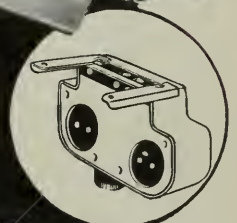

This new SMOOT-HOLMAN fixture incorporates the new turret lampholder which holds the lamps firmly in place without additional safeguards. The lamps are quickly inserted by depressing either face of the turret with one end of the lamp until the other end clears the opposite face and slips into place. The turret lampholder permits use of the new Jack Rabbit, for split-second starting. The luminaire itself is crafted according to Smoot-Holman quality and conforms to the new 9A RLM specification. Overall length 49 1/4", width 11 1/4", height 7".

Catalog No. NET - 2461

SMOOT-HOLMAN COMPANY

SMOOT-HOLMAN

INGLEWOOD, CALIFORNIA

MADE IN U.S.A.



Offices in Principal Western Cities—Branch and Warehouse in San Francisco

PRODUCER'S COUNCIL PAGE

The National Organization of Manufacturers of Quality Building Materials and Equipment
affiliated with THE AMERICAN INSTITUTE OF ARCHITECTS

President, E. E. CATHCART
Johns-Manville Sales Corp.
116 New Montgomery St.

Vice-President, C. J. NICHOLAS
Bastion-Morley Co.
301 Brannan St.

Secretary, H. C. GALITZ
Westinghouse Electric Corp.
110 Sutter St.

Treasurer, E. P. LARSON
Celotex Corp.
675 Townsend St.

Edited by C. W. KRAFT, KRAFTILE CO., Niles, California

NORTHERN CALIFORNIA CHAPTER

GENERAL COMMITTEE STRUCTURE

The Producers' Council, Inc.

Washington

D. C.

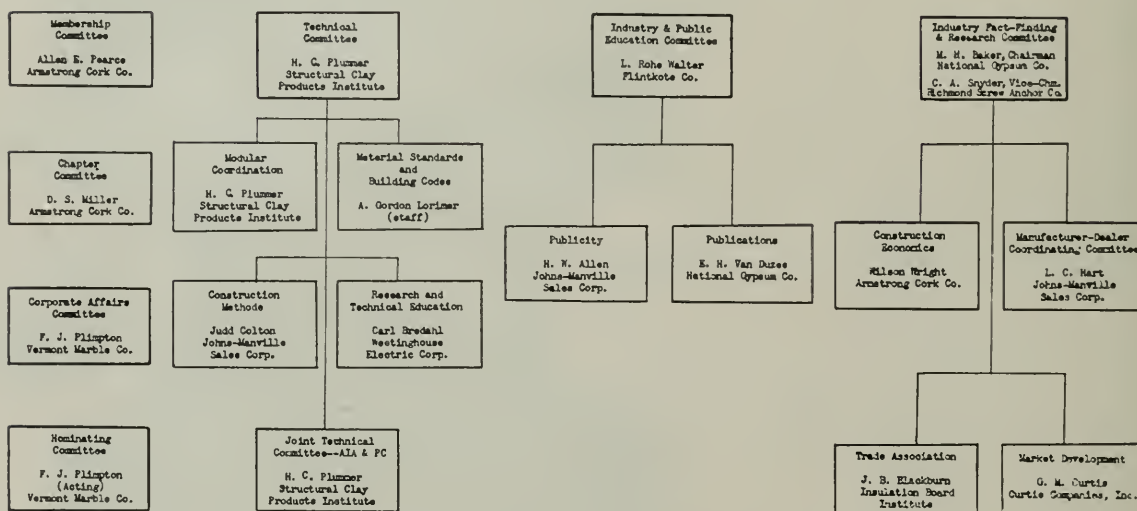

Geared to present is the new committee structure adopted by the National office under the leadership of new President T. S. "Ty" Rogers of Owens-Corning Fiberglass Corp. Adopted to meet current needs, the committees outlined in detail above, fall in to four logical groupings: (1) Council Affairs, (2) Technical, (3) Public Relations, (4) Industry Affairs. Each committee and sub-committee is headed by a technically trained man or by one qualified by experience to serve in his special field.

No More Advisory Board. Full reliance is placed on the Board of Directors for the conduct of Council activities.

Discontinued also is the Building Products Emergency Committee. The Council is undertaking no more legislative activities.

AIA Affiliation (A of the ABC's of Council activities) on an extended basis was agreed upon by the Joint Technical Committee of the AIA and Producers' Council.

Objectives have been clarified and major programs established by the new Board of Directors.

(Continued on opposite Page)

USE QUALITY PRODUCTS



CONSULT AN ARCHITECT

PRODUCERS COUNCIL PAGE — Cont'd

ABC's could stand repetition at this point. The Producers' Council is fundamentally based on:



A—Affiliation with the AIA;

B—Bulletin of technical data for the architect;

C—Chapter activities for uniting the activities of the two organizations in the interest of better construction.

16th Xmas Jinks has passed into history leaving a high water mark to shoot at in future years for fun and good fellowship, thanks to you, Clarke Wayland and your committee, including President Ed, Charles Nicholas, Herb Galitz, Ernie Larson, Harry Fabris, Fred Henning, Joe Carlson, and Past Presidents Ray Brown and George Quamby.

MERRY CHRISTMAS

APPOINTED SALES MANAGER

R. F. Kreisler, for the past eight years sales manager of Fir-Tex, has been appointed sales manager of the National Airlite Door Company of Los Angeles, California, according to a recent announcement by Walter E. Smith, company president.

National Airlite manufactures a new type of aluminum, overhead garage door, adjustable to fit any size door opening.

APPOINTED AIRPORT ENGINEER

Col. Frederick K. DuPuy has been retained by the Sonoma County Board of Supervisors, Santa Rosa, California, to prepare a Master Airport Plan for Sonoma County.

The project includes long range airport facilities at Santa Rosa, Petaluma, Cotati, Sonoma, Glen Ellen, Valley of the Moon, Healdsburg, Geyserville, Cloverdale, Sebastopol, Bohemian Grove, Guerneville, and other county areas.

DuPuy is Airport Engineer for Napa (California) County, and for Wm. P. Kyne's Bay Meadows Airport at San Mateo, California.

URBAN PLANNING

Formation of the Inter-Professional Urban Planning Conference, dedicated to the rebuilding and orderly future development of American cities has been announced by Louis Justement, chairman of the Committee on Urban Planning of the A. I. A.

SISALKRAFT

REG. U. S. PAT. OFF.

"More than a building paper"

THE SISALKRAFT CO.

205 West Wacker Drive
Chicago, Ill.

55 New Montgomery Street
San Francisco, Calif.

BASALITE

LIGHTWEIGHT CONCRETE
BUILDING UNITS

CHARACTER • ECONOMY • INSULATION
FIRE-SAFE • TERMITE PROOF • PERMANENCE

BASALT ROCK CO., INC.
NAPA, CALIFORNIA

FORDERER CORNICE WORKS

Manufacturers of

Hollow Metal Products • Interior Metal Trim
Elevator Fronts and Cabs
Metal Plaster Accessories • Sanitary Metal Base
Flat and Roll Metal Screens
Metal Cabinets • Commercial Refrigerators

269 POTRERO AVE.

SAN FRANCISCO, CALIF.

HEMLOCK 4100

STRUCTURAL STEEL

For Class A Buildings,
Bridges, etc.

JUDSON PACIFIC - MURPHY CORP.

1200 SEVENTEENTH STREET
SAN FRANCISCO

Plants: San Francisco - Oakland

(Continued from Page 23)



Schools have learned the lesson of health-safety. Architects and school officials know there is one solution to the problem, insofar as drinking water is concerned . . . Halsey Taylor Drinking Fountains.

There is a type for every need, each with the original patented automatic stream control and two-stream projector. Write for catalog illustrating and describing the complete Halsey Taylor line for school installations.

THE HALSEY W. TAYLOR CO.,
WARREN, OHIO
 West Coast Plant
 Redlands, Calif.

**HALSEY
 TAYLOR**



DRINKING FOUNTAINS

A-3

RADAR IS NOT NEW

(Continued from Page 33)

dielectric heating. In the first, radio energy creates an electro-magnetic field surrounding a copper coil and metal placed in this field is heated by induced radio frequency current flowing on the surface of the metal. By this process metals can be made red-hot instantaneously while floating in free space although the coil responsible for this heat remains stone-cold.

Dielectric heating is used for materials that do not conduct electricity, such as wood, plastics, glue, or—medically speaking—arthritic joints. The material to be heated is sandwiched between two electrically charged metal plates. This charge agitates molecules of the material causing them to rub together and create heat by what might be called molecular friction.

The present applications and future possibilities of high-frequency heating reach into nearly every industry.

Radio waves, the same kind that ferreted out enemy planes, ships, harbors, and installations, are being harnessed to speed the production of the tools and goods of peace.

J. H. Forshaw had his boyhood education at Ormskirk Grammar School in Lancashire, and from 1915 to 1919 served in the army, being adjutant of the 55th Divisional Royal Engineers. He won the Military Cross. After the war he went for his architectural training to the famous school at Liverpool University to learn his architecture from Professor Sir Charles Reilly and his town planning from Sir Patrick Abercrombie—later to be his partner in the preparation of his greatest personal achievement, the County of London Plan. At Liverpool Forshaw won the Certificate in Civic Design and the First Civic Prize for Townplanning.

In 1939 Forshaw was brought to the London County Council as Deputy Architect. The Chief Architect to the Council had about three years to serve before retiring, and he called Forshaw in as his deputy to gain experience in the Council routine before assuming the senior post; he was also specially charged with the duty of revising the whole administrative structure of the architectural and planning departments, because it was realized that readjustment was needed to meet the Council's ever growing tasks.

Before Forshaw could tackle this work and before he took over as Chief Architect—which he did in 1941—the 1939-45 war began, and Forshaw had to abandon creative architecture, and even the reorganization of his department, to be head of the London Heavy Rescue Service.

In 1941, soon after he had become Chief Architect, he was charged by the London County Council with the preparation of the postwar plan for the 116 square miles of the County. No such immense planning task had ever been considered in Britain before and this commission was given in the middle of a world war. As is well known, Sir Patrick Abercrombie, Professor of Town Planning at University College, London, worked with Forshaw as consultant.

The County of London Plan, published in 1943, is too large and complex an achievement to be described in an article about its author and it has been so well described in articles in the technical journals of almost every country in the world that description here is probably unnecessary. Forshaw has now left the London County Council, leaving behind him a living monument of his brief period as its Architect which is larger in significance for the future of the capital city of Britain than any task he could possibly have foreseen when he came to the Council in the fateful year 1939.

ESTIMATOR'S GUIDE

BUILDING AND CONSTRUCTION MATERIALS

PRICES GIVEN ARE FIGURING PRICES AND ARE MADE UP FROM AVERAGE QUOTATIONS FURNISHED BY MATERIAL HOUSES TO SAN FRANCISCO CONTRACTORS. 2½% SALES TAX ON ALL MATERIALS BUT NOT LABOR

All prices and wages quoted are for San Francisco and the Bay District. There may be slight fluctuation of prices in the interior and southern part of the state. Freight cartage, at least, must be added in figuring country work.

BONDS—Performance—\$10 per \$1000 of contract. Labor and materials, \$10 per \$1000 of contract.

BRICKWORK—

Common Brick—Per 1M laid—\$50.00 to \$60.00 (according to class of work).

Face Brick—Per 1M laid—\$120 to \$150 (according to class of work.)

Brick Steps—\$1.60 per lin. ft.

Brick Veneer on Frame Bldg.—Approx. \$1.30 per sq. ft.

Common Brick—\$19.00 per M, truckload lots, f.o.b. job.

\$19.00 per M, less than truckload, plus cartage.

Face Brick—\$40 to \$80 per M, truckload lots, delivered.

Cartage—Approx. \$4.00 per M.

BUILDING PAPER—

1 ply per 1000 ft. roll	\$4.25
2 ply per 1000 ft. roll	6.25
3 ply per 1000 ft. roll	7.75
Brownskin, Standard, 500 ft. roll	6.00

BUILDING HARDWARE—

Sash cord com: No. 7	\$1.20 per 100 ft.
Sash cord com. No. 8	1.50 per 100 ft.
Sash cord spot No. 7	1.90 per 100 ft.
Sash cord spot No. 8	2.25 per 100 ft.
Sash weights, cast iron	\$50.00 ton.
Nails, \$3.42 base.	
Sash weights, \$45.00 per ton.	

CONCRETE AGGREGATES—

The following prices net to Contractors unless otherwise shown.

Gravel, all sizes—		
\$1.95 per ton at Bunker; delivered	\$2.50
	Bunker	Del'd
Top Sand	\$1.90
Concrete Mix	1.90
Crushed Rock, ¼" to ¾"	1.90
	2.50

Crushed Rock, ¾" to 1½"	1.90	2.50
Roofing Gravel	2.25	2.80
River Sand	2.00	2.45

Sand—		
River Sand	2.00	2.45
Lapis (Nos. 2 & 4)	2.85	3.15
Olympia (Nos. 1 & 2)	2.85	3.10
Del Monte White84c per sack

Cement—
Common (all brands, paper sacks), carload lots, \$2.42 per bbl. f.o.b. car; delivered \$2.72.
Cash discount on carload lots, 10c a bbl., 10th Prox.; less than carload lots \$3.20 per bbl. f.o.b. warehouse or delivered.

Cash discount 2% on L.C.L.

Atlas White	} 1 to 100 sacks, \$2.50 sack	warehouse or del.; \$7.65 bbl. carload lots.
Calaveras White		
Medusa White		

Forms labor average \$350 per 1000 sq. feet.

Average cost of concrete in place, 50c per cubic foot, exclusive of forms; \$15.00 per cubic yard. With forms \$1.60 per cubic foot.

DAMP-PROOFING and Waterproofing—

Two-coat work, \$3.50 per square.

Membrane waterproofing—4 layers of saturated felt, \$7.00 per square.

Hot coating work, \$2.50 per square.

Medusa Waterproofing, \$3.50 per lb. San Francisco Warehouse.

Tricocel waterproofing.

(See representative.)

ELECTRIC WIRING—\$12 to \$15 per outlet for conduit work (including switches).

Knob and tube average \$3.00 per outlet. (Available only for priority work.)

ELEVATORS—

Prices vary according to capacity, speed and type. Consult elevator companies. Average cost of installing a slow speed automatic passenger elevator in small four story apartment building, including entrance doors, about \$6500.00.

EXCAVATION—

Sand, 60 cents; clay or shale \$1 per yard.

Trucks, \$20 to \$32 per day.

Above figures are an average without water. Steam shovel work in large quantities, less; hard material, such as rock, will run considerably more.

FIRE ESCAPES—

Ten-foot galvanized iron balcony, with stairs, \$150 installed on new buildings; \$160 on old buildings.

FLOORS—

Composition Floors, such as Magnesite, 50c per square foot.

Linoflor—2 gages—\$1.25 to \$2.75 per sq. yd.

Mastipave—90c to \$1.50 per sq. yd.

Battleship Linoleum—available to Army and Navy only—1/8"—\$1.75 sq. yd. 3/8"—\$2.00 sq. yd.

Terazzo Floors—50c to 70c per sq. ft.

Terazzo Steps—\$1.75 per lin. ft.

Mastic Wear Coat—according to type—20c to 35c.

Hardwood Flooring—

Standard Mill grades not available.

Victory Oak—T & G	\$143.25 per M. plus Cartage
¾" x 2¼"	122.00 per M. plus Cartage
½" x 1½"	113.50 per M. plus Cartage
Prefinished Standard & Better Oak Flooring	
¾" x 3¼"	\$180.00 per M. plus Cartage
½" x 2½"	160.50 per M. plus Cartage

Maple Flooring		
¾" T & G Clear	\$160.50 per M. plus Ctg.
2nd	153.50 per M. plus Ctg.
3rd	131.25 per M. plus Ctg.

Floor Layers' Wage, \$1.87½ per hr. (Legal as of Jan. 21, 1946. Given us by Inlaid Floor Co.)

GLASS—

Single Strength Window Glass	20c per	□ ft
Double Strength Window Glass	30c per	□ ft.
Plate Glass, under 75 sq. ft.	\$1.00 per	□ ft.
Polished Wire Plate Glass	1.40 per	□ ft.
Rgh. Wire Glass34 per	□ ft.
Obscure Glass27 per	□ ft.
Glazing of above is additional.			
Glass Blocks	\$2.50 per	□ ft. set in place

HEATING—

Average, \$1.90 per sq. ft. of radiation, according to conditions.

Warm air (gravity) average \$64 per register.

Forced air, average \$91 per register.

IRON—Cost of ornamental iron, cast iron, etc., depends on design.

LUMBER—All lumber at O.P.A. ceiling prices—

No. 1 Common.....	\$49.00 per M
No. 2 Common.....	47.75 per M
Select O. P. Common.....	52.75 per M

Flooring—

Delvd.	
V.G.-D.F. 8 & Btr. 1 x 4 T & G Flooring.....	\$80.00
C 1 x 4 T & G Flooring.....	75.00
D 1 x 4 T & G Flooring.....	65.00
D.F.-S.G. 8 & Btr. 1 x 4 T & G Flooring.....	61.00
C 1 x 4 T & G Flooring.....	59.00
D 1 x 4 T & G Flooring.....	54.00
Rwd. Rustic—"A" grade, medium dry.....	82.00
3 to 20 feet	
"B" grade, medium dry.....	78.50
6 to 20 feet	

Plywood—not available

	Under \$200	Over \$200
"Plyscord"—3/8".....	\$49.50	\$47.55
"Plywall"—1/4".....	45.15	43.30
3 ply—2/s—1/4".....	48.55	46.60
"Plyform"—5/8".....		
Unoiled.....	126.50	121.45
Oiled.....	127.90	122.75

Above prices delivered if quantity is sufficient to warrant delivery.

Shingles (Rwd. not available)—

Red Cedar No. 1—\$6.75 per square; No. 2, \$5.75; No. 3, \$4.45.
 Average cost to lay shingles, \$3.00 per square.
 Cedar Shakes—Tapered: 1/2" to 3/4" x 25"—\$8.95 per square.
 Resawn: 3/4" to 1 1/4" x 25"—\$10.65 per square.
 Resawn: 3/4" to 1 1/4" x 25"—\$10.65 per square.
 Average cost to lay shakes, \$4.00 per square.

MILLWORK—Standard.

D. F. \$100 per 1000. R. W. Rustic \$100.00 per 1000 (delivered).
 Double hung box window frames, average with trim \$6.50 and up, each.
 Complete door unit, \$10.00.
 Screen doors, \$3.50 each.
 Patent screen windows, 25c a sq. ft.
 Cases for kitchen pantries seven ft. high, per lineal ft., \$9.00 each.
 Dining room cases, \$9.00 per lineal foot.
 Rough and finish about 80c per sq. ft.
 Labor—Rough carpentry, warehouse heavy framing (average), \$40.00 per M.
 For smaller work average, \$40.00 to \$55.00 per 1000.

MARBLE—(See Dealers)

PAINTING—

Two-coat work.....	per yard 50c
Three-coat work.....	per yard 70c
Cold water painting.....	per yard 10c
Whitewashing.....	per yard 8c

PAINTS—

Two-coat work.....50c per sq. yd.
 Three-coat work.....70c per sq. yd.
 Cold water painting.....per yard 10c
 Whitewashing.....8c per sq. yd.
 Turpentine \$1.03 per gal. in drum lots.
 \$1.08 per gal. in 5-gal. containers.
 Raw Linseed Oil—not available.

Boiled Linseed Oil—\$1.38 per gal. in drums. Available only to work with high priority—\$1.48 per gal. in 5-gal. containers.

Use replacement oil—\$1.86 per gal. in 1-gal. containers.

Replacement Oil—\$1.20 per gal. in drums. \$1.30 per gal. in 5-gal. containers.

A deposit of \$6.00 required on all drums.

PATENT CHIMNEYS—

6-inch.....	\$1.20 lineal foot
8-inch.....	1.40 lineal foot
10-inch.....	2.15 lineal foot
12-inch.....	2.75 lineal foot

PLASTER—

Neat wall, per ton delivered in S. F. in paper bags, \$17.60.

PLASTERING (Interior)—

	Yard
3 Coats, metal lath and plaster.....	\$2.25
Keene cement on metal lath.....	2.70
Ceilings with 3/4 hot roll channels metal lath (lathed only).....	1.80
Ceilings with 3/4 hot roll channels metal lath plastered.....	3.30
Single partition 3/4 channel lath 1 side (lath only).....	1.80
Single partition 3/4 channel lath 2 inches thick plastered.....	4.80
4-inch double partition 3/4 channel lath 2 sides (lath only).....	3.30
4-inch double partition 3/4 channel lath 2 sides plastered.....	5.75
Thermax single partition; 1" channels; 2 1/4" overall partition width. Plastered both sides.....	4.95
Thermax double partition; 1" channels; 4 3/4" overall partition width. Plastered both sides.....	6.60
3 coats over 1" Thermax nailed to one side wood studs or joists.....	2.45
3 coats over 1" Thermax suspended to one side wood studs with spring sound isolation clip.....	2.85
Note—Channel lath controlled by limitation orders.	

PLASTERING (Exterior)—

	Yard
2 coats cement finish, brick or concrete wall.....	\$2.00
3 coats cement finish, No. 18 gauge wire mesh.....	3.00
Lime—\$4.00 per bbl. at yard.	
Processed Lime—\$4.15 per bbl. at yard.	
Rock or Grip Lath—3/8"—30c per sq. yd.	
1/2"—29c per sq. yd.	

Composition Stucco—\$2.70 to \$3.00 sq. yard (applied).

PLUMBING—

From \$100.00 per fixture up, according to grade, quantity and runs.

ROOFING—

"Standard" tar and gravel, 4 ply—\$8.00 per sq. for 30 sqs. or over.
 Less than 30 sqs. \$9.50 per sq.
 Tile, \$30.00 to \$40.00 per square.
 Redwood Shingles, \$7.50 per square in place.
 5/2 #1-16" Cedar Shingles, 4 1/2" Exposure.....\$8.00 square

5/8 x 16"—#1 Cedar Shingles, 5" Exposure.....\$9.00 square
 4/2 #1-24" Royal Shingles, 7 1/2" Exposure.....\$9.50 square
 Re-coat with Gravel \$4.00 per sq.
 Asbestos Shingles, \$23 to \$28 per sq. laid.
 1/2 x 25" Resawn Cedar Shakes, 10" Exposure.....\$10.50
 3/4 x 25" Resawn Cedar Shakes, 10" Exposure.....11.50
 1 x 25" Resawn Cedar Shakes, 10" Exposure.....12.50
 Above prices are for shakes in place.

SHEET METAL—

Windows—Metal, \$1.75 a sq. ft.
 Fire doors (average), including hardware \$2.00 per sq. ft.

SKYLIGHTS—(not glazed)

Copper, 90c sq. ft. (flat).
 Galvanized iron, 40c sq. ft. (flat).
 Vented hip skylights 60c sq. ft.

STEEL—STRUCTURAL—

\$150 ton (erected), this quotation is an average for comparatively small quantities. Light truss work higher. Plain beams and column work in large quantities \$140 per ton.

STEEL REINFORCING—

\$100 to \$130 ton, set.

STONE—

Granite, average, \$6.50 cu. foot in place.
 Sandstone, average Blue, \$4.00. Boise. \$3.00 sq. ft. in place.
 Indiana Limestone, \$2.80 per sq. ft. in place.

STORE FRONTS (None available).

TILE—

Ceramic Tile Floors—\$1.00 to \$1.25 per sq. ft.
 Cove Base—\$1.10 per lin. ft.
 Glazed Tile Wainscot—\$1.25 per sq. ft.
 Asphalt Tile Floor 1/8" & 3/8"—\$.18 to \$.35 per sq. ft. Light shades slightly higher.
 Cork Tile—\$.40 to \$.75 per sq. ft.
 Mosaic Floors—see dealers.
 Lino-Tile, \$.35 to \$.75 per sq. ft.

Wall Tile—

Glazed Terra Cotta Wall Units (single faced) laid in place—approximate prices:
 2 x 6 x 12.....\$1.10 sq. ft.
 4 x 6 x 12.....1.25 sq. ft.
 2 x 8 x 16.....1.20 sq. ft.
 4 x 8 x 16.....1.40 sq. ft.

VENETIAN BLINDS—

50c per square foot and up. Installation extra.

WINDOWS—STEEL—

30c per square foot, \$5 for ventilators.

ARCHITECT AND ENGINEER

IN THE NEWS

EMPLOYEES OF STANLEY WORKS HOLD OPEN HOUSE

Reversing the usual procedure, employees of The Stanley Works, together with their families and citizens of New Britain, Connecticut, recently held "Open House" in recognition of the completion of a new building which marked the culmination of a two-year construction and plant enlargement program.

Five buildings were included in the program: One is seven stories high and contains about 245,000 square feet of manufacturing space for the production of articles in the hardware line. Another building of six stories with 136,000 square feet of floor space houses the electric tool division. A third building is used for the manufacture of wire and rod products, while two smaller buildings are used as a garage for storage and maintenance of Stanley's extensive motor fleet, and for steel operations.

Items manufactured by Stanley were on display and more than 20,000 people attended the open house.

Included in a program which was planned by the employees was a brief talk by R. E. Pritchard, President of The Stanley Works; R. W. Chamberlain, Vice President, and others.

APPOINTED TRAFFIC MANAGER

Howard M. Daschbach, traffic manager of Geneva Steel Company, has been appointed traffic manager of Columbia Steel Company and will serve as traffic manager of both companies.

U. N. SITE COMMITTEE

Members of a 35-40 man sub-committee of the United Nations Site Commission, accompanied by a staff of engineers and technicians, conducted a survey of the San Francisco Bay area recently, in search of a permanent home for the U. N. O.

Sites at Crystal Springs, Moraga Valley, and southern end of the San Francisco Peninsula were inspected.

BUILDING TRADES WAGE (JOB SITES) NORTHERN AND CENTRAL CALIFORNIA

ATTENTION: The following are the PREVAILING hourly rates of compensation as determined by the Wage Adjustment Board, or which have been determined by the United States Department of Labor—Revised to July 1, 1946. Wage scales shown are those being paid and in effect mostly by agreement between employees and their union.

CRAFT	San Francisco	Alameda and Contra Costa	Marin	Vallejo	San Mateo	San Jose	Stockton	Sacramento	Fresno
ASBESTOS WORKERS.....	1.75	1.75	1.75	1.75	1.75	1.75	1.75	1.75	1.75
BRICKLAYERS.....	2.05	2.05	2.05	2.05	2.05	2.05	1.75	2.05	2.00
BRICKLAYERS, HODCARRIERS.....	1.57½	1.57½	1.57½	1.57½	1.57½	1.57½	1.47½	1.15	1.25
CARPENTERS.....	1.75	1.75	1.75	1.75	1.75	1.75	1.62½	1.50	1.50
CEMENT FINISHERS.....	1.75	1.75	1.75	1.75	1.75	1.75	1.75	1.75	1.75
ELECTRICIANS.....	1.87½	1.87½	1.87½	1.70	1.87½	1.87½	1.75	1.82½	1.75
ENGINEERS: MATERIAL HOIST.....	1.60	1.60	1.60	1.60	1.60	1.60	1.60	1.60	1.60
PILE DRIVER.....	2.00	2.00	2.00	2.00	2.00	2.00	2.00	2.00	2.00
STRUCTURAL STEEL.....	2.00	2.00	2.00	2.00	2.00	2.00	2.00	2.00	2.00
GLASS WORKERS.....	1.58½	1.58½	1.58½	1.58½	1.58½	1.21	1.40	1.37½	1.37½
IRONWORKERS: ORNAMENTAL.....	1.85	1.85	1.85	1.85	1.85	1.85	1.85	1.85	1.85
REINF. RODMEN.....	1.75	1.75	1.75	1.75	1.75	1.75	1.75	1.75	1.75
STRUCTURAL.....	2.00	2.00	2.00	2.00	2.00	2.00	2.00	2.00	2.00
LABORERS: BUILDING & CONCRETE.....	1.25	1.25	1.15	1.15	1.15	1.15	1.25	1.25	1.15
LATHERS.....	1.90	1.90	1.60	1.87½	1.75	2.00	1.87½	1.60	1.87½
MARBLE SETTERS.....	1.75	1.75	1.75	1.75	1.75	1.75	1.75	1.75	1.75
MOSAIC & TERRAZZO.....	1.75	1.75	1.75	1.75	1.75	1.75	1.60	1.16	1.12½
PAINTERS.....	1.75	1.75	1.75	1.64	1.75	1.75	1.60	1.60	1.50
PILEDRIVERS.....	1.86	1.86	1.86	1.86	1.86	1.86	1.86	1.86	1.86
PLASTERERS.....	2.00	2.00	1.75	2.00	2.05	2.00	2.00	1.87½	1.87½
PLASTERERS' HODCARRIERS.....	1.75	1.75	1.75	1.75	1.75	1.75	1.65	1.65	1.40
PLUMBERS.....	1.87½	1.87½	1.87½	1.87½	1.87½	1.87½	1.87½	1.87½	1.87½
ROOFERS.....	1.50	1.62½	1.50	1.62½	1.25	1.37½	1.50	1.50	1.50
SHEET METAL WORKERS.....	1.75	1.75	1.75	1.75	1.75	1.75	1.75	1.75	1.75
SPRINKLER FITTERS.....	1.58	1.58	1.58	1.58	1.58	1.58	1.58	1.58	1.58
STEAMFITTERS.....	1.87½	1.87½	1.87½	1.87½	1.87½	1.87½	1.87½	1.87½	1.87½
STONESETTERS (MASON'S).....	2.05	2.05	2.05	2.05	2.05	2.05	1.75	2.05	2.00
TILESETTERS.....	1.80	1.75	1.75	1.75	1.75	1.75	1.37½	1.37½	1.37½

Prepared and compiled by

CENTRAL CALIFORNIA CHAPTER, ASSOCIATED GENERAL CONTRACTORS OF AMERICA

with the assistance and cooperation of secretaries of General Contractors Associations and Builders Exchanges of Northern California.

CLASSIFIED ADVERTISING

RATE: 10c PER WORD . . . CASH WITH ORDER

MINIMUM \$2.50

ARCHITECT'S REPORTS—A valuable advance news service giving building and construction information daily on projects in Northern California. Name, location, architect, proposed cost, etc., on individual slips. Ideal for securing new business leads. Hundreds of items, total monthly cost only \$10. Don't delay, subscribe today. ARCHITECT & ENGINEER, Room 618, 68 Post Street,

San Francisco, California. Phone DOUGLAS 8311.

PHOTOGRAPHY—Keep a pictorial record of your building, or construction project. Pictures are of tremendous value to contractors, builders, engineers, architects. For Industrial-Publicity-Aerial photography, see FRED MAE, Room 721-22 Hearst Bldg., San Francisco 3, California.

ENGRAVING—Good engravings are essential to a satisfactory job of printing reproduction. For the best, see Poor Richard Photo Engraving Co., 324 Commercial St., San Francisco.

PRINTING—Printers, bookbinders. See us for commercial printing. Mercury Press, 942 Howard Street, San Francisco.

SUPERSTITION AND COLOR IN INTERIOR DECORATING

(Continued from Page 9)

born. Inside the rooms blue glasses are on tables and shelves, they are supposed to break to pieces when they meet an evil eye. Turkish boats are protected by chains of blue stones on both sides and on the masts.

In Mecklenburg superstitious people try to protect their children against diphtheria by putting a blue thread around their necks. In Algiers and other parts of North Africa many houses are painted blue, particularly in the Mohammedan and Jew-

ish quarters of the cities; this blue color originally was supposed to be a powerful protection against the evil eye. Blue in stables is very popular and may have the same basis—more so perhaps than the fear of flies of blue colors on walls and ceilings. In Syria well-meaning people send pot-flowers to the bride the day after the wedding, the pots being painted blue.

Magic Colors

Both blue and red are ancient magic colors. They are connected with the eerie red and blue of a flash of lightning. In ancient times Greeks as well as Romans protected their children against the evil eye by tying red threads around their wrists or wrapping them in a red scarf. According to the talmud, trees were protected against evil influence by painting them red.

The inhabitants of Northern Europe believed a red cloth would bring them luck in hunting. On the southern slopes of the Balkan a red cross is painted on the house door when a child is born. In China, three days after the birth of a child, certain signs are painted on red paper and several objects are wrapped up in this paper and then suspended by a red ribbon from a hook behind the door. The top brick of a new-built house in China is painted red, and decorated with garlands of red cloth or red paper and smeared with the red blood of a red cockscomb.

Generally red is not liked by evil spirits. Mongolian sorcerers wear a red attire. Red is essential for everything connected with a wedding ceremony in Hindustan, and this custom is supposed to have been common in ancient India. The bridegroom wears a silken red robe, the rooms are decorated in red, and all the presents given to the young couple are wrapped together with red thread. In Morocco the bridegroom who, on his wedding day, rides on horseback through the town, wears a red topcoat and finds his new abode decorated with red scarfs, cloth and curtains. The Turks attach a small red ribbon to the person or the object they want to protect.

Green in Mohammedan countries is the color of the Prophet and as such used freely in the room decoration. Gray, as a rule, is a somewhat meaningless color; but we are told that in some countries gray is used for inner decorating, just for its modesty which does not attract the attention of evil spirits. Yellow is a specific charm against all kinds of evil influence in China.

Those are only single items out of a huge list of relations between color and superstition in interior decorating. Though we are rarely aware of them, they exist and give evidence that even in our epoch of enlightenment human beings try to protect themselves by the power of colors against frightening and sinister natural forces.

HOGAN LUMBER CO.

Wholesale and Retail

LUMBER

MILL WORK • SASH & DOORS

Office, Mill, Yard and Docks

SECOND AND ALICE STREETS • OAKLAND, CALIF.

Telephone GLencourt 6861

CLINTON CONSTRUCTION CO. OF CALIFORNIA

General Contractors

923 FOLSOM STREET • SAN FRANCISCO

SUtter 3440

SANTA MARIA INN SANTA MARIA, CALIFORNIA

FRANK J. McCOY, General Manager

FERNAND E. PIMENTEL, Manager

**On the
Coast
Highway
between
San
Francisco
and
Los
Angeles**



**American
or
European
Plan
•
Old
English
Tap
Room**

BOOK REVIEWS

A **GLOSSARY of Technical Words, Terms and Phrases Used in the Plastic Industry.** B. F. Goodrich Chemical Co., Cleveland 15, Ohio.

A 12-page self-contained Glossary of chemical names, terms and phrases used in the plastic and rubber industries. Describes use and manufacture. Available upon request of manufacturer.

MARBLE FORECAST—1946 September 1947. Marble Institute of America, 108 Forster Ave., Mt. Vernon, N. Y.

Brochure outlining availability of domestic and foreign marbles and groups all marble into four classifications according to their respective characteristics and working qualities. ALSO available is new booklet, **MARBLE FOR THE HOME**, illustrating many uses of marble.

SPECIFICATION FOR THE DESIGN OF LIGHT GAUGE STEEL STRUCTURAL MEMBERS. American Iron & Steel Institute, 350 Fifth Avenue, New York 1, N. Y.

First official edition issued by American Iron & Steel Institute, Committee on Building Codes, in response to requests for design standards to govern the use of light gauge steel members for structural purposes in buildings and similar structures.

Contains basic design principles, charts, graphs, and tables to clarify the application of some features of the specifications.

EVERY INDICATION points to 1947 as being the start of a great era of commercial and industrial development throughout the 11 Western States. YOU, as an Architect, Contractor, Engineer, Manufacturer, and/or Craftsman, are an important individual in the ultimate extent to which the Pacific Slope will develop.

CONFERENCE CONCRETE PIPE MANUFACTURERS

The regular fall meeting of the California Associated Concrete Pipe Manufacturers was held in Fresno early this month.

Featured at various sessions presided over by H. W. Chutter, President, were: T. J. Kauer, manager of the Wire Reinforcement Institute; W. M. Caldwell, manager California Association of Employers; and R. B. Cozzens, Regional Engineer, U. S. Bureau of Reclamation.

The Most Complete Line of
STEELS and BUILDING MATERIALS
Made by a Single Producer



See Sweet's Catalog File or write us for full information.

REPUBLIC STEEL CORPORATION
GENERAL OFFICES: CLEVELAND, OHIO

DENVER, COLORADO CONTINENTAL OIL BUILDING
LOS ANGELES, CALIFORNIA EDISON BUILDING
SALT LAKE CITY, UTAH WALKER BANK BUILDING
SAN FRANCISCO, CALIFORNIA RIALTO BUILDING
SEATTLE, WASH. WHITE-HENRY-STUART BUILDING

PACIFIC MANUFACTURING CO.

HIGH CLASS INTERIOR FINISH
QUALITY MILLWORK

142 SANSOME ST., SAN FRANCISCO
GArfield 7755

6820 McKINLEY AVE., LOS ANGELES
THornwall 4196

BUILDERS EXCHANGE, OAKLAND

"AMERICAN - MARSH" CONDENSATION UNIT

Pumping
Machinery
for
Every
Purpose

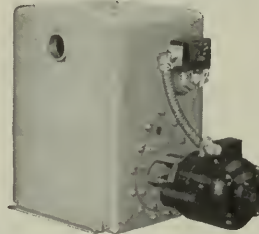

For Service
Call
DOuglas
6794
or
MUtual8322

SIMONDS MACHINERY CO.
SAN FRANCISCO 816 FOLSOM
LOS ANGELES 455 EAST 4TH

VERMONT MARBLE COMPANY

Producers and Finishers
of

Domestic and Imported Marbles

525 MARKET STREET, SAN FRANCISCO
Phone SUTter 6747

727 W. 7th STREET, LOS ANGELES
Phone TRinity 3459



IN THE NEWS

NAIL SHIPMENTS

If uninterrupted, the current high rate of nail shipments should, in a few months, relieve the present shortage, according to the American Iron and Steel Institute.

The peacetime annual rate was 789,000 tons.

Nail shortages developed as the result of loss of nail and staple production early in 1946, due to strikes.

POSTWAR FIRE FIGHTING SENSATION ANNOUNCED

New and novel! The Foamite Airfoam-Generating Nozzle—a strikingly out-of-the-ordinary foam-making, fire-fighting nozzle, only 2½" in diameter at the widest part of the barrel. It is made by American-LaFrance-Foamite Corporation of Elmira, New York.

The Foamite Airfoam-Generating Nozzle mechanically creates Airfoam through a scientific mixing of water, air, and Foamite Airfoam Liquid within the Nozzle, and dis-

charges the combined ingredients as Foamite Airfoam through the nozzle tip.

It is especially ideal for extinguishing fires in flammable oils, paints, varnishes, etc.

NEW DOOR JAMB

Following a period of thorough testing and proving, a new door jamb has been placed on the market by the Wheeler-Osgood Company, known as the WHEELER-OSGOOD TRU-SIZED DOOR JAMB.

The following drawing gives the details of this new product.

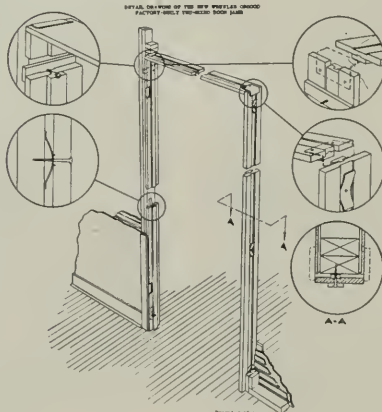

Radically different in design and construction it offers many advantages over ordinary door jamb installations.

PORTABLE ELECTRIC HOME HEATER

A new lightweight portable electric heater for home use has been announced by Westinghouse, San Francisco.

Headquarters for the manufacture and sale of the new units have been established at Emeryville, California, and for the time being the major points of dealer distribution will be on the Pacific Coast with Oregon and Washington receiving all of the early production.

The heater is made of aluminum satin finish, styled to blend with any decorative treatment, and weighs less than five and one-half pounds.

CLARKSON COMPANY Sales and Engineering departments have been moved from San Francisco to main office at 1414 El Camino Real, San Carlos, California.

LICENSED CONTRACTORS registered with the California Contractors Board numbered some 39,460 on October 1, 1946.

One of the University of California's three cyclotrons will soon be moved from the Berkeley to the Los Angeles campus.

The giant 4000-ton cyclotron at the University of California has hurled atomic bullets ten times harder than any used so far in atomic bomb research.

More than 1500 veterans are housed in University-provided quarters on the Berkeley campus of the University of California.

More than 30 classes in music have been opened this fall by University Extension, University of California, in cooperation with the San Francisco Conservatory of Music.

University Extension, University of California, is organizing an increasing number of "in-plant" training courses for industrial concerns in the San Francisco Bay area.

CEREAL PLANT

Construction of the General Mills Corporation's new \$2,000,000 packaging and cereal plant at Lodi, California, is well under way, according to company officials.

The new structure will be 740 feet long, and will contain more than two acres of floor space, and will supplement the Portland, Oregon, plant.

APPOINTED

James H. Quick and Frederick Ingalls have been appointed assistants to Frank Meunier, advertising and sales promotion manager of the General Petroleum Corporation, Los Angeles.

Venetian Blinds
of
Metal or Wood
for
Homes and Offices

Installed and Serviced
by

GUNN CARLE & CO.

20 POTRERO AVENUE
SAN FRANCISCO 3

Underhill 5480

ARCHITECT AND ENGINEER

MULLEN MFG. COMPANY

BANK, STORE AND OFFICE
FIXTURES—CABINET WORK
OF GUARANTEED QUALITY
CHURCH SEATING

Office and Factory:
60-80 RAUSCH ST., Bet. 7th and 8th Sts.
San Francisco
Telephone UNderhill 5815

THE TORMEY COMPANY

GENERAL PAINTERS
AND DECORATORS

Phone UNderhill 1913

563 FULTON STREET
San Francisco

ELMER F. STEIGELMAN

CIVIL ENGINEER

*Structural Design,
Surveying and
Subdivisions*

577 FOURTEENTH STREET
OAKLAND, CALIFORNIA

TWinoaks: 4191

Basalt Rock Co., Inc.

*Ready Mixed Concrete
Building Materials
Basalite Products*

SIXTH & BERRY STREETS
SAN FRANCISCO
PHONE: GARFIELD 3758

IN THE NEWS

NEW INTERNATIONAL STANDARDS BODY

Howard Coonley, chairman of the Executive Committee of the American Standards Association has been elected president of the International Organization for Standardization, recently organized in London.

Representatives of 23 national standards associations attended the organization meeting.

ENGINEERS MOVE

The firm of J. Y. Long Company, engineers, has moved into new offices at 1441 Franklin Street, Oakland, California.

Jack Y. Long, D. E. Ryan, Alexander Corsun, and J. A. Johaneck comprise the organization which engages in a general practice of engineering.

NAMED REPRESENTATIVE

G. S. Parsons has been appointed San Diego, California, representative of the Lincoln Electric Company.

Prior to serving in the U. S. Armed forces Parsons was affiliated with the Lincoln Electric Company, at one time representing their branch office in Los Angeles.

CPA BUILDING APPROVALS

More than \$84,500,000 of essential commercial and industrial construction was approved through the northern California district office of the Civilian Production Administration during the eight months that construction has been under government control, according to official reports.

During the same time some \$58,000,000 of commercial construction was denied.

CPA approvals for the entire state of California were \$219,000,000 for the five month period, beginning March 26, 1946.

THEODORE CRILEY, Jr., Architect, has moved to 610 W. 4th Street, Los Angeles 13, California.

DINWIDDIE CONSTRUCTION COMPANY

•
BUILDERS
•

CROCKER BUILDING
SAN FRANCISCO



HERRICK IRON WORKS

STRUCTURAL STEEL
REINFORCING STEEL

18TH AND CAMPBELL STS.
OAKLAND, CALIF.
Phone GLencourt 1767

Phone GARfield 1164

Thomas B. Hunter

Consulting Engineer

DESIGNER OF HEATING
AIR CONDITIONING
VENTILATING AND WIRING
SYSTEMS, MECHANICAL
AND ELECTRICAL EQUIP-
MENT OF BUILDINGS

41 SUTTER STREET
ROOM 710

San Francisco California

Scott Company

HEATING . . PLUMBING . . TILE

★

243 MINNA STREET
SAN FRANCISCO
Phone EXbrook 6741

**PITTSBURGH
TESTING LABORATORY**

Successors to
SMITH, EMERY & COMPANY

*Testing and Inspecting
Engineers and Chemists*

Structural Materials, Structures
Equipment, Pipe, Soils.

651 Howard St., San Francisco 5
EXbrook 1747

A. F. MATTOCK CO.

Builders

★

212 CLARA STREET
SAN FRANCISCO

**INDEPENDENT
IRON WORKS**

Steel Buildings
Service Stations
Steel Storage Tanks
Fabricated Plate Work
Steel & Sheet Metal Products
Fabricated Structural Steel
Steel Distributors

Eighth & Pine Sts. Oakland, 7

George F. Brayer

ELECTRICAL
CONTRACTOR

**166 Seventh Street
San Francisco**

Phone: MArket 1761

Index to Advertisers

ALADDIN Heating Corp.	46
AMERICAN Roof Truss Co.	32
ARCHITECTS Reports	*
BASALT Rock Company, Napa	37
BASALT Rock Company, San Francisco	45
BAXTER & Company, J. H.	34
BRAYER, Geo. F.	46
CLASSIFIED Advertising	41
CLINTON Construction Company	42
DINWIDDIE Construction Company	45
FORDERER Cornice Works.....	37
FULLER, W. P. Co.	*
GUNN, Carle & Company.....	44
HANKS, Inc., Abbot A.	46
HAWS Drinking Faucet Company	Back Cover
HERRICK Iron Works.....	45
HOGAN Lumber Company.....	42
HUNT, Robert W., Company.....	46
HUNTER, Thos. B.	45
INDEPENDENT Iron Works.....	46
JOHNSON Company, S. T.	*
JUDSON, Pacific-Murphy Corp.	37
KAWNEER Company	*
KRAFTILE Company	30
MATTOCK, A. F.	46
MULLEN Mfg. Co.	45
MUELLER Brass Co.	2
NORTHERN California Electrical Bureau	33
PACIFIC Coast Gas Association	Inside Back Cover
PACIFIC Manufacturing Company....	43
PACIFIC Portland Cement Company. .	1
PACIFIC Telephone & Telegraph Co. .	31
PARAMOUNT Built-in Fixture Co.	*
PETERSEN, Harold F.	46
PITTSBURGH Testing Laboratory.	46
PORTLAND Cement Association.	*
REMILLARD-Dandini Co.	46
REPUBLIC Steel Corporation.....	43
SANTA Maria Inn.....	42
SCOTT Co.	45
SIMONDS Machinery Company.....	43
SISALKRAFT Company	37
SMOOT-Holman Co.	35
STANLEY Works, The.	*
STEIGELMAN, Elmer F.	45
TAYLOR Co., Halsey W.	38
TORMEY Company, The.	45
UTILITY Appliance Corp.	*
U. S. BONDS.....	5
VERMONT Marble Company	43
WESTERN Asbestos Company.....	Inside Front Cover
WOOD, E. K., Lumber Company.	34

* Indicates Alternate Months

**ABBOT A. HANKS, INC.
Engineers & Chemists**

INSPECTING — TESTING — CONSULTING
CONCRETE • STEEL • MATERIALS
CHEMICAL AND TESTING
LABORATORIES
• RESEARCH AND INVESTIGATION •

TESTS OF STRUCTURAL MATERIALS
DESIGN OF CONCRETE MIXES
SHOP AND ERECTION INSPECTION OF
STRUCTURES AND EQUIPMENT
INVESTIGATION OF STRUCTURES
AND MATERIALS
TESTS AND INVESTIGATION OF
FOUNDATION SOILS
FIRE RESISTANCE AND INSULATION
TESTS

624 Sacramento Street, San Francisco

**Robert W. Hunt Company
ENGINEERS**

Inspection • Tests • Consultation
Schools and Other Structures
Are Built as Designed

*When Construction Materials are
Inspected at points of Manufacture
and during Erection by*

ROBERT W. HUNT COMPANY

*Cement, Concrete, Chemical, Metallurgical,
X-Ray and Physical Laboratories*

Chicago • New York • Pittsburgh
Los Angeles • All Large Cities
San Francisco, 251 Kearny Street

REMILLARD-DANDINI Co.

**Brick and
Masonry Products**

★

633 BRYANT ST., SAN FRANCISCO
569 THIRD ST., OAKLAND

**ALADDIN
Heating Corp.**

Specializing in
QUALITY HEATING
EQUIPMENT

2222 San Pablo Avenue
OAKLAND
TWinoaks 1022

**ARCHITECT AND ENGINEER
INDEX TO ARTICLES AND ILLUSTRATIONS
VOLUMES 164-167, 1946**

A	Page	G	Page
Adobe Houses (John W. Byers).....	Oct. 12		
Adrian, Wm.	Jan. 32		
Airplanes, Douglas Skymaster, 44 Passenger.....	July 12		
Airport Conversion Project, Napa (Frederick K. Dupuy and Russell G. DeLappe).....	Oct. 26		
American Red Cross Campaign.....	Feb. Cover		
Apartment Houses in Casablanca, Morocco.....	Feb. 18		
Apartment Houses in Tunis.....	Feb. 21-25		
A.I.A. Activities.....	Jan.-Dec. 31		
Architects, Royal Institute of British (C. D. Spragg).....	Feb. 13		
Architecture for Leisure (Hubert E. Bird).....	Apr. 16		
Art News and Comment.....	Jan.-Dec. 6		
Auto Sales and Apartment Bldg., Algiers.....	Feb. 26		
B			
Bank and Office Building, Casablanca.....	Feb. 17		
Bank, Compagnie Algerienne, Morocco.....	Feb. 19		
Bridges, Rainbow Spans of Steel (David B. Steinman).....	Aug. 26		
Bridges, Golden Gate, Mt. Hope, Rhode Island.....	Aug. 26		
Building Code, San Francisco Proposed (Albert J. Evers).....	July 8		
Building Construction Methods, Industrial (J. P. H. Perry).....	May 9		
C			
California Bear Flag Raising.....	May Cover		
Calif. Council of Architects, First Annual Convention (Address by J. N. Edmunds, Jr., "Where Do We Go from Here").....	Nov. 9		
Cameras, Your New Home Planned by (Lalla Hunter).....	Jan. 13		
Church, Coventry Cathedral.....	Jan. 14		
Church, St. Marks in the Valley, Santa Barbara (Winsor Soule and Jno. F. Murphy).....	April 11		
Church, Community, Baldwin Hills, L. A. (Garret Eckbo).....	Sept. 15		
City Planning, British, Difficulties and Hopes (Murril Hain).....	July 16		
City of London, Bombed Area of St. Paul's Cathedral.....	July 16		
City Planning, Eugene, Oregon.....	Sept. 26		
Commercial Buildings in North Africa (J. W. Hastings).....	Feb. 16		
Community, Cooperative Plan (Edw. Williams and Jos. A. Stein).....	Sept. 20		
D			
Bank of State of Morocco.....	Feb. 16		
Dewell, Henry D.—Obituary.....	April 32		
Douglas Fir Plywood Industry.....	Aug. 9		
E			
Editorial Notes.....	Mar.-Dec. 4		
Eisenhower's Scottish Culzean Castle.....	Jan. 16		
Engineers, Structural, Entertain.....	Oct. 30		
Engineers, With the.....	Jan.-Dec. 32		
Estimators' Guide.....	Jan.-Dec. 41		
F			
Factory Building, Bethlehem Steel Co., New Mill Depot.....	April 15		
Factory Building, Stanley Works, New Britain.....	June 20		
Factory Building, Willamette Valley Wood Chemical.....	Sept. 25		
Farm Workers Community Plan, Shafter (Garrett Eckbo).....	Sept. 14		
Fees, Schedule of Architectural.....	Mar. 6		
G			
Garden and the House—Cooperative Housing Project (Hildgard Boeninger).....	May 26		
Garden, Fisk (Francis E. Lloyd and Garrett Eckbo).....	Sept. 12-13		
Garden Court, Robt. Platt, Oakland (R. Royston).....	Sept. 16		
Garden Plan, Wm. Boeckel Residence, San Mateo (R. Royston).....	Sept. 18		
Glass, Stained:			
in Architecture (Harold W. Cummings).....	April 19		
Iowa State College (Harold W. Cummings).....	April 18		
Santa Fe Ry. Office, San Francisco (Harold W. Cummings).....	April 20		
Musicians Union, San Francisco (Harold W. Cummings).....	April 21		
Private Library (Harold W. Cummings).....	April 22		
Penthouse Window, Mrs. Mayes (Harold W. Cummings).....	April 23		
Financial Center Bldg., S. F. (Harold W. Cummings).....	April 25		
Masonic Temple, Lodi (Harold W. Cummings).....	April Cover		
H			
Hangar, Western Air Lines, L. A. Airport.....	July 13		
Headline News and Views (E. H. Wilder).....	Jan.-Dec. 36		
Highway, St. Cloud, France, Aerial View.....	June 27		
Highways, California Modern and Scenic.....	July 22		
Hospital, Berkeley General (Herrick)—(Resting & McGuinness).....	Nov. 16-30		
Hospital Statuary, Sydney, Australia.....	Nov. 12		
Hospital for Victor M. Orsatti, Beverly Hills (E. T. Heitschmidt and C. O. Matcham).....	Nov. 11		
Hotel, D'Angleterre, Algiers.....	Feb. 23		
Hotel Statler, Los Angeles.....	Aug. 24		
House I Want (Grace McC. Morley).....	Mar. 7		
Modern Living (Gardner Dailey).....	Mar. 8		
House and Garden Relationship (Thos. D. Church).....	Mar. 10		
Modern Living, California Style (Maurice Sands).....	Mar. 13		
Architecture Is a Fine Art (John S. Bolles).....	Mar. 14		
Choice of Building Site (Raymond D. Smith).....	Mar. 16		
Period Influence in the Modern House (Paul R. Williams).....	Mar. 18		
The Modern House (Pietro Belluschi).....	Mar. 20		
Contemporary Decoration (Frances Elkins).....	Mar. 23		
Textiles (Dorothy W. Liebes).....	Mar. 24		
A Garden to Live In (Edward C. Williams).....	Mar. 26		
Your House and the Architect (Wm. C. Ambrose).....	Mar. 29		
House, All Metal Intermountain, Denver (C. L. Brun).....	June 26		
Houses, Good Wood (L. V. Teesdale).....	June 9		
Housing—Aluminum House, England.....	Dec. 10		
Housing, Ping Yuen, Chinatown, S. F. (Mark Daniels).....	Jan. 21		
Housing, Solving It in England.....	Feb. 12		
Housing, Veterans' Co-operative Plan Exhibit (R. G. DeLappe).....	June 22		
Housing for the Skymasters (Clifford Smart).....	July 12		
Housing, British Postwar—Braithwaite and Orlit Houses.....	July 22-29		

I

Interior Decoration, Home of Floyd McCall (Margaret M. Tee)	June 16
Interior Decoration, Living Room, H. S. Robinson (Frances Elkins and Dorothy W. Liebes).....	April 8
Interior Decorating — Superstition and Color in (Dr. W. Schwesheimer)	Dec. 9

K

"Kennedy Case," Supreme Court Decision	Aug. 21
Kraffile Co. "Packaged" House.....	Oct. 34

L

Landscaping:

House and Garden Relationship (Thos. D. Church).....	Mar. 10
A Garden to Live In (Edw. C. Williams).....	Mar. 26
Cheerfulness in Living (Allan H. Reid).....	April 14
Garden and the House (Hildegard Boeninger)	May 26

Landscape Architecture:

Calif. Grammar School, Colusa (Wm. J. Gregg).....	May 18
Residence Patio, Menlo Park.....	May 20
Outdoor Municipal Theatre (R. Von Wetter).....	May 21
Steps and Walls (Thos. D. Church).....	May 22
Landscape Architecture (Eckbo, Royston & Williams)	Sept. 11

M

Model for Rebuilding City of Portsmouth, England	Jan. 13
Model for Rebuilding City of Coventry, England.....	Jan. 14
Modular Design, Comments on (Chas. Cressey)	June 28
Municipal Building, Fresno.....	April 11

O

Office Building and Bank, Casablanca.....	Feb. 17
Office Building, Morocco	Feb. 17
Office Buildings, Pac. Telephone & Telegraph Co., Van Nuys, Hayward, Los Angeles, San Francisco, Redwood City, Seattle, Newport Beach	July 12
Office Building, London Elec. Ry. Co., 1st Floor Plan.....	July Cover
O.P.A. Price Adjustments.....	April 26
Oregon's Boom Region, Pay as You Go Plan (Arthur W. Priaulx).....	Sept. 24

P

Paint Removers, Some Health Hazards (W. Schweisheimer).....	July 11
Painting Walls and Ceilings.....	April 27
Park, Brisbane Lagoon (Edw. C. Williams).....	Sept. 22
Peninsula of San Francisco (Mark Daniels).....	Dec. 14
Planning, Urban Program.....	July 10
Prefabricated House, Progress in Design for Lincoln Welding Foundation	Dec. 8
Price-Wage Issues Meet by Assoc. Genl. Contrs.	Aug. 11
Producers' Council Page	Jan.-Dec. 38
(Vic Anderson, R. J. Fuite, Joe Carlson, Wm. Collier, Floyd Jennings, V. R. Reynolds, Otis Winfield, Mr. Or Equal, Wayne Rawlings, C. T. Halsted)	
Public Works, Postwar California Program	July 22

Q

Quonset Multiple Houses	June 21
-------------------------------	---------

R

Radar	Sept. 28
Radar is Not New.....	Dec. 24
Rebuilding London's Homes (Thomas Hodges).....	Dec. 23
Reclamation, California's Stake in National (H. W. Bashore)	Feb. 10
Reference Frames in Space (R. M. Schindler)	April 10
Remodeling a Community (Irwin M. Johnson)	June 12
Research Laboratory, Shell Development Co.....	May 14

Residences:

A Berkeley, for Modern Living (H. H. Gutterson).....	Jan. 10
H. C. Bradley, Jr. (Whitney R. Smith)	Jan. 19
Louis Bradley, Santa Monica (John W. Byers)	Oct. 12
Wm. Boeckel, San Mateo (John E. Fennacy).....	Sept. 18
Kemper Campbell, Victorville (John W. Byers)	Oct. 21
Cottage at Carmel (Engelo Hewetson).....	Feb. 9
Ignacio del Valle, Saugus.....	Oct. 14
E. P. Gilmore, Rancho La Brea.....	Oct. 15
Mr. and Mrs. Geo. E. Madding, Hillsborough	Dec. 18
Curtis Peck, San Fernando (John W. Byers).....	Oct. 16
P. G. Winnett, Santa Monica.....	Oct. 18
Vikingsholm, Lake Tahoe (Lennart Palme).....	Jan. 22
E. W. Zimmer, Santa Monica (John W. Byers)	Oct. 19
Residences, A Group of Small (Chester H. Treichel)	Feb. 14
Residence, The House I Want.....	Mar. 7
Residence, G. I. Wingfoot, Prefabricated.....	June 10
Restaurant, Iceland, N. Y. (Kaj Velden).....	Mar. 3
Running Fire (Mark Daniels).....	Feb. 4

S

Service Station, Los Angeles (Wm. F. Hempel).....	Jan. 8
School, Ross Grammar (Carl F. Gramme).....	Sept. 21
School, High, San Mateo.....	Dec. 14
School, Burlingame High	Dec. 15
Shell Development Building, Emeryville, Research Laboratory, Housing for Scientists, Laboratory Bldg., South Laboratory Bldg. (Allison & Rible).....	May 14
Steel, Developments for Building Construction (C. F. Block)	Jan. 18
Steel Boilers, Residential and Commercial, Code for Rating	May 23
Store Bldg., Merchandise Mart, S. F. (L. J. Hendy)	Jan. 12
Store Bldg., Cornell's Furniture, Los Altos (Lawrence Gentry).....	May 24
Store Building, Joseph Magnin Co., Sacramento (Gruen & Krummeck)	Dec. 12
Store Building Redwood City	Dec. 17
Store Bldg., by Pietro Belluschi.....	June 19
Studio Bldg., Santa Monica (John W. Byers).....	Oct. 20

T

Telephone Company Building Program, West Coast	Aug. 12
Textile Exhibition, Art in Action Shop, City of Paris	Oct. 8
Textiles and Potteries, Art in Action Shop, City of Paris	Sept. 8
Theatre Bldg., Fez, Morocco.....	Feb. 19
Transport Headquarters, St. James Park, London.....	July 19

U

University of California Stern Hall Decoration (Frances Elkins).....	April 9
University of California, Santa Barbara College (Winsor Soule).....	April 12
University of London, New Buildings in Bloomsbury	July 18

W

War Memorials, Era of (L. M. Grabow).....	Mar. 6
War Memorials, Columbus Memorial Light House—Dominican Republic.....	May 12
War Memorials	Oct. 29
Western Air Line Facilities Los Angeles Airport	July 12
Window Boxes (Albert Wilson)	Oct. 10

