

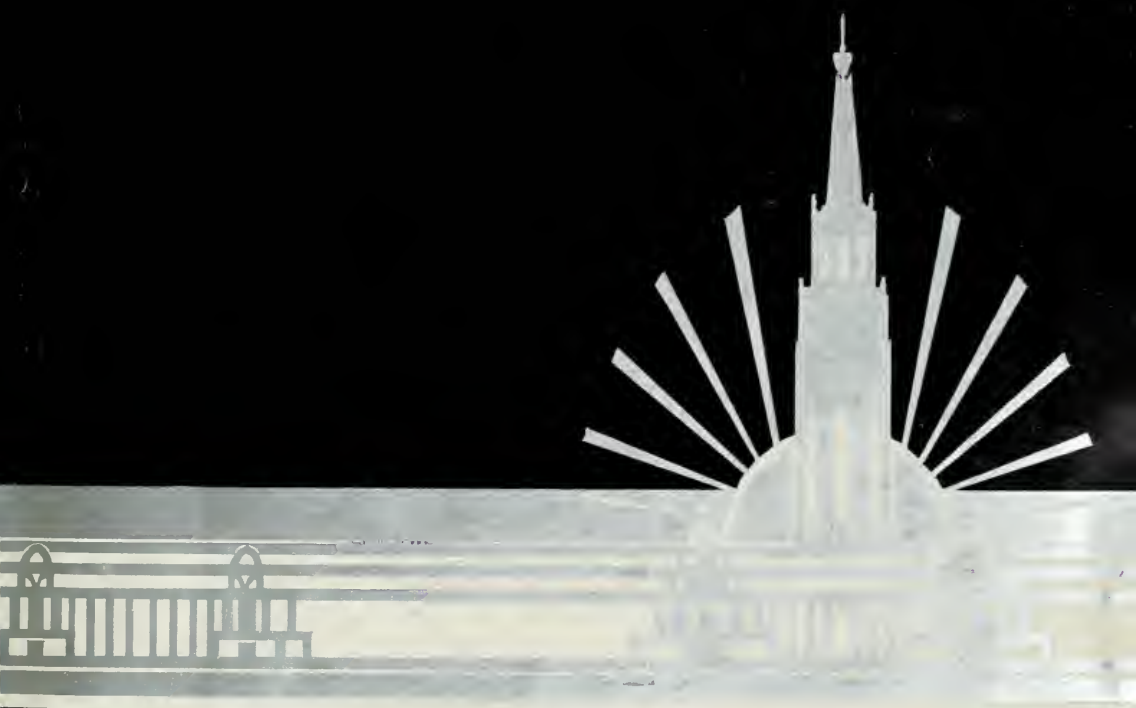



ARCHITECT AND ENGINEER



APRIL 1939

MARK DANIEL'S "RUNNING FIRE"—PAGE 1

FIRE RESISTANCE—STRUCTURAL STRENGTH SOUND AND THERMAL INSULATION

**For Buildings at
PALOMAR MOUNTAIN..**

*... All in ONE Material
at a Moderate Cost!*

Grouped around the observatory at Palomar Mountain are the superintendent's residence, the power plant, and five cottages. The relative isolation made it desirable to use a fire-resistant material for these buildings. So also was the need for structural strength, in case Mother Earth should become restless. Sudden changes of temperature on the mountain top made thermal insulation desirable. Quiet was desired by the staff, so sound insulation was a consideration.

All these advantages were found in Thermax—a slab form structural material made of clean shredded fibres coated and bound with fire-resistant cement. This one remarkable material offers fire resistance, structural strength, sound and thermal insulation—all at one moderate cost!

Thermax structural insulation is furnished in large rigid slabs of 1", 2" or 3" thickness. It is equally well suited for partitions, ceilings, roof decks, or flooring—forms an ideal base for plaster or stucco. Left exposed on ceilings, it also has high sound-absorption efficiency.

Thermax units are widely used in fire-proof construction and are approved by building departments of leading cities in the United States and Europe. Classified by Underwriters' Laboratories, Inc. Write today for detailed information.

The word Celotex is a brand name identifying a group of products marketed by The Celotex Corporation and is protected as a trade mark shown elsewhere in this advertisement.

Upper view shows superintendent's residence under construction; below, same building completed. At left, another Thermax-insulated building near Mt. Palomar Observatory. Architect: R. J. Batchelder.

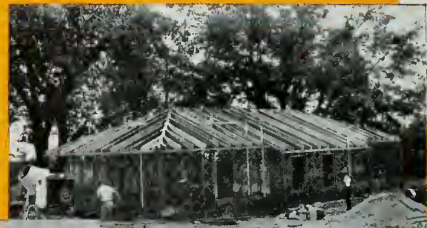

Copyright 1929, The Celotex Corporation

THE THERMAX

STRUCTURAL INSULATING SLAB BY

CELOTEX World's Largest
Manufacturer of Structural Insulation

RUNNING FIRE

by
MARK DANIELS, A.I.A.

An Old Game

It looks as if Germany and Italy have taken a page from our book of labor. England and France are in about the same position in relation to the Fascist-Nazi axis as the American employer finds himself confronted with by the A. F. of L. and the C. I. O. "Step on his toes," says the Fuehrer, "and when he looks down I'll kick him in the pants. When he looks back of him, you kick him in the shins." It's an old trick, learned in the sand lot, baiting the fruit peddler and dodging the cop. Hitler and Mussolini are a bit amateurish at the racket but they are learning fast—very fast.

Events of the last few days show clearly that the friendly enemies of the axis have been observing the strategy of their American exemplars more closely. When our employers get kicked numb in the Western exposure by the C. I. O., the A. F. of L. starts working on our Atlantic shins. When der Fuehrer gets through slapping the French in the allies, Mussolini kicks England in the Albania. It's a great game and if the H. and M. combine observes closely the tactics of our labor organizations in the United States, they can't fail eventually to get the old man down.

Of course, there are different measures of defense against such methods. One is to sign treaties when the pain makes you feel that you are carrying the shins of the world on your shoulders. Another is to take it out on your friends. If England had another real one she might exile her Prince of Wales, and cry to Hitler, "Now see what you went and made me do!"

Sanctions, too, are steps that can be taken. This principle also takes root in the sand lot. We are all familiar with their interpretation. Stript of all metaphor a sanction is the same as saying, "Do that again if you dare." Lacking a good king and prince to exile, as a further sanction it might be suggested the British threaten to give them Halifax.

But every cloud has a silver lining. In these tragic hours, while Hitler threatens Holland and Belgium and while rulers with outnumbered armies are Zogging to safer capitals, Mussolini warns that

the Mediterranean shores shall ring with Fascist anthems.

England takes a backward glance about 200 years in history (recent for her) and hands us the reassuring statement that Corfu shall not ring tonight.

★ ★ ★

Egg Money

The papers had been drawn, title search completed, deeds signed, and all documents put in order for the transfer of the famous Wikiup ranch in Sonoma county from the estate of the late John Rossiter to Mrs. Helen M. Smith. All was in readiness for the signature and the negligible detail of a cheque from Mrs. Smith, both to be produced at the San Francisco bank at 9:00 o'clock of a certain morning.

Mrs. Smith and her brother Lucien live on their other ranch, not far from Wikiup, near Santa Rosa, about one and a half hours from San Francisco, so they arose at six A. M. in order to be prompt. As they drove out of the garage they discovered that neither had a penny—not enough to pay bridge toll. Incredible but true, for that's the way with people who buy million dollar ranches.

Always resourceful, Lucien dashed up to the eggery and came back with six dozen eggs. Banks and stores were closed, but the kitchen of a hotel they supplied with eggs was not, and the proceeds of six dozen eggs would pay the toll. The eggs were delivered, a receipt taken and presented to the cashier. As he was about to pay over the money, the chef came up and started an argument about the size of the first dozen. It began to look as if the receipt would not be cashed, that the toll money could not be got in time and that the million dollar deal would be off unless all parties to it could be brought together another time. Lucien Matthews was in a fix, for this was the first time either he or his sister had delivered eggs in person.

Suddenly the door from the office burst open and a man with disheveled hair rushed in waving a local newspaper. The eight column spread headline announced the purchase of the Wikiup ranch by Mrs. Helen M. Smith. The excited man was the proprietor. He was a

smart man. He could put 2 and 2 together and get anything from 2 to 8. He had recognized the delivery boy. He had read the names. "Taka dos eggs, I say. Taka dos eggs. Pay queek, pay queek," he shouted, waving the paper. As Lucien went out with the money he heard—"buy a da Rossiter ranch, wana million dollar! Sacre!"

The toll was paid, the papers signed, the title transferred and, I suspect, Tony, the proprietor, now gets his eggs oversized and at a discount.

★ ★ ★

A Confession

If all this sounds a bit hard boiled I'll tell you why.

Yesterday (Easter Sunday) I was in the country. For months I have worked 16 hours a day, except on Sundays. On Sundays I have worked 18 hours. Yesterday I decided to go out in the world and see if there still were any fields, or trees, or birds, or lizards, to say nothing of rabbits and easter hats. The world was going to the devil anyway, in spite of my herculean efforts to save it. I had warned Hitler in this column that if he got too active the limelight would shift from Mussolini and there would be the devil to pay. Now see what's happened. Lewis, Merriam, Hearst and so on down the line were warned but I guess they don't read English, so I went into the country.

Cows were chewing cud, knee deep in alfalfa, trees were bursting into bloom, birds were making nests, bees were busy, meadow larks were singing, white oaks were flirting spring dresses, farmers were disking clean smells from the earth and fish were getting big enough to jump. Now I am back where the air has all been used once, where Market Street sounds like nine battle fronts and where my typewriter sticks at every line.

It's a dog's life.

★ ★ ★

What is a House?

In the past days of domestic architecture there was little distinction made between a house and a home. We used the two terms interchangeably. Not that we were ignorant of philology but if the

(Turn to Page 73)

*720.5 137
Ar 24

483979

The Architect & Engineer

Fred W. Jones, Editor

Mark Daniels, A. I. A., Associate Editor

Edgar N. Kierulff, Assistant Editor

CONSULTING BOARD OF EDITORS

Architectural—

- Arthur Brown Jr.
- Frederick H. Meyer
- Timothy L. Pflueger
- Will G. Corlett
- Harry Michelsen
- John J. Donovan
- Lewis P. Hobart
- David C. Allison
- Gordon B. Kaufmann
- Harris C. Allen
- Glenn Stanton
- Paul R. Hunter
- C. H. Alden

Engineering—

- H. J. Brunnier
- L. H. Nishkian
- William Adrian
- Wm. H. Popert
- Homer N. Hadley
- John J. Gould
- Geo. E. Atkins

Business Manager—

- L. B. Penhorwood

Advertising Manager—

- J. Leslie Meek

Architects' Reports—

- Vernon S. Yallop

THE ARCHITECT AND ENGINEER, INC., 68 Post Street, San Francisco, EXbrook 7182. President, K. P. Kierulff; vice-president, Frederick W. Jones; secretary, L. B. Penhorwood. Los Angeles office, 832 W. Fifth Street. Published on the 12th on each month. Entered as second class matter, November 2, 1905, at the Postoffice at San Francisco, California, under the Act of March 3, 1897. Subscriptions, United States and Pan America, \$3.00 a year; Foreign countries, \$5.00 a year; single copy, \$.50.

Contents for April, 1939

Frontispiece

OUTDOOR FIREPLACE BY WM. CLEMENS AMBROSE, ARCHITECT 16

Text

EXHIBITIONS STIMULATE PUBLIC INTEREST IN ARCHITECTURE 17

SOME HIGH SPOTS IN STORE PLANNING 23
Albert R. Williams, Architect

A WORLD'S FAIR BANK BUILDING 32

A PRIVATE OFFICE IN CHINATOWN 36

MOTION PICTURE EXPOSITION 36

HALF CENTURY OF ARCHITECTURAL PRACTICE 39
Alfred F. Rosenheim, F.A.I.A.

ARCHITECT VISUALIZES THE SAN FRANCISCO OF TOMORROW 44
B. J. S. Cahill, Architect

NOISE AND WHAT SCIENCE IS DOING TO CORRECT IT 47
Harry W. Perry

ELEVATED HIGHWAYS ONLY SOLUTION TO TRAFFIC CONGESTION 50

Plates and Illustrations

HOUSE FOR MRS. ESTHER THATCHER 17
Michael Goodman, Architect

RESIDENCE OF ROBERT B. MITCHELL 18
Miller & Warnecke, Architects

HOUSE FOR MR. AND MRS. H. T. HOWARD 20
H. T. Howard, Architect

RECREATION POOL AND BATH 21
Leo J. Sharps, Architect

HOUSE FOR BENJAMIN FOLLETT 21

FOWLER ELEMENTARY SCHOOL 22
C. H. Franklin and Ernest J. Kump, Jr., Architects

STORE AND OTHER BUILDINGS BY WILLIAMS & GRIMES, ALBERT R. WILLIAMS, ARCHITECT 22-31

WORLD'S FAIR BANK BUILDING 32-35
L. J. Hendy, Architect

DESIGN FOR MOTION PICTURE EXPOSITION 37

PRIVATE OFFICE IN CHINATOWN, LOS ANGELES 38
Webster & Wilson, Architects

HOLLENBECK JUNIOR HIGH SCHOOL, LOS ANGELES 41-43
Alfred F. Rosenheim, Architect

NEW JOBS AHEAD

The smartest trend in wall tiling in twenty years!

WASTELANDS in '37. So smart it has a new vogue in wall tiling! Some Master Kraftfiles are 6 x 9 in. They make possible bathroom and kitchen walls with an utterly new beauty... the ages-old luxury of colorful ceramics, in the best modern simplicity and taste!

And they've a power that's sheer gold! Due to their greater size and naturally ideal proportions, they actually create the illusion of spaciousness! Even the tiniest appears more roomy in these lovely 6 x 9's.

Can you picture your new kitchen and bathrooms with gleaming walls of this gorgeous tile? Walls that can clean with merely water? Walls that are acid and ink proof, cigar burn proof, vermin proof, and fire proof. And most important,

dampness proof and steam proof! Walls that will always look brand new, and should never cost you a penny in refinishing!

Only last year, these everlasting Master Kraftfile 6 x 9's were a luxury known only to the most costly homes of the West. At today's reduced prices, they can be afforded in homes of \$5000 and even less.

You've a choice of soft, sunlit colors inspired by Western scenic colorings. Some are pictured here, others include San Gabriel Yellow, Sierra Sky, Nevada Inn, Del Mar Pink, Shasta White and dozens more... each deeply fired into

everlasting tile at the famous Kraftfile Kilns at Niles, California.

Ask your architect or tile dealer to feature on Master Kraftfile 6 x 9's. Write for free folder "Kraftfile Ideas for Kitchens and Bathrooms."

MASTER KRAFTFILE 6 x 9's

SUNSET MAGAZINE

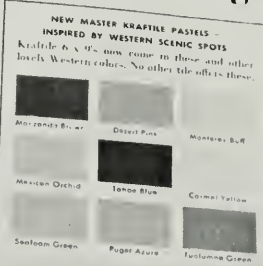
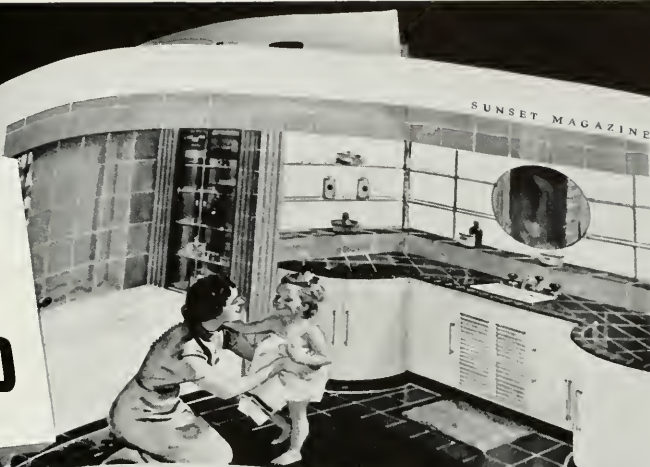

NEW MASTER KRAFTFILE PASTELS - INSPIRED BY WESTERN SCENIC SPOTS
Kraftfile 6 x 9's now come in these and other lovely Western colors. No other tile offers these.

FREE to those planning to build (or remodel) "Kraftfile Ideas for Kitchens and Bathrooms."
KRAFTFILE COMPANY—Niles, California
Please send free, your new folder "Kraftfile Ideas for Kitchens and Bathrooms."

Name _____
Address _____
City _____ State _____
None of Above _____

IN A SERIES of advertisements appearing in *Sunset* magazine, smart Master Kraftfile bathrooms and kitchens, designed by well-known West Coast architects, are reproduced in beautiful color. Their purpose is to whet people's appetite for new homes, to stimulate new building. The wisdom of this Kraftfile job-creating policy is already

evidenced by hundreds of inquiries now pouring in from prospective home builders. Kraftfile Company will gladly cooperate with architects, contractors and tile dealers interested in converting this new home desire into actual contracts. For details, simply mail coupon.

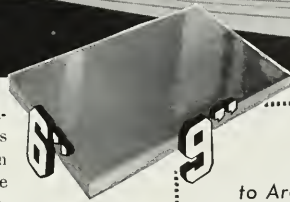

FREE

to Architects and Builders

KRAFTFILE COMPANY—Niles, California
Please send me information on your "New Jobs Ahead" program of cooperation with architects, contractors and tile dealers.

Name _____
Address _____
City _____ State _____

MASTER KRAFTFILE 6 x 9's

GARDEN PLANNING

By **BERNIECE ASHDOWN**

Landscape Architect

THE first essential to a well ordered garden is design. Its function is to make the most of every nook and corner, emphasizing its charms by pointing out its finest vistas and minimizing any objectionable features.

Good landscaping is no haphazard affair, but the result of careful planning. The method too often followed of buying new plant material, then calling a family council in the back yard to decide upon its location, invariably results in a restless deranged garden.

No landscape plan will suit any two places, since every situation presents its own par-

all times should be easily accessible. The entrances should be treated so as to give the finest possible impression at first glance.

Gardens should be comfortable. Areas should be provided which will be dry enough to use in wet weather and comfortably warm in the colder seasons, as well as areas designed to be cool on warm sultry days.

There should be at some good focal point a bench, comfortable and inviting. (See illustration.) If the location is too sunny, it should be provided with the shade of a tall growing tree, shrubs or perhaps a trellis of roses.

Privacy is of paramount importance. In order to fully enjoy living in one's garden it is necessary to feel that it is completely

careful thought given to color harmony, leaf texture, contrasts, as well as to extended blooming season.

Simple flower beds and pools, rectangular in shape and with plain straight edges, are usually best.

A great many things, bewildering to the amateur, have been said about axis. By axis we mean an imaginary line which passes through a design and in relation to which are arranged the various features of the garden. A simple rule to follow is to center your points of interest in the garden on an axis line with the most prominent feature of its surroundings. For example, if the garden adjoins the living room where French doors or a large window look out upon it,



BENCH IN GARDEN OF LYNN ATKINSON, LOS ANGELES

Frank Baden, Designer

ticular problems. The design and planting should fit in harmoniously with the style of the architecture and contour of the surrounding country. The simplified, streamlined architecture of today, for example, requires a different landscape treatment than the lavish rambling architecture of twenty years ago; a steep hillside location, a different treatment than a flat lot or one with gentle slopes.

A garden should be an extension of the living quarters into the out-of-doors, and at

secluded from public gaze. This can be accomplished by using hedges, walls, vine-covered fences or shrub groups.

Simplicity is the keynote of success. Always, a garden should give the impression of calm peaceful spaciousness, where there is room to move about freely. Plant material should be subordinated to living space.

Nothing has more charm than an open, well kept lawn properly bordered with shrubs, trees and flowers. The planting should be massed into regular groups and

arrange the line of axis from the center of the window or doors so that the garden picture will be focussed from that point and will look its very best from that vista.

If your garden possesses a lovely view, by all means take advantage of it. Don't plant anything where it will obstruct the view. On the other hand, if the views are objectionable, carefully block them out with proper planting.

Artificiality should be avoided. It is wise
(Turn to Page 75)

NEW YORK LIFE GETS INSURANCE AGAINST FLOOR TROUBLES

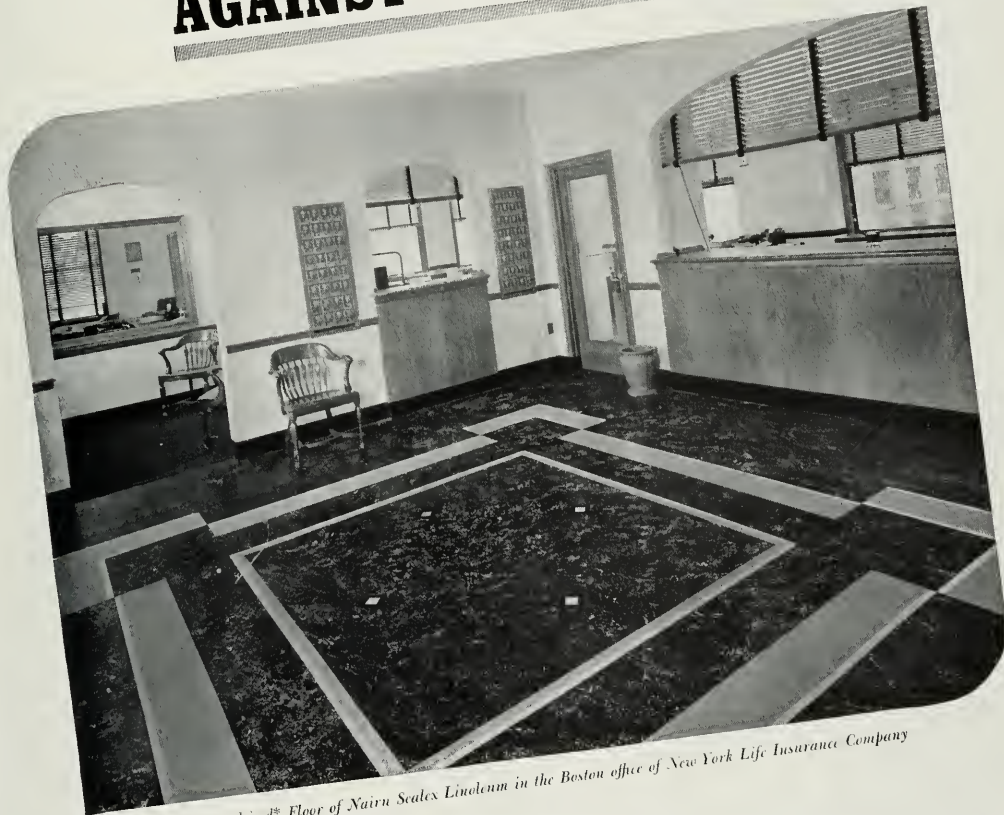

An attractive Personal-ized* Floor of Nairn Sealex Linoleum in the Boston office of New York Life Insurance Company

NAIRN
TRADEMARK REGISTERED
LINOLEUM
Floors and Walls

Nairn Sealex Linoleum assures quiet, easy-to-clean floors . . . years of heavy duty service with no costly maintenance

The architect likes the wide decorative scope offered by Nairn Sealex Linoleum . . . 13 different Plain Color and Veltone (marbleized) patterns—plus ready-cut Nairn Insets, Feature Strips and Borders which can be combined into smart Personal-ized floors following your own specifications.

And owners like the practical advantages. A quiet, resilient floor which is easy to clean and inexpensive to maintain!

Installed by authorized contractors, Nairn Sealex Linoleum is fully guaranteed. Write for free samples now!

CONGOLEUM-NAIRN INC., KEARNY, NEW JERSEY

*Trademark Registered



BEAUTY WITH ECONOMY

WITH LAUX REZICOTE, architects bring the beauty touch to brick, cement, tile and stucco surfaces—at surprisingly low cost. This superior synthetic resin paste paint has been used on the Fox Westwood Village theater with striking results. And with REZICOTE beauty goes economy—low cost, no expensive thinner, no special preparatory steps. Not only are first costs lower, but tough, elastic REZICOTE surfaces will stand up under any weather—sun, rain, wind or salt air.

Learn the whole story of Laux Rezicote—and of the entire Laux line of paint specialties. Write Laux Sales Co.: Seattle; Los Angeles; Oakland; Dallas; Phoenix; Portland, Ore.; Minneapolis; Lockport, N. Y.; Portsmouth, Va.

LAUX

PAINT PRODUCTS

The Beauty Line: VELLO, (Superior Wall Finish), REZICOTE, REZ, REZITEX, LAUXLITE, PLASTEREZ, LAUXTINT



*A service for you
...and your clients*

As the national leader in FHA financing, Bank of America's interest in better housing coincides with that of the architect and the engineer. Finer design and better construction mean a sounder investment for the home owner, a more satisfactory loan for the bank. Your interests, as well as those of your clients, will receive the friendliest consideration at Bank of America.

Bank of America
NATIONAL SAVINGS ASSOCIATION
Member Federal Deposit Insurance Corporation



PRESSURE TREATED LUMBER
● **PROTECTS AGAINST DECAY
AND TERMITE ATTACK**

*Specify it in your home
Available through Lumber Dealers*

LOS ANGELES
601 W. 5th Street
Phone MIchigan 6294

SAN FRANCISCO
333 Montgomery Street
Phone DOuglas 3883

J. H. Baxter & Co.

AGENTS FOR WEST COAST WOOD PRESERVING CO., SEATTLE, WASH.

Any Building lasts long enough to need the extra endurance of **U·S·S COPPER STEEL DUCTS**

THE life of any modern building is long enough to warrant the best duct that can be obtained at reasonable cost. For air-conditioning ducts are subject to the constant ravages of corrosion. Humidified air and condensation attack them night and day. And when duct work is eaten away by corrosion, it's costly to replace. That's why it is important to select materials for this construction with special care.

Built of U·S·S Copper Steel Sheets, duct-work costs but slightly more . . . and its useful life is greatly increased. Metallurgists long ago discovered that only a little copper added to molten steel imparts superior rust resistance. And 22 years' experience with copper steel construction has proved this to be true.

Because U·S·S Copper Steel Sheets are ductile, they can be easily fabricated. Installation time is cut down. Substantial savings in labor costs result.

Measured in terms of service, U·S·S Copper Steel Sheets give double value. Prove their superiority on your next job. There are many places on any type of building where they can mean greater economy for your clients. Use them to prolong the life of duct-work, roofing, gutters, down-spouts and flashings. U·S·S Copper Steel Sheets, either plain or galvanized, are available for quick delivery in all important cities.



READY TO GIVE EXTRA LIFE, is this air-conditioning system in a modern home. Trunk line, risers and hosing are of U·S·S Copper Steel Sheets. And notice their attractive contours, due in large measure, to the easy workability of the sheets used.

U·S·S COPPER STEEL SHEETS

COLUMBIA STEEL COMPANY, San Francisco

CARNEGIE-ILLINOIS STEEL CORPORATION, Pittsburgh and Chicago

TENNESSEE COAL, IRON & RAILROAD COMPANY, Birmingham

United States Steel Products Company, New York. Export Distributors



UNITED STATES STEEL



Photo by Garnett

RESIDENCE OF MR. AND MRS. HARRY A. MAYHEW, PASADENA
Harold J. Bissner, Architect

A Lovely Southern California Home in a Grove of Natural Landscaping

LOCATED high on the side of a gentle slope, the Mayhew residence commands a picturesque view of the Arroyo Seco and surrounding hills. Beauty of the house is further enhanced by its setting, a grove of natural landscaping.

The exterior construction is of redwood boards, whitewashed, while the interior convenience and comfort appear to have been carefully planned. Forced air

gas heating provides immediate warmth, and a storage gas water heater gives automatic hot water supply. In the kitchen is a modern gas range and Electroflux gas refrigerator.

Outstanding feature of the combination living and dining room is the authentic old Colonial fireplace with its built-in warming ovens.

OLD COLONIAL FIREPLACE
IN LIVING ROOM



THE KITCHEN, SHOWING GAS REFRIGERATOR
ON LEFT AND GAS STOVE ON THE RIGHT

HOMELIKE



**... IN THE MODERN
ALL GAS MANNER**

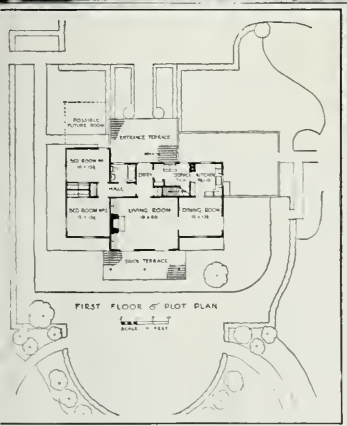

Left — Unique in its combination of compactness and flexibility (with provision for future addition of a room), this floor plan matches exterior charm and simplicity.

Dignified simplicity, “free-moving” plan, efficient utilization of space—these factors won national recognition for this residence designed by Architect W.W.Wurster for Mr. R. R. King, Atherton, California. ☆ Winter comfort is assured by a gas warm air furnace that runs itself. Hot water flows at the turn of a faucet—its dependable source, an automatic gas water heater. Cooking becomes a gay adventure with the smart gas range that keynotes a homemaker’s dream of a kitchen. ☆ Prominent mention of gas appliances in your specifications is another way of saying “Modern, economical, complete.”

★ ★ ★
SAN FRANCISCO FAIR VISITORS — See the fascinating, \$150,000 Gas Exhibit on Treasure Island, located in the Homes and Gardens Palace.

LET GAS DO THE 4 BIG JOBS

HEATING COOKING REFRIGERATION

PROOF *of the* PUDDING

Daily occupancy is the relentless test of a building's efficiency. Under this test the weaknesses in planning stand revealed.

Nowhere is inefficiency so quickly apparent and so constantly irritating as in inadequate electrical wiring.

Any commercial building especially, must have a wiring system so comprehensive that the electrical demands of a wide variety of tenants can be met. Wiring changes after a building is completed are expensive. They are unnecessary if the original wiring system is sufficiently extensive and properly installed.

If the useful life of the building is to continue over a reasonable period of years, that usefulness must not be strangled by inadequate wiring. Allowance must be made for the constantly increasing use of electrically driven office equipment.

•

*See the electrical exhibits at the Palace of
Electricity and Communications at the
Golden Gate International Exposition*

•

PACIFIC COAST ELECTRICAL BUREAU

447 SUTTER STREET • SAN FRANCISCO, CALIFORNIA

SAN FRANCISCO CHAPTER MEETING

The regular monthly meeting of the Northern California Chapter, A.I.A., was held at the St. Francis Yacht Club Tuesday, March 28, President James H. Mitchell presiding.

Announcement was made of the election to Associateship of Messrs. Mario J. Ciampi and Winfield Scott Wellington.

Mr. Mitchell introduced the guests for the evening: Carl I. Warnecke of Oakland, who later spoke on Large Scale Housing in the Oakland district; Paul A. Ryan, member of the Art Commission of San Francisco; Edgar I. Bissantz, vice-president of the Southern California Chapter, and Loring Rixford.

The president reported that the Board of Directors had discussed the reinvestment of the Educational Fund, and that the San Francisco Federal Savings and Loan Company had seemed to them the logical institution, since depositors in this organization are protected by Governmental insurance.

On motion of Mr. Stringham, seconded by Mr. Jeans, the matter was left to the discretion of the Board of Directors.

Mr. Mitchell told of the proposed shrine to Czechoslovakia to be built at the Golden Gate International Exposition, and the request that architectural service for the building be furnished gratis by the Chapter. After considerable discussion, consensus of opinion was against the furnishing of free architectural service.

Announcement was made of a proposed lecture to be given by Sir Raymond Unwin, R.I.B.A., some time in April.

A joint meeting of the State Association of California Architects and the Chapter was suggested to receive Leigh Hunt of the Board of Directors of the A.I.A. Mr. Hunt is particularly interested in State Associations and has been very active in the formation and furtherance of these organizations.

The proposal that architects require a list of sub-contractors to be submitted with each bid for a general contract, and that the acceptance of the listed sub-contractors by the successful general contractor be enforced was presented.

On motion of Mr. Meyers, seconded by Mr. Haas it was voted that the practice of requiring a list of sub-contractors to be submitted with each bid for a general contract, and that the acceptance of the listed sub-contractors by the successful general contractor be strongly recommended to all members of the Chapter, and that a copy of the motion be sent to Wm. H. George of the Builders' Exchange.

The meeting was then turned over to Mr. Allen, who conducted a discussion on "Large Scale Housing."

Albert J. Evers told about the administration of the San Francisco area, and the procedure necessary to the ultimate completion of a housing project. He also discussed several sites in San Francisco and described the projects already under way.

—J. D. Y.

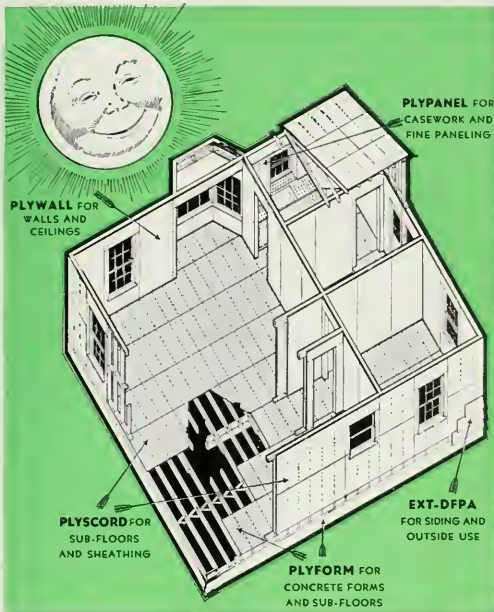

There was a
word for it
3000 years
ago . . .

Now we call it
dri-bilt
WITH PLYWOOD

**Standardized home construction
made practical by this method!**

Based on the use of floor mats of standard sizes, the Japanese developed a very practical grid system of dry-built construction 3000 years ago.

Now there is a modular plan of building keyed to modern times. It uses one of the most versatile of all modern materials . . . *Douglas Fir Plywood*, which is real lumber made larger, lighter, stronger. This new plan is ideal for every size and style of American home. *It is called Dri-Bilt with Plywood.*

The standard size of Douglas Fir Plywood panels is 4'x8'. By basing room sizes on multiples of 4' and using the proper grades of these big laminated panels for sheathing, sub-flooring, exterior siding, interior walls and ceilings, built-ins and even concrete forms. *substantial reductions can be made in*

building time—in labor, too. And your client gets so much more house for his money!

The Dri-Bilt with Plywood method reduces cutting, fitting and nailing to a minimum. It slashes building and supervisory time as much as six weeks because walls and ceilings are bone dry from start to finish. It gives you a more rigid, more durable house—one whose exterior walls are six times stronger than when horizontal board sheathing is used . . . one whose interior walls are puncture-proof and receptive to any finish.

You'll find it easy to specify the right grade of Douglas Fir Plywood for every purpose, because every panel is now "grade trade-marked." Study the trade-marks below. They make identification easy. Sweet's Catalog contains complete data on Douglas Fir Plywood. For special new information on the Dri-Bilt method, send coupon below.

F. H. A. has accepted Douglas Fir Plywood for home construction. Its use is approved in Uniform Building Code.

**DOUGLAS FIR
PLYWOOD**
Real Lumber
**MADE LARGER, LIGHTER
SPLIT-PROOF
STRONGER**



SPECIFY DOUGLAS FIR PLYWOOD BY THESE "GRADE TRADE-MARKS!"

DOUGLAS FIR PLYWOOD ASSOCIATION, Tacoma Bldg., Tacoma, Washington
Please send me your FREE manual on Dri-Bilt with Plywood construction.

Name _____

Address _____

City _____ State _____



Horace H. Rackham School of Graduate Studies, Ann Arbor, Michigan. Smith, Hinchman & Grylls, Architects, Detroit. 97 Johnson room thermostats operating 231 Johnson valves on radiators. Six ventilation systems are Johnson-controlled also.

● In many of America's most modern new schools and public buildings—where efficiency and comfort must be combined—Johnson automatic temperature and air conditioning control apparatus is favored.

Why does Johnson apparatus please so many people? Why do cities that have had Johnson equipment for many years, depend upon "Control by Johnson", again and again, for new schools and public buildings? Johnson engineers can tell you, as pioneers in air conditioning control apparatus, that Johnson has modern devices, tried and tested, to satisfy every requirement. Too, Johnson service is direct. Every member of the Johnson sales and technical staff belongs to a nationwide organization. "Control by Johnson" may be specified with confidence.

SEE THE JOHNSON
CATALOG IN SWEET'S
SECTION 26

JOHNSON
AUTOMATIC TEMPERATURE AND HUMIDITY CONTROL
JOHNSON SERVICE COMPANY, MILWAUKEE, WIS., AND PRINCIPAL CITIES

4 REASONS
why
BUSINESS MEN
BANK BY MAIL

1. **Economical** because it saves their valuable time.
2. **Convenient** wherever they live or travel.
3. **Efficient**—overnight service to most points in California.
4. **Safe** as the U. S. Mails.

Write today...

for free Bank-by-Mail kit containing all necessary forms, return envelope and simple instructions.

CROCKER FIRST NATIONAL BANK
OF SAN FRANCISCO
California's Oldest National Bank

Member Federal Deposit Insurance Corporation

BID OPENING

Sealed Proposals, for the furnishing of all labor, material, transportation and equipment for the construction of the Western Regional Laboratory including a separate Service Building located on the south side of Buchanan Street between the Southern Pacific right of way and Taylor Street, Albany (Alameda County), California for the Bureau of Chemistry and Soils, U. S. Department of Agriculture will be received by the Chief, Division of Purchase, Sales and Traffic, U. S. Department of Agriculture, until 2:00 P. M., E. S. T., May 26, 1939. The portion of the Laboratory building for which bids will be required will be L-shaped, three stories in height with attic and full basement. The Administration Unit of this building is approximately 64'-0" x 207'-0"; the Chemical Unit of this building is approximately 63'-0" x 307'-0", both of reinforced monolithic concrete and masonry construction to meet earthquake conditions, steel sash glazed with heat-absorbing glass, built up roof, cement, tile, terrazzo and linoleum floors, steel stairs, passenger and freight elevators, mechanical ventilating units, and the necessary electrical, plumbing and heating connections and equipment. The service building is approximately 73'-0" x 93'-0" of reinforced monolithic concrete and masonry construction, to meet earthquake conditions; steel sash, built up roof, cement floors connecting tunnels, under ground concrete fuel tanks, boilers, pumps, motors and the necessary heating, plumbing and electrical connections and equipment. Award of the contract will be made only to a contractor who can show sufficient experience, financial resources, and who can execute performance bond of 100% of cost, and payment bond of 50% of cost, to insure the satisfactory installations of the work contemplated. Plans and specifications may be had upon application to the Chief, Division of Purchase, Sales and Traffic, U. S. Dept. of Agriculture, Washington, D. C. on deposit of \$50.00 per set. Reference must be made to U. S. D. A. #3165. Checks must be certified and made payable to the Treasurer of the United States. If drawings and specifications in possession of unsuccessful bidders are not returned to and received by the Bureau of Agricultural Engineering of the Department within 60 days after bids are opened, the deposits will be forfeited to the Government.

THE ARCHITECT AND ENGINEER

COLORFUL STORE FRONT

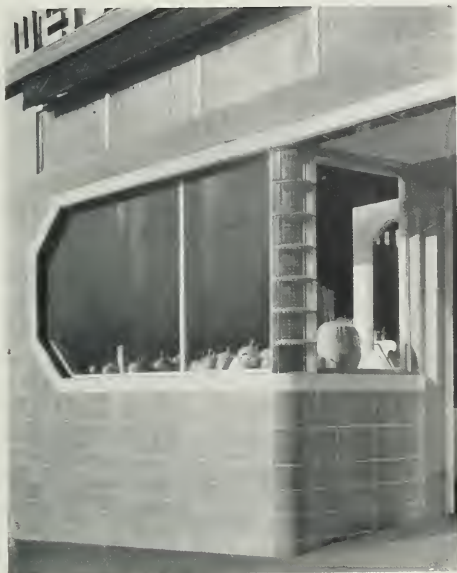

An interesting modernization project at Fillmore and Sacramento Streets, San Francisco . . . Houghton Sawyer, Architect . . . Scott Company, Tile Contractor . . . Six by nine Kraftile made possible this attractive market front design. A band and bullnose cap on the sills in Kraftile "Carmel Yellow"—almost a cream—sets off the windows and makes a pleasing combination with "Laguna Green," the predominating color.

BOYD LIGHTING FIXTURE CO.

Designers and Makers

**RESIDENTIAL
COMMERCIAL
THEATRE
LIGHTING FIXTURES**

DESIGNS AND ESTIMATES FURNISHED

Show Rooms and Factory

56 Twelfth Street, San Francisco

Phone HEMlock 4300

Recent San Francisco Installations

ROOS BROS., Market at Stockton Streets

LIVINGSTON BROS., Grant Ave. and Geary St.

OREGON CITY WOOLEN MILLS, Kearny and Post Streets

MORE BEAUTIFUL THAN MARBLE

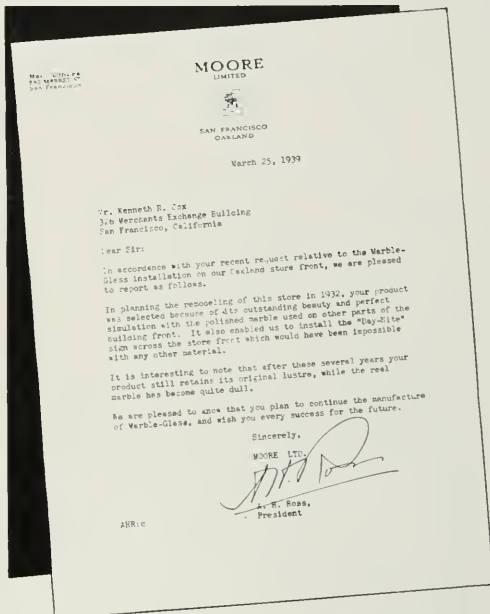

AFTER 7 YEARS

*"More Beautiful
than Marble," still!*

The ornamental design of Marble-Glass (a patented product) becomes an integral part of the glass. It cannot be injured unless the glass itself is broken.

As Mr. Ross, president of Moore, Ltd., writes above: *"It is interesting to note that after these several years your product still retains its original lustre, while the real marble has become quite dull."*

It is the *permanence* of the beauty of new Marble-Glass that permits every installation to be backed by a 50 YEAR WRITTEN GUARANTEE! Ask us for details and samples.

Some uses for MARBLE-GLASS:

Store fronts; corridors and vestibules; tables and counters; facing and tops for bars and fountains; restaurants; hotels; fireplaces; showers and bathrooms.

RUSS BUILDING
SAN FRANCISCO

TEL. SUTTER
8081

MARBLE GLASS CORPORATION

Q U I E T

THE CALM AND RESTFUL ATMOSPHERE OF THE MODERN RESTAURANT AND THEATER IS FAMILIAR TO ALL . . . THIS SAME BALM TO NOISE-SHATTERED NERVES CAN BE INCORPORATED INTO YOUR OWN HOME BY THE USE OF KALITE SOUND ABSORBING PLASTER.

KALITE'S EFFICIENCY IS CONFIRMED BY MAJOR ACOUSTICAL INSTALLATIONS ALL OVER THE NATION . . . SOUND CONTROL IS NOT EXPENSIVE THE KALITE WAY.

KALITE
U.S. COPYRIGHT

ACOUSTICAL AND INSULATING PRODUCTS

Another new development by

GLADDING, McBEAN & CO.

2901 LOS FELIZ BOULEVARD

LOS ANGELES, CALIFORNIA

SAN FRANCISCO • PORTLAND • SEATTLE • OAKLAND • SPOKANE • VANCOUVER, B. C.

A satisfied client

Roos. Bros., dealers of men's and women's apparel, have recently completed modernization of their California stores. The architect, Albert R. Williams, has installed in both the San Francisco and Fresno buildings of this firm —

STANLEY MAGIC DOORS

THE DOORS THAT **OPEN**
AT YOUR APPROACH AND
CLOSE AUTOMATICALLY

Read what the architects say about these magic doors:—

WILLIAMS & GRIMES - - ALBERT R. WILLIAMS, ARCHITECT
251 Post Street - San Francisco, California - Tel.: EXbrook 1557

The Stanley Works
Magic Door Division
New Britain, Connecticut

March 28, 1939

Gentlemen:

It may interest you to know that we are very much pleased with the several installations which you have made for us of the Stanley Magic Doors. In addition, our clients have been well satisfied as these magic doors not only attract customers but also help keep the ventilation under better control. Being comparatively new, many people have visited these stores out of curiosity to see the doors in operation.

Yours very truly,

Williams & Grimes
A.R. Williams, Architect

By *Albert R. Williams*
Albert R. Williams



Stanley Magic Doors in Roos Bros. store

Actuated by a beam of light, Stanley's Magic Doors offer the solution to traffic congestion, relief to bundle-laden shoppers, convenience to everyone.

STANLEY MAGIC DOORS
REQUIRE NO HAND TO OPEN



OUTDOOR FIREPLACE, COUNTRY ESTATE OF KENNETH HAMILTON, INVERNESS, CALIFORNIA
WILLIAM CLEMENS AMBROSE, ARCHITECT



HOUSE FOR MRS. ESTHER THATCHER, CARMEL, CALIFORNIA
Michael Goodman, Architect

EXHIBITIONS STIMULATE PUBLIC INTEREST IN ARCHITECTURE

THE half dozen photos shown here are from the recent Exhibition of Architecture at the San Francisco Museum of Art. Other work from this exhibition, not previously illustrated in *The Architect and Engineer*, will be shown from time to time. According to architects who participated in the display the public reaction has been most favorable, in fact some of the exhibitors are frank to attribute recent commissions to the publicity which this exhibition brought them.

On the opposite page is a picture of a fireplace which might well be called the "Outdoor Fireplace of the Month," and while on the subject of out of doors what a charming view above, showing another type of outdoor fireplace, this one more intimate and illustrating the possibilities of outdoor living space in a suburban home. The walls are creosoted and oiled redwood with pale coral ceiling.

Other pictures in this group are a striking view of the entrance approach to the Robert B. Mitchell home in Piedmont, the recreation pool and bath house for George Lewis in Burlingame, the Benjamin Follett place in Hillsborough (note circular open-air fireplace on the left); a severely modern home for Mr. and Mrs. H. T. Howard in San Francisco and a school building in Fowler, California, that strikes a new note in country school architecture. F.W.J.



RESIDENCE OF ROBERT B. MITCHELL, PIEDMONT, CALIFORNIA
MILLER AND WARNECKE, ARCHITECTS



Recreation
Pool and Bath
House for
Geo. Lewis,
Burlingame

Leo J. Sharps,
Architect



House for
Benjamin
Follett,
Hillsborough,
California

James H.
Mitchell,
Architect

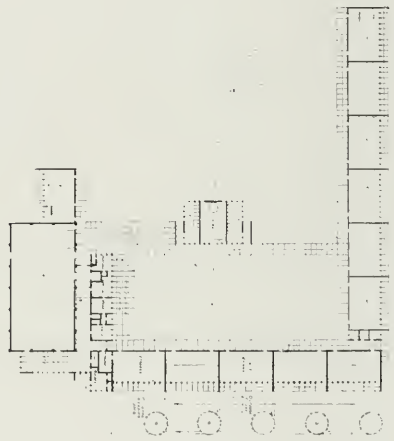

Photo by Sturtevant

HOUSE FOR MR. AND MRS. H. T. HOWARD, SAN FRANCISCO
H. T. HOWARD, ARCHITECT



FOWLER ELEMENTARY SCHOOL, FOWLER, CALIFORNIA
Chas. H. Franklin and Ernest J. Kump, Jr., Architects



PLANS, FOWLER ELEMENTARY SCHOOL, FOWLER, CALIFORNIA
Chas. H. Franklin and Ernest J. Kump, Jr., Architects

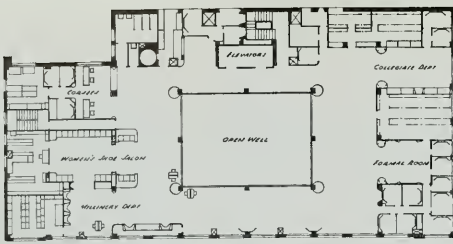

THIRD FLOOR PLAN

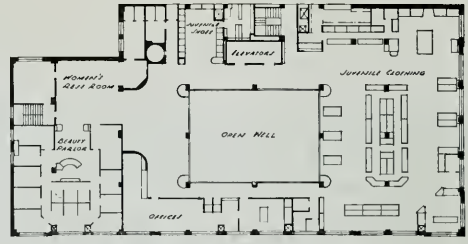

FOURTH FLOOR PLAN



VIEW FROM FOURTH FLOOR, LOOKING ACROSS AND DOWN LIGHT WELL IN ROOS BROS. STORE, FRESNO. THIS IS A REMODELED PROJECT, THE ORIGINAL STRUCTURE BEING STORES AND OFFICES
WILLIAMS & GRIMES, ALBERT R. WILLIAMS, ARCHITECT
Fisher & McNulty, Contractors

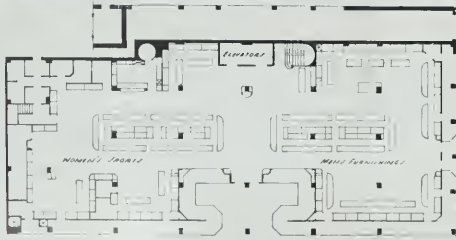

FIRST FLOOR PLAN

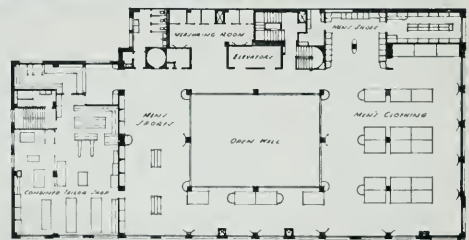

SECOND FLOOR PLAN



Photo by Moulin

GENERAL VIEW OF MEN'S FURNISHING DEPARTMENT, ROOS BROS. STORE,
FRESNO, CALIFORNIA

Williams & Grimes, Albert R. Williams, Architect

SOME HIGH SPOTS IN STORE PLANNING

By Albert R. Williams, Architect

IN STORE planning the main problem is not so much the ultimate design and effect but rather an arrangement which permits the proper functioning of the departments and the personnel. Elements for consideration are the actual sales areas, customer facilities, displays and public circulation areas, the business offices, receiving and delivery departments, stock rooms and service circulation. The space and equipment allotted to these many requirements naturally varies with the type of merchandise and selling policies of the store, and these factors quite naturally must govern the design in so far as general size and arrangement are concerned. The relative position of the selling departments is important, since a proper arrangement is certain to stimulate sales.

The modern tendency in most stores is to give the department sales areas the effect of an intimate shop. In some cases the selling system of the store requires the shops to be designed as salons and display centers only, with the actual selling being done in private fitting rooms or alcoves. In other cases a representative selection of merchandise is carried directly in the sales area. In either case, however, the stock space must be easily accessible and both stock rooms and sales areas must be planned to accommodate peak loads at certain seasons. It is desirable where possible to provide for interchange in the use of areas to handle strictly seasonal merchandise.

From the above rather sketchy outline it is evident that in seeking to establish a plan many different combinations are possible, but the final selection must be that combination best suited to the varied requirements of the client.

The policy of the store, as to permanence of the work, controls to a large extent the mate-



WOMEN'S FORMAL ROOM, ROOS BROS. STORE, FRESNO, CALIFORNIA
Note reflection of lights in mirror



CORSET DEPARTMENT, ROOS BROS. STORE, FRESNO
Williams & Grimes, Albert R. Williams, Architect



Lighting Fixtures by Boyd
MEN'S FURNISHING DEPARTMENT, ROOS BROS. STORE, SAN FRANCISCO
Daylight fluorescent tube lighting from ceiling corners



WOMEN'S READY TO WEAR DEPARTMENT, ROOS BROS. STORE, SAN FRANCISCO
Williams & Grimes, Albert R. Williams, Architect



MILLINERY DEPARTMENT, ROOS BROS. STORE, SAN FRANCISCO
Note table lighting by means of daylight fluorescent tubes



FORMAL ROOM, MEN'S CLOTHING DEPARTMENT, ROOS BROS. STORE,
SAN FRANCISCO



SHOE SALON, ROOS BROS. STORE, SAN FRANCISCO, CALIFORNIA
Williams & Grimes, Albert R. Williams, Architect

rials used. Some firms prefer to renovate or remodel at relatively frequent intervals while others favor more permanent improvements. In the first instance the materials chosen are naturally less expensive while more permanent work necessitates the use of fine woods and finishes and more durable construction throughout.

Probably one of the greatest developments taking place in stores today is the subject of lighting. A few years ago store lighting was considered adequate if it consisted of globes hung at intervals from the ceiling and calculated to give moderate general illumination. Today the illumination and electrical engineers work in detail with the architect with the result that not only is the light properly distributed at the selling level but often is a part and feature of the architectural effect. There is no longer a "standard unit fixture" which will serve every purpose in a modern store; each fixture is selected or especially designed for its specified function. Lighting should be considered a part of the plan and not merely an accessory intended to provide general illumination.

In the business of modern merchandising, the show window has become one of the most important parts of the store. A well-lighted window with a good display commands the momentary attention of those passing; it can attract others from a distance and, if it is well done and well lighted, it can cause as many as one out of every five to stop and examine the articles thoroughly. Ample proof of this is given by sales lighting tests.

Exclusive of the show window, the store front itself is quite as potent an outside salesman and has much to do with attracting customers. Outside the store, light in the form of luminous store fronts can effectively sell the store to the customer as a good place to buy and as a means of identifying a store's location in the minds of the buying public. Modern lines and forms, architecturally pleasing and appropriate in the daytime, come to life at night with a still more distinctive character.

Editor's Note—The work shown in these pages is from the office of Williams & Grimes, Albert R. Williams, architect, and illustrates admirably present day tendencies in store and window design.



NIGHT VIEW OF SHOW CLUB, HOTEL SOMERTON, SAN FRANCISCO
Williams & Grimes, Albert R. Williams, Architect
Indirect Neon lighting



COCKTAIL LOUNGE IN SHOW CLUB,
HOTEL SOMERTON, SAN FRANCISCO,
CALIFORNIA

Williams & Grimes,
Albert R. Williams, Architect



Fred W. Schell, Contractor

STORE FOR THE OREGON CITY WOOLEN MILLS, SAN FRANCISCO
Williams & Grimes, Albert R. Williams, Architect



STAIR APPROACH TO WOMEN'S
DEPARTMENT, OREGON CITY
WOOLEN MILLS STORE,
SAN FRANCISCO



CORNER OF MEN'S CLOTHING DEPARTMENT, OREGON CITY WOOLEN MILLS STORE, SAN FRANCISCO



FUR DEPARTMENT, LIVINGSTON BROS. STORE, SAN FRANCISCO
Williams & Grimes, Albert R. Williams, Architect

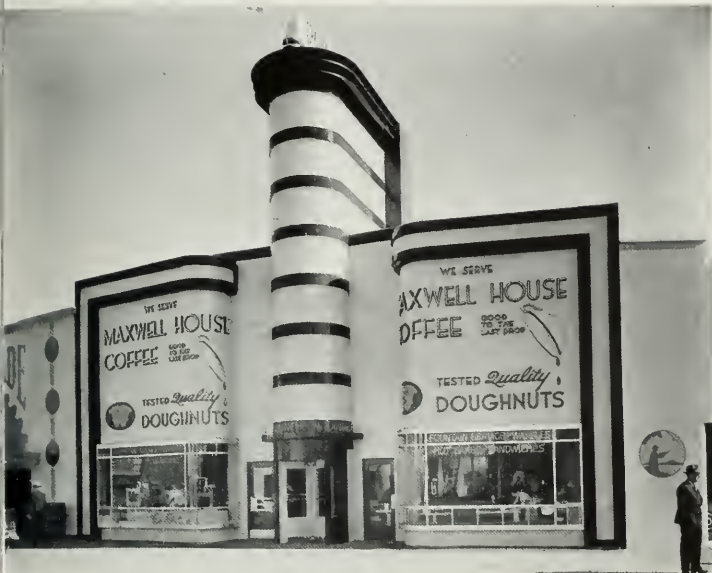

Faced with
Cream and Maroon
Ferro-Porcelain

Frank Allen,
Ferro-Porcelain
Construction

BUILDING FOR MAXWELL HOUSE COFFEE,
TREASURE ISLAND, G. G. INTERNATIONAL EXPOSITION
Williams & Grimes, Albert R. Williams, Architect



ADDITION TO CHAPEL AND CREMATORIUM, CYPRUS LAWN
MEMORIAL PARK, SAN MATEO COUNTY, CALIFORNIA
Williams & Grimes, Albert R. Williams, Architect



MAIN FACADE SHOWING MAP OF CALIFORNIA OVER ENTRANCE



NIGHT VIEW

Photos by Haas-Schreiner

A World's Fair Bank Building

A BUILDING that is attracting more than ordinary interest at the Golden Gate International Exposition is the Bank of America Branch, a structure unique in design and as complete in equipment and banking facilities as banks come. Streamlined in its appointments, glowing in rich colors of blue, red and gold, adorned with mural masterpieces within and relief panels outside, air conditioned and scientifically lighted, the building is probably without a duplicate in the world.

There are no windows. The lighting comes from concealed artificial sources. Atmospheric temperatures are controlled by the latest in air conditioning. There is a sound wave protective system about which only bank officials and the police department have full knowledge.



LOUNGE AND WRITING ROOM

Bank of America at Treasure Island

The bank fixtures are of streamline design with glass tile counters. Nine tellers' windows provide for ample service, and bank executives are accessible from an open platform off the main aisle. A comfortably furnished lounge and writing room makes a convenient waiting room for those planning to meet friends at the Fair.

A complete range of banking services is provided exhibitors and visitors alike staffed by thoroughly experienced men in every department. Owing to the large number of participants among the foreign nations and the many visitors expected from all parts of the world, foreign exchange plays an important part in the bank's business.

The front of the building, which is in architectural harmony with the Exposition as a whole, features a



FACADE FACING PARKING AREA



Bank of America's Branch at Treasure Island contributes significant art and warmth of color to the Exposition night scene. This exterior panel symbolizes Industry.



Relief panel symbolizing Mother Earth on the exterior of Bank of America's branch bank building at Treasure Island. The panel symbolizes Industry.



MAIN BANKING ROOM, BANK OF AMERICA BRANCH,
G. G. INTERNATIONAL EXPOSITION, TREASURE ISLAND
L. T. Hendy, Architect

Bank of America
officials say their
Treasure Island
building is a preview
of what tomorrow's
banks will be like.

huge illuminated map of California, on which an animated lighting system indicates the location of each of the bank's 495 branches in 307 Pacific Coast communities.

Note the reproduction on another page of an exterior relief

panel symbolizing Industry. "Where Nature furnishes the materials," says Hume, the old Scottish philosopher, "they are still rude and unfinished, till industry, ever active and intelligent, refines them from their brute state and fits them

for human use and convenience."

At night, flooded by "black light," the entire building becomes a glowing mass of color, accentuating the beauty of its streamline architecture and accompanying works of art.

Mural by Angelino Langani
in Branch Bank Building,
Bank of America,
Treasure Island.

"U. S. Sloop of War,
Portsmouth," entering
San Francisco Bay,
July 9, 1846.

When John B. Montgomery
sailed into S. F. Bay the
Golden Gate Bridge was
only a dream.



A Private Office In Chinatown

THE problem in the architectural design of this suite of offices in the new Los Angeles Chinatown was to combine a Chinese character appropriate to its location and ownership with a straightforward modern treatment fitting to its use as an efficiently operated professional office. One of the principal requirements was to provide over 300 lineal feet of open book shelves for the owner's extensive legal library. These were made a part of the pattern and design of all the walls and the color of the room was related to that of the books.

The large window back of the desk admits north light which is tempered with parchment colored Venetian blinds and blue green mohair hangings. Below the windows a series of cabinets provide storage and form a counter top at a convenient height. These cabinets and counter are of Philippine mahogany lightly toned and finished with dull varnish. Above the counter the walls and book shelves are of Douglas Fir which is finished with a semi-transparent glaze and varnish. Above the windows the plywood frieze which forms the curtain boxes is painted a straw color while the Celotex ceiling is tinted a soft blue green which is recalled in a deeper shade in the backs of the book cases which comprise most of the other two walls of the room.

All the furniture is of special design and is made of birch finished a natural warm tone. The owner's name in Chinese characters forms a decorative medallion in low relief on the front of the desk.

The desk lamp was made from two glazed bamboo tile sections set on a carved walnut base with a shade of finely split bamboo.

Heat is provided by an electric element set in a mantel faced with dark red marble.

Recessed in the mantel shelf is a flush light panel which illuminates a water color painting of "Confucius as a Justice" by Tyrus Wong. The painting is mounted on a panel designed for the space and is set flush with the wall.

A Motion Picture Exposition

FIFTH year student work at the College of Architecture, University of Southern California, is exemplified in the perspective and plot plan by Eugene Kinn Choy, Atelier Raymond Kennedy, on Page 38. The subject, "A Motion Picture Exposition," presented many interesting problems and how well they have been met a study of the drawings will disclose. The following was the program:

Subject: A MOTION PICTURE EXPOSITION

Location: In the Los Angeles area at the intersection of 2 major highways

Site: Level piece of ground 1200 sq. ft.

General requirements:

The project is to provide a permanent exhibition of the motion picture industry and is to be designed to eliminate the necessity of entertaining special guests and general public on the private lots of studios. Studios will make use of the Exposition for actual productions.

Minimum essential requirements:

Main entrance & administration bldg.	10,000 sq. ft.
Shrine exhibits & museum	20,000 sq. ft.
Cafe & lounges	10,000 sq. ft.
Preview of theater to seat 500 people	
Sound stage & shops	25,000 sq. ft.
Develop patrolled public entrance	
Radio & television studio	15,000 sq. ft.
Lake with marine sets	
Shops for outside leasing	15,000 sq. ft.
Exterior sets to be over as much area as possible	
General grounds to form an attractive landscape development	
Complete control of street intersection to a 100 ft. depth is to be assumed on all streets	

Required for preliminary sketch:

Plan of entire project at scale of 1" equals 10'	
Elevation of entrance gate at scale of 1/64" equals 1'-0"	
Present on 20" x 30" board	

Required for final presentation:

Plan at scale of 1' equals 50'	
Bird's eye perspective—full 20" x 30" sheet	
Three objective sketches each 12" x 20"	
Elevation of main entrance at scale of 1/16" equals 1'-0"	

PRIVATE OFFICE OF
YOU CHUNG HONG,
LOS ANGELES CHINATOWN

Webster & Wilson, Architects
Honor Easton, Interior Designer



This seven story store and loft building designed and built fifty years ago still stands as mute evidence of a young architect's successful start in his professional career



Compared with the specifications for such a building today the St. Louis structure was actually built better than standard requirements would seem to justify

HALF CENTURY OF ARCHITECTURAL PRACTICE

By Alfred F. Rosenheim, F. A. I. A.

MY FIRST substantial architectural commission was in 1887 when I designed a seven story and basement mercantile building, covering a ground area of 120 x 150 feet, of standard mill construction with walls of red brick trimmed with red granite, stone and terra cotta. Completed the following year, the project represented an expenditure of approximately \$300,000.

My most recent commission was a reinforced concrete school consisting of five sizable two-story units completed in 1937. The fifty year span between these two projects is a big round number and a pardonable excuse for harking back to note what changes have developed in "architectural and construction practices."

That first building of a young architect must have been quite good because practically two-thirds is standing and in use today. Yet, when I carefully reviewed the "general specifications" which turned up recently in a file dated 1887, I was not only amused but actually awed. Comparing them with the specifications we are required to provide today, it was apparent that a better building was produced than the specifications seemed to justify, yet they were "standard" for that period. In view of this fact I was forced to the conclusion that the contractors must have been honest men who, apparently, did everything in their power to help me acquire something of a reputation for the production of first-class work.

The general use of concrete, as we know it at present, was very limited in those early days.

Even in the case of foundations and the footings for walls and columns, the general practice was to use "dimension limestone," obtained from near-by quarries in Missouri and Illinois. However, when concrete was used according to rather "sketchy" specifications that left much to chance and the contractor's conscience, I recall the fact that good concrete was actually produced because there was not the slightest evidence of cracks anywhere in the walls that are usually due to settlements.

The Hollenbeck Jr. High School in Los Angeles, my 1937 effort, is modern concrete ac-



ARCHITECT ROSENHEIM IN 1913
(From The Architect & Engineer of that year)

ording to modern specifications. However, in the matter of design I do not consider the buildings particularly "modern" although the administration and assembly hall units may possess something akin to the so-called "contemporary" style.

a horizontal force equal to ten per cent gravity in conformity with and to the regulations adopted by the State Legislature, at the instance of the Division of Architecture, following the earthquake of 1933 which resulted in great damage to communities surrounding the city



Photo by Spence

AIR VIEW OF THE ORIGINAL BOYLE HEIGHTS INTERMEDIATE SCHOOL, LOS ANGELES, BUILT IN 1913

Alfred F. Rosenheim, Architect

Personally, I do not hesitate to express the fervent hope that "modernistic" architecture is not a permanent trend. I have a strong feeling that the bulk of modern work we see the country over has very little claim to architectural beauty. In fact I am inclined to doubt whether it can strictly be regarded as architecture. More fitting, I should say, would be to refer to the average building in that category as a "revolution" of new ideas introduced in construction, prompted by more or less unusual arrangements evolved by the architect.

But, whatever one chooses to call the style of my Hollenbeck School, it seemed to appeal to the Board of Education and its architect. The Board requires that all schools hereafter erected shall be so designed as to successfully resist

of Los Angeles. These regulations formed the basis of our designs and, naturally, led to the use of concrete construction as the best material to meet the stringent requirements for safety.

In the case of my project there was no deviation from the use of concrete which was quite general and included piles, caissons, footings, columns, walls, cross-walls for stiffening, floors, stairways, steps, platforms, retaining walls, roofs and even the smoke-stack. In many instances concrete floor slabs were finished integrally.

All exterior walls, which have limited ornamentation, were given a stucco finish in two colors. The plain surfaces are a pale buff while

the base, the spandrels between first story window heads and second story window sills and the wall copings, are of a deeper color. The combination is very pleasing and served to give the entire exterior a character and texture which are quite essential to exposed concrete

slightest damage.

However, the architect of the Board of Education, after very careful figuring, discovered that it would cost practically as much as new construction to renovate and reconstruct it to comply with the law. Hence, the decision.



Photo by Spence

AIR VIEW OF REMODELED AND ENLARGED BOYLE HEIGHTS SCHOOL, RENAMED THE HOLLENBECK JR. HIGH SCHOOL, COMPLETED IN 1938
Alfred F. Rosenheim, Architect

work.

The five units comprising the school include two class room buildings, administration building, boy's gymnasium and shop building and an assembly hall. The final total cost of the group was slightly in excess of \$785,000, which was next to the largest project undertaken by the Board of Education under the Los Angeles \$34,000,000 school program.

The foregoing project replaced the original 4-story Intermediate High School, erected from plans prepared by me and completed in 1914 so that it was 25 years of age.

It was really an attractive composition and I greatly regretted when informed that it was to be removed. The fact is that it went through the earthquake of 1933 without suffering the



ARCHITECT ROSENHEIM IN 1939



ONE OF FIVE SIZABLE UNITS FOR THE HOLLENBECK JR. HIGH SCHOOL, LOS ANGELES
ALFRED F. ROSENHEIM, ARCHITECT

Expositions have always meant a great deal to architects, mainly because they offer a chance at large monumental design on a scale seldom offered in permanent structures. Oddly enough they seldom celebrate current practice in design, but almost invariably they epitomize some phase or style far away in time or greatly removed in space from the City of the Exposition itself.

On the other hand, if they do not perpetuate what is past or remote but in actual existence, then they invariably try out some brand new ideas of design which have small chance of trial in private or enduring structures. Thus expositions are fine experimental fields for radical design.

ARCHITECTURE OF THE MIDWINTER FAIR

As an outstanding example of the first named tendency to reproduce the past the great Chicago Fair of 1892 was extraordinarily successful. Classical colonnades and porticos were so splendidly imitated that Pausanias himself

exact opposite, was the second Fair at Chicago where all surfaces were flat. This idea was first popularized in Germany and is now gaining ground all over this country because it is the logical expression of reinforced concrete. Although this revolutionary method of construction was actually invented in France, and in spite of the fact that the French are the most logical people in the world, in their exposition architecture, they prefer to be illogical and so retain all the florid excrescencies of the five orders "and then some," so that their practice in this field is only just a little bit more exuberant than in every day work. The French stand alone in their exposition architecture and work in the present rather than in the past or future tenses.

As a small boy I saw the great event of 1879. I remember only the Trocadero which still stands. In 1898 I saw the unfinished buildings for the next year's show and, of course, climbed up the Eiffel Tower, a hold-over from the show

DETAIL, HOLLENBECK JR. HIGH SCHOOL LOS ANGELES

Alfred F. Rosenheim, Architect

MASSIVE COLUMNS DOMINATE THE ENTRANCE TO THE ASSEMBLY HALL. ALTHOUGH THIS BUILDING MAY RESEMBLE THE "CONTEMPORARY STYLE," THE ARCHITECT SAYS IT WAS NOT INTENTIONALLY "MODERN," BUT A PRACTICAL SOLUTION OF THE PROBLEM AT HAND

NOTE HOW THE DETAILS ON THE CONCRETE STACK CORRESPOND WITH THOSE ON THE WALLS OF THE BUILDING





PLANS FOR THE HOLLENBECK JR. HIGH SCHOOL, LOS ANGELES
ARCHITECT

ARCHITECT VISUALIZES THE SAN FRANCISCO OF TOMORROW

Exposition and Two Great Bridges the Forerunner of World's Second Largest Metropolis

By B. J. S. Cahill, Architect

THE Fair at Treasure Island, although we may call it "The Pageant of the Pacific" is in reality a joyful celebration of the final unity of the cities around San Francisco Bay which are—at long last, linked together by two of the most stupendous bridges in the world. The Exposition itself is on San Francisco soil, so that it typifies and focuses the fact that the circle of communities around it, like jewels in a diadem, are all a part of one sovereign city, the Greater San Francisco of the future. All this may sound far-fetched at present, but, sooner or later it will come to pass so that in fifty years it will be the true metropolis of the Pacific and the second city on this continent.

The plan of this "City of the Future" was already made when the last rivet was driven in the bridge which completed this vast periphery of a population yet to come.

This, then, is the real event we now rejoice in, the consolidation of the Bay Cities, and if we appeal to the future as a justification let us glance over the past regarding expositions in general so as to come to some correct appraisal of our own in the present.

To begin with, of course, the engineering feats we celebrate far outshine the architectural one. But, as this technical field lies entirely outside our own, no comment can be of the slightest value.

Expositions have always meant a great deal to architects, mainly because they offer a chance at large monumental design on a scale seldom offered in permanent structures. Oddly enough they seldom celebrate current practice in design, but almost invariably they epitomize some phase or style far away in time or greatly removed in space from the City of the Exposition itself.

On the other hand, if they do not perpetuate what is past or remote but in actual existence, then they invariably try out some brand new ideas of design which have small chance of trial in private or enduring structures. Thus expositions are fine experimental fields for radical design.

ARCHITECTURE OF THE MIDWINTER FAIR

As an outstanding example of the first named tendency to reproduce the past the great Chicago Fair of 1892 was extraordinarily successful. Classical colonnades and porticos were so splendidly imitated that Pausanias himself would have been impressed. But what is far more important, millions of Americans saw what the splendors of antiquity were and our national architecture was fundamentally improved for a whole generation.

While the Midwinter Fair in Golden Gate Park was a continuation of the Chicago Exhibits, its architecture was also historical but instead of antique forms it revived the red tile and adobe features of the old Missions with a few samples of the Moorish style from Spain. The Central Building, where now the Spreckels Concert Platform stands, was a masterly example of real California architecture, far more worthy of preservation than the present poor background to Gustav Dore's bronze nymphs of the wine jar.

As a deliberate attempt to foreshadow an architecture of the future or "ART NOUVEAU" as it was called, the Turin Exposition was an interesting experiment. It failed to leave much impression on the design of that day because its chief feature consisted of twisted surfaces suggesting the anatomy of a magnified bone, and horribly expensive to realize in durable material.

Along entirely different lines, in fact the

exact opposite, was the second Fair at Chicago where all surfaces were flat. This idea was first popularized in Germany and is now gaining ground all over this country because it is the logical expression of reinforced concrete. Although this revolutionary method of construction was actually invented in France, and in spite of the fact that the French are the most logical people in the world, in their exposition architecture, they prefer to be illogical and so retain all the florid excrescences of the five orders "and then some," so that their practice in this field is only just a little bit more exuberant than in every day work. The French stand alone in their exposition architecture and work in the present rather than in the past or future tenses.

As a small boy I saw the great event of 1879. I remember only the Trocadero which still stands. In 1898 I saw the unfinished buildings for the next year's show and, of course, climbed up the Eiffel Tower, a hold-over from the show of the previous decade. Although no longer the tallest building on earth its great height impressed me because it literally penetrated the sky on certain cloudy days so that the top was entirely lost from sight.

TREASURE ISLAND ARCHITECTURE

The Fair buildings on Treasure Island, like those in New York, are not more notably futuristic than the last one at Chicago. Our Treasure Island Fair, however, exhibits an unusual archaeological feature in reproducing some of the Mayan motives from the jungles of Yucatan as well as many of the elaborate splendors of Cambodia and Siam, much less familiar than the temples of China and Japan, all of which are here represented to justify its title as "A Pageant of the Pacific."

Realizing also the stark monotony of flat surfaces, and at the same time eschewing the relief of paneling "pilastering" or pretty ornament, the designers of the Golden Gate Fair have resorted to the rather startling device of extruded buttresses set vertically or wind-baffling walls placed horizontally and in echelon which yield dramatic contrasts of light and shadow. Apart from the exotic splendor of various Oriental lands, imported bodily as it

were, from afar, and with the exceptions above noted, the main wall surfaces of the Exposition proper may well be regarded as blank canvases or screens on which, after dark, are suffused gorgeous and ever-changing color symphonies such as our modern electrical experts have developed to a degree of unimaginable splendor.

Too much praise cannot be given the idea of a tall spire as the contrasting center of the whole low lying group, which, like Venice of old, arose from the very waters of the Bay itself.

Since the many features which make the complex scene of Treasure Island have been technically dealt with in the February number of **The Architect and Engineer** no further details need be touched on except to repeat that the whole event is a joyous celebration of the complete plan of the Future San Francisco. And to help in our estimate we are also taking a short synoptic view of the expositions of the past. This leads us naturally to say a word about the Fair of 1915 which, it must not be forgotten, was also in celebration of an engineering feat even more important to the world than our giant bridges, the Panama Canal.

Architecturally speaking this affair at North Beach was a unique event. Avoiding the cold classicism of Chicago's first Fair and the rather stark modernity of the second; steering clear of the futuristic fantasies of Turin as well as the mere glorification of current practice, which characterizes most French efforts, the Panama Pacific Exposition, was yet colorful, sane, familiar and romantic. Although small as Expositions go, and a mere succession of interior courts, architecturally speaking, these richly decorated patios attained a gem like perfection in which old forms and new methods were happily blended in beautiful results seldom reached before or since in any Exposition.

It is a familiar fallacy of our day to assume that the newest thing is necessarily the best. We don't always go up hill, we sometimes go down. If anyone doubts this let him think of the most recent examples of sculpture, painting and music.

Some allusion was made above to the complete revolution in constructional methods

which a great International Exposition attempts and sometimes succeeds in inaugurating.

LONDON'S EXPOSITION IN 1851

Without any question, by far the most radical and complete revolution of all was brought about in building the first, and perhaps the most remarkable of all great expositions, that of 1851 in London.

The idea for this vast undertaking is credited to Prince Albert who was married to Queen Victoria. His belief was that by bringing all nations into friendly rivalry as to their products and resources it would make for perpetual peace as outlined by his illustrious countryman, Immanuel Kant. Then followed one of the most remarkable architectural competitions of which there is any record. What happened is about as follows. The Royal Commission appointed to carry out this ambitious—and hitherto unheard of project—called upon the architects of the day to submit plans for a suitable great structure big enough to house the exhibits. We may well imagine the rather stolid designs submitted. While these were being considered a well known horticulturist, Joseph Paxton, was called in to consult about the grounds and their suitable setting. Now this Paxton was a man of vision with much experience in building great greenhouses. One of them was on the Duke of Devonshire's estate at Alton Towers and another in the celebrated Kew Gardens. Oddly enough this very structure was reproduced in our own Golden Gate Park, although greatly reduced in scale.

While this super gardener was looking over the various building plans he suddenly had a great idea. Seizing a piece of blotting paper, so the story goes, he hastily made a pencil sketch of what was in his mind, and explained it to the commission. Instantly the idea caught on, the initial plans were all discarded, draughtsmen were called in and after working feverishly for days and nights, drawings were completed for an all-glass and iron building—the famous Crystal Palace, first erected in Hyde Park, London, and later removed to Sydenham where it remained for over three quarters of a century, one of the most attrac-

(Turn to Page 52)

NOISE AND WHAT SCIENCE IS DOING TO CORRECT IT

By Harry Wilkin Perry

in Buildings and Building Management

NOISE in an office building or apartment house is definitely objectionable. This generalization may seem to be refuted by the frequent blaring of radios in apartments and the obvious fondness of the younger generation for jazz and swing music as a gustatory accompaniment but it is well supported by physiological and psychological investigations. The desire of most persons, particularly middle-aged and elderly adults, for quiet is not a mere crochet of age but has a sure scientific foundation.

Many tests have proved conclusively that continual noise affects the nervous system of the human organism, lowering efficiency, distracting mental concentration and even impairing health, even though the individual become so used to customary noise as to be unconscious of it. Everyone knows that quietness is demanded in hospitals because of the injurious effect of noise on patients, but it is not so well known that normally healthy persons also are unconsciously affected. That they are has been proved many times and mathematically.

Noisy offices are inefficient offices. A large eastern insurance company reported a reduction of 52 per cent in errors by comptometer operators and 29 per cent by typists after noise absorbing material had been installed in the work rooms.

"Noise cuts into dividends," says Dr. Donald A. Laird, director of the physiological laboratory of Colgate University, "by lessening the output and requiring more energy from workers. There is no evidence that workers get used to noise. They may become unconscious of its presence but the effect upon their output remains. In the Colgate University laboratory it was determined, by the use of special apparatus, that noise of unusual intensity cuts into the output of professional typists on the average by 5 per cent. In higher mental work,

such as the executive does, the cut is in the neighborhood of 30 per cent."

The same authority found that errors in a typical manual production operation increased nearly one-third when the noise level in the workroom was increased from 40 to 90 units (decibels) and that a 42 per cent reduction in errors followed a lowering of the noise level from 50 decibels to 40 in the telephone operating room of a telegraph company. It has been found also that reduction of noise resulted in fewer absences from work.

LOUD NOISES CAUSE INDIGESTION

Owners and managers of hotels and apartment buildings are well aware of the demand of guests and prospective tenants for quiet rooms, remote not only from street noises but from lobby, kitchen, dining room and corridor sounds. Most patrons of dining rooms and restaurants, with the exception previously mentioned, prefer to eat where they will not have to expend excessive energy in loud conversa-

RELATIVE NOISE LEVELS IN BUILDINGS

Location and Source	Level Above Threshold, Decibels
Boiler factory	97
Subway, local station with express passing	95
Noisy factories	85
Very loud radio in home	80
Stenographic room, large office	70
Average of six factories	68
Information booth, large railway station	57
Noisy office or department store	57
Moderate restaurant clatter	50
Average office	47
Noises measured in residence	45
Very quiet radio in home	40
Quiet office	37
Quietest non-residential location	33
Average residence	32
Quietest residence measured	22

Taken from "City Noise," Department of Health, New York City

tion to be heard above the clatter of dishes and cutlery. Loud noises, according to Dr. Laird, play a part in causing nervous indigestion by decreasing the flow of saliva and gastric juice.

Quiet offices, restaurants, retail stores, banking rooms, studios, theaters and auditoriums attract patronage. They lack nervous tension and have an air of peace, orderliness and efficiency. The tenants may not realize fully the reasons for their satisfaction but they remain longer and are willing to pay higher rentals than for noisy quarters. Every building owner can improve the acoustic properties of the rooms and thereby increase the rental or sales value by having suitable sound-absorbing material installed. The larger amount by far of such materials is installed after buildings have been erected, as the acoustic properties of rooms and auditoriums cannot be ascertained with exactitude beforehand, although much can be done by the architect to give an auditorium or a studio desirable sound characteristics by suitable proportions of walls and ceiling, design of balcony and avoidance of wall and dome curvature that would act to concentrate reverberations as a lens focuses light.

Different treatments are required to suppress or reduce external and internal noises. Without air conditioning to permit sealed windows, not much can be done at reasonable expense to exclude outside noise. In apartment buildings, however, floors and walls can be treated to reduce penetration of the sound of footfalls and radios from adjacent apartments and to isolate kitchen and dining room sounds from living room and chambers. The rumble, rattle and clatter of street traffic are very difficult to exclude from any building. Passing trains or heavy trucks often shake the entire structure, and low-pitch heavy vibrations cause large window panes to vibrate in unison. Radio broadcasting and music studios should have the finished floor, walls and ceiling isolated from the supporting structure of the building by means of resilient mountings and suspensions, if possible. If this is impractical, false walls and ceilings of porous building board will give good results. Doors should be of heavy construction

and fitted with airtight seals at the threshold and all edges. Two soundproof doors with a small vestibule between are most effective. Interior rooms without outside windows are highly preferable, but if there are windows they should be of thick double or triple panes, each set in rubber and, if possible, in separate sashes isolated from each other.

The whole subject of noise and its reduction has been given a great deal of study. The propagation, reflection, interference, amplification and absorption of sound involve many factors and make the studies highly complex and scientific. Delicate instruments have been developed for measuring noise levels or intensities, which are expressed in units called decibels. These are divisions of a logarithmic scale covering the range of audible sound from about 20 to 20,000 vibrations per second. A level of 10 db. corresponds to ten times the intensity of a barely audible sound, 20 db. to 100 times, 30 db. to 1,000 times and so on to 120 db., which corresponds to one trillion times the original intensity and is the highest noise level the human ear can tolerate without feeling physical pain. The noise level of the average business office in which there is ordinary conversation ranges from 40 to 60 db. and that of a noisy office with telephone conversation and ordinary traffic noises ranges from 60 to 80 db.

A brief explanation of the physics of sound will make clear the principles underlying the acoustic materials offered by the building industry today as effective means for reducing the noise level within rooms. Sound or noise is produced by air waves set in motion by vibration, as by the ringing of a bell, and travels in all directions from the source as waves on a still pond radiate from a dropped stone but at a rate of about 1,100 ft. per sec. Sound, like light, is reflected from or absorbed by surfaces it strikes. Hard, dense building materials, such as wood, plaster, concrete and glass, reflect more than 95 per cent of the energy or sound waves that strike them, as white paint reflects most of the light waves, and these air waves travel back and forth between the surfaces of walls and floor and ceiling many times, building up the in-

tensity of a continuous sound until it is much higher than it would be in the open air without reflecting surfaces. This is why a speaker or music can be heard much better in an auditorium than out of doors.

Conversely, porous materials having innumerable minute air spaces act as a cushion to absorb the energy of the air waves instead of reflecting it. The constituents of the material may be hard and rigid but the air in the spaces is compressible and, being partly confined, stores up the energy momentarily and releases it relatively slowly, much as an automobile shock absorber operates. This is the principle on which nearly all sound, or acoustical, materials are based.

Many different substances are used in the manufacture of acoustical materials. Most of them are vegetable products, such as cane and wood fibers, cork and rubber. Others are minerals, as stone, slag, silica and cement. Most are formed into tiles or panels in a range of sizes suitable for application to ceilings and walls of all architectural designs, including curved surfaces. They are produced in a great variety of styles—plain and in patterns, tinted in plain colors and in many colored designs—and can be cleaned and painted without injury or impairment of their sound-absorbing property. They are therefore used for decorative effects as well as for the primary purpose of reducing sound reflection, and consequently are well suited to modernizing and beautifying interiors when remodeling or redecorating buildings, as they can be applied directly to plaster, concrete, wood, building board and metal or suspended by metal ties as false ceilings.

MANY TYPES OF ACOUSTICAL MATERIALS

Each of the larger manufacturers makes a number of types of acoustical material to suit different requirements and employs acoustical engineers to give advisory service on the problems involved. Because of the diversity of conditions affecting different structures and rooms, it is important to get the advice of such a service as to the kind of material to be used and where and how it should be applied, and to have the installation work done by a competent

contractor authorized by the manufacturer to apply his products.

The great majority of jobs are done to subdue internal noises—pounding of leather heels on bare, hard floors; rattle and clatter of office machines, dishes and tableware; loud talking; ringing of telephone bells and buzzers; slamming of doors; rustle of papers, and so on. The treatment of these noises calls for covering the floor with some resilient material that will stop the noise at its source and the nature of which depends upon the amount of wear it will receive, and covering the ceiling and perhaps the walls with the kind and quantity of acoustical material best suited to the particular condition and the money that can profitably be spent on the job.

Whereas a restaurant or a large business office may need a maximum of sound deadening, a theater, music hall or auditorium should have a certain amount of reverberating effect at definite vibration frequencies to provide the best hearing properties throughout the auditorium, while surfaces on or around the stage should reflect rather than absorb the sounds of speech and music.

Every material in the structure of walls, floor and ceiling of an auditorium, all draperies and furnishings, and the audience itself have definite and individual coefficients of sound absorption which must be calculated to arrive at the total absorption property. Shape and volume of the room, height of the balcony if any, average size of the audience (in number), whether the auditorium is used mostly for speaking or music, and other factors are considered in ascertaining the acceptable range of reverberation time; that is, the time required for sound to die out to one millionth of its initial intensity (or decrease by 60 db.) after emission of sound at the source has ceased. So it will be seen that the services of an acoustical engineer are needed to analyze the problem of improving the sound characteristics of an auditorium or theater.

In an industrial or commercial establishment and in business offices or living quarters the

(Turn to Page 52)

ELEVATED HIGHWAYS ONLY SOLUTION TO TRAFFIC CONGESTION

LACK of express highway facilities within and through our major cities is penalizing motorists. Elevated highways would relieve congestion and save the public millions of dollars by reducing accidents, fuel consumption and travel time. Such, in substance, were the conclusions reached by a special committee appointed to study the construction of elevated highways and which reported to the American Road Builders' Association at their recent San Francisco convention.

The report enumerated various elevated highways already built and analyzed the results achieved from them; it also recited the plans for additional elevated highways already drawn by various cities. These plans, it was stated, call for the erection of at least 1,000 miles of elevated highways for the relief of traffic congestion.

The following interesting paragraphs are taken from the somewhat lengthy report:

The Automobile Manufacturers Association reports that there was, in 1937, a total of 7,099,425 passenger cars and 988,955 trucks in the United States, or, in other words, one car for every 5.5 persons in the country. Some 90% of these automobiles, passenger cars and trucks, are owned by persons residing in cities.

According to figures furnished by city engineers we had in these cities only 42,504 miles of paved city streets and 23,393 miles of unpaved streets, or a total of 65,892 miles of all streets. To crowd some six million cars and trucks on 65,000 miles of city streets is the basic cause of all the congestion. For every mile of paved city streets our city residents own approximately 150 cars.

Start those cars moving, even at a modest rate of speed, and you can easily visualize the problem that is confronting your municipal highway engineer. If your streets are to be used for parking as well as driving, it no longer remains a simple problem. And in the city the automobile must be allowed to park, otherwise

it becomes impossible for it to make deliveries. Inasmuch as the primary purpose of a car is to make deliveries of persons and property, parking must be provided for. Therefore the only alternative offered the municipal highway engineer is to provide for a separation of the moving cars from the parked cars. That means elevated highways.

By-pass roads have failed to solve the traffic problem. By-pass roads actually contribute to congestion in the cities as the Bureau of Public Roads has found. Express roads must tap and drain the congestion.

Eighty out of every hundred motorists on the main highways today are headed for destinations less than twenty miles from home, and only two out of a hundred are going more than one hundred miles. Express roads will develop a new traffic, a through traffic, and therefore they must be so planned as to alleviate congestion, not contribute to congestion.

Furthermore, it is shown by these surveys that the main highways and their extensions through the city carry 58.9% of the total vehicular traffic; 30.8% more is on the other city streets. Scarcely more than 10% of the total occurs on all secondary and local rural roads. Furthermore, of the total travel surveyed, 58% is urban in origin, whereas only 42% is rural in origin.

These surveys by the U. S. Bureau of Public Roads, show conclusively that motor transport is primarily a city problem. The cry used to be "Get us out of the mud." That cry is today old as the dodo. The slogan today is "Get us out of the congestion."

The congestion in the cities should be studied in the light of improved highway engineering. A scientific approach should be made first and it appears to us that it would indeed be unwise to burden this problem with any great scheme of slum-clearance, or to lay it open to any unmoral scheme of land-grabbing. It would be foolish to agitate the complete rebuilding of

our cities to meet the need of the automobile age, as we pointed out in our report last year. We must approach this problem from a rational point of view and construct highways that fit any need that we already have.

Elevated highways affording all the limited features necessary to cope with the problem, and accommodating swiftly moving through traffic, are possible. Several agencies have already given this matter considerable study. The automobile manufacturers and the gasoline producers have been studying it for some time. The American Institute of Steel Construction has only recently joined with these other agencies in an endeavor to obtain a solution.

Prejudice is a difficult thing to overcome because its obstructions are so intangible. Prejudice against elevated highways exists largely because the public keeps remembering the unsightly, noisy and dusty elevated railways in New York and some other cities. Those have been eyesores and no one is going to weep to see them go. Once they are out of the way New York will build crosstown elevated highways to tap its circumferential highway.

The American Institute of Steel Construction held a competition to prove that elevated highways can be beautiful in design, that they will reduce traffic noises and will not constitute a dust hazard in any city. Those designs have been placed on display in New York, Chicago, St. Louis, San Francisco, Los Angeles, Pittsburgh and Washington, D. C. They have shown that we can make great improvements in design.

Dr. Miller McClintock, Director of the Yale University Bureau for Street Traffic Research, in an address last October, stated that he had knowledge of several cities having on the boards plans for new elevated highways. He estimated conservatively that these plans call for at least 1,000 miles of elevated highways.

If elevated highways were incorrect in principle, if elevated highways were defacing in character, if elevated highways did not meet the pressing needs of the day, do you suppose so many miles of elevated highways would be under design at this day?

It would be wrong politically to permit this

problem to become involved with any scheme of city-rebuilding or slum-clearance. It is purely a traffic problem and unless solved as a traffic problem it would discriminate against the American motorist who is the one most vitally concerned.

Second to New York in the matter of traffic relief, is Los Angeles which has aroused much interest in a streamlined solution of the congestion problem. Thanks to the Los Angeles Chamber of Commerce, Proposition No. 9 as a Charter Amendment was put to the voters last September. This sets up an agency to recommend remedies. While it is not intended to forecast what any city may formally propose, it is safe to prophesy that the ultimate solution will be a grid of elevated highways to bring traffic into and drain traffic out of the heart of the city.

In San Francisco an equally interesting plan has been proposed. The report of the San Francisco City-wide Traffic Survey prepared for the Department of Public Works will bear careful study. It was found that the average over-all speed of automobile travel in San Francisco is 17.3 miles per hour during off peak hours and 16 miles per hour during peak hours. Over-all speeds are as low as 5 miles per hour on streets in congested areas. This condition is gradually growing worse with the completion of the two new bridges and will become critical before the San Francisco Exposition is concluded. A limited way or express highway was proposed of 64.6 miles in all. This, it was estimated, would cost \$26,120,800 for the system in its entirety, a small cost in comparison with the benefits to be received.

A breakdown of the recommendations would give:

33.6 miles of Elevated Limited Way costing \$525,000 per mile
26.9 miles of Limited Way at Grade costing \$32,000 per mile
3.3 miles of Depressed Limited Way costing \$917,000 per mile
and .81 of a mile of tunnel costing \$2,000,000 per mile.

A total of \$3,000,000 was estimated as the

probable cost of easements and special connections.

This proposed highway for San Francisco would be designed for H-10 loading, because it is presupposed that they would be devoted to the exclusive use of passenger automobiles, or commercial vehicles of comparable weights. Upon the major streets of San Francisco today during the twelve-hour period operate some 900,000 car miles, over the twenty-four-hour period the operation increases 50 per cent up to 1,350,000 car miles. This is exclusive of the traffic movement in the triangle bounded by Harrison Street, The Embarcadero, California Street and Van Ness Avenue.

In these downtown areas we usually find the financial and business heart of every city. It is that area which must be served, and it is there congestion must be relieved, otherwise we will have the problem of stagnation in business, depressed property values, decline in city revenues and the infiltration of decay and death to the city. While architects and city planners dream of their ideal, and visualize their Cities of Tomorrow, traffic congestion is crying out to high heaven for a solution which seems to become simple and economical with the elevated highway.

GREATER SAN FRANCISCO

(Concluded from Page 46)

tive show places anywhere on earth. Thus it comes about that the Trocadero, the Eiffel Tower and the Crystal Palace in Europe and in America, our own deYoung Museum in Golden Gate Park, Mr. Maybeck's Fine Arts Building and now the Pan American Hangars on Treasure Island, remain as holdovers of the most notable expositions held since the middle of the last century.

NOISE IS TOO EXPENSIVE

(Concluded from Page 49)

object is to prevent as much reflection of sound as possible within reasonable limits. Treatment of floors, walls and ceilings cannot reduce the noise of mechanical equipment at the source; that can be done only by quieting the machines themselves; but it does decrease the sound level

in the room by preventing much of the noise reflection and by making loud talking unnecessary. Therefore partitions to exclude noise from individual offices can be eliminated, resulting in better ventilation and illumination and fuller use of floor area without lessening the efficiency and privacy of dictation and conversation and use of the telephone.

S. F. EMPLOYERS COUNCIL

For the purpose of protecting the interests of employers and groups of employers through collective bargaining and mutual aid in relations between employers and employees, there has been organized the San Francisco Employers Council.

The objectives of this Council, as stated in its Articles of Incorporation, are as follows:

- 1—To secure collective action by employers and groups of employers to the end that stable, peaceful and harmonious relations between employers and employees will be promoted and established and that wages and working conditions fair and just both to employer and employee be maintained and honest and faithful observance of all agreements and obligations by all parties concerned be procured, always recognizing the public interest as paramount.
- 2—To promote and encourage the organization of autonomous groups among employers and to promote cooperation among such groups and individual employers for mutual counsel and aid in matters relating to labor relations;
- 3—To promote the recognition and exercise of the right of employers to bargain collectively;
- 4—When requested, to assist its members and others in matters relating to the negotiation, execution and performance of fair labor contracts;
- 5—To collect, compile and distribute information and statistics relating to any of the matters mentioned herein.

The incorporators of the new organization are: Wallace M. Alexander, Wakefield Baker, Tod Bates, W. H. Berg, Charles M. Cadman, Francis Carroll, L. R. Chandler, A. W. Eames, Adrien J. Falk, John F. Forbes, Gregory A. Harrison, C. E. Heise, H. H. Hilp, J. W. Howell, Charles Kendrick, Roger D. Lapham, W. P. Laufenberg, A. J. Lowrey, C. K. McIntosh, R. S. Odell, C. D. O'Sullivan, Charles R. Page, and Almon E. Roth.

NAMED ARCHITECTURAL ADVISER

Alterations on University of Oregon buildings that may be needed in the future will be supervised by Eyster Brown, professor of architecture in the University. Mr. Brown succeeds W. R. B. Wilcox as architectural adviser.

With the Architects

PARTNERSHIP DISSOLUTION

Announcement is made of the partnership dissolution of Symmes & Willard of Bakersfield.

Under the terms of the dissolution, all plans, files, equipment, and the office building located at 1314 Seventeenth Street in Bakersfield, have been taken over by Stanton Willard who will carry on the practice under his own name. Associated with him in his office are Messrs. Arthur C. Metcalf and J. Warren Wright, both licensed architects.

Prior to removal to the present address, the firm was located at 215 Haberfelde Building, Bakersfield.

Mr. Willard's office handles a large volume of school and public work, as well as commercial and residential buildings. Several of his school buildings are now under construction, with plans in preparation for a number of others.

SEATTLE ARCHITECT WINS CLAIM

Judgment of \$819.90 against the Bremerton School District was awarded James Taylor, Seattle architect, as the result of a long fight between the architect and the school board over expenses incurred by Mr. Taylor in preparing plans for a proposed junior high school. The architect sued for \$2,746.66 after financial arrangements for the school failed when voters rejected a proposed bond issue. Judge Clay Allen of King county ruled that Mr. Taylor should be paid for items prepared prior to the agreement.

SEATTLE FIRM BUSY

When voters of Seattle recently approved a \$3,000,000 bond issue, it stirred up considerable activity in the office of Naramore & Brady, Seattle architects who had been retained previously for the preliminary work. They are now making a survey to determine what work shall be undertaken with the \$750,000 which the levy will raise.

IRWIN M. JOHNSON BUSY

Irwin M. Johnson, 2219 Seventh Avenue, Oakland, reports considerable activity in residence and store work of which he has no less than a dozen commissions. The average cost of the houses is \$6500.

BURLINGAME STORE

Earl B. Burtz, 681 Market Street, San Francisco, has awarded a contract for a \$20,000 store building in Burlingame for Martin Stelling, Jr., of San Francisco.

21 STORY APARTMENT BUILDING

San Francisco's first real apartment house sky-scraper to be built in several years is announced as a 1939 project from the office of Samuel Lightner Hyman and A. Appleton, architects. The 21 story building, plus a three floor garage, will occupy the site of the former homes of Emma W. Halsey and Mrs. Charles Fickert on Green Street. There will be 142 completely furnished apartments. The total cost will run close to \$1,000,000. H. Rosenthal will be the structural engineer and George Atkins the mechanical engineer.

AUDITORIUM AND CAFETERIA

From plans by Stanton Willard of Bakersfield, bids will be opened April 27 for the construction of Unit B of the Washington School in Bakersfield, the unit to consist of auditorium, cafeteria, administration and clinic buildings. The estimated cost is in excess of \$200,000.

BERKELEY RESIDENCE

Plans have been completed by Messrs. Williams and Wastell of Oakland for an \$8,000 six room residence to be built on Spruce Street, Berkeley, for Mrs. Alberta F. Dozier. The house will have stucco exterior, composition roof and steel sash.

TO REMODEL STORE BUILDING

Preliminary plans are in progress in the office of a New York firm of architects for extensive alterations to the store building at 15th Street and Broadway, Oakland, owned by the Bond Stores, Inc. William I. Garren of San Francisco, will act as supervising architect.

DRIVE-IN MARKET

A one story frame and stucco drive-in market is to be constructed on the north side of San Pablo Avenue, near Solano, Albany, for an unnamed client, from plans by Earl R. MacDonald, 1710 Franklin Street, Oakland. The cost of the improvement is estimated at \$12,000.

SACRAMENTO SCHOOL BUILDINGS

Contracts have lately been let for two school projects in Sacramento, one for \$150,000 from the office of Charles F. Dean for a new High School assembly hall, and the other for an addition to the Crocker Grammar School for \$42,000, Starks and Flanders, architects.

BUILDING TRENDS ON THE PACIFIC COAST

Despite a depressed stock market, due to the tense situation in Europe, building continues to show an upswing. California is setting the pace again in the number as well as in the value of home mortgages accepted for insurance this year, according to the report of the Federal Housing Administration. The Northern California District Office states that it is likely that home construction in San Francisco will lend considerable impetus to the general business recovery.

Cumulative through January 31, 1939, there has been 271,814 Title I modernizing loans to the value of \$106,777,394; likewise for the same period there has been 69,100 Title 2 mortgages including refinancing of existing dwellings to the value of \$292,713,396; this speaks well for California.

Cumulative through January 31, 1939, there has been 271,814 builder and four real estate operatives and their indictment on a charge of conspiracy to defraud the government in Federal housing loans. It is reported that complaints similar to those which caused these arrests are being investigated in the San Francisco and Oakland territories.

Notice has been received of the President's approval of the sum of \$7,951,000 for low-rent housing projects in San Francisco.

Editor's Note—Complete data for the second, third and fourth quarters of this year, with a comparison of the same quarters in 1938 will appear in *The Architect & Engineer* in July, October and January. In addition to these quarterly reports this department will publish monthly notes of interest in the building industry, together with statistical data of special interest.

Design of the first of two projects is under way in the offices of architects here. One group will be built near McLaren Park; another to be known as the Sunnyvale project, though land for this unit has not yet been acquired. Construction will also begin soon on the Potrero Hill and Holly Park projects for which \$2,000,000 was allotted some time ago.

Latest advices reveal that in March of 1938 FHA in Northern California accepted for insurance 991 new home mortgages amounting to \$4,914,900; March of 1939 the number of applications was increased to 1165, with a value of \$5,311,800.

During the past year shelter was provided for 7,764 persons in San Francisco with an estimated gain in population of 10,615. This should indicate a homebuilding program steadily increasing in California.

Building permits for March 1939 were 63.60 higher than the month preceding. Activity was not alone recorded in California, but the eleven western states show gains of a substantial nature over the same month of last year. Los Angeles shows an unusually heavy increase, with San Francisco in second place. Other cities showing decided gains were Oakland, Denver, Salt Lake City, Seattle, Portland, Phoenix, San Diego and Sacramento.

TOTAL VALUE OF BUILDING PERMITS IN CALIFORNIA FOR FIRST THREE MONTHS OF 1939 AND 1938

January 1938		January 1939	
No. of Permits	Value	No. of Permits	Value
6,996	\$15,492,328	9,248	\$18,026,690
February 1938		February 1939	
6,583	11,606,778	8,652	14,655,878
March 1938		March 1939	
8,994	16,997,671	12,135	23,784,733

ELEVEN WESTERN STATES EXCLUSIVE OF CALIFORNIA FOR THE SAME PERIOD

January 1938	February 1938		March 1938	
	No.	Value	No.	Value
Arizona	151	\$ 585,869	143	\$ 166,900
Colorado	338	331,474	70	31,861
Idaho	54	37,220	90	165,321
Montana	24	23,175	12	6,970
Nevada	22	46,021	20	24,571
New Mexico	42	52,000	58	124,343
Oregon	430	408,555	442	1,377,806
Utah	118	279,737	28	145,690
Washington	590	811,949	656	1,744,377
Wyoming	31	49,915	18	65,560
TOTALS	1,800	\$2,625,935	1,537	\$3,855,669
January 1939	February 1939		March 1939	
	No.	Value	No.	Value
Arizona	170	\$ 294,338	127	\$ 263,775
Colorado	460	445,273	86	49,038
Idaho	68	97,472	88	108,626
Montana	19	118,260	29	35,300
Nevada	46	198,982	46	38,849
New Mexico	51	245,363	60	153,540
Oregon	385	488,593	400	1,134,243
Utah	93	199,892	7	24,782
Washington	724	1,369,267	656	1,058,698
Wyoming	27	32,890	26	52,509
TOTALS	2,043	\$3,490,330	1,525	\$2,919,362
			3,240	\$3,935,185
			190	\$ 690,569
			745	1,515,651
			140	93,235
			48	68,106
			86	221,212
			85	309,115
			693	884,320
			255	946,757
			1,229	1,460,388
			45	115,115

Bills Pending Affecting Practice of Architecture and Engineering

FOLLOWING are some of the more important bills introduced in the 1939 California Legislature affecting the practice of architecture, engineering and construction:

A. C. A. 62—MORE EXEMPTIONS

Amends Article XXIV of the State Constitution to include another exempt class from state civil service. Amendment reading: "Persons engaged by contract for the construction, or design, or preparation of drawings, or contract documents, or as consultant, for any State structure, building, road, or other improvements, or structure under State supervision."

A. B. 2110—HITS BUREAUCRACY

Amends Section 2 of the State Contract Act, relating to the State Department of Finance, to provide where act now states that the Department of Public Works must **prepare** any plans for State work, an alternative "**Or approve.**"

This bill is a companion to A. C. A. 62, as the two are obviously designed to make possible the "contracting out" of the work now performed by the Division of Architecture.

A. B. 1335—ENGINEERS NOT ARCHITECTS

Amends Section 5537 of the Professions and Business Code, relating to the practice of architecture, by prohibiting Structural Engineers from preparing plans, drawings, specifications as an architect. It does, however, allow anyone to prepare plans for any building or structure whose total content does not exceed 5000 cubic feet or the cost exceed \$1,000. An individual may for his own use prepare plans for structures, sheds, granaries, one or two car garages, barns, and minor buildings necessary for agricultural pursuits.

"No person may prepare plans, drawings, specifications, instruments of service or other data for any building or other structure exceeding a total content of five thousand cubic feet or the cost of which exceeds one thousand dollars, unless he is registered as an architect under this chapter, but an individual, may for his own personal use, prepare plans, drawings, specifications, instruments of service and other data for structures to be used as sheds, granaries, one or two car garages, barns, and minor buildings necessary for agricultural pursuits."

A. B. 1336—"ARCHITECTURAL ENGINEER"

Adds a new section to the Professions and Business Code relating to the creation of a class of architectural engineers under the supervision of the Board of Registration of Civil Engineers, allowing registered civil engineers having a knowledge of structural design to use the title of "Architectural Engineer" after being authorized by the board except that he shall not design any frame structure which consists of structural steel,

structures which exceed 500,000 cubic feet in content or any frame structure which costs in excess of \$50,000.

"Section 1. Section 6735.5 is hereby added to the Professions and Business Code, to read as follows:

"6735.5. Every registered civil engineer having a knowledge of the fundamental principles and theory of structural design, and with experience in the preparation of plans and specifications and the supervision of the construction of frame structures, may use the title of architectural engineer, and may design any frame structure which has for its principal materials wood, stone, brick, masonry, plaster, reinforced concrete, or any, or all, or any combination, of the foregoing materials, except that he shall not design any frame structure in which the framework consists of structural steel, nor any frame structure which exceeds a height of forty feet from the mean curb grade, if any, or the finish grade where no curb exists, nor any frame structure which exceeds 500,000 cubic feet in content, nor any frame structure which costs in excess of \$50,000.

"The title of 'architectural engineer' authorized by this section may only be used by a registered civil engineer who has been authorized to do so after a written or oral examination by the board. The procedure for fees, examinations and certificates to use the title architectural engineer shall be the same as that for a structural engineer."

A. B. 2549—BARS PRIVATE PRACTICE

This act prohibits any person employed by a public body as an architect, civil engineer, or land surveyor from accepting outside employment and prescribes a penalty for violation of the act by removal from his public employment, also the suspension or revocation of his license, except—

- (1) Where the employee is only employed on a part time basis. (He cannot use any public property in his outside employment).
- (2) If appointing power grants him a 30-day leave of absence without pay but in no case longer than thirty days in one year.
- (3) If appointing power grants leave of absence without pay when his services are not necessary by the public body during the course of leave. This must be by order or resolution.

A. B. 749—EXEMPTIONS TO LATERAL FORCE LAW

An act to amend section 19100 of the Health and Safety Code, relating to the exemption from the earthquake protection provision.

This act removes the restriction of earthquake protection from homes up to two families.

A. B. 749

Amends the Health and Safety Code.

"Section 1. Section 4 of the act cited in the title

hereof is hereby amended to read as follows:

"Section 4. This act shall not apply to the following buildings:

"(a) Any building not intended primarily for the occupancy by human beings and no part of which is located within the limits of an incorporated city or incorporated city and county.

"(b) Any building designed and constructed for use exclusively as a dwelling for not more than two families.

"(c) Any building on which work has actually been commenced prior to the effective date of this act.

"(d) Any building not intended primarily for occupancy by human beings, all or a part of which is located within the limits of an incorporated city and county, when such building is designed and constructed primarily for use in housing poultry, livestock, hay, grain or farming machinery and supplies."

A. B. 751—ENGINEERS FEES

A new act to set up the fees which may be charged by Civil Engineers and Structural Engineers for State, county, municipal, corporation, district or political subdivision work.

"Section 1. Section 19 is hereby added to the act cited in the title hereof, to read as follows:

"Section 19. Every registered civil engineer and structural engineer engaged in preparing plans, drawings, specifications, instruments of service, or other data for buildings or other structures for the State, or the county, municipal corporation, district or political subdivision, shall receive a fee based on the cost of the building or other structure not to exceed the following:

"(a) For the first \$100,000, or fraction thereof, at the rate of 5 per cent.

"(b) For the next \$100,000, or fraction thereof, at the rate of 4 per cent.

"(c) For the next \$100,000, or fraction thereof, at the rate of 3 per cent.

"(d) For the next \$100,000, or fraction thereof, at the rate of 2 per cent.

"(e) For the next \$100,000, or fraction thereof, at the rate of 1 per cent.

"(f) For all amounts in excess of \$500,000, at the rate of one-half of one per cent.

"A contract involving a fee for services described in this section in an amount greater than that permitted under this section is voidable in its entirety at the option of the State, county, municipal corporation, district, or political subdivision, and shall be void as to the excess amount in any event.

"Section 2. Section 20 is hereby added to said act to read as follows:

"Section 20. Every registered civil engineer or structural engineer shall at or before the time of executing a contract for the rendition of services within the scope of this act for the State, or a county, municipal corporation, district or political subdivision, execute a bond to the State of California with two or more individuals as sureties or with an admitted surety insurer as surety,

approved by the public agency for which such services are to be rendered, conditioned upon his faithful execution and performance of the contract, obedience of all laws relating to the subject matter of the contract, and satisfactory to the State, county, municipal corporation, district or political subdivision with which the contract is executed.

"If the contract for the rendition of services subject to this act is made by more than one registered civil engineer or structural engineer or a combination of civil engineers and structural engineers, the bond shall be joint and several. If an individual surety bond is given, the bond shall be not less than twice the contract price. If the bond is given by an admitted surety insurer, the bond shall be in an amount not less than the contract price."

A. B. 2672—STATE BOARD OF EXAMINERS

Changes the set up of the Department of Professional and Vocational Standards and makes two departments.

(1) Professional Standards.

(2) Vocational Regulations.

The State Board of Architectural Examiners, Northern and Southern Division, are placed under the Department of Professional Standards.

A. B. 2459—CHECKING PLANS

An act to amend sections 5 and 6 of the "Act to regulate the construction of buildings in the State of California, in respect to horizontal forces. Changes the wording to make it a violation of the act to design, or participate in the design of a building or issue a permit for the construction of any building which does not meet the requirements of the act or are exempt under the act. Names who will enforce the law within the cities, incorporated cities and counties. Places architects and civil engineers on the same footing; either can certify to the plans. Those checking the plans for the issuance of permits must also be licensed or a registered civil engineer.

S. B. 1214

Amends the section which created the State Board of Architectural Examiners. Changes the appointments of Jan. 15, 1941, from three to one and increases the appointments of Jan. 15, 1943 from two to four.

S. B. 186—PRACTICE OF ARCHITECTURE

An act to repeal Chapter I, comprising sections 5500 to 5604, inclusive, of Division III of the Professions and Business Code, and to add Chapter I, comprising sections 5500 to 5634, inclusive to Division III of the Professions and Business Code, relating to the practice of architecture and the powers and duties of the board governing such practice.

Briefly the important differences between the new "Architects' Practice Act" and the present Act are:

Organization

The present law is administered by a Board of ten members, five from the southern and five from the northern districts. The members are selected and appointed by the Governor for a term of four years. Each group functions as a District Board with a presi-

dent and secretary, with separate business offices and separate funds, and each Board has full power to hold hearings, punish offenders against the law, hold examinations, and grant provisional and temporary certificates. The only joint function of both District Boards is the granting of State Certificates and the making of rules by which the District Boards are governed.

The new law provides for a single Board of five members appointed by the Governor from a list selected from persons licensed to practice architecture in the State of California and nominated through the Chapters of the American Institute of Architects. Two members to be selected from the northern section, two from the southern section, and one at large.

These five members will function as a single Board with joint funds and powers. They will perform all the duties now carried by the District and State Boards, and will meet alternately in San Francisco and Los Angeles.

Provisional Certificates

The present law requires that a successful candidate for a certificate to practice architecture shall first receive a Provisional Certificate and having passed the probationary period without a protest being filed, shall be granted a State Certificate. Inasmuch as no Provisional Certificate has ever been questioned, either by formal charge or privileged communication, it has been decided to omit this very clumsy provision. The new act will grant the candidate a State Certificate immediately.

The certificate grants to the holder the right to the use of the title "Architect" and the right to practice architecture as long as he holds a valid, unrevoked license and is not delinquent in payment of his annual license fee.

Temporary Permit

The present act grants to out-of-state architects a "Temporary Certificate to Practice Architecture" for a single building. The new act grants him a "temporary permit" to erect a single structure.

Written Notice

This provision has been found to be a source of continual trouble and has enabled many persons to practice architecture by merely informing a possible client that he was not an architect. The new law will omit "Section 5" entirely.

Definition

The present act is weak in that it does not include a definition of architecture. It is sought to overcome this lack by the inclusion of a definition. After a careful study of working definitions that have been used in various parts of the country, it is believed that the one proposed will be a basis, not for restricting the legitimate practice of architecture, but to enable the Board to enforce the law against offenders who attempt to practice unlawfully.

"The practice of architecture consists of rendering or offering to render advice or service concerning the

planning, design or structural design of buildings or other structures, the repair or alteration of existing buildings or other structures, or any other service in connection with the planning or design or supervision of the construction of buildings or other structures."

Exemptions

This chapter does not affect:

- (a) An owner in making plans and drawings for his own building.
- (b) Civil engineers registered under Chapter 7 of Division III of this code in so far as they are engaged within the scope of the practice of civil engineering authorized by Chapter 7 of Division III.
- (c) Contractors licensed under Chapter 9 of Division III of this code in so far as they are engaged within the scope of the business of contracting authorized by Chapter 9 of Division III.
- (d) Cabinet and fixture makers who furnish materials and labor, and manufacture store fronts, fixtures and cabinet work in so far as they furnish drawings and specifications of their work.

Disciplinary Proceedings

These provisions have been broadened to cover cases that have come to the attention of the Board throughout the years under the act and now gives the Board wider powers to discipline offenders within the profession against whom charges have been brought.

In General

For legal reasons, many of the former rules and regulations, such as the minimum requirements of education and training, and the examination subject matter, were incorporated in the new act.

The recording of certificates is abolished as unnecessary.

The collection of fees will be handled by the Department of Professional and Vocational Standards, the Board being relieved of this duty. The question of delinquencies in the payment of fees will be automatic through the State Department.

The general arrangement of the new act was made by the Code Commission and makes for simplicity and ease of index and change.

CIVIL ENGINEERS AT SACRAMENTO

There was a large turn out of engineers in Sacramento April 17 when Sacramento Section, Am. Soc. C. E. were hosts to the San Francisco Section and members of the Structural Engineers Association of Northern California. The assembly was held in the spacious Elks Hall and followed an enjoyable dinner in the same building. The principal speakers were Edward Hyatt, State Engineer, who spoke on "The Conception and Development of the Central Valley Project in its Early Stage," and Walter R. Young, Construction Engineer, Bureau of Reclamation, whose subject was "The Design and Construction of the Central Valley Project." Saturday, the 18th, the visitors enjoyed a trip to Shasta Dam.

Architect Stresses Need of Better Regional Planning

IN THEIR physical development, American communities "are to a great extent in a lawless state," Abram Garfield of the Cleveland Chapter of the American Institute of Architects declares in a report made public by the Institute Committee on Public Information. There is a discouraging lack of regional planning, and destructive decentralization proceeds unchecked, Mr. Garfield finds.

"There is no city or good sized town which has escaped the decentralizing effects of the automobile," Mr. Garfield says. "Decentralization has in it great possibility for good when we know how to take advantage of it, but in the meanwhile there are drawbacks. It has destroyed property values in very large areas, reduced tax returns, built up tax delinquency and has added to the need for more expensive highways."

Mr. Garfield urges citizens throughout the country to organize, and not to wait for a fully equipped personnel to be educated in regional planning. A chief difficulty, he points out, is the scarcity of trained planners.

"Cities and towns do not need to wait for expert guidance," he continues. "If it can be obtained, so much the better but we cannot wait. The problems which have been dropped down on our towns and cities owing to the loss of real value within their limits and because of the necessity of more expensive highways to connect their centers with outlying districts are too insistent and can be helped greatly by citizen groups."

"City plan commissions have done invaluable work, but they cannot solve all of these problems alone. If a plan commission happens to have money enough to make a comprehensive city plan and undertakes to impose it without this preliminary citizen backing, it will have then to defend its plan against attack from all quarters."

"If the citizens themselves, beginning with their own neighborhoods and having their desires coordinated by a central committee, bring their problem and their suggestion of a solution to the plan commission and the legislative body, they are likely to meet with success."

"It must be remembered that legislative bodies and plan commissions have a great mass of routine business to transact. They are not always able nor do they have time to initiate action on all the needs of their community, and if demands and uncoordinated requests come in from all neighborhoods there will be little chance of attention."

"On the other hand, a responsible group of citizens is not burdened with routine and is not governed by expediency as the legislative body must be. It will have sorted out the neighborhood problems, concluded something as to the order of importance, and will have rearranged adjacent plans and ideas so that they work together and not against one another."

"A report to the legislative body from such a group will receive attention, the turmoil of public hearings will have been greatly reduced, and, while mistakes will

occur, they will be mistakes which have been more or less agreed to.

"A legislative body will almost always carry out the known wishes of the electors, and the problem is to organize the wishes. This may sound like a backward step since it appears to be throwing technical subjects into public debate. Technical problems must finally be decided by those who are qualified, but we yet lack a public interest without which greater mistakes are liable."

"There is no intention to suggest that expert guidance is not a very valuable thing if it can be obtained. Any one who has considered these problems has found, almost at once, that he has not thought about this or that feature which often is of first importance. When this occurs it must not be permitted to be discouraging because nothing will be more valuable to the final solution than early discussion, difference of opinion and a nearer understanding by the public at large. Public opinion is formed by trial and error."

"The immense and dramatic traffic solutions for Manhattan Island have caught the attention of the whole country, but it will be discovered that these solutions are not necessary for all cities. Citizens' committees which rush to councils and planning commissions with skyways for a solution will find that guidance is a very good thing, but one should be glad that the citizens' committee has caught the idea, if only to give it up."

To a great extent, planning bodies, except in the matter of traffic, receive almost no interested backing or encouragement, according to Mr. Garfield.

"All other departments of city administration, law, welfare, health, police, have their complementary citizens' groups, and the urgent advice of these groups has great weight with legislative bodies. Citizen organizations corresponding to the usual city departments have been in existence for a very long time and represent organized public opinion."

"It is not an overstatement to say that in our physical development we have been and, to a great extent, are yet in a lawless state. There is substantial agreement that robbery is not a good thing and when such an agreement is reached it is possible to make laws. There is yet no substantial agreement in regard to the use of one's property relative to the community so that the laws and ordinances governing this point are still somewhat on the defensive."

"A citizens group may begin with the old idea of neighborhood or street associations, but it cannot be left to the neighborhoods to form their associations as they may happen to think of it. There must be a central executive body which will help form the neighborhood associations so that, as far as possible, every area of the town is represented."

"Neighborhood associations begin with ash cans and having front lawns mowed on the same day but, under proper guidance, will consider their street lights, water

(Turn to Page 64)

A MILLION A DAY

Borrowers of the Home Owners' Loan Corporation, caught in the grip of the depression and threatened with the loss of their homes only a few years ago, today are paying \$1,000,000 every working day to charge off their debt to Uncle Sam. The borrowers now on the books of the Corporation have paid back 91 cents on every dollar obligation due to date.

These figures—ample proof that the American home owner does not regard the Government as a Santa Claus—were released in December by Charles A. Jones, General Manager of the Corporation, in a New Year's statement which declared that fully 83 per cent of the accounts now on HOLC books are in "excellent condition." And his statistics on foreclosures showed that the Corporation will end 1938 with acquisition of only slightly more than 11 per cent of the properties it refinanced, a percentage less than half that of any comparable group of private lending institutions.

Other figures quoted by Mr. Jones were encouraging items for the real estate market as a whole. HOLC rentals have jumped to \$28.25 per month, as compared to \$21.53 for August, 1935, an increase of 33 1/3 per cent. Sales of properties amounted to approximately 30,000, or more than one-fourth of the number the Corporation has acquired, despite a policy which permits sales only at a rate a stabilized market can absorb. And the HOLC still is spending more than \$100,000 each working day to improve the properties in its possession—a policy which is exerting a nation-wide influence on the protection of property values.

"These figures do not mean that HOLC has accomplished its task," said Mr. Jones. "There are thousands of borrowers now in satisfactory condition who still have delinquencies to overcome and who need our cooperation. There are approximately 135,000 whose ultimate fate depends on how they meet their problems in the next few years—borderline cases that require and deserve, all the help one properly can extend. There is a huge responsibility in the handling of the 115,000 properties we have acquired; even those that have been sold still present us with a collection job of great proportions.

"Despite all our efforts, tax delinquencies have become an increasingly difficult problem. It is a problem which we must overcome in the next few years. But the performance of HOLC borrowers in the troubled years since the Corporation was formed lends confidence as to the ultimate outcome.

"It is only a few years since foreclosures in this country were tabulated at the rate of 1,000 a day. More than a million home owners were literally without hope. Today, nearly three-fourths of that million are on their way to debt-free home ownership and thousands of others are making a good fight; the majority will win, barring unforeseen economic difficulties.

THE HOLLENBECK JR. HIGH SCHOOL BUILDING

designed by
A. F. ROSENHEIM

and featured in this issue

built by

BARUCH CORPORATION

General Contractors

625 South Olive Street

LOS ANGELES

"HOLC borrowers to date have paid back \$540,000,000, or 17 per cent of their entire principal indebtedness. About 1500 a month are paying off their loans in full; 44,000 already have paid in more than \$100,000,000 to get their names crossed off our books. We are collecting about \$15,000,000 a month in principal and \$9,500,000 in interest. Collections in October were 94.4 per cent of billings and in November were 92 per cent.

SCORES "MODERN" STYLE HOME

A house in the extreme so-called "modern" style, besides fighting with its neighbors, is sure to become as obsolescent as mission furniture, according to Talmage C. Hughes, secretary of the Detroit Chapter of the American Institute of Architects, who warns Americans that in general they show a deplorable lack of knowledge of how to attain a well designed and well built home.

"People who are smart in their dress and in the selection of their furniture, who would be mortified to be seen in an antiquated car or even a new one of questionable design, seem to prefer to 'bull their way through' the building of a home rather than to risk displaying lack of knowledge," Mr. Hughes declares.

"When people learn to be brutally frank and place their building problems in the hands of professional men just as they consult doctors, dentists, and lawyers,

then and only then may we expect to see a decided improvement in the design of small houses.

"Inappropriate design and poor construction are two of the greatest factors in the destruction of the value of the home. In the selection of a style, obsolescence, the enemy of value, should be borne in mind. Jigsaw exteriors, over-done bungalows, and false-gabled English were among many passing fads, while good Colonial, early American, and Georgian have stood the test of time. If well done, they will always be good.

"We should not design only in the past, but should adapt the tried and true to our own times, always contributing something to their development. No one can foretell what the future will bring forth but those who have made architecture a life study can make some very logical deductions. Bad planning is worse than no planning at all. When building, it costs a great deal more not to plan and design properly than to do so.

"Leaders in business and industry, the upper strata who erect large and important buildings, appreciate the need of an architect's services. Likewise, public buildings of monumental character attract the best talent in the profession.

"What is difficult to understand is the attitude of the vast multitude of the well-to-do who go to make up Mr. and Mrs. Average American. They are well informed except in their ideas about the designs of the homes in which they live, and the proper method of procedure when contemplating building. They may discuss a Governor Winthrop secretary and eighteenth century or modern furniture, but with houses they do not know Regency from 'Cape Cod Gothic.'

"When the Federal Government loans money to a man building a home, this is what it says about the planning: 'Ethical material dealers want to supply the proper specified materials; ethical contractors want to build homes to which they can point with pride; in all matters pertaining to planning and construction, your architect is qualified to advise you. His training and experience enable him to lay out the plans to the best possible advantage, and nothing can take the place of his expert supervision.'"

G. M. DISPLAY AT THE FAIR

Frigidaire Division, General Motors Sales Corporation, is represented at the Golden Gate International Exposition with a display which utilizes both light and color in a number of unique applications to emphasize the modernistic note, which is the general theme of the exhibit.

Color transparencies in a number of display units contribute to the general attractiveness and at the same time simplify the technical aspects of several of these subjects.

Motion, not so much to attract attention as to ex-

plain technique, is also employed to good effect without being overly done. X-ray views and cut-away models will carry the visitor into the inside phases of design and construction of a number of products.

The major item of educational value will be an exhibit depicting the current results of the company's research in the field of food preservation. Methods of elimination of food drying, together with technique for maintaining taste, color and flavor in stored foods for long periods, will interest practically every visitor.

Products on display will include representative items from the company's complete line, which includes domestic automatic refrigerators, electric ranges, electric water heaters, refrigerating equipment for every known commercial use, and air conditioning for both summer and winter application.

For enjoyment of guests, cool, refreshing drinking water will be provided by a number of the company's own electric water coolers, located at strategic points in the exhibit area.

WM. B. MUNDIE

William Bryce Mundie, nationally known architect, died at his home in Evanston, Ill., March 27, aged 76.

During the years 1898-1905, Mr. Mundie was architect of the Chicago Board of Education, a period when many large schools were erected. Mr. Mundie designed the Horticultural Building erected for the World's Columbian Exposition.

His long association with Major Wm. Le Baron Jenney was not only that of partner—the two men were close companions. In the office shortly before and during the activity of Mr. Mundie were men who likewise have left their mark on American architecture, a few of whom may be mentioned: D. H. Burnham, W. A. Holabird, Martin Roche, Louis H. Sullivan, Irving K. Pond, W. A. Otis, James Gamble Rogers, Howard VanDoren Shaw, Alfred H. Granger, D. Everett Waid, F. B. Meade.

OPENING FOR MECHANICAL ENGINEERS

Mechanical engineers who have had heating and ventilating experience are needed in the State service. An examination for associate mechanical engineer, \$260 a month, will be held May 13. Bulletins and application forms may be obtained from the branch offices of the State Personnel Board in San Francisco or Los Angeles or from the headquarters offices, 1025 P Street, Sacramento. Applications should be filed not later than May 6.

PARCEL P. O. BUILDING

Contracts are expected to be awarded within the next few weeks for the construction of a five story reinforced concrete parcel post office building at Mission, Howard and Spear Streets, San Francisco. There is an appropriation of \$2,000,000 for the structure.

Estimator's Guide

Giving Cost of Building Materials, Wage Scale, Etc.

Amounts given are figuring prices and are made up from average quotations furnished by material houses to San Francisco contractors. 3% Sales Tax on all materials but not labor.

All prices and wages quoted are for San Francisco and the Bay District. There may be slight fluctuation of prices in the interior and southern part of the state. Freight cartage, at least, must be added in figuring country work.

Bond—1½% amount of contract.

Brickwork—

Common, \$40 to \$45 per 1000 laid, (according to class of work).

Face, \$100 to \$110 per 1000 laid, (according to class of work).

Brick Steps, using pressed brick, \$1.25 lin. ft.

Brick Veneer on frame buildings, \$.75 sq. ft.

Common f.o.b. cars, \$14.00 at yard. Cartage extra.

Face, f.o.b. cars, \$45.00 to \$50.00 per 1000, carload lots.

HOLLOW TILE FIREPROOFING (f.o.b. job)

3x12x12 in.	\$ 84.00 per M
4x12x12 in.	94.50 per M
6x12x12 in.	126.00 per M
8x12x12 in.	225.00 per M

HOLLOW BUILDING TILE (f.o.b. job)

carload lots.	
8x12x5½	\$ 94.50
6x12x5½	73.50

Building Paper—

1 ply per 1000 ft. roll	\$3.50
2 ply per 1000 ft. roll	5.00
3 ply per 1000 ft. roll	6.25
Brownskin, 500 ft. roll	4.50
Brownskin, Pro-tect-o-mat, 1000 ft. roll	9.00
Sisalcraft, 500 ft. roll	5.00
Sash cord com. No. 7	\$1.20 per 100 ft.
Sash cord spot No. 7	1.90 per 100 ft.
Sash cord spot No. 8	2.25 per 100 ft.
Sash weights cast iron, \$50.00 ton.	
Nails, \$3.50 base.	
Sash weights, \$45 per ton.	

Concrete Aggregates—

Gravel (all sizes) \$1.45 per ton at bunkers; delivered to any point in S. F. County \$1.85.

Top sand	Bunker	Delivered
Concrete mix	\$1.45	\$1.85
Crushed rock, ¾ to ¾	1.60	2.00
Crushed rock, ¾ to 1½	1.60	2.00
Roofing gravel	1.60	2.00
City gravel	1.45	1.85
River sand	1.40	1.80
Delivered bank sand—\$1.00 per cubic yard at bunker or delivered.		

SAND—

River sand	Bunker	Delivered
Lapis (Nos. 2 & 4)	\$1.40	\$1.80
Olympia (Nos. 1 & 2)	2.00	2.40
Headlands plaster sand	\$1.80	\$2.20
Del Monte white	50c per sack	

CEMENT (all brands, cloth sacks) \$2.72 per bbl. f.o.b. car; deliv. \$2.90 per bbl., carload lots; less than carload lots, warehouse or delivered; 80c per sack. (Less 10c per sack returned, 2% 10th Prox.)

Common cement (all brands, paper sacks) carload lots \$2.52 per bbl. f.o.b. car; delivered, \$2.70; less than carloads delivered, 75c per sack; Discount on cloth sacks, 10c per sack. Cash discount on carload lots, 10c a barrel, 10th Prox.; cash discount less than carload lots, 2%.

Atlas White } 1 to 100 sacks, \$1.50 sack,
Calaveras White } warehouse or delivery; over 100
Medusa White } sacks, \$1.25; 2% discount 10th of month.

Forms, Labors average \$40.00 per M. Average cost of concrete in place, exclusive of forms, 35c cu. ft.; with forms, 60c.

4-inch concrete basement floor 12½c to 14c per sq. ft.

Rat-proofing 7½c

Concrete Steps \$1.25 per lin. ft.

Dampproofing and Waterproofing—

Two-coat work, 20c per yard.

Membrane waterproofing—4 layers of saturated felt, \$4.50 per square.

Hot coating work, \$1.80 per square.

Medusa Waterproofing, 15c per lb., San Francisco Warehouse.

Tricoccol waterproofing.

(See representative.)

Electric Wiring—\$12.00 to \$15.00 per outlet for conduit work (including switches).

Knob and tube average \$3.50 per outlet.

Elevators—

Prices vary according to capacity, speed and type. Consult elevator companies.

Average cost of installing an automatic elevator in four-story building, \$2800; direct automatic, about \$2700.

Excavation—

Sand, 60 cents; clay or shale \$1 per yard.

Teams, \$12.00 per day.

Trucks, \$22 to \$27.50 per day.

Above figures are an average without water. Steam shovel work in large quantities, less; hard material, such as rock, will run considerably more.

Fire Escapes—

Ten-foot galvanized iron balcony, with stairs, \$115 installed on new buildings; \$140 on old buildings.

Floors—

Composition Floors—22c to 40c per sq. ft. In large quantities, 16c per sq. ft. laid.

Mosaic Floors—80c per sq. ft.

Duraflex Floor—23c to 30c sq. ft.

Rubber Tile—50c to 75c per sq. ft.

Terezo Floors—45c to 60c per sq. ft.

Terezo Steps—\$1.60 lin. ft.

Hardwood Flooring (delivered to building)—

1½x2½" T & G Maple
 \$ 88.00 M ft. |

1½x2½" T & G Maple
 115.00 M ft. |

¾x3½" sq. edge Maple
 100.00 M ft. |

	1½x2½"	¾x2"	¾x2"
	T&G	T&G	Sq. Ed.
Clr. Old. Oak	\$120.00 M	\$ 82.50 M	\$110 M
Sel. Old. Oak	93.00 M	69.50 M	84 M
Clr. Pla. Oak	102.00 M	74.50 M	86 M
Sel. Pla. Oak	97.00 M	62.50 M	76 M
Clear Maple	111.00 M	100.00 M	
Laying & Finishing	14c ft.	12c ft.	10c ft.
Wage—Floor layers, 10c.			

Note—Above quotations are all board measure except last column which is sq. ft.

Glass (consult with manufacturers)—

Double strength window glass, 20c per square foot.

Plate 75c per square foot (unglazed) in place, \$1.00.

Art, \$1.00 up per square foot.

Wire (for skylights), 40c per sq. foot.

Obscure glass, 30c square foot.

Glass bricks, \$2.40 per sq. ft., in place.

Note—If not stipulated add extra for setting.

Heating—

Average, \$1.90 per sq. ft. of radiation, according to conditions.

Warm air (gravity) average \$40 per register.

Forced air, average \$60 per register.

Iron—Cost of ornamental iron, cast iron, etc., depends on designs.

Lumber (prices delivered to bldg. site).

No. 1 common	\$29.00 per M
No. 2 common	27.00 per M
Select O. P. common	34.00 per M
2x4 No. 3 form lumber	24.00 per M
1x4 No. 2 flooring VG	47.00 per M
1x4 No. 3 flooring VG	47.00 per M
1x6 No. 2 flooring VG	60.00 per M
1½x4 and 6, No. 2 flooring	60.00 per M

Slash grain—

1x4 No. 2 flooring	\$43.00 per M
1x4 No. 3 flooring	40.00 per M
No. 1 common run T. & G.	30.00 per M
Lath	5.25 per M

Shingles (add cartage to price quoted)—

Redwood, No. 1	\$1.10 per bble.
Redwood, No. 290 per bble.
Red Cedar	1.10 per bble.

Plywood—Douglas Fir (ad cartage)—

"Plyscord" sheathing (unsanded) 5/16" 3-ply and 48"x96"

Wellboard Grade (sound one side)—

¾" 3-ply 48"x96"	\$37.50 per M
Concrete Form Panels (special core & glue) ¾" 5-ply 48"x96"	\$110.00 per M
If tiled	\$5.00 extra per M

Millwork—Standard.

O. P. \$85.00 per 1000. R. W., \$90.00 per 1000 (delivered).

Double hung box window frames, average with trim, \$6.50 and up, each.

Doors, including trim (single panel, 1¾ in. Oregon pine) \$8.00 and up, each.

Doors, including trim (five panel, 1¾ in. Oregon pine) \$6.00 each.

Screen doors, \$3.50 each.

Patent doors, 25c a sq. ft.

Cases for kitchen pantries seven ft. high per lineal ft., \$8.00 each.

Dining room cases, \$9.00 per lineal foot. Rough and finish about 75c per sq. ft.

Labor—Rough carpentry, warehouse heavy framing (average), \$17.50 per M. For smaller work average, \$35.00 to \$45.00 per 1000.

APRIL, 1939

61

Marble—(See Dealers)

Painting—

Two-coat work	36c per yard
Three-coat work	50c per yard
Cold Water Painting.....	10c per yard
Whitewashing	4c per yard
Turpentine, 65c per gal., in 5 gal. cans, and 55c per gal. in drums.	
Raw Linseed Oil—97c gal. in bbls.	
Boiled Linseed Oil—\$1.00 gal. in bbls.	
Medusa Portland Cement Paint, 20c per lb.	

Pioneer or Dutch Boy White Lead in Oil (in steel kegs).

	Per Lb.
1 ton lots, 100 lbs. net weight.....	10 ¹ / ₂ c
500 lbs. and less than 1 ton lots.....	10 ¹ / ₂ c
Less than 500 lb. lots.....	11c

Pioneer or Dutch Boy Red Lead and Litharge (in steel kegs).

1 ton lots, 100 lb. kegs, net weight.....	10 ¹ / ₂ c
500 lbs. and less than 1 ton lots.....	10 ¹ / ₂ c
Less than 500 lb. lots.....	11c

Pioneer Red Lead in Oil (in steel kegs)

1 ton lots, 100 lb. kegs, net weight.....	11 ¹ / ₂ c
500 lbs. and less than 1 ton lots.....	11 ¹ / ₂ c
Less than 500 lb. lots.....	12c

Note—Accessibility and conditions cause some variance in costs.

Patent Chimneys—

6-inch	\$1.25 lineal foot
8-inch	1.75 lineal foot
10-inch	2.25 lineal foot
12-inch	3.00 lineal foot

Plastering—Interior—

	Yard
1 coat, brown mortar only, wood lath.....	\$0.60
2 coats, lime mortar hard finish, wood lath	70
2 coats, hard wall plaster, wood lath.....	72
3 coats, metal lath and plaster.....	1.25
Keene cement on metal lath.....	1.30
Ceilings with 3/4 hot roll channels metal lath (lath only).....	1.10
Ceilings with 3/4 hot roll channels metal lath plastered.....	1.85
Single partition 3/4 channel lath 1 side (lath only).....	.85

Single partition 3/4 channel lath 2 inches thick partition.....	\$2.90
4-inch double partition 3/4 channel lath 2 sides (lath only).....	1.70
4-inch double partition 3/4 channel lath 2 sides plastered.....	3.80
Thermax single partition, 1" channels; 2/4 overall partition width. Plastered both sides.....	2.50
Thermax double partition; 1" channels; 4/4 overall partition width. Plastered both sides.....	3.10
3 coats over 1" Thermax nailed to one side wood studs or joists.....	1.25
3 coats over 1" Thermax suspended to one side wood studs with spring sound isolation clip.....	1.40

Plastering—Exterior—

2 coats cement finish, brick or concrete wall.....	\$1.00
3 coats cement finish, No. 18 gauge wire mesh.....	1.50
Wood lath, \$7.50 to \$8.00 per 1000.....	17
2.5-lb. metal lath (dipped).....	.20
2.5-lb. metal lath (galvanized).....	.28
3.4-lb. metal lath (dipped).....	.22
3.4-lb. metal lath (galvanized).....	.28
3/4-inch hot roll channels, \$72 per ton.....	
Finish plaster, \$18.90 ton; in paper sacks. Dealer's commission, \$1.00 off above quotations. \$13.85 (rebate 10c sack).....	
Lime, 1-c-b, warehouse \$2.25 bbl.; cars, \$2.15 lime, bulk (ton 2000 lbs.), \$16.00 ton.....	
Wall Board 5 ply, \$50.00 per M.....	
Hydrate Lime, \$19.50 ton.....	1.25 per hour
Plasterers Wage Scale.....	1.25 per hour
Lathers Wage Scale.....	1.10 per hour
Head Carriers Wage Scale.....	
Composition Stucco—\$1.80 to \$2.00 sq. yard (applied).....	

Plumbing—

From \$70.00 per fixture up, according to grade, quantity and runs.

Roofing—

"Standard" tar and gravel, \$6.50 per sq. for 30 sqs. or over.
 Less than 30 sqs. \$7.00 per sq.
 Tile, \$20.00 to \$35.00 per square.
 Redwood Shingles, \$7.50 per square in place.
 Copper, \$16.50 to \$18.00 per sq. in place.
 Cedar Shingles, \$8.00 per sq. in place.
 Recoat, with Gravel, \$3.00 per sq.
 Asbestos Shingles, \$15 to \$25 per sq. laid.

Slate, from \$25.00 to \$60.00 per sq. yard, according to color and thickness.
 Shakes—12" x 24" resawn \$11.50 per sq
 1/2" x 25" resawn 10.50 per sq
 1/2" x 25" tapered 10.00 per sq
 Above prices are for shakes in place.

Sheet Metal—

Windows—Metal, \$1.75 a sq. foot.
 Fire doors (average), including hardware \$1.75 per sq. ft.

Skylights—(not glazed)

Copper, 90c sq. ft. (flat).
 Galvanized iron, 30c sq. ft. (flat).
 Vented hip skylights 60c sq. ft.

Steel—Structural

\$120 ton (erected), this quotation is an average for comparatively small quantities. Light truss work higher. Plain beams and column work in large quantities \$90 to \$100 per ton.

Steel Reinforcing—

\$80.00 to \$120.00 per ton, set.

Stone—

Granite, average, \$6.50 cu. foot in place
 Sandstone, average Blue, \$4.00, Boise \$3.00 sq. ft. in place.
 Indiana Limestone, \$2.80 per sq. ft. in place.

Store Fronts—

Copper sash bars for store fronts, corner, center and around sides, will average 75c per lineal foot.
 Note—Consult with agents.

Tile—Floor, Wainscot, etc.—(See Dealers)

Asphalt Tile—18c to 28c per sq. ft. installed.

Wall Tile—

Glazed Terra Cotta Wall Units (single faced) laid in place—approximate prices:
 2 x 6 x 12 \$1.00 sq. ft.
 4 x 6 x 12 1.15 sq. ft.
 2 x 8 x 16 1.10 sq. ft.
 4 x 8 x 16 1.30 sq. ft.

Venetian Blinds—

40c per square foot and up. Installation extra.

THE BUILDERS' EXCHANGE OF SAN FRANCISCO STANDARD WAGE SCALE

For mechanics employed on construction work in the Bay Region. Effective September 1, 1937

CRAFT	Journeymen Mechanics
Asbestos Workers	\$ 8.00
Bricklayers (8h-5d)	6.75
Bricklayers' Hodcarriers (6h-5d)	10.50
Cabinet Workers (Outside) (5d)	8.00
Caitson Workers (Open)	6.40
Carpenters (8h-5d)	10.00
Cement Finishers (8h-5d)	10.00
Cork Insulation Workers (8h-5d)	9.00
Electric Workers (8h-5d)	11.00
Electrical Fixture Hangers	8.00
Elevator Constructors	10.40
Engineers, Portable & Hoisting	9.60
Glass Workers (8h-5d)	9.60
Hardwood Floormen	9.00
Housesmiths, Architectural Iron (Shop) (8h-5d)	9.00
Housesmiths, Architectural Iron (Outside) (8h-5d)	10.00
Housesmiths, Reinforced Concrete or Rodmen (8h-5d)	10.00
Iron Workers (Bridge and Structural) Including Engineers (8h-5d)	12.00

CRAFT	Journeymen Mechanics
Laborers, Building (8h-5d)	\$ 6.00
Laborers, Common (8h-5d)	6.00
Lathers, Channel Iron (8h-5d)	9.00
Lathers, All Others	9.00
Marble Setters (8h-5d)	10.50
Marble Setters' Helpers (8h-5d)	5.50
Millwrights	9.00
Model Makers (\$1.50 per hr-6h)	9.00
Modelers (\$2 per hr-6h)	12.00
Model Casters	7.20
Mosaic and Terrazzo Workers (Outside)	9.00
Painters (7h-5d)	8.50
Painters, Varnishers and Polishers (Outside)	9.00
Pile Drivers and Wharf Builders	9.00
Pile Drivers' Engineers	10.00
Plasterers (6h-5d)	10.00
Plasterers' Hodcarriers (6h-5d)	7.50
Plumbers (8h-5d)	11.00
Roofers, Composition (8h-5d)	9.00
Roofers, All Others (8h-5d)	8.00
Sheet Metal Workers (8h-5d)	10.00
Sprinkler Fitters	10.00

CRAFT	Journeymen Mechanics
Steam Fitters (8h-5d)	\$11.00
Stair Builders (8h-5d)	9.00
Stone Cutters, Soft and Granite (8h-5d)	8.00
Stone Setters, Soft and Granite	12.00
Stone Derricemen	9.00
Tile Setters (8h-5d)	11.00
Tile Setters' Helpers (8h-5d)	6.50
Tile, Cork and Rubber (8h-5d)	9.00
Welders, Structural Steel Frame on Buildings	11.00
Welders, All Others on Buildings	9.00
Dump Truck Drivers, 2 yards or less	6.00
Dump Truck Drivers, 3 yards	6.50
Dump Truck Drivers, 4 yards	7.00
Dump Truck Drivers, 5 yards	7.00
Dump Truck Drivers, 6 yards	7.50
Truck Drivers of Concrete Mixer Trucks: 2 yards or less	6.50
3 yards	7.00
4 yards	7.50
5 yards	7.50
6 yards	8.00

GENERAL WORKING CONDITIONS

- Eight hours shall constitute a day's work for all crafts except as otherwise noted.
- Plasterers' Hodcarriers, Bricklayers' Hodcarriers, Roofers' Laborers, and Engineers, Portable and Hoisting, shall start 15 minutes before other workmen, both at morning and at noon.
- Five days, consisting of not more than eight hours a day, on Monday to Friday inclusive, shall constitute a week's work.
- Transportation costs in excess of twenty-five cents each way shall be paid by the contractor.
- Overtime shall be paid as follows: For the first four hours after the first eight hours, time and one-half. All time thereafter shall be paid

- double time. Saturdays (except Laborers), Sundays and holidays, from 12 midnight of the preceding day, shall be paid double time.
- On Saturday, Laborers shall be paid straight time for an eight-hour day.
- Where two shifts are worked in any twenty-four hours, shift time shall be straight time. Where three shifts are worked, eight hour's pay shall be paid for seven hours on the second and third shifts, allowing one-half hour for lunch.
- All work, except as noted in paragraph 9, shall be performed between the hours of 8 a.m. and 5 p.m.
- In emergencies, or where premises cannot be vacated until the close of business, men then

- reporting for work shall work at straight time. Any work performed on such jobs after midnight shall be paid time and one-half up to four hours of overtime and double time thereafter, provided, that if a new crew is employed on Saturdays, Sundays or holidays which has not worked during the five preceding days, such crew shall be paid time and one-half.
- Recognized holidays to be: New Year's Day, Decoration Day, Fourth of July, Labor Day, Admission Day, Thanksgiving Day, Christmas Day.
- Men ordered to report for work, for whom no employment is provided, shall be entitled to two hours' pay.

ARCHITECTS' BULLETIN

Issued For

THE STATE ASSOCIATION OF CALIFORNIA ARCHITECTS
Northern Section

STATE ASSOCIATION MEMBER
OF THE
AMERICAN INSTITUTE OF ARCHITECTS

Editor

Harris C. Allen

Address all communications for publication in the Bulletin to the Editor (Harris C. Allen) 557 Market Street, Room 218, San Francisco, California.

Board of Control

Harris C. Allen Otto G. Hintermann
Harry Michelsen Wayne S. Hertzka

State Association Officers

President.....Sylvanus B. Marston, Pasadena
Vice-President.....Gwynn Officer, Berkeley
Secretary.....Wayne S. Hertzka, San Francisco
Treasurer.....Robert H. Orr, Los Angeles

Regional Director, A. I. A.

Albert J. Evers, San Francisco

Delegate Regional Director, Southern California

Gordon B. Kaufmann, Los Angeles

Executive Board—Northern Section
Officers

President.....Gwynn Officer, Berkeley
Vice-President.....Ernest E. Weihe, San Francisco
Secretary.....Wayne S. Hertzka, San Francisco
Treasurer.....Otto G. Hintermann, San Francisco

Directors

Harry J. Devine R. H. Reimers
Wm. J. Merchant Harold Weeks

Executive Board—Southern Section
Officers

President.....Sylvanus B. Marston
Vice-President.....Louis N. Crawford
Secretary.....Winsor Soule
Treasurer.....Robert H. Orr

Directors

Merrill W. Baird Abe Edelman
Harold C. Chambers George D. Riddle

Advisors—Northern Section

Harris C. Allen *San Francisco*
J. K. Ballantine, Jr. *(Secretary)*
Sam. Lightner Hyman
Wm. G. Merchant
Jas. F. McGuiness
Dodge A. Riedy
Harold H. Weeks
Ernest E. Weihe
Albert R. Williams
Fred. H. Reimers *(President)*
C. A. Caulkins *North Bay District*
Peter Sala *Lower San Joaquin District*
J. U. Cloudsley *(Secretary)*
Edw. W. Kress *Santa Clara Valley*
Mario Corbett *Son Mateo*
Alden Cambell *Sacramento*
Ernest J. Kump *Upper San Joaquin*
Dole F. Thomsen *Palo Alto*
Norman W. Sexton *Marin*
Geo. P. Simonds *East Bay*
Chester Treichel *East Bay*
Gwynn Officer *Berkeley*
F. T. Georgeson *Redwood Empire*
Casebolt Dakin *Upper Sacramento*
Ralph Taylor *Lassen District*

LEGISLATION

MEMBERS of the Association have already been informed that the unreasonable bills regulating architectural fees have been withdrawn. Their excess doomed them, aided by the light of publicity. To reveal such attacks upon professional—and public—welfare, is peculiarly the province of the Association. In this case, the attack was so open, so extreme, so obviously iniquitous, that it was a comparatively easy matter to discover and to confound it. In other cases, where schemes to undermine professional service to the building public are disguised in ambiguous terms, or tucked in under riders to bills not clearly pertaining to the building industry, recognition, publicity and timely action are far from easy.

The difference between the effectiveness of individual and organized efforts is one of the principal reasons for organizing architects of the State into one Association.

The Architectural Practice Act has had the required three readings in the Senate without sign of opposition. If, as and when passed by the Senate the bill will go to the Assembly.

DECORATORS MEET Our friends, the American Institute of Interior Decorators, have just held a successful convention which profited by having available at Treasure Island a number of striking examples of their art for public demonstration. Results of continuing closer cooperation between architects and decorators are more and more satisfactory. Out of the confusion of early treatment to meet changes in contemporaneous design, there is emerging a more logical, more comprehensive, more human approach to individual problems; the universal, mechanical prescription for all cases is little in evidence now. This applies to both architect and decorator and, as previously said, to their better cooperation.

QUESTIONNAIRES During recent years, the mails have abounded in "Questionnaires" asking people to indicate their preference on all sorts of political, commercial, statistical points. These extend, in various forms, to newspapers and periodicals, chiefly in the coupon type which the reader is urged to clip and mail in order to receive detailed information about product or method.

Most of us disregard such appeals, partly because it is too much trouble to fill out the forms and address and stamp and mail the envelope, and partly because we do not wish or need the information, or because we already possess it; or because we object to mutilating pages of a journal we wish to file.

As an association of professional men and women, we can not, of course, advise any discriminating action or assist in any advertising campaign. However, it may be pointed out that when a questionnaire or coupon is intended to ascertain whether the subscriber really reads the magazine—and if such magazine is one which the subscriber believes is beneficial to the profession

and the industry—it can do no harm, and may well do good, to answer such queries as may come under this head.

Incidentally, there is so much new information coming out all the time that architects need hardly fear getting too much, if they wish to keep pace with the times.

ARCHITECTURAL CLUB

The San Francisco Architectural Club is to be congratulated upon the attractive exhibit it is maintaining at the Golden Gate Exposition. This has been installed in the east wing of the Homes and Gardens Building, on the main floor next the Gas Exhibit, on the south side of the Court of Reflections. The exhibit will be renewed from time to time. It is a real contribution to the cause of good architecture.

SOUTHERN CALIFORNIA CHAPTER

A program for professional betterment was outlined by Donald Beach Kirby to members of Southern California Chapter, American Institute of Architects, at the regular monthly meeting of the Chapter in Los Angeles, March 14.

Mr. Kirby, chairman of the Chapter's professional betterment committee, stated that the program is the result of a survey and analyses of the architectural profession made locally by Jack Little, public consultant. It outlines in an interesting manner how forces are apparently working against the architect, how these negative forces may be overcome and what benefits may be expected from the program.

A report on bills affecting the practice of architecture, engineering and construction, introduced in the 1939 session of the California Legislature, was made by Earl T. Heitschmidt, chairman of the legislative committee. Mr. Heitschmidt told of the activities of the committee in the interest of these bills and was given a vote of thanks for his work. A. M. Edelman, member of the California State Board of Architectural Examiners, and S. B. Marston, president of the State Association of California Architects, commented on certain sections of existing and pending bills.

Material for the Chapter book, a volume of photographs of residential work done by Southern California architects, is practically all assembled and will go to the printer shortly, according to Paul Robinson Hunter, chairman of the committee in charge of this activity.

Delegates to the 1939 national convention of the Institute were elected. They are: Earl T. Heitschmidt, Roland E. Coate, Eugene Weston, Jr., Gordon B. Kaufmann, David C. Allison, Pierpont Davis, A. M. Edelman and David J. Witmer. Alternates are: Myron Hunt, Carleton M. Winslow, Ben H. O'Connor, John C. Austin, Reginald D. Johnson, Samuel E. Lunden and Ralph Flewelling.

The convention will be held jointly with the International Association of Architects in Washington, D. C., in September. Following the business session of the

convention, the delegates will adjourn and go to New York City in a body for the purpose of visiting the New York Fair.

Bernard Herzbron, who recently transferred from the New York Chapter to the local Chapter, was introduced by Carleton M. Winslow. Edgar Bissantz presided.

BETTER REGIONAL PLANNING

(Concluded from Page 58)

hydrants, changes of roadways, parks, playgrounds, schools, and the general desire to keep the neighborhood free from damaging intrusion by inappropriate occupancy.

"It may be the neighborhood will conclude that it needs stores or any other new thing. In any case, the neighborhood association will determine its own needs and desires, and then take them to the central committee, which will undertake to approve, disapprove or coordinate and to use its influence with the town council to bring about the change that is asked for.

"If this seems to apply only to small towns which have no planning commissions nor even a zoning law, it nevertheless applies to all cities. It is based upon the sound theory that any plan which is universally wanted is a better thing than another plan which is imposed upon the community.

"It is quite generally recognized that a regional plan means much more than a highway and road plan. It means a knowledge of the entire area so that someone finally knows the better, even if not the best, use of each piece of land; it means that industry, commerce and traffic are so placed and arranged that they may be reasonably expected to prosper.

"It finally means that when these necessities of material progress are properly cared for the remnant, the large and important remnant, becomes a place where people can live with a sense of security which is now lacking."

PLANNING THE LITTLE HOUSE

"The prospective home builder should select his architect as carefully as he selects his doctor or his lawyer," says Alice Waugh in her new book, "Planning the Little House," just published by McGraw-Hill. "A house is far too difficult and complicated an undertaking for one who has not had special training."

"When the building allowance is limited," the author writes, "the owner may be tempted to try to get along without the services of an architect, in order to save the cost of his fee. Such a policy is false economy, for a good architect who is experienced in designing small houses contributes the full amount of his fee in the service he renders."

Miss Waugh, of the faculty of Iowa State College, is a well known authority on small house planning.

MODERNIZED PRODUCTS

Brief Notes on New Materials and Equipment in the Building Industry.

195. HARDWOODS

Another issue of that very fine little magazine published by the E. L. Bruce Company. It is profusely illustrated and tells of all the important uses for the lumber products which this company manufactures. By clipping the coupon below you may have a copy.

196. PAINTING

The Aluminum Company of America has just issued a booklet, one of the most interesting that we have seen for some time. It is called "Fifteen Years Behind the Brush" and deals with that important phase of American building "Painting." Send for your copy.

197. STAINED SHINGLES

A very informative bulletin by the West Coast Stained Shingle Company. It treats of Creo-Dipt Stained Shingles and Zephyr Double Wall construction. This should prove of more than ordinary interest to the profession.

198. LEAD AND OIL

The March issue of "Lead," published by Lead Industries Association, is just out with news of the uses of lead and oils in the preservation of dwellings and other buildings. The coupon will bring you a copy.

199. STAIRWAYS

A booklet from the Pacific Manufacturing Company dealing with "Marco" stairways, a product of this company, is now ready for distribution. There is much of interest in this tiny folder. Send for your copy.

200. CONCRETE BUILDINGS

The Portland Cement Association has just issued a very fine booklet entitled "Concrete for Industrial Buildings and Garages." It contains a store of valuable information and is well illustrated.

201. INSULATION

From the Celotex Corporation there has come a brochure on insulat-

ing a six room dwelling by means of their Guaranteed Insulation. It is stated in this brochure that the above can be accomplished for as little as \$93.30; send for your copy and learn how this can be done.

202. PLUMBING FIXTURES

Another Mueller Record. This interesting magazine is always welcome as it contains facts and some news of timely interest. It is issued by the Mueller Company.

203. LIGHT CONDITIONING

The Pacific Coast Electrical Bureau has issued another booklet on lighting. This one has for a title "There's Style in Light Conditioning, Too." It is very well illustrated.

204. CORK FLOORS

A folder from the Armstrong Cork Company tells about "Monocork," a new plastic floor of cork and rubber. The coupon will bring your copy.

205. NICKEL PRODUCTS

"Inco," Vol. 16, No. 2, is out. Published by the International Nickel Company, the booklet is one of a series dealing with the various uses of nickel from which this company manufactures so many articles used in the building industry.

206. PROTECTIVE COATINGS

We have a new company heard from through the medium of a most interesting booklet, the Technical Protective Coatings Company. It is called an "Encyclopedia of Corrosion Prevention, Correction, Protection, and Maintenance Coatings." This should be of vital interest to the architectural and engineering professions. Send for a copy by using the coupon.

207. 2-GLASS INSULATION

An old friend is back again, Libbey-Owens-Ford Glass Company's always interesting brochures on window conditioning. This one deals with double glass insulation.



CONFERENCE

208-209. MARBLE TILE

Two folders from the Vermont Marble Company which illustrate a new tile of marble called "Markwa" and the use of Vermont Marble Mantels. Both these folders are well illustrated and most interesting. The coupon will bring you copies of both should you desire to have them.

FREE FOR THE ASKING

Check items on coupon, paste on letter head or postal card, and mail to Architect and Engineer.

Architect and Engineer
68 Post Street
San Francisco, Calif.

Please send me literature on the following items as checked below. This request places me under no obligation.

- | | |
|------------------------------|----------------------------------|
| 195 <input type="checkbox"/> | 202 <input type="checkbox"/> |
| 196 <input type="checkbox"/> | 203 <input type="checkbox"/> |
| 197 <input type="checkbox"/> | 204 <input type="checkbox"/> |
| 198 <input type="checkbox"/> | 205 <input type="checkbox"/> |
| 199 <input type="checkbox"/> | 206 <input type="checkbox"/> |
| 200 <input type="checkbox"/> | 207 <input type="checkbox"/> |
| 201 <input type="checkbox"/> | 208-209 <input type="checkbox"/> |

My Name
Name of Company
Street
City State

Survey Finds 40% of Urban Homes in "Good Condition"

COLONEL F. C. Harrington, Works Progress Administrator, early in January, made public a comprehensive report disclosing that only 40 per cent of the 8,000,000 American homes covered in surveys of 203 urban communities, were considered in "good condition."

The report is "Urban Housing: A Summary of Real Property Inventories Conducted as Work Projects, 1934-1936." The inventories, covering approximately the number of homes sufficient to house 45 per cent of the urban families in 1930, were begun as projects under the Civil Works Administration and the Federal Emergency Relief Administration, and carried on by the WPA.

More than 16 per cent of the homes covered by these studies, with the exception of residences in New York City, were rated "unfit for use" or in need of major repairs to make them habitable. More than 15 per cent had no private flush toilets, 20 per cent were without private bath or shower, and more than 40 per cent lacked central heating.

Most of these inventories for the individual cities were set up in response to local demands and were designed to meet specific local needs through the determination of the residential housing situation in the areas surveyed. The results have been summarized in a report issued by the WPA Division of Social Research under the direction of Corrington Gill, Assistant Administrator in charge of Research and Statistics.

"From these surveys has been assembled the most detailed body of statistical information now available on the physical characteristics of housing in the United States," he said in the letter of transmittal. "Such information provides the data essential for analysis of various problems connected with real estate and aids in the formation of sound programs throughout the country."

While sub-standard housing is not limited to certain sections of the country, Mr. Gill said, the extent and characteristics of such housing vary from region to region. He called attention to the findings of the surveys that 32 per cent of all city dwelling units in the Southeast lacked private indoor flush toilets while 19 per cent in the Northwest and 12 per cent in the Northeast were without that facility. Fifteen per cent of the urban dwelling units in the Southwest, seven per cent in the Northwest and 3.5 per cent in the Northeast were without running water.

Installed bathing facilities were found to be even less common than private flush toilets. More than 40 per cent of the dwelling units in Southeastern cities were without private bath tubs or showers; in the Northwest 21 per cent and in the Northeast 20 per cent were without these facilities.

"It is generally agreed that the absence of sanitary

facilities, unsafe condition of physical structure, overcrowding and the presence of extra families are all factors which render a dwelling unit sub-standard," Mr. Gill added.

Findings presented by the report include:

There was more than one person per room in 17 per cent of the dwelling units visited.

Five per cent of the families covered lived in dwelling units already containing a "primary" family.

Single-family houses were the dominant type of residential structure, but one-half of the dwelling units were in buildings designed for more than one family.

Nearly two-fifths of the units were occupied by their owners.

Most single family homes occupied by their owners were valued at less than \$5,000 and about one-fifth at less than \$2,000.

In rented units, the average monthly rental was about \$25, with a wide variation from city to city and section to section of the country.

Electricity was the usual means of lighting, and either electricity or gas was the common fuel used for cooking. In the Southeast, however, 25 per cent of the urban homes were without gas or electric lighting and nearly half were without gas or electric cooking equipment. More than half the structures inspected were built before 1915 and a quarter before 1895. Wood was found to be the prevailing material for exteriors in all regions except New York City, the proportion ranging from 65 per cent in the Northeast to 82 per cent in the Southeast.

The data on individual structures and dwelling units are confidential, but summary tabulations have been released for city blocks, housing districts, census tracts, and other tabulating units. Through these reports information on the general housing situation for each city and for areas within the city may be secured. In most cases the complete local report is available in the community surveyed. The final city reports have been distributed to Federal agencies concerned with housing.

Inventories from which the report was prepared included Oakland, Sacramento and San Diego in California; Portland in Oregon; Seattle in Washington and Reno in Nevada.

APPOINTED LOS ANGELES DISTRIBUTOR

Appointment is announced of W. A. Warner of Portland, Oregon, as sales representative of the West Coast Stained Shingle Company in Southern California. Mr. Warner, widely known in the building material field on the Pacific Coast, will make his headquarters in Los Angeles, where he will handle the company's full line of products. These include stained shingles, hand-split shingles, processed shakes and the nationally advertised Creo-Dipt shingles and stain.

The Beautiful High Grade

MIRRORS

in Roos Bros- San Francisco Store

Manufactured by

NEWMAN-McWILLIAMS GLASS CO.

724 Golden Gate Ave., San Francisco

Phone ORduay 3342

GLASS
FOR EVERY
BUILDING
PURPOSE

WE ARE PROUD

*to have been selected by
WILLIAMS & GRIMES to execute
all of the BRONZE and STAINLESS
STEEL work for the splendid
group of modern designed
installations featured in this issue of
THE ARCHITECT & ENGINEER*

NATIONAL

ORNAMENTAL IRON & BRONZE CO.

70 CHESLEY ST.

MARKET 1230

FISHER & McNULTY

GENERAL CONTRACTORS

MATTEI BLDG., FRESNO

BUILDERS

ROOS BROS.

FRESNO

WILLIAMS & GRIMES, ARCHITECTS

Furnishings and Drapes

for ROOS BROS. and
Oregon Woolen Mills Store

Williams and Grimes

Al Williams, Architect

by

George Maurice Hyde

MEMBER OF THE AMERICAN INSTITUTE OF DECORATORS

Fairmont Hotel
San Francisco

*Both stores are illustrated in this issue of
THE ARCHITECT AND ENGINEER*

*Modern Homes are
Air-Conditioned by*

SELECTAIR

● DESIGNED and built by the S. T. Johnson Co., pioneer manufacturers of Oil Burners, this smart new air-conditioner combines in one compact unit every feature desired by home-owners, architects and engineers for economical heating, air-conditioning and ventilating the modern home. Year-round hot water. Forced air circulation for summer. Equipped with the popular BANKHEAT Pressure-Type Burner. Furnished in enamel with chrome trim.

Send for "Selectair" Bulletin & complete specifications

S. T. JOHNSON CO.

Oil Burners

940 Arlington Avenue, Oakland, California

401 Broad Street, Philadelphia, Pa.

● THERE'S A JOHNSON OIL BURNER FOR EVERY PURPOSE

No Worry for the Architect

*"—All acid proof drain pipe and fittings
shall be ferro-silicon—CORROSIRON—"*

[Write for this specification]



FEDERAL BUILDING ● CIVIC CENTER ● SAN FRANCISCO

Arthur Brown, Jr., Architect

CORROSIRON DRAIN LINES and FITTINGS and LABORATORY EQUIPMENT was specified because of its superior resistance to corrosion and wear.

Pacific Foundry Company, Ltd.

NEW YORK ● 3100 NINETEENTH ST., SAN FRANCISCO ● LOS ANGELES



For GAS HEAT choose the
DELCO CONDITIONAIR

Built and Backed by General Motors

● This extremely efficient unit automatically warms, purifies, humidifies and circulates the air—supplies complete winter air conditioning to which summer cooling can easily be added. A quality product of unusual efficiency with the plus value of the "General Motors" name. Also models for oil heat. Get complete specifications from —

ALADDIN HEATING CORPORATION

Delco-Frigidaire Dealer

2222 SAN PABLO AVENUE • OAKLAND

A good investment—

is a well designed, well built,
structure, properly located.

Lindgren & Swinerton, Inc.

have been building substantial
buildings for over a half of a cen-
tury, are still building them and
will continue building them for
another half of a century.

Lindgren & Swinerton, Inc.

Standard Oil Building
San Francisco
619 H Street
Sacramento

605 W. Olympic Boulevard
Los Angeles
1723 Webster Street
Oakland

'QUAKE RESISTIVE DWELLINGS

"PRIVATE dwellings and other structures of similar proportions can be made relatively earthquake proof by taking simple, common sense care to make them rigid and appropriately strong," says D. C. McGinness, director, Northern California district office of the Federal Housing Administration.

"Professor Lydik S. Jacobsen, Stanford University mechanical engineer, and Professor R. R. Martell of the California Institute of Technology, research workers financed by a grant to devise simple methods of making home buildings resistant to earthquake shock, have made public a part of their conclusions," Mr. McGinness continues.

"They have built a machine at Stanford that would reproduce on a work bench the earth movements recorded in the Southern California disaster of 1933, when more than 100 persons were killed. Tiny houses, built on a scale that would make them as susceptible to the work bench shock as were the real houses in the real quake, have been subjected to many experiments.

"The main points, they have discovered, were to anchor the house thoroughly to a generous concrete foundation, keep the upright timbers as nearly unbroken as possible, and brace the framework and put sheathing and sub-flooring diagonally.

"The Federal Housing Administration is always alert to consider such findings in setting up minimum construction requirements for home building in California. In this particular instance, minimum construction requirements conform to the finds of these research experts. When the National Housing Act, under which FHA functions, was passed by Congress in 1934, a number of "jerry-builders" entered the field, sensing quick profits. Generally, they subcontracted all of their work at the lowest cut prices possible, and, because of inexperience, were unable to detect substandard items and practices.

"Moreover, applications for insurance on mortgages on new construction were accompanied by plans and specifications which were ambiguous, indefinite and loose, to say the least.

"Builders and the public were constantly asking the requirements of framing, mix of concrete, depth of excavation, and a host of other items which required considerable time and slowed FHA's processing of applications for insurance on mortgages.

"A careful field analysis was made of local building practices, supply of materials, adequacy and enforcements of building requirements, climatic conditions, possibility of earthquakes and other important factors. Considerable time and manpower were utilized with the result that the minimum construction requirements as finally set up embody, we believe, a comprehensive manual for guidance in sound home construction. Vitally important is the fact that these requirements were localized to meet local conditions and hazards such as earthquakes. In a number of instances small

and even large communities which heretofore lacked adequate building codes pertaining to residential structures have seen fit to adopt the minimum construction requirements of the FHA as a basis of either developing or revising their building codes.

"Copies of the minimum construction requirements for all areas served by the insuring offices of the Federal Housing Administration may be obtained by communicating with the district offices.

"The minimum requirement standards of the Federal Housing Administration do not increase construction costs beyond the means of families of very modest incomes. The construction of substantial, sanitary, and comfortable types of shelter, plus safety precautions to preclude unnecessary loss of life during an earthquake, are within the reach of all home builders in the 'less than \$6,000 class.'

"The desirability of maintaining and developing local traditions and producing housing suitable to local topography, climatic conditions and taking into consideration local hazards, such as possibility of earthquakes, needs no argument. Good houses, at whatever price, can be produced only by the combination of good architecture, well-selected materials, and honest building."

WASHINGTON STATE CHAPTER NOTES

The attendance of members and guests from outside the city, at the annual Chapter dinner, was particularly large. Among the guests were William F. Gardiner, president of the Architectural Institute of British Columbia; from the Oregon Chapter came Glen Stanton, the newly elected president; Roi Morin, secretary, and Hollis Johnson. Stanley Smith and Harry Weller made the journey from Pullman; Leonard Bindon, from Mrs. Bindon, from Bellingham; George Gove, "Chuck" Pearson, Ernest Mock, and Nelson Morrison, from Tacoma; and former secretary and president, Dan Huntington, from Metaline Falls.

New Chapter Associates are Miss Elizabeth Ayer, Donald Daniel Bickford, and Frederick Theodore Ahlson; Junior Associates: John L. Rogers and Kenneth St. Clair Ripley; proposals for membership: Associate, John Paul Jones; Junior Associate, Samuel Halfon.

Mr. Willmen, chairman of the Committee on Domestic Architecture, has reported that the attempt to get architects to co-operate in providing limited service at a moderate fee, had not so far succeeded, mainly on account of inability to obtain drawings suitable for reproduction. Small houses are being built in various ways, and the committee is perplexed as to how to get the public to appreciate good architectural service. The best solution was suggested as the giving of good service, at a regular fee, wherever possible. The report was adopted.

The March meeting was held at the College Club, Seattle, Thursday evening, March 2. A business session, and motion pictures by Arthur Loveless, followed the dinner.

Specify

H. C. Little OIL HEAT

• AQUATHERM OIL BURNING WATER HEATER



30 gal. storage capacity—40 gal. per hour recovery. Electric thermostatic control. No pilot. Fully automatic.

• OIL BURNING FLOOR FURNACE

Low first cost—dependable—economical. Available in 56,000 or 84,000 B.t.u. maximum output.

• AIR CONDITIONING FURNACE

Models for any size home. Fully automatic. Economical to own and operate.

**ALL MODELS burn low cost
#27 and lighter Diesel Oil**

See your dealer, or write

H. C. LITTLE BURNER CO.

SAN RAFAEL, CALIFORNIA

"Goods of the Woods"

Dependable Building Materials

Lumber and Millwork
for
All Types of Construction

★

Wolmanized or Creosoted
Lumber and Timbers
is your protection against
Termites and Decay

★

E. K. WOOD LUMBER CO.

San Francisco

Los Angeles

Oakland

POMONA TILES

FOR

**Bathrooms and Kitchens
in over 60 colors**

Warehouses and Display Rooms

135 Tenth St. San Francisco
629-33 North La Brea Ave. Los Angeles
6106 Roosevelt Way Seattle

POMONA TILE MFG. CO.
PLANT — POMONA, CALIF.



Booklet "The Charm of a Well Lighted Home" available upon request.

ORIGINAL ideas in modern lighting as well as beautiful interpretations of pure period Lightoliers are always available in a wide and interesting variety at Incandescent. Although finely finished and beautifully executed, these selections are priced for today's restricted budgets.

INCANDESCENT SUPPLY CO.

SAN FRANCISCO : OAKLAND : FRESNO : LOS ANGELES

STRUCTURAL STEEL

For Class A Buildings,
Bridges, etc.

JUDSON PACIFIC CO.

1200 SEVENTEENTH STREET
SAN FRANCISCO

Plants: San Francisco - Oakland

A Permanent Exposition
of the newest ideas
in home planning
and equipment.



THE BUILDING MATERIAL EXHIBIT

Architects Bldg. • Fifth & Figueroa • Los Angeles • MU-6306

CONTRACTORS OPPOSE "MERIT RATING"

Outright repeal or postponement of the provision in state social security laws which permits a reduction in taxes for unemployment compensation insurance to employers who provide continuous employment to their workers was urged in a report to the 20th annual convention of the Associated General Contractors of America in San Francisco by H. E. Foreman, of Washington, D. C., Assistant Managing Director of the Association.

This "merit rating plan" would put an unreasonable burden on the construction industry and many other industries which because of weather, seasonal or other factors, are unable to provide continuous employment. He pointed out that wages are higher in the construction industry than in most industries because of the seasonal nature of the work.

He quoted the opinions of other experts in the social security field who have pointed out that this plan might lead to a breakdown of the unemployment compensation insurance system.

In his report he stated that "the most serious problem facing general contractors is that feature of most state acts which provides for the future assessment of taxes for unemployment compensation on a so-called merit rating plan. Some 40 states have included this feature, and others are now considering its adoption. Most of these merit rating plans go into effect in 1940 or later. All are based on the theory that by providing a financial incentive, to be based upon the continuity of employment furnished, greater stabilization of employment will be accomplished.

"This theory," Mr. Foreman said, "proceeds on the basis that all employers are on an equal basis with respect to their ability to provide continuous employment. Obviously, this premise is erroneous, as many industries are entirely dependent upon other industries for their markets. It can be readily seen that the dependent industry is completely at the mercy of the purchasing inclination of the others. The construction industry definitely falls into this latter class.

"Not only is it dependent upon the purchases of others over whom it can exercise but partial control, but it is exposed to many other factors which are unavoidable. The vicissitudes of weather is one. It being a mobile industry, required to move its plant to the site of operations, thereby necessitating a turnover of employment, is still another. From all studies made by this Association, it is quite evident that there are few if any firms in the construction industry that could qualify for merit ratings allowing them to pay rates less than the standard now set up in the various laws.

"On the other hand, it seems definite that in those states where penalty ratings are provided for, construction employers would be required to pay the maximum rates. This entirely ignores the fact that construction wages are materially higher than those for similar occupations in industries less exposed to broken time and

that the reason for such higher wages is to compensate workers for lost time."

Mr. Foreman recalled that the last A.G.C. convention had adopted a strong resolution opposing this feature, and that Congress, all state legislatures, the Social Security Boards, and all state agencies handling unemployment compensation had been urged to drop the merit rating feature which is not, however, the Federal law.

TIMBER BRIDGE COMPETITION

A competition for the design of a timber bridge design is announced by the National Lumber Manufacturers Association, American Forest Products Industries, Inc., and the Timber Engineering Company.

Open to students of architecture and engineering as well as graduates of both schools, the contest is aimed primarily at providing suitable designs for short span timber bridges for secondary highways.

The rules require that the design submitted shall be of a highway bridge constructed of timber and employing the timber connector method of construction. The live load may be H-10 or H-15 and the span may vary from 30 feet to 70 feet, measured from center to center of bearings, but using only spans divisible by 10. The roadway must be 18 feet in the clear. Piers of supports need not be designed beyond the anchorage of the bridge to a concrete pier which shall be assumed to have already been designed. Assumption for dead loads should be stated on the drawing and the design should be predicated on the use of American Standard sizes of dressed lumber and timber surfaced on four sides.

Beside providing suitable bridge structures for highways the purpose of the contest is to acquaint designing engineers with the latest developments and design practices of modern timber construction. As an added incentive to students the prize money has been divided into two classifications: (1) for all contestants and (2) for students only.

The grand prize will be \$500 in cash and in addition there will be six prizes from \$200 to \$50. Seventeen other student prizes totalling \$300 will likewise be awarded making 25 awards in all amounting to \$1,500.

Further details may be obtained from the secretary of the National Lumber Manufacturers Association, 1337 Connecticut Avenue, Washington, D. C.

CONCRETE FOR BETTER BUILDINGS

This new 24-page illustrated book, published by the Portland Cement Association, presents the architectural and structural advantages of concrete masonry for exterior and bearing walls, firesafe partitions, economical backup, and as an interior wall treatment for decorative, acoustic and insulation purposes. Photographs of stores and factories, theaters and recreational buildings, churches and schools, apartments and housing projects in all parts of the country illustrate the text matter.

INCLUDE TREES IN YOUR PLANS

DAVEY, ORIGINATOR OF TREE SURGERY, OFFERS FREE INSPECTION AND ESTIMATE.



SAN FRANCISCO Russ Bldg. SUTTER 3377
 Fresno Mattei Bldg. TUCKER 1929
 LOS ANGELES Story Bldg. TUCKER 1929
 Local phones in: Pasadena, Palo Alto, Oakland, San Rafael, San Mateo

SKILL - KNOWLEDGE - RESPONSIBILITY



VAN ARSDALE-HARRIS CO.

ENGINEERS & CONTRACTORS

ACOUSTICAL TREATMENT - INSULATION
 SOUND CONTROL

FIFTH & BRANNAN STS. SAN FRANCISCO, CALIF.
 TELEPHONE GARfield 3600
 DIVISION

VAN ARSDALE-HARRIS LUMBER CO., INC.

USE BASALITE

Light-weight, pre-fabricated Concrete building products for floors, walls, and roofs in your next building.

BASALT ROCK COMPANY, INC.

Napa, California

NOISE CONTROL— ON TREASURE ISLAND

STATE AUDITORIUM AND RADIO STUDIOS
 BELL TELEPHONE SYSTEM EXHIBIT
 SAN FRANCISCO RECREATION EXHIBIT
 FEDERAL BUILDING THEATER

Furnished by—

WESTERN ASBESTOS CO.

Building Materials Mechanical Specialist
 SACRAMENTO OAKLAND
 SAN FRANCISCO

Bull Dog Clips



Securely anchor Sleepers
in Concrete Slabs

Gunn, Carle & Co.

SAN FRANCISCO
20 Potrero Ave. UNDERhill 5480

FRANK ALLEN

FERRO-PORCELAIN
CONSTRUCTION

320 Market Street
San Francisco, California
Telephone SUtter 8236



*No longer a problem
for the Architect*

TRANSIT MIX CONCRETE AND MORTAR

makes delivery of material
to the job swift and in-
expensive . . . minimizing the
architect's supervision costs
and assuring his client a de-
pendable mix.

Speed . . . Reliability . . . Economy
Let us co-operate with you

Golden Gate-Atlas Materials Co.

16th and Harrison Streets
San Francisco
UNderhill 3650

KNOW YOUR EARTHQUAKES

According to records from modern instruments, about nine thousand earth shocks occur annually. Somewhere on the earth's surface there is a shock every hour. Five thousand of these shocks are perceptible to human senses. While scientists, engineers and business men are interested in a general way in earthquakes in different parts of the globe, they are primarily and specifically interested in those that occur in the United States and particularly in those states where the greatest number of disturbances have occurred.

The University of California Press has just released a "Descriptive Catalog of Earthquakes of the Pacific Coast of the United States" in which is recorded "only those earthquakes which were of sufficient intensity to be felt by human beings" occurring in the states of California, Oregon, Washington, Idaho, Nevada, Utah, and Arizona, between the years 1769 and 1928 inclusive.

The Pacific Coast and Rocky Mountain states have come through a boom period in building. Construction has been careless. Building codes have been weakened by amendment or neglected and allowed to become obsolete. Until very recently neither owners, architects nor builders have considered earthquake resistance. The result is that many of the structures erected in the last thirty years, to say nothing of those older, are earthquake hazards for the owner, the mortgagee, the insurance company and the occupants. Hence a study of the record by those whose interests are most deeply concerned will undoubtedly hasten the adoption of corrective measures for the lessening of hazards to life and property.

This book of three hundred pages by Sidney D. Townley and Maxwell W. Allen, is a publication of the Seismological Society of America, a continuation of the catalogs prepared originally by Professor Edward S. Holden, formerly director of the Lick Observatory, issued in 1898, and subsequently augmented by Professor Alexander G. McAdie, and brought down to the year 1907, while he was serving as Meteorologist in charge of

Cabinet Work

in
ROOS BROS.
and
LIVINGSTON BROS.
Stores

*Williams & Grimes, Albert R. Williams,
Architect*

Manufactured and Installed by

OSTLUND & JOHNSON

Bank, Store, Office
FIXTURES

1901 Bryant St., San Francisco

JOSEPH MUSTO SONS-KEENAN COMPANY

MARBLE
and
ONYX

535 NORTH POINT STREET
SAN FRANCISCO
1801 S. SOTO STREET
LOS ANGELES

SISALKRAFT

REG. U. S. PAT. OFF.

"More than a
building paper"

THE SISALKRAFT CO.

205 West Wacker Drive
(Canal Station) Chicago, Ill.
55 New Montgomery Street
San Francisco, Calif.

Pacific Manufacturing Company

High Class Interior Finish
Quality Millwork

142 Sansome St. 6820 McKinley Ave.
San Francisco Los Angeles
GARfield 7755 THORnwall 4196

1315 Seventh Street, Oakland
GLEncourt 7850



CLIENTS will bless you for installing the Wesix "49'er" ELECTRIC BATHROOM HEATER. But try it first in your own home. Certain that you will like its forty-nine inches of INSTANT RADIANT HEAT and QUICK CIRCULATING HEAT, we are offering this smart new heater at factory cost to architects, for personal use! Limit one heater per architect. List price \$21.50. Please write on your regular letterhead, to: 1018 WESIX BLDG., SAN FRANCISCO

WESIX
WESIX ELECTRIC HEATER CO.

the San Francisco office of the United States Weather Bureau.

The descriptions throughout this work indicate the intensity of the shock as measured by the Rossi-Forel scale, date, time and duration of disturbance, area affected, resultant loss of life, if any, and extent of property damage.

Scientists, engineers, bankers, builders and insurance people will want a copy of this book at hand. They can be obtained from Perry Byerly, Bacon Hall, University of California, Berkeley, California.

RUNNING FIRE

(Concluded from Page 1)

house were not for human habitation we qualified the noun with other words as, for instance, "dog house" or "cow shed." But that was before the period of multiple use of buildings.

Today a house is any structure in which a human creature sleeps. The fact that you can sleep in a tin can, as did "mehitabel" of Don Marquis fame, makes it a house. In fact I have seen cans that look more like homes than do some of the houses of today. It is largely the desire for multiple use, coupled with modern trends, that has brought about this state of affairs.

I have never owned one of those multiple use gadgets that was not an utter failure, including houses. The fountain pen that has a flashlight, a pair of tweezers, a calendar and an ear spoon combined in its frame is about as practical as a house with a machine shop, five extra bed rooms, a rumpus room, a Turkish bath, a folding library and a disappearing bar that can be converted into a room for ping-pong. Nor have I ever seen one of those trick houses that held the interest of its own owner much longer than a fortnight.

In his "Seven Lamps of Architecture" Ruskin admonishes us not to imitate. If we cannot afford marble, let us not paint wood to look like marble. If we cannot afford stone let us not imitate it in another medium. The same is true of architecture in general. If we cannot afford features that do not belong in a home let us make the home small enough so that we can afford to go elsewhere for such pastimes. Anyhow, let us strive to make the house we live in a home rather than a combination of night club, hot house, brewery and pickle factory.

Pitcher

Improved Disappearing Doors Save 20% Space

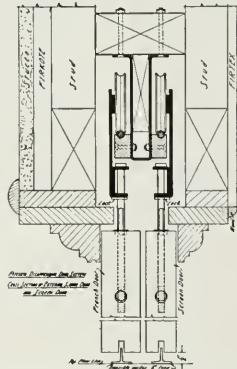

Joins with a 3 3/4" stud wall... steel studs... adjustable steel and wood track. Can be used for screen doors in connection with French doors. Send for detail drawing.

E. C. Pitcher Co.
557 Market Street
San Francisco



HERRICK IRON WORKS

STRUCTURAL STEEL
REINFORCING STEEL

18TH AND CAMPBELL STS.
OAKLAND, CALIF.
Phone GLEncourt 1767

FORDERER CORNICHE WORKS

Manufacturers of

- Hollow Metal Products
- Interior Metal Trim
- Elevator Fronts and Cabs
- Metal Plaster Accessories
- Sanitary Metal Base
- Metal Cabinets
- Flat and Roll Metal Screens
- Commercial Refrigerators

269 POTRERO AVE.
San Francisco, Calif.
HEmlock 4100

Donovan Automatic Awning Type Windows

Give 100% natural ventilation and day-lighting control

UNIVERSAL WINDOW COMPANY
Berkeley, California

"AMERICAN MARSH" Redi-Vac Vacuum Heating Pump

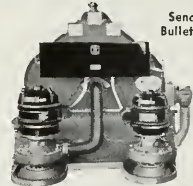

Send for Bulletin 441

SIMONDS MACHINERY CO.
San Francisco Los Angeles
816 Folsom St. 455 East Fourth St.



SANTA MARIA INN

Santa Maria, California

*On the Coast Highway
between
Los Angeles and San Francisco*

OVER NIGHT

or

JUST A MEAL

FRANK J. MCCOY, *Owner*
Geo. A. Thompson, *Manager*

El Encanto Hotel

Santa Barbara

*On the Riviera, above the
Old Mission*

Frank J. McCoy, *Owner*
Fred F. Pimental, *Manager*

MODERNIZATION LOANS

The Federal Housing Administration has insured 1,899,242 loans amounting to \$765,583,161 for property improvement purposes since enactment of the National Housing Act in June, 1934.

More than \$200,000,000 of this amount has been insured since February 3, 1938, when this type of insurance was revived.

Under Title I of the National Housing Act, the FHA insures "character" loans on monthly payment terms for repair, modernization, and improvement of property, including certain limited types of new construction. Authority to insure loans of this nature expired on April 1, 1937, but it was renewed by last year's amendments as a result of widespread demand and as a stimulus to employment.

Amounts up to \$10,000 may be borrowed to repair or modernize existing properties, and amounts up to \$2,500 may be borrowed for the construction of new buildings under Title I. The average loan is less than \$500.

S. BROWN CO.

Specialists and Designers

**Modern and Period
Upholstered Furniture**

Factory

964-66 Natoma Street

San Francisco

UNderhill 7100

W. C. TAIT, INC.

General Contractors for the
following projects from the
office of

WILLIAMS & GRIMES,
Architects

Sommer & Kaufmann
Livingston Bros.
Picadilly Circus

883 Market Street, San Francisco

Independent Iron Works

Structural Steel
Ornamental Iron
Steel Service Stations
Steel Tanks
Standard Steel Mill Buildings
Bridges

821 Pine Street

Oakland

MEXICAN ARCHITECTS

It seems The Architect and Engineer has an enthusiastic booster and warm friend in L. Salvador Sanderson, architect of Laredo, Texas. Recently he has sent us two new subscriptions from representative Mexican firms. How one of these subscriptions was obtained, and other comments, may interest Architect and Engineer readers:

"I asked Salvador Soda for a subscription just to see what would happen, the other subscription being voluntary. He advised that his firm took the 'Architectural Forum' and several 'plan books'—published, of all places, in the vicinity of Arkansas.

"I told Soda if they projected the Forum's philosophy to its logical conclusion they would have to close down their mahogany camps and mills for no one would want carved beams, doors, furniture or any other refinements of their greatly beloved world. His subscription was immediately forthcoming on my advice that The Architect and Engineer presented the best and not the funniest work done in the well known State of California.

"At present there is a lot of work going on in Mexico and although no registration laws to compel it, the architects get the lion's share of the planning.

"As the 'pack box,' better known in Mexico as 'indecentes,' (meaning vulgar in English), is on its last feeble leg, I should think now would be the time to turn on the heat if you

ANDERSON & RINGROSE

General Contractors

320 Market Street, San Francisco

Phone GARfield 2245

Clinton Construction Co. of California

*General
Contractors*

923 Folsom Street
San Francisco
SUtter 3440

HIGH GRADE MILLWORK
AND INTERIOR FINISH
SASH AND DOORS

LANNOM BROS. MFG. CO.

FIFTH AND MAGNOLIA STREETS
OAKLAND, CALIFORNIA

Telephone: TEmplebar 3663

MULLEN MFG. COMPANY

BANK, STORE AND OFFICE
FIXTURES—CABINET WORK
OF GUARANTEED QUALITY
CHURCH SEATING

Office and Factory:
60-80 RAUSCH ST., Bet. 7th and 8th Sts.
San Francisco
Telephone UNDERhill 5815

G. P. W. JENSEN & SON

Building Construction

320 Market Street, San Francisco
Phone: GARfield 2444

DINWIDDIE CONSTRUCTION COMPANY

BUILDERS

CROCKER BUILDING
SAN FRANCISCO

Carl T. Doell Co.

Plumbing
Heating

Plumbing Contractor
Veterans Memorial Building
Oakland

467 21ST STREET
OAKLAND

Telephone GLencourt 8246

ever intend to capture all those easy-to-get subscriptions.

"While I may be carrying the thing too far, I can not resist the temptation to inquire, why not a Mexican page or two, edited in both Spanish and English? It would certainly bring forth a lot of vivas from Mexico if only a faint amen from the rest of us.

"Pencil Points" has bored us to distraction with 'New England,' which all the architects I know in the big Southwest have about as little use for as a carload of red derby hats.

"Please quote me your advertising rates. My wood carvers want more work and it has occurred to me some of the folks out West might be very glad to get beautiful 2' 8" x 7' doors, containing 15 carved panels heavy molded in Spanish cedar 2 inches thick for \$35.00 or in mahogany for \$45.00—if they knew we made them on short notice to any details, including our own.

"If possible, I know Soda and Guerra would be glad to receive your recent San Francisco World's Fair number for their first. Congratulations on it and good luck.

R. S. SANDERSON."

GARDEN PLANNING

(Concluded from Page 4)

to preserve existing values wherever possible. Architectural features should be used sparingly and with caution. This is especially true in small gardens, where, if used too lavishly, they are apt to give the impression of a pottery shop. Above all never place a prominent feature haphazardly.

Beware also of cheap garden statuary or other garden accessories.

It is safest to avoid brightly colored pavement, pots, vases, etc. They are often used effectively, but more often, by being misused, spoil an otherwise lovely garden picture.

If you have a new garden, start now (before you have to rectify your mistakes) with a carefully worked-out design and stay with it. If your garden is an old one, you have the advantage of having many fine plants and accessories with which to work.

GOOD NUMBERS

Editor, Architect and Engineer:

Congratulations on the splendid issue of The Architect and Engineer for February. The cover is a knockout.

C. M. VANDEBURG,
Director Publicity and Promotion,
G. G. International Exposition.

Editor, Architect and Engineer:

Congratulations upon your splendid current Exposition number.

CLYDE F. TRUDELL, Architect.
Burlingame, Cal.

Editor, Architect and Engineer:

Two outstanding numbers—your February and March issues.

HARRY MICHESEN, Architect.
San Francisco.

Louis C. Dunn, Inc.

GENERAL
CONTRACTORS

Monadnock Building
San Francisco

Phone: DOuglas 4632

Empire Construction Co., Ltd.

Builders



RUSS BUILDING
SAN FRANCISCO
SUtter 2989

Smith

Lumber Company

WHOLESALE - JOBBING - RETAIL
FACTORY AND BUILDING LUMBER
PLYWOODS - ROOFING

DISTRIBUTING YARDS

San Francisco	Oakland
•	19th Ave. &
4th & Channel	Estuary
Market 0103	FRuitvale 3174

YOUR INQUIRIES SOLICITED

FRED W. SCHELL

Contractor
General

666 MISSION STREET
SAN FRANCISCO

Contractor for the Oregon City
Woolen Mills Store, San Francisco,
designed by Williams & Grimes and
illustrated in this number.

ABBOT A. HANKS, INC.
Engineers & Chemists

INSPECTING — TESTING — CONSULTING
 CONCRETE • STEEL • MATERIALS
 LABORATORIES
 CHEMICAL AND TESTING

• RESEARCH AND INVESTIGATION •

TESTS OF STRUCTURAL MATERIALS
 DESIGN OF CONCRETE MIXES
 SHOP AND ERECTION INSPECTION OF
 STRUCTURES AND EQUIPMENT
 INVESTIGATION OF STRUCTURES
 AND MATERIALS
 TESTS AND INVESTIGATION OF
 FOUNDATION SOILS
 FIRE RESISTANCE AND INSULATION
 TESTS

624 Sacramento Street, San Francisco

Phone GARfield 1164

Hunter & Hudson

Consulting Engineers

DESIGNERS OF HEATING
 AIR CONDITIONING
 VENTILATING AND WIRING
 SYSTEMS, MECHANICAL
 AND ELECTRICAL EQUIP-
 MENT OF BUILDINGS

41 SUTTER STREET
 ROOM 710
 San Francisco California

**The
 Fink & Schindler
 Co.**

GENERAL
 CONTRACTORS

Manufacturers of com-
 mercial fixtures and
 interior wood work

Factory and Office
 552 Brannan Street
 San Francisco, Calif.

VAUGHN - G. E. WITT Co.

Manufacturers and Distributors

Pump Governors	Oil Heaters
Safety Pump Governors	Relief Valves
Automatic Gas Regu- lating Valves	Oil Burner Governors
Gas Burning Equipment	Oil Burners
Vacuum Pump Governors	Oil Pumping Sets
Vacuum Regulating Valves	Oil Valves
Continuous Flow Steam Traps	Oil and Steam Strainers
Thermostats	Duplex Oil Pumps
Reducing Valves	Rotary Oil Pumps
	Boiler Feed Pumps
	Water Heaters
	Boiler Feed-Water Regulators

4224-28 Hollis St., Emeryville, Oakland

**THE
 HERMANN SAFE CO.**

MANUFACTURERS AND DEALERS
 OF

FIRE AND BURGLAR PROOF
 SAFES AND VAULTS, SAFE-
 DEPOSIT BOXES, ETC.

200 HOWARD STREET
 SAN FRANCISCO
 GARfield 3041 - 3042

THE MOST COMPLETE LINE
 OF STEELS AND STEEL BUILD-
 ING MATERIALS MADE BY A
 SINGLE PRODUCER



See Sweet's Catalog File or write us for
 full information.

Republic Steel Corporation

General Offices: Cleveland, Ohio

Denver, Colo. . . . Continental Oil Bldg.
 Los Angeles, Calif. . . . Edison Bldg.
 Salt Lake City, Utah . . . Walker Bank Bldg.
 San Francisco, Calif. . . . Rialto Bldg.
 Seattle, Wash. . . White-Henry-Stuart Bldg.

**VERMONT
 MARBLE
 COMPANY**

Producers and Finishers
 of

Domestic and Imported
 Marbles

San Francisco
 Los Angeles
 and
 Tacoma, Wash.

Robert W. Hunt Company
 ENGINEERS

Inspection - Tests - Consultation
 Schools and Other Structures
 Are Built as Designed

When Construction Materials are
 Inspected at point of Manufacture
 and during Erection by

ROBERT W. HUNT COMPANY

Cement, Concrete, Chemical, Metallurgical,
 X-Ray and Physical Laboratories

Chicago - New York - Pittsburgh
 Los Angeles - All Large Cities
 San Francisco, 251 Kearny Street

**JOHN
 CASSARETTO**

—Since 1886—And Still Active—

Building Materials

READY MIX CONCRETE
 ROCK - SAND - GRAVEL - LIME
 CEMENT - PLASTER - MORTAR
 METAL LATH - WOOD LATH
 STUCCO - WIRE NETTING

Service Unexcelled

Bunkers
 Sixth and Channel, San Francisco
 Phones: GARfield 3176, GARfield 3177

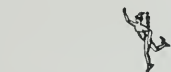

MERCURY PRESS

We Print
*The ARCHITECT and
 ENGINEER*

*"A Thing of Beauty
 Is a Joy Forever"*

942 HOWARD STREET
 SAN FRANCISCO

**FINE WATER COLORS
 AND PAPERS
 FOR ARCHITECTURAL
 RENDERINGS**

**H. S. CROCKER
 COMPANY, Inc.**

720 MISSION STREET
 MARKET STREET AT SECOND
 SAN FRANCISCO

**THE TORMEY
 COMPANY**

GENERAL PAINTERS
 AND DECORATORS

Phone UNDERhill 1913

563 FULTON STREET
 San Francisco



ARCHITECT AND ENGINEER



MAY, 1939

PORTLAND ARCHITECTURE MOVES STEADILY FORWARD



150,000 cu. ft. of conditioned air per minute, with changes eight times an hour—this is the formula for scientific, healthful comfort at NBC. The simple, fully automatic gas boiler supplies a steam required for the entire thermostatically-controlled system

Like a glimpse of the future is "Hollywood Radio City," new NBC Studios, with the most advanced developments in broadcast engineering, *including flexible gas fuel for automatic air conditioning*. ☆ The weather is just a *fact*, no longer a *factor*. Inside temperature is always 72 degrees and humidity 45 per cent—for broadcasting efficiency and year-around comfort. ☆ Heating problems are easily solved in homes, large and small, as in public buildings—this modern, automatic way—with controlled, economical gas fuel. Gas Company engineers gladly aid with valuable technical suggestions, free of charge.

SAN FRANCISCO FAIR VISITORS: See the fascinating, \$150,000 Gas Exhibit on Treasure Island in the Homes and Gardens Palace.

LET **GAS** DO THE 4 BIG JOBS

THE MODERN FUEL

HOUSE HEATING • WATER HEATING • COOKING • REFRIGERATION

RUNNING FIRE

by
MARK DANIELS, A.I.A.

Humanizing Murder

"*Make Next War Humane*" is a headline in one of our dailies. A statement so paradoxical should continue by telling how it can be done. Perhaps we should "say it with flowers," or conduct a standard American radio program on every front. Certainly putting all belligerents on the dole or under the W. P. A. would be one way to accomplish the desired result by an indirect method.

But, stupid as the phrase is, it would be innocuous if the word "Next" were deleted. "Next War" implies the inevitableness of one. One gathers from the headline that there is going to be a next war; that there must be a next war. Instead of working to ameliorate the pains of war why not banish war altogether or work to that end? That headline would, at least, sound more humane if it read, "Make Next War Impossible," or better still, "Make War Impossible." Anyhow, either phrase would be more possible of accomplishment than to make war humane.

★ ★ ★

One Way Traffic

There is much conjecture concerning the underlying motive of the royal visit to America at this particular and critical time. Following the thought of the foregoing item it has been suggested by some that the Duke took advantage of the situation to broadcast his views on peace. By the same token it is possible that the royal couple went to sea so they could hear it.

Again, it has been whispered that the next few weeks would be a good time to be either in Canada or the United States. The United States has been used as a storm cellar before this but I have never known a British gentleman, outside their church, to run from or hide behind anything.

Of course, there is the theory that the combined machination of one Grover Whalen and the press have

succeeded in putting one over but that hardly seems probable to me. My feeling is that so many presidents, diplomats, senators, politicians and traveling salesmen are keeping the Atlantic in a froth traveling to England on the Cunard and other British lines that the king and queen decided to do something to stop this one-way traffic.

★ ★ ★

In Reverse

Since my boyhood days until the fall of the Kaiser and particularly after 1920 I had great admiration for the German scientists and manufacturers. They were resourceful. If they got insufficient crops for a certain product they found some other material from which to manufacture the same goods. They lacked dye-stuffs so they made them seemingly from nothing. They had no rubber trees so they made rubber from something else.

The Germans were a great and resourceful nation. When they needed something they seemed to be able to reach into the air and develop it. We used to say that the Germans could make something from nothing. Have they reached the limit of their ability? It would seem so. After nearly a century of making something of nothing they are now madly bent upon a career of making nothing of something.

★ ★ ★

Customs, Good and Bad

We who are forced in our mad pursuit of the elusive cartwheel of commerce, to keep our proboscises flattened against the pavement, soon forget that there are other customs in the world than our own. We even forget that winter in the northern hemisphere is summer below the equator. Some of us have even got to the point where we think that a man who laughs at any time of the year is crazy; and yet there are those who laugh on every

appropriate occasion, those who wear straw hats the year round, and some who are sane enough to work less than eighteen hours a day.

There are many customs which no one in a civilized country would care to adopt. Certain tribes of Asia rub noses upon greeting. Other tribes of Africa wear cartwheels in their lips and ears. Women of a certain tribe in Africa let portions of their anatomy grow to such enormous sizes that they cannot sit down for the rest of their lives. In America there is no one who would wish to adopt these customs either summer or winter.

In the western part of Ireland boys wear skirts until they are twelve years of age because leprauchans do not like girls and will, on the other hand, steal boys at the first opportunity. Skirts for boys is not a custom we would like to adopt. In Japan it is not proper for a lover to kiss his fiancée no matter how beautiful she may be. Emphatically, this is not a custom we would like.

But there is one in China that I, as an architect, am sure all others in my profession would be happy to have adopted throughout the United States.

It is the custom amongst the Chinese of the higher classes to entertain in a royal manner the designer contract-builder. They have no architect purely as such in China. The reason for this is that China is ridden with superstition. It is possible, according to their beliefs, for the designer-contractor to leave openings where evil spirits can come in and destroy the future happiness and prosperity of the person for whom they have built a house. This, of course, is another fine argument against the contractor-builder. However, the custom of entertaining the architect lavishly in order to prevent his leaving an evil influence on the building is one that I advocate strongly and pray may be introduced in the United States forthwith.

Architect & Engineer

MAY, 1939

Fred W. Jones, Editor

Mark Daniels, A. I. A., Associate Editor

Edgar N. Kierulff, Assistant Editor

CONSULTING BOARD OF EDITORS

Architectural—

Arthur Brown Jr.
Frederick H. Meyer
Timothy L. Pflueger
Will G. Corlett
Harry Michelsen
John J. Donovan
Lewis P. Hobart
David C. Allison
Gordon B. Kaufmann
Harris C. Allen
Glenn Stanton
Paul R. Hunter
C. H. Alden

Engineering—

H. J. Brunner
L. H. Nishkian
William Adrian
Wm. H. Popert
Homer N. Hadley
John J. Gould
Geo. E. Atkins

Business Manager—

L. B. Penhorwood

Advertising Manager—

J. Leslie Meek

Architects' Reports—

Vernon S. Yallop

THE ARCHITECT AND ENGINEER, INC., 68 Post Street, San Francisco, EXbrook 7182. President, K. P. Kierulff; vice-president, Frederick W. Jones; secretary, L. B. Penhorwood. Los Angeles office, 832 W. Fifth Street. Published on the 12th on each month. Entered as second class matter, November 2, 1905, at the Postoffice at San Francisco, California, under the Act of March 3, 1897. Subscriptions, United States and Pan America, \$3.00 a year; Foreign countries, \$5.00 a year; single copy, \$.50.

Frontispiece

View from North Center, Oregon State Capitol, Salem, Oregon

Text

Current Notes from the Architects of Portland, Oregon	17
Glenn Stanton, A.I.A.	
Cooperation Between Architects and Building Industry	35
Harry M. Michelsen, A.I.A.	
Los Angeles Union Passenger Railway Station	37
Ten Questions and Answers on Radiant Heat	41
C. A. Russell	
Building Codes an Aid to Fire Prevention	44
Geo. W. Booth	
Industrial Research for Architect and Engineer	45
J. E. Holbrook	
Progress of the Butterfly Map—The Three Variants	47
B. J. S. Cahill	
Models Show 25 Years of Highway Progress	51
With the Architects	53

Plates and Illustrations

Recent Work of Portland, Oregon, Architects

Glenn Stanton, Guest Editor

Marquetry Murals by Aimee Gorham 17-34	Jackson Park and University Hospital 25
Building for Weisfield & Goldberg 18	Lawrence, Hollord & Allyn, Architects
Harry A. Herzog, Architect	First Church of Christ, Scientist 25
Bohemian Restaurant 18	Glenn Stanton, Architect
Lawrence, Hollord & Allyn, Architects	St. Joseph's Parochial School 26
Millinery Shop 19	Francis D. Jacobberger, Architect
Harry A. Herzog, Architect	Weeks Memorial Hall 26
Office Building 19	Lawrence, Hollord & Allyn, Architects
A. E. Doyle & Associate, Architects	Home for Mr. and Mrs. P. Belluschi 27
Detail, Mail-Well Envelope Co. 20	A. E. Doyle & Associate, Architects
Richard Sundeleaf, Architect	Residence of Wm. Jenkins 28-29
Alterations to Heathman Hotel Garage 21	Roi L. Morin, Architect
Infirmity, University of Oregon 21	Residence of Dr. Milton Steiner 30
Lawrence, Hollord & Allyn, Architects	Harold W. Doty, Architect
Wilson-Chambers Mortuary 22	Two Houses by Hollis Johnston and Herman Brookman 31
Richard Sundeleaf, Architect	Residence for Charles Blackburn 32
Chapel, Y.M.C.A. Building 22	Morgan H. Hartford, Architect
Glenn Stanton, Architect	Residence for W. A. Healy 33
Offices and Garage 23	Tucker & Wallmann, Architects
Knighton & Howell, Architects	Wilson-Chambers Mortuary 22
Warehouse Building 23	Richard Sundeleaf, Architect
Knighton & Howell, Architects	Chapel, Y.M.C.A. Building 22
Garden 24	Offices and Garage 23
Florence H. Gerke and Walter Gerke, Landscape Architects	Warehouse Building 23
	Knighton & Howell, Architects
	Garden 24
	Florence H. Gerke and Walter Gerke, Landscape Architects
Unions Passenger Station, Los Angeles	37-40
The Butterfly Map	48
Models of Highway Traffic	51-52

NEW PARTITIONS TILED WITHOUT LABOR!



Kraftile Terra Cotta Wall Units are pre-tiled, one side, or both. Save on labor and building time

With Kraftile Terra Cotta Wall Units, one or both sides of a partition are "automatically" finished with a smart, semi-matt Kraftile surface.

Building time is cut accordingly. Labor costs run about one-third less.

And you've only one craft to deal with on the job.

Building owners find there's practically no upkeep cost with Kraftile partitions. An occasional cleaning with a damp cloth is all that's ever needed.

Glazed Kraftile surfaces are higher fired than even ordinary tile. Colors cannot fade. They're fireproof, steamproof and stain-proof.

In 21 states and in Canada, Kraftile Terra Cotta Wall Units are making a reputation for themselves in schools, hospitals, food products plants, laboratories and public buildings. Many of these installations were made under the supervision of our Engineering and Designing Department. This experience is available to you. Mail coupon today.

KRAFTILE TERRA COTTA WALL UNITS



Kitchen by Bureau of Yards and Docks, U. S. Naval Air Base, Sunnyvale, Calif.

FREE HANDBOOK FOR ARCHITECTS AND BUILDERS

KRAFTILE COMPANY, Niles, California

Please send me without cost or obligation "Handbook of Specifications and Suggestions on Glazed Terra Cotta Wall Units"

Please have service representative call

Name _____

Address _____

City _____

State _____

THE DELPHINIUM

One of our Loveliest and Most Popular
Flowers

By **BERNIECE ASHDOWN**
Landscape Architect

DELPHINIUMS are not strangers in perennial gardens. In fact, no summer garden is considered, by most modern gardeners, to be quite complete without the stately grace of Delphiniums somewhere in its ranks. Their color range is magnificent; from deep toned cobalt and ultramarine to delicate silver blue, traced like frost upon the petals. There are snowy whites, new yellows, rosey plum shades, clarion sky blues and innumerable glorious combinations with striking and subtle contrasts.

For centuries Delphiniums have been cultivated, but in the last twenty years hybridizers have brought about more improvement than had been made in all the hundreds of years preceding.

The Delphinium, as we know it today, is truly a garden aristocrat. It blooms from April until Fall. Its sturdy flowering stalks range in height from one to eight feet, depending upon the variety. The blossoms have good form and clear vivid color.

Delphiniums should have full sun or partial shade and demand a rich, loose sandy loam that will let the air get to the roots. The ground should be kept well fertilized, watered and drained and given frequent applications of lime. Wood ashes dug in around their crowns in the spring gives the plant new vigor. If the plants produce short weak stalks with undersized blossoms, the soil probably lacks nitrogen, moisture or lime. Heavy soil may be made more suitable by forking in a little sharp sand and bits of old plaster.

Unless the plants are planted in a very protected situation it is wise to tie each stalk to a slender stake, using raffia or wide tape so as not to injure the stalk.

Well established, healthy plants often produce from a dozen to two dozen spikes, but it is advisable to thin them out to about a 50-50 average.

After they have finished blooming, cut the stalks back, leaving about one foot of the stem so as not to injure the plant. Give them fresh applications of fertilizer and keep them well watered. Do this faithfully and they will produce another bloom.

Delphiniums are sometimes subject to attacks of mildew. This problem is more easily prevented than cured. Watch carefully for mildew on neighboring plants and remove the infected parts as soon as possible. Dusting with dry Bordeaux or sulphur is an effective preventive. Wherever possible, irrigate by flooding or basin irrigation rather than spraying. If overhead sprinkling is practiced, it should be done early enough so that the leaves of the plant will be dry before night.

Coal ashes worked in around the crown

of the plant discourage cut worms and similar pests.

The most common way to propagate Delphiniums is from seed. This is always interesting and presents few difficulties if rules are followed. The seed may be sown in the spring but the fall is the best time, preferably within six months after the seeds have ripened. Sow them thinly in rich, well drained sandy loam to which has been added a little lime. Keep them moist and protected from the direct sun until they have their second leaves.

A cold frame is excellent for raising seedlings, and is much less trouble than most other arrangements. When their third or fourth leaf appears, they may, weather permitting, be planted into the open ground.

Tall growing varieties should be planted two feet apart. Smaller plants may be closer. Vigorous plants from seed sown in the fall will bloom the following summer.

By all means buy the best seeds obtainable. Poor seeds require more work and attention and the results are always disappointing.

Delphinium hybrid seeds do not run very true to type. Only about fifteen per cent of them will produce flowers like the mother plant, but this does not mean that the others are not interesting. On the contrary, the multitude of new colors and forms are often lovelier than those of the parent plants.

Propagation from slips is quite successful but requires a greenhouse.

Plants may also be increased by dividing the clumps with a sharp knife in the spring.

The different strains of Delphinium are far too numerous to list here in their entirety. Most of our imported seed comes from England and Germany. English hybrid Delphiniums as a whole come in darker shades than the American hybrids. In addition to the Wrexham, which is the best known of the English strains in America, English hybrids also include Blackmore and Langdon.

Germany was the original home of the familiar Delphinium *Belladonna* which is very different from the hybrid varieties. It bears loose graceful sprays of vivid sky blue flowers, which are splendid for cutting. German hybridizers also have made many important contributions including the Blue Wonder *Erlkonig* and the *Mastadont*. They have also produced Delphinium *Iceberg*, which is a lovely white, and the Delphinium *Sulphureum* *Zalil* which is yellow.

Among the best known Pacific Coast varieties is the *Vetterle* and *Reinelt* strain.

Since each season produces new and better varieties, it is advisable, when buying seed to consult a reliable seed dealer who will advise you as to what varieties are best.

Next season will bring thousands of new and better Delphiniums into bloom. Some of them might just as well be in your garden. They are particularly lovely in the perennial border in the company of Columbines, Lilies (especially *Lilium Candidum*) *Digitalis*,

Campanulas, *Stocks*, and late blooming *Tulips* or anywhere where a touch of blue is needed to accent an otherwise perfect garden picture.

REGIONAL COMPETITIONS FOR FEDERAL BUILDINGS

FIRST of a series of eleven regional competitions for designs for Federal buildings, is announced by Admiral C. J. Peoples, in: on Monument are notable fruits of the Treasury Department.

Under the program made public in March by Secretary Morgenthau, architects of seven states of District No. 8 are being called upon to design for the City of Leavenworth, Kansas, a new Post Office and Court House building with a cost limit of \$250,000.

Registered or qualified architects with home offices in this territory are eligible to compete. The district includes Minnesota, North Dakota, South Dakota, Kansas, Iowa, Missouri and Nebraska.

The author of the winning design will receive \$2,600 for this distinction and will be paid an additional \$2,600 in his capacity as consultant during the preparation of working drawings and specifications which will be prepared under the direction of the office of the Supervising Architect of the Public Buildings Branch of the Procurement Division.

In order that all eligible architects of the eighth district may be free to compete, it has been arranged to draw a jury of award from neighboring regional districts.

The competition will remain open for approximately seven weeks.

Competitions already approved by Secretary Morgenthau, but for which details have not been announced, include Evansville, Indiana, Post Office, Court House and Custom House; Charleston, South Carolina, Post Office, and Burlingame, California, Post Office.

"This event is something of a milestone in the history of American public buildings," declared Admiral Peoples in commenting upon the invitation to architects in private practice.

"In the early days of the republic, competition among architects was frequently chosen as a means of bringing out the best available talent. The Capitol and the Washington Monument are notable fruits of the professional competition procedure.

"Direct selection by the Government of architects in private practice is an alternative, and that method has also produced some of our great public buildings—the Supreme Court building, and most of the Triangle group. Nevertheless, direct selection of individual practitioners brings its own difficulties in attempting to avoid the charge of bias or political preferment.

"Designing its buildings with the talents of its own architectural organizations is still another alternative for the Government. Such organizations as the Office of Super-

(Turn to Page 75)

Now...



ABSOLUTELY QUIET

No longer need flush valves be annoyingly noisy. They can be absolutely quiet. Indeed, the Sloan *Quiet-Flush* Valves are absolutely quiet. Sloan *Quiet-Flush* Valves are available in the Royal, Star, Crown and Naval models.

Moreover, any Sloan flush valve in the above models, may be made absolutely quiet—regardless of when installed. Merely replace the present stop valve with the redesigned

Sloan stop, then insert in the valve itself a new type guide and seat. This simple change, readily made by any master plumber, reduces the roar of rushing water to a murmur—and virtually makes your old valve a brand new installation.

Build customer goodwill by giving them the world's most universally used flush valve—plus absolute quiet.

See our comprehensive Catalog in Sweets

SLOAN VALVE COMPANY • CHICAGO

4300 WEST LAKE STREET

SLOAN *Quiet
Flush* **VALVES**

OREGON BRASS WORKS ARCHITECTURAL METAL

Universally Preferred by Northwest Architects

Makers of
Bronze
and
Aluminum
Letters
Both Stock
and
Special
Design



Makers of
Thresholds
Push and Pull
Bars
Door Hardware
Specialties

Illustrated above, Bohemian Restaurant, Portland, Oregon, one of many outstanding Portland buildings which have employed OREGON BRASS WORKS ARCHITECTURAL METAL to enhance appearance and beauty of exterior.

OREGON BRASS WORKS

BRASS · BRONZE · COPPER AND ALUMINUM PRODUCTS

1127 S.E. 10th AVENUE

PORTLAND, OREGON



BEAUTIFUL COLORS—
Not "Painted On"—But
BUILT IN—
Permanently!

Drawer or Cabinet Pull MC1478

STANLEY "Multichrome" Cabinet Hardware

Knob Pull



MC1185

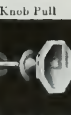

MC1484

with your choice of

RED...BLACK...IVORY...BLUE...GREEN

Its beauty is made permanent by wrought brass (with a choice of steel or brass in hinges), with heavy chromium plate and an *insert* of color that cannot peel or fade no matter how often it is cleaned. Send for descriptive folder. The Stanley Works, New Britain, Conn. Los Angeles Office: 407 American Bank Building; San Francisco: 818 Monadnock Building; Seattle: 568 First Avenue, South.

STANLEY

TRADE MARK

HARDWARE FOR CAREFREE DOORS

Cabinet Spring
Latches



MC1290 1/4

for flush doors
MC1290 3/8

for lipped doors

Cabinet Hinges



MC1522

(Wrought Steel)

MC1522 1/2

(Wrought Brass)

Cabinet Hinges

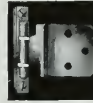

MC1521

(Wrought Steel)

MC1521 1/2

(Wrought Brass)

Drawer or
Cabinet Pull



MC1488



PRESSURE TREATED LUMBER

● PROTECTS AGAINST DECAY
AND TERMITE ATTACK

Specify it in your home
Available through Lumber Dealers

LOS ANGELES
601 W. 5th Street
Phone Michigan 6294

SAN FRANCISCO
333 Montgomery Street
Phone DOuglas 3883

J. H. Baxter & Co.

AGENTS FOR WEST COAST WOOD PRESERVING CO. SEATTLE, WASH



From the L.O.F. exhibit at the Golden Gate International Exposition.

Glass CREATES A GEM
OF BEAUTY AND *Color*

● Here new and fascinating types of glass create a modern bathroom that is a gem of beauty and color. There is something about glass that symbolizes cleanliness and sanitation—particularly in the bathroom. And here walls of cadet blue and princess blue Vitrolite with luminous Vitrolux for soft ceiling lighting elevate the room to a new plane of attractiveness and convenience.

And here, too, are found other alluring and serviceable applications of glass. The shower screen of polished Flutex... the sparkling mirrors and dressing table shelf, both of

polished Plate Glass... the dressing table stool and curved top of the low white seat both of heavy bent polished Plate Glass... the facing of white Vitrolite on the tub.

For practical utility and distinctive beauty in bathrooms use glass—generously. Your local L.O.F. distributor will explain the many extraordinary features of Vitrolite, Vitrolux and other types of glass. And he will gladly cooperate in the solution of any problem of design or application.

Libbey-Owens-Ford Glass Company, Toledo, O.

LIBBEY · OWENS · FORD
QUALITY GLASS



TOO MUCH "STREAMLINING"

THE modern artist no longer designs for man but for machines, according to Ralph T. Walker of New York, Fellow of the American Institute of Architects.

Attacking the growing influence of "streamlining," or functionalism, in art, Mr. Walker declares that architectural design will become stagnant if architects accept modern developments as being anywhere near perfect. As an example of how some modern designs have failed in the manner in which they are supposed to be superior, that is, in efficiency serving their purpose, Mr. Walker cites the fact that concert halls built more than thirty years ago are acoustically superior to radio studios costing millions of dollars and constructed within the past few years.

"Carnegie Hall in New York, the Academy of Music in Philadelphia, Symphony Hall in Boston, the Auditorium in Chicago, the Lyric Theatre in Baltimore, the Tabernacle in Salt Lake City, are more desirable for concerts than the so-called 'heavens' that have been created by experts specifically for men like Arturo Toscanini," he says. The reason given for the superiority of the older halls is that existing fire laws forbid the use of wood and slow-drying plaster, two substances which soften music and prevent echoes.

"The perfect visual hall and the perfect hall for hearing are not necessarily the same form," Mr. Walker points out. "If you consider the performer and his desires you might plan a vastly different hall than if you thought of modernism as concrete, plate glass and steel construction.

"The old halls have a psychological factor missing from the modern auditorium, especially those of the concrete and lally colum type, and that is a sense of playfulness and warmth. All the performers like the old rooms because in them they feel that a sympathetic and immediate response is possible from the audience out front. This is heretical, but how much the red plush, the gilt, and the great spaces contribute to this widespread belief is impossible to say.

"It remains an interesting idea that music sounds best both to the performer and to the auditor in places

like Carnegie Hall and the Metropolitan. Here there can be no doubt that the materials and atmosphere each contribute their part. And it would seem foolish for any designer to be so stiff-necked in modern formulas as to neglect to find out whether there is a basis for the belief in those qualities of the older rooms.

"Standardization of architectural design by Walter Gropius, the German architect whose glass and brick structures in the days before the World War foretold the buildings of today, and others of his philosophy has been offered as a new Utopia. 'In all epochs of history, the existence of standards—that is the conscious adoption of type forms—has been the criterion of a polite and well ordered society; for it is commonplace that repetition of the same things for the same purposes exercises a settling and civilizing influence on men's minds.'

"Shall we say that paragraph in another way? Let all thinking, all progress stop now. What we have accomplished now is sufficient. Actually what we will say if we agree with this idea is: our formula is the end, there can be nothing else.

"Here we have the great modern conflict constantly recurring, the conflict between the engineer and the inventor. The engineering mind of Walter Gropius (let us remember that none of the forms used by Gropius is his own invention but rather taken from the designers of factories, and those mostly Americans) determined to limit, to restrict, to make a stopping point to knowledge for civilization's sweet sake, all in contrast to the scientist-inventor type such as Einstein who sees no immediate reason for being satisfied, no adequate solution now within the present knowledge, and who is ever willing to think of standards as merely points of departure for new accomplishments."

FINE ARTS ALLIANCE

A number of professional and business people in Los Angeles have organized the Fine Arts Alliance of California, which will sponsor a monthly bulletin containing a schedule of fine arts events in the South. Gordon B. Kaufmann, architect, is president and Paul R. Hunter, another architect, is on the board of directors.

The Sensation of the Roofing Industry!



Find out about it!

THE PARAFFINE COMPANIES INC.
475 Brannan St., San Francisco

Please send information about the new Thermoslab.

Name.....

Address.....

City..... State.....

A & E



SEE THE CRANE INSERT IN SWEET'S ARCHITECTURAL CATALOG GIVING SUGGESTIONS ON PLANNING BATHROOMS, KITCHENS AND HEATING SYSTEMS

They Wanted a Bathroom That's Fun to Use

"WHEN we build," Jones Senior used to say, "we're going to have a bathroom that's more than a mere utility... a bathroom that's really FUN to use!" So today, in their new house, they have just that: a CRANE bathroom, selected by their architect to fit the Jones' ideas of comfort and convenience... at a price the Jones can afford to pay.

The people you're planning houses for like to get enjoyment out of life, too. You should know about Crane's bathroom planning service... a service that places at your disposal a wealth of new, practical ideas for making bathrooms more livable. In

Crane bathrooms, utility is made more attractive and enjoyable. The extra convenience of Crane plumbing products comes from better basic design... not from novelties or "gadgets." And because Crane can suggest a multitude of *complete* bathroom treatments, you are sure of obtaining the inherent harmony of form, design and color which every architect appreciates.

At the nearest Crane Display Room, the Crane Planner will help you in the planning of bathrooms to suit every type of home. Make it a point to visit the Crane Display Room and take advantage of this service and bring your client, too.



Efficiency in use combined with beauty in appearance are the qualities which your clients want in the kitchens you design for them. Crane modern sinks will help you make your kitchens both charming and convenient to use. Make use of the Crane Planning Service—it is maintained for your convenience.

CRANE

CRANE CO., GENERAL OFFICES
836 S. MICHIGAN AVE., CHICAGO
VALVES • FITTINGS • PIPE
PLUMBING • HEATING • PUMPS

NATION-WIDE SERVICE THROUGH BRANCHES, WHOLESALERS, PLUMBING AND HEATING CONTRACTORS



With the new Fuller Pure Prepared Primer, successful two-coat painting becomes a fact! Yes, two coats will outlast three applied the old way. For, unlike old-fashioned paint primers, this new Fuller primer penetrates evenly . . . provides a protective seal of uniform tensile strength, free from weak spots . . . and that means less chance of cracking or flaking. Ask your Fuller Paint dealer, or your painter, all about it!

**PURE PREPARED
 PRIMER**

**FULLER
 PAINTS**
they last

What's the difference between Advertising and Selling?

We might as well say — what's the difference between ham and eggs? There may be a difference; but you can't get as much satisfaction with either of them separately as you can in combination.

Advertising and selling work together like ham and eggs—when both are the best—you get the best results.

In combination with your best selling efforts—for best results—use the best advertising medium in the West Coast building field . . . now in its thirty-third year of continuous publication, read and respected by architects and professional building men everywhere.

THE
ARCHITECT and ENGINEER

68 POST STREET
 SAN FRANCISCO

•
Publishers of ARCHITECTS REPORTS
 •

*Sponsored and endorsed by the State Association
 of California Architects.*

**STREAMLINED
CONSTRUCTION
DEMANDS**

W A S T E D

**IN
CONCRETE
HARDENING**



**GOLDEN GATE
24
HOUR
PORTLAND CEMENT**



A "Pacific" Product
sold by Building
Materials Dealers.

*This New
20 page*
**MANUAL TELLS
HOW TO GET IT**

If you have not received
a copy your request
will be promptly
complied with.

Produced by

SAN FRANCISCO
LOS ANGELES

PACIFIC PORTLAND CEMENT COMPANY

PORTLAND
SEATTLE

COASTWIDE SERVICE

"DATED" HOUSES



A house is old when it fails to provide convenience and comfort to those living in it. A house with a score or more useful years behind it may yet be young, and one built yesterday may not be modern.

The electrical age is here, and electrical convenience is becoming increasingly important in the home. Antiquated lighting or an insufficient number of convenience outlets definitely places a house in the "pre-electrical" age.

The house which provides for the convenient use of appliances will remain modern indefinitely. The house in which few outlets are available, requiring unsightly and dangerous extension cords run under rugs or festooned around the room, is unnecessarily out-of-date.

Guard against premature obsolescence of the homes you design by including adequate electrical specifications.

•
See the electrical exhibits at the Palace of Electricity and Communications at the Golden Gate International Exposition

•

PACIFIC COAST ELECTRICAL BUREAU

447 SUTTER STREET • SAN FRANCISCO, CALIFORNIA

MISSION INN

One of Monterey's oldest historic buildings, yet offering the most modern convenience and comfort to travelers.

Plan to visit Monterey, Carmel and Pebble Beach . . . and plan to stop at this unusual Inn of early California charm.

Private parking.

IN HISTORIC

MONTEREY

BOOK OF LINCOLN FOUNDATION AWARDS

Fourteen of the 109 original studies of welding contained in the new book, "Arc Welding in Design, Manufacture and Construction," just published by the James F. Lincoln Arc Welding Foundation, Cleveland, Ohio, are on structural subjects, two of which pertain to steel-framed houses. The 14 studies, carried out by men who are well known in the field of structural design, are outstanding contributions of the recent \$200,000 award program. The structural section of the book contains 248 pages and 113 illustrations, including photographs and line drawings.

Decision to publish "Arc Welding in Design, Manufacture and Construction," was reached by trustees of the Lincoln Foundation at a meeting last fall. Feeling that the award papers constitute a large and valuable source of scientific study, research and information on welding, the trustees decided to make the material generally available. The book has been under preparation for six months.

"Arc Welding in Design, Manufacture and Construction" provides scientific and technical schools, colleges and universities, engineering bodies and libraries, as well as industrial and executive officials, a tremendous volume of data on welding. The book should be of incalculable value to designers, engineers, architects, production officials and others desirous of obtaining the benefits attributed to arc welded construction.



*A service for you
... and your clients*

As the national leader in FHA financing, Bank of America's interest in better housing coincides with that of the architect and the engineer. Finer design and better construction mean a sounder investment for the home owner, a more satisfactory loan for the bank. Your interests, as well as those of your clients, will receive the friendliest consideration at Bank of America.

Bank of America
NATIONAL TRUST & SAVINGS ASSOCIATION
Member Federal Deposit Insurance Corporation

With few exceptions, the papers are reproduced in complete form. Only those which were too lengthy for inclusion in their entirety are in the form of comprehensive briefs. All photographs and drawings essential to a clear and adequate presentation of each subject are included. Each study includes designs, calculations, procedures and other pertinent information showing how the advantages attributed to arc welded construction are obtained.

"THE WORLD OF TOMORROW"

Projecting its motto into the vistas of tomorrow, steel pulls back the curtain of time at its "Hall of the Future," a feature of the United States Steel Subsidiaries' exhibit at the New York World's Fair. Here scientists, reading from the discoveries of today the possible applications of tomorrow, have woven a stimulating pattern of man's future environment. Farms operated by radio control, prefabricated houses with rooms sliding in place like the drawers of a desk, and elevated pneumatic tubes in which the traveler is sped to his destination by compressed air, all appear in animated models.

The exhibit, arranged in panoramic form, successively presents the possible evolution of the highway, the factory, the farm, the city, and the home of tomorrow. Emphasizing the combination of utility and beauty, each unit is a promise of what man may do with the tools that he has fashioned for creating a life of increased order, efficiency, and convenience.

MORE BEAUTIFUL THAN MARBLE

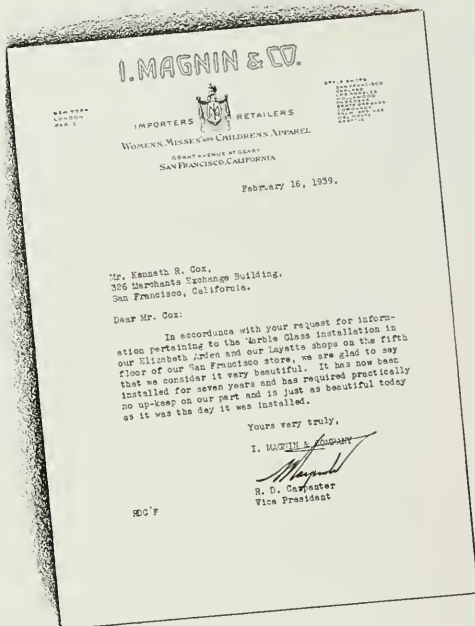

INSTALLED 7 YEARS

and
"Just as beautiful today as it was the day it was installed"

... writes Mr. R. D. Carpenter, vice-president of I. Magnin & Co. Because of its patented method of manufacture, the ornamental design of the new MARBLE-GLASS — which utilizes ceramic colors — becomes an integral part of the glass. It cannot be injured unless the glass, itself, is broken.

MARBLE-GLASS, the new building material, has the physical characteristics of plate glass. Not just another marble substitute, however, MARBLE-GLASS lends itself to a wide variety of applications, designs and effects, not possible with other products. Every installation backed by a *50 Year Written Guarantee!* Let us supply you with complete information and samples.

Among the uses for MARBLE-GLASS:

Store fronts; corridors and vestibules; table tops and counters; facing and tops for bars and fountains; fireplaces; showers and bathrooms; restaurants; hotels; office buildings; hospitals; theaters.

General Offices:

**RUSS BUILDING
SAN FRANCISCO
TEL. SUTTER
8081**

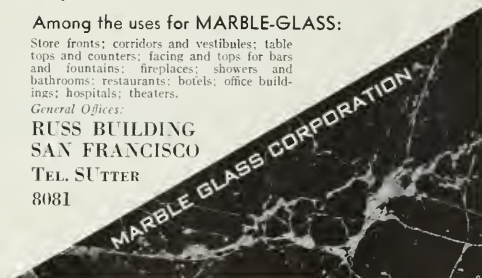

Haws Drinking Fountains

in retail stores indicate consideration for the comfort of patrons. Roos Bros., not overlooking this added convenience to customers, have equipped their new

Fresno store with HAWS DRINKING FOUNTAINS, which meet the requirements of the American Public Health Association.



**HAWS DRINKING
FAUCET CO.**

**1808 Harmon Street · Berkeley
Agents in San Francisco · Los Angeles
Portland · Seattle · Salt Lake City**



First and Pine Branch, Bank of America

Long Beach, California



Entrance detail, faced with N. CLARK & SONS CERAMIC VENEER. Also showing use of Alameda Quarry Tile for stair treads and risers.

WHEN Bank of America decided to "dress up" the exterior appearance of the First and Pine Branch in Long Beach . . . N. Clark & Sons Ceramic Veneer was selected for application over the existing facade for first story height, fronting on two streets.

This is one of many similar N. Clark & Sons installations in Southern California and Arizona . . . demonstrating the ease with which dull, uninteresting old building exteriors may be modernized with attractive, colorful, durable Ceramic Veneer.

Pacific Clay Products, 306 West Avenue 26, Los Angeles, are our sales representatives in this area. Consult with them for complete information on Ceramic Veneer, Unitile, Terra Cotta Wall Units and Quarry Tile.

N • CLARK & SONS

116 NATOMA STREET, SAN FRANCISCO

LOS ANGELES

SALT LAKE CITY

PORTLAND



VIEW FROM NORTH CENTER, OREGON STATE CAPITOL, SALEM, OREGON
TROWBRIDGE & LIVINGSTON & FRANCIS KEALLY, ARCHITECTS
WHITEHOUSE & CHURCH, OREGON, ASSOCIATES

Photo by Frank L. ...

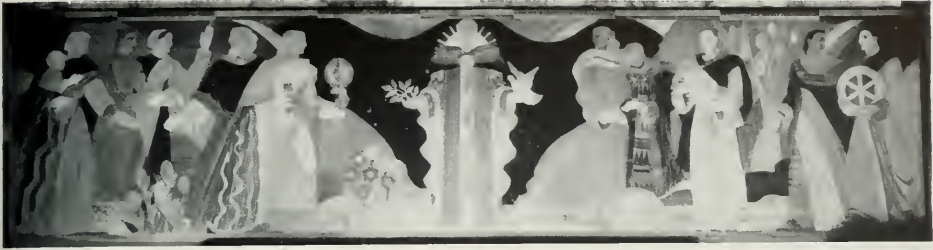

MARQUETRY MURAL, NEW YORK WORLD'S FAIR, BY AIMEE GORHAM

(See page 34 for descriptive matter.)

CURRENT NOTES FROM THE ARCHITECTS OF PORTLAND, ORE.

By Glenn Stanton, A.I.A.

A GAIN the Oregonians have the floor, so to speak. Last year we reviewed briefly our scant architectural background. The facts touched upon were that in our relatively new country, we are rather free from the effects of tradition, though a few are discernible.

Portland's founders, hailing from New England, were conservative, and that characteristic still persists. As a Pacific port we have been slightly influenced by the Oriental feeling. Climate, too, is a factor in our conservative manners.

On the other hand, there is another trend definitely toward the modern interpretation, and though again conservative, it is extremely promising and thoroughly sound.

As one architect to another, to dwell on the examples herewith offered would be a trite waste of time and space, so they are submitted for your approval with brief comment.

Portland architects, fortunately, have at their service a fine group of qualified craftsmen and builders. An organization which has been instrumental in the maintaining of high standards in the building industry during the past eighteen years is the Oregon Building Congress. They have acted as a clearing house for all concerned and have functioned in a valuable manner.

One of their most worthwhile activities has been the encouragement of young craftsmen by apprenticeship training. These trained men are helping to continue the high standard of work demanded by our profession.

Besides those encouraged in the usual trades, independent craftsmen often appear with achievements in their individual field.

One such artist and craft worker is Aimee Gorham.

Her artistry and technique are her own. Only after many patient years of experimenting and development has she ventured to apprise the architects of the results. Now, they speak for themselves.

These distinguished murals are designed with a fine feeling for composition and subtle appreciation of color. Her palette of wood veneers is handled with a deft and sure touch, and the effects are beautiful to behold.

Besides the cuts shown of panels done for our two fairs, her work may be seen in the lobby of the Commerce Building of Oregon State College at Corvallis, as well as at Timberline Lodge on Mount Hood.

Mrs. Gorham is an artist who we are proud to claim as an Oregonian.



BUILDING FOR WEISFIELD & GOLDBERG, PORTLAND, OREGON

Harry A. Herzog, Architect

A careful combination of fine materials brings freshness and interest to Mr. Herzog's work



BOHEMIAN RESTAURANT, PORTLAND, OREGON

Lawrence, Holford & Allyn, Architects

Architectural Metals by Oregon Brass Works

Here the architects have combined materials effectively



MILLINERY SHOP, PORTLAND OREGON
 Harry A. Herzog, Architect

OFFICE BUILDING FOR THE
 EQUITABLE SAVINGS & LOAN ASSN.,
 PORTLAND, OREGON

A. E. Doyle & Associate, Architects

The work of this firm reflects a fine feeling
 for pattern with courage for simple and
 sound solutions



Architectural Metals by Oregon Brass Works



DETAIL OF ENTRANCE, MAIL-WELL ENVELOPE COMPANY, PORTLAND
Richard Sundeleaf, Architect

Photo by Jourdan

Mr. Sundeleaf's industrial and commercial work is characterized by straightforward treatment and sound planning.



ALTERATIONS TO HEATHMAN HOTEL GARAGE, PORTLAND, OREGON
A. E. Doyle & Associate, Architects



INFIRMARY, UNIVERSITY OF OREGON HEALTH SERVICE, EUGENE, OREGON
Lawrence, Holford and Allyn, Architects



WILSON-CHAMBERS MORTUARY, PORTLAND, OREGON
Richard Sundeleaf, Architect



CHAPEL, Y.M.C.A. BUILDING, PORTLAND, OREGON
Glenn Stanton, Architect



OFFICES AND GARAGE FOR OREGON MOTOR STAGES, PORTLAND, OREGON
Knighton & Howell, Architects

Photo by Boychuk



WAREHOUSE BUILDING FOR THE CITY OF PORTLAND
Knighton & Howell, Architects

Photo by Boychuk

Sensitive and successful handling of architectural concrete detail is reflected in the above work



Photo by Walter Hazar, Jr.

GARDEN OF DR. AND MRS. E. W. MORSE, PORTLAND, OREGON
Florence Holmes Gerke and Walter Gerke, Landscape Architects

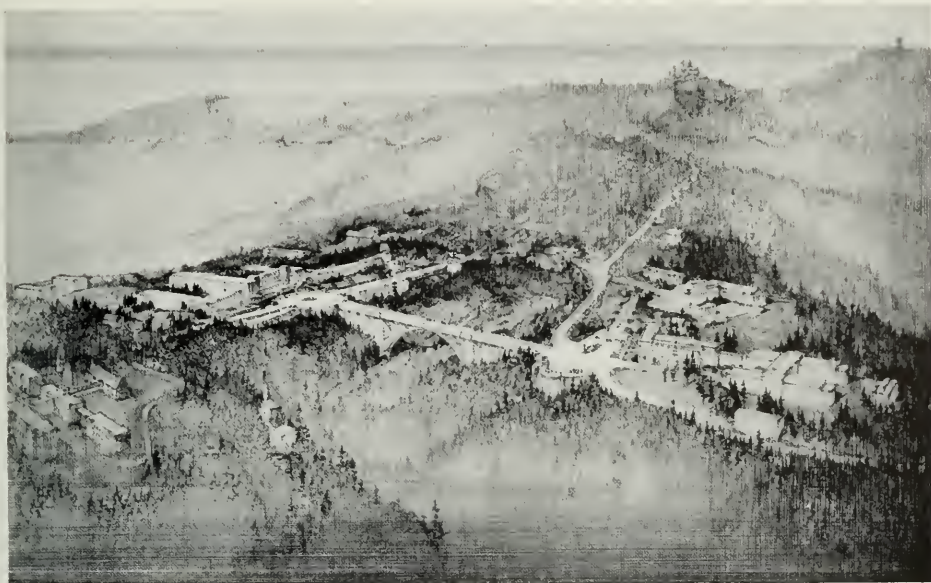

AIRPLANE VIEW OF JACKSON PARK, SHOWING UNIVERSITY OF OREGON
MEDICAL SCHOOL AND HOSPITALS, PORTLAND, OREGON

Lawrence, Holford & Allyn, Architects



FIRST CHURCH OF CHRIST, SCIENTIST, CORVALLIS, OREGON

Glenn Stanton, Architect



ST. JOSEPH'S SCHOOL
ROSEBERG, OREGON

ST. JOSEPH'S PAROCHIAL SCHOOL, ROSEBERG, OREGON

Francis D. Jacobberger, Architect

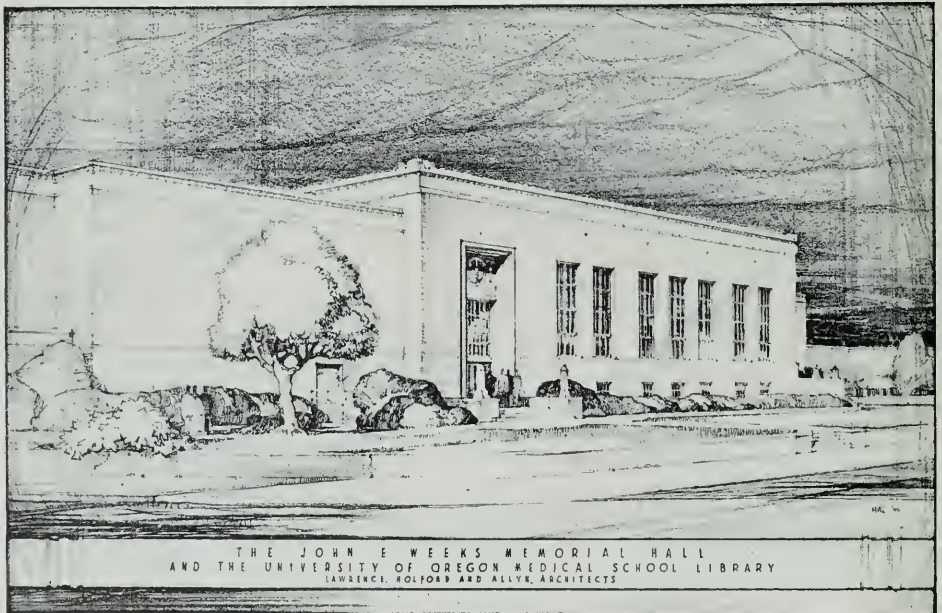

THE JOHN E. WEEKS MEMORIAL HALL
AND THE UNIVERSITY OF OREGON MEDICAL SCHOOL LIBRARY
LAWRENCE, HOLFORD AND ALLYN, ARCHITECTS

WEEKS MEMORIAL HALL AND UNIVERSITY OF OREGON MEDICAL SCHOOL LIBRARY

Lawrence, Holford & Allyn, Architects



HOUSE FOR MR. AND MRS. P. BELLUSCHI, PORTLAND, OREGON
A. E. Doyle & Associate, Architects



GARDEN ELEVATION, HOUSE FOR MR. AND MRS. P. BELLUSCHI,
PORTLAND, OREGON
A. E. Doyle & Associate, Architects



ENTRANCE DETAIL, RESIDENCE OF WILLIAM JENKINS, SEATTLE, WASHINGTON
Roi L. Morin, Architect

A typical example of Mr. Morin's study of detail; profiles strong and vigorous



RESIDENCE OF WILLIAM JENKINS, SEATTLE, WASHINGTON

Roi L. Morin, Architect

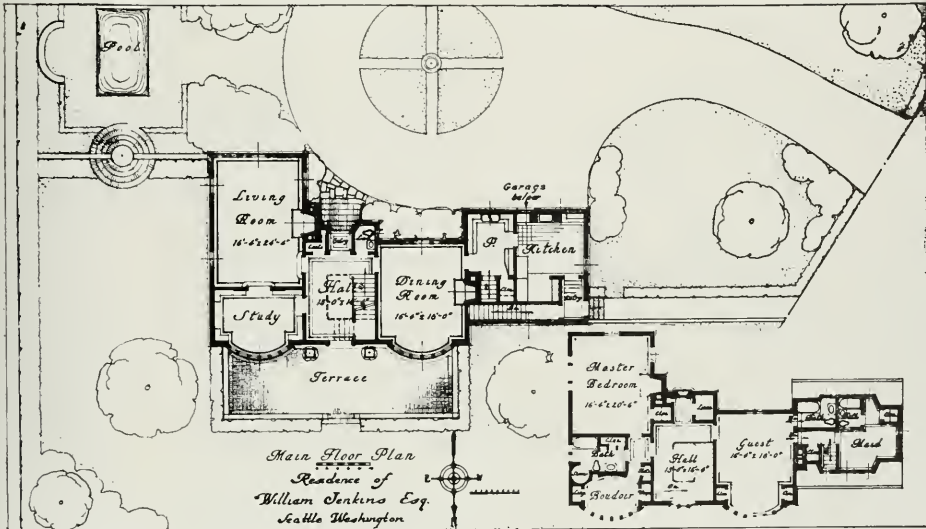

PLANS, RESIDENCE OF WILLIAM JENKINS, SEATTLE, WASHINGTON

Roi L. Morin, Architect



ENTRANCE FRONT, RESIDENCE OF DR. MILTON STEINER, PORTLAND, OREGON
 Harold W. Doty, Architect

Mr. Doty, though often classed as English in his design, is always resourceful, sincere and original

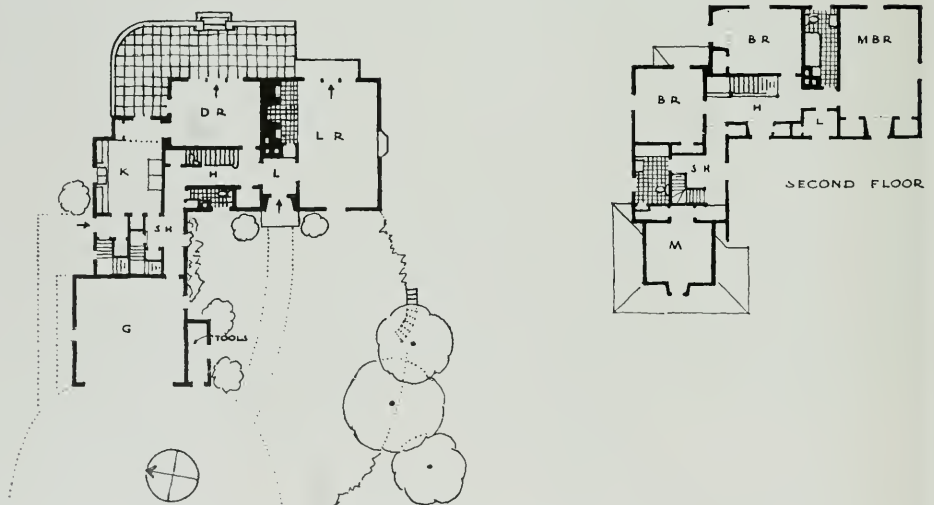

PLANS, RESIDENCE OF DR. MILTON STEINER, PORTLAND, OREGON



HOUSE FOR MR. AND MRS. LEO H. BARUH, PORTLAND, OREGON
Hollis Johnston and Herman Brookman, Architects

The work of this firm shows carefully studies detail and consistent concern for color and texture

SMALL HOUSE FOR
MR. AND MRS.
R. P. LEWIS,
PORTLAND

HOLLIS JOHNSTON
AND HERMAN
BROOKMAN,
ARCHITECTS



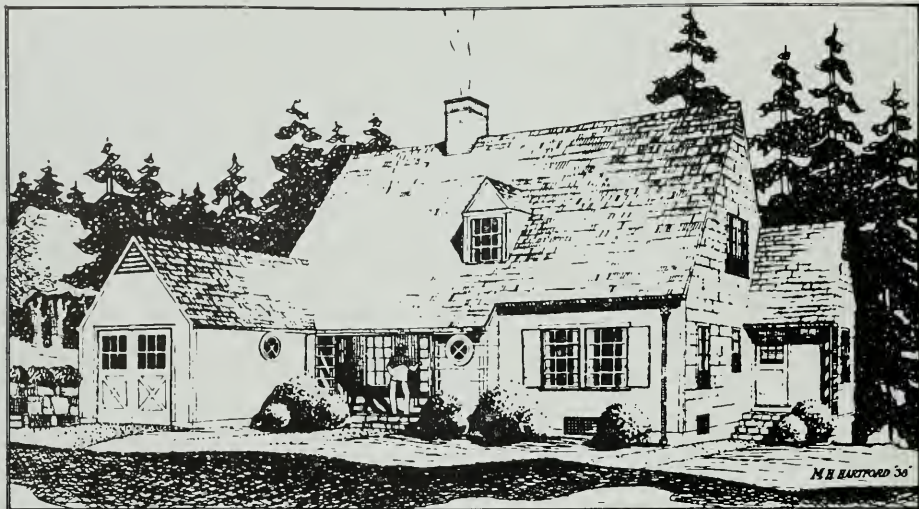

RESIDENCE FOR CHARLES BLACKBURN, LAKE OSWEGO, OREGON
Morgan H. Hartford, Architect

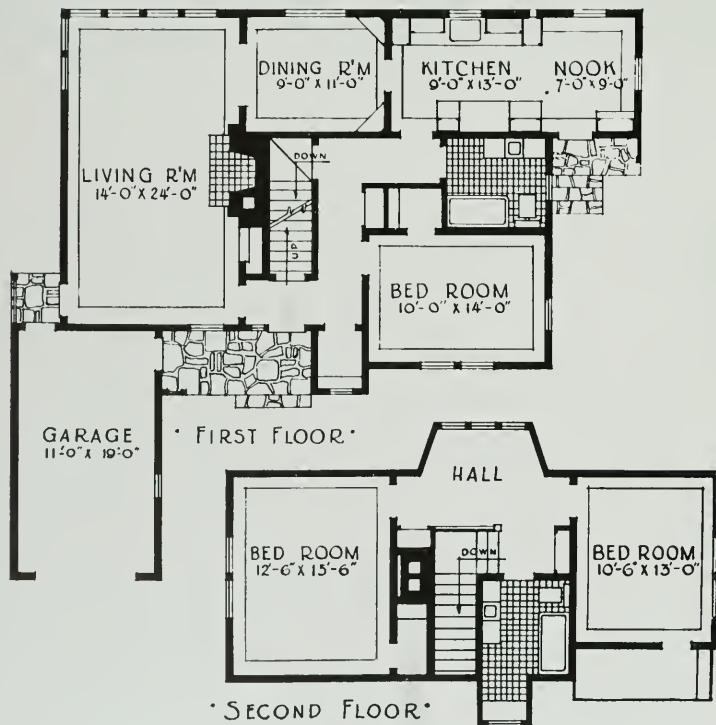

CONSTRUCTION OUTLINE

Chas. Blackburn Residence, Near Portland, Oregon, Morgan H. Hartford, Architect

Structure built in 1938.

Typs—Wood frame.

Exterior—Royal shingles and T & G flush siding walls.

Roof—Wood shingle.

Heating—gas forced air.

Basement—Rumpus room.

First Floor—Living room, dining room, kitchen, nook, bedroom, bath, porches, and garage.

Second Floor—Two bedrooms, bath and hall.

All rooms arranged for lake view.

House situated with north side facing lake.

Building has been adapted to rocky terrain of the site so that basement wall on lake front is exposed full height, providing view and making possible overhang shown in sketch.



RESIDENCE OF MR. AND MRS. W. A. HEALY, PORTLAND, OREGON

Tucker and Wallmann, Architects

Good planning evident in simple elevations; splendid feeling for relation of house and grounds



ENTRANCE HALL AND STAIRCASE,
RESIDENCE OF MR. AND MRS.
W. A. HEALY, PORTLAND, OREGON

Tucker and Wallman, Architects

FIFTH SYMPHONY INSPIRATION FOR MARQUETRY MURALS

IN this issue are two marquetry veneer murals—one, on page 17, executed for the New York Fair; the other a panel for the Golden Gate International Exposition. The former constitutes the main decoration in the state dining room of the United States Building at the New York Fair.

The President of the United States and the King and Queen of England will be entertained in this room.

Walter Dorwin Teague designed a special setting for the New York mural. A long, modern sideboard is underneath the mural, with chairs on either side; at each side of the center mural

are vertical panels reaching to the baseboard. The entire panel, with the two sides, is 25 feet four inches high. The center panel is 15 feet long.

Subject of the mural is "International Cooperation."

The central figure stands for "universal friendliness and brotherhood." To the extreme right are Industry, Wealth, Fruits of Earth, and a figure (next to the central one) who symbolizes "the kindness of man"; he leads "Wickedness" to the spirit of Universal Brotherhood.

At the extreme left, the "Coming Generation" is being brought for protection to Law and Government; while in the background, two figures represent Science, one with a retort, and one with a ray of light extending from his upraised hand.

The two side panels (not shown) represent Mercy and Peace—one, the ancient symbol of mercy, three pure white flowers, and the other a broken sword with wheat growing therefrom.

Purples, oranges, and reds are among the rich colors in the center panel.

The artist, Mrs. Aimee Gorham, listened to Tchaicowsky's Fifth Symphony while designing the mural; she feels that there is a correlation between music and art.

Panel for the San Francisco Fair is 3 feet by 5 feet. The wood is very light in tone. Curly maple was used in the figures . . . browns, soft yellow and dull pink. The mural might be used as an over-mantel decoration.



MARQUETRY PANEL AT GOLDEN GATE
INTERNATIONAL EXPOSITION, SAN FRANCISCO

COOPERATION BETWEEN ARCHITECTS AND BUILDING INDUSTRY

By Harry M. Michelsen, A.I.A.

I DID not come here to make a formal speech* as an official representative of any architectural society; I came simply as one interested in this question to participate in your discussions of the relation of construction to the professional groups, in the hope that I might help to eliminate some of the misunderstandings and misconceptions that may exist. What we need most at the present time is tolerance on both sides, a willingness to see the other man's problems from his viewpoint.

It is my intention and desire to attempt to establish a closer relationship between the various groups that comprise the building industry. In all construction enterprises, there are at least four factors: capital, design, labor, and management. The ultimate employer of all four is the user. The construction industry as a whole thus contributes to the public a service and realistic results that are beneficial to the entire community.

We are all conscious of the striking disparity between the world's actual consumption of construction projects and services, and the potential powers of production with which science has now endowed us. Few of us accept this situation as the natural and permanent result of the progressive application of science to all fields of endeavor. We recognize our present troubles to have arisen to a large extent because our progress has been unbalanced and there has been a delay between theoretical progress and advancement in the other departments of endeavor. We recognize that the danger of our present situation lies not in the increasing of scientific developments but in the uneven methods of financing and cooperation. While productive efficiency has increased and continues to advance with bewildering rapidity, we destroy much of the possible advantage to be derived from this program by methods in our distribution and in our dealings with our fellow men. If we continue to believe that the problems must be solved by the artificial crea-

tion of building construction or through restricting production by the elimination of modern methods and devices, the situation will continue to follow a downward trend.

Progress in the science of management in construction, as in all sciences, is achieved through the normal procedure of scientific methods, that is through the collection and classification of facts, through testing the conclusions drawn from them, and the standardization of those methods which, in the light of the available facts and by experience, are shown to be the best. Scientific methods are essentially a social activity requiring the highest degree of cooperation, and it is largely due to the lack of such cooperation, more particularly in construction affiliations, that scientific progress has not been more rapid.

To make this statement is not to deny that much has been done and still more attempted. In recent years new methods of technique and organization have been attempted to secure the minimum waste of labor or material. Improved methods of design, management of construction, standardization of materials and practices, simplification of processes, and improvements in the system of erecting structures, have led to greater achievements.

In considering cooperation between the architects and the construction industry, it is essential that we review the activities that have taken place in recent years. Many projects, such as the development of roads, city planning, and the architectural treatment of bridges and other projects have been of vast importance to the public. First of all, most of these elements are considered from architectural and engineering standpoints, and then put into realistic form by the contractors; it being almost impossible for any one of these groups to function successfully without the close cooperation of the others.

Over a period of many years the architects have been very active in enhancing roadside

* An address before the National Convention of Associate Contractors of America at San Francisco, March 8, 1939.

beauty. It has been established that it is impossible to pass legislation affecting structures that may be offensive to the sense of vision, but obstructions, adjacent to highways, that interfere with the safety of driving may be eliminated, which leads to more beautiful roads and pleasant scenery. Highways have been greatly developed, as they not only add convenience and comfort to travel among the pleasure-seeking public, but are greatly utilized for commercial purposes. Simultaneously with this wide expanse of highway systems, the demand for new structures has stimulated business throughout the building industry. For this reason it is the architects' duty to cooperate with the engineers and contractors to the fullest extent, with the thought in mind of further developing construction enterprises to create a higher standard of living throughout the nation.

Many new designs in the construction of roadways are constantly being brought forth. Recently the elevated highway and boulevard, which years ago were considered as impractical, have been promoted and are being given serious thought by the larger cities as a solution to the congested streets now in existence. I wish to congratulate Mr. Lynn Atkinson, who has devoted his time and efforts in attempting to establish elevated boulevards in many large cities, particularly in San Francisco and Los Angeles. To some, his ideas may sound fantastic, but those who realize that the traffic situation is becoming acute know that new experiments will have to be made in the near future in order that automobile travel may be kept in conformity with the everchanging era in which we live. An analysis of Mr. Atkinson's plans shows that this type of highway is practical and feasible, and is not prohibitive, as some may suppose, due to high construction costs. Greater speed and safety, and more economical transportation should be the result of this type of construction, and it seems probable that these facts will be recognized within a few years.

Similarly, the Golden Gate and the San Francisco-Oakland Bay Bridges were only an engineer's dream for many years prior to their con-

struction, and they are beyond a doubt proving to be a beneficial link between the Bay cities and are allowing travel to move rapidly between these areas. The financial aid of both the federal and state governments has made these projects, as well as many other transportation improvements, possible, as a direct result of which the surrounding country has enjoyed increased building activities of various types.

These subjects merely enumerate a few of the recent developments in construction projects, but are characteristic of the progress that is being made. It was through the contiguity of finance, design, and construction that these great undertakings were possible.

If we are to continue to develop in the construction field, new efforts towards a joint understanding must be predicated on the basis of intellectual good will, such understanding being in direct proportion to disseminated knowledge. The past years of our existence, with combined and diversified action for an improvement in cooperation, are an adequate guarantee that the professional and construction groups will be closer related in their activities in the future. It is clear, that while objectives may remain unchanged, and methods of procedure vary according to the needs and requirements of the times, conditions outside of the industry may contribute to make more obvious an intensification of efforts to achieve a fundamental basis for progress.

It is interesting to note that within the last few years there has developed a strong sentiment to correlate the construction industry. Prior to the present organized political and labor era, it was difficult to find associations which were devoting time, thought, and energy to ascertain ways of improving conditions for the combined industry. As we review the various organizations, such as Building Conference Boards, Construction Congresses, and other special units pertaining to construction in many civic societies, we must agree that there is a growing natural tendency toward the unification of our industry.

During this period of economic and political

(Turn to Page 49)



UNION PASSENGER STATION, LOS ANGELES, CALIFORNIA

Illustrations Courtesy Southwest Builder and Contractor

Left—Main Entrance and Tower. Right—South Patio Looking West Toward the Tower

LOS ANGELES UNION PASSENGER RAILWAY STATION

LOS ANGELES now may boast of one of the most beautiful Union Passenger Stations in the country. Completion of the \$11,000,000 building was marked by a three days celebration which began May 3 and ended on the 5th.

The new terminal occupies a 44-acre tract on Alameda Street between Aliso Street on the south and Macy Street on the north. There may be larger terminals in many of the metropolitan cities of the east and midwest but none more modern or better planned and none so beautiful and glamorous. In fact, as our contemporary, the Southwest Builder and Contractor says, "in all the world it has no counterpart and as an expression of Southern California spirit and architecture it is destined to spread the fame of Los Angeles already known for its many wonderful show places."

In keeping with Southern California traditions the early Spanish influence is dominant in the architectural treatment of the passenger station and its appurtenant units. The buildings were planned and designed by an architectural committee consisting of the architects of the three railroad companies, J. H. Christie of the Southern Pacific, H. L. Gilman of the Santa Fe and R. J. Wirth of the Union Pacific, with the firm of John Parkinson and Donald B. Parkinson as consulting architects. The senior member of the consulting firm who participated in the preliminary architectural activities did not live to see the consummation of the project, his son, Donald B. Parkinson, carrying on for the firm.

One of the features of the design is the massing and the balancing of effects which,



UNION PASSENGER STATION, LOS ANGELES, CALIFORNIA

Left—Arcade connecting station building with restaurant. Center—Station buildings from parking area. Right—Close up of station entrance

with the extended frontage, makes a most interesting study. Even more intriguing are the lines of the low-pitched red tile roofs which, viewed from different points, particularly in the rear, produce architectural effects reminiscent of some of the notable buildings of old Spain. Particularly interesting are the converging roof lines at varying levels where the waiting room joins the main concourse in the rear.

A detailed description of the project would require more space than is here available. Briefly the layout contains three distinct divisions.

First, the passenger station buildings, set back about 222 feet from and fronting on Alameda Street, which stretch out parallel to it some 800 feet.

Second, the mail, baggage and express building immediately back of and parallel to the station buildings. This structure is approximately 1200 feet in length, two stories in height in the middle and three stories at either end.

Third, the tracks and train sheds, on a higher level approximately even with the second floor of the mail, baggage and express building to which a tunnel 28 feet wide and ramps give

UNION PASSENGER STATION, LOS ANGELES

Left—Rear view of station. Right—Section of train concourse

Photos by Woodcock



access from the train concourse. There are 16 tracks for passenger trains with 8 steel umbrella sheds, ranging from 600 to 1200 feet in length.

The passenger station is "L" shaped and consists of three structural units, one paralleling Alameda Street containing the main concourse and the entrance lobby, another extending from it at a right angle, containing the waiting room, and a third the tower. The main unit is 80 feet wide and 210 feet long, inside dimensions; the second containing the waiting room, 80 feet wide and 140 feet in length, and the tower 30x30 feet and 125 feet in height.

The entrance lobby and the waiting room are on the main axis extending west to east to the train concourse in the mail, baggage and express building. This forms the principal unit in the architectural plan, extending back from the high arched entrance a width of 80 feet and a distance of 220 feet. Separating the entrance lobby in the main concourse and the waiting room is a massive open arch.

On the left, continuous with the entrance lobby, is the main concourse in which the separate ticket booths of the three railroad companies are located. This room is 62 feet in height from the floor to the top of the walls supporting the roof arches spanning the 80-foot clear floor. An idea of the scale may be obtained when it is stated that an ordinary 5-story building could be set inside of it and there would be room to spare. The concourse is distinguished by three high arched windows in the east and west walls.

These three units of the station are all steel frame construction with roof trusses spanning the clear width of the main entrance lobby and waiting room and the main concourse. The steel frame is set between two reinforced concrete walls, one on the outside and the other on the inside, giving the appearance of massive masonry, with the deep reveals at openings.

At the north end of the main concourse is a two-story extension containing the public rest rooms on the ground floor and the terminal administrative offices on the second floor. South of the station and connected to it by a

high arcade is a building containing a spacious restaurant and kitchen. A covered cloister running back from the restaurant to the mail, baggage and express building completes a large quadrangle, known as the south patio, which is beautifully landscaped and through which incoming passengers may pass on leaving the train concourse. Opposite to it on the north side of the waiting room is a large patio enclosed on the north by a wall extending from the main concourse to the mail, baggage and express building. This, known as the north patio, is also beautifully landscaped. All structures outside of the main units of the station group are reinforced concrete. Exterior walls of all these buildings are coated with cement waterproof paint applied directly to concrete surfaces.

The train concourse at the east end of the waiting room occupies the ground floor of the mail, baggage and express building on a level with the main floors of all the station buildings. Entrance of the tunnel to the train sheds is off this concourse.

Interiors of all the station rooms are treated in harmonious color schemes and materials appropriate to the Spanish architectural motive. Floors in the main entrance lobby waiting room and the main concourse are red Padre tile with a central strip of vari-colored marbles in patterns simulating continuous rugs. These marbles include Verde Antique from Vermont, Alicante from Spain, Montana Travertine, Tennessee marble and Campan Melange. The floors in the train concourse are cement tile in pastel shades.

The wainscot in the main concourse and the waiting room consists of a field of Montana Travertine, a golden yellow; with Bois Jordan, a dark marble with spots of green and red Campan Melange, and base of Black Belgian marble. Wainscot in the train concourse is a California faience tile. Approximately 75,000 square feet of marble and tile were used.

Walls of all the principal station rooms are covered with acoustic board; also the ceiling in the train concourse. The steel roof trusses



UNION PASSENGER STATION, LOS ANGELES

Upper part from Curcio; Right—Arch separating entrance lobby and waiting

are furred and plastered to simulate heavy timbers and the ceiling panels between are decorated in conventional designs. Lighting fixtures in the main concourse entrance lobby and waiting room are massive metal chandeliers. Lighting of the train concourse is diffused through glass ceiling panels.

Wood finish in the principal station rooms is black walnut. The ticket booths in the main concourse are also of the same kind of wood. Outside doors and grills are of bronze.

The mail, baggage and express building is adjacent to the 500,000 cubic yard earth fill on which the depot tracks are laid.

This building, containing approximately 200,000 square feet floor area, is of heavy reinforced concrete construction, designed for live loads of 250 lbs. per square foot, utilizing the Mushroom flat slab floor system. All exterior and interior wall surfaces and ceilings are the natural concrete as stripped of the plywood forms which left true and even surfaces. The power plant and mechanical equipment for all

the buildings are installed in the first story of this building. At the north end of the station is a garage with a capacity for 134 cars where passengers may store their automobiles when leaving the city by train and pick them up on their return.

The grounds in front of the station are laid out for automobile parking and landscaped. The planting here and in the north and south patios is on an elaborate scale, including grown trees of various species common to Southern California, such as palms, olive trees, pepper trees, eucalyptus, rubber trees and others of an ornamental and flowering type. In the enclosed north patio there are two rows of orange trees bearing their golden fruit. In the middle of the north wall in this patio is a tile backed fountain. The walks are paved with natural flagstones. In the south patio the walks are paved with brick in herringbone pattern. This patio with its picturesque pylons, trees, shrubs and flowers provides a charming typical Southern California vista to all passengers and visitors coming and going.

TEN QUESTIONS AND ANSWERS ON RADIANT HEAT

By C. A. Russell*

1. *Radiant heat travels at the rate of how many feet?*

Answer: 58,924,800,000 feet per minute (186,000 miles per second—the speed of light).

2. *Does the ordinary house heating system warm the human body?*

Answer: It does not. When the room temperature is 83 degrees, or less, the human body actually contributes heat to the room.

3. *Which of these solids will attain the highest temperature if all three are placed in a uniformly heated room—Iron, Wood or Asbestos?*

Answer: All solid objects in a uniformly heated room have the same temperature whether they be of iron, wood, asbestos or any other material.

4. *Heat can be transferred from one body to another in how many different ways?*

Answer: Three different ways—radiation, convection, conduction.

5. *If radiant heat is passed through a cake of pure transparent ice, upon leaving it would it con-*

tain more, less, or as much heat?

Answer: As much heat—and it would not melt the ice.

6. *Can infra-red rays be seen by the human eye?*

Answer: No, and some of them cannot even be felt.

7. *How is the heat of the sun imparted to the earth's atmosphere?*

Answer: By conduction. The sun's radiant heat is absorbed by the earth. The earth, in turn, imparts its heat to the atmosphere by conduction.

8. *When their actual temperatures are identical does a metal object feel to the touch colder, warmer, or the same as a wooden object?*

Answer: Colder. The heat is conducted from the hand more rapidly by a metal object, producing a sensation of chill.

9. *When you are in a room whose temperature is 70 degrees, and you are normally clothed, is the heat transferred outward or inward from the body?*

* General Sales Manager, Wesix Electric Heater Co., San Francisco.

Answer: Outward from the body. Normal body surface temperature is 83 degrees, or more, and heat is transferred outward until the room temperature equals or exceeds that of the body.

10. *What is the most practical means of providing comfort in the bathroom—by furnace duct, steam pipe, electric fan heater, electric spot heater, or electric radiant convection heater?*

Answer: An electric radiant-convection type heater.

These facts, of course, are not new to science; but they form the background for an interesting analysis of the desirability of heat in relation to human needs—particularly in the bathroom.

The human body gives up its heat through various avenues. Some of it is dissipated through body wastes; 14.5% through evaporation from the skin; 23% by convection; 40% by radiation from the skin.

The problem is to prevent our body heat from being dissipated too rapidly. If our bodies are clothed and we are at rest, other conditions being normal, 70 degrees is the room temperature which seems to hold the heat loss at the point where we experience greatest bodily comfort.

The bathroom, however, presents another problem. Bathers, being unclad, are totally uninsulated against body heat losses. In addition, the bathroom temperature is lower than that in the remainder of the house because the fixtures and the tile floors and walls absorb a far greater amount of heat, proportionately, than the floor and walls in other rooms.

Now before we go further into the discussion of bathroom heat, let us visualize the drafting room of a well-known architect. He is seated at his desk, with a set of house plans unrolled before him. At his shoulder a young draftsman is leaning over and pointing to a feature in the plans.

Assistant: "What can we do about this?"

Architect: "Leave it."

Assistant: "But it's not practical."

Architect: "Who wants a practical house?"

Ridiculous, of course. Yet this scene actually transpired in one architect's office. And not being subject to the same restraint of employer-employee relationship as the assistant, we make

so bold as to answer for him. "Everyone wants a practical house."

"Maybe so," you say, "but just about all our clients ever talk about is looks." Well, isn't that why they come to you in the first place—to get a home with personality and charm? People to whom practical things are the only ones that matter are content to do without an architect, and "save" the fee. Your clients talk principally about appearance, but they assume that the homes you design for them will be as practical as they are beautiful.

The bathroom, for instance, is used every day by every member of the family. To be able to determine the correct means of providing comfort in it requires only a rudimentary knowledge of physics—just enough to answer simple questions like those above. Yet there are cases, even today, of architects who fail to apply their theoretical knowledge to this practical problem.

Consider the man of the house going into the bathroom for his morning shower. The air is cold—colder than elsewhere in the house because the fixtures have absorbed whatever heat there was in the room—and colder still if the room has tile floors and walls. We know that heat flows from hot to cold, and that the greater the difference in temperature the greater the speed of flow. The vitality of this man, therefore, is going to be used in diffusing heat, by radiation and by convection, from his body to the relatively chilly surroundings. This lowers his resistance and increases his susceptibility to the disease germs which are constantly in the air. For comfort, and to safeguard his health, he needs heat in the bathroom; but what kind of heat?

A central furnace duct? This does not meet the requirements because it takes more time than most men can spare in the morning. Unless expensive auxiliary devices are used the entire house must be heated to get the necessary warmth in any one room, and, during most of the year, in California, especially, the bathroom is the only room that needs to be heated. If the auxiliary devices are used, the installation cost of the separate furnace duct is much greater than that of other systems. And if a

fully automatic system is used, so that the house temperature is kept constant 24 hours of the day, the operating cost will be out of reach of the average pocketbook. Nor will a steam radiator or any central plant extension provide the solution, for the same reasons.

An electric "fan" heater? If a forced draft electric heater—commonly called a "fan" heater—is used our early morning bather upon emerging from his bath will experience the same sensations, to a degree, that he would if he stepped from a swimming pool and stood in front of an electric fan! Even though the air is warm, the fact that it is blown across his body at too great a velocity causes discomfort. The rate of heat dissipation from the body, body heat loss by convection, the rate of evaporation of moisture on his skin—all are increased, with a resultant effect of a chill. At the same time, his body continues to lose heat by radiation into the cold fixtures, floors, and walls. A fan heater should never be used in the bathroom.

An electric "spot" heater? If he uses an electric radiant heater of the reflector or "spot" type he makes a momentary gain in bodily comfort. The radiant rays, coming from a heat source of a thousand degrees or more, will penetrate his body and help to compensate for body heat losses. But, as we know, radiant heat passes through the air without warming it. Since the air is not heated, the floors, walls, and fixtures remain cold. Our typical man, therefore, continues to lose heat—by direct radiation into the floors, walls, and fixtures, and by conduction into the chilly air in contact with his body.

An electric radiant-convection heater? This is the most practical means of providing comfort in the bathroom. It supplies both radiant and convection heat in a balanced relationship. At the flip of a switch it produces an instantaneous, cheerful glow which laves the body with gentle but penetrating radiant heat—heat that abounds in healthful infra-red rays. Radiant heat is essential in cold bathrooms because, practically speaking, it is the only heat from an outside source that will actually warm the body.

At the same time this heater circulates an even flow of warmed air throughout the entire bathroom. This circulating heat surrounds the human body, checking heat losses by conduction; it warms the fixtures, floors, and walls, minimizing heat losses by radiation. Velocity of flow is 160 feet per minute, assuring virtually perfect heat distribution and complete absence of perceptible drafts—in short, maximum four-corner comfort!

Realizing its superiority to other systems, you would naturally expect the radiant-convection heater to be proportionately costly. All factors considered, however, it is the least expensive of all types. Installation usually costs less than a furnace duct or steam pipe; and, because it operates independently of the main heating system, it provides **more bathroom comfort per dollar** than any other means of heating!

Not only are these radiant-convection heaters unrivalled in their primary function of providing maximum bathroom comfort at minimum cost, but they also lead the field in safety, durability, and appearance. Safety is assured by the approval of the Fire Underwriters' Laboratories; durability by the five-year guarantee against burnout; and the standard chromium finish and modern styling enhance the beauty of the finest bathrooms. All exposed parts are non-corrosive—the heaters cannot be damaged by water or steam. In fact, these heaters are so well constructed that the first ones, built 20 years ago, are still in operation!

They are also obtainable with vitreous enamel grilles, in various colors, to harmonize with colored fixtures or tile; and one model contains a built-in thermostat which will automatically maintain a constant temperature in the bathroom.

The convenience of these electric radiant-convection heaters cannot be measured in dollars. As easy to turn on as an electric light, they bring quick warmth for the morning shave, for an impromptu shower, for bathing children, for sickness—any time of the day or night, regardless of weather conditions.

BUILDING CODES AN AID TO FIRE PREVENTION

By Geo. W. Booth

THE INTENT of all fire prevention activities and the object of maintaining fire departments are to reduce the enormous annual destruction of wealth and to prevent the maiming and death of the people of this country. A comprehensive study of conditions in any community, or for the country as a whole, will clearly show that the destruction of an automobile factory, an explosion and fire in a flour mill, the burning of a hotel, a conflagration of several blocks of stores or dwellings, have individually produced losses which have exceeded the total of all other fires occurring in the community.

Values are a decided factor in losses. With an increase in values, and consequent greater probability of serious losses, the problem becomes one which not only affects the individual property owner but also is of importance to the community. Where it involves possibilities of a conflagration, national interests are at stake. It is also a fact that with the conditions which go with high values there is a corresponding increase in life hazard, for with high values building heights increase, congestion becomes more general and manufacturing processes depart from simple forms, and hazards of many kinds are introduced.

Losses are of three general characters: destruction of the building, damage to the contents, and injury to the occupants.

It is not possible to erect structures which are not susceptible to some damage by fire. Modern building construction has evolved resistive buildings as we know them today, but experience in the conflagration in Baltimore and in many individual building fires has been that even these buildings can sustain losses over 50 per cent of their value, and severe damage to contents and loss of life also take place.

To reduce or minimize these serious losses and injuries, which statistics show are occasioned by less than 1 per cent of the fires, those who are interested in fire prevention must an-

alyze the factors which contributed to or caused them.

A general study of building fires shows several outstanding factors which not only in themselves increase the probability of losses because of the inherent conditions, but also prevent effective fire fighting. These features of building construction are excessive areas, open stairways, thin walls, improper ventilation systems, interior courts, unprotected windows, inaccessible basements and sub-basements, lack of fire doors, steelwork without insulation, weak floors and structural members which will not withstand sustained fire without failure, and the presence of various inaccessible places in which fire can extend vertically and horizontally without discovery.

Correction of these principal factors responsible for fire losses and injury is the object to be aimed at by building codes. It is for that reason that every community should enact and enforce such a code. The argument sometimes advanced that the adoption of a building code increases cost of construction cannot be denied. It is one of the axioms applying to all forms of safety that the lessening of any hazard costs money or effort or both. As against this is the fact that few people object to this cost when the value of the results obtained are fully realized.

Each day examples arise in which some cheapening of construction has caused the loss of a life or the destruction of property values which may influence the economic well-being of an entire community. The recent death of nine firemen in Syracuse, New York, due to the collapse of a fire-damaged building, constructed sixty years ago before the enactment of a suitable building code, is an example of what too often happens. Old law tenements, so called because of their erection before suitable restrictions had been enacted, are frequent causes of injury and loss in many cities.

One of the principal reasons fire-safe build-

(Turn to Page 49)

INDUSTRIAL RESEARCH FOR ARCHITECT AND ENGINEER

By J. E. Holbrook

FOR five thousand years and more, the factor which has placed the most severe limitation upon those who designed and erected homes, buildings, monuments and other structures has been that of materials.

The earliest of these were wood, stone and mud. For countless centuries after man learned to join with his fellows in the establishment of communities, he was limited by such materials to the construction of the simplest of single-story edifices. What pride of accomplishment he must have felt when, after weary years of experimentation, he learned to cut stone into square blocks and to combine straw with earth to make bricks. How marvelous to him must have seemed the pyramids in Egypt's Valley of the Kings, and the multilevel zikkurats from which the Assyrians worshipped their gods, built with these new structural materials.

Long, indeed, has been the road which architects and engineers have traveled since those early days when the first discoveries were made in structural substances. To bricks and stone were added, with the passing years, such other commodities as metals, cements and mortars, lumber and paint. With the aid of these, the building profession was enabled to expand and to diversify its functions. Styles of architecture were developed, entirely new kinds of structures were invented, comfort and efficiency were multiplied many-fold.

This progress in building was due in large part to what in truth was early industrial research. For the most part, however, all such evolution was of a relatively simple sort, marked by the adaptation of known substances to the needs of home building and industry.

The true era of industrial research did not have its beginning until half a century ago. In fact, within the last two decades more contributions have been made to the science of architecture than in the entire period of civilization which preceded it. For it is only in very recent time that chemistry and metallurgy have come

to play a full part in the building industry.

One important phase of research has been the improvement of existing materials. Chemistry has been applied to lumber, to remove pitches and resins, to protect against decay, insect infestation and even fire. Faster-setting cements and sturdier mortars have been developed. Bricks have been improved, and to this elemental ceramic material have been added a wide variety of terra cotta and tile.

Even more significant has been the work done in laboratories to make new types of substances, capable of successful application where the older materials could not be used in many cases.

History of The Paraffine Companies, Inc., affords a typical illustration of the contributions made by chemical studies to architecture and engineering. The company had its beginning in the work of two men—Truman J. Pearce, a Santa Barbara chemist, and Melvin W. Beardsley, an oil driller and refiner. By dissolving the pitch-like asphalt obtained from California petroleum in carbon bisulphide, used until that time primarily as an asphyxiant for gophers and squirrels, they developed the earliest product of the firm—a substance which made excellent paint and roofing material.

An asphalt refinery and felt mill were built to exploit the discovery of Pearce and Beardsley. Research continued, however, and to the original products have been added other paints, varnishes and lacquers, a variety of roof coverings, linoleum and other flooring products.

Similarly, other firms made important contributions as a result of industrial research, so that in fifty years entire new fields have been opened to the building profession.

These tremendous achievements have served in large measure to strike from the construction industries the chains with which they were bound for so many centuries. Today materials no longer tend to limit the architect and engineer. On the contrary, they offer him endless opportunities for artistic expression, for

Editor's Note:—The author is Assistant General Sales Manager of The Paraffine Companies, Incorporated.

industrial achievement, for creation of human comfort and happiness.

But no firm can hope to happen upon all of the opportunities which are available for industrial research in architecture and engineering. The best sources for suggestions along such lines are the architects and engineers themselves, the men who must do the actual work of planning and erecting the nation's buildings. More and more, scientific study must come to be directed by those who will make practical use of its discoveries.

To facilitate this practice in our own firm, Industrial Research Laboratories has been set up recently as a division to work directly with the building industries on problems suggested entirely by architects, engineers and others engaged in the building and related industries. Research will cover the application of products already available, and also the development of new materials to meet specific requirements—such as resistance to corrosion, abrasion, heat, moisture, solvents, flexing or the weather.

Thus industrial research moves forward today, directed not only by companies with products to sell, but also by those who must purchase such materials for building operations, or must utilize them in planning and designing. Architects and engineers of the future will have even greater opportunities than those of today.

INSTITUTE GETS BEHIND HOME BUILDING PLAN

"REGISTERED" homes costing less than \$5,000 are the objective of a joint program of the American Institute of Architects and the Producers' Council, national organization of manufacturers of building materials and equipment, in cooperation with the Federal Home Loan Bank Board.

More than 400 home designs have already been contributed by 230 leading residential architects for the Federal Home Building Service Plan, which will now be expanded into a joint "Home Building Service," according to N. Max Dunning, chairman of an executive committee acting on behalf of the Institute and the Council.

These and many additional designs will be exchanged between one section of the country and another. Technical aid formerly restricted to those of ample means will be made available to everyone involved in the planning and supervising of small home construction, including operative builders, local construction groups, and national trade associations.

Besides the final certificate of registration, identifying the house as soundly built, the service provides for financing counsel; the most favorable financing consistent with security; competent architectural design suited to the needs of the family, site, and neighborhood; a qualified builder; specification of proper materials, and supervision of construction.

In an effort to put the program into effect in all parts of the country as soon as possible, conferences are being arranged with home financing institutions, architects, technicians, contractors, materials manufacturers, dealers, and other elements of the housing industry. Qualified architects and technicians will participate regardless of society affiliation.

"The Home Building Service, although national in scope, will function principally through local programs," Mr. Dunning explains. "It is essentially one of private enterprise, utilizing existing organizations. The result of the Service, it is believed, will be a renewed confidence in home ownership, added stability for mortgage values, and, consequently, a revival of building. The certificate of registration on a home will increase its security as an investment and its value for resale or rental purposes.

"The present Federal Home Building Service Plan, already in operation in a number of communities through the member lending institutions of the Bank System, is being broadened to embrace all home-financing institutions, including commercial banks, and will cooperate with every agency working toward sound, economically planned small homes."

The executive committee, in addition to Mr. Dunning, consists of Russell G. Creviston of Chicago, president of the Producers' Council; William Stanley Parker of Boston, president of the Construction League of America, and Donald H. McNeal.



MERCATOR EXAGGERATION

CORRECT LAND FORM

MOLLWEIDE DISTORTION

PROGRESS OF THE BUTTERFLY MAP—THE THREE VARIANTS

By B. J. S. Cahill

IN *The Architect and Engineer* of September, 1924, was an illustrated account of "A Ground Plan of the Earth," or "The Butterfly Map of the World."

Little did the author dream at that time of the immense road he had to travel and the vast amount of work that needed to be done before he could say "finis" to his map. Only last year was it academically completed and its future as a commercial factor new seems assured.

It is a long story but a brief resume may interest architects because its progress from sketch form to complete details after many try-outs and innumerable erasures, is absolutely typical of our profession's procedure. And it is the only procedure that could possibly produce success, because, while experts, such as structural engineers, electricians, and air-conditioners, must exercise their special knowledge as "details" of any structure, they will fail dismally if they attempt, as a joint committee, to design a successful building.

Mathematicians and geodesists, when on occasion they try their hand at devising a world map, begin with detail and end, of course, in disaster! Any draughtsman who, with a hard

pencil, begins to design a house by drawing in the entrance and then adding the rooms exactly as they should be and expect to finish his plan satisfactorily, is foredoomed to failure.

This, perhaps, is the most interesting thing we can say of the Butterfly Map: that it was designed as an architect designs, from the "general" to the "particular."

The next important discovery was that it takes several kinds of "nets" (that is the grid of parallels and meridians) to express certain attributes of the surface of a globe which cannot co-exist on the same diagram. In other words, within the same outlines we must have several "floors" to contain all that is needed. These, on the map, I call Variants. Instead of one map, a maid-of-all-work map as it were, we must have three maps. If the net lines were removed all three would look quite similar on casual inspection, but fundamentally they are all quite different as briefly indicated in the following summary:

(1) The Orthomorphic Variant slowly increases in scale from the center of each octant, but all the lines cross each other at right angles. Thus all compass "roses" are valid on the map

and therefore it is suitable for weather maps on which the direction of the wind is important.

(2) The Orthomeric Variant shows correct scale areas, although true compass directions are somewhat warped or distorted. This Variant is best suited for general purposes of geog-

raphy, especially in economic surveys of products and distribution. But, whereas a globe is continued by the mechanical act of revolving it, on the Variants of the Butterfly Map, this continuity is achieved by replacement of the parts. This principle is used on the International Millionth Map where any one of two thousand odd sheets

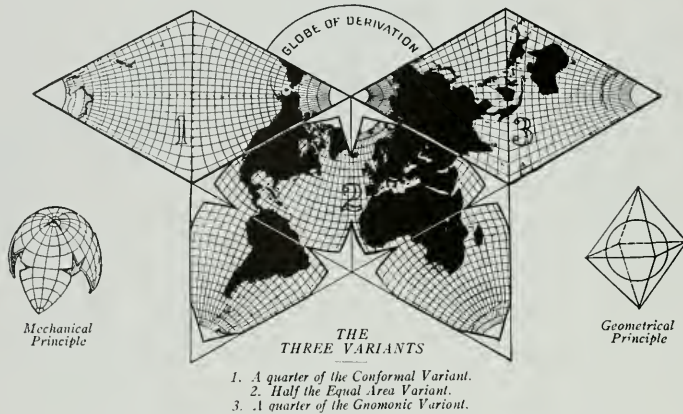

The Butterfly Map—Octahedral System of Projection. B. J. S. Cahill, 1890-1934

raphy, especially in economic surveys of products and distribution.

(3) The Orthodromic Variant shows on each octant the shortest route between any two points and all points in between by drawing a straight line from one to the other. This Variant is useful in amphibious navigation and problems of geophysics. All these attributes are perfectly displayed on a globe but cannot co-exist, as we said, on one diagram.

But there is another attribute peculiar to a globe: It has no boundaries. It is a continuum in all directions as you can find out by revolving it. Now this attribute has been strangely overlooked by most of the world's cartographers. Any world map that is bounded by a curved line (and many are so bounded), is what may be called a "static" world map; incapable of showing moving objects such as storms or travel routes when these reach the edge of the map. It is true that Mercator's chart (it is not a map) can be extended East and West and other world maps can be extended in four directions.

The Butterfly Map has straight lines at all its edges and in some of its Variants can be extended in twelve directions and in no case less

which map the whole world, can be extended without a break by adding two sheets to each side and two to top and bottom as well as four more at the corners, eight sheets added to the central one. Thus more than 9 sheets of the Millionth Map can be assembled in a plane surface. Of course, all the sheets can be fitted together perfectly on the surface of a huge globe 42 feet in diameter.

Finally all the Variants of the Butterfly Map can be built up into geometrical solids, regular octahedrons or tetrahedrons both positive and negative. Certain types of the Orthomeric Variant can be built up into 14-sided polyhedrons of quasi-globular or pseudo-spherical form. A very close approximation to an actual globe, without, however, having any curved surfaces.

While "The Butterfly Map" is the more generic name, since the development of the three variants, the correct title is "The Octahedral System of Projection." All three Variants have been mathematically computed with calculated tables of coordinates. An account of this three-part system, the only one ever attempted in the history of Cartography, has been published in six languages and is known to projectionists all

over the world. Since it was academically completed only last year, its commercialization is as yet in its infancy, but very important developments are expected in the near future. Indeed, the Miroir du Monde of Paris described it as "La Mappemonde de l'Avenir," the world Map of the Future.

NOTED WRITER DESCRIBES MAP

Bruno Lessing, feature writer for the Examiner, writes that since seeing the map he has had an uncontrollable desire to travel. He describes the map as one of the most fascinating things he has ever seen. He writes: "It is a scientific and original idea, and Mr. Cahill's own. He must have designed it years ago because Robert Dollar congratulated him upon 'the excellent indorsements you have received from such a number of prominent men.' It just happens that I never knew of it before.

"Mr. Cahill presents a map of the earth on a flat sheet of paper. About 400 years ago Gerhard Kremer, a Dutch geographer who had assumed the name of 'Mercator,' attempted the same thing. 'Mercator's Projection' has become a classic among all who are interested in geography. And yet every student knows that it is wrong and misleading.

"The problem is the simplest thing in the world to explain and yet, an impossible one to solve. All you've got to do is to take the skin of an orange and lay it down flat on a table so as to show the whole surface.

"I have a suspicion that Mr. Cahill cut up thousands of oranges before he hit upon his ingenious solution. His map is the shape of a butterfly. He has divided the surface of the globe into eight segments. Of course, it is not an accurate map because no flat map can show accurately the distances and the measurements on a sphere. But it is vastly more accurate than that of 'Mercator.'

"On the old map Venezuela's area is about one-third the size of Sweden and Norway. The Butterfly Map shows that Venezuela is bigger than both those countries combined.

"I am looking at this map. I wanna go to Australia. Aside from its coastline it is a mysterious country. There are aborigines who go

hunting with a boomerang and take their wives along to look after the baggage. I'd like to investigate that system. And I love kangaroos.

"I wanna go to Thibet. I'd like to teach the Grand Lama (I hope I have his title right) how to play pinochle and have him tell me about the mysteries of life. I wanna go to the South Seas and roam around with dusky maidens who will put flowers in my hair (if they find enough hair) and who sing by moonlight while the white surf accompanies them with a gentle threnody.

"I wanna roam over all the wings of this butterfly because the map is so darn alluring. It keeps singing to me: 'Why stay when you can move? I offer you the globe on which you live. Brush off your wings and fly.'"

ARCHITECTS AND BUILDING INDUSTRY

(Concluded from page 36)

confusion, we have learned from our highly organized governments the value of concentrating our forces into a centralized group to obtain our objectives. We all realize that our security has precedence over our culture and professional attitude, but inasmuch as the sciences are the fundamental principles of the construction industry, they should guide us accordingly. It is with these fundamental facts in mind, along with our ability to organize and cooperate, that slowly but surely we will be unified into a strong industry of lasting value and importance.

BUILDING CODES

(Concluded from Page 44)

ing construction is not commonly obtained—and any student of conditions in American cities will recognize that this is the case—is that design and construction follow practices handed down from one generation to another.

To overcome this practice, a definite educational campaign is necessary. To properly cover all of these features the National Board of Fire Underwriters maintains consulting service on matters pertaining to all phases of building construction. In addition model Building Codes have been prepared, one of which is suitable for villages and small towns, and the other for municipalities.



Statue of "Erda" the Earth Mother, mentioned by Wagner in the Ring. It was designed by Jason Herron for a pool containing zoological specimens for the Senior High School of South Pasadena, California. The statue is of a semi-glazed terra cotta, the incisions of the carving being a turquoise blue, with the finish surface a light shade of pink. The pool is lined with tiles of the same turquoise blue.

The mural pictured below is oil on canvas, executed by Lorser Feitelson. The scene is an interior, bare of furnishings except a table, with the czar handing a charter to Nicolai Petrovich de Rezanov for the purpose of forming a trading and holding company to exploit the lands of the Pacific north and east of Japan. Among his exploits was obtaining a trade treaty with the Spanish governor of California.



PAUL I, CZAR OF RUSSIA, GRANTING THE CHARTER TO REZANOV—1799.
ONE OF TEN MURALS IN THE BOARD OF SUPERVISORS HEARING ROOM,
HALL OF RECORDS, LOS ANGELES.



MODEL EXHIBITED BY CALIFORNIA DIVISION OF HIGHWAYS,
GOLDEN GATE INTERNATIONAL EXPOSITION, TREASURE ISLAND

Courtesy California Highways

MODELS SHOW 25 YEARS OF HIGHWAY PROGRESS

"A QUARTER Century of Highway Progress" is the theme of an interesting exhibit by the California Division of Highways at the Golden Gate International Exposition.

Located in the eastern wing of the California Building is a highway diorama forty-four feet in length and five feet in width, constructed accurately to scale, which graphically portrays the tremendous growth and change which has taken place in highway facilities since the inception of the present State system of roads just a little over a quarter of a century ago.

Beginning with a section which depicts the general type and condition of roads in 1912, with their narrow, rutted soil surfaces—dusty in summer and muddy in winter—the model strives to show in a natural sequence of scenes the progress of highway betterment in 25 years.

For instance, the first soil road, winding and indirect in its alignment, terminates in a pave-

ment, fifteen feet in width, representing the first effort to supply hard-surfaced, all-weather roads. As the mileage of this type of improvement grew, the ownership of an automobile, even of the vintage of 1913 and 1914, became a pleasure instead of a trying adventure.

The adjacent section, therefore, shows the next forward step in highway construction brought by the growth of traffic—the increasing of pavement widths from fifteen feet to twenty feet, as well as the improvement of many of the earlier roads to better standards of alignment.

The three-lane pavements and undivided four-lane pavements, which are still so largely a part of our present highway development, are next depicted and the final scene represents a section of ultra-modern divided "express" highway, with its wide separation strip, its

(Turn to Page 59)

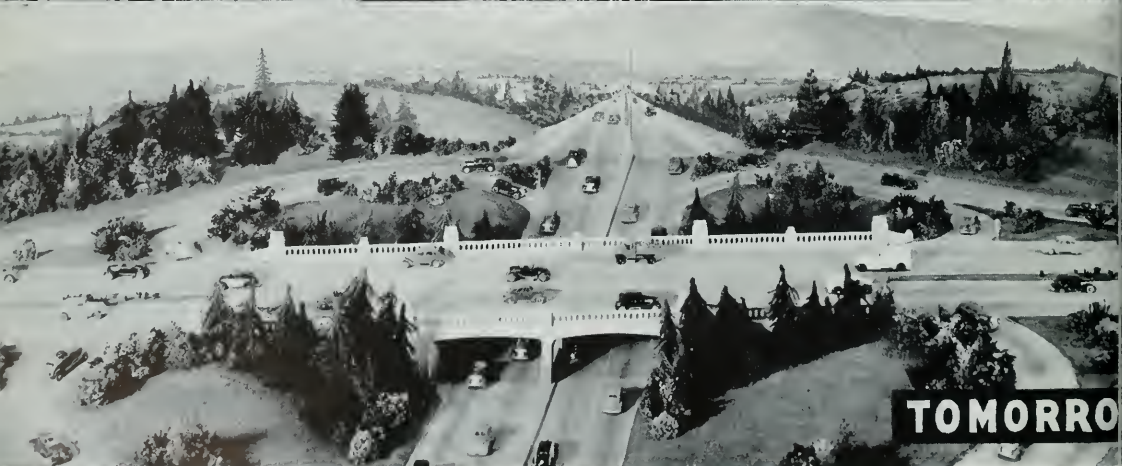

With the Architects

CHAS. F. PLUMMER, ARCHITECT

Charles F. Plummer, architect of Los Angeles, was stricken with a cerebral hemorrhage while driving his car on Wilshire Boulevard April 12. He was taken to a receiving hospital and later removed to the Queen of the Angels Hospital, where he died without regaining consciousness.

Mr. Plummer was born in Arkansas, Wisconsin, and as a youth came west, living for a time at Seattle. In 1913 he moved to Los Angeles. Although his practice was of a general nature he specialized in commercial work and was widely known as architect of the numerous Boos Bros. cafeterias which reflected many new ideas in cafe planning. He also designed many store improvements. Other work included the Del Mar Club, Young's market building at Seventh and Union, the Hoffman candy factory and other industrial buildings.

PERSONAL

Herman Charles Light, formerly at 656 So. Ridgley Drive, Los Angeles, announces the removal of his office to 120 $\frac{1}{2}$ So. Sweetzer Avenue, Los Angeles.

Hyman Rosenthal, for the past three years with the Exposition drafting department, has opened an office at 255 California Street, San Francisco, for the practice of his profession.

Henry Bertelsen, Spokane architect, has moved his office from the Arthur D. Jones Building to the Empire State Building.

James M. Taylor, Jr., of Seattle has moved his office from the Arcade Building to the Textile Tower.

Messrs. **M. L. Barker** and **G. Lawrence Ott**, 624 South La Brea Avenue, Los Angeles, announce the opening of a branch office in San Diego, Room 404, San Diego Trust Building. The architects' representative in charge of the office is M. F. Jackson.

Lawrence C. Test of Pasadena, was awarded a prize of \$100 for his design of a low cost suburban garden home submitted in the Productive Home Architectural Competition, nationally conducted.

J. Robert Harris has opened an office at 6671 Sunset Boulevard, Hollywood.

John J. Donovan, A. I. A., and former president of the State Assn. of California Architects, will give a course of twelve seminars at the summer session of the University of California, Berkeley, commencing in July. Mr. Donovan's subject will be "Problems in School Housing."

TREASURE ISLAND TRIP

The Producers' Council Club of Northern California held its monthly meeting Monday, May 1st, at the Engineers' Club, San Francisco. Chief object of dis-

cussion was trips to Treasure Island at which architects of the Bay region will be guests of the Council. The Producers' Council is an organization of manufacturers who have nation-wide distribution. It is affiliated with the American Institute of Architects. The local officers are: President, F. K. Pinney; Vice-President, Thomas Rolph; Secretary-Treasurer, R. H. Brown.

U. S. LABORATORY BUILDING

Bids will be received up to the 26th of this month for construction of a Western Regional Laboratory, U. S. Department of Agriculture, at Albany, Alameda County, California. There will be two units—the Laboratory Building and the Service Building, both of monolithic concrete and masonry construction. An appropriation of \$1,000,000 is available for buildings and equipment.

WAREHOUSE AND OFFICE BUILDING

W. D. Peugh, architect, 333 Montgomery Street, San Francisco, has completed plans and a contract has been let, for a one and two story reinforced concrete warehouse and office building for the Boyer Company. The \$50,000 building will be located on the west side of Second Street, between King and Berry Streets, San Francisco. Cahill Bros., 206 Sansome Street, San Francisco, are the contractors.

FEDERAL HOUSING PROJECT

Working drawings are practically completed by Miller & Warnecke, John J. Donovan, Hugh C. White, F. H. Reimers and H. A. Minton, drafting rooms, Ray Building, Oakland, for the proposed \$2,500,000 Federal Housing Project in West Oakland. The work, involving construction of a group of low rental apartment buildings, is the first of the kind to go forward in Northern California. Bids will be advertised shortly.

NATIVE SONS CLUB HOUSE

Twin Peaks Parlor, Native Sons, will build a club house at 24th and Diamond Streets, San Francisco, from plans by Vincent Buckley, 525 Market Street, San Francisco. The building will be one story and will contain club rooms, small hall with maple floor, and quarters for banquet gatherings. The improvement will cost \$15,000.

OLYMPIC CLUB ALTERATIONS

More modernization work is to be done to the Olympic Club Building, 524 Post Street, San Francisco, from plans by Douglas D. Stone, 381 Bush Street, San Francisco. New bathrooms will be included in the improvements, the estimated cost of which is \$25,000.

NORTHERN CALIFORNIA CHAPTER, A.I.A.

A joint meeting of the Chapter and the State Association of California Architects was held at the Alexander-Hamilton Hotel, San Francisco, April 18, President James H. Mitchell presiding. This meeting was called to honor Leigh Hunt, member of the Board of Directors of the American Institute of Architects and President of the Wisconsin Society of Architects.

The following members were present: Messrs. Harris C. Allen, G. Frederick Ashley, Henry C. Collins, Mark T. Daniels, Albert J. Evers, Wayne S. Hertzka, Ellsworth E. Johnson, Thomas J. Kent, Wm. Gladstone Merchant, Frederick H. Meyer, Chester H. Miller, James H. Mitchell, Howard Moise, Irving F. Morrow, Gwynn Officer, Warren C. Perry, Dodge A. Riedy, Paul A. Ryan, Roland I. Stringham, Ernest E. Weihe, W. Raymond Yelland, John Davis Young.

Guests: Leigh Hunt, speaker of the evening; Donald Cameron, R.I.B.A., of Glasgow, Scotland, architect of the Scotch Village at the Golden Gate International Exposition; Paul Duncan, A.I.A., of Los Angeles, and Miss Elisabeth Boyter, representing the California Society of Architectural Draftsmen.

Announcement was made of the plans laid to celebrate "Architects' Day" at the Exposition, October 11, following the International Congress of Architects and Institute Convention in Washington, D. C.

Frederick H. Meyer reported that the proposed Architectural Practice Act was in the Senate Committee for re-hearing and possible revision and that the committee was to report on it again in about two weeks.

Announcement was made of a dinner to be held April 19, under the auspices of the San Francisco Housing Association, to honor Sir Raymond Unwin, former President of the R.I.B.A., and former President of the Town Planning Association of Great Britain.

Mr. Mitchell then introduced the guest of honor, Leigh Hunt, who presented a very interesting and educational picture of the relations between the various State Architectural Associations and the American Institute of Architects.

Following the talk Mr. Hunt answered questions from the floor and described methods of employment and practice in the East.

The Chapter expressed its appreciation to Mr. Hunt for his work and efforts in behalf of unity within the profession—J. D. Y.

IT'S PACIFIC COAST AGGREGATES NOW

The shareholders of the Golden Gate Atlas Materials Company have voted to wind up and dissolve the affairs of that company and all future business will be conducted under the name of Pacific Coast Aggregates, Inc., of which the Golden Gate Atlas Materials Company was its almost wholly owned subsidiary. The offices will be at 85 Second Street, while the main plant will be at 16th and Harrison Streets, San Francisco, as heretofore.

STRUCTURAL ENGINEERS ASSOCIATION NOTES

At the May 2 meeting, members of the Northern Section, Structural Engineers of California, were treated to a performance of the famous Dancing Girls of Bali. Several items of interest to members were down on the program and the new State Constitution and Uniform Code were discussed.

The welfare committee has been asked to consider changes in the by-laws.

There are four applications now pending for membership. This indicates activity on the part of the membership committee and others interested in the welfare of the Association.

The program committee is looking for suggestions and expressions of opinion on the type of midsummer picnic for this year. Now, and not after a decision is made, is the time for these expressions; also, now is the time to begin to think about the annual meeting. It will be held this year somewhere within the environs of San Francisco.

As an indication of the interest of the Structural Engineers of Northern and Southern California in the activities of the Pacific Coast Building Officials Conference, a total of eleven members from the two associations attended the meeting of the Code Changes Committee of the Conference at Fresno April 22.

Professor Jacobsen of the Association is taking an active part in the Earthquake Research Program being sponsored by the Los Angeles County Board of Supervisors.

Requests have been made for an excursion at the time of the summer meeting of the American Society of Civil Engineers for the Structural Division. It has been suggested that this excursion take in the two large bridges as well as a trip up the Oakland Estuary where much construction is either in progress or contemplated.

Possibility of an excursion of the Structural Engineers Association to Treasure Island is also being considered by the program committee.

S. F. SECTION—AM. SOC. C. E.

San Francisco Section, American Society of Civil Engineers, held its regular by-monthly meeting at the Engineers' Club Tuesday evening, April 18, with a large attendance. The technical program which followed dinner was of exceptional interest, being an illustrated talk by Captain F. B. Butler, Corps of Engineers, on "Engineering Features in the Construction of a Modern Seacoast Battery."

At the February meeting the speaker was Chas. M. Upham. His subject: "German Super Highways."

At this meeting L. H. Nishkin reported that since this was a legislation year the committee was busy. One meeting had been held in Sacramento. Five groups have joined together—Los Angeles, Sacramento and San Francisco Sections of the Am. Soc. C. E., and the Northern and the Southern Associations of Structural Engineers.

Report of Test for New Shower Stalls in Girls' Gymnasium, Vallejo

TO solve constantly recurring problems of construction in school and club shower rooms, reinforcement of glazed wall units was developed recently by Krafftile Company at its Niles, California, plant and put through severe tests for structure and seismic resistance.

For the purpose of testing, two standard walls were constructed at the Krafftile plant in accordance with the plans and specifications for the gymnasium showers in the Vallejo High School. The shower units were constructed with the collaboration of John J. Donovan,

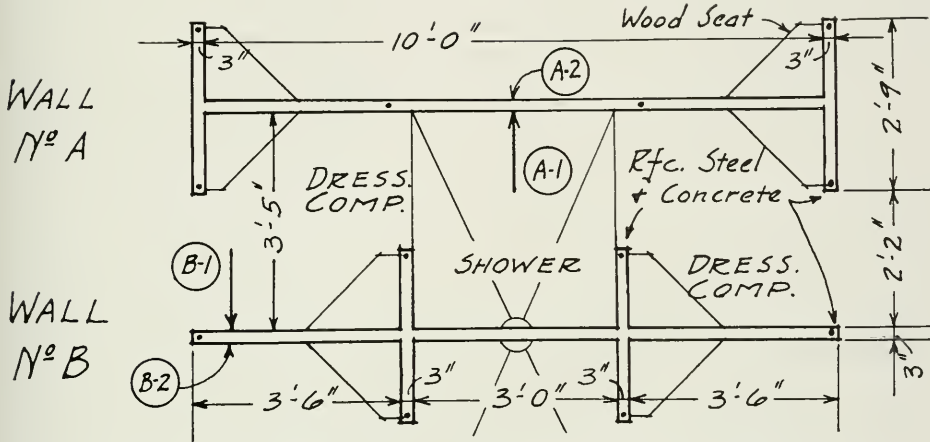

Plan of unit, consisting of shower and dressing compartments, tested for structure and seismic resistance at Krafftile plant, Niles. Point of test in Wall A is indicated by circled "A-1" and in Wall B by circled "B-1." Units were designed for Girls' Gymnasium in Vallejo High School by John J. Donovan, Architect, as developed at Krafftile plant, structure is of terra cotta wall units reinforced into a monolith.

The extent of the tests, duly witnessed, was a load ten times the requirements of the State Engineer's office for minimum strength in school construction in California, equal to over 100 per cent gravity. The walls remained secure to the floor without a sign of failure.

The arrangement for the units called for partitions 5 feet 2 inches in height. Each stall shower serves two dressing compartments suitable for a total of 4 persons. In the job for which Reinforced Krafftile construction was developed, there will be three banks of such units in multiples of twelve, a total of thirty-six units.

In order to meet the problems of rust, deterioration, staining, warping, and short life, as well as to attain attractive permanent coloring and a surface easy to keep clean, glazed wall units were specified. To attain the strength of structure exacted for school construction, especially for seismic resistance, the terra cotta wall units were reinforced into practically a monolithic structure.

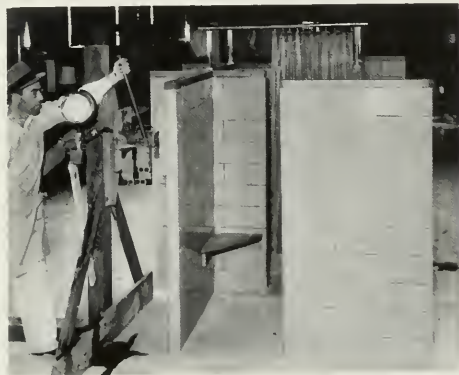

Snapshot of test for structure and seismic resistance of partitions for school shower and dressing compartments. Krafftile Terra Cotta Wall Units, reinforced by steel bars and concrete, resulted in a practical monolith.

architect of the school, and his chief draftsman, Oscar M. Price.

The partitions were reinforced vertically and anchored to the floor by means of steel rods. Tying these vertical rods together, expanded metal strips were laid horizontally in about every third course. All reinforcement is entirely concealed as erected.

At each wall termination (and at other points as marked in the accompanying illustration), the steel rod was introduced into the vertical shaft formed by the cells in the glazed wall units. Around the rod was poured concrete to fill the entire shaft. Thus, there is in effect a built-in column which is an integral part of the wall. Anchor dowells in the concrete flooring project into each of these columns, securing column and wall to the floor.

In the partitions built for these tests, doors and miscellaneous hardware were not installed. Two weeks time was allowed for mortar curing. Test samples were made of setting and grouting mortar.

Under the supervision of the Hersey Testing Laboratory, pressure was applied in the two separate tests, as marked A-1 and B-1 in the accompanying illustration. Pressure was applied horizontally and in each

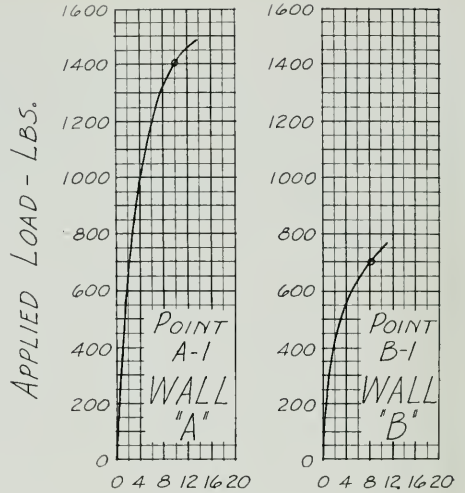

DEFLECTION
by $\frac{1}{64}$ inches
Gauge readings on tests



Shower and dressing compartment partitions for Girls' High School Gymnasium, Vallejo, California, as constructed at Kraftite Company plant for tests of structure and seismic resistance. Three-cornered wooden seat in one of the dressing compartments is in Wall B, as tested. At right, is Wall A, as designated in sketch. Hardware for doors, at each end of unit, and plumbing, including shower head, were omitted in test set-up.

test at a point 4 feet 2 inches from the floor, the walls being 5 feet 2 inches in height.

Deflection was measured on the opposite side of the wall. Pressure gauge readings, converted into total pounds pressure, indicate the actual applied load, as charted on graphs herewith.

Although additional pressure was applied without loosening individual tiles and with the walls remaining sound and secure to the floor, 1410 pounds at point A-1 and 689 pounds at point B-1 were determined as probably ultimate for concentrated loads at these specific points.

The ultimate strength indicated is several times more than the requirements of Appendix A of the California State Building Code.

NOW IT'S STREAMLINED WINDOWS

Streamlined windows are one of the latest innovations in construction, according to a research bulletin edited by the Structural Service Department of The American Institute of Architects from data provided by the Producers' Council. Other new appliances include concave washing bowls that permit the user to stand close enough to prevent splashing, and architectural glass that can be moulded into sculptured panels or simple light fixtures.

Windows may now have flat sliding bolts fastened on steel casements, which, placed inconspicuously on the bottom of the window instead of in the middle of the frame, do not interfere with flat screens, blinds and shades. The new bolt permits full width screens for more than one vent, and provides extra convenience and economy on all sash installations.

"The smooth, streamlined surface of the window made possible by the fastener is extremely useful where stool lines are high and sash installations are above normal reach, such as over sinks," the report says. "Furthermore, the lock requires no special detailing, no fitting on the job, and no added cost above standard equipment."

Another new development in window design is the growing use of watertight, aluminum sills. "The weight of an average width aluminum sill is approximately one pound per foot of length," it is explained. "Thus, it is easy for one man to handle sills of any length which a job might require. Aluminum cannot rust, so these sills never need painting and the evenness with which they weather keeps them always attractive looking. Their price is generally lower than sills of other suitable permanent materials offered to the building industry.

"Since aluminum sill sections are thin and do not exceed the width of masonry joints, the body of the sill may be extended at either end into the masonry to provide an extremely weather-proof joint. If it is not possible to embed the sill in the masonry, the sill may be cut to the window width and calked at the jamb to obtain a proper joint.

"Aluminum sills can be selected to fit almost any construction condition. Because they come in long

lengths they may be cut to fit from jamb to jamb, thus eliminating troublesome intermediate joints. Again maximum weather-tightness is attained. Also, since but few joints are necessary, installation time is reduced and erection cost lowered. The sills may be made to fit around obstructions, such as posts or mullions, by simply cutting notches or mitering as required, with a hacksaw."

A new model vitreous china cabinet lavatory, which, because of a concave front, makes possible a closer approach for washing, has been designed. "The basin is rectangular with a handy low shelf back, and the supply controls, mounted on an angle instead of horizontally, are out of the way," the Bulletin states. "The cabinet is of all-steel welded construction with durable baked enamel finish. Two large compartments and three shelves in each door give ample storage space while the cabinet base is recessed to give toe room.

"The new lavatories have spacious basins, greater handy shelf areas, out-of-the-way fittings, mixer faucets, and compact controls that operate with finger-flick ease."

Architectural glass may now be produced by a new process which has substantially lowered its cost and has made it available for far wider use by architects and designers than ever before, it is pointed out. "Specially cast shapes of the glass may now be used with success for such purposes as strip illumination, illuminated bulkheads, friezes, spandrels, door and fireplace trim, band courses, decorative inserts, pilasters, interior screens, and partitions.

"Its possibilities in modern building construction and decoration are largely unexplored, but that they are almost limitless is indicated by the striking achievements already accomplished by its use. The glass can now be specially cast in sculptured panels for decorative purposes. This revolutionary development has turned the architect's and designer's desire for true sculptural treatment of glass into an actuality. In working with this medium in bas relief, shadows and highlights have new values, entirely different from those to be expected when working with opaque materials.

"A vital part of the beauty of a finished panel of the new glass is the sparkle and life imparted to it by the constant change and filtration of light through its various thicknesses. Pieces as large as four feet square may be used to reproduce a single design, or larger panels may be made up from a number of sections four feet square or smaller. In working with the glass it is possible to achieve almost as many striking effects by change of glass texture as by change of contour.

"A slightly rougher texture where shadows are wanted will count for just as much as the actual variation in thickness. The back of the sculptured glass panel is usually left with the sand-fused finish, just as it comes from the casting operation. This gives a depth and translucence to the glass which it would not otherwise have, and also creates the impression of a much greater thickness than is actually the case."

ARCHITECTS INSPECT NEW STATION

The regular monthly meeting of Southern California Chapter, American Institute of Architects, was held at the Fred Harvey restaurant in Los Angeles Union Passenger Terminal, Tuesday, May 9.

Eugene Weston, Jr., who presided, introduced Donald B. Parkinson, consulting architect for the Union Terminal; Herman Sachs, color consultant; Tommy Tomson, landscape architect, and S. V. Meigs, assistant construction engineer on the project during erection and now general foreman of the Terminal.

Following dinner, Mr. Meigs, Mr. Parkinson and Mr. Tomson conducted a tour of the Terminal and explained the design of the building, planting of the grounds and the mechanics of the plant.

Mr. Parkinson explained that the design of the buildings was determined by local conditions and traditions and followed a thorough study of the problem by the architectural committee of the Terminal. He said the south court is the heart of the whole project, which is planned to impart to visitors the true atmosphere of California.

The June meeting of the Chapter will be held at the Mona Lisa restaurant in Los Angeles. In July the Chapter will meet jointly with the Producers' Council Club of Southern California.

PRODUCERS' COUNCIL-ARCHITECTS' DAY

On Wednesday, May 10th, the architects and engineers of the Bay region were guests of the Northern California Chapter of the Producers' Council at a luncheon meeting in the Oakwood Barbecue Restaurant on Treasure Island. Following introduction of guests and welcome remarks by F. K. Pinney, Armstrong Cork Co., President of the Producers' Council Chapter, the group visited several of the outstanding exhibits by member firms of the Council, including those of W. P. Fuller, Pittsburgh Plate Glass, Johns-Manville, Libbey-Owens-Ford Glass, Gladding-McBean, Crane Company, Soule Steele Co. and the Number One Home of the Exposition Model Homes Tour which is just being completed. The event was voted a real success and it was decided to hold a second similar meeting within a month's time.

ISLAND ARCHITECTURAL EXHIBIT

The splendid exhibit of the San Francisco Architectural Club in International Hall adjoining the Homes and Gardens Building, continues as a main point of interest to Fair visitors. The present display is Catholic church and school architecture. Visiting architects are requested to make the exhibit their headquarters while at the Exposition.

APRIL BUILDING PERMITS

Building permits for April in 25 leading Pacific Coast cities show a decrease of 10% from March, but a gain of some 22% over April, 1938, the figures being \$17,830,828 for 1938 and \$21,872,854 for 1939.

JOB FOR ELECTRICAL ENGINEER

Opportunity to conduct engineering studies and advise on problems of availability, production, and distribution of electric power in connection with the development of the Central Valley Project is offered in the position of Supervising Electric Utilities Engineer, Central Valley Project. An examination for this vacancy will be held June 15.

Applicants for the position, which pays \$420 a month, must have had education equivalent to that represented by graduation from college with major work in electrical engineering and five years of engineering experience in electric power utility management, valuation, or rate-fixing. Bulletins for the test and application forms can be obtained from the Los Angeles, San Francisco or Sacramento offices of the State Personnel Board. Applications should be filed by June 8.

BAN ON NEON SIGN

An important judgment has recently been given by Justice Boyce, who, in the Supreme Court, ordered that a Neon sign at Bayswater Road, Kings Cross, Sydney, should be turned off from 8:15 p.m. to sunrise.

An injunction had been filed against York Motors Pty. Ltd., owners of the sign, by two occupants of flats in Bayswater Road, who complained that the light from the sign illuminated their flats and was a source of annoyance and inconvenience.

This judgment may have an important bearing on other similar installations, comments a writer in "Buildings," published in Sydney, Australia.

BIDS FOR LOW-RENT HOUSING

First of the Low-Rent Housing Projects in Los Angeles county financed by the U. S. Housing Authority, are expected to be under way by next July. Bids have been asked for construction of the Carmelitos Project at Long Beach to be opened June 15 at 2 p. m. at the office of the Housing Authority of Los Angeles County, 1150 Western Pacific Building, Los Angeles.

As now planned, the project will comprise 86 buildings containing 607 dwelling units consisting of 3 1/2, 4 1/2 and 5 1/2 rooms each with 4 to 10 units in each building.

WINNERS OF L. A. COMPETITION

In the competition for design of a Founders' monument, sponsored by the State Association of California Architects, Southern Section, Architects Max Maltzman and Charles Light were awarded first prize of \$100. Second prize of \$50 was awarded to Harbin F. Hunter for his unusual rendering and Merrill W. Baird was given third prize of \$25.

Five honorable mentions were awarded to Architects L. H. Lippiatt, Harold Sexsmith, Francis Parsons, Parker Ben, and to W. L. Risley.

LIBRARY BUILDING

Working plans are under way in the office of Arnold Constable, 580 Market Street, San Francisco, for a

\$25,000 library for the Marin Junior College District, Kentfield, Marin County, California. The building will be frame and stucco with tile roof.

DISTRIBUTION OF CLAY

Despite the handicap of the general business recession, most domestic clay mines were fairly active in 1938. The output figures just released by the Bureau of Mines, however, make a poor showing in comparison with those for 1937 since that was a record year for several kinds of clay. Shipments of kaolin or china clay dropped 19%, ball clay sales 22%, and fire clay 48%—reflecting declines in consuming industries. A decline of 24% in the production of bleaching clay (fuller's earth), however, is attributed to increasing use of substitutes.

The heavy-clay-products industries—raw material for which is used chiefly locally and hence not included in Bureau of Mines production figures—fell off slightly, reflecting diminished expenditures for building. While the building contract awards were substantially greater in 1938 than those reported for 1937, improvement was confined to the last few months.

Imports were reduced much more sharply than domestic production, reflecting further displacement of foreign by American clays as well as greater retrenchment in those industries that still are wedded to the use of imported materials. The total imports of all kinds of clay dropped in 1938 to 113,059 short tons, valued at \$1,127,462 from 205,304 tons and \$1,950,043 in 1937. During the five-year period, 1925-29, imports averaged 420,310 tons, valued at \$3,841,462 annually.

CERTIFICATES TO PRACTICE

State Board of Architectural Examiners has granted provisional certificates to the following persons to practice architecture in California: Jerald Torrens Beem, 246 Roswell, Long Beach; Harland Bruce Douglas, 842 Rougeot, San Luis Obispo; Frederick Charles Hageman, San Marcos Trout Club, Santa Barbara; Eduardo Jose Samaniego, 2265 W. 22nd St., Los Angeles; Kenneth Raymond Swift, 633 S. Burlingame Ave., West Los Angeles.

FRANK ALLEN GOES INTO BUSINESS

Frank Allen, for some time identified with the Ferro-Enamel Company of Oakland, has established his own business under the name of "Frank Allen Ferro-Portland Construction," with offices at 320 Market Street, San Francisco. Mr. Allen reports business good, one of his latest contracts to be successfully completed being the Maxwell House Coffee building, Treasure Island.

ARCHITECTURAL METALS USED

The Oregon Brass Works of Portland, Oregon, were identified with the construction of many of the prominent buildings illustrated in this issue of *The Architect*

and *Engineer*. The firm's architectural metals were used on the Weisfield & Goldberg store, Bohemian restaurant, Zell Brothers store, Wegerts Prescription Pharmacy and the Equitable Savings & Loan Building, all in Portland, Oregon.

HIGHWAY PROGRESS

(Concluded from Page 51)

grade separations with intersecting major highways, and with paralleling service roads to preserve the "freeway" principle of its design.

An attempt has been made to visually illustrate the growth of traffic since 1912 by the number of automobiles shown using each section of the model.

The tremendous increase in the cost of constructing a mile of the early day roads as compared with the cost of constructing the complicated designs now necessary, should also be plainly evident to any spectator who views the model.

Moreover, an attempt has been made to illustrate the evolution of the esthetic features of highway design as well as to suggest the advantages which should, and do, accrue by virtue of intelligent and careful landscaping where climatic conditions are favorable to such treatment without excessive maintenance cost. The cooperation and interest of the California Roadside Council is acknowledged in the development of this phase of the model design.

Every part of the model is to correct scale, and the trees, shrubbery, buildings and other appurtenances were carefully checked for historical accuracy and exactness of detail.

The basic topography of the model was first done in clay and then cast into plaster, after which the various dressings which feature the exhibit were added. The workmanship and skill throughout are of such high quality that a perfect illusion of naturalness has been created, and the model has elicited much comment and praise.

Complete plans for the highway exhibit were developed by Division of Highway's personnel, working in cooperation with the California Commission for the Golden Gate International Exposition, which supplied the funds for the construction and installation of the entire exhibition housed in the California Building.

BOOK REVIEWS

EDIBLE WILD PLANTS: by Oliver Perry Medsger; The Macmillan Company, New York City, N.Y. Price: \$3.50.

This is the first complete handbook describing the wild plants in America which are edible. It forms a very definite contribution to American natural literature.

Almost all of the edible plants growing outside of cultivation are described with accompanying drawings in pen and ink, some eighty in number, besides nineteen photographs. Those having country homes will find this book of great value in learning to identify and classify the wild plants of an edible nature that may be growing on their property or in the near vicinity.

GARDEN OF LARKSPURS: by L. H. Bailey; The Macmillan Company, New York City, N.Y. Price: \$3.00.

A book which not only is an authoritative work on larkspurs but also encompasses the field of delphinium culture, and is a complete departure from the usual treatise on delphiniums.

More than a hundred species are accounted for and there is a chapter on the diseases attacking these plants. Illustrations complete a very sound work, valuable to professional gardeners, as well as amateurs. The book contains a key to the several varieties and expert advice for those interested in the culture of hybrid larkspurs.

PAINTS AND PAINTING: by G. C. Molleson, M.E.; David MacKay Company, Washington Square, Philadelphia, Pa. Price: \$2.00.

A non-technical manual of useful and practical information on Paints and Painting with chapters on the formulation, properties, and application of the various paints. The book should prove of definite value to those charged with the maintenance and preservation of bridges, equipment and buildings, as well as miscellaneous structures.

The contents includes much of interest to the home owner and the average layman; also its contents will give the general consumer a better idea of the merchandise he is purchasing, thereby enabling him to buy the paint most suitable for his purpose. A book such as this one should be in many hands.

THE BUILT-UP ROOF: Issued by Bernard Sachs, Editor of "The American Roofer," 425 Fourth Avenue, New York City. Price: \$1.00.

An excellent little handbook containing information and details on the built-up roof. It is a complete working guide to all phases of its application and approved by the roofing industry as a whole. There are eighty illustrations and eighty pages of text. Contractors especially will find "Built-Up Roofs" an asset to their library of practical building information.

RICHARD UPJOHN—Architect and Churchman: by Everard M. Upjohn; Columbia University Press, New York City, N.Y. Price: \$4.00.

This is the first biography to be written by a direct descendant of one of America's noted earlier architects. Upjohn was commissioned to design Trinity Church in New York City a century ago.

In this volume will be found data on the life work of an interesting figure in American professional life, and the book should be of more than ordinary interest to the architect of today. Upjohn worked in the period covered by the years 1835 to 1870, and affords a link connecting a Greek revival architect such as was Robert Mills with the eclecticism of H. H. Richardson.

The book is well written and contains over one hundred illustrations of Upjohn's work. It is a definite contribution to the biographies of professional Americans.

SIR JOHN VANBRUGH, Architect and Dramatist; by Laurence Whistler; The Macmillan Company, New York City, N.Y. Price: \$5.00.

One of the very best books dealing with biography in the professional field to come out this year. The subject is the man who from an obscure soldier became the rival of Congreve and later of Wren, and brought English Baroque to its perfection.

A most colorful career is here unfolded and makes delightful reading. Marlborough, Steele, Addison, Walpole and Congreve cross the pages, taking the reader back to one of the vital periods of English life in London. An architect who has a flare for the history of his profession will get inspiration from this volume.

THE THEORY OF MODERN STEEL STRUCTURES (Vol. 1; Vol. 2): by L. E. Grinter, The Macmillan Company, New York City, N. Y. Price: \$8:50 (Two Vols.)

In the two volumes comprising the theory of modern structures there will be found the most complete and accurate data on Statistical Determinate Structures and on Indeterminate Structures. These books form text matter for undergraduate courses in analysis of steel structures. Wide in scope, thoroughly technical and minutely accurate with graphs, tables and illustrations, the two books commend themselves to the engineering student in search of ready information and technical advice.

LOCAL ARCHITECTS WIN PRIZES

Prizes of \$100 for distinguished low cost single family dwellings designed for the Northwestern section of the United States were awarded in New York City to five San Francisco men by a jury of nationally known architects. Their entries were chosen recently as winners in the second and culminating stage of a nationwide housing contest organized by the Productive Home Architectural Competition.

The San Francisco winners are John Ekin Dinwiddie, Garrett Eckbo and Albert Hill, collaborators, 360 Pine Street; Francis Ellsworth Lloyd of 360 Pine Street, and Frederick L. Langhorst of 260 California Street. The winning designs will be published in the June number of *The Architect and Engineer*.

Estimator's Guide

Giving Cost of Building Materials, Wage Scale, Etc.

Amounts given are figuring prices and are made up from average quotations furnished by material houses to San Francisco contractors. 3% Sales Tax on all materials but not labor.

All prices and wages quoted are for San Francisco and the Bay District. There may be slight fluctuation of prices in the interior and southern part of the state. Freight cartage at least, must be added in figuring country work.

Bond— $1\frac{1}{2}\%$ amount of contract.

Brickwork—

Common, \$40 to \$45 per 1000 laid, (according to class of work).

Face, \$100 to \$110 per 1000 laid, (according to class of work).

Brick Steps, using pressed brick, \$1.25 lin. ft.

Brick Veneer on frame buildings, \$.75 sq. ft.

Common f.o.b. cars, \$14.00 at yard. Cartage extra.

Face, f.o.b. cars, \$45.00 to \$50.00 per 1000, carload lots.

HOLLOW TILE FIREPROOFING (f.o.b. job)

3x12x12 in.	\$ 84.00 per M
4x12x12 in.	94.50 per M
6x12x12 in.	126.00 per M
8x12x12 in.	225.00 per M

HOLLOW BUILDING TILE (f.o.b. job)

carload lots.	
8x12x5 $\frac{1}{2}$	\$ 94.50
6x12x5 $\frac{1}{2}$	73.50

Building Paper—

1 ply per 1000 ft. roll	\$3.50
2 ply per 1000 ft. roll	5.00
3 ply per 1000 ft. roll	6.25
Brownskin, 500 ft. roll	4.50
Brownskin, Pro-tect-o-mat, 1000 ft. roll	9.00
Sisal-kraft, 500 ft. roll	5.00
Sash cord com. No. 7	\$1.20 per 100 ft.
Sash cord com. No. 8	1.50 per 100 ft.
Sash cord spot No. 7	1.90 per 100 ft.
Sash cord spot No. 8	2.25 per 100 ft.
Sash weights cast iron, 500 lb. ton.	
Nails, \$3.50 base	
Sash weights, 45¢ per ton.	

Concrete Aggregates—

Gravel (all sizes) \$1.45 per ton at bunker; delivered to any point in S. F. County \$1.85.	
	Bunker Delivered
Top sand	\$1.45 1.85
Concrete mix	1.45 1.85
Crushed rock, $\frac{3}{4}$ to 94	1.60 2.00
Crushed rock, $\frac{3}{4}$ to 1 $\frac{1}{2}$	1.60 2.00
Roofing gravel	1.60 2.00
City gravel	1.45 1.85
River sand	1.40 1.80
Delivered bank sand—\$1.00 per cubic yard at bunker or delivered.	

SAND—

	Bunker Delivered
River sand	\$1.40 1.80
Lapis (Nos. 2 & 4)	2.00 2.40
Olympia Nos. 1 & 2	1.80 2.20
Headburg plaster sand	\$1.80 and \$2.20
Del Monte white	.50c per sack

CEMENT (all brands, cloth sacks) \$2.72 per bbl. f.o.b. car.; deliv. \$2.90 per bbl., carload lots; less than carload lots, warehouse or delivered, 80c per sack. (Less 10c per sack returned, 2% 10th Prox.)

Common cement (all brands, paper sacks) carload lots \$2.52 per bbl. f.o.b. car.; delivered, \$2.70; less than carloads delivered, 75c per sack. Discount on cloth sacks, 10c per sack. Cash discount on carload lots, 10c a barrel, 10th Prox.; cash discount less than carload lots, 2%.

Atlas White } 1 to 100 sacks, \$1.50 sack,
Calaveras White } warehouse or delivery; over 100
Medusa White } sacks, \$1.25; 2% discount 10th
of month.

Forms, Labors average \$40.00 per M.
Average cost of concrete in place, exclusive of forms, 35c per cu. ft.; with forms, 60c.
4-inch concrete basement floor 12 $\frac{1}{2}$ c to 14c per sq. ft.
Rat-proofing 7 $\frac{1}{2}$ c
Concrete Steps \$1.25 per lin. ft.

Dampproofing and Waterproofing—

Two-coat work, 20c per yard.
Membrane waterproofing—4 layers of saturated felt, \$4.50 per square.
Hot coating work, \$1.80 per square.
Medusa Waterproofing, 15c per lb., San Francisco Warehouse.
Tricocel waterproofing.
(See representative.)

Electric Wiring—\$12.00 to \$15.00 per outlet for conduit work (including switches).
Knob and tube average \$3.50 per outlet.

Elevators—

Prices vary according to capacity, speed and type. Consult elevator companies.
Average cost of installing an automatic elevator in four-story building, \$2800; direct automatic, about \$2700.

Excavation—

Sand, 60 cents; clay or shale \$1 per yard.
Teams, \$12.00 per day.
Trucks, \$22 to \$27.50 per day.
Above figures are an average without water. Steam shovel work in large quantities, less; hard material, such as rock, will run considerably more.

Fire Escapes—

Ten-foot galvanized iron balcony, with stairs, \$115 installed on new buildings; \$140 on old buildings.

Floors—

Composition Floors—22c to 40c per sq. ft. In large quantities, 16c per sq. ft. laid.
Mosaic Floors—80c per sq. ft.
Duraflex Floors—23c to 30c sq. ft.
Rubber Tile—50c to 75c per sq. ft.
Terazzo Floors—45c to 60c per sq. ft.
Terazzo Steps—\$1.60 lin. ft.

Hardwood Flooring (delivered to building)—
1 $\frac{1}{2}$ x2 $\frac{1}{4}$ " T & G Maple \$ 88.00 M ft.
1 $\frac{1}{4}$ x2 $\frac{1}{4}$ " T & G Maple 115.00 M ft.
 $\frac{7}{8}$ x3 $\frac{1}{2}$ " sq. edge Maple 100.00 M ft.

	1 $\frac{1}{2}$ x2 $\frac{1}{4}$ "	3 $\frac{1}{2}$ x2"	1 $\frac{1}{2}$ x2"
	T & G	T & G	Sq. Ed.
Clr. Ord. Oak	\$120.00 M	\$ 82.50 M	\$110 M
Sel. Ord. Oak	99.00 M	69.50 M	88 M
Clr. Pla. Oak	106.00 M	74.50 M	88 M
Sel. Pla. Oak	97.00 M	62.50 M	76 M
Clear Maple	111.00 M	100.00 M	
Laying & Finishing	14c ft.	12c ft.	10c ft.
Wage—Floor layers,	\$10.00.		

Note—Above quotations are all board measure except last column which is sq. ft.

Glass (consult with manufacturers)—

Double strength window glass, 20c per square foot.
Plate 75c per square foot (unglazed) in place, \$1.00.
Art, \$1.00 up per square foot.
Wire (for skylights), 40c per sq. foot.
Obscure glass, 30c square foot.
Glass bricks, \$2.40 per sq. ft. in place.
Note—If not stipulated add extra for setting.

Heating—

Average, \$1.90 per sq. ft. of radiation, according to conditions.
Warm air (gravity) average \$40 per register.
Forced air, average \$60 per register.

Iron—Cost of ornamental iron, cast iron, etc., depends on designs.

Lumber (prices delivered to bldg. site).

No. 1 common	\$29.00 per M
No. 2 common	27.00 per M
Select O. P. common	34.00 per M
1x4 No. 3 form lumber	24.00 per M
1x4 No. 2 flooring VG	55.00 per M
1x4 No. 3 flooring VG	47.00 per M
1x6 No. 2 flooring VG	60.00 per M
1 $\frac{1}{2}$ x4 and 6, No. 2 flooring	60.00 per M

Slash grain—

1x4 No. 2 flooring	\$43.00 per M
1x4 No. 3 flooring	40.00 per M
No. 1 common run T. & G.	30.00 per M
Lath	5.25 per M

Shingles (add cartage to price quoted)—
Redwood, No. 1 \$1.10 per bdle.
Redwood, No. 290 per bdle.
Red Cedar 1.10 per bdle.

Plywood—Douglas Fir (ad cartage)—

"Plyscord" sheathing (unsanded)	
5/16" 3-ply and 48"x96"	\$32.50 per M
"Plywall" (wallboard grade)—	
1/4" 3-ply 48"x96"	\$35.00 per M
"Plyform" (concrete form grade)—	
3/4" 5-ply 48"x96"	\$100.00 per M
Exterior Plywood Siding—	
7/16" S-ply Fir	\$ 90.00 per M
Redwood	\$100.00 per M

Millwork—Standard.

O. P. \$85.00 per 1000. R. W., \$90.00 per 1000 (delivered).
Double hung box window frames, average with trim, \$6.50 and up, each.
Doors, including trim (single panel, 1 $\frac{3}{4}$ in. Oregon pine) \$8.00 and up, each.
Doors, including trim (five panel, 1 $\frac{3}{8}$ in. Oregon pine) \$6.00 each.
Screen doors, \$3.50 each.
Patent screen windows, 25c a sq. ft.
Cases for kitchen pantries seven ft. high, per lineal ft., \$8.00 each.
Dining room cases, \$8.00 per lineal foot. Rough and finish about 75c per sq. ft.
Labor—Rough carpentry, warehouse heavy framing (average), \$17.50 per M. For smaller work average, \$35.00 to \$45.00 per 1000.

Marble—(See Dealers)

Painting—

Two-coat work	36c per yard
Three-coat work	50c per yard
Cold Water Painting.....	10c per yard
Whitewashing	4c per yard
Turpentine, 65c per gal., in 5 gal. cens. and 55c per gal. in drums.	
Raw Linseed Oil—97c gal. in bbls.	
Boiled Linseed Oil—\$1.00 gal. in bbls.	
Medusa Portland Cement Paint, 20c per lb.	

Pioneer or Dutch Boy White Lead in Oil (in steel kegs). Per Lb.

1 ton lots, 100 lbs. net weight.....	10 1/4c
500 lbs. and less than 1 ton lots.....	10 1/2c
Less than 500 lb. lots.....	11c

Pioneer or Dutch Boy Red Lead and Litharge (in steel kegs).

1 ton lots, 100 lb. kegs, net weight.....	10 1/4c
500 lbs. and less than 1 ton lots.....	10 1/2c
Less than 500 lb. lots.....	11c

Pioneer Red Lead in Oil (in steel kegs)

1 ton lots, 100 lb. kegs, net weight.....	11 1/4c
500 lbs. and less than 1 ton lots.....	11 1/2c
Less than 500 lb. lots.....	12c

Note—Accessibility and conditions cause some variance in costs.

Petent Chimneys—

6-inch	\$1.25 lineal foot
8-inch	1.75 lineal foot
10-inch	2.25 lineal foot
12-inch	3.00 lineal foot

Plastering—Interior—

1 coat, brown mortar only, wood lath	Yard \$0.60
2 coats, lime mortar hard finish, wood lath ..	.70
2 coats, hard wall plaster, wood lath72
3 coats, metal lath and plaster	1.25
Keene cement on metal lath	1.30
Ceilings with 3/4 hot roll channels metal lath (lathed only)	1.10
Ceilings with 3/4 hot roll channels metal lath plastered	1.85
Single partition 3/4 channel lath 1 side (lath only)85

Single partition 3/4 channel lath 2 inches thick plastered	\$2.90
4-inch double partition 3/4 channel lath 2 sides (lath only)	1.70
4-inch double partition 3/4 channel lath 2 sides plastered	3.80
Thermax single partition; 1" channels; 2 1/4" overall partition width. Plastered both sides	2.50
Thermax double partition; 1" channels; 4 1/4" overall partition width. Plastered both sides	3.10
3 coats over 1" Thermax nailed to one side wood studs or joists	2.25
3 coats over 1" Thermax suspended to one side wood studs with spring sound insulation clip	1.40

Plastering—Exterior—

2 coats cement finish, brick or concrete wall	\$1.00
3 coats cement finish, No. 18 gauge wire mesh	1.50
Wood lath, \$7.50 to \$8.00 per 1000.17
2 1/2-lb. metal lath (dipped)20
2 1/2-lb. metal lath (galvanized)22
3 1/2-lb. metal lath (dipped)22
3 1/2-lb. metal lath (galvanized)28
3/4-inch hot roll channels, \$72 per ton.	
Finish plaster, \$18.90 ton; in paper sacks.	
Dealer's commission, \$1.00 off above quotations.	
\$13.85 (rebate 10c sack).	
Lime, f.o.b. warehouse, \$2.25 bbl.; cars, \$2.15 lime, bulk (ton, 2000 lbs.), \$16.00 ton.	
Wall Board 5 ply, \$50.00 per M.	
Hydrate Lime, \$19.50 ton.	

Plasterers' Wage Scale	\$1.25 per hour
Lathers' Wage Scale	1.25 per hour
Hod Carriers' Wage Scale	1.10 per hour
Composition Stucco—\$1.80 to \$2.00 sq. yard (applied).	

Plumbing—

From \$70.00 per fixture up, according to grade, quantity and runs.

Roofing—

"Standard" tar and gravel, \$6.50 per sq. for 30 sqs. or over.
 Less than 30 sqs. \$7.00 per sq.
 Tile, \$20.00 to \$35.00 per square.
 Redwood Shingles, \$7.50 per square in place.
 Copper, \$16.50 to \$18.00 per sq. in place.
 Cedar Shingles, \$8.00 per sq. in place.
 Recoat, with Gravel, \$3.00 per sq.
 Asbestos Shingles, \$15 to \$25 per sq. laid.

Slate, from \$25.00 to \$60.00 per sq. yard, according to color and thickness.
 Shakes—1x25" resawn \$11.50 per sq. || 1/2x25" resawn | 10.50 per sq. |
| 1/2x25" tapered | 10.00 per sq. |

Above prices are for shakes in place.

Sheet Metal—

Windows—Metal, \$1.75 a sq. foot.
 Fire doors (average), including hardware \$1.75 per sq. ft.

S Skylights—(not glazed)

Copper, 90c sq. ft. (flat).
 Galvanized iron, 30c sq. ft. (flat).
 Vented hip skylights 60c sq. ft.

Steel—Structural

\$120 ton (erected), this quotation is an average for comparatively small quantities. Light truss work higher. Plain beams and column work in large quantities \$90 to \$100 per ton.

Steel Reinforcing—

\$80.00 to \$120.00 per ton, set.

Stone—

Granite, average, \$6.50 cu. foot in place.
 Sandstone, average Blue, \$4.00, Boise, \$3.00 sq. ft. in place.
 Indiana Limestone, \$2.80 per sq. ft. in place.

Store Fronts—

Copper sash bars for store fronts, corner, center and around sides, will average 75c per lineal foot.
 Note—Consult with agents.

Tile—Floor, Wainscot, etc.—(See Dealers)

Asphalt Tile—18c to 28c per sq. ft. installed.

Wall Tile

Glazed Terra Cotta Wall Units (single faced) laid in place—approximate prices:	
2 x 6 x 12	\$1.00 sq. ft.
4 x 6 x 12	1.15 sq. ft.
2 x 8 x 16	1.10 sq. ft.
4 x 8 x 16	1.30 sq. ft.

Venetian Blinds—

40c per square foot and up. Installation extra.

THE BUILDERS' EXCHANGE OF SAN FRANCISCO STANDARD WAGE SCALE

For mechanics employed on construction work in the Bay Region. Effective September 1, 1937

CRAFT	Journeymen Mechanics
Asbestos Workers	\$ 8.00
Bricklayers (8h-5d)	10.50
Bricklayers' Hodcarriers (6h-5d)	6.75
Cabinet Workers (Outside) (5d)	8.00
Catsons Workers (Open)	6.40
Carpenters (8h-5d)	10.00
Cement Finishers (8h-5d)	10.00
Cork Insulation Workers (8h-5d)	9.00
Electric Workers (8h-5d)	11.00
Electrical Fixture Hangers	8.00
Elevator Constructors	10.40
Engineers, Portable & Hoisting	9.00
Glass Workers (8h-5d)	9.68
Hardwood Floormen	9.68
House-smiths, Architectural Iron (Shop) (8h-5d)	9.00
House-smiths, Architectural Iron (Outside) (8h-5d)	10.00
House-smiths, Reinforced Concrete or Rodmen (8h-5d)	10.00
Iron Workers (Bridge and Structural) Including Engineers (8h-5d)	12.00

CRAFT	Journeymen Mechanics
Laborers, Building (8h-5d)	\$ 6.00
Laborers, Common (8h-5d)	6.00
Lathers, Channel Iron (6h-5d)	9.00
Lathers, All Others	9.00
Marble Setters (8h-5d)	10.50
Marble Setters' Helpers (8h-5d)	6.50
Millwrights	9.00
Model Makers (\$1.50 per hr-6h)	9.00
Modelers (\$2 per hr-6h)	12.00
Model Casters	7.20
Mosaic and Terrazzo Workers (Outside) ..	9.00
Painters (7h-5d)	8.50
Painters, Varnishers and Polishers (Outside) ..	9.00
Pile Drivers and Wharf Builders	9.00
File Drivers' Engineers	10.00
Plasterers (6h-5d)	10.00
Plasterers' Hodcarriers (6h-5d)	7.50
Plumbers (8h-5d)	11.00
Roofers, Composition (8h-5d)	8.00
Roofers, All Others (8h-5d)	8.00
Sheet Metal Workers (8h-5d)	10.00
Sprinkler Fitters	10.00

CRAFT	Journeymen Mechanics
Steam Fitters (8h-5d)	\$11.00
Stair Builders (8h-5d)	9.00
Stone Cutters, Soft and Granite (8h-5d) ..	8.00
Stone Setters, Soft and Granite	12.00
Stone Derricksman	9.00
Tile Setters (8h-5d)	11.00
Tile Setters' Helpers (8h-5d)	6.50
Tile, Cork and Rubber (8h-5d)	9.00
Welders, Structural Steel Frame on Buildings ..	11.00
Welders, All Others on Buildings	9.00
Dump Truck Drivers, 2 yards or less	6.50
Dump Truck Drivers, 3 yards	6.50
Dump Truck Drivers, 4 yards	7.00
Dump Truck Drivers, 5 yards	7.00
Dump Truck Drivers, 6 yards	7.50
Truck Drivers of Concrete Mixer Trucks:	
2 yards or less	6.50
3 yards	7.00
4 yards	7.50
5 yards	7.50
6 yards	8.00

GENERAL WORKING CONDITIONS

- Eight hours shall constitute a day's work for all crafts except as otherwise noted.
- Plasterers' Hodcarriers, Bricklayers' Hodcarriers, Roofers' Laborers, and Engineers, Portable and Hoisting, shall start 15 minutes before other workmen, both at morning and at noon.
- Five days, consisting of not more than eight hours a day, on Monday to Friday inclusive, shall constitute a week's work.
- Transportation costs in excess of twenty-five cents each way shall be paid by the contractor.
- Overtime shall be paid as follows: For the first four hours after the first eight hours, time and one-half. All time thereafter shall be paid

- double time. Saturdays (except Laborers), Sundays and holidays, from 12 midnight of the preceding day, shall be paid double time.
- On Saturday, Laborers shall be paid straight time for an eight-hour day.
- Where two shifts are worked in any twenty-four hours, shift time shall be straight time. Where three shifts are worked, eight hour's pay shall be paid for seven hours on the second and third shifts, allowing one-half hour for lunch.
- All work, except as noted in paragraph 9, shall be performed between the hours of 8 a.m. and 5 p.m.
- In emergencies, or where premises cannot be vacated until the close of business, men then

- reporting for work shall work at straight time. Any work performed on such jobs after midnight shall be paid time and one-half up to four hours of overtime and double time thereafter, provided, that if a new crew is employed on Saturdays, Sundays or holidays which has not worked during the five preceding days, such crew shall be paid time and one-half.
- Recognized holidays to be: New Year's Day, Decoration Day, Fourth of July, Labor Day, Admission Day, Thanksgiving Day, Christmas Day.
- Men ordered to report for work, for whom no employment is provided, shall be entitled to two hours' pay.

ARCHITECTS' BULLETIN

Issued For

THE STATE ASSOCIATION OF CALIFORNIA ARCHITECTS

Northern Section

STATE ASSOCIATION MEMBER
OF THE
AMERICAN INSTITUTE OF ARCHITECTS

Editor

Harris C. Allen

Address all communications for publication
in the Bulletin to the Editor (Harris C.
Allen) 557 Market Street, Room 218, San
Francisco, California.

Board of Control

Harris C. Allen Otto G. Hintermann
Harry Michelsen Wayne S. Hertzka

State Association Officers

President.....Sylvanus B. Marston, Pasadena
Vice-President.....Gwynn Officer, Berkeley
Secretary...Wayne S. Hertzka, San Francisco
Treasurer.....Robert H. Orr, Los Angeles

Regional Director, A. I. A.

Albert J. Evers, San Francisco

Delegate Regional Director, Southern
California

Gordon B. Kaufmann, Los Angeles

Executive Board—Northern Section
Officers

President.....Gwynn Officer, Berkeley
Vice-President.....Ernest E. Weihe, San Francisco
Secretary...Wayne S. Hertzka, San Francisco
Treasurer...Otto G. Hintermann, San Francisco

Directors

Harry J. Devine R. H. Reimers
Wm. J. Merchant Harold Weeks

Executive Board—Southern Section
Officers

President.....Sylvanus B. Marston
Vice-President.....Louis N. Crawford
Secretary.....Winsor Soule
Treasurer.....Robert H. Orr

Directors

Merrill W. Baird Abe Edelman
Harold C. Chambers George D. Riddle

Advisors—Northern Section

Harris C. Allen San Francisco
J. K. Ballantine, Jr. (Secretary)
Sam. Lightner Hyman
Wm. G. Merchant
Jas. F. McGuiness
Dodge A. Riedy
Harold H. Weeks
Ernest E. Weihe
Albert R. Williams
Fred. H. Reimers (President)
C. A. Caulkins North Bay District
Peter Sala Lower San Joaquin
 District

J. U. Cloudsley (Secretary)
Edw. W. Kress Santa Clara Valley
Mario Corbett San Mateo
Alden Cambell Sacramento
Ernest J. Kump Upper San Joaquin
Dole F. Thomsen Palo Alto
Norman W. Sexton Marin
Geo. P. Simonds East Bay
Chester Treichel East Bay
Gwynn Officer Berkeley
F. T. Georgeson Redwood Empire
Casebolt Dakin Upper Sacramento
Ralph Taylor Lassen District

MORE LEGISLATION

ATTENTION has been directed the past month to national legislation affecting building activities. The Association has communicated with our California delegates in Washington in regard to both Federal Housing Administration and United States Housing Authority Acts, to which amendments were proposed which would have seriously crippled the program. One of these would have reduced the cost per family unit from \$4,000 for building, improvements only, to \$3,500, including land and professional fees. This amendment, fortunately, was defeated. Other changes are still undecided, but we have received courteous and sympathetic responses from several of our representatives.

We are also interested in extending appropriations for certain Public Works Administration projects which may be considered as emergency features in providing work for the building industry—including architects and engineers—during a lapse of private building activity.

• ASSOCIATIONS DIRECTOR •
A San Francisco meeting was called in April on rather short notice, to greet the representative of State Associations on the Board of Directors of the American Institute of Architects, Mr. Leigh Hunt. The meeting was quite well attended and very interesting. Mr. Hunt has a gracious and convincing personality, as can well be imagined when it is learned that largely as a result of his recent extended traveling, the number of State Association members of the Institute has increased from four to nine, with an early prospect of three more.

Among the points brought out by Mr. Hunt was the use of collective, continued advertising that has been effectively made by some associations. Small, repeated notices of the "Consult your architect" type, inserted in papers weekly or oftener, brought more tangible results than the occasional large splurge—which few people take time to read. Another concerned the increasing friendly relationship between architects and draftsmen, which is not news to our California outfit.

Mr. Hunt urged more general financial support by architect members, and reported percentages of paying members, in some states, much higher, alas, than in our own case; although all the states apparently think of California as leader in this movement, which shows that we cannot rest on our laurels if we wish to keep in the lead.

There was one point, however, which we have solved happily, that has caused considerable confusion and trouble elsewhere; the division or duplication of activities between Institute and Association. It has worked out simply and satisfactorily here, by definitely assigning education, esthetics and ethics

to one, and legislation, business practice and publicity to the other—with interlocking committees.

DRAFTSMEN'S REGISTRATION The California Society of Architectural Draftsmen have actively taken up the work of registering available draftsmen and are running advertisements in trade journals. The records are still kept in the State Association of California Architects office, and our loyal office secretary, Mrs. Milton, is on the job to cooperate with the Draftsmen's Society in bringing architects and draftsmen together.

MEMBERSHIP PRIVILEGES If you have read this far, do not stop now. The privilege of carrying on our joint efforts for better architecture—which is the real aim back of all our activities—can be yours by sending the modest sum of \$5.00 for annual subscription dues. And think how you will brighten the life of our due-tiful treasurer, Otto Hintermann.

DALY'S MOTIFS This famous old book is offered by Mr. B. Cooper Corbett for a fraction of its catalogue price, in a two-volume edition with original engraved plates, published in France in 1869. Call the S. A. C. A. office for particulars.

SOUTHERN CALIFORNIA CHAPTER

Los Angeles architects are 100 per cent in favor of a publicity campaign if the necessary wherewithal can be raised. At the April 11th meeting of the Chapter varying methods for financing the movement were discussed.

That there is immediate need for such a program and that suitable means of raising the necessary funds can be found, was indicated by opinions expressed. A resolution was adopted authorizing a committee to have published two types of pamphlets for distribution among prospective clients; one type for those who contemplate erecting commercial buildings and the other for residences.

The program, which is the outgrowth of a recent survey and analyses of the architectural profession, contemplates following up the distribution of pamphlets with space advertising in newspapers and magazines, and budgeting a sum of money each year to perpetuate the plan.

A letter from the Los Angeles County Supervisors, requesting that the Chapter study and report on a civic center plan, was read by Eugene Weston, Jr., who presided.

John C. Austin stated that not only the supervisors, but the business men of Los Angeles are interested in such a plan and are desirous of the architects and engineers working out a satisfactory solution. "If a comprehensive plan is not provided," he said, "and the flow of traffic through the downtown area is not

regulated, business will become more decentralized than ever."

Gordon B. Kaufmann read a letter from the Institute's Federal Public Works committee chairman, in which it was stated that government officials have authorized the holding of architectural competitions for four post office buildings to be erected in various parts of the country, one of them at Burlingame, California. The competitions will be confined to architects practicing in regions where the buildings are to be erected.

Charles O. Matchem was presented with a certificate of membership in the Institute.

Creation of the Fine Arts Alliance of California, an association of people interested in all of the fine arts, was announced by Mr. Kaufmann, president of the Alliance.

A letter from the Los Angeles City Housing Authority was read, thanking the Chapter for its support of the slum clearance program. In this connection it was stated that the Federal Works Progress Administration recently made an appropriation for a survey of Los Angeles housing needs, to replace existing sub-standard dwellings.

Ralph W. Armitage, president of the Santa Barbara Chapter, was a guest.

ARCHITECTS AND HEATING ENGINEERS

Washington State Chapter, A. I. A., met April 6 with the Pacific Northwest Chapter, American Society of Heating and Ventilating Engineers, and listened to an illustrated talk by Leon L. Munier on "Panel Heating."

At a business meeting following the program the architects decided that hereafter members of the Chapter will not participate in a group display of drawings without the approval of the exhibition committee. President F. A. Naramore announced a goodwill tour to Pullman on May 15.

After some discussion as to whether the architects' sketches in the Central Housing Bureau should be changed or withdrawn, it was moved by William J. Bain that the matter be turned over to a special committee, with the thought in mind of establishing a permanent exhibit. President Naramore appointed a committee composed of Mr. Bain, Edwin J. Ivey, G. Wellington Stoddard, LaMonte Shorett and Lance E. Gowen.

TACOMA BUILDING CODE

Tacoma architects recently appeared before the City Council in an effort to change the building code so architects may be employed in the construction of buildings valued at \$5,000 or more. Architect E. T. Mock argued that such a provision would benefit the home builder by saving him money. Principal opposition to the proposal came from lumber company representatives, who argued that such a provision might deter construction of homes.

MODERNIZED PRODUCTS

Brief Notes on New Materials and Equipment in the Building Industry.

210. HOME FINANCING

The Bank of America has issued a little booklet aptly called "A Pocket Guide to Home Financing." It contains some interesting and pertinent data and illustrations. The coupon will bring you a copy.

211. PUMPS

A very fine little handbook has been put out by Economy Pumps, Inc. It contains much useful information on pumps. Send for your copy.

212. PAINTS & VARNISHES

An old friend is back again—Dutch Boy Painter Magazine; this interesting booklet always has news of interest to the building contractor and is up to the mark editorially.

213. COPPER & BRASS

A new Bulletin of the Copper and Brass Research Association is just out and, as always, has a fund of excellent data. This number is "The Saga of American Building," and is nicely gotten up.

214. OIL BURNERS

We welcome some new information and data to this page through the carefully tabulated sheets issued by the John Zink Company. The pamphlet deals with gas and oil burners, several types of which are illustrated. Use the coupon.

215. KRAFTILE IDEAS

Featuring 6 x 9 tile, the newly issued folder of the Kraftile Company of Niles, California, is at once colorful and practical in its suggestions to home-owners and prospective builders of dwellings. Profusely illustrated, the folder reproduces in four colors attractive sketches by two widely-known architects. Frederick L. Confer's bathroom for a \$7200 home and Frederick H. Reimers' kitchen design for a \$7500 home, are prominent among the folder's illustrations. A postal card brings you a copy of this beautiful folder.

216. LIGHT FIXTURES

Some excellent data on lighting, especially on high tension systems, is contained in a booklet by the Miller Company. The booklet deals with the

use of Fluorescent fixtures. Coupon will bring you a copy.

217. CELOTEX

The Celotex Corporation has issued a booklet on "The Fundamentals That Will Make Your Home Stay Modern Longer." We doubt if there is a question that is of greater interest among home owners or builders today. The coupon will secure you a copy of this interesting piece of literature.

218. CABLES

A new cable insulated in rubber without lead sheath for commercial and industrial uses, is fully described in a broadside issued by the Anaconda Copper Company. This should prove of great interest to electrical contractors.

219. SLATE

The Parsons Brothers Slate Company have put out a broadside on Roofing Slate which contains some useful information. The coupon will bring you a copy for your files.

220. LOW COST HOMES

A booklet from the National Lumber Manufacturers Association on low cost homes is one of the best of its kind this year. It has a world of good data and information on an important subject, is well written and illustrated. There are plans, sketches, diagrams and cost tables included.

221. STORE FRONTS

"Store Fronts" is the title of a new booklet by the Kawneer Company. Done in color, it presents the subject in a very attractive manner. The booklet contains information of particular interest to architect and contractor alike. Send for your copy.

222. CONCRETE ROADS

The Portland Cement Association has issued a booklet on "Concrete Highways," and other public improvements. The booklet should be seen to be appreciated. It details some phases of a highly important feature of our national life.

223. STOPS RUST

A rust resisting base for paint finishes called "Bonderizing" is illustrated and described in a very fine booklet put out recently by the Parker Rust Proof Company. This is one of the

handsomest pamphlets received in some time.

224. REFUSE DISPOSAL

The Calcinator Corporation has issued a broadside on a home refuse disposal unit manufactured by them and which has advantages that are manifestly interesting to the home owner and builder. The coupon will bring you this information and all pertinent details.

225. LATHING

Metal Lath News, that interesting little paper put out by the Metal Lath Manufacturers Association, has an especially important title this month; it is called the Housing Edition and contains very detailed data on lathing for homes.

FREE FOR THE ASKING

Check items on coupon, paste on letter head or postal card, and mail to Architect and Engineer.

Architect and Engineer
68 Post Street
San Francisco, Calif.

Please send me literature on the following items as checked below. This request places me under no obligation.

- | | |
|------------------------------|------------------------------|
| 210 <input type="checkbox"/> | 218 <input type="checkbox"/> |
| 211 <input type="checkbox"/> | 219 <input type="checkbox"/> |
| 212 <input type="checkbox"/> | 220 <input type="checkbox"/> |
| 213 <input type="checkbox"/> | 221 <input type="checkbox"/> |
| 214 <input type="checkbox"/> | 222 <input type="checkbox"/> |
| 215 <input type="checkbox"/> | 223 <input type="checkbox"/> |
| 216 <input type="checkbox"/> | 224 <input type="checkbox"/> |
| 217 <input type="checkbox"/> | 225 <input type="checkbox"/> |

My Name.....

Name of Company.....

Street.....

City..... State.....

American Women Become Government Consultants in Home Planning

THE American housewife has at last been called in as a Government consultant. Representatives of the country's greatest industry, housekeeping, have lately met in a conference at Washington to advise with the United States Housing Authority in its work of creating 160,000 new homes for low-income families. Eight homemakers from low-rent housing projects brought their experience to help decide such matters as the shape and size of rooms, the place to put shelves, where the family should eat—matters that do so much to determine the ease of daily living. With their help the USHA is seeking to give homemaking the benefits of the efficiency studies which have long served American industry, farming, and business.

Early in its program the USHA set up in Washington a laboratory for the study of problems in the design and equipment of low-cost dwelling units. Results of these studies are made regularly available to the architects and engineers of local housing authorities all over the country who are now planning and building low-rent housing projects with the aid of USHA 90 per cent loans. More than half a million former slum dwellers will be rehoused in such projects during the next two years, and all of them will live in homes reflecting the common-sense ideas of the housewife as well as the most recent achievement of technical experts.

These USHA homes will be efficient modern workshops for the housewife, as well as agreeable family environments. Laboratory experiment, conducted in the housewives' interests and frequently by the housewives themselves, guarantees the practical nature of every unit-plan. The laboratory, called "study house," is really not a house, but rather an ingenious arrangement of movable walls which permits duplication of conditions in dwelling-units of different sizes and varying floor plans. Here the installation of kitchen and bathroom equipment, the provision of closet space, the arrangement of furniture—all the thousand-and-one details necessary to convenient operation of the home—are practiced and perfected. Here the advocates of eating in the kitchen battle with the defenders of combination living and dining rooms, each faction supporting its belief by concrete demonstration. Here the double bed and the twin bed continue their generation-long feud, as bedroom walls are extended and contracted to provide suitable space. Here cross-ventilation can be studied in operation rather than in blue prints. Here the woman of the house can realize her dream of standing by the sink and ordering the architect to "put more shelves here—wide ones!"

Local communities, financed and counseled by USHA, are building a great variety of low-rent housing projects in every part of the nation. The projects will range in size from 40 dwelling units to several thousand. The appearance and the method of construction will naturally vary to conform with local living conditions. But

interior plans, dwelling-unit designs, will be far more constant, for they will all meet certain standards of convenience, comfort, and efficiency. And these standards are evolved from "study house" experimentation. The American standard of living is becoming a fact rather than a slogan, insofar as it pertains to housing.

The USHA laboratory is utilized by several groups. First, the Technical Division of USHA itself carries on constant experiments, revising room sizes, checking all manner of specifications, testing new ideas developed in the field by local housing authorities. Second, outside experts are called in for conference—home economists and specialists in allied subjects. Thus the arrangement of kitchen equipment and the depth of linen closets are examined critically in the light of the best available knowledge. Third, housewives are invited to inspect the laboratory arrangements, and tear them to pieces if they wish. Women who are actually keeping house in homes similar to those being planned for future projects have a realistic appreciation of what is needed, of what must be included, of what can be discarded. Their point of view is, in the long run, the test that all houses have to meet. American women will ultimately decide the success or failure of present housing plans, and, therefore, every effort is being made to profit by their suggestions in the beginning.

To a large extent these suggestions support the more professional criticism of the experts, but conferences of housewives invariably develop interesting sidelights and reveal a wealth of detailed observation growing out of daily experience in the home. For example, where no separate dining room can be afforded, the American family prefers a kitchen ample enough for eating purposes to the idea of a combination living and dining room. This is a practical preference, to be sure, when space is limited, but it is also a survival of good old American rural traditions.

Women want room to store things. They're emphatic about that. Half their comments have to do with closet space, shelf space, utility rooms, and the like. Women know that housekeeping is largely a problem of proper space to put things in, or on, and they will sacrifice many luxuries for adequate storage arrangements. From canned vegetables to kiddy cars, from bath towels to lawn mowers, everything has to be "put away" eventually, and only the housewife knows what a job it is. It is safe to say that dwelling units planned for USHA will provide more satisfactory arrangements of this type than have ever been achieved in low-cost housing.

USHA houses are designed for real families, for real groups of individuals, and not to meet theoretical requirements. The ages of children, the number of old people, the occupation of the breadwinner—all these factors are kept in mind when the dwelling-units of different types are first sketched and then organized into a project. Each project must provide for a wide range

of families, and the design problem is thus vastly more complicated than that of an architect who builds a house for a separate family group. The "study house" laboratory has proved of vital assistance in solving this problem.

CHAS. D. MAGINNIS HONORED

Charles D. Maginnis of Boston has been elected president of the Fifteenth International Congress of Architects, which, sponsored by the United States Government and the American Institute of Architects, will be held in Washington, September 24-30.

Mr. Maginnis, who is president of the Institute, was chosen by the Joint Committee on Organization of the Congress. Through the Department of State, invitations to participate in the Congress have been extended to fifty foreign governments and to more than 100 foreign architectural societies.

With the approval of President Roosevelt, Secretary of State Hull has appointed eight delegates to represent the United States officially. Mr. Maginnis is chairman of the delegation, the other members of which are:

Louis A. Simon, supervising architect, Treasury Department, Washington, D. C.; Edwin Bergstrom, Los Angeles, Calif.; Harvey Wiley Corbett, Richmond H. Shreve and Stephen F. Voorhees, New York; George Oakley Totten, Jr., Washington, D. C.; Clarence C. Zantzing, Philadelphia. Mr. Zantzing will be Secretary General of the Congress.

Organization committees representing the Federal Government and the Institute have been chosen to arrange for the event.

The Congress of Architects meets in Washington at the invitation of President Roosevelt and the Congress of the United States. The meeting will be the first that the Congress has held in the New World.

Architects of many nations will deliver addresses. Rural and city planning, a critical study of contemporary architecture as judged by standards of other centuries, and opinion on the relationship to be established between the architect and his government are included in the agenda.

SAN FRANCISCO WAREHOUSE

The office of Wm. G. Merchant, Russ Building, San Francisco, is completing plans for a one story steel and corrugated iron warehouse and office building for Earl M. Jorgensen Company, 534 Second Street, San Francisco. The structure will be located at 22nd and Campbell Streets, San Francisco.

NEW BERKELEY H. S. UNITS

W. G. Corlett of Oakland and Henry H. Gutterson of San Francisco have been commissioned to prepare plans for two additional units to the Berkeley High School. The buildings will be for the commercial grades, will be constructed of reinforced concrete and cost \$275,000.

*Modern Homes are
Air-Conditioned by*

SELECTAIR

● DESIGNED and built by the S. T. Johnson Co., pioneer manufacturers of Oil Burners, this smart new air-conditioner combines in one compact unit every feature desired by home-owners, architects and engineers for economical heating, air-conditioning and ventilating the modern home. Year-round hot water. Forced air circulation for summer. Equipped with the popular BANKHEAT Pressure-Type Burner. Furnished in enamel with chrome trim.

Send for "Selectair" Bulletin & complete Specifications

S. T. JOHNSON CO.

Oil Burners

940 Arlington Avenue, Oakland, California
401 Broad Street, Philadelphia, Pa.

● THERE'S A JOHNSON OIL BURNER FOR EVERY PURPOSE

No Worry for the Architect

*"—All acid proof drain pipe and fittings
shall be ferro-silicon—CORROSIRON—"*

[Write for this specification]



FEDERAL BUILDING ● CIVIC CENTER ● SAN FRANCISCO

Arthur Brown, Jr., Architect

CORROSIRON DRAIN LINES and FITTINGS and LABORATORY EQUIPMENT was specified because of its superior resistance to corrosion and wear.

●

Pacific Foundry Company, Ltd.

NEW YORK ● 3100 NINETEENTH ST., SAN FRANCISCO ● LOS ANGELES



**For GAS HEAT choose the
DELCO CONDITIONAIR**

Built and Backed by General Motors

●This extremely efficient unit automatically warms, purifies, humidifies and circulates the air—supplies complete winter air conditioning to which summer cooling can easily be added. A quality product of unusual efficiency with the plus value of the "General Motors" name. Also models for oil heat. Get complete specifications from —

ALADDIN HEATING CORPORATION

Delco-Frigidaire Dealer

2222 SAN PABLO AVENUE • OAKLAND

A good investment—

is a well designed, well built,
structure, properly located.

Lindgren & Swinerton, Inc.

have been building substantial
buildings for over a half of a cen-
tury, are still building them and
will continue building them for
another half of a century.

Lindgren & Swinerton, Inc.

Standard Oil Building
San Francisco

619 H Street
Sacramento

605 W. Olympic Boulevard
Los Angeles

1723 Webster Street
Oakland

Economic as well as social objectives demand eradication of slums, Frederick Bigger of the Pittsburgh Chapter of the American Institute of Architects, chairman of the Pittsburgh City Planning Commission, declares in a report on the basic difficulties of American housing.

A municipality, in preserving a "dangerous and pathological" housing condition and at the same time attempting to compensate for it by vast expenditures for new projects, was likened by Mr. Bigger to "a mad physician" who administers poison and antidote, toxin and anti-toxin, in concurrent doses.

"Our communities, generally, have seemed to be unable or unwilling, or both, to prevent wholesale retrogression," says Mr. Bigger, whose report appears in a social study of Pittsburgh, published by the Columbia University Press. "The actual situation, when analyzed in the light of an observable drop in living standards, reveals that there is an excess of inferior dwellings, a lack of social control to prevent overcrowding and the occupancy of undesirable structures, and a real shortage of good houses.

"Clearly, the continuance of substandard housing in the urban picture is a principal cause of new housing developments which force the community to expand over wider territory, to become physically difficult to administer, costly to repair, and extravagant to operate. In these trends, with their collectively unsound economic basis, is to be found the obvious explanation of the disconcerting fact that the larger the community, the greater the per capita cost of operating it.

"In the trend toward better housing—accelerated in prosperity and halted or reversed in times of depression—the dominant factor unfortunately is, not the well-being of the people who are housed, it is the pressure exerted by our financial procedure and its objective—as much profit as we can get. This is buttressed by unwieldy legalities.

"The pressure of financial factors affecting housing—and building generally—compels an unremitting search for economies in planning and construction. A premium is placed upon ingenuity as an aid in 'beating the game' which is so inflexibly fixed by the financial set-up. Among the results of such efforts are increasing skill in site-planning, in the grouping of buildings, and in the creation of more adequate and appropriately designed open spaces.

"Less effort, or less successful effort, has been directed to the search for a way to escape the maladjustments which our traditional practices involve. The thing we should be looking for is a better and more equitable adjustment between two forces which now pull in opposite directions. They are, on the one hand, the interest and aim of the private property owner; and, on the other hand, the interest and aim of the collective group of private property owners who make

up a dominant part of the community and whose collective action is exercised by their chosen public officials.

"Whether the private owner of property be an owner-occupant of a dwelling or a landlord, he is dominated by the profit motive. He objects to increased taxation, but he desires the improvements, at public expense, which promise to make his property more valuable.

"Acting collectively with his fellows, through public officials, he finds that he has to pay outrageous prices for the land or buildings that must be taken from John Doe or Richard Roe to make way for a public improvement. Still acting collectively, he finds it too costly to buy the private property necessary for the recreation of his children, as a substitute for the private yard play space that has been covered over by 'more profitable' buildings."

Public improvement such as a costly street widening is followed, Mr. Bigger points out, by the expanding cycles of higher property values, higher taxes, more bulky buildings, more intensive use of private property, more people and vehicles in the street, demand for relief from congestion, specific proposals for new public improvements, new improvements at public expense, increased property values, still higher taxes, still more intensive use of private property, still more 'congestion' of people and vehicles in the street, demands for still more 'relief from congestion', new schemes proposed to increase values, another publicly financed improvement program, and so on.

"All through this vicious spiral the public treasury never comes out ahead, its credit becomes pledged to the limit; some property owners are more or less constantly 'on the make', other owners have nothing done to help their own properties the while they contribute taxes toward this effort to increase the values of the favored owners' property.

"Public facilities—streets, sewers, water, lights, etc.—which serve the blighted area and the slum have to be maintained after a fashion, at least, by public funds. They may, or may not, have been adequate when first supplied; but they are almost certain to be neglected after decline has set in, thus accelerating retrogression.

"If, however, standard maintenance of these facilities should be continued, either the tax contribution of depreciated properties is less than the cost of the service they enjoy, or they must be overcrowded to produce sufficient revenue to meet such a charge. Whether or not the blighted area and the slum pay for their own facilities, it is a theoretical fiction that they contribute their proper quota toward the provision of facilities for other and higher-standard localities, perhaps even for those new ones in which modern housing is set up to compete with them.

"Is there an alternative to saddling high-standard

JUST OUT—

The *NEW* Oil Burning DOUBLE Wall Register Floor Furnace



by
H.C. Little

Completing the H. C. Little line of dependable oil burning furnaces, air conditioning units, water heaters, and ranges, the new Double Wall Register Floor Furnace delivers uniform, **controlled** heat on both sides of the partition. One size — 70,000 input — with key or electric control.

Simple and safe, with amazing economy. Send for new illustrated folder for your A.I.A. file.

H. C. LITTLE BURNER CO., San Rafael, Calif.

"Goods of the Woods"

Dependable Building Materials

**Lumber and Millwork
for
All Types of Construction**

★

**Wolmanized or Creosoted
Lumber and Timbers
is your protection against
Termites and Decay**

★

E. K. WOOD LUMBER CO.

San Francisco

Los Angeles

Oakland

POMONA TILES

FOR
Bathrooms and Kitchens
in over 60 colors

Warehouses and Display Rooms

135 Tenth St. San Francisco
629-33 North La Brea Ave. Los Angeles
6106 Roosevelt Way Seattle

POMONA TILE MFG. CO.
PLANT — POMONA, CALIF.



Write for "The Charm of a Well Lighted Home" — to help you plan attractive healthful lighting.

Plan your lighting when you're planning. Incandescent provides ideas for any decorative effect in beautiful traditional and contemporary Lightoliers wrought for a lifetime of perfect lighting.

INCANDESCENT SUPPLY CO.

SAN FRANCISCO : OAKLAND : FRESNO : LOS ANGELES

STRUCTURAL STEEL

For Class A Buildings,
Bridges, etc.

JUDSON PACIFIC CO.

1200 SEVENTEENTH STREET
SAN FRANCISCO

Plants: San Francisco - Oakland

A Permanent Exposition
of the newest ideas
in home planning
and equipment.



THE BUILDING MATERIAL EXHIBIT

Architects Bldg. • Fifth & Figueroa • Los Angeles • MU-6306

housing and non-residential properties with the cost of maintaining even inferior public services for blighted areas and slums which cannot pay for them? In effect the municipality does two ridiculously contradictory things; that is, it preserves a dangerous and costly pathological condition and at the same time attempts to compensate for it by vast expenditures for new projects. It is as if a mad physician were to administer poison and antidote, toxin and anti-toxin, in concurrent doses.

"Appraisal technique is clumsy in its efforts to differentiate between residential and other types of real property. Ordinarily, no account is taken of the important distinction which ought to be made between housing occupied solely by the owner with saving to himself, and rented housing which exists only as a commercial, profit-making commodity. This tends to throw owner-occupied property into the speculative field, and tempts the owner to surrender the 'social home values' for the lure of pecuniary profit.

"These are bad habits to which all our communities have been addicted. There seems to be little or no realization that they are productive of serious social and economic results. But they are there to see, underlying many of the conditions to which our welfare palliatives are applied—tinder for the flame of social disturbance unless corrected with calmness, intelligence, and wisdom."

FUTURE OF ARCHITECTURE IS GOOD

Dean Arnaud of Columbia University says:

"During the past years of outward inactivity, architecture has been undergoing a process of inward change and growth, which might be considered as a period of incubation preceding a rebirth. Changes in social, philosophic, and esthetic ideals and scientific developments will require a new expression in building; and architects, during the past years of enforced leisure, have devoted their time to the study of these changes and developments; so that there is every indication that when building does revive, there will evolve, in this country, a vital, national, modern architecture that will mark a new epoch in the history of art.

"Young men should be convinced that there is a great future for architecture, and that they must prepare now for the time when their services and training will be essential to the physical and esthetic well-being of their fellow-men.

"Architecture, being an art as well as a fundamental need of the human race, is perhaps the most concrete and all-inclusive expression of the age that produces it. It is a truthful record of social, political, and financial conditions, despite survivals of forms and concepts which may still appear to have vitality, while in reality they are superannuated."

A laboratory of design correlation has been established at Columbia for the study of pure form and its application to architecture and industry, according to the report. "The systematic investigation of the reasons for change in form and the application of its findings to commercial processes have not yet been attempted in this country, and are of great necessity and value," Dean Arnaud explains.

"Although the work is still in an experimental stage, it has accomplished results that have occasioned favorable comment. We believe that this type of research has a definite place in a school of architecture, and also in a university which exerts an active influence on contemporary thought and enterprise.

"After a period of continued work and experiment, this laboratory should assemble material that would be of real value to industry, such as methods for the simplification of process, uses of new materials, and the development of forms based on traditional usage, function and esthetic principles."

NEW TYPE LAVATORY

Crane Co., Chicago, announces a new vitreous china lavatory called the "Diana," which has gracefully simple lines, brilliant metal trimmings and a semi-oval basin designed for convenient use and to reduce splashing. The generous free slab surface is accentuated by the novel basin design. The trimmings include lever action Securo metal spout supply and quick draining waste fixture which assures rapid drainage. The sizes are 24x20 inches and 27x21 inches. The basin dimensions are 18x11½ inches and 21x12½ inches.

RICHARD WALBERG HONORED

Richard Walberg, president and general manager of Lindgren & Swinerton, Inc., has been elected president of Central California Chapter, Associated General Contractors of America, succeeding H. H. Hilp. Fred J. Early, Jr., was elected vice-president and W. E. Lyons, president of W. E. Lyons Construction Co., Alameda, treasurer. William E. Hague was reappointed secretary-manager.

MAMMOTH FINISHING MACHINE

What is said to be the largest finishing machine ever constructed was recently shipped to Russia by the Flexible Road Joint Machine Company of Warren, Ohio. The net weight of this giant machine is slightly under 18 tons. The screed alone weighs 3¼ tons and is equipped with five electric vibrators.

NEW SCHOOL DEDICATED

Miller & Hovind, architects of Spokane, recently inspected the new \$315,000 Moscow, Idaho, high school building and reported its completion. The firm took over the supervision of the construction following the death of Architect Charles I. Carpenter. The building was formally dedicated May 14.

INCLUDE TREES IN YOUR PLANS

DAVEY, ORIGINATOR OF TREE SURGERY, OFFERS FREE INSPECTION AND ESTIMATE.



SAN FRANCISCO Russ Bldg. SUTter 3377
Fresno Maffei Bldg.
LOS ANGELES Story Bldg. TUCKer 1929
Local phones in: Pasadena, Palo Alto, Oakland, San Rafael, San Mateo

SKILL - KNOWLEDGE - RESPONSIBILITY



PRODUCTS

VAN ARSDALE-HARRIS CO.

ENGINEERS & CONTRACTORS

ACOUSTICAL TREATMENT - INSULATION
SOUND CONTROL

FIFTH & BRANNAN STS. SAN FRANCISCO, CALIF.
TELEPHONE Garfield 3600
DIVISION

VAN ARSDALE-HARRIS LUMBER CO., INC.

USE BASALITE

Light-weight, pre-fabricated Concrete building products for floors, walls, and roofs in your next building.

BASALT ROCK COMPANY, INC.

Napa, California

NOISE CONTROL— ON TREASURE ISLAND

STATE AUDITORIUM AND RADIO STUDIOS
BELL TELEPHONE SYSTEM EXHIBIT
SAN FRANCISCO RECREATION EXHIBIT
FEDERAL BUILDING THEATER

Furnished by—

WESTERN ASBESTOS CO.

Building Materials *Mechanical Specialties*
SACRAMENTO OAKLAND
SAN FRANCISCO

CABOT'S CREOSOTE SHINGLE STAINS



Gunn, Carle & Co.

SAN FRANCISCO

20 Potrero Ave. Underhill 3436

JOSEPH MUSTO SONS-KEENAN CO.

**MARBLE
and ABRASIVES**

ONYX

836 NORTH POINT STREET
SAN FRANCISCO
82 S. GOTO STREET
LOS ANGELES



**Golden Gate Atlas
TRANSIT**

**MIX CONCRETE
AND MORTAR**

•
makes delivery of material to the job swift and inexpensive . . . minimizing the architect's supervision cost and assuring his client a dependable mix.

•
**PACIFIC COAST
AGGREGATES, Inc.**

16th and Harrison Streets
85 Second Street
San Francisco

HEATING ENGINEERS 1940 CONVENTION

The Sixth International Heating and Ventilating Exposition will be held at Cleveland, Ohio, January 22 to 26, 1940. As usual, the Exposition will be under the auspices of the American Society of Heating and Ventilating Engineers and will coincide with the 40th Annual Meeting of the Society.

During the same week also in Cleveland will be held the meetings of the National Warm Air Heating and Air Conditioning Association.

More than half of the available exhibition space in Lakeside Hall has already been engaged by 184 exhibitors. Previous expositions have been held in Philadelphia in 1930, in Cleveland in 1932, in New York in 1934, in Chicago in 1936 and in New York in 1938.

There was a total of 327 exhibitors in the last exposition, representing the largest assemblage of heating, ventilating and air conditioning equipment ever held. Registered attendance totaled 45,057. These visitors came from 61 cities and towns in 26 foreign countries, 1413 cities and towns in 48 states of the United States.

The Sixth International Heating and Ventilating Exposition—the Air Conditioning Exposition—will bring together hundreds of exhibitors showing the latest developments in heating, ventilating and air conditioning equipment.

FUNDS FOR HOME BUILDING

Belief that May and June will be the big months of the year in residential building, especially one-family homes, has inspired the Building and Loan Association affiliated with the U. S. Building & Loan League to speed up their service with only 24 to 48 hours are required between the borrower's application and his commitment.

It is estimated that \$95,000,000 will be available for lending purposes during the next two months because the monthly repayment of principal on existing mortgage loans is better than at any time in the past five years.



Doctors, lawyers, dentists, engineers, teachers— all those whose time is precious— appreciate our Bank-by-Mail service. It enables them to do their banking when most convenient, night or day. Safe. Fast. Reliable. Overnight to most points in California.

Write today...

for free Bank-by-Mail kit containing all necessary forms, return envelope and simple instructions.



Member Federal Deposit Insurance Corporation

SISALKRAFT
REG. U. S. PAT. OFF.

“More than a
building paper”

THE SISALKRAFT CO.

295 West Wacker Drive
Canal Station, Chicago, Ill.
55 New Montgomery Street
San Francisco, Calif.

**Pacific
Manufacturing
Company**

High Class Interior Finish
Quality Millwork

162 Broadway St. San Francisco
6426 McKinley Ave. Los Angeles
Garfield 7752 Thornehall 4196

1215 Seventh Street Oakland
Glensport 7850



CUSTOMERS will stress you for installing the *Wesix 49* or *ELECTRIC BATHROOM HEATER*, but only *if you install it in your own home.* Certain that you will like its form-time notes or *INSTANT RADIANT HEAT* and *QUICK CIRCULATING HEAT*, we are offering this smart new heater at *WESIX 49* in *apartments*, for personal use. Limit one heater per apartment. List price \$29.95. Please write your request or order to: 1074 WESIX BLDG., SAN FRANCISCO

WESIX
WESIX ELECTRIC HEATER CO.



HERRICK IRON WORKS

STRUCTURAL STEEL
REINFORCING STEEL

18TH AND CAMPBELL STS.
OAKLAND, CALIF.
Phone BLanchard 1767

FORDERER CORNICE WORKS

Manufacturers of
Metal Mens' Products
Interior Metal Trim
Elevator Fronts and Cases
Metal Plaster Accessories
Sanitary Metal Bases
Metal Cabinets
Bar and Rail Metal Screens
Commercial Refrigerators

388 POTRERO AVE.
San Francisco, Calif.
REBlock 4100

As the relatively high rate people are now putting money into the stock market and the comparatively low rate that are withdrawing the last five months will rise according to conservative estimates a net gain of at least \$10,000,000 in the last year would be the stock market is likely to be lined out.

CALIFORNIA'S FIESTA YEAR

Sacramento and the fifteen other counties of California's Golden Empire are making a romantic and colorful contribution to California's Fiesta Year. This is the Sacramento-Golden Empire Centennial, celebrating the 100th anniversary of the founding of Sacramento by General John A. Sutter, which brought the Golden Gate to interior California.

The Centennial began May 1 when General Sutter's Fort, situated in 1839 and now restored to its original condition, was opened. In summer the fort will be inundated by a parade team commemorating Sutter, James W. Wadsworth, discoverer of gold at Colusa, Bart Starr, General John C. Fremont, Mark Twain and other pioneer figures.

The picturesque mining town of Colusa is setting up following Martha F. Schuch's gold discovery, which started the course of a democracy and revolution in "Flowing Coins," a typical Mother Lode mining village of the gold rush days.

The Centennial is being conducted under a sponsorship designed to afford visitors from all sections of the nation an opportunity to view the celebrated pioneer and his family, as displayed upon the pages of history in an environment of the dramatic and old, while enroute to and from the Golden Gate Exposition in San Francisco.

ATTENTION, STONE CUTTERS

In Dublin is an inscription of a tombstone which reads "God and man." On the side of the stone is found the missing "a." The Scotch stone cutter estimated his stone correctly, and so earned the "a" in time around the corner. A law suit followed and the Scot won.

Pitcher

Improved
Disappearing Doors
Save 20% Space

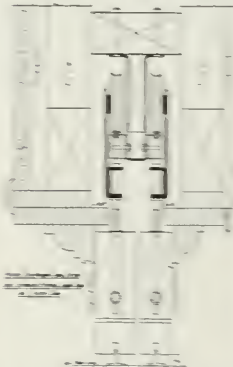

Joists with a 24" stud wall free and adjustable steel and wood track. Can be used for screen doors in connection with French doors. Send for detail drawing.

E. C. Pitcher Co.
557 Market Street
San Francisco

Donovan Automatic Awning Type Windows

Give 100% natural ventilation
and day-lighting control

UNIVERSAL WINDOW
COMPANY

Berkeley, California

"AMERICAN MARSH" Redi-Vac Vacuum Heating Pump

Send for
Bulletin 44



MINOMES MACHINERY CO.
San Francisco Los Angeles
816 Potrero St. 455 East Fourth St.



SANTA MARIA INN

Santa Maria, California

*On the Coast Highway
between*

Los Angeles and San Francisco

OVER NIGHT

or

JUST A MEAL

FRANK J. MCCOY, *Owner*

Geo. A. Thompson, *Manager*

El Encanto Hotel

Santa Barbara

*On the Riviera, above the
Old Mission*

Frank J. McCoy, *Owner*

Fred F. Pimental, *Manager*

Independent Iron Works

Structural Steel
Ornamental Iron
Steel Service Stations
Steel Tanks
Standard Steel Mill Buildings
Bridges

821 Pine Street

Oakland

Clinton Construction Co. of California

*General
Contractors*

923 Folsom Street
San Francisco
SUtter 3440

AMERICAN SALESMANSHIP

The following extract from a pamphlet issued by the Postmaster of Chicago in an endeavor to increase the sale of stamps, is a highlight in this respect:—

"It is only a few steps to the nearest mail box—write a letter. Take a little chunk of your heart and spread it over some paper; it goes, oh such a long way! Write a letter to your mother or father, to your sister, brother, sweetheart, loved ones. Are they dear to you? Prove it with a letter! Write a letter and give them the same thrill you had when you last received that same kind of a letter. Think of the joy of opening the mail box and drawing out a warm envelope enriched with old familiar handwriting! A personal letter—it's good to get one. So send one—write a letter!

"Write a letter to the aged relative who hasn't many days to live, the friend of your father, the friend of your family, the one surviving link between your own present and past. Don't wait for that dear soul to die till you act. Act now with a message of love to cheer those last few days on earth. **Sit down and start writing.**

"Write a letter to the author whose story gave you that delightful half hour last night. Write a letter to the cartoonist whose serial strip you avidly devoured this morning; to the teacher who inspired you twenty years ago; to the doctor who saved your baby's life; to your old employer to show him there was something more between you than a pay check. Be a human being—**Write a letter!**

"There's a man in public life you admire, believe in, rave about. Write him a letter of praise, or encouragement. To be 'with him in spirit' is not enough—show your spirit with a letter. We can't all be pioneers, crusaders, presidents—but we can help those brave men stay on the track and push through to a grand and glorious success if all we ever say is 'Attaboy!' **Write an 'Attaboy' letter!**

"Write a letter and give—Give praise, encouragement, interest, consideration, gratitude. You don't have to give these things; but the real letter is the one you don't have to write!"

Copper Halftones
in this issue

Made by

**Continental Engraving
& Color Plate
Co.**

156 Second Street
San Francisco

Melrose Lumber & Supply Co.

●
LUMBER AND
MILL WORK

●
46th Ave. and E. 12th St.
Oakland

Phones: FRuitvale 0240 — 0251

ANDERSON & RINGROSE

General Contractors

320 Market Street, San Francisco
Phone GARfield 2245

HIGH GRADE MILLWORK
AND INTERIOR FINISH
SASH AND DOORS

LANNOM BROS. MFG. CO.

FIFTH AND MAGNOLIA STREETS
OAKLAND, CALIFORNIA
Telephone: TEmplebar 3663

MULLEN MFG. COMPANY

BANK, STORE AND OFFICE
FIXTURES—CABINET WORK
OF GUARANTEED QUALITY
CHURCH SEATING

Office and Factory:
60-80 RAUSCH ST., Bet. 7th and 8th Sts.
San Francisco
Telephone UNDERhill 5815

G. P. W. JENSEN & SON

Building Construction

320 Market Street, San Francisco
Phone: GARfield 2444

DINWIDDIE CONSTRUCTION COMPANY • BUILDERS •

CROCKER BUILDING
SAN FRANCISCO

Carl T. Doell Co.

*Plumbing
Heating*

Plumbing Contractor
Veterans Memorial Building
Oakland

467 21ST STREET
OAKLAND

Telephone GLEncourt 8246

REGIONAL COMPETITIONS

(Concluded from Page 4)

vising Architect, Treasury Department; the Bureau of Yards and Docks, Navy Department; the Quartermaster General's Office, War Department; and the Construction Service, Veterans' Administration—to mention a few of the larger ones—are professionally staffed and eminently qualified to design any buildings the Government may require.

"During the greatly expanded public works program of recent years, the need for speed in the preparation of plans put great pressure on these Governmental agencies. Drawings were needed without delay in order that men might be put to digging and building. In the Office of the Supervising Architect, Procurement Division, Treasury Department, which is the largest architectural arm of the Government, post offices were required at the rate of one a day. Pressure of this kind eliminated both direct selection and competition; either would require time that was not available.

"In this emergency period Secretary Morgenthau called to Washington a score or more architects from various parts of the country, appointed them Consulting Architects on a yearly salary. These men brought each a fresh viewpoint and a localized knowledge of regional traditions, materials and methods of building, and our recent post offices, court and custom houses reflect these qualities. Most of these visiting consultants have returned to their private practices.

"The Regional Competition, in Secretary Morgenthau's opinion, now offers a logical, practicable means—one thoroughly in accord with democratic ideals—of bringing to the task of designing the more important of our public buildings all the architectural talent we possess. In the Office of the Supervising Architect there is a staff of expert technicians and an accumulation of knowledge as to the design of post offices, court houses, custom houses, and the like such as cannot be assembled in private practice. On the other hand, architectural ability is widely spread in America, and genius is likely to appear when opportunity calls it forth. It is Secretary Morgenthau's hope that the Regional Competition method of procedure will bring together in the public service the full power of our creative and technical ability, to the end that we shall have public buildings worthy of America."

Louis A. Simon, Procurement Division, Treasury Department, is acting as architectural adviser, preparing the programs and supervising the conduct of the competitions. Drawings called for are to be in pencil, free from elaborate rendering, thus keeping to a reasonable minimum the labor involved in the competitive effort. Copies of the Kansas program may be obtained by addressing LeRoy Barton, Acting Supervising Architect, (Architectural Competition), Procurement Division, Treasury Department, Washington, D. C.

Louis C. Dunn, Inc.

GENERAL
CONTRACTORS

Monadnock Building
San Francisco

Phone: DOUGlas 4632

Empire Construction Co., Ltd.

Builders



RUSS BUILDING
SAN FRANCISCO
Sutter 2989

Smith

Lumber Company

WHOLESALE - JOBBING - RETAIL
FACTORY AND BUILDING LUMBER
PLYWOODS - ROOFING

DISTRIBUTING YARDS

San Francisco	Oakland
•	19th Ave. &
4th & Channel	Estuary
MArket 0103	FRuitvale 3174

YOUR INQUIRIES SOLICITED

FRED W. SCHELL

**Contractor
General**

666 MISSION STREET
SAN FRANCISCO

Contractor for the Oregon City
Woolen Mills Store, San Francisco,
designed by Williams & Grimes and
illustrated in this number.

ABBOT A. HANKS, INC.
Engineers & Chemists

INSPECTING — TESTING — CONSULTING
CONCRETE • STEEL • MATERIALS
CHEMICAL AND TESTING
LABORATORIES
• RESEARCH AND INVESTIGATION •

TESTS OF STRUCTURAL MATERIALS
DESIGN OF CONCRETE MIXES
SHOP AND ERECTION INSPECTION OF
STRUCTURES AND EQUIPMENT
INVESTIGATION OF STRUCTURES
AND MATERIALS
TESTS AND INVESTIGATION OF
FOUNDATION SOILS
FIRE RESISTANCE AND INSULATION
TESTS

624 Sacramento Street, San Francisco

Phone GARfield 1164

Hunter & Hudson
Consulting Engineers

DESIGNERS OF HEATING
AIR CONDITIONING
VENTILATING AND WIRING
SYSTEMS, MECHANICAL
AND ELECTRICAL EQUIP-
MENT OF BUILDINGS

41 SUTTER STREET
ROOM 710
San Francisco California

The Fink & Schindler Co.

GENERAL CONTRACTORS

Manufacturers of com-
mercial fixtures and
interior wood work

Factory and Office
552 Brannan Street
San Francisco, Calif.

VAUGHN - G. E. WITT Co.

Manufacturers and Distributors

Pump Governors	Oil Heaters
Safety Pump Governors	Relief Valves
Automatic Gas Regulating Valves	Oil Burner Governors
Gas Burning Equipment	Oil Burners
Vacuum Pump Governors	Oil Pumping Sets
Vacuum Regulating Valves	Oil Valves
Continuous Flow Steam Traps	Oil and Steam Strainers
Thermostats	Duplex Oil Pumps
Reducing Valves	Rotary Oil Pumps
	Boiler Feed Pumps
	Water Heaters
	Boiler Feed-Water Regulators

4224-28 Hollis St., Emeryville, Oakland

THE HERMANN SAFE CO.

MANUFACTURERS AND DEALERS
OF
FIRE AND BURGLAR PROOF
SAFES AND VAULTS, SAFE-
DEPOSIT BOXES, ETC.

200 HOWARD STREET
SAN FRANCISCO
GARfield 3041 - 3042

THE MOST COMPLETE LINE
OF STEELS AND STEEL BUILD-
ING MATERIALS MADE BY A
SINGLE PRODUCER



See Sweet's Catalog File or write us for
full information.

Republic Steel Corporation
General Offices: Cleveland, Ohio

Denver, Colo. . . Continental Oil Bldg.
Los Angeles, Calif. . . Edison Bldg.
Salt Lake City, Utah . . Walker Bank Bldg.
San Francisco, Calif. . . Rialto Bldg.
Seattle, Wash. . . White-Henry-Stuart Bldg.

VERMONT MARBLE COMPANY

Producers and Finishers
of

Domestic and Imported
Marbles

San Francisco
Los Angeles
and
Tacoma, Wash.

Robert W. Hunt Company
ENGINEERS

Inspection - Tests - Consultation
Schools and Other Structures
Are Built as Designed

*When Construction Materials are
Inspected at point of Manufacture
and during Erection by*

ROBERT W. HUNT COMPANY

*Cement, Concrete, Chemical, Metallurgical,
X-Ray and Physical Laboratories*

Chicago - New York - Pittsburgh
Los Angeles - All Large Cities
San Francisco, 251 Kearny Street

JOHN CASSARETTO

—Since 1886—And Still Active—

Building Materials

READY MIX CONCRETE
ROCK - SAND - GRAVEL - LIME
CEMENT - PLASTER - MORTAR
METAL LATH - WOOD LATH
STUCCO - WIRE NETTING

Service Unexcelled

Bunkers
Sixth and Channel, San Francisco
Phones: GARfield 3176, GARfield 3177



MERCURY PRESS

We Print
The ARCHITECT and
ENGINEER

"A Thing of Beauty
Is a Joy Forever"

942 HOWARD STREET
SAN FRANCISCO

**FINE WATER COLORS
AND PAPERS
FOR ARCHITECTURAL
RENDERINGS**

**H. S. CROCKER
COMPANY, Inc.**

720 MISSION STREET
MARKET STREET AT SECOND
SAN FRANCISCO

**THE TORMEY
COMPANY**

GENERAL PAINTERS
AND DECORATORS

Phone UNderhill 1913

563 FULTON STREET
San Francisco

ARCHITECT

AND

ENGINEER

JUNE 1939

ARCHITECT AND ENGINEER

JUNE, 1939

FRED W. JONES
Editor

MARK DANIELS
Associate Editor

E. N. KIERULFF
Ass't Editor

CONSULTING BOARD
OF EDITORS

Frontispiece

Architectural—

Arthur Brown, Jr.
Frederick H. Meyer
Timothy L. Pflueger
Will G. Corlett
Harry Michelsen
John J. Donovan
Lewis P. Hobart
David C. Allison
Gordon B. Kaufmann
Harris C. Allen
Glenn Stanton
Paul R. Hunter
C. H. Alden

Engineering—

H. J. Brunnier
L. H. Nishkian
William Adrian
Wm. H. Popert
Homer N. Hadley
John J. Gould
Geo. E. Atkins

Business Manager—

L. B. Penhorwood

Advertising Manager—

J. Leslie Meek

Architects' Reports—

Vernon S. Yallop

THE ARCHITECT AND ENGINEER, INC., 68 Post Street, San Francisco, EXbrook 7182. President, K. P. Kierulff; vice-president, Frederick W. Jones; secretary, L. B. Penhorwood. Los Angeles office, 832 W. Fifth Street. Published on the 12th on each month. Entered as second class matter, November 2, 1905, at the Postoffice at San Francisco, California, under the Act of March 3, 1897. Subscriptions, United States and Pan America, \$3.00 a year; Foreign countries, \$5.00 a year; single copy \$.50.

STORE BUILDING FOR I. MAGNIN & COMPANY, LOS ANGELES
Hunt and Chambers, Architects; T. L. Pflueger, Architect of Interior

Text

ALL-MARBLE BUILDING FOR I. MAGNIN & CO., LOS ANGELES 19

STORY OF RED CEDAR AND ITS USES FOR BUILDING PURPOSES 23
Howard H. Riley, Architect

UNITED STATES FOREST SERVICE BUILDING PROGRAM, 1933-1936 35
Blanchard & Maher, Architects

ARCHITECT PREDICTS SHORT LIFE FOR STREAMLINED BUILDINGS 46
Herbert G. Wenzell

BACKSTAGE IN EUROPE'S INDUSTRIES—AN ENGINEER OBSERVES 47
F. T. Letchfield

AMERICAN ARCHITECTURE VIEWED FROM EUROPE 53
WITH THE ARCHITECTS 55

A HOUSE THAT MANY ARCHITECTS HAVE DREAMED OF BUILDING 57

CITY TRAFFIC CONGESTION AS AN ARCHITECT'S PROBLEM 59
Charles Cressey, Architect

Illustrations

Store Building for I Magnin & Co., Los Angeles 20-22
Hunt and Chambers, Architects; T. L. Pflueger, Architect of Interior

Residence of Lyman Bunting, Yakima, Wash. 23
Wm. J. Bann and Lionel H. Pries, Architects

Residence of G. L. Drake, Shelton, Wash. 25
Geo. W. Stoddard, Architect

Residence at Sheridan Beach, Seattle, Wash. 25
Wm. J. Bann, Architect

House in Rye, N. Y. 26
L. S. Beardsle, Architect

House for R. S. Lewis, Brentwood . 26
E. C. Rain, Architect

House for L. W. Ross, Seattle, Wash. 29
Smith, Carroll and Johansen, Architects

Interior Residence of Gordon Prentice, Seattle, Wash. 30
Geo. Wellington Stoddard, Architect

Buildings for United States Forest Service, Program of 1933-1938, Region 5 35-45
Blanchard & Maher, Architects

California Home of the West, Treasure Island 57
Vincent G. Rainey and Roy Chamberlain, Architects

IT LOOKS
LIKE A BUSY
SUMMER!

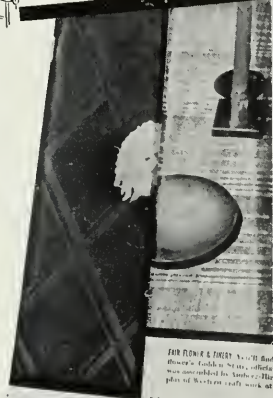

JUNE 1939 • 10 CENTS
Sunset

It's...Today's smartest tiling

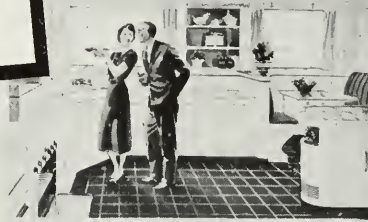

Master Kraftile's... Today's smartest tiling

MASTER KRAFTILE 6 X 9'S

IN THIS ISSUE:

A 5 TIME WINNER! In the world of...
Heads of...
Each...
For more about it, see...
NOW READ IN MORE THAN 225,000 WESTERN HOMES

Kraftile's "New Jobs Ahead" Program continues with another full-color page in Sunset magazine in June

Kraftile follows through on its campaign to stimulate new home building!

Into the homes of 225,000 higher-income *Sunset* readers — another beautiful full-color Master Kraftile advertisement!

The smart all-tile kitchen pictured was designed in Master Kraftile 6 x 9's by Frederick H. Reimers, A. I. A.

The object of this advertising is to whet people's desire for today's handsome new

kitchens and bathrooms... to spur them on into actual building. Inquiries are solicited. Folders are distributed. Cooperation of dealers with architects is arranged for.

Already this job-creating policy is producing results. Inquiries are pouring in by the hundreds — from every section of the West.

Kraftile's "New Jobs Ahead" can help make your summer a busy one, too. If interested, mail coupon below.

MAIL COUPON TODAY

KRAFTILE COMPANY, NILES, CALIFORNIA

Please send me information on your "New Jobs Ahead" program of cooperation with architects, contractors and tile dealers.

Name

Address

City State

**MASTER
KRAFTILE 6 x 9's**



Month after month *Sunset* magazine is telling the story of new Master Kraftile 6 x 9's to its family of 225,000 home-loving readers. Full-color reprints of ads sent free upon request.

Architect & Engineer

MAY, 1939

Fred W. Jones, Editor

Mark Daniels, A. I. A., Associate Editor

Edgar N. Kierulff, Assistant Editor

CONSULTING BOARD OF EDITORS

Architectural—

Arthur Brown Jr.
Frederick H. Meyer
Timothy L. Pflueger
Will G. Corlett
Harry Michelsen
John J. Donovan
Lewis P. Hobart
David C. Allison
Gordon B. Kaufmann
Harris C. Allen
Glenn Stanton
Paul R. Hunter
C. H. Alden

Engineering—

H. J. Brunnier
L. H. Nishkian
William Adrian
Wm. H. Papert
Homer N. Hadley
John J. Gould
Geo. E. Atkins

Business Manager—

L. B. Penhorwood

Advertising Manager—

J. Leslie Meek

Architects' Reports—

Vernon S. Yallop

THE ARCHITECT AND ENGINEER, INC., 68 Post Street, San Francisco, EXbrook 7182. President, K. P. Kierulff; vice-president, Frederick W. Jones; secretary, L. B. Penhorwood. Los Angeles office, 832 W. Fifth Street. Published on the 12th on each month. Entered as second class matter, November 2, 1905, at the Postoffice at San Francisco, California, under the Act of March 3, 1897. Subscriptions, United States and Pan America, \$3.00 a year; Foreign countries, \$5.00 a year; single copy, \$.50.

Frontispiece

View from North Center, Oregon State Capitol, Salem, Oregon

Text

Current Notes from the Architects of Portland, Oregon . . .	17
Glenn Stanton, A.I.A.	
Cooperation Between Architects and Building Industry . . .	35
Harry M. Michelsen, A.I.A.	
Los Angeles Union Passenger Railway Station . . .	37
Ten Questions and Answers on Radiant Heat . . .	41
C. A. Russell	
Building Codes an Aid to Fire Prevention . . .	44
Geo. W. Booth	
Industrial Research for Architect and Engineer . . .	45
J. E. Holbrook	
Progress of the Butterfly Map—The Three Variants . . .	47
B. J. S. Cahill	
Models Show 25 Years of Highway Progress . . .	51
With the Architects . . .	53

Plates and Illustrations

Recent Work of Portland, Oregon, Architects

Glenn Stanton, Guest Editor

Marquetry Murals by Aimee Gorham	17-34	Jackson Park and University Hospital	25
Building for Weisfield & Goldberg . . .	18	Lawrence, Holtford & Allyn, Architects	
Harry A. Herzog, Architect		First Church of Christ, Scientist . . .	25
Bohemian Restaurant	18	Glenn Stanton, Architect	
Lawrence, Holtford & Allyn, Architects		St. Joseph's Parochial School	26
Millinery Shop	19	Francis D. Jacobberger, Architect	
Harry A. Herzog, Architect		Weeks Memorial Hall	26
Office Building	19	Lawrence, Holtford & Allyn, Architects	
A. E. Doyle & Associate, Architects		Home for Mr. and Mrs. P. Belluschi . . .	27
Detail, Mail-Well Envelope Co.	20	A. E. Doyle & Associate, Architects	
Richard Sundeleat, Architect		Residence of Wm. Jenkins	28-29
Alterations to Heathman Hotel Garage	21	Ro L. Merin, Architect	
Inlinary, University of Oregon	21	Residence of Dr. Milton Steiner	30
Lawrence, Holtford & Allyn, Architects		Harold W. Doty, Architect	
Wilson Chambers Mortuary	22	Two Houses by Hollis Johnston and	
Richard Sundeleat, Architect		Herman Brookman	31
Chapel, Y.M.C.A. Building	22	Residence for Charles Blackburn . . .	32
Glenn Stanton, Architect		Morgan H. Hartford, Architect	
Offices and Garage	23	Residence for W. A. Healy	33
Knighon & Howell, Architects		Tucker & Wallmann, Architects	
Warehouse Building	23		
Knighon & Howell, Architects			
Garden	24		
Florence H. Gerke and Walter Gerke, Landscape Architects			
Union Passenger Station, Los Angeles	37-40		
The Butterfly Map	48		
Models of Highway Traffic	51-52		

NEW PARTITIONS TILED WITHOUT LABOR!

Kraftile Terra Cotta Wall Units are pre-tiled, one side, or both. Save on labor and building time

With Kraftile Terra Cotta Wall Units, one or both sides of a partition are "automatically" finished with a smart, semi-matt Kraftile surface.

Building time is cut accordingly. Labor costs run about one-third less.

And you've only one craft to deal with on the job.

Building owners find there's practically no upkeep cost with Kraftile partitions. An occasional cleaning with a damp cloth is all that's ever needed.

Glazed Kraftile surfaces are higher fired than even ordinary tile. Colors cannot fade. They're fireproof, steamproof and stainproof.

In 21 states and in Canada, Kraftile Terra Cotta Wall Units are making a reputation for themselves in schools, hospitals, food products plants, laboratories and public buildings. Many of these installations were made under the supervision of our Engineering and Designing Department. This experience is available to you. Mail coupon today.

KRAFTILE TERRA COTTA WALL UNITS



Kitchen by Bureau of Yards and Docks, U. S. Naval Air Base, Sunnyvale, Calif.

FREE HANDBOOK FOR ARCHITECTS AND BUILDERS

KRAFTILE COMPANY, Niles, California

Please send me without cost or obligation "Handbook of Specifications and Suggestions on Glazed Terra Cotta Wall Units"

Please have service representative call

Name _____

Address _____

City _____

State _____

EVERYONE'S IRIS

"Glamour-girls" of the Modern Garden

By **BERNIECE ASHDOWN**
Landscape Architect

HAVE you noticed what has happened to the Iris family in the last few years? It is miraculous how the posterity of the humble little "flags" of back-yard fences have become glamour-girls, parading justly in the limelight of modern gardens. In the gardens of the rich and poor alike, the Iris has its place.

Like all true aristocrats the Iris family is a very old and very dignified one. Centuries ago the Florentine Iris (*Iris florentina*) or orris root, which is the ancestor of all white bearded Irises, was used in the manufacture of perfumes. Species, including *Iris germanica*, have been extensively used in making dentifrices and cosmetics. Charles V. of France chose the Iris to be the royal emblem of France. Even today the white Iris is a frequent ornament in Mohammedan cemeteries and has a special religious significance.

Nor is it a small family; there are literally hundreds of them—Iris that like hot sun-baked places, some that grow in bogs, we ones that grow best in a little shade, others that are at home almost anywhere; Iris with huge plume-like blossoms and others that bloom in slim, graceful dignity. With a little care in selection of varieties, one may have Iris continually in bloom from early spring to late fall. Best of all they are ridiculously inexpensive. The same choice varieties which, when they were introduced a few years ago, sold rapidly at prices ranging between fifteen and fifty dollars per root, may be had today for thirty-five or fifty cents. Certainly they are just as beautiful now as they ever were. The reason for the change in price is simply that they increase rapidly and the market is flooded.

Iris come in a wide range of color, including lilac, blue, purple, yellow, white and some reddish tones, with widely varied combinations and infusing of tones. Their form, too, is widely yet intricately varied making the designation of many of the species difficult for the amateur.

There are two general classes of Irises. The first class includes the species comprised of the Bearded Irises or **pogons**, the Beardless or **apogon** types and the crested or **evansia** Irises, which all have thick rhizomes or rootstocks. The second class is made up of those having bulbs and may be divided further into three groups including: **juno** Irises, the **xiphiums** (Spanish and English) Irises and the **reticulatae**.

Among Iris enthusiasts, there are scores of amateur hybridizers. It is a simple and fascinating hobby with unlimited possibilities. The seed are best sown in the fall in a cold frame or in some other place where they can be protected until spring, when their grass-like leaves will appear. They should then be transplanted, where they may be

protected against drought and too much heat. Mulch them well for winter and they should bloom the following spring and summer. Be very critical of them as they bloom and discard at once any that do not measure up to a high standard of quality.

Like other flowers, Iris do have their eccentricities. The Bearded Iris, rather large or small, require perfect drainage and prefer lime while the Beardless varieties do best in lime-free soil. Japanese Iris (*Iris kaempferi*) like acid soil best and must have an abundance of water, especially at blooming time.



The yellow English Iris (*I. pseudacorus*) and Siberian Iris (*I. sibirica*) thrive near streams or pools where there is an abundant supply of moisture from below.

Bearded Iris may be transplanted when they are in full bloom, and some gardeners prefer to do it at this season in order to select color combinations, but the most favorable season for planting all Irises is from July until November, depending upon the blooming season and the weather. Planting at this time allows them to make ample root growth during the winter and early spring.

For best results they should be well fertilized each spring and lime should be given to the Bearded varieties. The clumps should be dug up and replanted every four years. Otherwise the roots become too crowded to produce blossoms.

Iris are comparatively free from pests and diseases. They are troubled occasionally however, by root borer. The eggs are laid on the leaves of the Iris when the borer is in the moth stage, usually in late spring. When the eggs have hatched, the young larvae eat the leaves and work their way down to the root, which in the course of time, they gradually eat away. The best method of control is to watch carefully for the larvae on the leaves; if they appear, crush them with the fingers. Some gardeners have found that by burning over the Iris lightly, the larvae are destroyed and the plants are not injured. The best way

to do this is to scatter dry weeds among the infected plants and set them on fire. The blaze should be quick, but hot enough to destroy the larvae.

Root-rot is found occasionally but is more easily controlled. Iris growing in a sunny location with well-drained, properly balanced soil (containing lime for species which require it) are seldom troubled with rot. The presence of the disease is most readily detected by the unpleasant odor from the decaying roots. If it appears, dig the plant up, remove infected parts and wash the roots in a weak solution of **potassium permanganate** (2 pts. to 1000).

In case of aphids, spray with a nicotine solution.

Below are listed a few of the most practical and least expensive Iris. This list is, of course, by no means complete, but is offered only as a foundation upon which to build a more complete collection.

In order to have blossoms early next spring plant *Iris reticulata* whose dark purple blossoms come before the crocus. Also in the rock garden, plant miniature varieties like *Iris cristata* which comes in white as well as blue.

Try also Iris of the Dutch, Spanish and English types.

Among the bearded types we have:

Los Angeles: Tall white with large full blossoms.

San Francisco: Tall white with lavender edge.

Sensation: A vivid blue Iris having a delightful fragrance.

Wambliska: Bears huge pure white flowers.

Persia: A tall richly colored variety with smoky blue standards (upper petals) and vivid purple falls (lower petals).

Dorothy Deitz: Very lovely white with blue falls.

Henri Riviere: A combination of pure lemon yellow and lilac.

Waconda: A fine fuchsia red for those who want sensational color.

Nebraska: Strong healthy plant, bearing deep yellow blossoms.

Freida Mohr: A delicate lavender pink.

California Gold: A tall deep yellow variety.

VENETIAN BLINDS

Light and Air
Without Draft or Glare



Gunn, Carle & Co.

SAN FRANCISCO

20 Potrero Ave. UNDERHILL 5480

VARIETY *is the* Spice of Design

The Cedar Shingle is the most flexible of all roofing materials and flexible, too, for side-wall construction.

We show here a few examples in which the architect has used his creative craftsmanship with marked effect.

With Cedar Shingles, period designs may be carried to completion with a roof that's befitting.

Coupled with these architectural virtues, Red Cedar Shingles are enduring, architecturally beautiful and possess excellent insulating qualities.



This Handbook is compiled by a wood technologist and a shingle applicator. Its 100 pages detail and illustrate the uses and application of Certigrade officially inspected Red Cedar Shingles—complete technical data also. Mailed free on request. Write Red Cedar Shingle Bureau, Seattle, U. S. A., or Vancouver, B. C., Canada.



FOR GUARANTEED GRADES AND QUALITY, SPECIFY—

CERTIGRADE *Red Cedar* Shingles

CERTIGRADE
SHINGLES
BY ALLIANCE

GENUINE
CEDAR
NOT
IMITATION

Certigrades pass official inspection for grade and quality. U. S. Government standards.

Sold only by established lumber dealers

YULE COLORADO Marble Lends Beauty to Design



NEW HOME OF I. MAGNIN & CO., LOS ANGELES

Hunt & Chambers, Exterior Architects

Timothy L. Pfueger, Interior Architect

Wm. Simpson Construction Co., Contractors

Yule Colorado WHITE MARBLE

dominates the exterior while a variety of marble textures give warmth, color and richness to the interior. Yule Colorado quarried, fabricated and erected, and interior marble finished and installed by —

VERMONT MARBLE COMPANY

727 West 7th St.
LOS ANGELES

525 Market St.
SAN FRANCISCO

1120 East D St.
TACOMA



R. B. WILLS, ARCHITECT

WESTERN RED CEDAR

Nature HAS ENDOWED CEDAR SIDING WITH AMAZING QUALITIES

To meet the exacting requirements of external appearance and economical utility Western Red Cedar Siding offers an ideal choice. The bevel cut creates deep shadow lines which break up flat surfaces and soften horizontal lines. Because Cedar has a minimum of shrinkage, Siding can be mitered at the corners, preserving a sweep of line most pleasing to the eye. Cedar Siding is available in smooth-planed or rough-sawn finish. Each has a high degree of paintability, marked by freedom from pitch.

With its extreme durability and its natural beauty, Western Red Cedar Siding also has high insulation value. Cedar Siding will give long years of unflinching service with a minimum of upkeep cost.

★ Information for your files mailed on request

We have available for architects a complete information series detailing with working drawings and illustrating examples of the uses and application of Western Red Cedar Siding. We will gladly mail you this A. I. A. File No. 19-A on request. Address Western Red Cedar Lumber, 5566 Stuart Building, Seattle, Wash.

STANDARD PRODUCTS ALWAYS UNDER THESE TRADE MARKS

Aloha Master Made
Eagle Brand Miller Cedar
Highland Cedar The Surety Bond
Maltese Cross Tree Life
★ ★ Weyerhaeuser ★ ★

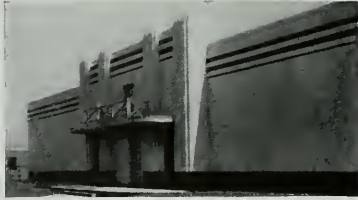

"WINDOWLESS" INDUSTRIAL BUILDING with Complete Air Conditioning CONTROLLED "BY JOHNSON"

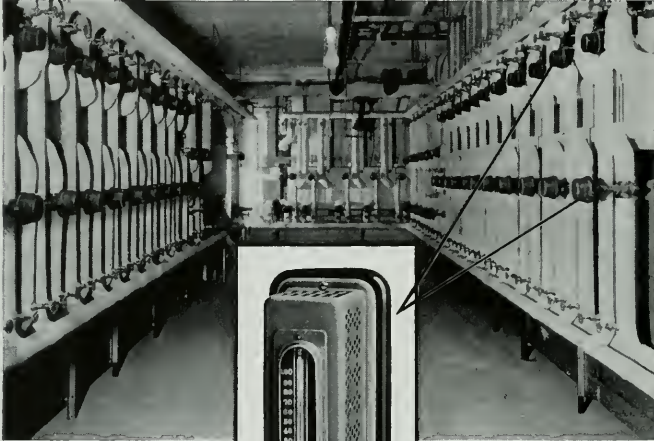

Office and Research Building
for National Aluminate Corp.,
Chicago, Illinois

Ambrose C. Cramer, Inc.,
Architects; Robert E. Hattis,
Consulting Engineer, Chicago



THE "HEATING"
CONTROLLER

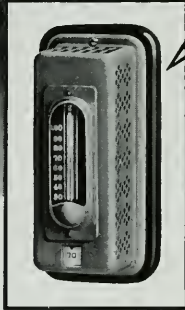

THE "BRAIN" OF
THE SYSTEM



THE "COOLING"
CONTROLLER

Pictured above is the "control room", showing Johnson valves on the heating and cooling coils in the individual ducts which serve each room. In this windowless building, the occupants of each space determine the exact temperature which they desire. Then, each of the 61 Johnson room thermostats, the "brain" of this complete air conditioning system, calls for heating or cooling effect, automatically maintains the required temperature. . . The *adjustable sensitivity* of these Johnson "proportioning type" room thermostats is the distinctive feature. Each instrument is precisely balanced, *on the job*, with respect to the heating and cooling capacity of the units which it controls. The exact requirements of each room are met, without "hunting" or fluctuation of temperature. . . Each room thermostat controls two valves; a direct-acting, diaphragm-operated valve (the "heating" controller) for the hot water heating coil, and a reverse-acting valve (the "cooling" controller) for the cold water cooling coil. The cold water valves are "long-neck" pattern, allowing ample clearance for piping and pipe covering. When any room is up to temperature, its "heating valve" closes gradually. If complete closing does not allow the room to cool to the desired temperature, the "cooling valve" begins to open.

ALSO: JOHNSON CONTROL FOR INDUSTRIAL PROCESSES

JOHNSON SERVICE COMPANY

MILWAUKEE, WIS., AND DIRECT BRANCH OFFICES IN PRINCIPAL CITIES

SMEARING THE PROFESSION

An architect recently excused himself for sleeping late on Sunday morning by explaining that it was the triumph of mind over mattress to be a step behind the present.

That is the sort of advertisement the profession has had—and plenty of it.

By it the public has been convinced—to a greater extent than we all enjoy—that architecture up until the great awakening after the World War was wrong; and by inference that all fees paid architects previous to that time were doubtful investments.

The public mind—untutored but persistent—goes on to conclude that if architecture previous to 1919 was not so hot (and that covers a lot of territory) maybe it has not been so hot since that time.

At any rate advertising of architecture by architects has been detrimental. The illusion of aesthetic infallibility with which a trusting public once endowed the profession has been shattered. The public is not now averse to entrusting its commercial work to engineers, its residential to realtors.

Is it not now time to make our taunts in private and not permit a willing press to exploit our processes of smearing the profession?

The profession of architecture long ago, in search of the highest principles to govern its behavior, adopted an attitude of isolation and strict professional ethics. This attitude has done much toward establishing its honesty and good motives, but little toward increasing its revenue.

Now, no art is healthy that does not have healthy financial returns. Since therefore the honesty of the profession has been established, it appears to be pertinent for its members to give more persistent thought to the matter of selling its usefulness to the public.

Architecture has in recent years been done by argumentation between architects which has done little to improve its reputation. Architects have printed in conspicuous places the statement that their profession up to within a couple of decades of the present has been misguided, shackled by ancient formulae, stuffy and pointless. They have discovered that newspapers and magazines (smelling the delicious aroma of controversy) will publish all they write sneering at the work of other architects and belittling the traditions of architecture. Why not confine our public discussion as to whether architecture should be this or that to arguments erected in concrete, brick and stone?

Then we will be in a position to apply our forensic and literary abilities to the job of emphasizing the public service which the architectural profession is able to offer—for which their is no substitute.—The Federal Architect.

**THE MOST IMPORTANT
STORE FRONT CON-
STRUCTION PRINCIPLE**

RESILIENCY



* EXTRUDED SASH



* ROLLED SASH

KAWNEER Store Front construction is not only up-to-date and attractive—it is also efficiently designed to give lasting, trouble-free service. That is why so many prominent architects and builders specify Kawneer Resilient Store Front Sash.

They know that this superior resilient construction allows for the inevitable movement of plate glass, yet holds it in a secure and powerful grip—regardless of variations in thickness. Pressure is distributed evenly along the glass surface. Looseness and rattling are eliminated and the possibilities of glass breakage reduced to an absolute minimum.

Kawneer Store Front Sash is available in either resilient extruded (with a choice of three attractive face pieces) or rolled construction—in either aluminized aluminum or architectural bronze. In addition, the Kawneer line includes complete metal construction such as transom bars, hood, recessed and concealed awning bars, entrance doors, pilasters, mouldings, sign letters and special metal work. Complete information will be sent on request. The Kawneer Company, BERKELEY, CALIF.

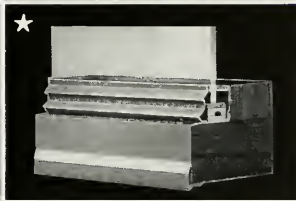
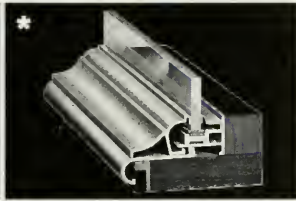
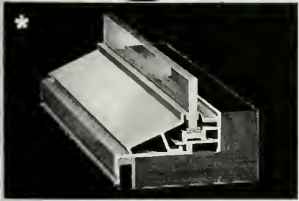

FOUNDED IN 1905—
BY A PRACTICING ARCHITECT

Kawneer

Rustless Metal Store Fronts • Doors • Sealair Windows • Architectural Metal Work

For data see catalogs in SWEET'S; or write The Kawneer Company, 67 Niles, Michigan, New York, Chicago, or Berkeley, Calif.

Dealers in principal cities.

Painting?

LET THIS NEW
Primer

SAVE YOU ONE
COAT OF PAINT

With the new Fuller Pure Prepared Primer, successful two-coat painting becomes a fact! Yes, two coats will outlast three applied the old way. For, unlike old-fashioned paint primers, this new Fuller primer penetrates evenly . . . provides a protective seal of uniform tensile strength, free from weak spots . . . and that means less chance of cracking or flaking. Ask your Fuller Paint dealer, or your painter, all about it!

PURE PREPARED
PRIMER

**FULLER
PAINTS**
they last

What's the difference between Advertising and Selling?

We might as well say — what's the difference between ham and eggs? There may be a difference; but you can't get as much satisfaction with either of them separately as you can in combination.

Advertising and selling work together like ham and eggs—when both are the best—you get the best results.

In combination with your best selling efforts—for best results—use the best advertising medium in the West Coast building field . . . now in its thirty-third year of continuous publication, read and respected by architects and professional building men everywhere.

THE **ARCHITECT and ENGINEER**

68 POST STREET
SAN FRANCISCO

•
Publishers of ARCHITECTS REPORTS
•

*Sponsored and endorsed by the State Association
of California Architects.*

**STREAMLINED
CONSTRUCTION
DEMANDS**

W A S T E D

**IN
CONCRETE
HARDENING**



**GOLDEN GATE
24
HOUR
PORTLAND CEMENT**

*This New
20 page*
**MANUAL TELLS
HOW TO GET IT**

If you have not received
a copy your request
will be promptly
complied with.

A "Pacific" Product
sold by Building
Materials Dealers.



Produced by

SAN FRANCISCO
LOS ANGELES

PACIFIC PORTLAND CEMENT COMPANY

PORTLAND
SEATTLE

COASTWIDE SERVICE

GLAZED KRAFTILE WALL UNITS FOR FIRE HOUSE



APPARATUS ROOM OF ENGINE 20, SAN FRANCISCO . . . WALLS ARE TWO TONES OF BLUE.

SO many practical advantages resulted from the installation of glazed Kraftile wall units in the apparatus room of San Francisco's fire house No. 20 that when the building was demolished to make way for Golden Gate Bridge approaches, similar construction was adopted in the new home of "No. 20," on the south side of Greenwich Street east of Steiner Street.

The demolished building contained the first installation of such walls in San Francisco fire house construction and so proved their practicability during their five years that the city's Bureau of Architecture specified glazed Kraftile wall units in the reconstruction job.

Apparatus room walls are a problem because of wet equipment, exhaust gases, need of good light. Doors stand open most of the time.

Besides the advantages of construction, ease of maintenance and economy of upkeep are important factors resulting from installation of such wall units.

The home of "No. 20," with gleaming and colorful walls and immaculate apparatus, is a creditable addition to the neighborhood. Contrasting with the shiny red and glistening brass of the apparatus, the walls are done in two attractive shades of blue. Kraftile's Tahoe Blue was specified for the base and trim while the lighter Cascade Blue decorates the walls.

Kraftile glazed wall units of two-inch thickness are made a part of the exterior brick walls. For partitions, four-inch thickness was used for fire-proofing the steel columns. Masonry contractor was Wm. Rainey & Son.

Our MILLER BRAND

**MILLER
CEDAR**

Defies the weather—lasts for ever!

Manufacturers of Western Red Cedar Beveled and Bungalow Siding, special detailed Siding, selected Paneling, Mouldings and Trim, and MILLER BRAND Certigrade Red Cedar Shingles.

Sales Representatives:

A. B. Johnson Lumber Co., Fife Bldg., San Francisco, Calif.

A. B. Johnson Lumber Co., 726 Petroleum Securities Bldg., Los Angeles, Calif.

Earl V. Smith Lumber Co., Walker Bank Bldg., Salt Lake City, Utah.

Mills and Sales Offices:

E. C. MILLER CEDAR LUMBER COMPANY
Aberdeen, Washington

New Attractive Doorways

EXECUTED IN BRILLIANT

U·S·S STAINLESS STEEL

DOORWAYS are but one of many building uses for which no other metal is so practical and so economical as stainless steel.

No other metal is so easy to clean and to keep clean. So free from corrosion, staining and pitting. So useful for parts inaccessible to cleaning—such as grilles, gates, marquees, and towers.

U·S·S Stainless hardware eliminates expensive and laborious polishing. It wears indefinitely. It should never need replacement. There is no known limit to its useful life.

Per year of service, U·S·S Stainless Steel is for many uses the least expensive metal you can use. Write today for complete data.



SANTA MONICA. On the Rex Cafe and Cocktail Lounge, doors and marquee of U·S·S Stainless Steel give passers-by a quick impression of the clean, efficient service they will receive within. As a business builder, stainless is without an equal, because it always presents a shining, "come hither" smile.

OKLAHOMA CITY. These U·S·S Stainless doorways on the First National Bank Building create an air of quiet dignity. Strictly modern, yet strong and substantial, they are perfectly attuned to today's banking requirements. They will last a lifetime, will require little cleaning and no polishing.

NEW YORK. In the Earl Carroll Theatre, doorways and decorative trim of U·S·S Stainless Steel provide an atmosphere of rich elegance—a highly appropriate setting for the slogan "Through these portals pass America's most beautiful girls."

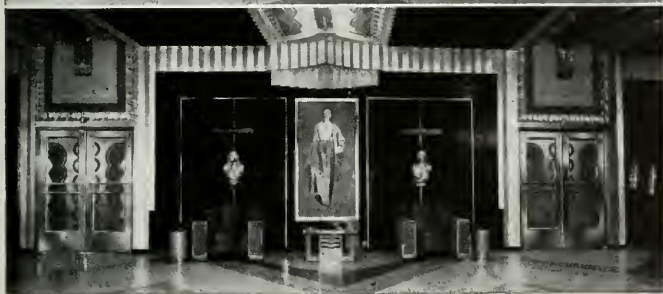

STAINLESS STEEL

COLUMBIA STEEL COMPANY, San Francisco, Pacific Coast Distributors of U·S·S Stainless Steel
Produced by

AMERICAN STEEL & WIRE COMPANY, Cleveland, Chicago and New York
CARNEGIE-ILLINOIS STEEL CORPORATION, Pittsburgh and Chicago
NATIONAL TUBE COMPANY, Pittsburgh

Scully Steel Products Company, Chicago, Warehouse Distributors • United States Steel Products Company, New York, Export Distributors

UNITED STATES STEEL



**ONE OF MANY FOREST SERVICE BUILDING UNITS
WHICH WE FURNISHED IN 1933 - 1936**

GRADE MARKED LUMBER

MILLWORK

DOUGLAS FIR PLYWOOD

CONCRETE FORM PANELS

INSULATING BUILDING BOARDS

MASONITE PRESWOOD

"CERTIGRADE" RED CEDAR SHINGLES

REDWOOD SHINGLES

PONDEROSA PINE

REDWOOD

HOMOSOTE

"GOODS OF THE WOODS"



E. K. WOOD LUMBER CO.

LOS ANGELES

SAN FRANCISCO

OAKLAND

4701 SANTA FE

1 DRUMM ST.

FREDERICK & KING

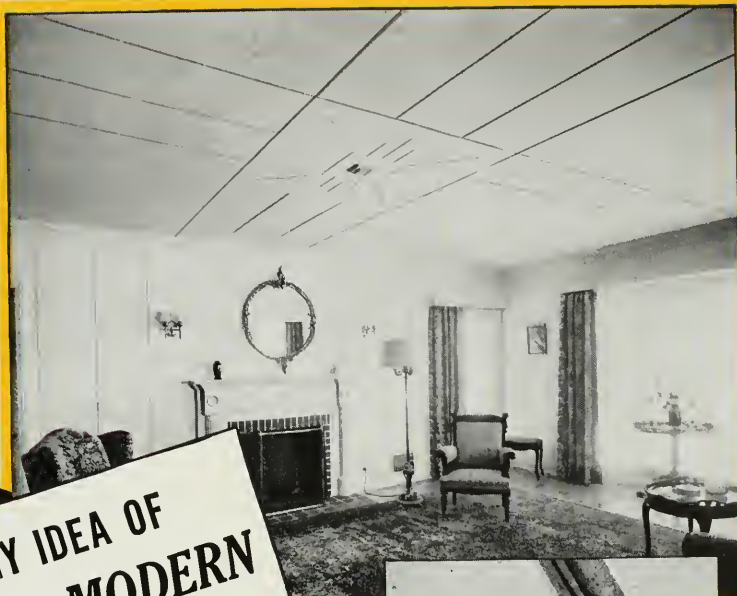

**"THIS IS MY IDEA OF
BEAUTIFUL, MODERN
INTERIOR FINISH
AND IT INSULATES, TOO!"**

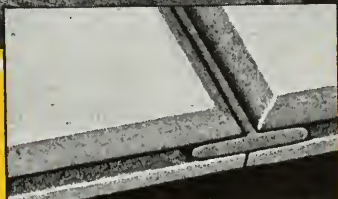

See how the spline joint prevents all open cracks, with only the beautifully detailed edges exposed. Celotex key joint units go up fast—save days in the completion of important jobs.

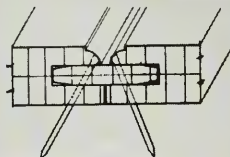

Nail heads are hidden in the depth and shadow of the joint, getting a good grip on the material and studs. Large spans require intermediate nailing.

**CELOTEX KEY JOINT UNIT
BUILDS AS IT BUILDS—PRO-
VIDES FULL 3/4-INCH INSULATION**

Women are delighted with the beautiful effects achieved with new Celotex key joint interiors. And architects use this economical method of combining insulation and interior finish in one material.

Celotex key joint units design as they build—only five sizes are required to make possible an infinite variety of

patterns. All edges of each unit come already prepared for a spline, so there need be no cutting or sawing except at room borders and openings. And because the material is a full 3/4" thick, it is applied direct to studding without special framing or grounds.

Let us send you all the facts on this brand new kind of insulating interior finish, and learn how it speeds completion of a house without sacrifice of either beauty or efficiency! Mail the coupon!

The word Celotex is a brand name identifying a group of products marketed by The Celotex Corporation.

CELOTEX

REG. U. S. PAT. OFF.

KEY JOINT UNITS

Sales Distributors Throughout the World

AE 6-39

THE CELOTEX CORPORATION
919 N. Michigan Avenue, Chicago, Ill.
Please send my FREE copy of your new booklet on
Celotex key joint units, with diagrams.

Name.....
Address.....
City.....
County..... State.....



Standard 32-foot span timber roof truss for warehouse at Forest Service Experimental Range Station, Strawberry, Calif. 2 1/2" TECO split ring connectors at all joints.

TIMBER ROOF TRUSSES WITH TECO SPLIT RINGS

ARE NOW STANDARD WITH THE U. S. FOREST SERVICE—REGION 5

IN 1938, 115 LOOKOUT TOWERS OF 118 BUILT BY THE FOREST SERVICE IN THE UNITED STATES, WERE CONSTRUCTED OF TIMBER WITH TECO CONNECTORS.

Not only roof trusses in spans up to 200 feet and lookout towers in heights up to 120 feet, but highway bridges, trestles, grandstands and numerous other types of structures require the efficiency and lower cost of connector design to meet the modern trends of present-day construction.

The advantages of more economical timber construction—through the use of TECO connectors—are available to all designing architects and engineers. Suggestions for TECO joint details, complete technical and descriptive data is supplied free on request.

TIMBER ENGINEERING COMPANY OF CALIFORNIA

85 Second Street • San Francisco

Agents in principal cities of the Western United States

BUSY TIMES FOR ENGINEERS

Engineers have some busy days ahead, if announcements of meetings, banquets, etc., mean anything. Their activities start July 13 when the San Francisco Engineering Council will celebrate Engineer's Day at the Golden Gate International Exposition. Starting at 10:30 A. M. with a band concert at the Exposition Stadium, the day will be most eventful with an address on "Engineering Contributions to Human Welfare," by former President Herbert Hoover, followed by an inspection of industrial and engineering exhibits and concluding with a banquet in the California Building at 6:00 P. M. and an address on "International Engineering Relationships," by Professor Rodolfo E. Ballester, Director of the Argentine Bureau of Irrigation. Professor Ballester is a fluent and forceful speaker and ranks among the leading engineers of the day.

From July 26 to 29th the American Society of Civil Engineers will hold its 69th annual convention in San Francisco and Bay District. This gathering of engineers from all sections of the United States will be outstanding in professional interest and entertainment. The Exposition management has set aside Thursday, July 27 as "Civil Engineers' Day" with a banquet on the Island as the big attraction. An elaborate floor show will be featured. The preceding day there will be a formal dinner in San Francisco.

At the various meetings to be held during the convention technical papers will be read by leading engi-

neers on subjects of interest to the several sections. George W. Pracy is general chairman of the convention. Dean S. B. Morris is in charge of the program while Ralph Wadsworth is arranging the excursions, which will include visits to the San Francisco sewage plant and the Peninsula works of the Water Department. I. C. Steel is in charge of the Treasure Island celebration. Other committee heads include Ed Knapik, W. H. Popert, Prof. Hyde, Dr. N. A. Bowers and T. J. Corwin, Jr.

ARIZONA CHAPTER HOLDS EXHIBITION

Arizona Chapter, A. I. A., recently conducted its first Architectural Show. The exhibition of photographs, together with a few sketches, was hung in Tucson at the civic art gallery and was open to the public. It will be shown later in Phoenix.

As a part of the show an educational exhibit consisting of sample plans and specifications, contract forms and other A. I. A. documents and a number of posters explained the value of employing an architect and exhorted the public to consult him.

President Mahoney has stimulated interest in the Chapter meetings by calling upon various members to speak upon problems of practice, embracing the following subjects: "Contractor and What He Expects of the Architect," "The Architect and the Structural Engineer," and "Examination of an Applicant for Registration."

WANTED—Copies of February and April, 1938, ARCHITECT and ENGINEER. Communicate with this office.

Compare it with other glasses for **FREEDOM** from **DISTORTION**...

*Pennvernon
leads them
all!*



MAKE THIS TEST.
*Compare a sizable sample of
Pennvernon with similar
samples of other sheet glasses.
Inspect the samples from all
angles. You will find that
Pennvernon is freer from
distorting defects.*



ANOTHER PROOF: Stand ten feet away from a window glazed with Pennvernon. Look through it, from all angles, at the scene beyond. Then do the same with a window glazed with any other sheet glass. And you will see that the view is clearer, more sharply outlined, more natural in color when seen through the Pennvernon Window.

ONE important reason why architects, builders and contractors in increasing numbers are specifying Pennvernon Window Glass for the windows of homes and public buildings, is that Pennvernon approaches more nearly than other sheet glasses the perfect freedom from distorting defects found in fine plate glass.

In making this claim, we believe we are telling the simple truth. If you don't accept our unsupported statement. Prove for yourself that Pennvernon Window Glass is freer from distortion by making the actual comparisons described on this page.

Pennvernon's unusual freedom from distorting defects, like its greater brilliance of finish on both sides of the sheet, its more durable surfaces and better color transmission properties, is the result of the special Pennvernon manufacturing

process and the purity of Pennvernon ingredients.

Pennvernon is available in single and double strength, and in thicknesses of 3-16" and 7-32".

Distributed by
W. P. FULLER & CO.

Branches and dealers
throughout the West.

Specify **PENNVERNON
WINDOW GLASS**



STORE BUILDING FOR I. MAGNIN & COMPANY, LOS ANGELES, CALIFORNIA
Hunt & Chambers, Architects; T. L. Pflueger, Architect of Interior

Photo by Parker

ALL - MARBLE BUILDING FOR I. MAGNIN & CO., LOS ANGELES

COMMERCIAL buildings of marble are so rare that when a structure built of this material is designed more than ordinary interest develops. A recent example is the I. Magnin store building in Los Angeles, the exterior of which is Yule Colorado white marble with a black granite base. True, we are accustomed to seeing many of our monumental buildings clothed in this beautiful product of Mother Nature—for example, the Lincoln Memorial and the Tomb of the Unknown Soldier, in Washington, but the appearance of marble on large commercial structures is to a more or less extent a rarity, a rather deplorable situation one must admit. And, considering the permanence and beauty of the material, one wonders why.

Of modern classic design, the six-story structure occupies the southeast corner of Wilshire Boulevard and New Hampshire Avenue, heart of the swank shopping district of Los Angeles. This symphony of beauty may well be classed as a memorial of one achievement in 1939.

We are indebted to Walter Fassett of the Vermont Marble Company, whose materials made this building possible, for the following interesting data:

"The quarries from which this exterior marble was taken are 10,000 feet above sea level in the State of Colorado, while in the town of Marble, at an elevation of 8,000 feet, are located the mills and shops. An electric road runs between the quarries and mills, carrying men to and from work and transporting blocks down to the lower level. A hydro-electric station operated by mountain streams supplies the power for this road as well as for machinery and lights. The exposed surface of the deposit is nearly a mile in length and the vein dips into the mountain at an angle of 45 degrees.

"Yule marble is very hard and of exceptional purity as it contains no foreign substances in sufficient quantity to cause appreciable discoloration or disintegration. The low rate of absorption is of signal importance for it is a fact accepted without argument that the less water a building stone absorbs the longer it will endure. Something over 350 tons of marble went into the exterior walls of the I. Magnin building."

Marble dominates both the exterior and interior of the building. Tennessee marble covers the main floor while the walls are veneered with a French imported product called Rose de Brignolles. There are some 9,000 square feet used to cover the walls of the main store, believed to be the largest installation of this marble in a single room in the country.

Large quantities of other grades of marble have been imported from France, Italy, Belgium and Norway, also onyx from Mexico.

The entire store was planned and decorated from a feminine viewpoint, soft colors, fragile fabrics in delicate colorings, intimate salons, and exquisite appointments forming an ensemble of impressive refinement and beauty.

Myron Hunt and H. C. Chambers designed the building proper while Timothy L. Pflueger supervised the interior.—F. W. J.



ENTRANCE DETAIL, STORE BUILDING FOR I. MAGNIN & COMPANY, LOS ANGELES
Hunt & Chambers, Architects; T. L. Pflueger, Architect of Interior



STORE BUILDING FOR I. MAGNIN & COMPANY, LOS ANGELES
Hunt & Chambers, Architects; Timothy L. Pflueger, Architect of Interior

ELEVATOR VESTIBULE



LINGERIE SALON, BUILDING
FOR I. MAGNIN & CO., LOS
ANGELES, CALIFORNIA

Hunt & Chambers, Architects
T. L. Pflueger, Architect of Interior

Plaster work throughout by Reischel &
Martin

Illustrations on this page courtesy of
California Plasterer



FUR SALON, STORE BUILDING
FOR I. MAGNIN & CO., LOS
ANGELES, CALIFORNIA

Hunt & Chambers, Architects
T. L. Pflueger, Architect of Interior

Black and White Mural by Jean Dunand
Other artists who contributed to the
decorative scheme of the building: Jessie
Arms Botke, Esther Bruton and Marie
Rosendich.



RESIDENCE OF LYMAN BUNTING, YAKIMA, WASHINGTON

William J. Bain and Lionel H. Pries, Architects

Untreated cedar siding left to weather in natural lines

Photo by Ben Wildman

STORY OF RED CEDAR AND ITS USES FOR BUILDING PURPOSES

By Howard H. Riley, Architect

THE use of cedar for building purposes is closely associated with the history and development of the human race. The durability and beauty of this fine wood was recognized and mentioned in man's earliest records. Western Red Cedar is well qualified to carry on these traditions and this species is particularly adapted for the production of fine lumber and shingles. The growing popularity of red cedar accounts, in a measure, for the liberal space taken here to describe and picture recent examples of the uses of the wood.

The botanical range of the red cedar tree extends from Southern Alaska to Southern Oregon and as far east as Montana. It reaches its maximum development on the Pacific slope. The cedar forms part of the dense stands of timber and grows in groups or singly scattered among the Douglas fir, Western hemlock and spruce. It reaches its greatest size and is most numerous in areas having a large amount of moisture in the sub soil. Trees 700 to 800 years old and up to sixteen feet in diameter are not uncommon. While these trees reach great dimensions their growth is slow and generally uniform.

This slow growth results in small annular bands with relatively narrow summer rings. The



AN UNUSUAL STAND OF 10 FT. TREES OF THE FINEST QUALITY RED CEDAR, SHOWING SIXTY FEET OF CLEAR TRUNKS

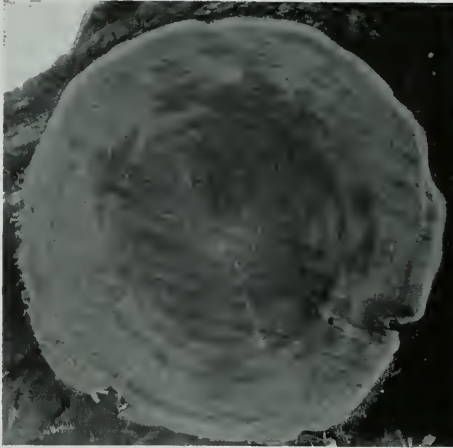

END VIEW OF A WESTERN RED CEDAR LOG, SHOWING THE NARROW SAPWOOD RING AND VARIATION IN COLOR OF THE WOOD. MORE THAN 99 PER CENT OF THIS HUGE TREE WAS DURABLE HEARTWOOD.

THE HEARTWOOD OF WESTERN RED CEDAR IS VERY IMPERMEABLE TO LIQUIDS, AND IT IS DIFFICULT TO INJECT OILY MATERIALS INTO THE WOOD. THIS REFRACTORY BEHAVIOR MAY FURTHER EXPLAIN ITS ABILITY TO GIVE GOOD SERVICE UNDER ADVERSE CONDITIONS.



Copyright Darius Kinsey
 FELLING A CEDAR 76 FEET IN CIRCUMFERENCE MEASURED 1½ FEET FROM THE GROUND. SUPPOSED TO HAVE BEEN LARGEST TREE IN WASHINGTON

summer growth is dense and also darker in color than the winter portion of the band. These trees have a fine, regular cell structure and are characteristically straight and even grained.

The larger trees are remarkably free from knots and as a result lumber of unusual size and texture may be sawn, while the smaller timber is equally valuable as fence posts or poles. The smaller logs, when sawn, produce a lumber that is ideal for some interior treatments.

Pitch and resin is absent in the cellular structure of this specie but they contain a phenolic compound in sufficient quantities to discourage the growth of wood destroying fungi. This is one of the chief reasons for this wood's resistance to decay and rot.

BAN TO VERMIN AND INSECTS

The aroma of cedar is peculiar unto itself, and while pleasant to human beings, it has well proved its worth as a repellent to vermin and insects. In an unpainted state it is an excellent insurance against the destruction of clothing by moths.

A cedar log shows from ¾" to 1½" of sapwood on the exterior which is invariably white in color and is eliminated in the manufacture of the higher grade of lumber and shingles. The heart wood may vary in color from a light yellow to a dark reddish brown. Very little is known as to the causes of this variation in color, but it is presumably due to varying physical and chemical properties of the soil in which the tree has grown. The amount of moisture also seems to have some effect on the amount of coloring matter present. The amount of color or lack of it has no bearing on the durability or usefulness of this wood. It does, however, add interest and beauty when left in a natural state or when treated with a finish that brings out this natural variation in colors.

Cedar, when seasoned, is light in weight and has a low coefficient of expansion and contraction with changes in moisture content. In drying, the shrinkage of vertical grain lumber or shingles is less than half that of slash grain. But this shrinkage is much less than the average soft woods. End shrinkage is unknown and this, combined with its ability to withstand warping, assures tight and lasting joints even under ad-



RESIDENCE OF G. L. DRAKE, SHELTON, WASHINGTON
George W. Stoddard, Architect
Double coursed shingle side-walls



RESIDENCE AT SHERIDAN BEACH, SEATTLE, WASHINGTON
William J. Bain, Architect
Horizontal siding with V-joint vertical board siding on entrance gable



HOUSE IN RYE, NEW YORK

L. S. Beardsle, Architect

An excellent example of the staggered effect on sidewalls with cedar shingles



HOUSE OF R. H. LEWIS, BRENTWOOD, CALIFORNIA

E. C. Rahn, Architect

A pleasing combination of cedar siding and shingles

verse conditions. Lumber is sawn in the conventional manner, and of course the result is part vertical grain and part slash grain.

VERTICAL GRAIN FOR EXTERIOR TRIM

The vertical grain is used for all of the higher grades of lumber and exterior trim and finish. Slash grain has many uses for which it is the ideal building material. This is particularly true in the construction of silos, tanks, and similar structures where water or other liquids come in direct contact with this wood.

Slash grain, especially that coming from the smaller logs that show a few knots, produces beautiful panelling for certain architectural effects. This slash grain offers an interesting variation of pattern in grain between the summer and winter woods, and unusual color combinations.

The value of insulation in present day construction is being given the care and study it deserves. It is necessary for the proper functioning of air condition plants, fuel economy and general comfort for those occupying the building. Wood in general, because of its cellular structure, ranks high in insulation value per unit of thickness when compared to other commonly used materials. Exhaustive tests have shown that cedar has an appreciable advantage over other commercially available woods.

One of the numerous tests made with this material was conducted by the College of Forestry of the University of Washington on a section of shingles laid $5\frac{1}{2}$ " to the weather on solid sheathing. This test showed a heat transmission rate of 0.28 B. T. U's. per degree Fahrenheit of temperature difference below and above the roof.

Workability is always of prime importance in the manufacture of any raw material. When properly seasoned, cedar comes from the planer or shaper with a smooth and even surface. The softness and even texture make this an excellent general wood working material and it meets the needs for the exacting work of the pattern maker.

Many beautiful examples of the wood carvers' art have been created using cedar as a material. For sand blasting or etched stenciled designs it is unsurpassed.



LEFT: FLAT GRAIN WESTERN RED CEDAR SHOWING ITS INTERESTING PATTERN AND THE SHARP CONTRAST BETWEEN THE NARROW DARK SUMMERWOOD AND THE LIGHT SPRINGWOOD IN THE ANNULAR GROWTH RING

RIGHT: VERTICAL GRAIN WESTERN RED CEDAR SHOWING THE NATURAL CLEARNESS AND FINE, EVEN GRAIN CHARACTERISTIC OF THIS WOOD

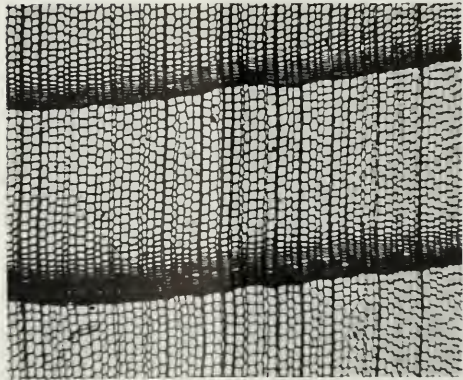

CROSS SECTION OF RED CEDAR SHINGLE SHOWING AIR-FILLED HEAT INSULATING CELLS—THERE ARE SEVERAL MILLION IN EVERY CUBIC INCH OF WESTERN RED CEDAR WOOD. DARK HORIZONTAL LINES ARE WOOD RAYS THAT REINFORCE AGAINST SPLITTING. VERTICAL DARK LINES MARK THE LIMITS OF ONE ANNUAL RING, MAGNIFIED 40 TIMES



RESIDENCE AT SHERIDAN BEACH, SEATTLE, WASHINGTON

William J. Bain, Architect

Vertical and horizontal cedar siding



NAILS SHOULD NEVER BE MORE THAN 2 INCHES ABOVE THE BUTT-LINE OF THE NEXT COURSE

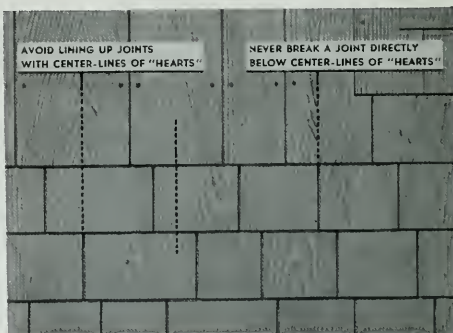

FLAT GRAIN SHINGLES IN GRADES NO. 2 AND NO. 3 SHOULD BE PROPERLY APPLIED AS SHOWN ABOVE

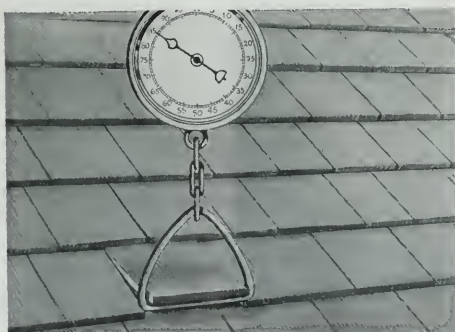

A FORCE OF 85 POUNDS IS REQUIRED BEFORE A PROPERLY NAILED CEDAR SHINGLE OF AVERAGE WIDTH CAN BE PULLED FROM A ROOF, SHOWING REAL WIND RESISTANCE

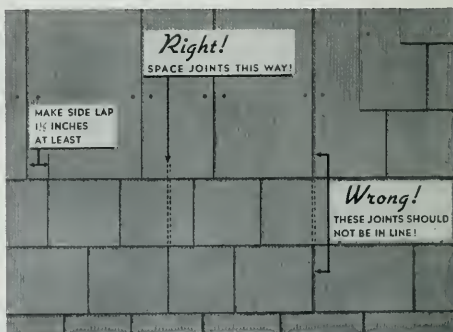

THE CORRECT SIDE LAP AND PROPER BREAKING OF JOINTS IS IMPORTANT, BUT EASILY ACCOMPLISHED



HOUSE FOR L. W. ROSS, SEATTLE, WASHINGTON

Smith, Carroll & Johannsen, Architects

Horizontal cedar siding used in combination with flush panels



RESIDENCE OF A. B. WINKLEY, SEATTLE, WASHINGTON

Smith, Carroll & Johannsen, Architects

Clear vertical grain cedar paneling treated with bleaching solution and colorless polishing wax



RESIDENCE OF GORDON PRENTICE, SEATTLE, WASHINGTON

George Wellington Stoddard, Architect

An effective use of random width knotty cedar



RESIDENCE OF GORDON PRENTICE

George Wellington Stoddard, Architect

Built-in cupboard of knotty cedar. Wall paneling of random width cedar boards



HOUSE BY WILLIAM J. BAIN, ARCHITECT

Double coursed shingle sidewalls

By its behavior under adverse conditions this wood is fast becoming the standard for outside siding and trim.

The craftsman can leave his work, safe in the knowledge that his efforts will stand the test of time. Mitered joints in beveled siding stay closed and tight, a trying test for any material subjected to changes in weather conditions. Ease of nailing without splitting is a recognized quality that has been well proven by years of experience with thin sections.

How any wood material will take paint and the effect of the material on the protective coating is of prime importance in any building project. As the oil dries it has a tendency to loosen its hold on the lead flakes that compose the body matter and permit them to dust off. Cedar, because of the natural oils contained in its cells, retards this action. By the same token the absence of resins which would become volatile under the action of the sun are absent, thus eliminating one of the chief causes of blistering and peeling of paint.

CEDAR SHINGLES FOR COLONIAL HOUSES

The question of the roof and roofing material is of prime importance. It is this covering that protects the entire building and its contents. Wood, because of its abundance and ease with which it can be prepared, naturally, became the first roofing material in the early colonies. In the Northwest shakes split from giant cedars was the natural material for the settlers' cabins. Some of these early cabins with their shake roofs are still giving service, and after years of exposure with no protective coating whatever, show little or no signs of deterioration.

After the hand-split shake, the sawn shingle was, of course, the next step, and as in nearly every other industry in our country, it has always been strong for a better product and better ways of manufacture. The old horizontal saw, called a block machine, gave way to the modern so-called upright machine. This shingle machine gives the operator better control over the blocks and enables him to place the wood in a position to take the greatest advantage of the grain. This machine automatically cuts the shingles with a taper. The operator trims

the edges on another saw, and grades them into the proper bin. They are again checked as the shingles are packed into bundles.

The proper laying of shingles is of importance. The lap should vary on various pitches of the roof, joints should be broken to avoid cracks through the roof. This, with a hot dipped zinc coated or copper nail, will insure long years of service.

Shingles lend themselves to many variations in laying, such as doubling on some courses, irregularly laid butts and varying of spacing from eave to hip. This, combined with the natural texture of the wood gives the Architect unlimited opportunity. The same holds true in the use of shingles on side walls. Double coursing and wide spacing giving a clapboard effect is only one of the many methods in use today.

A combination of siding and shingles is another combination that lends charm to many walls. Again a variation of siding widths also combined with shingles has been used successfully.

The manufacturers of lumber in the Western Red Cedar industry, by careful manufacturing methods and grading rules, are taking full advantage of the beauty and lasting qualities of this fine wood.

VARIETY OF INTERIOR FINISHES POSSIBLE

Western red cedar, both the slash and vertical grain, lends itself to a wide variety of finishes, ranging from the natural rich tones of color in the wood itself to light bleached effects required for a particular color scheme.

The finishing of cedar in its natural tones is a simple process.

There are several types of wood preservatives available that retain the natural beauty of the grain and prevent darkening with age. These finishes dry in flat tones but may be brought to a soft gloss with the use of steel wool.

Several bleaching solutions and bleaching oils are available which lighten the natural tone of the wood. They range in beautiful tones of oyster, bone white and platinum. After the bleaching process is complete, the surfaces are protected by non-gloss lacquer, or colorless polishing wax.

Summary of Sizes, Packing Rules, Running Inches and Shipping Weights

SEE NOTE No. 1

SEE NOTE No. 2

GRADES	Shingle Thicknesses (Green)	Approximate Bundle Thickness, Inches		No. of Courses per Bundle	Number Running Inches Per Square				Shipping Wts. per Square	
		Green	Dry		Roof		Sidewall		Roof 4 Blds.	Side Wall 3 Blds.
					Green	Dry	Green	Dry		
No. 1—24" (Royals)	4 Butts = 2"	6½/7	6½/6¾	15/14	1996	1920	1497	1440	192	144
No. 1—18" (Perfections)	5 Butts = 2¼"	8½	7¾	18/18	2664	2620	1998	1965	158	118½
No. 1—16" (Perfects 5X)	5 Butts = 2"	8	7¾	20/20	2960	2880	2220	2160	144	108
No. 2—24" (16" Clear)	4 Butts = 2"	6½/7	6½/6¾	15/14	1996	1920	1497	1440	192	144
No. 2—18" (12" Clear)	5 Butts = 2¼"	8½	7¾	18/18	2664	2620	1998	1965	158	118½
No. 2—16" (12" Clear)	5 Butts = 2"	8	7¾	20/20	2960	2880	2220	2160	144	108
No. 3—24" (10" Clear)	4 Butts = 2"	6¼/6¾	6/6½	15/14	1996	1920	1497	1440	192	144
No. 3—18" (8" Clear)	5 Butts = 2¼"	7¾	7¾	18/18	2664	2620	1998	1965	158	118½
No. 3—16" (8¼ Clear)	5 Butts = 2"	7¾	7¾	20/20	2960	2880	2220	2160	144	108
No. 1 and No. 2 Grades DIMENSIONS	Shingle Thicknesses (Green)	Widths (Green)	No. of Courses per Bundle	Additional Cross Shingles	No. of Bundles per Square		No. Pieces per Bundle	Shipping Wts. per Square		
					Roof	Side Wall		Roof 4 Blds.	Sidewall 3 Blds.	
24" x 6"	4 Butts = 2"	6"	14/14		4	3	84	192	144	
18" x 5"	5 Butts = 2¼"	5"	16/16	8	4	3	156	158	118½	
18" x 6"	5 Butts = 2¼"	6"	17/18	8	4	3	113	158	118½	
16" x 5"	5 Butts = 2"	5"	18/18	8	4	3	152	144	108	
16" x 6"	5 Butts = 2"	6"	19/20	8	4	3	125	144	108	

NOTE No. 1.—A small amount is allowed for shrinkage from green to dry wood. See grading rules for specific grade measurements, and also note third column, this table.

NOTE No. 2.—No definite number of random width shingles are packed in a bundle; minimum contents is determined by actual running (combined width of shingles laid side by side) inches of wood contained.

Covering Capacities per Bundle in Square Feet of the Various Sized Shingles

Exposure Inches	16" Shingles	18" Shingles	24" Shingles	Exposure Inches	16" Shingles	18" Shingles	24" Shingles	Exposure Inches	16" Shingles	18" Shingles	24" Shingles
3½	18	15½		7½	37½	34	25	11½	56½	52½	38
4	20	17½		8	40	36½	26½	12	59½	55	40
4½	22½	20		8½	42½	39	28	12½		57½	41½
5	25	22½		9	45	41	30	13		59½	43
5½	27½	25		9½	47½	43½	31½	13½		62	45
6	32	27½	20	10	50	46	33	14		64½	46½
6½	33½	29½	22½	10½	52	48	35	14½			48
7	35	31½	24	11	54½	50½	36½	15			50

Formula for Figuring Covering Capacities per Bundle

FORMULA: BASED ON GREEN MEASUREMENTS

$$\left\{ \begin{array}{l} \text{Total number of} \\ \text{courses in both} \\ \text{ends of bundle} \end{array} \right\} \times 18\frac{1}{2} \left\{ \begin{array}{l} \text{Running} \\ \text{inches in} \\ \text{each course} \end{array} \right\} \times \left\{ \begin{array}{l} \text{Number of inches} \\ \text{exposed to} \\ \text{weather} \end{array} \right\} + 144 = \text{Number of Square Feet that 1 Bundle will cover.}$$

FOR EXAMPLE:—Find covering capacity of 1 bundle 16" shingles exposed 5" to the weather:

$$\frac{(20 + 20) \times 18.5 \times 5}{144} = \frac{3700}{144} = 25.7 \text{ square feet.}$$

4	bundles—16" = 1 square at 5"	exposure
4½	bundles—16" = 1 square at 4½"	exposure
5	bundles—16" = 1 square at 4"	exposure

Page 6

Page 7

A square of shingles is guaranteed to cover 10' x 10' area or 100 square feet when laid at the prescribed weather exposure.

Color of wood is not a defect. This applies to all grades. Variations in color of heartwood of Western Red Cedar are caused by differences in the density of natural color infiltrations. Conclusive research has indicated no difference in the strength or durability of wood of varying color (see Commercial Standard C.S. 31-35 for Red Cedar Shingles, Bureau of Standards, U. S. Department of Commerce.) (Also tests made at the Forest Products Laboratory, College of Forestry, University of Washington, Seattle, Washington.)

If re-inspection is necessitated because of the too frequent occurrence of defects, the shipment is off-grade in which the total running inches of defective shingles constitute more than 4% of the shipment.

Definitely the finest shingles that have been offered the public as a standardized and inspected product are Certigrades. These inspected shingles are identified, in each of the several grades, by a label on every bundle bearing the word CERTIGRADE. No manufacturer who is unwilling to meet the requirements of the Red Cedar Shingle Bureau can obtain or use these labels which certify that the shingles so identified have been inspected and guaranteed as to grade by this Bureau.

Shingles that bear the CERTIGRADE labels can not be purchased at random, but are sold only by responsible dealers who know what service is demanded in their respective localities.

DOUBLE COURSED SHINGLE SIDE-WALLS FOR COLONIAL DESIGN

SIDE-WALLS covered with shingles that are given a very wide exposure create a strikingly attractive appearance. The application is particularly adaptable to modern interpretation of the Colonial styles and lends individuality to the designer's treatment of other architectural periods. The wide exposure requires deep butt shadows to be effective.

Weather exposure of shingles in single courses should not exceed half the shingle length minus one-half inch. When double-coursing is employed with "butt-nailing" much longer exposures become possible, greatly reducing the cost of application. It is advisable to use five penny small head hot-dipped zinc-coated nails, two nails per shingle, placed near the edges of the shingles and not more than three inches above the butts.

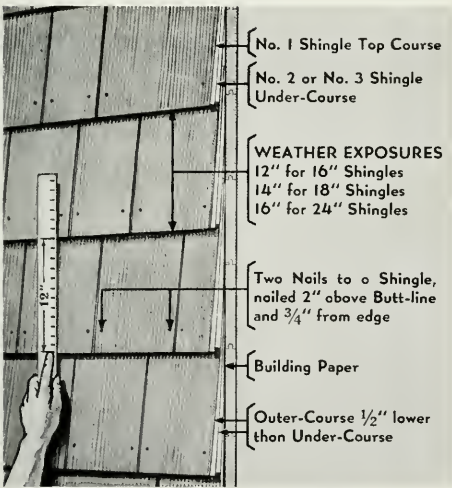

CONSTRUCTION DETAILS OF DOUBLE COURSING

The following table shows the reason why the double-coursing is economical due to the greater allowable exposure of the shingles:

LENGTH OF SHINGLES (in inches)	EXPOSURE OF SHINGLES (in inches)	
	Single Course	Double Course*
16"	6" to 7 1/2"	8" to 12"
18"	6" to 8 1/2"	8" to 14"
24"	8" to 11 1/2"	12" to 16"

* Assuming exposed course is face or butt-nailed.

The exposed shingles in each course should be Grade 1 which are all clear edge grain shingles. The under courses may be Grade 2 or 3. When pre-stained shingles are applied, the concealed courses should be stained also.

STANDARD GRADING RULES FOR WESTERN RED CEDAR

THE following are the rules under which Western red cedar lumber is graded and marketed:

"Clear" Bevel and Bungalow Siding shall be well milled on face and edges and be practically clear but permitting on thin edge, bright sap and slight imperfections which will be covered by lap when laid. Shall be usable full length without waste, making a smooth surface. In 6" and wider siding the angle of grain, for 3/4 of face from thick edge, shall not deviate from vertical more than 45 degrees.

"A" Bevel and Bungalow Siding. Mixed grain, bright sap admitted. Will admit the following or their equivalent:

- Torn Grain—slight.
- Raised Grain—slight.
- Rough Spots—occasional, small, on thick edges.
- Knots—Three scattered sound tight pin. Usable full length without waste.

"B" Bevel and Bungalow Siding. Will permit sap stain. Will also admit:

- Raised Grain.
- Torn Grain—medium.
- With one of the above will admit one of the following or its equivalent:

- Knots—4 small sound tight.
- Skips—occasional slight skips on face and edges.
- Wormholes—a few pin, well scattered.

Will also admit cut-outs that can be removed by wasting not more than 10% of the length of the piece by not exceeding one cut-out in pieces 6 to 9', two cut-outs in pieces from 10 to 15' inclusive and three cut-outs in pieces over 16' in length.

"C" Bevel and Bungalow Siding. Will admit all pieces falling below "B" grade, on account of imperfect manufacture, knots, etc. Especially is this grade intended to cover stock too thin to dress to standard sizes and consequently will be mostly rough. This grade will take all

lengths and no specified percentages are guaranteed.

"B and Better" Finish. Manufactured for use as casing, base, cabinets, and interior trim of finest quality for natural, stained, or enameled finish. Will admit:

Torn Grain—slight.
Sap—bright, 1 inch.

With the above will admit the following or their equivalent:

Knots—2 sound tight pin.

One additional knot or $1/2$ " sap allowed for each additional 2" in width.

Slight skips on back of piece.

Sound Knotted Paneling. The basis of this grade are knots, burls and other natural markings which are sound, of fairly uniform distribution, and add to the decorative character of the piece. Knots shall form the major portion of the markings. Must be well-manufactured; will admit slight torn grain; slight cup; slight skip on back of piece; sound intergrown knots ranging in size from $1\frac{1}{2}$ " in 4" widths to 2" in wider widths. Spike knots shall be of the diameter permitted and not longer than half the width of the piece. Star-checked knots caused by drying shall be permitted. Moisture content shall be 10% or less at time of loading.

No. 1 Boards and Sheathing. Must be well-manufactured for use as a general purpose product as sheathing and wall covering especially for permanent construction where resistance to decay is required. Will admit occasional slight variation in sawing and the following or their equivalent, if not in serious combination:

Knots—sound intergrown, approximately:
 $1\frac{1}{2}$ " in 4" and 6" widths.
2" in 8" and 10" widths.
 $2\frac{1}{2}$ " in 12" and wider widths.

Encased Knots—half the sizes of intergrown knots provided they are immovably fixed in position.

Spike Knots—equivalent.
Checks—seasoning, none through.
Crook—slight.
Cup—slight.

Sap Stain—medium, 25% of face.

Skips—slight.

Torn Grain—heavy.

Wane— $1/2$ " on edge, 1" on face, $1/6$ length of piece.

Wormholes—pin, well scattered.

No. 2 Boards and Sheathing. Must be well-manufactured and will admit the following or their equivalent, if not in serious combination:

Knots—sound tight, approximately:

2" in 4" widths.

$2\frac{1}{2}$ " in 6" widths.

3" in 8" and 10" widths.

$3\frac{1}{2}$ " in 12" widths.

Encased Knots—not firmly set, half the diameter of allowable tight knots.

Unsound Knots—half the diameter of allowable tight knots.

Spike Knots—equivalent.

Checks—seasoning.

Crook—medium.

Pith.

Sap Stain.

Shake—fine.

Skips—slight.

Splits—not longer than twice the width of the piece.

Torn Grain—deep.

Wane.

Wormholes—occasional.

If the above are limited, 3 knot holes, half the diameter of allowable tight knots, or equivalent smaller knot holes, permitted, based on 12" lengths.

No. 3 Boards and Sheathing. Will admit the following or their equivalent, if not in serious combination:

Knots—large loose unsound or decayed.

Knot Holes.

Decayed Sap.

Rot—limited.

Sap Stain.

Shake.

Splits—quarter length of piece.

Variation in thickness, hit and miss $1/16$ ", or $1/16$ " scant full length if one side is surfaced.

Wane.

Wormholes—large.

UNITED STATES FOREST
SERVICE
BUILDING PROGRAM
1933 - 1936
REGION 5

BLANCHARD & MAHER
ARCHITECTS

FIRM OF
SPENCER, BLANCHARD & MAHER
L. GLENN HALL
LANDSCAPE ARCHITECT



* BOUNDARY MARKER

AT THE outset of the present administration, under the Emergency Conservation Act of 1933, the Forest Service of Region 5, comprising the National Forest Lands of California and southwestern Nevada, had the opportunity to plan and effect a general construction program that had long been needed. Part of this program was the housing of its personnel in the field together with construction of all the necessary service buildings as offices, warehouses, shops, garages, barns, camp ground buildings, boundary markers, and special buildings for the particular needs of the California Forest and Range Experimental Station. An architectural department was immediately organized under the direction of L. A. Barrett, Assistant Regional Forester.

It was the general consensus of opinion that the exterior appearance of the buildings should be in the character of the wooden buildings of the early days of the Mother Lode Country, rather than any material to directly imitate or give the semblance of logs.

Under President Roosevelt's Recovery Act,

the Forest Service of Region 5 realized an opportunity to obtain much needed housing facilities adequate for its personnel. However, several obstacles presented themselves, to which there seemed to be no solution.

In the initial stages of Forest Service housing, a limitation of \$500 was set as a maximum to be spent on any one building. This limitation was, through the years previous to 1933, raised by degrees to \$2,500 in an attempt to cover increasing demands of comfort in severe climates of the mountain regions. With the advent of this new program, this limitation remained at \$2,500, and this had to cover the cost of construction of the largest building, that of a Forest Ranger residence, a structure of 1200 square feet floor area.

Prior to 1933 contributed labor had been necessary to obtain a building of any size with the funds available and the limitations imposed. This resulted in Forest Rangers getting together in the late fall or early spring and having an old-fashioned barn raising. Under the present set-up, no contributed labor was allowed ex-

* All photographs by courtesy of U. S. Forest Service and California Forest and Range Experiment Station



DISTRICT RANGERS' HEADQUARTERS, ANGELES NATIONAL FOREST, NEWHALL, CALIFORNIA
Group consists of 2-Room Office, Guard Dwelling, Ranger Dwelling and Fire Crew Barracks.

cept that of C.C.C. boys who were to be used to do rough labor only, such as digging basements, foundation trenches and assisting with the pouring of concrete.

With the statutory limitation of \$2,500 imposed by Congress and the largest residence requiring 1200 square feet, the unit cost was extremely low. In order to keep all buildings, small and large, within such a comparative unit cost, methods rather unusual at the time were necessary to effect such economy.

As the program set up at that time was one of comparatively short duration, it was obviously impossible to design separate structures to cover all requirements of the large personnel. The requirements of occupancy were studied and standard building types designed. Also, it appeared that a conservative survey showed the necessity of building during the first year at least 450 structures in order to make a fair start. These standard buildings were of thirteen different types; residences, fire crew bunkhouses, offices and garages. The problem arose as to variance in structural requirements. Some buildings were at altitudes of 8000 feet where

a snow and ice load of 150 pounds per square foot might be expected on roof areas. Other buildings were in desert countries where the problem was one of insulation against heat alone. It was finally decided to keep a standard structural design throughout all buildings and design for the severe snow loads and extreme cold. This would obviously give a well-insulated house against heat in desert regions and the roof trussing would vary in relation to the load anticipated.

In such a program the natural tendency would be to turn to prefabrication of a unit type. However, investigation at that time proved that the West particularly had little to offer in this field, and furthermore, an investigation of total costs showed that all known experiments of this nature ran considerably higher than unit costs would allow. So it was necessary to try to design buildings to fit the various needs of the personnel, and to have these buildings readycut in so far as practical, and organize and supervise the construction in order that erection costs could be kept as nearly as possible to those of the prefabricated



HEADQUARTERS OF THE SEQUOIA NATIONAL FOREST, PORTERVILLE

26-Foot Span Garage, 48-Foot Span Shop, 32-Foot Span Warehouse

building. Efforts in this direction were well rewarded, as it finally developed that the unit costs in general stayed within the estimates and the limitations.

Investigation of the program showed thirteen different types of buildings needed, viz.:

1. Forest Ranger Dwelling with a floor area of 1200 square feet.
2. Forest Guard Dwelling, 900 square feet.
3. Combination Fire Lookout and Observatory Dwelling, 450 square feet, lookout, kitchen, living room, and porch.
4. Two-Room Office and porch with toilet facilities, for the use of district rangers.
5. One-Room Office for ranger with porch and toilet facilities.
6. Fire Crew Barracks to accommodate twelve men during the fire season.
7. One-car Garage.
8. Two-car Garage.
9. Combination Garage and Woodshed.
10. Woodshed to cover ten cords of wood.
11. Warehouses for storage of rolling stock for truck trail maintenance and storage of sup-

plies and fire fighting equipment. Two sizes, 30'x50' and 30'x80'.

12. Four-horse Barn with storage of 25 tons of hay and 3 tons of grain.

13. Two-horse Barn.

At the outset of the program in 1933, the Forest Service organized its architectural force for this emergency program. Orders were immediately sent out to all C.C.C. camp superintendents to start training the most promising of the young men for work in this field. Several of the large lumber companies were called in in an effort to learn their reactions to handling such a program which was new to most of them. They were to be, in effect, the general contractor for all material, and furnish all materials except cement and aggregate, brick and rough plumbing.

Designs were then formulated, fulfilling the requirements of each building. The Forest Service, with its interest in the welfare of the lumber industry, naturally desired that the buildings be finished inside and out with wood. The outside finish was "clear all heart redwood" or western



SUPERVISOR'S OFFICE, PLUMAS NATIONAL FOREST, QUINCY, CALIFORNIA

Blanchard & Maher, Architects

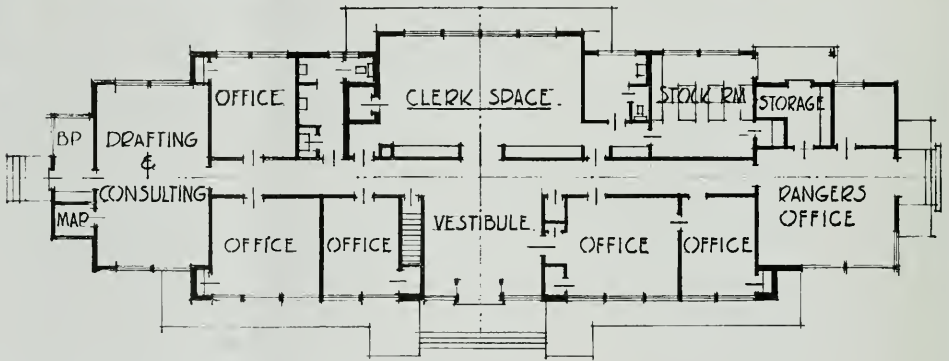

PLAN, SUPERVISOR'S OFFICE, QUINCY

red cedar. Under this was building paper and shiplapped diagonal sheathing. On the inside clear Douglas fir or Ponderosa pine was used to panel the interiors. Floors and ceilings were of Douglas fir T&G and the roofs covered with wood shingles over paper and solid sheathing. Subfloors were laid diagonally.

A system of cutting, bundling and marking had to be set up for the logical segregations of the various elements of the structure, and a double-check system installed for the mills to

insure against shortage, since most of the buildings were well removed from rail points and an oversight might mean long delays. Architectural drawings, mill drawings, and the final bill of lading handed to the carpenter in the field, had to be cross-checked and simplified so the rather frequent semi-skilled mechanics in the isolated and mountainous areas, called on to erect a structure, could understand the procedure.

All construction was to be under the direc-



ENTRANCE DETAIL, SUPERVISOR'S OFFICE, NATIONAL FOREST, MT. SHASTA CITY, CALIFORNIA



CALIFORNIA FOREST AND RANGE EXPERIMENT STATION, OFFICE AND LABORATORY,
MT. SHASTA CITY

Mount Shasta in Background



TYPICAL FOREST GUARD DWELLING, ANGELES NATIONAL FOREST, SOUTHERN CALIFORNIA
Blanchard & Maher, Architects

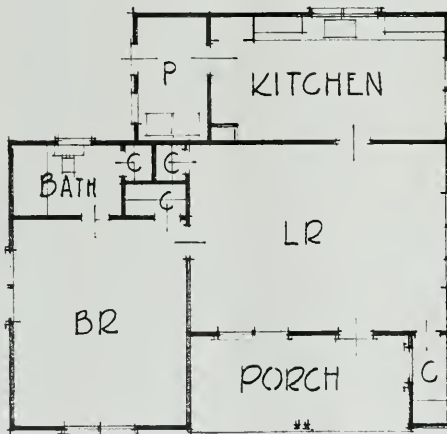

PLAN, FOREST GUARD DWELLING

tion of the Forest Supervisors of the eighteen National Forests that comprise Region 5. It was necessary for each Forest to organize crews under the supervision of the architects. Two landscape architects started off at once to lay out sites and stake locations of the buildings.

Requests for bids were sent out to about twenty of the large mills cutting most of their own timber. Due to the land grant rates on freight, existing over much of the State, the Forest Service asked for bids f.o.b. bidder's plant. This caused a great deal of confusion as the bids came in so closely bunched that a careful survey of rail rates between bidder's plant and destinations nearest each mill was necessary to determine which bids would be to the Government's advantage. The freight



TYPICAL FOREST RANGER DWELLING AND PLAN, TUOLUMNE RANGER STATION, STANISLAUS NATIONAL FOREST, CALIFORNIA

rates, in relation to the proposals, determined the actual award.

Specifications had to be drawn up so as not to penalize mills by forcing them to use timber not cut in their logging areas. This necessitated a thorough knowledge of lumber operations along the entire Pacific Coast, which fortunately the Forest Service was in a fine position to give. For instance, in central California Ponderosa pine was used as the exterior and interior finish of the buildings. In the north redwood or red cedar was used on the exterior, and Douglas fir on the interior. In the south Ponderosa pine and incense cedar were used.

Bids were also let for the material for warehouses on such items as prefabricated steel trusses, galvanized iron for roofs and overhead door hardware. Approximately 500 identical roof trusses of 30'-0" span were necessary and 200,000 square feet of galvanized iron needed. Although the structures were all small, the number was so large that the program proved to be a great stimulus to the material dealers and manufacturers. Unit costs on materials ran about \$1.00 per square foot, which indicated

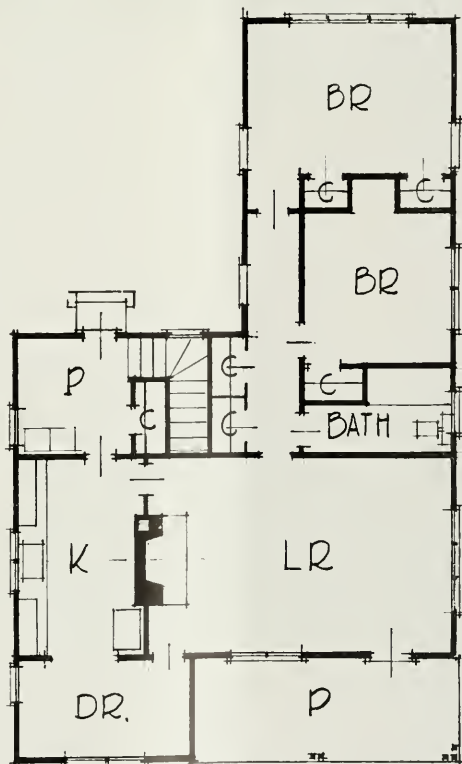



TWO-ROOM RANGERS' OFFICE, SHASTA NATIONAL FOREST, NEAR McCLOUD, CALIFORNIA
Mount Shasta in Background



RANGER'S OFFICE, MARKLEVILLE, MONO
NATIONAL FOREST



BARN AND HAY STORAGE GARAGE, SEQUOIA
NATIONAL FOREST



FIRE CREW BARRACKS TO ACCOMMODATE TWELVE MEN,
CLEVELAND NATIONAL FOREST, CORONA, CALIF.

Blanchard & Maher, Architects

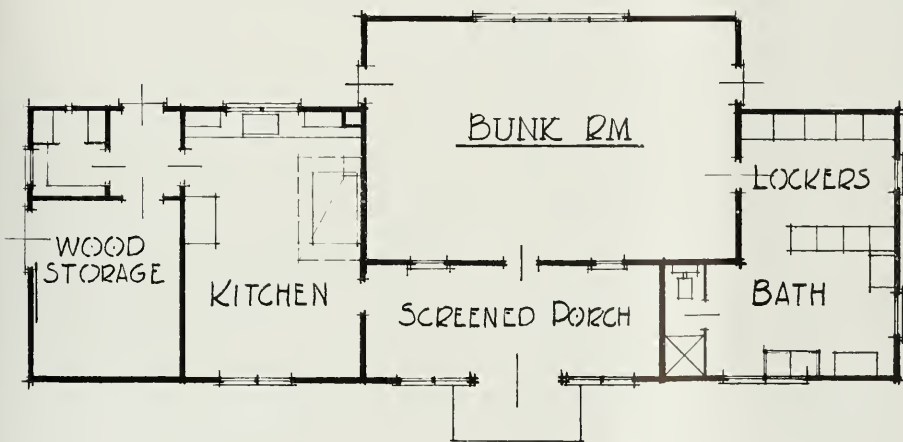

PLAN, FIRE CREW BARRACKS



STANDARD 10-STALL 26-FT. SPAN GARAGE, PLUMAS NATIONAL FOREST, QUINCY

Blanchard & Maher, Architects

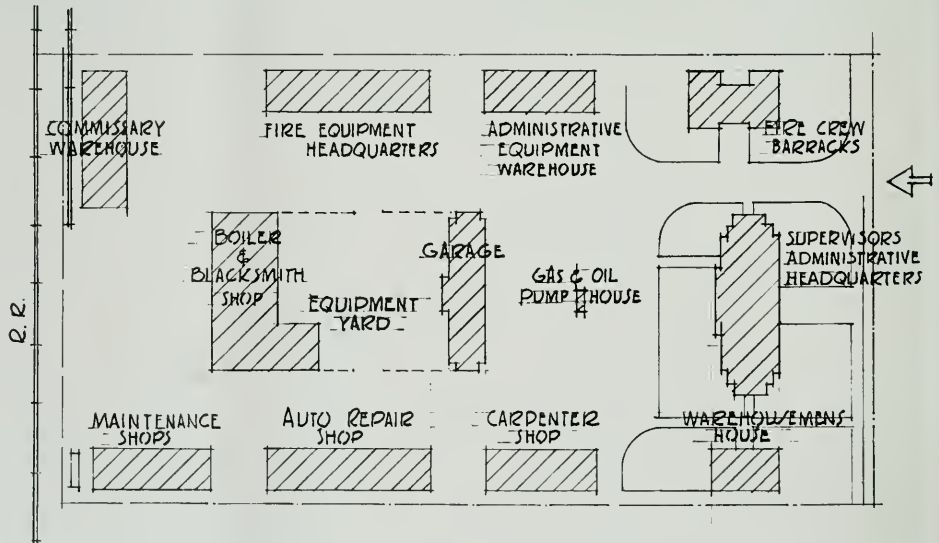

PLOT PLAN, SUPERVISOR'S HEADQUARTERS, QUINCY, PLUMAS NATIONAL FOREST

that we would be able to keep within our limitation of approximately \$2.15 a square foot. This allowed \$0.70 a square foot for construction, and the remainder for materials to be purchased locally.

The mills furnishing material were from Los Angeles to Portland, Oregon. In a subsequent

program, material was brought in from Seattle, Washington. The architects, with the aid of Navy Inspectors to follow up and check grades, went from mill to mill and checked cutting details, lumber grades, finished plumbing, steel trusses, door hardware, etc., and finished correlating the various phases of the work.



SUPERVISOR'S OFFICE, MT. SHASTA CITY, SHASTA NATIONAL FOREST. SALMON MOUNTAINS IN BACKGROUND

The supervision of the different construction projects was carried out by the architects who explained training and instructed the foremen in the procedure for this type of work, with which they were not familiar. It was necessary to develop a system of procedure in laying out the bundled material for each particular unit to be erected, in order to prevent handling and rehandling of the material.

In August of 1933 buildings were under construction from the Laguna Mountains, east of San Diego, to the Klamath River, and in both the Coast mountain chains and the Sierra. The program neared completion as fall and winter weather approached and started to drive the workmen out of the high country. Priority shipment had been made by the mills to the high snow country first to insure completion of these buildings before winter.

This, in general, was the story for the first year of operation, 1933. The winter of 1933-34 was spent making revisions in light of knowledge



MESS HALL, CALIFORNIA F. & R. EXPERIMENT STATION, ANGELES NATIONAL FOREST

gained during the summer and fall operation, and in designing additional standard buildings as well as special units. In the spring of 1934 bids were called for again on the standard buildings, and a program started for that year. Four Forest Supervisors' headquarters were constructed that year in addition to several other large buildings. Timber connectors were now available which enabled all warehouse trusses (standard span 32'-0" and 48'-0") and large garage units (span 26'-0") to be fabricated from wood. Tooth ring connectors were first used and later split-ring connectors adopted as standard.

In the spring of 1935 it was felt desirable to modify the design of the previous standard buildings. The architectural organization was considerably augmented and the entire series of buildings redesigned and more specialized



TYPICAL FOREST FIREMAN'S LOOKOUT TOWER. ORIGINALLY THESE WERE BUILT OF STEEL; LATER A STANDARD TIMBER DESIGN WAS ADOPTED

ARCHITECT PREDICTS SHORT LIFE FOR STREAMLINED BUILDINGS

EDITOR'S NOTE: As Architect and Engineer goes to press word comes from Detroit of the sudden death by heart failure of Herbert G. Wenzell, author of the accompanying article. Mr. Wenzell was 55. His early training was in the well known offices of Warren and Wetmore and Tracy and Swartout of New York City. Notable examples of his work are churches and bank buildings in Detroit. Medals of honor were awarded him by the Detroit Chapter, A.I.A., for his Masonic Temple and Central Woodward Christian Church. His article on Modern Design reflects clear thinking and logical reasoning. Herbert Wenzell might have become a successful professional writer had he so chosen.

THE question of "modernism" in architecture continues to be a mooted topic for debate by some of the nation's most distinguished architects. Writing for the Weekly Bulletin of the Michigan Society of Architects, in reply to Roger Allen's comments upholding the modern trend, Herbert G. Wenzell, an architect of professional standing in the East, says:

"It is no doubt significant that industrial designers are taking a prominent part in the development of the modern type of architecture and have streamlined everything from bottles to modern cities.

"I would contend in general that this type of architecture is not convincing because primarily it is not honest. It strives to be 'functional'

types developed, especially for warehousing of fire-fighting equipment, general storage, etc.

By the summer of 1936 the main body of work had been done. In the previous three years some 1200 buildings of various sizes and uses had been constructed under this program. The program was indeed a highly diversified one; including in its later stages in 1936 the construction of various headquarter plants with their shops and warehouses, an adobe staff headquarters building for the experiment station, laboratories, mess halls, dormitories and classroom as well as staff headquarters for the ranger school at Quincy. In addition, standard 14'-0" x 14'-0" Forest Firemen Lookout Buildings (45 were purchased under one bid) were developed as well as with the aid of the Engineering Department, standard 20', 30' and 40' wood towers for such buildings. Water tanks and their towers were of standardized design.

but betrays a pretense which is futile. It has in a brief time adopted certain types of construction, fenestration and primitive ornamentation which identifies it as a style. As a style, however, I think it safe to predict that it will be relatively short lived, for human interests and ideals are here involved.

"I would shudder to think of a strictly functional streamlined cathedral and perhaps it may be significant that this has not yet been attempted to my knowledge in the U. S. A. And here is, to me, the crux of the matter in regard to the lack of convincing and permanent qualities in the great majority of the examples of modern . . . the elimination of all character and expression not related to the material and mechanistic.

"All this would be to me, a rather distressing situation architecturally, were it not for the individualism of some few architects who, in their work, have retained the qualities which go to make a humanistic architecture. And it is worth while noting that some of these men and much of their work are at our back door. And, too, it is significant that these men are teachers in a real sense. It is doubly significant that they had no hand either in the World's Fair in Chicago or the going concern in New York City.

"Perhaps the arteries are growing stiff and I look upon the architectural scene (or scenery) with a jaundiced eye, but in my recent pilgrimages to New York I can but see the futility of the modern architectural Babylon and I return again and again to what were masterpieces in their day, all within a stone's throw of each other—The St. Regis Hotel, St. Thomas and the University Club. It is a nostalgia of which I am not altogether ashamed. I mention these structures because while entirely dissimilar because of their derivation yet to me they have those definite yet elusive qualities which make for great architecture. That they are monumental is beside the question. So is Radio City.

"I am impelled to touch upon the question of project housing—housing on a large scale.

(Turn to page 61)

Backstage In Europe's Industries . . . An Engineer's Observations

By F. T. Letchfield*

BECAUSE the natural sciences are universal in their application one would imagine that scientific research would be the same the world over. And so it is, in so far as the scientist must deal with immutable physical laws. Strangely enough, however, a scientific research laboratory reflects the psychology of the country in which it is found and so, to that extent, may be used to gauge national habits. The conversion of scientific knowledge into things of every day usefulness is the function of the engineer. It is his job to make things work in a practical way. Thus by observing the speed and the rate at which engineers translate scientific discoveries into industrial practices, within a given country, one may learn much of the long term economic outlook for that country. And so the inspection of scientific research laboratories in various parts of the world becomes something more than an interesting professional pastime if one will but look behind the scenes to the broader picture . . .

To study scientific progress in present day Europe a group of twenty-five engineers and scientists assembled by the National Research Council of New York, recently visited forty-six research laboratories covering eighteen different industries in England, France and Germany. As a member of that party I will endeavor to tell you, not so much in detail of what we saw as certain conclusions which might be drawn from what we observed. May I add, however, that it is quite impossible for any one traveling in Europe to return without a host of impressions all centering upon the marked differences in economic philosophies, social outlook and standards of living existing between America and those countries across the Atlantic. Nor can the fact that one may be totally unqualified to analyze or appraise them lessen their incidence upon one's reactions. Perhaps all the events of the past several years make one somewhat hypersensitive to international conditions at this time but in any event I would ask you to

recognize that I express only my own personal opinions and that many of them fall far beyond the purview of engineering. Such lapses can only be excused perhaps as natural manifestations of an intellectual curiosity common to most human beings.

I can well imagine that any naturalized citizen would always have an especial reverence for the country of his birth and a genuine belief in its contribution to America. But any one visiting England for the first time, whose ancestry runs back a few generations in America, must conclude that England is truly our mother country; that we are essentially an Anglo-Saxon race despite the many heterogeneous racial alloys simmering in the melting pot. At least such were my own reactions which grew geometrically with our stay in England.

ENGLANDS CONTRIBUTION TO SCIENCE

In the field of pure science England today—as in the past—is contributing a major share to the world's knowledge. We were privileged to spend one day at Trinity College, Cambridge. There we stood on veritable scientific Holy Ground and almost felt the presence of Sir Isaac Newton, Faraday, J. Clerk Maxwell, Cavendish and others who made Trinity the "Cradle of Science." There we were met in person by Sir Joseph J. Thomson, now the octogenarian Head Master of Trinity, who received the Nobel prize for his discovery of the electron in 1897 and who, together with the Curies, is credited with inaugurating the present renaissance in physics. There, in his capacity of Director of Cavendish Laboratories, we met the late and lovable Lord Rutherford who died but three months ago and who received the Nobel prize for his discovery of the neutron and other epochal contributions to the knowledge of atomic structures. There we also met Dr. Aston, another Nobel prize recipient and found him at work in his laboratory weighing atoms. And there, too, we met Dr. Carmichael and Dr. Cockcroft, both internationally famous for their work in the field of cosmic rays and low temperatures.

*Abstract of an address before the San Francisco Section, American Society of Civil Engineers.

In many of the industrial laboratories we met men of exceptional ability, particularly at the Metropolitan Vickers plant in Manchester, the Cotton Research Institute at Didsbury, at the laboratories of the great Brown-Firth plant in Sheffield and the Mond Nickel Company at Birmingham. They were doing excellent work, especially in the fields of textiles, low vacuum apparatus, the metallurgy of rustless steels and the hydrogenation of coal into gasoline and other hydro-carbon fuels.

Likewise the executive heads of these institutions were universally the fine, substantial, able Englishmen which the world, but particularly we Americans, so admire. And so it was something of a shock to observe the very splendid abilities at the top and the definite mediocrity at the bottom of the industrial structure in England. Nor is it easy for the American to rationalize the great disparity between the standards of living for a considerable number in the upper social strata of England and the great masses at the bottom. The evidence of such a gulf made one question the widespread belief held here in America that England has solved her social and labor problems on a much more enlightened basis than have we. True there is greater stability between employer and employee and the English system may be adequate for England. But stability of employer-employee relationships does not necessarily mean progress for the worker. Far from it. As the status of the English laborer amply attests.

I must admit that we left England with mixed emotions for we saw a country which industrially is behind America at least a generation. We saw a country whose industry would be swamped over night by Japan's mechanized labor, Germany's engineering ingenuity and America's mass production were colonial preference tariff walls and other artificial barriers once leveled. We found a country which is dropping farther and farther behind the rest of the world in all these things we call modernization.

On the other hand, no one, I believe, can visit the great offices of Lloyds in London, where the insurance threads of the world are

knotted, or peruse the statements of Barclays, Midland or other such banks—all having deposits of two hundred to four hundred million pounds—or meet and talk with the heads of British Chemical companies, the enormous trading corporations of great shipping concerns without being convinced that London is still the financial and business center of the world.

Likewise one must inevitably be impressed with a certain quality, a substance, a something in the English character which defies appreciation. Call it what you will, my own belief is that it springs from their very love of tradition. For I believe that a pride in one's own country and an abiding faith in its basic institutions are prerequisites to the sterling citizenship so universal to the English.

And so as we crossed the channel to Calais the thought occurred to me that, could England but adopt more of America's industrial philosophy and if in our own country we might follow the English practice of basing our laws on proven experience rather than upon wishful thinking and theoretical experimentation—both countries might be better off.

FRANCE CAN LEARN FROM AMERICA

In France, our official host was the Under Secretary of State for Foreign Affairs, M. Jean Perrin—one of France's leading scientists and Nobel Prize man. M. Perrin told us that even though he is Chairman of a Government Committee for the Advancement of Science and Engineering in France, that he, himself, had never been allowed inside one French Industrial Research Laboratory or plant. One can well imagine then, that we, as foreigners, had to secure our information of French Industry deductively. However, there were many straws blowing in the wind, and straws quite often tell as complete and sometimes a more interesting story than the stack from which they come.

We were taken to many of the Governmental Laboratories, the Aviation Laboratories, the Locomotive testing stand at Vitry and the like—also to many colleges, universities and endowed institutions. Among others we visited the College de France, founded by Francois Lr. in 1530. It is historically important because it was here that science was first adopted as a

subject for organized study. It is perhaps even more important as the birthplace of the Engineering profession.

We spent one memorable afternoon at the Pasteur Institute and one incident of Pasteur's life is of more than passing interest to all Californians for, strange as it may seem, he affected the industrial history of the State in a peculiar way. In the early sixties the silk industry of France and Italy was nearly wiped out by an epidemic of pebrine, a plague fatal to silk worms. Conditions became so acute that it was profitable to raise silk worms in California and ship their eggs around the Horn to the Italian and French hatcheries. The infant industry flourished and grew for a period of eight or ten years and a considerable acreage in California was given over to the cultivation of mulberry trees. But Pasteur, when appealed to by the silk men of France, found a preventive for pebrine and the California industry died a sudden death.

We spent another unforgettable day at the Radium Institute where we had the honor and privilege of meeting Madame Joliot Curie who is ably carrying on the work of her illustrious parents. Here I should like to digress for a moment to cite examples of the type of scientific accidents which so often change the course of human events.

Pierre and Marie Curie were not searching for a cure for cancer when in 1897 they discovered radium. They were endeavoring to identify emanations Becquerel had observed the year before coming from a Uranium compound. When radioactivity was found to consist of alpha rays, beta rays and gamma rays the use of radium in the treatment of cancer automatically suggested itself.

ACUITY OF SCIENTISTS BENEFITS MANKIND

By some poetic justice Madame Joliot Curie one day in 1932 was observing actions transpiring in a Wilson Vacuum Chamber when another scientific accident happened. A photon struck an atom of aluminium and transmuted the latter into radioactive sodium. As a result there are today laboratories in France, England, Germany and America producing artificial radio active salts with the thought that these can be induced directly into the

blood stream where they will travel to the affected part, give up their emanations therapeutically and forever after remain harmless. Thus does the acuity of some scientist so often benefit mankind in strange and unexpected ways.

It was difficult for us to understand Madame Curie's English but no one could miss her earnestness, professional zeal and intellectual integrity. In fact meeting and talking with such gigantic figures in the realm of science as Madame Curie, Lord Rutherford, Thomson, Aston and others, I have mentioned, one realized that one was standing in the presence of those whose names would live long; long after those of the Stallins, the Hitlers, the Mussolinis and other political figures of the day, will have been forgotten by all save a few students of history.

The French are good mechanics and have an extraordinary ability to put mundane materials together gracefully, as symbolized by the beauty and symmetry of the Eiffel Tower. Likewise the French are good engineers and individually do much brilliant work but their collective genius is frustrated by a medieval industrial philosophy which still regards labor as a commodity to be purchased in the cheapest market, which still refuses to replace obsolete equipment, which still regards the purchase of a labor saving device as an unwarranted extravagance. It is no mere coincidence that while Renault was famous before Ford was heard of, yet where there is one French car in America there are one thousand American automobiles in France. Bleriot sensed the modern airplane before Wright and Curtis, yet—compared to our modern transport planes the French ships of today look like galvanized iron sheds with wings attached.

All in all one is forced to the conclusion that France has much more to learn from America than it has to teach us. One does regret however, that those among us who believe that the high road to industrial greatness lies in the direction of legislative restrictions or coercion could not be compelled to visit France and observe at first-hand what happens to industry when it is placed in a legislative straightjacket, such as fashioned by M. Blum and his Front Populaire.

CONFUSION OF FACTS IN GERMANY

One evening about seven o'clock, we left Paris on the International train for Berlin. We crossed the German border about midnight and could tell that event, not by the Customs Guards for they came later, but by the road-bed for it was so much smoother and we had our first contact with the precise mental processes of the German engineers.

About three in the morning two uniformed Customs Guards came into our compartment. They paid no attention to our bags but meticulously counted every penny of the money we had declared upon crossing the border and upon departing warned us we were to carry no newspapers into their country.

We arrived in Berlin the following morning where we had our preconceived ideas of secrecy, political surveillance and espionage that would cover our movements knocked into a cocked hat by the very comprehensive program which had been prepared for us and the evident willingness of the German engineers and scientists to give us all the information we could ask for.

Let me say at the outset, that it is impossible to secure an accurate picture of present day Germany from our domestic newspapers and unfortunately, the longer one stays in Germany, the more one learns of it, the more confused one becomes because each set of facts is so contradictory. But perhaps a brief outline of what has happened in Germany may help to illuminate the current scene.

The Versailles Treaty stripped Germany of her army, her navy, her air force and her pride. In the political setup following the collapse of the monarchy no one party had a majority, yet each minority could—and did—make trouble. Hindenburg was universally beloved and respected but too old and too feeble to do more than keep the German ship of state afloat. Somewhat in desperation the bankers and industrialists backed Hitler, believing that with such men as Schacht, Luther and others at his side he could be guided and controlled. But the tail immediately wagged the dog in alarming fashion for Hitler, regardless of his many shortcomings, is a master of mass psychology. As such he tore open historical wounds of racial

prejudices and hatreds and then proceeded to anoint them with a series of manifestoes and edicts which to us can seem nothing short of barbaric. But strangely enough, the German people regarded them as the only possible course.

HITLER RESTORES GERMAN PRIDE

Herr Hitler has torn up the Versailles Treaty, has given back to Germany her army, her navy, her air force and—more than all else—has restored the Germans' belief in themselves and their pride in their country. It is the latter which is responsible for Hitler's amazing popularity throughout the Vaterland. I was told, not by Germans but by those who, through long residence in the country, are competent to speak authoritatively, that a secret poll such as we have in America, would tomorrow give Hitler a majority of at least 75 per cent on any personal issue.

He has succeeded in regimenting in all minutes the lives of sixty-five million people including seventy thousand highly trained scientists and engineers whose energies are mobilized and co-ordinated to an amazing degree upon a program of "Ersatz" ("Ersatz" meaning substitute.) We did not visit one research laboratory in Germany which was not endeavoring to find some indigenous material or to produce some synthetic product as a substitute for something heretofore imported. Herr Hitler is determined that Germany is to be economically self contained. It is of course a crazy and impossible economy, but out of it and because of its very impossibilities, are coming many startling things. Developments which some day, when the miasma of Nazism has passed and the world has regained its sanity, will be felt commercially and economically in this country—unless in this country we, too, bend every energy to keep abreast. This I confidently expect we shall do.

We saw wool made from the roots of beech trees—after turpentine and resin had been extracted as useful by-products. As a textile it has its shortcomings but it costs only half as much as animal wool in Germany. Most of the automobile tires now used in Germany are made from acetylene gas. The motor fuel is gasoline hydrogenated from brown coal, peat

and mixed with 20 per cent potato alcohol. Aluminium, magnesium and many light weight alloys are substituted for steel and iron wherever possible. Bakelite and a host of synthetic plastics are used in place of wood. Their requirements for ammonia and other nitrogenous derivatives are made from liquid air and coal gas. At the I. G. Farben plant in Ludwigshafen we saw synthetic sapphires, amethysts, emeralds, rubies, garnets and aqua marines that you and I couldn't tell from true gems.

But traveling through Germany with its inevitable human contacts and opportunities for observations one learns of other things beside the remarkable abilities of the German scientists. One learns for instance, that every Christian German boy and girl at the age of six, go willy nilly into the Hitler Jugend. And there they stay until the age of ten when they go—not into the boy scouts or girl scouts—but into the Hitler Movement where every moment of their lives is accounted for until they are eighteen. Then the girls, regardless of what social strata they may come from, spend six months in girls' camps helping the farmer's wife with the children, or scrubbing floors or even raking hay in the field. And the boys—at the age of eighteen—do their six months' "Arbeit" in the labor battalions, draining swamps, making roads or building fortifications. Then they go into the army. That statement, however, is but an euphemism for every German boy and girl is "In the Army" from the sixth birthday on. And one wonders what thoughts must be seething in the minds of their parents whose early and formative education was had when German philosophy was one of the richest in all history.

MILITARISM IN THE GERMAN SCHOOLS

Friends of ours—an American couple living in Berlin—took their two sons out of the German schools last year for they casually asked the younger—age 9—what he had been doing at school that day and he replied, "Oh, today, we practiced throwing hand grenades!" Further inquiry disclosed that he was proficient at stringing barbed wire and digging trenches and that the older boy—13—was having bayonet and rifle practice four times a week.

At Heidelberg one no longer sees multi-

colored uniforms and caps of the student fraternities for they have been done away with as too individualistic. But the old dueling hall has just been refurbished and Hitler blessed it with an edict virtually making mandatory the settlement of certain types of disputes with the broadsword—for bloodletting fits in nicely with Mr. Hitler's scheme of things.

I had expected to emerge from Germany in a belligerent frame of mind but I left with a feeling of pathos and tragedy for, on one hand, one sees in Germany evidence of splendid physical accomplishments in the reclamation of fifteen million acres of tide lands, the elimination of slums, a great new highway system, public buildings, splendid schools, laboratories and the like. But on the other hand one sees sixty-five million splendid people being led by a madman waving a sword at a mad world, attempting an impossible economy which is rapidly raising the cost of living, lowering the standards of living and generating social pressures which sooner or later will explode unless they be relieved or diverted by war. It is fear of this last which covers all Europe like a pall. To us here in America, due to our isolation and invulnerableness, the threats and rumors of war have certain unreal or at least only academic qualities. But as one travels through Europe the menace of war, indeed its likelihood, becomes a grim reality.

On every hand one sees bodies of troops accoutered for action. Notices in public buildings of what to do and where to go in event of an air raid. Authorities in Berlin had measured the cellar of the home of some American friends living there, had assigned twenty-two people to occupy it in case of attack and had even left material with which to caulk the windows to keep out poison gas. Other friends in England were building a bomb proof shelter and an acquaintance in France keeps a sea-going schooner in readiness at Marseilles.

AND AMERICA LEADS THEM ALL

And so, after the disappointments of England, the archaic and chaotic picture in France and the sinister tragic atmosphere of Germany, it is perhaps not surprising that as we set sail for home the query kept running through my mind,

—"Why is it that America is preeminent among all nations?"

But statistics alone are not the only evidence of the vitality and vigor of the American System. I have seen it personally in a Model "T" Ford negotiating the impassable winter roads of Siberia. I have seen it in modern service station equipment high in the Swiss Alps; in American cash registers and bookkeeping machines back of hotel desks in Germany and many familiar names of American concerns on manufacturing plants in England. I have seen it in the ubiquity of Singer sewing machines, Eastman kodaks, Packard cars, Woolworth stores and the like. One may see the same evidence in offices of the American Express Company in Paris or Rome or London or Geneva or any other place where tourists go, for they are filled with American school teachers and "white collar" workers. Where else in all the world can salaried people, in large numbers, spend their vacations traveling the globe?

There are some who believe that America's unique economic status is due to our vast natural resources. But if that were the answer, then Russia would excell us. If it were due to a large, intelligent population, then China would lead the world. If it were because of the so-called "Capitalistic System" then France would have living standards approaching our own. If it were solely because of a democratic form of government, then the masses in England would be far better off. If it were the result of engineering skill or scientific knowledge, then Germany would crowd us for first place as a producer and consumer of the world's goods. All

such premises leave the riddle still unsolved. I presume every one will have their own answer and I am perhaps too chauvinistic to speak without prejudice, but to me America's greatness springs primarily from three factors. First, the age old struggle for freedom found a soil here in America in which it could blossom and flourish. Second, the qualities of self reliance, resourcefulness and courage required in the struggle to conquer our physical frontiers, became dominant, national traits. The third factor—which after a trip through Europe I believe is the most imponderable of all—is really a product of the first two. I refer to the sovereignty of the individual, the equality of rights, without hereditary or arbitrary privileges and rights not vouchsafed to all. In short, the absence of caste or of traditions which still impose the psychology of caste. I may be laying undue stress upon the latter but it is the only premise by which I can rationalize the great difference between what we saw in Europe and what I know of America.

And so, if you were to ask me what thought above all others stands out in my mind as a result of visiting the scientific research laboratories of Europe I should have to tell you frankly that it falls far afield from the miracles and wonders of science, from the things of historical interest, from the beauties of Old World art galleries or the pleasures of travel in general. I should have to admit that the thought which supersedes all others and which grows with each retrospection, is a formless prayer of thankfulness that a kind destiny has given me citizenship here—in America.

AMERICAN ARCHITECTURE VIEWED FROM EUROPE

"AMERICAN Architecture Viewed From Europe," was the subject of an address delivered by Dr. Siegfried Giedion, secretary of the International Congress for Modern Architecture, at a symposium of contemporary architecture conducted at the New York University Institute of Fine Arts, May 12. Other speakers were George Howe, architect of the Children's World at the New York World's Fair; R. Buckminster Fuller, creator of the dymaxion house and automobile; Dr. John E. Burchard, director of the Albert Farwell Bemis Foundation at the Massachusetts Institute of Technology; Professor Frederick Kiesler of Columbia University, and Alvar Aalto of Finland.

Dr. Giedion's address follows:

"It is very curious for the European historian to observe that the judgment concerning the simplicity, technical correctness, and surety of shape revealed by American production has not changed since the Great Exhibition in London in 1851, when the European public first came in contact with American furniture and utensils.

"Later in 1878 when the first director of the Museum of Industrial Arts in Berlin saw the American tools exhibited at the Paris World's Fair he experienced an intense esthetic pleasure. He pointed out a parallelism between these tools and the most beautiful primitive stone and bronze instruments. The French at that date seeing the American furniture pointed out that a new style had arisen across the Atlantic, which manifested itself in all forms of industrial art, which they termed the Pullman Car Style.

"The difference between American and European industry lies in the fact that European industry springing into existence on English soil in the late 18th Century, substituted the machine for hand labor in dealing with simple raw materials such as iron or cotton fibre. Whereas American industry became robust at a much later period, around 1850, which required that complicated crafts and skilled labor be industrialized.

"It is necessary to stress these differences in structure for a clear understanding of the evolutionary process which American architecture has followed. In the field of building the primitive method of wood construction became practically made over from a craft demanding skilled labor, into an industry. For example, the invention of the balloon frame which cropped up near Chicago toward the middle of the 19th Century.

"In the seventies European architecture was losing more and more of its dignity. The closer it clung to historical forms in an effort to regain its security, the more insecure it became. Time and again the inner

unrest and uncertainty of the period was reflected in the European facades and ground plans.

"In America, however, houses, like furniture and tools, maintained a definite character.

"It is, at least for European observers, almost incomprehensible that, in the middle of the Seventies, in popular books, instead of decorative details the housing problem was conceived in its entire variability. (As in the books of Eugene C. Gardner in the Seventies.)

'There were already the flexible and informal ground plans so characteristic for the later development of Richardson and Frank Lloyd Wright. The kitchen, for example, was treated with a sense of organization in 1880 as in the European development in 1920.

"John Ruskin said once of America: 'I could not even for a couple of months live in a country so miserable as to possess no castles.' But what in the 19th Century did the Europeans make of their whole historical background? Also, in America, a heap of architectural horrors existed. At the same time, however, houses maintained a definite character in America. The sense for the so-called plain surfaces in the treatment of the brick, the wood and the stone wall was never lost.

"The Chicago school was one of the happy moments in American architecture. In no other country could be seen in the 15 years between 1879-1893 such vigor to push into the future as shown by the Chicago school. Here were handled with astonishing keenness all the new problems arising from the big office building and the apartment house, to the creation of the system of elaborate playgrounds.

"At this period America had to advance alone.

"The importance of the Chicago school for the history of architecture lies in the fact that for the first time in the 19th Century the schism between construction and architecture, between engineer and architect, was eliminated. This schism characterized the whole earlier period of the century and is responsible for the uncertainty in architectural problems. With surprising boldness the Chicago school tried to break through to pure forms.

"The full significance of the Chicago school had not been fully established. There are buildings, which are today known only to some specialists and which belong in every history of architecture like the Leiter Building (today Sears, Roebuck department store) built by William Le Baron Jenney, 1889, the first of the high buildings in which the purity of construction had finally found its counterpart in architecture. The second building was the Reliance Building by Daniel Burnham (Chi-

cago, 1894) a glass tower of 15 stories. Perhaps the Reliance Building is more than the forerunner of Mies Van Der Rohe's scheme for a skyscraper of glass and iron of 1922. The third building was erected by Louis Sullivan: The Carson Pirie Scott store (1893-1904) and is unsurpassed in strength of expression. When this department store was finished after 1900 it appeared completely old-fashioned to contemporaries. They had by that time lost both heart and head in the eastern classical revival which transformed the solid business building into a mercantile palace. At the very moment when the Chicago school had achieved command over the means it had created, its development was suddenly stopped by the influence of the Chicago World's Fair (1893).

"Far away from the great public, Frank Lloyd Wright continued in another sense the work of the Chicago school. His works grew out of the creative atmosphere of Chicago, the basic elements of the American domestic architecture and the eternal secret of the artistic genius destined to push forward into the unknown.

"Why was the academic architecture since 1893 so dangerous?"

"It is no pure accident that the architects who acclaimed the pseudoclassic revival of the nineties and onward were excellent businessmen with boundless building activity when judged by European standards.

"A classical revival has a different meaning at different periods. About 1900 it signified a passivity to everything living. The architect thereupon renounced helping to shape life actively. The consequence was clear and still perceptible today. In contrast to the European development the role of the architect in America was changed from an artistic and social one into that of a pure specialist.

"In the last two decades contemporary architecture is no longer the concern of specialists who simply build as they are asked. Architecture has awakened out of a long passivity and dares to seize life actively and help to mold it. Architecture asks today: what kind of life do you lead? Can I be responsible for how you are forced to live and dwell?"

"All these questions involve that contemporary architecture, and proceed from a moral program. Architecture forsakes the realm of the mere specialist and feels the profound desire to plunge down to the realities of life.

"Out of a creative, or, if you will, moral impulse, architecture has formed a wrapping or shell for life which is in identity with the aims of the time.

"Architecture has gained its leading role in Europe just because it hasn't waited until the public nodded its approval to everything or the building industry could fulfill all its aims.

"In the realm of architecture America took the lead during three decades—in the eighties on a large scale

—and until 1910 by the isolated work of some of its geniuses. From then on Europe took the leading role. Because of circumstance, America today has once more the obligation to take up the leading role.

"For two reasons especially this is not simple. First because the effect of an education which used the classical revival as a narcotic for an estrangement from life and creation, cannot be blotted out in a day. The second springs from a totally different source. America has the highest development of industrialization, which is imperative to fulfill the architecture of our period, but mass production or even the greatest standardization can become an obstacle if it is not subordinated to the command of human needs."

ENGINEERING POSITIONS FILLED

Frank A. Banks, construction engineer of the Grand Coulee Dam project, has been appointed Acting Administrator of the Bonneville Project to succeed the late John Delmadge Ross.

Mr. Banks, 57 years old, a graduate of the University of Maine in civil engineering, has been employed continuously by the Bureau of Reclamation since 1906. He worked up through the field service of the Bureau to the position in 1917 of construction engineer of American Falls Dam in Idaho, and in 1920 went to the Owyhee Project in Oregon as construction engineer of the great Owyhee Dam, then the outstanding engineering structure in the world. In August 1933, when the Grand Coulee Dam Project was begun Frank Banks was assigned to the job as construction engineer and he has supervised the work since that date.

While Acting Administrator of the Bonneville Project Mr. Banks will continue as construction engineer of Grand Coulee Dam.

Secretary Ickes has also announced the appointment of Barry Dibble, electrical engineer whose home is in Redlands, California, as Assistant Administrator of the Bonneville Project to work with Mr. Banks and to represent him at the Portland, Oregon, project office.

TO IMPROVE MEXICAN QUARTERS

Presenting a plan to the City of Santa Barbara to remodel the Mexican quarters, approximately 100 students of the University of Southern California School of Architecture, visited the mission city the week-end of May 11, under the direction of Prof. Clayton M. Baldwin and Prof. Carl B. Troeddsen.

As a part of their field project, the students submitted plans and models to Santa Barbara officials as a suggested means of city beautification. Concrete houses with one and two bedroom units to be built at low cost and surrounded by playgrounds and gardens are features of the student designs.

The project is sponsored by Alpha Rho Chi, national honorary fraternity at S. C. and is similar to the presentation to the city of Santa Ana last year of a plan to modernize the business section of that community.

With the Architects

STANFORD UNIVERSITY LIBRARY

Working drawings are in progress in the offices of Arthur Brown, Jr. and John Bakewell, Jr., 251 Kearny Street, San Francisco, for a new library to be known as the Hoover Library on War, Revolution and Peace and to be erected on Stanford University Campus, Palo Alto, at an estimated cost of \$600,000. Construction will be under the supervision of George Wagner, Inc., 181 South Park, San Francisco.

SEVENTY-FIVE RESIDENCES

Herbert Goodpastor, with offices in the Mitau Building, Sacramento, is preparing plans for the development of Sierra View Terrace in Sacramento which improvements will include the construction of seventy-five or more dwellings. They will be built in units, and will be constructed of Basalite blocks, each house having five rooms, bath and garage. The promoters are expected to spend \$200,000 on the project.

CONTRACT FOR LABORATORY BUILDING

On its bid of \$817,000, MacDonald & Kahn, San Francisco, have been awarded a contract for the construction of laboratory and service buildings for the U. S. Department of Agriculture in Albany, Alameda County. Both buildings will be of reinforced concrete, monolithic construction, with built-up-roofing, steel sash and heat absorbing glass.

JUNIOR COLLEGE AND GYMNASIUM

Charles F. Dean, California State Life Building, Sacramento, has prepared plans for a one-story frame and stucco addition to include a library and gymnasium, for the Yuba Junior College District at Marysville; also a one-story asbestos shingle exterior gymnasium at Dunsuir for the Dunsuir Joint Union High School District.

PERSONALS

Bert Harper has been appointed building inspector of Santa Paula to succeed William H. Robinson, resigned. Mr. Harper was former district road superintendent in Ventura County.

Kenneth R. Swift, architect, is now associated with M. J. Gabrielsen, structural engineer, under the name, Swift & Gabrielsen, architect and engineer, 6362 Hollywood Boulevard, Los Angeles.

Alvar Aalto, internationally known authority on modern architecture from Helsingfors, Finland, accompanied by his wife, was a recent visitor to Treasure Island, the guest of Dorothy Wright Liebes, director of the decorative arts section of the Fair.

MEDALS FOR CALIFORNIA ARCHITECTS

At a recent dinner given by the Committee on Foreign Relations of the American Institute of Architects, twenty certificates of award were presented by the French government to a group of American architects, whose works, photographically exhibited at the Paris International Exposition of 1937, were honored at that time by an international jury.

Gordon B. Kaufmann of Los Angeles received two awards in as many classifications, one Industrial and Commercial Architecture, and the other Sports Buildings and Housing Development. In Residential Architecture bronze medals were awarded Wm. W. Wurster of San Francisco and Richard Neutra of Los Angeles.

COMPETITION FOR SCULPTORS

A regional competition open to sculptors resident of or attached to states this side of the Mississippi, is to be held, the winner to be awarded a commission to execute two sculptures, either in marble, aluminum, or bronze, for the Main Street entrance lobby of the Los Angeles Post Office and Court House. The sculptures are to be eight feet high; \$7,200 will be paid to the winning artist for each one, amount to cover complete cost of models, materials, execution, and installation of the finished work. Form announcements may be obtained from E. C. Maxwell, Director of the Foundation of Western Art, Los Angeles.

JOHN E. TOURTELLOTTE, ARCHITECT

John E. Tourtellotte, pioneer architect in the Pacific Northwest, died in Portland May 8, aged 70. In nearly 50 years of activity, Mr. Tourtellotte had designed more than 15 hotels and 35 public buildings in Idaho and Oregon, the most noted being the Idaho State Capitol at Boise. At the time of his death his firm of Tourtellotte & Phillips had charge of the construction of the Linn County Courthouse at Albany, Ore.

THE ARCHITECT

There is no truer poet than
The architect; each visioned plan
He forms in symmetry as fine
As any metrical design
The poet uses; with skilled care
The architect contrives to pair
Sunlight and shadow in a scheme
That accents every cadenced beam
And cornice, he does not forget
Demands of usefulness, and yet
He somehow builds a lyric tone
Into each syllable of stone.

—Ida Marian Breed

SAN FRANCISCO BUILDING FOR MAY

Building construction in San Francisco continues to show an upward swing with more homes being built every day, according to the monthly building report of S. J. Rosenblum, chief clerk of the Central Permit Bureau.

Due to sharp increases in frame construction and Government building during May, building construction during the first five months of this year surpassed the figure for the same period in 1938 by more than \$3,500,000.

During the first five months of 1939, 3756 building permits were issued for construction costing \$11,868,314, as compared to 3115 permits issued last year for a total of \$8,234,291.

In May, 1939, 713 permits were issued for work estimated to cost \$3,747,847, as compared to 696 permits issued in May, 1938, for work costing \$1,385,417. Permits issued last month for a total of \$1,585,063.

Two large permits were issued for the \$1,735,000 Rincon Hill Postoffice Annex and the \$186,000 Alcatraz Industrial Prison building to boost the May total.

AUTO CLUB BUILDING

A building which will be leased by the California State Automobile Association for its Berkeley Branch, is to be erected at 1849 University Avenue, from plans by Albert F. Roller of San Francisco. J. W. Plachek will supervise construction, as representative of the owner, W. J. Acheson. The building will cost \$12,000.

PALO ALTO DWELLINGS

Plans have been completed for two Palo Alto residences, one for Mr. Hink, and the other for Prof. Fairman. They will cost \$10,000 each. Plans are by Birge M. & David Clark, 310 University Avenue, Palo Alto.

STORE BUILDING REMODEL

Extensive remodeling is planned to the store building at Post and Kearny Streets, San Francisco, formerly occupied by Hastings and owned by the Cousins Investment Company. The architect is Elias Rothschild of New York, William I. Garren, of San Francisco, being the local supervising architect.

BERKELEY STORE BUILDING

Under construction at 1111 University Avenue, Berkeley, is a one-story, 50x90' reinforced concrete and steel store building to be occupied by the Hagstrom Food Stores. Plans were prepared by Irwin M. Johnson, 2219 Seventh Avenue, Oakland.

OAKLAND STORE BUILDING

Safeway Stores, Inc., will have another store building at 54th Street and San Pablo Avenue, Oakland, plans for which have been prepared by Earl R. MacDonald, 1710 Franklin Street, Oakland. The building will be one-story frame and stucco construction, tile and plate glass front and will cost \$12,000.

CONTRACT FOR THREE TUNNELS

For construction of another four-mile section of the 30-mile railroad relocation around the Shasta reservoir site in connection with the Central Valley Federal Reclamation Project in California, a contract has been awarded to R. G. Clifford of San Francisco, on his bid of \$1,223,186, the lowest of 13 tenders submitted to the Bureau of Reclamation May 2 at its Sacramento office.

The tunnels included in the construction of this section of the railroad are 915 feet, 1,610 feet, and 2,235 feet long.

SAN FRANCISCO FLATS

A two-story frame and stucco flat building will be erected on Jefferson Street, west of Broderick, San Francisco, from plans by Douglas D. Stone, 381 Bush Street, San Francisco. The owner is Marion Pancrazi.

VISALIA JUNIOR COLLEGE

Bonds have been voted and preliminary plans are being drawn in the office of H. L. Gogerty, 6272 Yucca Street, Hollywood, for a group of college buildings at Visalia, estimated to cost \$400,000.

MORTUARY BUILDING ADDITION

A new chapel and other improvements are planned to the mortuary building at 29th and Dolores Streets, San Francisco, for James H. Reilly & Company. Vincent Buckley, 525 Market Street, San Francisco, is the architect.

PAROCHIAL SCHOOL

Working drawings are in progress for a twelve-room and cafeteria building for Holy Names Parish at 40th Avenue and Kirkham Street, San Francisco. Plans are by John J. Foley of San Francisco.

TURLOCK SHOP BUILDING

A \$40,000 frame shop building is to be built for the Turlock Union High School District, Turlock, Stanislaus County, from plans by Henry L. Gogerty of Hollywood.

STORE BUILDING ALTERATIONS

Summerfield & Haines are the owners of a one-story store building which is to undergo extensive remodeling from plans by Architects Hertzka & Knowles of San Francisco.

SAN FRANCISCO APARTMENT BUILDING

An \$18,000 two-story frame and stucco apartment building is being designed for a San Francisco client in the office of F. Frederic Amandes, 414 Dewey Boulevard, San Francisco.

BURLINGAME RESIDENCES

A. E. Van Bolt is the owner of a \$6500, five room house to be built in Burlingame from plans by J. K. Ballentyne, Jr., architect, of San Francisco.

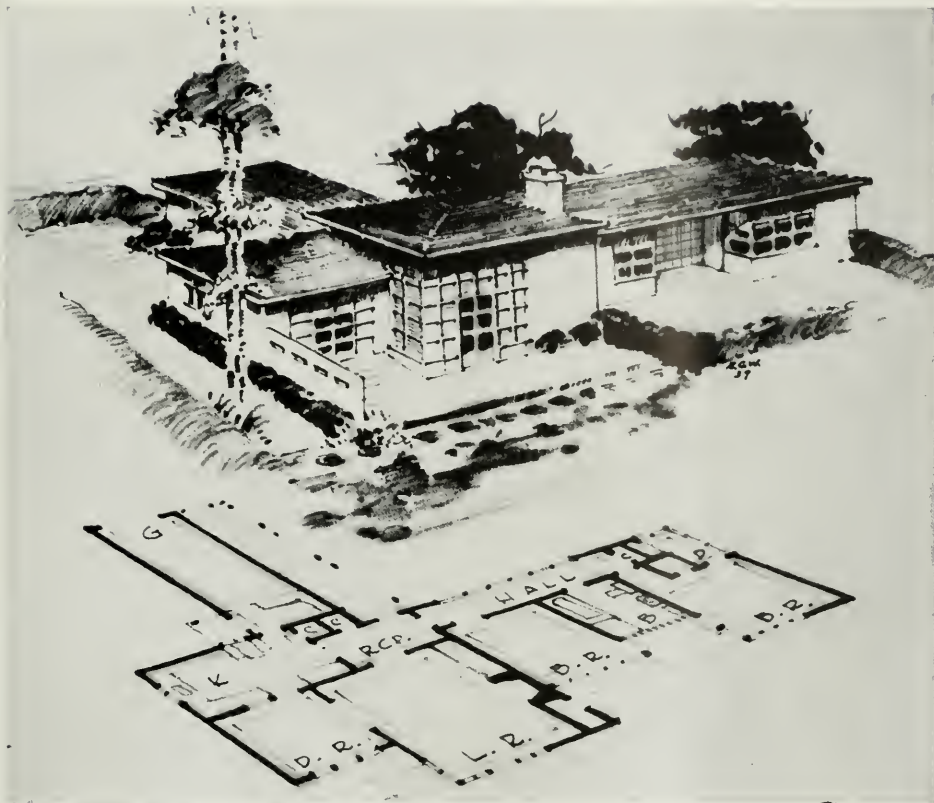

CALIFORNIA HOME OF THE WEST, TREASURE ISLAND

Vincent G. Rainey and Loy Chamberlain, Architects

A HOUSE THAT MANY ARCHITECTS HAVE DREAMED OF BUILDING

THE "California Home of the West," a completely equipped California modern residence, is the most recent effort of the building industry to stimulate interest in home construction by reaching directly thousands of daily visitors to the Golden Gate International Exposition. This latest Treasure Island model home is sponsored by the Construction Industry Section of the San Francisco Chamber of Commerce, a co-operative organization embracing every phase of the construction industry.

The house itself is of special architectural interest, representing the most advanced ideas in design and building methods. It was designed by Vincent G. Rainey and Loy Chamberlain on behalf of the State Association of California Architects. Opportunities presented in its

planning are what every architect dreams of and often wishes his clients would allow him to execute.

Organization, orientation and livability feature the plan. It provides for private recreation, sun bathing and comfort separated from guest reception and garden enjoyment. Many unique features are incorporated, among which are a bathroom with glass brick wall and a cafe style breakfast counter which can be transformed into a bar or counter for buffet dining. The house is all-gas, equipped with the most modern facilities for cooking, heating, refrigeration and water heating.

The owner of this home can permit guests to enjoy being their own hosts with minimum effort. Briefly, it is planned for efficient service of those things which are ordinarily drudgery. Maximum livability is woven about an intimate relation to garden and sunshine.

HOMES AND OFFICES OF FUTURE TO BE SHAPED BY SOUND

BUILDINGS shaped by sound, rather than by geometry alone, may add a strange new beauty to the architecture of tomorrow, asserted J. P. Maxfield and C. C. Potwin of Electrical Research Products at the tenth anniversary meeting of the Acoustical Society of America, held in New York last month. The acoustic factor has grown so important in the eyes of architects that today the requirements of good listening are beginning to exert a profound influence on the appearance of new structures, they added.

This is particularly true where good acoustics are essential, as in auditoriums, concert halls, and other rooms where people gather to enjoy speeches or musical entertainment. The demands of proper acoustics are now taken into account when the plans for a building are drawn, in contrast with the former practice of waiting until it was finished and then applying corrective treatment. Surprisingly, modern architects have found that, by following the acoustic requirements closely, in design, new shapes and contours of added beauty have often resulted.

Following the work of Professor Wallace Sabine and others, Maxfield and Potwin point out, more effective methods have been developed for solving the problems of acoustic planning. One particular method, which they describe in detail, promises to become highly important to architects. It involves co-ordinating the shape of the room with the placement of sound absorbing material in such manner that undesirable sound reflections and echoes are dispersed and blended to produce a more pleasing acoustic effect. It also calls for a more scattered arrangement of the sound absorbing materials or "padding," and makes it possible to create good listening conditions even in spaces of most unconventional basic design.

At this same meeting Dr. Vern O. Knudsen, University of California physicist and inventor of the "ear defender," told members of the Acoustical Society of America what the future held in store for the ear. New sounds to be created, new musical thrills in the offing, as well as such comforts as noise reducing agents, better hearing aids individually fitted to individual ears, and the "ear defender," his own invention that will protect not only one's hearing but the entire nervous system, were all predicted and a few offered. "The golden age of sound should be just around the corner," he asserted.

The ear, unlike the eye, is without natural means of protection such as eyelids, and therefore Dr. Knudsen argues man must use his own ingenuity to avoid unwanted noise. In the "ear defender," a small stopper-like device, this is done and noise incident to such occupations as riveting, drilling, forging, hammering, weaving, etc., no longer deafens the hearer provided with

the device. It has even been found that the efficiency of typists decreases as their machines increase in noise. Girls armed with "ear defenders" will no longer suffer the occupational disease of typewriting—"eraseritis."

But most important, however, was that part of his paper devoted to the sounds of the future. The Society learned that new and novel sound treats were in store for mankind. Dr. Knudsen has been busy for several years, he revealed, in studying sound production and its basis. Working from scratch he is ready to build new instruments capable of new sounds, pitches, volumes, etc. How orchestras and instrumental ensembles of the future will sound, how much richer hearing will be, how much more silent will annoying noises become, how much keener the defective in hearing will hear with improved hearing aids—this is the **Ear to the Future** as presented before the Acoustical Society of America.

In concluding his reverie, Dr. Knudsen predicted the almost total elimination of "that universal nuisance—noise." He looked forward to the twentieth anniversary of the Acoustical Society when its members would celebrate their contributions to "the making of a more quiet world, to aiding the hard of hearing, to joining hands with those who gladden the heart with music."

WARNING TO "BOGUS" INSPECTORS

At a recent meeting in the Northern California district office of the Federal Housing Administration in San Francisco, attended by FHA officials from Washington and presided over by D. C. McGinness, district director, and Douglas S. Manuel, production manager, warning was issued to the public that no person, "be he a representative of a labor or employer organization, has the right to enforce the minimum construction requirements of the FHA in this area."

"This matter of enforcement is exclusively in the hands of FHA and their authorized representatives," it was also stated. Complaints have been received lately that self-constituted "inspectors" have been attempting to usurp this function of FHA inspectors.

Before a house is eligible for an FHA-insured mortgage loan, plans must meet definite standards and requirements. When a new home is being constructed, periodic checks are made and the entire project is subject to FHA inspections by men trained for this purpose and who carry government credentials, local FHA officials warned.

This protection is a safeguard to both the borrower's investment and his physical comfort, FHA officials also pointed out at the meeting. It assures him, they state, a home that is suitably designed and structurally sound, built of good materials, protected against shoddy workmanship, and checked for compliance with plans and specifications.

CITY TRAFFIC CONGESTION AS AN ARCHITECT'S PROBLEM

By Charles Cressey, Architect

WHY is it, that a profession which once had front rank men attacking city traffic congestion problems has lately yielded leadership to others chiefly interested in dealing with effects rather than causes?

Probably there is a lull, pending conclusions on metropolitan road problems, or in part due to a popular impression that traffic questions are a matter of roadways and regulations—with buildings regarded as so many unavoidable obstructions.

Despite new highways, excellent underpass ideas, and splendid police work, congestion in central business areas is often worse than before. Channels of traffic flow are streamlined and obstructions cleared, only to deliver more people and more goods into city centers ill-planned to act as spreading grounds.

It has been accepted far too readily that auto traffic congestion must be cured first—and at any cost—usually by robbing costly city buildings of already limited area, and telling foot traffic to chase itself. As a matter of fact, if a solution for foot traffic interference could be found first, and the auto-parking system next met in a practical way, most of the auto traffic troubles in city centers would disappear or be greatly simplified. That is why city traffic congestion is largely an architect's problem.

To illustrate one field for architectural activity: In 1934 (See Southwest Builder and Contractor, Aug. 19th, 1934. "Modernization of Business and Business Buildings") I proposed modernization plans basically dealing with relief of sidewalk traffic congestion. Summarizing these suggestions were:

1. Unified modernization of city buildings, on a block by block basis, to permit free flow of pedestrian traffic within existing building lines.
2. Block grouping of vertical transportation on a "joint service" plan, instead of wasteful private elevators.
3. Cross-connection of entrance, lobbies, and public areas.
4. Inter-communication between floors and ground floor premises, also upper floors at regulated levels.
5. Zoned business areas, with side-walks regarded chiefly as landings for traffic.
6. Unified basement for auto-parking, direct access to elevators and direct delivery of goods (replacing alleys).
7. A "Concourse Plan" based on co-operative merchandising space, with division walls reduced to a minimum.

With this system, cross-connection of existing ground floor units would approximate the concourse plan—in fact many hotel lobbies, elevator entrances, bank halls, department stores, and markets, already closely realize the concourse idea, lacking only unification.

Unified basements offer a big field for traffic relief—all the way from a low-elevation rapid transit system—a wholesale auto-parking plan—or major access for goods; division of public utilities is an admitted problem in this connection, but the advantages, too, are obvious, notably accessibility for utilities without interfering with traffic. There would be worse problems to face before any high-level transit system could become an accomplished fact.

One primary cause of sidewalk congestion is the single front business unit, with its inevitable return of pedestrians again and again into an already crowded traffic stream. Interior communication through existing division walls would dilute this congestion, especially if cross-connected street to street. It is common to see stores more or less without customers, when sidewalks are crowded, yet open front merchants are making active sales. It is a question of customer contact, and the concourse plan provides this exceptionally well.

There are many small-scale examples, old and new, but nothing on a traffic-plan basis, such as would break down that common blockade of division walls between business premises. Could a Goldberg cartoon be any funnier or more futile, than the travel-diagram of an average pedestrian making a round of city calls.

With ordinary team-work between associated interests, the concourse plan in its many adaptable phases, seems to provide a prompt, simple, and low cost form of traffic relief, plus a cure for many merchandising troubles and a major contribution to public comfort and welfare.

CONSTRUCTION ENGINEER NAMED

Two important personnel changes in the Bureau of Reclamation, resulting from the prospect of early commencement of work on the Friant Dam near Fresno, California, are announced by Secretary of the Interior Harold L. Ickes.

Roy B. Williams, Assistant Commissioner, Bureau of Reclamation, has been designated as Construction Engineer of the Friant Division of the Central Valley Project, California. Harry W. Bashore, Construction Engineer of the Kendrick Project, Wyoming, will take over Mr. Williams' duties in Washington as Assistant Commissioner.

WASHINGTON STATE CHAPTER

The members of Washington State Chapter, A.I.A., paid a goodwill tour to Washington State College May 19. Tacoma architects also attended.

New members of the Chapter include Clifton J. Brady, Bruce Hopkins, Leslie Peterson and Stephen Richardson, the last three being junior associate members.



OVER TO MILLION SQ. FT. OF PLYWOOD USED ON TREASURE ISLAND

Douglas Fir Plywood is either the principal structural material or is used extensively in each of the California State and County Buildings marked with a star on this south-east quarter of the Golden Gate Exposition.

The Federal Building below is an outstanding example of plywood construction. Other plywood-use buildings include:

- Women's Club Building
- Cavalade Building
- French Pavillion
- Hydrosphere Building
- Brazil Building
- Netherlands Building
- and many, many others.

They're both PLYWOOD FAIRS!

AT NEW YORK . . . You are cordially invited to visit the Douglas Fir Plywood House in the Town of Tomorrow.

AT TREASURE ISLAND . . . Be sure to see the Plywood Exhibit in the Homes and Gardens Building. Notice also the many striking exposition buildings made of Plywood.

If you're Fair-bound this summer, East or West, please accept our invitation to visit the Douglas Fir Plywood displays. The Plywood House in the New York World's Fair is a brilliant example of the new Dri-Bilt with Plywood method of construction that is sweeping the country. On Treasure Island, you will be interested in seeing the Plywood Exhibit and learning how more than 10,000,000 square feet of this engineered lumber were used in the exposition buildings, Douglas Fir Plywood Association, Tacoma, Wash.

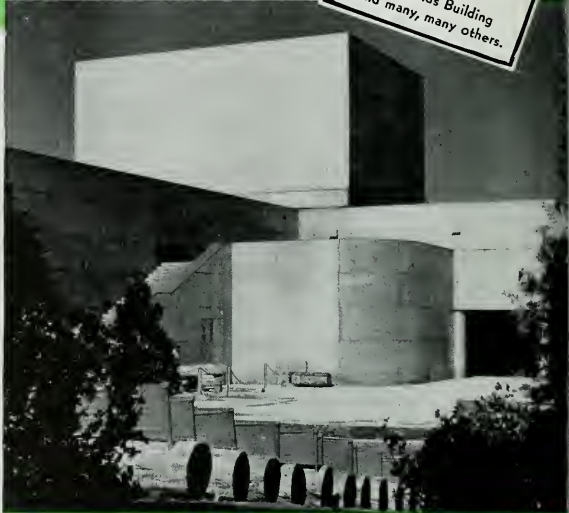

Below: You've read about the Dri-Bilt with plywood method of construction. This Plywood House in the Town of Tomorrow, designed by F. Lawrence Kocher, shows how very practical this revolutionary new method really is.

DOUGLAS FIR PLYWOOD
Real Lumber
**MADE LARGER, LIGHTER
 SPLIT-PROOF
 STRONGER**



Don't miss seeing this beautiful Plywood House if you visit the New York World's Fair. Send for free manual which tells about Dri-Bilt with Plywood construction.

NORTHERN CALIFORNIA CHAPTER

The regular monthly meeting of the Northern California Chapter, A.I.A., was held at the Alexander Hamilton Hotel in San Francisco Tuesday, May 23, President James H. Mitchell presiding.

Mr. Haas, Chairman of the Committee on Relations with the Construction Industry, announced a proposed competition for "A House on a Twenty-five Foot Lot," and asked for a discussion of the matter. The Producers' Council, which suggested the competition, wished to learn the opinion of the meeting.

Motion by Mr. Stringham, seconded by Mr. Ambrose: That the proposed competition be referred to the Board of Directors for action. Passed.

Mr. Howard, Chairman of the Committee on Education and Registration, told of plans to enable architectural students at the University of California to visit the offices of various members of the profession. Sentiment of the meeting favored the scheme.

Messrs. Bakewell, Frick, Hurd, Howard, Mitchell, Stringham and Wurster were elected as delegates to serve at the seventy-first convention of the A.I.A., to be held September 25 to 28, 1939, in Washington, D. C. Messrs. Clark, Devine, Evers, Maury, and Wyckoff were elected to serve as alternates.

Mr. Maury outlined the situation concerning the office of State Architect.

Motion by Mr. Maury, seconded by Mr. Evers: That a resolution be drafted describing the situation and urging the appointment of one of the three licensed architects determined to be eligible by the Civil Service examination. That copies of this resolution be sent to the Governor and to the State Department of Public Works. Passed.

Motion by Mr. Masten, seconded by Mr. Daniels: That copies of the resolution also be sent to the State Association of California Architects, all Institute Chapters in the State of California, the local Chapters of the American Society of Civil Engineers and the Producers' Council. Passed.

Mr. Weihe, Institute Representative for the Chapter on Competitions, reported that in the recent Smithsonian Institute competition staged by the Federal Government, a reasonable fee had been allotted, together with the privilege to the winning architect to conduct the work in his own office.

Mr. Weihe also mentioned the proposed change in competition procedure, establishing 12 o'clock noon at the city where the drawings are being prepared as the time limit, rather than the present rule of 12 o'clock noon Eastern Standard time.

The Unification Plan was discussed, and the need of understanding between all interested groups was stressed. Suggestion was made that the Chapter take steps to further this aim.

The program for the meeting consisted of brief reviews and comments upon various books pertaining to

STREAMLINED BUILDINGS

(Concluded from page 46)

Aside from all other complicated questions the one which is paramount in the minds (and hearts if you will) of those who will occupy these dwellings is the appearance and environment. They should be domestic. Consideration of economy would eliminate every feature except as necessitated by the simplest requirements of durable shelter. Such requirements produce in general the net result, in appearance of a factory. Now here it would seem is a field for the modernist, yet it has been conclusively shown by careful estimates that the modern streamlining, his fenestration and other calculated effects are not economical nor does his style satisfy the inherent demand for some measure of domesticity.

"Now it appears that this desirable characteristic is psychologically based on tradition rather than sophistication and therefore it will be found that in the most successful examples to date of low cost housing in this country there is an attempt to adapt very simple detail motives based on the colonial or Georgian. It is altogether possible and probable that other forms will be adopted which will be satisfactory but the simple fact remains that so far it hasn't been found economical to depart from some form of tradition or expression in the low cost housing field. It may well be argued that the best modernists in this country have not busied themselves with this problem. It is my belief that if they have not done so it is because they recognize the difficulty involved in the obvious requirements.

"Simply stated the vocabulary of the modernist just doesn't solve the problem insofar as this country is concerned.

"I suppose that most all architects who are not out and out egoists have eternally that sense of frustration which is a matter of conscience and conscience is guilt and most of our guilt, it seems to me, is that in following the crowd we are denying our freedom that we may satisfy an easy security."

Architecture and the Allied Arts by Messrs. Daniels, Moise and Morrow.

Mr. Daniels reviewed a "History of Mosaics" by

(Turn to page 69)

BOOK REVIEWS

ROMANCE OF THE NATIONAL PARKS: By Harlean James, The Macmillan Company, New York City, N. Y. Price: \$3.00.

A very fine book relative to those great national playgrounds to which every American should turn with pride. The photography is superb and the text will yield the reader information concerning his heritage which will give food for thought. The territory covered in this book embraces the 7,000,000 acres of national parks from Maine to California, from Minnesota to Florida, with sections given over to description of areas in Alaska and Hawaii.

THE WORLD OF PLANT LIFE: By Clarence Hylander, The Macmillan Company, New York City, N. Y. Price: \$7.50.

Here is gathered together in one work a comprehensive mass of data and facts about plants. Practically every variety of common type of plant is classified and discussed. Bacteria and orchids, seaweed ferns, marsh plants and the exotic and weird plants of tropic and desert are spread out for the edification and delight of the reader. A truly remarkable book.

THE OLD WATER MILLS OF NORFOLK: By Claude J. W. Messent, A.R.I.B.A., Fletcher & Son, Norwich, Norfolk. Price: 6 Shillings (\$1.50 Approx.)

A book on a subject little known in this country and one of great charm. The illustrations are delightful and the text contains information of historical value. Apparently the majority of these fascinating water mills in England are situated within the confines of Norfolk, at least we gather from the author that those now remaining are grouped in that county. To the lover of the quaint and of the English countryside this book will have a considerable appeal.

DATA BOOK ON GAS UTILIZATION: By H. Roy Kelley, A.I.A., Published by The Pacific Coast Gas Association, 447 Sutter Street, San Francisco.

An excellent handbook of important data gathered and edited by one of the outstanding architects of the Pacific Coast. Mr. Kelley has done a fine piece of work and is to be complimented. The information will be of value to all members of the profession and to those engineers and special contractors who, keenly alive to the advances of modern building installations, endeavor at all times to keep abreast of the changes and improvements. There is much technical detail with tables, scales and diagrams.

SPARKS, LIGHTNING, COSMIC RAYS: By Dayton C. Miller, The Macmillan Company, New York, N. Y. Price: \$2.50.

A most interesting book including in its topics the numerous researches in radioactivity and cosmic rays,

the electrical experiments of the early Greeks, and the contributions to the field of electrical science of Benjamin Franklin. There is a philosophic presentation of the growth of the ideas surrounding the nature of electricity with historically important events authoritatively chronicled. This book is worthy of being read thoughtfully. It contains useful references to the most intriguing of the sciences—that of electricity.

TWENTY YEARS OF ARCHITECTURE IN ESTONIA:

Published for The Estonian Government. A. Wasserman, Bookseller, Tallinn, Estonia. Price: \$2.00.

Photographs, architectural and landscape, bound in boards and with translations into English, French and German. After carefully going through this book one has at least an idea of the beauties of this Baltic country. Some of the rural homes shown are delightful and might well fit into our northern areas.

VISIT EAST FOR PLEASURE—AND BUSINESS

John E. Traynor, manager of the Haws Drinking Faucet Company of Berkeley, and Mrs. Traynor, who for many years carried on the business of the firm upon the death of her father, recently made an enjoyable trip East which included the principal cities in the New England and Middle West States. While in New York the Traynors visited the Fair and after seeing it decided our own at Treasure Island is indeed something to be proud of. The New York Fair, of course, is much larger but no more colorful or interesting than the Golden Gate Exposition, they say.

In visiting many of the large Eastern cities the Traynors took particular pains to note the number of drinking fountains in use in public buildings, parks, schools and gas stations. They were disappointed in the small number. Mr. Traynor says California has more drinking fountains than all the large eastern centers put together. However, the public is just beginning to realize the convenience and advantages of sanitary fountains and the next year or two will probably see a very considerable increase in the number of installations in the East. In anticipation of the demand the Haws Company will have eastern representation, arrangements having been completed for a prominent Newark, N. J., firm to handle the fountains.

A new type of Haws wall fountain has been perfected which will be on the market shortly. Wall hung, similar to the popular Manhattan but plainer and less expensive, the fixture is expected to be extensively specified by architects of schools and other public buildings.

HEATING ENGINEER ADDRESSES ARCHITECTS

Erwin L. Weber, heating engineer of Seattle, addressed a meeting of Portland Chapter, A.I.A., on May 16, at Lloyd's golf course. He illustrated his talk on panel and radiant heating with lantern slides. Everett High School is the only building in the Pacific Northwest which is heated by this method.

Estimator's Guide

Giving Cost of Building Materials, Wage Scale, Etc.

Amounts given are figuring prices and are made up from average quotations furnished by material houses to San Francisco contractors. 3% Sales Tax on all materials but not labor.

All prices and wages quoted are for San Francisco and the Bay District. There may be slight fluctuation of prices in the interior and southern part of the state. Freight cartage, at least, must be added in figuring country work.

Bond—1/2% amount of contract.

Brickwork—

Common, \$40 to \$45 per 1000 laid, (according to class of work).
Face, \$100 to \$110 per 1000 laid, (according to class of work).
Brick Steps, using pressed brick, \$1.25 lin. ft.
Brick Veneer on frame buildings, \$.75 sq. ft.
Common f.o.b. cars, \$14.00 at yard. Cartage extra.
Face, f.o.b. cars, \$45.00 to \$50.00 per 1000 carload lots.

HOLLOW TILE FIREPROOFING (f.o.b. job)

3x12x12 in. \$ 84.00 per M
4x12x12 in. 94.50 per M
6x12x12 in. 126.00 per M
8x12x12 in. 225.00 per M

HOLLOW BUILDING TILE (f.o.b. job)

carload lots.
8x12x5/2 \$ 94.50
6x12x5/2 73.50

Building Paper—

1 ply per 1000 ft. roll \$3.50
2 ply per 1000 ft. roll 5.00
3 ply per 1000 ft. roll 6.25
Brownskin, 500 ft. roll 4.50
Brownskin, Pro-tect-o-mat, 1000 ft. roll 9.00
Sisalraft, 500 ft. roll 5.00
Sesh cord com. No. 7 \$1.20 per 100 ft
Sesh cord com. No. 8 1.50 per 100 ft
Sesh cord spot No. 7 1.90 per 100 ft
Sesh cord spot No. 8 2.25 per 100 ft
Sesh weights cast iron, 550.00 ton.
Nails, \$3.50 base.
Sesh weights, \$45 per ton.

Concrete Aggregates—

Gravel (all sizes) \$1.45 per ton at bunker; delivered to any point in S. F. County \$1.85.
Bunker Delivered
Top sand \$1.45 \$1.85
Concrete mix 1.45 1.85
Crushed rock, 1/4 to 3/4 1.60 2.00
Crushed rock, 3/4 to 1 1/2 1.60 2.00
Roofing gravel 1.60 2.00
City gravel 1.45 1.85
River sand 1.40 1.80
Delivered bank sand—\$1.00 per cubic yard at bunker or delivered.

SAND— Bunker Delivered
River sand \$1.40 \$1.80
Lapis (Nos. 2 & 4) 2.00 2.40
Olympia Nos. 1 & 2 1.80 2.20
Healdsburg plaster sand \$1.80 and \$2.20
Del Monte white50c per sack

CEMENT (all brands, cloth sacks) \$2.72 per bbl. f.o.b. car; deliv. \$2.90 per bbl., carload lots; less than carload lots, warehouse or delivered, 80c per sack. (Less 10c per sack returned, 2% 10th Prox.)

Common cement (all brands, paper sacks) carload lots \$2.52 per bbl. f.o.b. car; delivered, \$2.70; less than carloads delivered, 75c per sack. Discount on cloth sacks, 10c per sack.
Cash discount on carload lots, 10c a barrel, 10th Prox.; cash discount less than carload lots, 2%.

Atlas White (1 to 100 sacks, \$1.50 sack, warehouse or delivery; over 100 sacks, \$1.25; 2% discount 10th of month)
Culveras White
Medusa White

Forms, Labors average \$40.00 per M.
Average cost of concrete in place, exclusive of forms, 35c per cu. ft.; with forms, 60c.
4-inch concrete basement floor 12/2c to 14c per sq. ft.
Ret-proofing 7/2c
Concrete Steps \$1.25 per lin. ft.

Dampproofing and Waterproofing—

Two-coat work, 20c per yard.
Membrane waterproofing—4 layers of saturated felt, \$4.50 per square.
Hot coating work, \$1.80 per square.
Medusa Waterproofing, 15c per lb., San Francisco Warehouse.
Tricocel waterproofing.
(See representative.)

Electric Wiring—\$12.00 to \$15.00 per outlet for conduit work (including switches).
Knob and tube average \$3.50 per outlet.

Elevators—

Prices vary according to capacity, speed and type. Consult elevator companies.
Average cost of installing an automatic elevator in four-story building, \$2800; direct automatic, about \$2700.

Excavation—

Send, 60 cents; clay or shale \$1 per yard.
Teams, \$12.00 per day.
Trucks, \$22 to \$27.50 per day.
Above figures are an average without water. Steam shovel work in large quantities, less; hard material, such as rock, will run considerably more.

Fire Escapes—

Ten-foot galvanized iron balcony, with stairs, \$115 installed on new buildings; \$140 on old buildings.

Floors—

Composition Floors—22c to 40c per sq. ft. In large quantities, 16c per sq. ft. laid.
Mosaic Floors—80c per sq. ft.
Duraflex Floors—23c to 30c sq. ft.
Rubber Tile—50c to 75c per sq. ft.
Terazzo Floors—45c to 60c per sq. ft.
Terazzo Steps—\$1.60 lin. ft.

Hardwood Flooring (delivered to building)—

	1 1/2" x 4"	3/4" x 2"	5/8" x 2"
	13/8"	1 1/8"	5/8"
Clr. Qtd. Oak	\$141.00 M	\$109.00 M	\$133.50 M
Sel. Qtd. Oak	118.00 M	97.00 M	106.50 M
Clr. Pla. Oak	117.00 M	101.00 M	107.50 M
Sel. Pla. Oak	97.00 M	90.00 M	99.00 M
Clr. Maple	120.00 M	94.50 M	

Wage—Floor layers, \$10.00.
Note—Above quotations are all board measure except last column which is sq. ft.

Glass (consult with manufacturers)—

Double strength window glass, 20c per square foot.
Plate 75c per square foot (unglazed) in place, \$1.00.
Art \$1.00 up per square foot.
Wire (for skylights), 40c per sq. foot.
Obscure glass, 30c square foot.
Glass bricks, \$2.40 per sq. ft., in place.
Note—If not stipulated add extra for setting.

Heating—

Average, \$1.90 per sq. ft. of radiation according to conditions.
Warm air (gravity) average \$40 per register.
Forced air average \$60 per register.

Iron—Cost of ornamental iron, cast iron, etc., depends on designs.

Lumber (prices delivered to bldg. site).

No. 1 common \$29.00 per M
No. 2 common 27.00 per M
Select O. P. common 34.50 per M
2x4 No. 3 form lumber 24.00 per M
1x4 No. 2 flooring VG 55.00 per M
1x4 No. 3 flooring VG 47.00 per M
1x6 No. 2 flooring VG 60.00 per M
1 1/4 x 4 and 6, No. 2 flooring 60.00 per M
Slash grain—
1x4 No. 2 flooring \$43.00 per M
1x4 No. 3 flooring 40.00 per M
No. 1 common run T. & G. 30.00 per M
Lath 5.25 per M
Shingles (add cartage to price quoted)—
Redwood, No. 1 \$1.10 per bble.
Redwood, No. 290 per bble.
Red Cedar 1.10 per bble.

Plywood—Douglas Fir (add cartage)—

"Plyscord" sheathing (unsanded)
5/16" 3-ply and 48"x96" \$32.50 per M
"Plywall" (wallboard grade)—
1/2" 3-ply 48"x96" \$35.00 per M
"Plyform" (concrete form grade)—
5/8" 5-ply 48"x96" \$100.00 per M
Exterior Plywood Siding—
7/16" 5-ply Fir \$ 90.00 per M
Redwood \$100.00 per M

Millwork—Standard.

O. P. \$85.00 per 1000. R. W., \$90.00 per 1000 (delivered).
Double hung box window frames, average with trim, \$6.50 and up, each.
Doors, including trim (single panel, 1 3/4 in. Oregon pine) \$8.00 and up, each.
Doors, including trim (five panel, 1 3/8 in. Oregon pine) \$6.00 each.
Screen doors, \$3.50 each.
Patent screen windows, 25c a sq. ft.
Cases for kitchen pantries seven ft. high per lineal ft., \$8.00 each.
Dining room cases, \$8.00 per lineal foot. Rough and finish about 75c per sq. ft.
Labor—Rough carpentry, warehouse heavy framing (average), \$17.50 per M.
For smaller work average, \$35.00 to \$45.00 per 1000.

Marble—(See Dealers)

Painting—

Two-coat work	per yard	42c
Three-coat work	per yard	60c
Cold water painting	per yard	10c
Whitewashing	per yard	4c
Turpentine, 65c per gal., in 5 gal. cans, and 55c per gal. in drums.		
Raw Linseed Oil—86c gal. in bbls.		
Boiled Linseed Oil—89c gal. in bbls.		
Medusa Portland Cement Paint, 20c per lb.		

White Lead in oil

	Per Lb.	
1 ton lots, 100 lbs. net weight	11 1/4c	
500 lbs. and less than 1 ton	11 1/2c	
Less than 500 lb. lots	12c	

Red Lead and litharge

1 ton lots, 100 lbs. net weight	11 1/4c
500 lbs. and less than 1 ton	11 1/2c
Less than 500 lb. lots	12c

Red Lead in oil

1 ton lots, 100 lbs. net weight	11c
500 lbs. and less than 1 ton	11 1/4c
Less than 500 lb. lots	12 1/4c

Note—Accessibility and conditions cause some variance in costs.

Patent Chimneys—

6-inch	\$1.25 lineal foot
8-inch	1.75 lineal foot
10-inch	2.25 lineal foot
12-inch	3.00 lineal foot

Plastering—Interior—

	Yard
1 coat, brown mortar only, wood lath	\$0.60
2 coats, lime mortar hard finish, wood lath72
3 coats, metal lath and plaster	1.25
Keene cement on metal lath	1.30
Ceilings with 3/4 hot roll channels metal lath (lathed only)	1.10
Ceilings with 3/4 hot roll channels metal lath plastered	1.85
Single partition 3/4 channel lath 1 side (lath only)85

Single partition 3/4 channel lath 2 inches thick plastered	\$2.90
4-inch double partition 3/4 channel lath 2 sides (lath only)	1.70
4-inch double partition 3/4 channel lath 2 sides plastered	3.80
Thermax single partition; 1" channels; 2 1/2" overall partition width. Plastered both sides	2.50
Thermax double partition; 1" channels; 4 1/2" overall partition width. Plastered both sides	3.10
3 coats over 1" Thermax nailed to one side wood studs or joists	1.25
3 coats over 1" Thermax suspended to one side wood studs with spring sound isolation clip	1.40

Plastering—Exterior—

2 coats cement finish, brick or concrete wall	\$1.00
3 coats cement finish, No. 18 gauge wire mesh	1.50
Wood lath, \$7.50 to \$8.00 per 100017
2.5-lb. metal lath (dipped)20
3.4-lb. metal lath (dipped)22
3.4-lb. metal lath (galvanized)28
3/4-inch hot roll channels, \$72 per ton. Finish plaster, \$18.90 ton; in paper sacks. Dealer's commission, \$1.00 off above quotations. \$13.85 (rebate 10c sack)	
Lime, 60-bb. warehouse, \$2.25 bbl.; cars, \$2.15 Lime, bulk (ton 2000 lbs.), \$16.00 ton. Wall Board 5 ply, \$50.00 per M. Hydrate Lime, \$19.50 ton.	
Plasterers' Wage Scale	\$1.67 per hour
Lathers' Wage Scale	1.50 per hour
Hod Carriers' Wage Scale	1.25 per hour
Composition Stucco—\$1.80 to \$2.00 sq. yard (applied).	

Plumbing—

From \$70.00 per fixture up, according to grade, quantity and runs.

Roofing—

"Standard" tar and gravel, \$6.50 per sq. for 30 sqs. or over.
 Less than 30 sqs. \$7.00 per sq.
 Tile, \$20.00 to \$35.00 per square.
 Redwood Shingles, \$7.50 per square in place.
 Copper, \$16.50 to \$18.00 per sq. in place.
 Cedar Shingles, \$8.00 per sq. in place.
 Recoit, with Gravel, \$3.00 per sq.
 Asbestos Shingles, \$15 to \$25 per sq. laid.

Slate, from \$25.00 per sq., according to color and thickness	
Shakes—125" resawn	\$11.50 per sq.
1/2x25" resawn	10.50 per sq.
1/2x25" tapered	10.50 per sq.
Above prices are for shakes in place.	

Sheet Metal—

Windows—Metal, \$1.75 a sq. foot.
 Fire doors (average), including hardware, \$1.75 per sq. ft.

Skylights—(not glazed)

Copper, 90c sq. ft. (flat).
 Galvanized iron, 30c sq. ft. (flat).
 Vented hip skylights 60c sq. ft.

Steel—Structural

\$120 ton (erected), this quotation is an average for comparatively small quantities. Light truss work higher. Plain beams and column work in large quantities \$90 to \$100 per ton.

Steel Reinforcing—

\$80.00 to \$120.00 per ton, set.

Stone—

Granite, average, \$6.50 cu. foot in place
 Sandstone, average Blue, \$4.00, Boise, \$3.00 sq. ft. in place.
 Indiana Limestone, \$2.80 per sq. ft. in place.

Store Fronts—

Copper sash bars for store fronts, corner, center and around sides, will average 75c per lineal foot.
 Note—Consult with agents.

Tile—Floor, Wainscot, etc.—(See Dealers)

Asphalt Tile—18c to 28c per sq. ft. installed.

Wall Tile

Glazed Terra Cotta Wall Units (single faced) laid in place—approximate prices:
 2 x 6 x 12

4 x 6 x 12

2 x 8 x 16

4 x 8 x 16

Venetian Blinds—

40c per square foot and up. Installation extra.

THE BUILDERS' EXCHANGE OF SAN FRANCISCO STANDARD WAGE SCALE

For mechanics employed on construction work in the Bay Region. Effective September 1, 1937

CRAFT	Journeymen Mechanics
Asbestos Workers	\$ 8.00
Bricklayers (6h-5d)	10.50
Bricklayers' Hodcarriers (6h-5d)	6.75
Cabinet Workers (Outside) (5d)	8.00
Calsson Workers (Open)	6.40
Carpenters (8h-5d)	10.00
Cement Finishers (8h-5d)	10.00
Cork Insulation Workers (8h-5d)	9.00
Electric Workers (8h-5d)	11.00
Electrical Fixture Hangers	8.00
Elevator Constructors	10.40
Engineers, Portable & Hoisting	9.00
Glass Workers (8h-5d)	9.68
Hardwood Floorers	9.00
Housemiths, Architectural Iron (Shop) (8h-5d)	9.00
Housemiths, Architectural Iron (Outside) (8h-5d)	10.00
Housemiths, Reinforced Concrete or Rodmen (8h-5d)	10.00
Iron Workers (Bridge and Structural) Including Engineers (8h-5d)	12.00

CRAFT	Journeymen Mechanics
Laborers, Building (8h-5d)	\$ 6.00
Laborers, Common (8h-5d)	6.00
Lathers, Channel Iron (6h-5d)	9.00
Lathers, All Others	9.00
Marble Setters (8h-5d)	10.50
Marble Setters' Helpers (8h-5d)	6.50
Millwrights	9.00
Model Makers (\$1.50 per hr-6h)	9.00
Modelers (\$2 per hr-6h)	12.00
Model Casters	7.20
Mosaic and Terrazzo Workers (Outside)	9.00
Painters (7h-5d)	8.75
Painters, Varnishers and Polishers (Outside)	9.00
File Drivers and Wharf Builders	9.00
File Drivers' Engineers	10.00
Plasterers (6h-5d)	10.00
Plasterers' Hodcarriers (6h-5d)	7.50
Plumbers (6h-5d)	11.00
Roofers, Composition (8h-5d)	9.00
Roofers, All Others (8h-5d)	8.00
Sheet Metal Workers (8h-5d)	10.00
Sprinkler Fitters	10.00

CRAFT	Journeymen Mechanics
Steam Fitters (8h-5d)	\$11.00
Stair Builders (8h-5d)	9.00
Stone Cutters, Soft and Granite (8h-5d)	8.00
Stone Setters, Soft and Granite	12.00
Stone Darricmen	9.00
Tile Setters (8h-5d)	11.00
Tile Setters' Helpers (8h-5d)	6.50
Tile, Cork and Rubber (8h-5d)	9.00
Welders, Structural Steel Frame on Buildings	11.00
Welders, All Others on Buildings	9.00
Dump Truck Drivers, 2 yards or less	6.00
Dump Truck Drivers, 3 yards	6.50
Dump Truck Drivers, 4 yards	7.00
Dump Truck Drivers, 5 yards	7.00
Dump Truck Drivers, 6 yards	7.50
Truck Drivers of Concrete Mixer Trucks:	
2 yards or less	6.50
3 yards	7.00
4 yards	7.50
5 yards	7.50
6 yards	8.00

GENERAL WORKING CONDITIONS

- Eight hours shall constitute a day's work for all crafts except as otherwise noted.
- Plasterers' Hodcarriers, Bricklayers' Hodcarriers, Roofers, Laborers, and Engineers, Portable and Hoisting, shall start 15 minutes before other workmen, both at morning and at noon.
- Five days, consisting of not more than eight hours a day, on Monday to Friday inclusive, shall constitute a week's work.
- Transportation costs in excess of twenty-five cents each way shall be paid by the contractor.
- Overtime shall be paid as follows: For the first four hours after the first eight hours, time and one-half. All time thereafter shall be paid

- double time. Saturdays (except Laborers), Sundays and holidays, from 12 midnight of the preceding day, shall be paid double time.
- On Saturday, Laborers shall be paid straight time for an eight-hour day.
 - Where two shifts are worked in any twenty-four hours, shift time shall be straight time. Where three shifts are worked, eight hours' pay shall be paid for seven hours on the second and third shifts, allowing one-half hour for lunch.
 - All work, except as noted in paragraph 9, shall be performed between the hours of 8 a.m. and 5 p.m.
 - In emergencies, or where premises cannot be vacated until the close of business, men then

- reporting for work shall work at straight time. Any work performed on such jobs after midnight shall be paid time and one-half up to four hours of overtime and double time thereafter, provided, that if a new crew is employed on Saturdays, Sundays or holidays which has not worked during the five preceding days, such crew shall be paid time and one-half.
- Recognized holidays to be: New Year's Day, Decoration Day, Fourth of July, Labor Day, Admission Day, Thanksgiving Day, Christmas Day.
 - Men ordered to report for work, for whom no employment is provided, shall be entitled to two hours' pay.

ARCHITECTS' BULLETIN

Issued For

THE STATE ASSOCIATION OF CALIFORNIA ARCHITECTS

Northern Section

STATE ASSOCIATION MEMBER
OF THE
AMERICAN INSTITUTE OF ARCHITECTS

Editor

Harris C. Allen

Address all communications for publication
in the Bulletin to the Editor (Harris C.
Allen) 557 Market Street, Room 218, San
Francisco, California.

Board of Control

Harris C. Allen Otto G. Hintermann
Harry Michelsen Wayne S. Hertzka

State Association Officers

President.....Sylvanus B. Marston, Pasadena
Vice-President.....Gwynn Officer, Berkeley
Secretary...Wayne S. Hertzka, San Francisco
Treasurer.....Robert H. Orr, Los Angeles

Regional Director, A. I. A.

Albert J. Evers, San Francisco

Delegate Regional Director, Southern
California

Gordon B. Kaufmann, Los Angeles

Executive Board—Northern Section

Officers

President.....Gwynn Officer, Berkeley
Vice-Pres.....Ernest E. Weihe, San Francisco
Secretary...Wayne S. Hertzka, San Francisco
Treasurer...Otto G. Hintermann, San Francisco

Directors

Harry J. Devine R. H. Reimers
Wm. J. Merchant Harold Weeks

Executive Board—Southern Section

Officers

President.....Sylvanus B. Marston
Vice-President.....Louis N. Crawford
Secretary.....Winsor Soule
Treasurer.....Robert H. Orr

Directors

Merrill W. Baird Abe Edelman
Harold C. Chambers George D. Riddle

Advisors—Northern Section

Harris C. Allen *San Francisco*
J. K. Ballantine, Jr. *(Secretary) Santa Clara Valley*
Sam. Lightner Hyman
Wm. G. Merchant
Jas. F. McGuiness
Dodge A. Riedy
Harold H. Weeks
Ernest E. Weihe
Albert R. Williams
Fred. H. Reimers *(President)*
C. A. Caulkins *North Bay District*
Peter Sala *Lower San Joaquin District*
J. U. Cloudsley *(Secretary)*
Edw. W. Kress *Santa Clara Valley*
Mario Corbett *San Mateo*
Alden Cambell *Sacramento*
Ernest J. Kump *Upper San Joaquin*
Dole F. Thomsen *Palo Alto*
Norman W. Sexton *Marin*
Geo. P. Simonds *East Bay*
Chester Treichel *East Bay*
Gwynn Officer *Berkeley*
F. T. Georgeson *Redwood Empire*
Casebolt Dakin *Upper Sacramento*
Ralph Taylor *Lassen District*

Architectural Practice Act

AFTER a conference in Sacramento between the Association Legislative Committee and representative engineers and contractors, minor revisions were made in the Architectural Practice Act which were satisfactory to all parties. These were to be proposed as amendments, and the bill was reported back to the Senate from Committee, approved for reading, with all open opposition removed. If passed in the Senate, no difficulty is expected in the Assembly.

It is hard to account for the delays and obstacles and the apparent confusion attending legislation which is so really simple and honest as such a purely professional regulatory measure. However, there always seems to be suspicion on the part of some interests that jokers are concealed in such bills that will curtail or injure their business prospects. The welfare of the public generally is not considered, although the prime and, indeed, the only motive of these regulatory Acts is to protect the public welfare. Human nature being what it is—and always will be—self interests produce the strongest urge to influence action, with, of course, a more or less vague feeling that public interests will not suffer greatly and will be sufficiently protected by local ordinances and inspection regulations.

Every city has "blighted sections" which bear silent but eloquent testimony to the fallacy of this belief.

Some forty architects accepted the official invitation to qualify by examination, under Civil Service rules, for the position of State Architect. Three of these were qualified as gaining the three highest ratings, from whom—again according to rule—the position should be filled.

Some time has elapsed, but no appointment has been made. In justice not only to the three so qualified, but to all those who undertook this rather arduous ordeal, at some expense of time and money, the appointment should be made from the qualified trio, without further delay. All of these gentlemen are of high professional standing.

A committee from the Associated General Contractors has been studying this complicated matter for some time, with—and welcoming—advice and assistance from architects and engineers. A recent meeting of the Building Industry Conference Board was devoted to the subject, with more discussion to follow in later meetings.

There have been many weaknesses and injustices in the old loose way of taking bids. Various methods of establishing "depositories" for bids of both general and sub-contractors have been proposed, to prevent the extremes of both collusion and "chiseling." A satisfactory system would be helpful to architects and engineers as well, for reasons obvious to all of us.

Incidentally, architects are not entirely blameless for present evils. Too often, our specifications are not clear and definite; giving the choice of alter-

nates is frequently the cause of confusion and a chance for subterfuge; owners are not clearly informed as to the value of fairness in bidding methods and in selecting contractors. In the long run, the owner loses either in cash or quality, when bids and contracts are not established on the most fair and open competition system.

Applying it to our profession, the evils of unregulated competition are too well known to need repetition here.

SOCIETY OF DRAFTSMEN The process of knitting closer and more understanding relations between the Society of Draftsmen and the Association continues, and a meeting was scheduled for the evening of June 8th to further these good relations. During the lull in office activities, the registration system has been improved and the State Association of California Architects office is in better position to meet all needs for service.

PRODUCERS' COUNCIL Our good friends the Producers, through their good Council and their good Club (no threats implied) are again looking after the education and entertainment of the architects. Having thrown an afternoon party at Treasure Island in May, they decided to follow it up with an evening affair early in June. These occasions are always cheerful and stimulating, with such genial and congenial hosts. You don't have to Prod the Producers to Prodigality.

SUBSCRIPTIONS And how about prodding the old pocket into opening up for some more subscription dues—realizing that legislation years bring heavy calls on the Association treasury? Otto Hintermann reports proudly that a larger proportion of members are paid up than for years; but it is still far from being a majority. And the activities undertaken are definitely and deliberately for the best interests of the entire profession. Five dollars will not break any practicing architect, and no one really wishes to have someone else putting up for him, if he stops to think about it that way. No contribution to the cause of architecture, and for the protection of professional practice, can be more efficient in proportion, than payment of the small Association subscription dues.

HYMAN ROSENTHAL BUSY

Hyman Rosenthal, formerly structural engineer for the San Francisco Bay Exposition Company, has resumed the private practice of structural engineering and has opened an office at 255 California Street, San Francisco. Plans were recently completed by Mr. Rosenthal for a reinforced concrete addition to the Medico Dental Building at Sacramento. At present he is making studies of the framing for a 21-story and 3-basement apartment building to be constructed at Green and Leavenworth Streets, in San Francisco.



*A service for you
...and your clients*

As the national leader in FHA financing, Bank of America's interest in better housing coincides with that of the architect and the engineer. Finer design and better construction mean a sounder investment for the home owner, a more satisfactory loan for the bank. Your interests, as well as those of your clients, will receive the friendliest consideration at Bank of America.

Bank of America
NATIONAL TRUST & SAVINGS ASSOCIATION
Member Federal Deposit Insurance Corporation



PRESSURE TREATED LUMBER
● **PROTECTS AGAINST DECAY AND TERMITE ATTACK**

*Specify it in your home
Available through Lumber Dealers*

LOS ANGELES
601 W. 5th Street
Phone Michigan 6294

SAN FRANCISCO
333 Montgomery Street
Phone DOuglas 3883

J. H. Baxter & Co.

AGENTS FOR WEST COAST WOOD PRESERVING CO. SEATTLE, WASH.

MODERNIZED PRODUCTS

Brief Notes on New Materials and Equipment in the Building Industry.

226. NEW TYPE WINDOW

The Easy Glide Window Company have put out a broadside illustrating their "Easy Glide" windows. Details of these new type windows should prove of interest. The coupon will bring you a copy.

227. FIR TIMBER

From the West Coast Lumbermen's Association has come an interesting folder on Hemlock and Fir timber. The illustrations tell a very convincing story.

228. DUTCH BOY

Dutch Boy Painter Magazine, the little booklet issued by the National Lead Company, is here again. It always has things of great interest and this number is especially good. Send for your copy by clipping the coupon.

229. "PORTAPRINT"

Eberbach and Son Company announce through a broadside a new method of prints, drawings and plans by means of their "Portaprint." This is a method of office duplicator. Full details are shown.

230. LEADED ROOFS

"Lead," magazine, put out by the Lead Industries Association, has a new number and this one, like the others, contains some interesting features. Roofs using lead are among the details shown this month. Send for your copy.

231. HEATING UNIT

The Hotstream Heater Company has an illustrated broadside of a new heating unit for use with either natural or manufactured gas. Tables of sizes, ranges and recovery capacities are included.

232. METAL TUBING

The American Brass Company has put out a very fine booklet on "Seamless Flexible Tubing." It is well illustrated and has technical details, yet is written understandably for the layman as well as the engineer. Send for a copy—use the coupon.

233. ABOUT STEEL

"Steel Facts," issued by the American Iron and Steel Institute, is worth while reading. The May issue contains some surprising figures and gives steel "facts" of interest.

234. FANS

Exhaust Fans and Ventilating Fans is the title of a booklet just issued by the Emerson Electric Company. Some interesting material is included. The fans are for both private and public buildings, large and small. Send for a copy.

235. ALLOY STEELS

The Electro Metallurgical Company has issued another "Electromet Review." This little booklet contains data of vital interest concerning alloy steels and irons. The coupon will bring you a copy.

236. GAS BURNER

A new bulletin illustrative of the Portland Type Conversion Gas Burner has been put out by the John Zink Company. Details are given of the new features such as removable working parts, filtered pilot supply, and a new price range. The coupon will bring a copy.

237. WASHROOM EQUIPMENT

The Bradley Washfountain Company's new booklet, "Washroom Layouts" is interesting and has drawings, plans and sketches of practical ideas for installation.

238. DEEP WELL PUMPS

Worthington Pump and Machinery Company has some illustrative printed material on deep well pumps and portable compressors that is very excellent. The latest departures in modern machinery of this type are here explained and illustrated. Send for a copy by using the coupon.

239. PRESSURE TREATMENT

New booklet issued by J. H. Baxter & Co. Describes "C.Z.C.," the Pressure Treatment which gives economic permanence to frame houses. Includes information for contractors and architects as well as prospective home builders.

FREE FOR THE ASKING

Check items on coupon, paste on letter head or postal card, and mail to Architect and Engineer.

Architect and Engineer
68 Post Street
San Francisco, Calif.

Please send me literature on the following items as checked below. This request places me under no obligation.

226	<input type="checkbox"/>	233	<input type="checkbox"/>
227	<input type="checkbox"/>	234	<input type="checkbox"/>
228	<input type="checkbox"/>	235	<input type="checkbox"/>
229	<input type="checkbox"/>	236	<input type="checkbox"/>
230	<input type="checkbox"/>	237	<input type="checkbox"/>
231	<input type="checkbox"/>	238	<input type="checkbox"/>
232	<input type="checkbox"/>	239	<input type="checkbox"/>

My Name.....
Name of Company.....
Street.....
City..... State.....

DO YOU HAVE THE FACTS



THE LAMINEX Streamliner

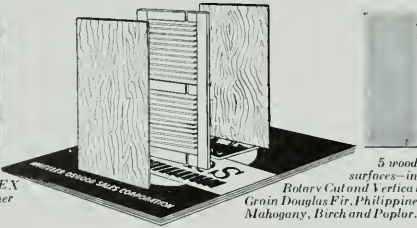

5 wood surfaces—in Botany Catwood Vertical Grain Douglas Fir, Philippine Mahogany, Birch and Poplar.

—about America's most popular modern door?

You, too, can benefit by the numerous advantages of the LAMINEX Streamliner Door. They're described and illustrated in the new No. 39 Catalog. It shows how strength, light weight, beauty and economy have all been combined in one door, for residential as well as commercial building use—illustrates how the Streamliner eliminates the difficulties frequently experienced with ordinary doors in air-conditioned rooms—indicates decoration and finish treatments which enable the Streamliner to be used in any type of interior, effectively and economically.



Write for Your FREE COPY

—contains over 200 door designs and layouts—helpful information for solving virtually any door problem.

WHEELER OSGOOD SALES CORPORATION

Factory and General Office: Tacoma, Wash. General Sales Offices: New York, Chicago
Branch Offices: Los Angeles, Dallas, Wichita, Tacoma, San Francisco
Stocks Carried in Principal Cities

The Country's Most Complete Line of Doors

A good investment—

is a well designed, well built, structure, properly located.

Lindgren & Swinerton, Inc.

have been building substantial buildings for over a half of a century, are still building them and will continue building them for another half of a century.

Lindgren & Swinerton, Inc.

Standard Oil Building
San Francisco

619 H Street
Sacramento

605 W. Olympic Boulevard
Los Angeles

1723 Webster Street
Oakland

*Modern Homes are
Air-Conditioned by*

SELECTAIR

● DESIGNED and built by the S. T. Johnson Co., pioneer manufacturers of Oil Burners, this smart new air-conditioner combines in one compact unit every feature desired by home-owners, architects and engineers for economical heating, air-conditioning and ventilating the modern home. Year-round hot water. Forced air circulation for summer. Equipped with the popular BANKHEAT Pressure-Type Burner. Furnished in enamel with chrome trim.

Send for "Selectair" Bulletin & complete Specifications

S. T. JOHNSON CO.

Oil Burners

940 Arlington Avenue, Oakland, California
401 Broad Street, Philadelphia, Pa.

● THERE'S A JOHNSON OIL BURNER FOR EVERY PURPOSE

No Worry for the Architect

"—All acid proof drain pipe and fittings shall be Ferro-silicon—CORROSIRON—"

[Write for this specification]



FEDERAL BUILDING ● CIVIC CENTER ● SAN FRANCISCO

Arthur Brown, Jr., Architect

CORROSIRON DRAIN LINES and FITTINGS and LABORATORY EQUIPMENT was specified because of its superior resistance to corrosion and wear.

Pacific Foundry Company, Ltd.

NEW YORK ● 3100 NINETEENTH ST., SAN FRANCISCO ● LOS ANGELES

MIX 29 TONS CONCRETE PER MINUTE

Grand Coulee Dam's concrete mixing plant has broken its own world's record—20,684 cubic yards of concrete have been poured within 24 hours.

The old record was 15,844 cubic yards, made in 1937.

This new all-time high for a single day's mixture of concrete was made by pouring 14½ cubic yards or 29 tons of concrete every single minute of the day.

It required 75 carloads of cement, 225 of sand and 525 carloads of gravel, and the resultant mixture weighed more than 40,000 tons. It would have paved almost 10 miles of standard 20-foot highway.

More than 1,500,000 cubic yards of concrete mixture have already been placed in the world's biggest masonry dam under the present contract, which began February 2, 1938.

The contract calls for 4,500,000 cubic yards more, all to be placed in huge blocks as big as many city building lots, one on top the other, upon the low-dam base consisting of 4,500,000 cubic yards of masonry poured under the old contract that began in 1934 and ended in 1938.

With a 3-shift, 24-hour day, and the concrete mixing plant operating at top speed, construction on the dam will have used more than 23,000 carloads of cement before July 1.

The mixers, of 4 cubic yards capacity, were loaded at an average of 13 seconds.

TRIBUTE TO FRED T. LLEWELLYN

Upon the eve of his retirement from business, the Board of Directors of American Institute of Steel Construction presented Fred T. Llewellyn of the United States Steel Corporation an engrossed resolution of appreciation for his contribution to the structural steel fabricating industry.

BANK AND OFFICE BUILDING

Plans have been completed by H. H. Winner of Ross, for a one and one-half story steel, concrete and terra cotta bank building in Watsonville for the Pajaro Valley National Bank. Building will cover ground area 85x90' and will represent an expenditure of \$130,000.

AIR CONDITIONED



OIL
HEAT

AT ITS BEST

...is presented in the H. C. LITTLE FULLY AUTOMATIC FURNACE BURNER UNIT — highest quality engineering and construction — exclusive "Heat Trap" all steel welded unit — clean filtered and humidified air — constant automatic temperature control — quiet, economical operation, burns low-priced furnace oil — output 120,000 BTU per hour. Also made in smaller sizes for small homes and commercial installations. Over 50,000 H. C. Little Units in service.

For all-around comfort and economy... match with H. C. Little Oil Burning Water Heater.

H·C·LITTLE BURNER CO.

Factory: San Rafael, Calif.

Dealers Everywhere

NORTHERN CALIFORNIA CHAPTER

(Concluded from page 61)

Edgar Waterman Anthony, giving a concise but highly entertaining synopsis of the development of this art.

Mr. Morrow gave an interesting discourse upon Architects, their ideas and their actions, using as background three books by Walter Gropius, the "New Architecture and the Bauhaus," "Bauhaus 1919-1928," and the "Theory and Organization of the Bauhaus."

Mr. Moise spoke upon a subject of great importance and interest at the moment—Housing, outlining an outstanding treatise upon the subject in the United States—"Modern Housing," by Miss Catherine Bauer.

Mr. Mitchell expressed thanks and appreciation of the efforts of the speakers on behalf of the Chapter.

The Sensation of the Roofing Industry!



Find out about it!

THE PARAFFINE COMPANIES INC.
475 Brannan St., San Francisco

Please send information about the new Thermoslab.

Name

Address

City.....State.....

A & E

MODERN EFFICIENCY *demands* WIRING ADEQUACY



Streamlined automobiles of 1939 type would be of little use on roads adequate for the horse and buggy. No one questions the wisdom of highway development's keeping pace with automobile development.

Yet many expect the electrical highway in commercial buildings to accommodate 1939 traffic with wiring barely adequate ten or fifteen years ago.

Tremendous increase in use of electrically driven office machinery, beauty parlor equipment, and scores of other devices, together with the growing demand for better light, is bringing many building owners to shocked realization that their comparatively new buildings fail to attract tenants because of electrical inadequacy.

The architect may not feel that the responsibility is his, but unless he has suggested, in fact strongly urged, liberal wiring provision at the time of building, some criticism is sure to fall upon him.

Include wiring adequacy in your recommendations.

•
See the electrical exhibits at the Palace of Electricity and Communications at the Golden Gate International Exposition

•
**PACIFIC COAST
ELECTRICAL BUREAU**

447 SUTTER STREET • SAN FRANCISCO, CALIFORNIA

POMONA TILES

FOR
Bathrooms and Kitchens
in over 60 colors

Warehouses and Display Rooms

135 Tenth St. San Francisco

- 629-33 North La Brea Ave. Los Angeles

6106 Roosevelt Way Seattle

POMONA TILE MFG. CO.
PLANT — POMONA, CALIF.



*S*PECIAL lighting equipment for distinguished residences is no longer required. Now Lightoliers, in all periods, for all locations, styled and constructed from expensive "specials" are available at low cost — through dealers or at our showrooms. Send for "The Charm of a Well Lighted Home," an informative manual on correct residential lighting.

INCANDESCENT SUPPLY CO.
SAN FRANCISCO : OAKLAND : FRESNO : LOS ANGELES

STRUCTURAL STEEL

For Class A Buildings,
Bridges, etc.

JUDSON PACIFIC CO.

1200 SEVENTEENTH STREET
SAN FRANCISCO

==== Plants: San Francisco - Oakland =====

A Permanent Exposition
of the newest ideas
in home planning
and equipment.



THE BUILDING MATERIAL EXHIBIT

Architects Bldg. • Fifth & Figueroa • Los Angeles • MU-6306

HIGHLAND CEDAR PRODUCTS

ARE manufactured from the finest old growth cedar timber grown on the Pacific Coast today. Our plant is modern in every respect and equipped with the best of machinery — our employees are skilled craftsmen of many years experience.

We operate the latest type cross circulation kilns, assuring uniform moisture content.

Grades, grain, texture, always uniform.

HIGHLAND CEDAR PANELS

Knotty and clear, vertical and flat grain panels up to 30 inches in width.

HIGHLAND CEDAR EXTERIOR TRIM AND SIDING

Any design, pattern or size desired up to 36 inches in width, 24 feet in length.

HIGHLAND CEDAR BATTENS AND MOULDING

Any size or pattern— Stock or Special Design.

HIGHLAND CEDAR SHINGLES

All standard grades and sizes for roofing and side walls.

Stained shingles also supplied.

WILLIAM HULBERT MILL CO.
EVERETT, WASHINGTON

"Anything in Cedar"

INCLUDE TREES IN YOUR PLANS

DAVEY, ORIGINATOR OF TREE SURGERY, OFFERS FREE INSPECTION AND ESTIMATE.



SAN FRANCISCO Fresno LOS ANGELES
Russ Bldg. Mattei Bldg. Story Bldg.
Sutter 3377 TUCKER 1929
Local phones in: Pasadena, Palo Alto,
Oakland, San Rafael, San Mateo

SKILL - KNOWLEDGE - RESPONSIBILITY

U.S.
PRODUCTS

VAN ARSDALE-HARRIS CO.

ENGINEERS & CONTRACTORS

ACOUSTICAL TREATMENT - INSULATION
SOUND CONTROL

FIFTH & BRANNAN STS. SAN FRANCISCO, CALIF.
TELEPHONE GARfield 3600
DIVISION

VAN ARSDALE-HARRIS LUMBER CO., INC.

USE BASALITE

Light-weight, pre-fabricated Concrete building products for floors, walls, and roofs in your next building.

BASALT ROCK COMPANY, INC.

Napa, California

NOISE CONTROL— ON TREASURE ISLAND

STATE AUDITORIUM AND RADIO STUDIOS
BELL TELEPHONE SYSTEM EXHIBIT
SAN FRANCISCO RECREATION EXHIBIT
FEDERAL BUILDING THEATER

Furnished by—

WESTERN ASBESTOS CO.

Building Materials
SACRAMENTO

Mechanical Specialties
OAKLAND
SAN FRANCISCO

ILLUSTRATIONS OF SUPERIOR CONSTRUCTION

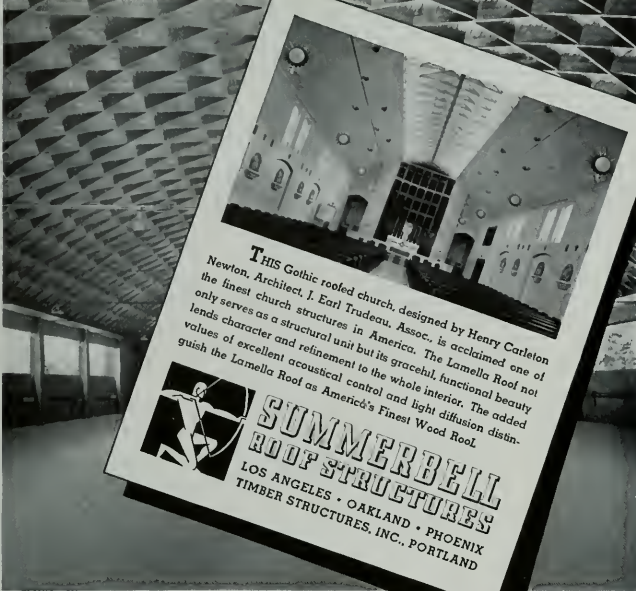

THIS Gothic-roofed church, designed by Henry Carleton Newton, Architect, J. Earl Trudeau, Assoc., is acclaimed one of the finest church structures in America. The Lamella Roof not only serves as a structural unit but its graceful, functional beauty lends character and refinement to the whole interior. The added values of excellent acoustical control and light diffusion distinguish the Lamella Roof as America's Finest Wood Roof.



SUMMERBELL
ROOF STRUCTURES, INC.
 LOS ANGELES • OAKLAND • PHOENIX
 TIMBER STRUCTURES, INC., PORTLAND

ROOFS OF WOOD—BUILT TO ENDURE

BAY BRIDGE TRAFFIC

April traffic figures for the Bay Bridge released by State Director of Public Works Frank W. Clark show that 169,806 vehicles traveled across the bridge to Treasure Island during the month.

Exposition figures show that from the opening of the World's Fair on February 18 to May 1 the total paid admission visitors to Treasure Island to go via the Bay Bridge by automobile or bus were 1,107,512 or approximately half of the total number of paid admission visitors.

Economy, convenience, and time-saving elements, the experts believe, are among the factors encouraging the automobile travel which has risen from an anticipated 20 to 25 per cent of all traffic to nearly 43 per cent. Families are able to take their lunch and keep them safely locked in their car in the Exposition parking lot without other necessary family equipment, if needed.

Not including admission to the Exposition, although there is no charge for the car, the total transportation costs with five persons in the car for the round trip is 20 cents per person or 10 cents per person one way. This includes a 50 cent round trip bridge toll and a 50 cent 24-hour parking fee, totalling \$1.00.

For four persons the cost is 25 cents per round trip per person, and with three persons in the car the round trip per person may be estimated at 33 1/3 cents.

A 40c one-way fare has been fixed to meet public demand for a reduced toll.



Golden Gate Atlas
 TRANSIT
MIX CONCRETE
 AND MORTAR

• makes delivery of material to the job swift and inexpensive . . . minimizing the architect's supervision costs and assuring his client a dependable mix.

PACIFIC COAST
AGGREGATES, Inc.

16th and Harrison Streets
 85 Second Street
 San Francisco

Ideal
Banking
Service
FOR
SALESMEN

Traveling men, salesmen — men and women whose jobs prevent their calling at the bank in person, find our BANK-BY-MAIL Service ideal. They do their banking when most convenient, night or day and wherever there is mail service. Prompt. Reliable. Overnight to most points in California.

Write today . . .

for free Bank-by-Mail kit containing all necessary forms, return envelope and simple instructions.



Member Federal Deposit Insurance Corporation

Pacific
Manufacturing
Company

High Class Interior Finish
 Quality Millwork

142 Sansome St. San Francisco
 6820 McKinley Ave. Los Angeles
 GARfield 7755 THORnwall 4196

1315 Seventh Street, Oakland
 GLencourt 7850



CLIENTS will bless you for installing the Wesix "49'er" ELECTRIC BATHROOM HEATER. But try it first in your own home. Certain that you will like its forty-nine inches of INSTANT RADIANT HEAT and QUICK CIRCULATING HEAT, we are offering this smart new heater at factory cost to architects, for personal use! Limit one heater per architect. List price \$21.50. Please write on your regular letterhead, to: 1018 WESIX BLDG., SAN FRANCISCO

WESIX
WESIX ELECTRIC HEATER CO.

SUMMER REPAIR WORK

ANATION-WIDE campaign to promote property modernization and repair is an important item on the building industry's summer schedule.

The campaign has the full co-operation of the Federal Housing Administration and is planned to "break" simultaneously in all sections of the country the current month. The theme: "Fix Up Your Home! Modernize Outside and Inside."

During the past few years the building industry has found that many modernization jobs can be closed and new prospects developed by featuring these Property Improvement Loans (FHA Title I Loans). Furthermore, the FHA plan means cash payment to the dealer.

Because of this, members of the industry will take a special interest in figures recently released by the Federal Housing Administration. These show that even during the normally dull winter period, private lending institutions continued to make Property Improvement Loans, and that more inquiries and applications for these loans are being received right now than at any time since the FHA plan was put in operation. Modernization loans insured by FHA during the last week of April amounted to \$4,500,000 or more than 9,000 loans per week.

This increased activity indicates that the public and the lending institutions are coming to realize and avail themselves of the benefits offered by the FHA plan. The mounting figures also suggest that it behooves the building industry itself to plan a little concentrated action for the coming months.

As a matter of fact, FHA officials throughout the country point out that industry is approaching that agency more and more frequently with cooperative suggestions and plans to make the most of the FHA modernization and repair work program. In line with these suggestions, FHA has prepared literature and display material for the trade. This information is now available at headquarters in Wash-

Pitcher

**Improved
Disappearing Doors
Save 20% Space**

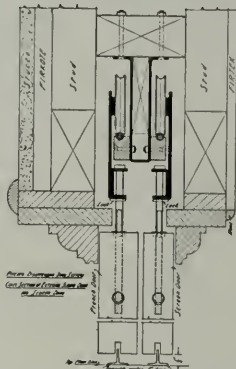

Joins with a 3 3/4" stud wall . . . steel studs . . . adjustable steel and wood track. Can be used for screen doors in connection with French doors. Send for detail drawing.

E. C. Pitcher Co.
557 Market Street
San Francisco



**HERRICK
IRON WORKS**

STRUCTURAL STEEL
REINFORCING STEEL

18TH AND CAMPBELL STS.
OAKLAND, CALIF.
Phone GLencourt 1767

FORDERER CORNICHE WORKS

Manufacturers of

Hollow Metal Products
Interior Metal Trim
Elevator Fronts and Cabs
Metal Plaster Accessories
Sanitary Metal Base
Metal Cabinets
Flat and Roll Metal Screens
Commercial Refrigerators

269 POTRERO AVE.
San Francisco, Calif.
HEmlock 4100

Donovan Automatic Awning Type Windows

Give 100% natural ventilation
and day-lighting control

UNIVERSAL WINDOW
COMPANY
Berkeley, California

"AMERICAN MARSH" Redi-Vac Vacuum Heating Pump

Send for
Bulletin 441

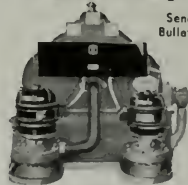

SIMONS MACHINERY CO.
San Francisco 816 Folsom St. Los Angeles 455 East Fourth St.



SANTA MARIA INN

Santa Maria, California

*On the Coast Highway
between
Los Angeles and San Francisco*

OVER NIGHT

or

JUST A MEAL

FRANK J. MCCOY, *Owner*
Geo. A. Thompson, *Manager*

El Encanto Hotel

Santa Barbara

*On the Riviera, above the
Old Mission*

Frank J. McCoy, *Owner*
Fred F. Pimental, *Manager*

Independent Iron Works

Structural Steel
Ornamental Iron
Steel Service Stations
Steel Tanks
Standard Steel Mill Buildings
Bridges

821 Pine Street

Oakland

Clinton Construction Co. of California

*General
Contractors*

923 Folsom Street
San Francisco
SUtter 3440

ington, or through FHA's 64 field offices.

The material includes a colorful window display printed in red, blue, buff and black and a cleverly illustrated booklet with a check list for home owners, printed in red and black. A mimeographed piece will describe how dealers can develop and handle business under the "Property Improvement Credit Plan," Title I of the National Housing Act. It is a brief merchandising manual for dealers suggesting means by which they may increase their sales through the FHA plan of installment payments.

Both the display material and literature are available to all dealers wishing to be identified with the national modernization program, but it will be sent only on direct request. To avoid duplication, manufacturers and trade associations should have the dealers themselves send in their orders. It is suggested that this be done as soon as possible since quantities are limited and it is a case of "first come, first served," in filling requests.

The window display pieces are designed to be used separately and may be adapted to the needs and display facilities of individual dealers. However, this material is essentially a unified window display in which all pieces are employed to feature the dealer's merchandise. A colorful streamer bearing the legend, "Fix Up Your Home" extends across the window, and side streamers suggest improvements "Your Home Can Have." There are also "before and after" cards, posters and seals. In order to instruct dealers on how to arrange this material attractively in their windows, a descriptive folder has been prepared. This folder reproduces the window displays in full color. Copies are available for manufacturers, trade associations, and others who wish to tie in their sales outlets with the national modernization program.

RESISTANCE OF TREATED WOOD

Development of a complete and accurate test for determining the resistance of treated wood to damage

Ferro - Porcelain

FOR

A. CAPURRO BUILDING
Corner Polk and Washington Sts.

Martin Rist, Architect

Furnished and Installed by

FRANK ALLEN

Ferro-Porcelain Construction
320 MARKET ST., SAN FRANCISCO

Melrose Lumber & Supply Co.

LUMBER AND
MILL WORK

46th Ave. and E. 12th St.
Oakland
Phones: FRuitvale 0240 — 0251

ANDERSON & RINGROSE

General Contractors

320 Market Street, San Francisco
Phone GARfield 2245

HIGH GRADE MILLWORK
AND INTERIOR FINISH
SASH AND DOORS

LANNOM BROS. MFG. CO.

FIFTH AND MAGNOLIA STREETS
OAKLAND, CALIFORNIA
Telephone: TEmplebar 3663

MULLEN MFG. COMPANY

BANK, STORE AND OFFICE
FIXTURES—CABINET WORK
OF GUARANTEED QUALITY
CHURCH SEATING

Office and Factory:
60-80 RAUSCH ST., Bet. 7th and 8th Sts.
San Francisco
Telephone UNDERhill 5815

G. P. W. JENSEN & SON

Building Construction

320 Market Street, San Francisco
Phone: GARfield 2444

DINWIDDIE CONSTRUCTION COMPANY BUILDERS

CROCKER BUILDING
SAN FRANCISCO

Carl T. Doell Co.

*Plumbing
Heating*

Plumbing Contractor
Veterans Memorial Building
Oakland

467 21ST STREET
OAKLAND
Telephone GLencourt 8246

by fungi and bacteria is announced by Laucks Laboratories, Inc., of Seattle, Wash.

A special technique, based on the wood block method of toxicity assay proposed first by the Bell Telephone Company, has been developed by the Seattle firm. According to J. M. Kniseley, Laucks' chief chemist, this test can be made for a reasonable cost and is a more thorough and practical method for determining the resistance of treated wood to the ravages of specific organisms than that which might be obtained by a complete chemical analysis of a preservative treatment, since it actually evaluates the toxicity rather than the concentration or the chemical character of the preservative.

"HONEYMOONERS" PROMENADE

From the balcony of the United States Steel Subsidiaries building at the New York World's Fair, visitors get an excellent view of two miniature "Niagara Falls." One is on the Consolidated Edison building and the other is on the Electric Utilities building, both of which are located across the court from the United States Steel exhibit. The promenade balcony runs around the Steel building outside the second floor. Here visitors can also get an excellent panorama of the Fairgrounds.

AN ARBOR OF STEEL PRODUCTS

A feature of the gardens behind the United States Steel Subsidiaries building at the New York World's Fair is a long curving trellis, or arbor, 30 feet high and 200 feet in length. Built of steel, the arbor displays a wide variety of products made of steel today, telling at a single glance, a story of steel's versatility.

AUTOMOBILE DOORBELL

An electrical expert has equipped his home with an automobile doorbell, so that chimes signal the car's arrival as it runs over a switch in the drive.

Louis C. Dunn, Inc.

GENERAL
CONTRACTORS

Monadnock Building
San Francisco

Phone: DOuglas 4632

Empire Construction Co., Ltd.

Builders



RUSS BUILDING
SAN FRANCISCO
SUtter 2989

Smith
Lumber Company
WHOLESALE - JOBBING - RETAIL
FACTORY AND BUILDING LUMBER
PLYWOODS - ROOFING

DISTRIBUTING YARDS

San Francisco	Oakland
•	19th Ave. &
4th & Channel	Estuary
MArket 0103	FRuitvale 3174

YOUR INQUIRIES SOLICITED

SISALKRAFT
REG. U. S. PAT. OFF.

"More than a
building paper"

THE SISALKRAFT CO.
205 West Wacker Drive
(Canal Station) Chicago, Ill.
55 New Montgomery Street
San Francisco, Calif.

ABBOT A. HANKS, INC.
Engineers & Chemists

INSPECTING — TESTING — CONSULTING
 CONCRETE • STEEL • MATERIALS
 CHEMICAL AND TESTING
 LABORATORIES
 • RESEARCH AND INVESTIGATION •

TESTS OF STRUCTURAL MATERIALS
 DESIGN OF CONCRETE MIXES
 SHOP AND ERECTION INSPECTION OF
 STRUCTURES AND EQUIPMENT
 INVESTIGATION OF STRUCTURES
 AND MATERIALS
 TESTS AND INVESTIGATION OF
 FOUNDATION SOILS
 FIRE RESISTANCE AND INSULATION
 TESTS

624 Sacramento Street, San Francisco

Phone GARfield 1164

Hunter & Hudson

Consulting Engineers

DESIGNERS OF HEATING
 AIR CONDITIONING
 VENTILATING AND WIRING
 SYSTEMS, MECHANICAL
 AND ELECTRICAL EQUIP-
 MENT OF BUILDINGS



41 SUTTER STREET
 ROOM 710

San Francisco California

**JOSEPH MUSTO
 SONS-KEENAN
 CO.**

**MARBLE
 and ABRASIVES
 ONYX**

535 NORTH POINT STREET
 SAN FRANCISCO
 1801 S. SOTO STREET
 LOS ANGELES

VAUGHN - G. E. WITT Co.

Manufacturers and Distributors

Pump Governors	Oil Heaters
Safety Pump Governors	Relief Valves
Automatic Gas Regulating Valves	Oil Burner Governors
Gas Burning Equipment	Oil Burners
Vacuum Pump Governors	Oil Pumping Sets
Vacuum Regulating Valves	Oil Valves
Continuous Flow Steam Traps	Oil and Steam Strainers
Thermostats	Duplex Oil Pumps
Reducing Valves	Relay Oil Pumps
	Boiler Feed Pumps
	Water Heaters
	Boiler Feed-Water Regulators

4224-28 Hollis St., Emeryville, Oakland

**THE
 HERMANN SAFE CO.**

MANUFACTURERS AND DEALERS
 OF

FIRE AND BURGLAR PROOF
 SAFES AND VAULTS, SAFE-
 DEPOSIT BOXES, ETC.

200 HOWARD STREET
 SAN FRANCISCO
 GARfield 3041 - 3042

THE MOST COMPLETE LINE
 OF STEELS AND STEEL BUILD-
 ING MATERIALS MADE BY A
 SINGLE PRODUCER



See Sweet's Catalog File or write us for
 full information.

Republic Steel Corporation

General Offices: Cleveland, Ohio

Denver, Colo. . . Continental Oil Bldg.
 Los Angeles, Calif. . . Edison Bldg.
 Salt Lake City, Utah . . Walker Bank Bldg.
 San Francisco, Calif. . . Rialto Bldg.
 Seattle, Wash. . . White-Henry-Stuart Bldg.

**VERMONT
 MARBLE
 COMPANY**

Producers and Finishers

of

Domestic and Imported
 Marbles

San Francisco
 Los Angeles
 and
 Tacoma, Wash.

Robert W. Hunt Company
 ENGINEERS

Inspection - Tests - Consultation
 Schools and Other Structures
 Are Built as Designed

*When Construction Materials are
 Inspected at point of Manufacture
 and during Erection by*

ROBERT W. HUNT COMPANY

*Cement, Concrete, Chemical, Metallurgical,
 X-Ray and Physical Laboratories*

Chicago - New York - Pittsburgh
 Los Angeles - All Large Cities
 San Francisco, 251 Kearny Street

**JOHN
 CASSARETTO**

—Since 1886—And Still Active—

Building Materials

READY MIX CONCRETE
 ROCK - SAND - GRAVEL - LIME
 CEMENT - PLASTER - MORTAR
 METAL LATH - WOOD LATH
 STUCCO - WIRE NETTING

Service Unexcelled

Bunkers

Sixth and Channel, San Francisco
 Phones: GARfield 3176, GARfield 3177



MERCURY PRESS

We Print
 The ARCHITECT and
 ENGINEER

*"A Thing of Beauty
 Is a Joy Forever"*

942 HOWARD STREET
 SAN FRANCISCO

**FINE WATER COLORS
 AND PAPERS
 FOR ARCHITECTURAL
 RENDERINGS**

**H. S. CROCKER
 COMPANY, Inc.**

720 MISSION STREET
 MARKET STREET AT SECOND
 SAN FRANCISCO

**THE TORMEY
 COMPANY**

GENERAL PAINTERS
 AND DECORATORS

Phone UNDERhill 1913

563 FULTON STREET
 San Francisco

ARCHITECT

AND

ENGINEER

JULY 1939



PLASTER-CRAFT CONSTRUCTION



Corridor, Los Angeles Union Station. Consulting Architects, John and Donald B. Parkinson; Construction Engineer, A. J. Barclay; General Contractor, Robert E. McKee; Plaster Contractor, Elwood E. Schwent.

...in THE WEST'S NEWEST TERMINAL

Beautiful and new as this morning's sunrise, the eleven-million-dollar Los Angeles Union Station begins its long life of service. The principles of sound construction embodied in this building include specifying and using *Plastercraft Construction* — that winning combination of Empire Plasters, Empire Steel Studs, Milcor Metal Lath,

and Corner Beads. ☆ Where permanence, safety, and appearance are factors, don't substitute for the ever-reliable *Plastercraft Construction* group. They are engineered to *work together* — and quick assembling means economy on the job. Specify *Plastercraft*—the "backbone" of the West's outstanding projects.

Ask Your Building Materials Dealer

EMPIRE
Studs
RENO
Plasters

MILCOR
Metal Products
SIERRA
Gypsum Tile

EMPIRE
Plasters
STANDARD
Plasters

Produced and Distributed by
PACIFIC PORTLAND CEMENT COMPANY
 SAN FRANCISCO LOS ANGELES COASTWIDE SERVICE PORTLAND SEATTLE

RUNNING FIRE

by
MARK DANIELS, A.I.A.

San Francisco's Chinatown

Chinatown has for more than half a century been one of San Francisco's most important tourist lures. People have come to this city from all parts of the world to enjoy trips through Chinatown. The festivities of the Chinese holidays, particularly New Year's day, have been written up and discussed and described by many a famous author.

This attraction, however, is fading more and more rapidly as each year passes, due to the infiltration of modern architectural styles of this country and of foreign countries, and the adoption of customs on the part of the present American born generation of youthful Chinese. The picturesque costumes and fascinating old characters of thirty years ago are almost never seen and the cocktail bar with its chromium plated stools is now taking the place of the old establishments so full of atmosphere. If this progress is permitted to continue it will not be long before Chinatown will look like any other street of shops and cocktail bars, and one more of San Francisco's great magnets will lose its tourist-drawing power.

Chinatown in San Francisco is the largest Chinatown outside China and is not only one of San Francisco's features but is a unique settlement in the United States. The culture and arts of China have been a dominant factor in civilization since the ninth century, at which time it was considered by all authorities to be the foremost in the world. This culture and art is worth preserving in the country of the United States and it is doubly important to us that it be retained in San Francisco.

On the other hand San Francisco's Chinatown is riddled with tuberculosis and has nearly three times the infant mortality rate of other sections of the city, in spite of the efforts of Dr. Geiger and his assistant, Mr. Thyle. Already, through the courageous work of Dr. Geiger, Mr. Thyle has condemned some twelve buildings as utterly uninhabitable. Dr. Geiger has been working on a long-time

plan to rid Chinatown of its unhealthy conditions but he has been hampered by the fact that the area is a constricted and restricted one, that the Chinese desire to live in that same neighborhood and that, upon execution of condemnation proceedings, large groups of Chinese move from the condemned building to overcrowd another nearby one—and if the property is renovated, the rents will rise and the former tenants cannot afford the more modern building.

With funds available for proper housing projects, it does seem that something should be done to preserve the unique charm and beauty of Chinatown by air conditioning the district and making it as sanitary and livable as any other in the city.

The trouble at present seems to be that the condition upon which government money is available for housing projects precludes the possibility of air conditioning and rebuilding Chinatown in a character that would be purely Chinese. However, the retention of Chinese architecture, art and culture, and the attraction of the great unit of Chinatown itself seems to be much more important than adherence to rule.

It is not possible to modify the rules and regulations for the construction of housing units sufficiently to permit such a unit being established in San Francisco's Chinatown? Such is the picture, if it could be accomplished; it would clear San Francisco of one of America's worst slums, remove the threat of tuberculosis and plagues from the heart of the city and bring back in an enhanced form the attraction of oriental life, Chinese art and architecture.

★ ★ ★

Retrospectum

I walked into the bar, leaned on it and ordered an Old Fashioned in a tired voice. A little man was hanging on to the bar next to me looking with jaundiced eye at a pale blonde at the far end of the room; the blonde's hair was slightly disarrayed and she was talking at great length in a loud voice to a disinterested companion.

The little man turned confidentially toward me and said, "God fashioned Eve by taking a rib from Adam."

I said "What?"

"The symbology of the Bible is astounding. It is impossible to conceive that the ancient philosophers, the writers of the Bible, could have discovered the truth that man is not woman because he has but one less chromosome than woman."

Again I said "What?"

"The processes of thought that arrived at this conclusion could not have been based on scientific knowledge as the ancients had not the modern inventions, the medical background, or the invaluable studies that have been made in the past thousand years. Therefore any deductions made must have been through the development of metaphysical impressions, their recording and discussion. The rib that Adam lost to Eve must necessarily have been the representation of the chromosome that Eve has that Adam has not. Therefore . . ."

It this point my friend evidently thought it wise to depart. He waved me a cheery goodbye, missed the door by about six inches, manipulated himself around it and disappeared.

When I went to finish my Old Fashioned the glass was empty.

★ ★ ★

Unfit for British Ears

It was the Archbishop of Canterbury who suggested that the recent broadcast of the Duke of Windsor should not be permitted over the B.B.C.? I seem to recollect that it was he who forbade the bans in England and carried on to prevent the Duke's brother from attending the wedding. I also seem to recall faint pictures of aged ecclesiastics in Salem gleefully rubbing their hands as they watched the operations of a ducking stool.

This may not be the explanation for cutting out the peace plea of the Duke from the English auditors but there seems to be no other unless it is that the English ruling class considered anything the Duke might say would be unfit for a Briton's ears. Of course, anything would be good enough for America.

ARCHITECT AND ENGINEER

JULY, 1939

FRED W. JONES
Editor

MARK DANIELS
Associate Editor

E. N. KIERULFF
Ass't Editor

CONSULTING BOARD
OF EDITORS

Architectural—

Arthur Brown, Jr.
Frederick H. Meyer
Timothy L. Pflueger
Will G. Corlett
Harry Michelsen
John J. Donovan
Lewis P. Hobart
David C. Allison
Gordon B. Kaufmann
Harris C. Allen
Glenn Stanton
Paul R. Hunter
C. H. Alden

Engineering—

H. J. Brunner
L. H. Nishkian
William Adrian
Wm. H. Popert
Homer N. Hadley
John J. Gould
Geo. E. Atkins

Business Manager—

L. B. Penhorwood

Advertising Manager—

J. Leslie Meek

Architects' Reports—

Vernon S. Yallop

THE ARCHITECT AND ENGINEER, INC., 68 Post Street, San Francisco, EXbrook 7182. President, K. P. Kierulff; vice-president, Frederick W. Jones; secretary, L. B. Penhorwood. Los Angeles office, 832 W. Fifth Street. Published on the 12th on each month. Entered as second class matter, November 2, 1905, at the Postoffice at San Francisco, California, under the Act of March 3, 1897. Subscriptions, United States and Pan America, \$3.00 a year; Foreign countries, \$5.00 a year; single copy \$.50.

Frontispiece

ENTRANCE TO ADMINISTRATION BUILDING,
MASTICK SCHOOL, ALAMEDA
Kent and Hass, Architects

Text

ALAMEDA HAS NEW TYPE ELEMENTARY SCHOOL	19
A YOUNG ARCHITECT'S SKETCHES	25
Glenn Stanton, Architect	
A HOME IN THE HILLS	27
Mark Daniels, Architect	
HOME PLANNING DO'S AND DON'TS	31
Clement W. Fairweather, F.A.I.A.	
SAN DIEGO'S NEW CIVIC CENTER	33
Richard S. Requa, Architect	
A NATURAL MURAL OF MATCHLESS BEAUTY	37
ARCHITECT DESCRIBES HIS OWN HOME	39
Ben H. O'Connor	
IMPORTANCE OF BATH ROOM MODERNIZATION	43
LOW COST SINGLE FAMILY DWELLINGS	47
SOME UNIQUE REQUIREMENTS OF LONDON BUILDING REGULATIONS	49
Robins Fleming	

Illustrations

Mastick School, Alameda, California	20-22
Kent and Hass, Architects	
Portfolio of Sketches by George Wardner	24-26
Residence of B. H. Lieurance, Santa Rosa	27-30
City and County Administration Building, San Diego	33-35
Aerial Photo of San Francisco Bay Bridge	36
Cocktail Lounge, Mark Hopkins Hotel	37-38
Timothy L. Pflueger, Architect	
House of Ben H. O'Connor, Architect	39
Small Church Competition	41-42
Low Cost Single Family Dwellings	47-48

Index to advertisements—Page 80



SAVE $\frac{1}{3}$
ON LABOR COSTS
with
**SELF-TILED
PARTITIONS**

KRAFTILE Terra Cotta Wall Units are already finished on one or both sides with a smart, everlasting Kraftile surface. You've only one craft on the whole job—you save time—your labor costs are reduced about a third.

A Kraftile wall surface will save building owners real money on upkeep costs. The beautiful semi-matt glaze is stainproof, steamproof, fireproof. No soaps or cleaners needed—just a damp cloth. And because Kraftile is higher-fired, it will resist the hardest abuse.

All Kraftile Wall Units are *precision-sized* to within 1-16 inch. Made in standard 6 x 12 and 8 x 16 sizes and shapes. Easily reinforced for earthquake resistance to meet California State Code requirements.

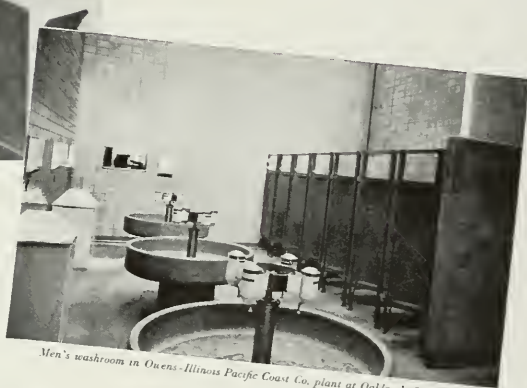

Men's washroom in Owens-Illinois Pacific Coast Co. plant at Oakland, California

In 21 states and in Canada, builders of schools, hospitals, food products plants, laboratories and public buildings have been quick to recognize the advantages of self-tiled Kraftile partitions. Our Engineering and Designing Department worked closely with many of these builders. This experience is yours for the asking.

**KRAFTILE
TERRA COTTA WALL UNITS**

FREE HANDBOOK FOR ARCHITECTS AND BUILDERS

KRAFTILE COMPANY — Niles, California

Please send me without cost or obligation "Handbook of Specifications and Suggestions on Glazed Terra Cotta Wall Units."

Name

Address

City State

LILIES

For Every-Day Gardeners

By BERNIECE ASHDOWN
Landscape Architect

Of all families of flowers, perhaps none has so many imposters carrying its family name as the lily family. For centuries, people have carelessly dubbed every flower bearing any resemblance to this noble family, a "lily." Today, as a result, we find *Hemerocallis* called Day-lily, *Convallaria majalis* labeled Lily of the Valley and *Nymphaea* known as Water lily, to say nothing of the hundreds of other plants similarly misnamed.

The family *Lilium* is a large one, embracing hundreds of species which differ widely except for family characteristics. Lilies have erect leafy stems bearing terminal flowers or flower clusters, which range in color from white to red and include tones of orange and yellow. Most of them are exquisitely perfumed and have a beautiful wax-like texture. Their rough surfaced bulbs are protected by leaf-like scales.

Lilies have the distinction of being the oldest of all cultivated flowers. Ancient records bear witness to their cultivation by early Egyptians and Asiatic peoples.

Most of our lilies are native to Asia, principally China. Another group came from Europe, some from Africa, and a good many are native to America.

Although lilies are very well known, they have never attained the popularity enjoyed by more easily grown flowers. Their cultural requirements, however, are not beyond the reach of the most modest garden. Most European lilies make amiable companions for the perennial border. Most American lilies, on the other hand, prefer acid soil and are therefore at home among the Azalia, Heath, Rhododendrons and other acid loving plants.

Due to their widely varying habits it is necessary to consider the individual requirements of the various lilies separately. First, however, I shall list a few general rules.

While most lilies grow splendidly in full sun, they also thrive in semi-shade. Under all conditions the bulbs should be well mulched or the ground shaded so as to keep it cool and moist.

Good drainage is essential. Where the ground is flat and the soil heavy, under-ground drainage is imperative. When planting bulbs, it is wise to dig a roomy hole, line the bottom with an inch of sand so as to completely surround the bulb before it is covered with soil; the roots may then grow through the layer of sand to the fertile soil below, and the bulb is protected from rotting caused by an accumulation of undrained water. The ideal soil for lilies is composed of equal parts of clay, sand, leaf-mold and a good fertilizer.

When selecting bulbs, watch for bruised places and decay, as well as insects and disease. It is best to buy all bulbs from a reliable dealer, who can assure you of their

health and quality. If there is any doubt about whether or not the new bulbs are disease-free, plant them far from any other lilies in the garden until you are sure. Before planting new bulbs, cut off all broken scales, and dust them well with powdered sulphur.

It is difficult to give definite dates for planting lily bulbs, because of the necessary modifications due to climate and the times of the new bulb shipments. It is wisest to consult a local expert.

The proper planting depth is also variable. In sandy soil they may be planted from one and a half to two inches deeper than in clay

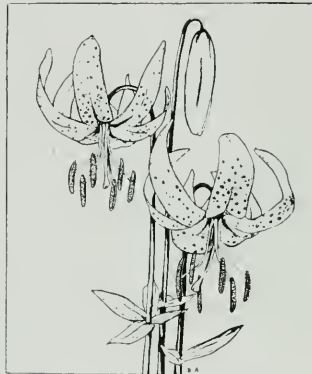

soil. Generally, the bulbs are planted three times their own depth, but this rule has many exceptions.

Many enthusiastic garden hobbyists find propagating lilies from seed both fascinating and profitable. The seeds are sown in a shaded cold frame and allowed to remain there until the bulbs are well formed. In this way, a large disease-free stock of bulbs may be produced at little or no cost.

After blooming, all flower stocks except those to be used for seed, should be removed. Take special care in cutting the stalks, so that all the foliage is not cut away. The leaves are essential to further development of the bulb.

Here are a few of the hardiest lilies with blooming seasons extending from June to September.

Lilium candidum (Madonna lily) white, very fragrant, 3 to 5 ft. tall; shallow planting, likes lime soil.

Lilium amabile: Orange, about 3 ft. tall; plant 6 inches deep, partial shade.

Lilium concolor: Red, or yellow, star-like blossoms. Plant 3 in. deep in full sun.

Lilium hansonae: Yellow, 5 to 6 feet high; plant 8 in. deep.

Lilium pardalinum californicum: (See illustration) red orange, 4 to 8 feet tall, plant 5 inches deep in full sun.

Lilium Canadense: Red, or yellow, 2 to 6 ft. tall, needs damp soil.

Lilium regal: White, very fragrant, 3 to 6 ft. tall, plant 6 to 8 inches deep.

Lilium tigrinum: Orange-red, spotted with black, 4 to 6 feet tall, likes sun and dry soil.

Lilium speciosum: Pink or white, 3 to 4 ft. tall, plant 6 to 8 inches deep in semi-shade.

Lilium superbum: Red orange, native of America, 4 to 6 feet tall, plant in semi-shade, and keep moist.

Lilium Henryi: Orange, 9 ft. tall, sun or semi-shade, 8 in. deep.

Lilium longiflorum: White, well-known as Easter lily, plant in sheltered place about 4 inches deep.

INCLUDE TREES IN YOUR PLANS

DAVEY, ORIGINATOR OF TREE SURGERY, OFFERS FREE INSPECTION AND ESTIMATE.



SAN FRANCISCO Sutter 3377
Russ Bldg.

FRESNO
Maffei Bldg.

LOS ANGELES
Story Bldg. Tucker 1929

Local phones in: Pasadena, Palo Alto,
Oakland, San Rafael, San Mateo

SKILL - KNOWLEDGE -
RESPONSIBILITY

Send for
catalog
"The Charm
of a Light-
Conditioned
Home"

No furnishings you can
buy for so little will
give you as much long
term satisfaction as a
new Lightolier fixture.

**INCANDESCENT
SUPPLY COMPANY**
726 MISSION STREET, SAN FRANCISCO

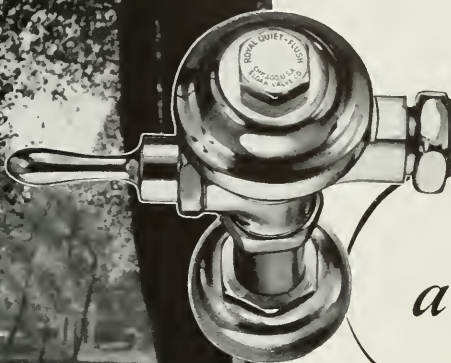

*scarcely
a murmur...*

There is no reason now for noisy flush valves. They can be absolutely quiet. Indeed—Sloan *Quiet-Flush* Valves are absolutely quiet. When operated, the flow of water through a Sloan *Quiet-Flush* Valve makes scarcely a murmur. And this *Quiet-Flush* equipment is available to all Sloan Royal, Star, Crown and Naval valves.

What is more—*any* Sloan flush valve in the above models may be made absolutely quiet—regardless of when installed. Merely replace the present stop valve with the Sloan *Quiet-Flush* stop, then insert in the valve itself a new type guide and seat. This simple change, readily made by any master plumber, reduces the roar of rushing water to a whisper—and virtually makes the old valve a brand new installation.

A new descriptive folder, with cross-sectional views showing how this miracle of quietness is accomplished—will be sent you upon request.

See our comprehensive Catalog in Sweets

SLOAN VALVE COMPANY • CHICAGO
4300 WEST LAKE STREET

SLOAN *Quiet
Flush* **VALVES**

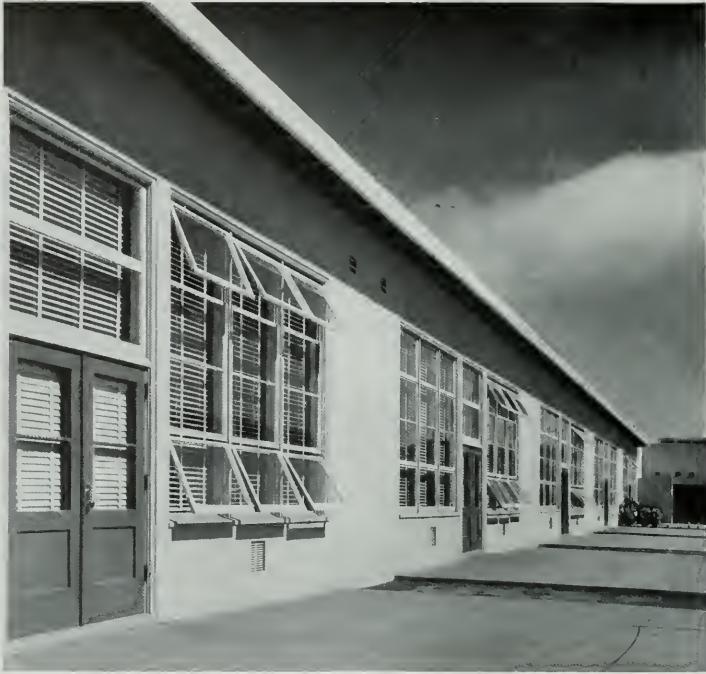

Outdoor classroom terraces. Note windows.

DONOVAN

Automatic Awning Type Windows

Installed in the new **Mastick School**, Alameda, California, insure 100% natural ventilation control and perfect daylight illumination . . . Specified by Architects, Messrs. Kent & Hass.

*Donovan windows are giving service
in 1500 schools on the Pacific Coast*

UNIVERSAL WINDOW COMPANY
Berkeley, California

THIS SIGN

INVITES YOU TO NEW

SOURCES OF INSPIRATION



● The marvels of the New York World's Fair—the splendors of Manhattan—both will attract you to the metropolis this year. Both will offer to the architect limitless sights of compelling interest—limitless sources of inspiration.

In New York, readily accessible in famed Radio City, is the Permanent Exhibit of Decorative Arts and Crafts. And here Libbey-Owens-Ford conducts a permanent and complete exhibit of flat glass.

The photographs of sections of this exhibit illustrate some of the novel, practical and ornamental possibilities of glass. However, they do not portray the full scope of the display. You will find there in infinite variety, new and artful uses of glass in keeping with today's trend in architecture—a trend that emphasizes the functional and decorative value of this fascinating material.

Libbey-Owens-Ford Glass Company, Toledo, O.

LIBBEY • OWENS • FORD



QUALITY GLASS

AN OPEN LETTER TO ARCHITECTS AND ENGINEERS

To Members of the Architectural and Engineering Professions in California:

Gentlemen:

I bear you greetings from the Contractors' State License Board, and a request for your assistance in a matter of considerable importance to both general building contractors throughout the State, and to awarding authorities.

The request is that you advise prospective bidders for reconstruction contracts that the bid or proposal form must contain a statement that the bidder is licensed by the State as a contractor, that the license is in force, and also showing the license number itself.

This request is not made in order to throw more work upon your offices that could be properly handled elsewhere. Nor is it in any way to be construed as an attempt to show to your particular professions, which are so well founded in ethical procedure, the way in which your own business should be carried on.

The request is made merely to avoid incidents such as one which recently happened and which caused confusion and embarrassment to many who were involved. The situation arose when an unlicensed contractor was the successful bidder upon a public works contract. Other incidents of this sort have arisen in the past and in all cases the outcome has been unfortunate for some persons involved, more so in some than in others.

In the first place, if a contractor submits a low bid in good faith, the awarding authority naturally will desire to take the benefit of that low figure. The contractor himself will not feel that he should be refused the job merely because he does not have a license which he presumes he can secure within a week or two by filing an application form with the Contractors' Board. Competitors, however, and others interested in the welfare of competitors, usually learn of an instance where a low bidder is unlicensed and raise the question of the legality of the bid. It has been ruled by the Attorney General of the State that a contract can not legally be awarded to a man whose bid was submitted at a time he was unlicensed. Therefore, if a license should be issued to him at once, which is not likely, he still could not legally enter into the contract.

In instances of this sort, the rules of the State Board require that the inspector in charge of the district bring a criminal action against the contractor. Such an action brings profit to no one, and if the contractor should have bid in honest error, it is unfortunate that the matter has to be taken to public prosecution authorities who may, in some instances, feel that it is necessary in order to protect themselves from charges of favoritism to prosecute the contractor. He is then cited into court. As far as the inspectors of the State License Board are concerned, they

are bound by the decisions of public prosecuting officers since our departmental rules require that all cases be reported to the district attorney or city attorney.

In closing, I trust that the members of the professions will understand, as I have already stated, that this is in no sense an attempt to dictate the manner in which architects and engineers carry on their business. It is merely intended to show a way in which an embarrassing situation can be avoided. This Board knows that the situation which arises in a case of this sort is fully as embarrassing to the architect or engineer in charge of the project as it is to the contractor, and to the others who are charged with enforcement of State laws.

Sincerely,

ARTHUR ALBER,

Registrar and Executive Secretary
of the Contractors' State License Board.

SMALL HOME SERVICE

Editor, Architect & Engineer
San Francisco, California

As the architect member of the Publicity Committee of the Small Home Service, I have been requested by the Board of Directors to send to Architect & Engineer information concerning the Small Home Service of Southern California.

The Small Home Service, incorporated in April 1938, is sponsored by architects, lending institutions, contractors, material dealers, manufacturers and realtors, and embodies the significant feature of architectural service, not only in the preparation of drawings but also in consultations with clients and inspections to the jobs. While it is true that this is another attempted solution to the small house problem by means of the stock plan method, it is, I believe, the most completely worked out program that has thus far been actually put into operation. It is interesting to note that this idea, initiated over a year ago, is in line with the program being developed jointly by the A.I.A. and the Producers Council.

May I call attention to several features of the scheme that are of particular architectural interest? The Portfolio, which is the first thing the prospective owner sees, contains some seventy houses selected from 350 designs submitted by fifty-four architects. These houses were carefully selected and minor revisions made to them by the Committee on Design, the members of which have been conspicuously successful in the small house field in Southern California. These houses contain as many modern features in plan and exterior as the Committee felt would be acceptable to the public, and all the houses conform to the standards of our local Federal Housing Administration. In order to avoid any inequality of presentation, all of the perspectives have been done by one man, Frank W. Jamison, the foremost delineator in Los Angeles. With the Portfolio

is included the estimated cost and loan data for each house. The average estimated cost includes the architect's fee.

The specifications are a relatively permanent document, describing materials and methods of installation. The kind and quality of materials for each job are listed in schedule form on the first sheet of the working drawings. This is a most ingenious arrangement, and it is necessary only for the architect to fill in a small schedule sheet in order to write the specifications. Sheet No. 2 of the working drawings contains typical construction details approved by the local F.H.A. office.

While the details of the Service are just now nearing completion, it is rather interesting to know that on the first house to proceed into the working drawing stage, the clients made no changes to the plan and that in one conference it was possible to develop all of the required information necessary for the specification schedule. Some five hundred copies of this Portfolio have been printed and are in use at banks and material dealers, and the character of the Service is being advertised widely through pieces of literature and by broadcasts over the air.

Very truly yours,

PAUL R. HUNTER, Architect.
Los Angeles, Calif.

PAGE MR. FARLEY

(H. H. Zimmerman in Bulletin, Illinois Society of Architects)

The Post Office Department intends to issue seven sets of postage stamps with portraits of famous American sculptors, poets, authors, musicians, scientists, inventors and educators. Architects at present are not listed for this honor. I have written to Postmaster General Farley, asking whether architects are to be ignored, or whether suggestions for names of architects worthy of this honor would be considered by him.

I think it would be fine if the profession would approve the idea and request this recognition for architects. The law, of course, prohibits portraits of living persons appearing on the postage stamps.

FORMOIL

Saves Form Lumber
Strips Concrete Clean

Particularly efficient for
architectural concrete



Gunn, Carle & Co.
SAN FRANCISCO
20 Potrero Ave. Underhill 5480

LIBERAL USE OF RUSTLESS METAL

Makes Any Store Front Design More Effective



SEE ZOURI FOR:

- ✓ THE COMPLETE STORE FRONT INCLUDING—
- ✓ SASH AND BARS
- ✓ AWNING BARS
- ✓ ENTRANCE DOORS
- ✓ PILASTERS
- ✓ MOULDINGS
- ✓ METAL SIGN LETTERS
- ✓ PANELING
- ✓ ORNAMENTAL WORK

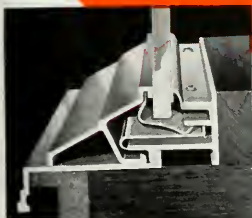
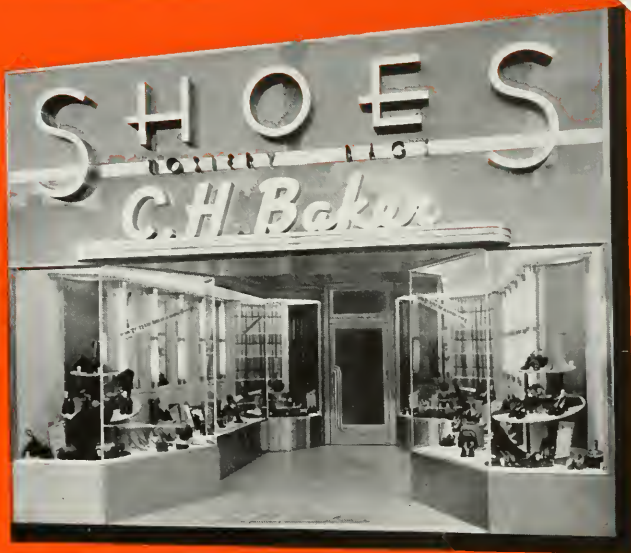

Glass Protection

To be safe, plate glass must be handled and HELD with care! That's why the new ZOURI Extruded Sash and Bars as well as the famous Rolled Safety Key - set construction are designed to provide FULL CUSHION GRIP on glass. This important feature assures maximum protection against the danger and expense of glass breakage — protection vital to the satisfaction of owner and merchant.

Important to architects and builders is the modern demand for more attractive store fronts. That's why store front designers are turning to the liberal use of ZOURI Rustless Metal — for its life and lustre, for rich lasting beauty, and for interesting lines and contrasts.

Zouri offers a complete line of store front construction in either rolled or extruded metal. In most cases striking effects may be obtained by the use of standard sections,

which are carried in stock. In others, ZOURI fabricates special architectural metal work in aluminum, bronze or stainless steel—to face the entire front with modern metal, to produce doors or metal letters in harmony with the store front design, or to satisfy any modern demand. A 14-page catalog is at your disposal in SWEET'S. See your ZOURI distributor or write direct to ZOURI STORE FRONTS, BERKELEY, CAL., for f. s. details.

ZOURI STORE FRONTS

The Lieurances will always enjoy PLENTY OF HEAT AND HOT WATER



• Steady, even heat with concealed radiation, and a constant supply of hot water, winter and summer, are supplied automatically in the new Lieurance residence at Santa Rosa by a General Electric oil-fired boiler. The General Electric unit was specified by Architect Mark Daniels for its record of continuous, satisfactory operation and economy. Thousands of satisfied owners report fuel savings of 25% to 50% over other types of heating equipment.

Give your clients these benefits too — specify General Electric automatic heat for their homes. The G-E complete line includes —

Oil Furnaces • Oil Burners • Oil Winter Air Conditioners
Gas Furnaces • Gas Winter Air Conditioners • Room Coolers • Store Coolers • Central Cooling Systems • Air Circulators.

Phone or write us for free literature and complete information.

GENERAL AIR CONDITIONING • AND HEATING CO. •

4001 Piedmont Avenue

Phone: HUmboldt 2711

Oakland

PIGEON SOILING OF BUILDINGS

One of the seemingly small but nevertheless exasperating problems of architects of public buildings, office structures and even churches, has been an effective method for ridding the facades of these structures of pigeon soiling. Albert F. Roller, architect of San Francisco, appears to have solved the problem successfully in a remodeled job at Center Street and Shattuck Avenue, Berkeley, so we have asked him to reply to the following query from an eastern banker in the belief that publication of the correspondence may prove helpful to readers confronted with similar problems.

LIBERTY BANK OF BUFFALO
BUFFALO, N. Y.

June 6, 1939

ARCHITECT AND ENGINEER
68 Post Street
San Francisco, California

Dear Mr. Jones:

Has any method been developed among owners of public buildings, banks, and office buildings to keep pigeons off of facades of the buildings? We are having trouble with pigeons soiling the steps below the facade and occasionally annoying some of our customers. Of course, we do not want to harm the pigeons, but the damage is becoming

Assuring you of our willingness to reciprocate, more and more pronounced.

I am Yours very truly,
BERT H. WHITE
Vice President

ALBERT F. ROLLER
ARCHITECT
San Francisco

June 13, 1939

ARCHITECT AND ENGINEER
68 Post Street
San Francisco, California

Dear Mr. Jones:

Your letter regarding correction of pigeon nuisance on the building in Berkeley is acknowledged, together with Mr. White's letter.

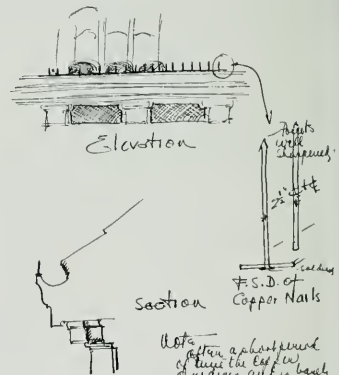

ARCHITECT'S SKETCH SHOWING SOLUTION OF PROBLEM

In order to abate the nuisance on building in question, we placed on all overhanging ledges strips of copper approximately 1" wide supporting 3/2" copper spikes with the points well sharpened and close enough on center to make it impossible for a bird to roost. Also, all apertures and tile ends were closed up with copper screening as were the distances between the medallions under the cornices.

This sufficiently disturbed the habits of the birds so that within a short time they made their nests elsewhere.

ALBERT F. ROLLER

ARCHITECT AND ENGINEER

"We wanted Duct Work that would last the life of the building . . . that's why we chose U-S-S COPPER STEEL"



"REPLACING duct work is a costly job in any building. We had to be certain that the steel selected for air-conditioning ducts would give the longest possible service—at moderate cost. U-S-S Copper Steel was the logical choice. It lasts longer. Costs just a little more. And our clients recognize the label. They have confidence in the name 'United States Steel'. That's why I don't hesitate to

recommend it for the important jobs." U-S-S Copper Steel is proving to architects everywhere that it is the ideal material for countless uses. In heating and air-conditioning ducts, it stands up against high humidity conditions and wet-air condensation. For roofing, siding, downspouts, gutters—wherever atmospheric corrosion must be encountered—actual tests have shown that Copper Steel is more

serviceable. The copper addition gives it a double defense against most of its natural enemies. Look at the chart on this page—here's proof of extra life that may be expected from U-S-S Copper Steel. Further information may be obtained by writing to one of the companies listed below. U-S-S Copper Steel Sheets are quickly available—plain or galvanized—in principal cities.



COPPER STEEL SHEETS

COLUMBIA STEEL COMPANY, *San Francisco*
 CARNEGIE-ILLINOIS STEEL CORPORATION, *Pittsburgh and Chicago*
 TENNESSEE COAL, IRON & RAILROAD COMPANY, *Birmingham*

Scully Steel Products Company, *Chicago, Warehouse Distributors*
 United States Steel Products Company, *New York, Export Distributors*

Look for this symbol on steel products. It represents the highest quality, the finest metallurgical service.

UNITED STATES STEEL



MAIN LOBBY INTERNATIONAL HEADQUARTERS BUILDING OF KRAFT-PHENIX
CHEESE CORPORATION, CHICAGO.

MUNDIE, JENSEN, BOURKE & HAVENS, ARCHITECTS

Note on left wall reproduction of plaque depicting earliest record of dairying. Walls are of Krafttile units in an attractive color scheme dominated by warm shades of buff. The plaque, made in California, is a copy in ceramic of an ancient Babylonian limestone frieze.



"PADDY," HORSE DONE IN BRONZE FOR THE MAIN LOBBY OF KRAFT-PHENIX CHEESE CORPORATION INTERNATIONAL HEADQUARTERS BUILDING, CHICAGO



MAIN LOBBY OF KRAFT-PHENIX CHEESE CORPORATION INTERNATIONAL HEADQUARTERS BUILDING, CHICAGO. WALLS ARE OF KRAFTILE'S MACHINE-RUN UNITS IN FOUR SHADES

Treasure Island's

"SUNSHINE HOUSE"

all-gas livability



The entire building industry cooperated in fulfilling this architect's dream of the perfect "California Modern" home. The all-gas "Sunshine House" at the Golden Gate International Exposition, Home Division; erected by the Construction Industry Section of the San Francisco Chamber of Commerce. ☆ To millions of visitors it reveals superb planning for comfort, recreation and carefree convenience.

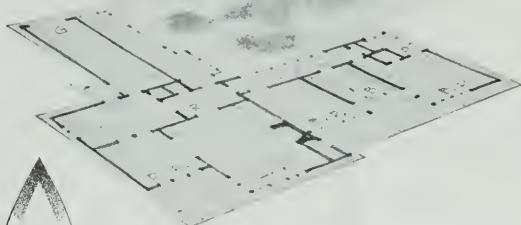

See the all-gas Sunshine House on Treasure Island. ☆ Then visit the Gas Industry's exhibit, Homes and Gardens Palace.

Vincent G. Raney and Loy Chamberlain headed the Architects' Committee that accomplished this triumph of indoor and outdoor living. For heating they specified an automatic, forced-air gas furnace. ☆ The planned kitchen of course has an automatic gas range for fast, sure, economical cooking and a gas refrigerator for silent and savings. ☆ Hot water flows with fingertip ease from an automatic gas water heater. ☆ The architect and builder will approve your choice of gas for these same big jobs in your home.

LET **GAS** DO THE 4 BIG JOBS
THE MODERN FUEL

HOUSE HEATING • WATER HEATING • COOKING • REFRIGERATION



SLENDER PURSES BUY MORE *LIVABILITY* when you specify a Crane family planned kitchen



Better Bathrooms for the Low-Cost Home

Planning a more convenient, more livable bathroom for the home of modest cost is easier with Crane Bathroom Planning Service—offering arrangements within practically every price range. Ask about this service.

JOHN JONES, with a limited budget, is usually bent on getting the last ounce of convenience for his money in the house he buys. His architect faces the problem of providing sound construction plus as many of the amenities as John's slender purse will buy. One of the surest ways to give such clients high quality with greater livability is to specify a Crane Family Planned Kitchen.

No matter how modest the home, it can have the better design that Crane kitchen equipment offers—the step-saving convenience of a Crane sink designed with thorough knowledge of housewifely work habits and de-

sires. It can have Crane scientific kitchen arrangement approved by home economists and tested by wide, practical experience. And it can perform the additional functions which many home buyers require today—use of the kitchen for breakfasting or dining, for sewing, ironing or entertaining—whatever your needs may be.

For your use, Crane offers a complete kitchen planning service—offering a wealth of usable kitchen ideas for the low-cost home. Make use of this service—yours without obligation—and judge Crane quality for yourself at the nearest Crane Display Room.



CRANE

CRANE CO., GENERAL OFFICES
836 S. MICHIGAN AVE., CHICAGO
VALVES • FITTINGS • PIPE
PLUMBING • HEATING • PUMPS

NATION-WIDE SERVICE THROUGH BRANCHES, WHOLESALERS, PLUMBING AND HEATING CONTRACTORS



Something brand new in paint! A primer that makes successful two-coat painting a reality! Actually saves you one coat! It's the new Fuller Pure Prepared Primer . . . the primer of "controlled," even penetration. Unlike old-fashioned primers, this new Fuller primer provides a film of uniform strength . . . less chance for cracking, flaking, or blistering! Ask your Fuller Paint Dealer, or your painter, all about it.

**PURE PREPARED
PRIMER**

**FULLER
PAINTS**
they last

HERE and NOW

That's how people want their electrical service! Not "over there" or "in the next room" or "in an hour or two," but right where they are at the time they want to use it.

They are learning there is no excuse for having to detach one appliance before they can use another, for carrying appliances from one place to another in order to have service, for having appliances operate inefficiently, and for tripping over tangles of extension cords. And, above all, they will not continue indefinitely to pay for the privilege of wasting electricity as they surely do if the wiring is inadequate.

The convenient, efficient, and economical use of electrical appliances depends upon the wiring in the walls of the house, and adequate service should be built in when the house is constructed.

Let the adequate electrical service of the homes you build speak for you and tell of the care with which you plan for the comfort and convenience of your clients.

•
See the electrical exhibits at the Palace of Electricity and Communications at the Golden Gate International Exposition.

•
**PACIFIC COAST
ELECTRICAL BUREAU**

447 SUTTER STREET • SAN FRANCISCO, CALIFORNIA

Building for the Ages

Clay building materials have been used for centuries. In fact, the Modern Terra Cotta is one of the oldest building materials known to man. The name Terra Cotta means "burned earth."

Born of fire, burned clay products naturally resist further conflagration.

N. CLARK & SONS

116 NATOMA STREET
SAN FRANCISCO, CALIF.

PLANT: ALAMEDA, CALIF.

Portland • Salt Lake City • Los Angeles

With this thought expressed in a plaque over the display . . . N. Clark & Sons presents to the visiting public, in the Alameda-Contra Costa Counties Building at the Golden Gate International Exposition . . . a comprehensive showing of clay products produced for use in building construction. Included are the following items:

- Roof Tile
- Quarry Tile
- Brick
- Brile
- Essex Floor Tile
- Patent Pipe
- Chimney Pipe
- Alameda Pavers
- Architectural Terra Cotta
- Glazed Wall Units
- Ceramic Veneer
- Swimming Pool Gutter
- Shower Base
- Flue Lining
- Drain Tile
- Sewer Pipe





Photo by Moulin

ENTRANCE TO ADMINISTRATION BUILDING, MASTICK SCHOOL, ALAMEDA, CALIFORNIA
KENT AND HASS, ARCHITECTS



ADMINISTRATION BUILDING, MASTICK SCHOOL, ALAMEDA, CALIFORNIA

Kent and Hass, Architects

ALAMEDA HAS NEW TYPE ELEMENTARY SCHOOL

THE Alameda, California, Board of Education, in collaboration with its architects, Messrs. Kent and Hass, has developed a new type of elementary school which experts already have termed a real contribution to the educational opportunities of today. It is a one-story frame building with an open court or patio center and open-roofed passageway connecting all classrooms, administration offices and lavatory facilities.

The new school, as a whole, is impressive for its simplicity of design and architecture, unique in its value from the practical standpoint, harmonious in its color scheme both inside and out, protected from fire and earthquake hazards, and economic in construction.

All classrooms have east or west exposure and the kindergarten unit faces south with the alcoves facing east and west, all opening onto a separate terrace and play yard for the exclusive use of the small children.

There are twelve activity type classrooms, twenty-three by forty-two feet, a three-section kindergarten room, and an administration unit. The open court provides opportunity for out-of-door activities for the several classrooms. The center lawn of the patio is twenty-six feet by two hundred eight feet, in addition to the fifteen-foot paved open terraces on either side which connect directly to the classrooms for outdoor class activities. Each classroom has a planting space or small garden between terrace. Each has a frontage on the patio constructed largely of glass, affording ample daylight.

Lateral windows are placed above the blackboard areas on the outside wall of each room, opening over the roof of the outside passageway. Twenty-six per cent of the wall area of each room is devoted to windows of the universal type.

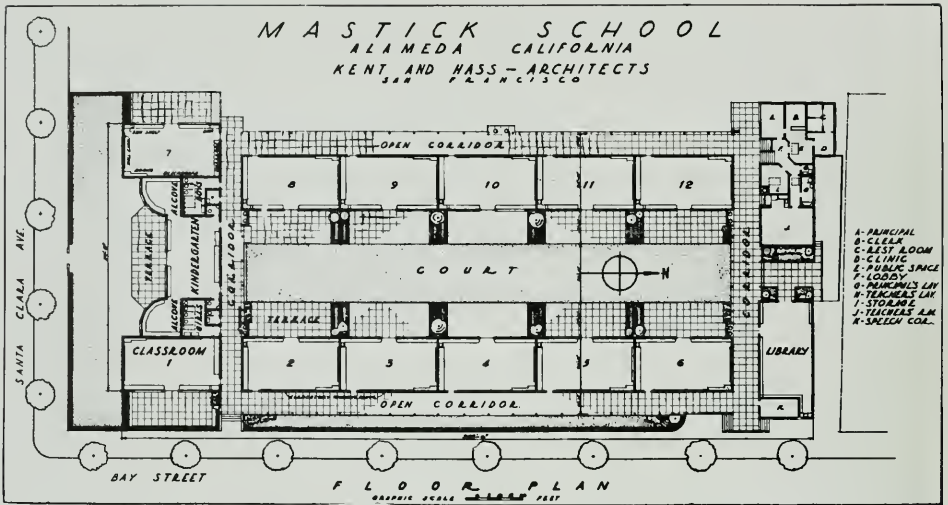

PLAN, MASTICK SCHOOL, ALAMEDA, CALIFORNIA
 Kent and Hass, Architects

Plumbing and Heating by Madden



ACTIVITY TYPE CLASS ROOM, MASTICK SCHOOL, ALAMEDA, CALIFORNIA
 Kent and Hass, Architects



KINDERGARTEN ALCOVE, MASTICK SCHOOL, ALAMEDA, CALIFORNIA
 Kent and Hass, Architects

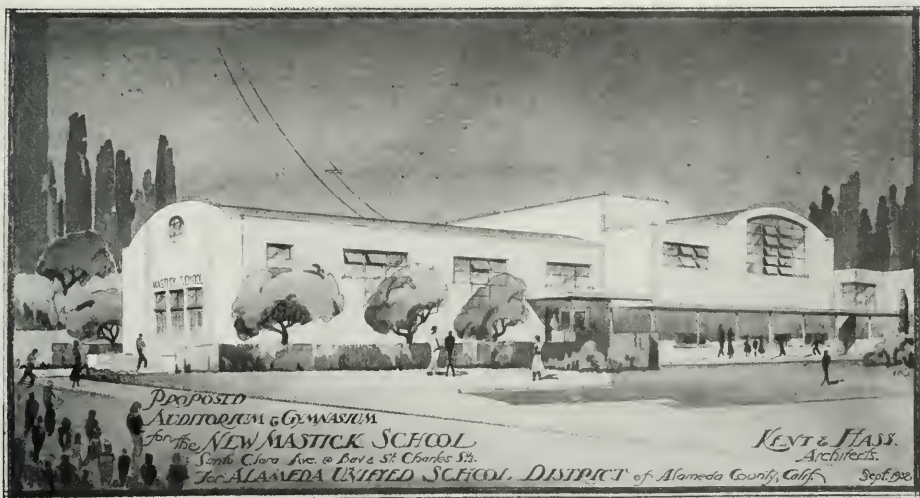

PERSPECTIVE, PROPOSED AUDITORIUM AND GYMNASIUM UNIT, MASTICK SCHOOL, ALAMEDA
 Kent and Hass, Architects

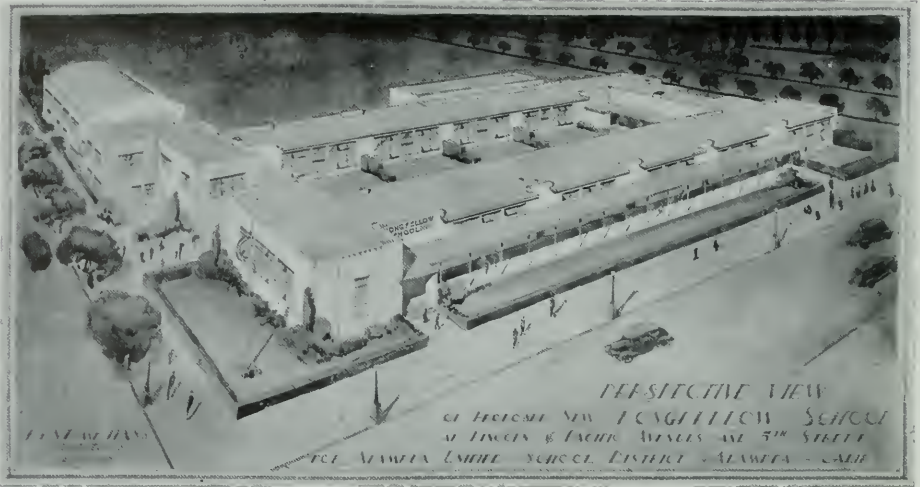

PERSPECTIVE, PROPOSED LONGFELLOW SCHOOL, ALAMEDA, CALIFORNIA
 Kent and Hass, Architects

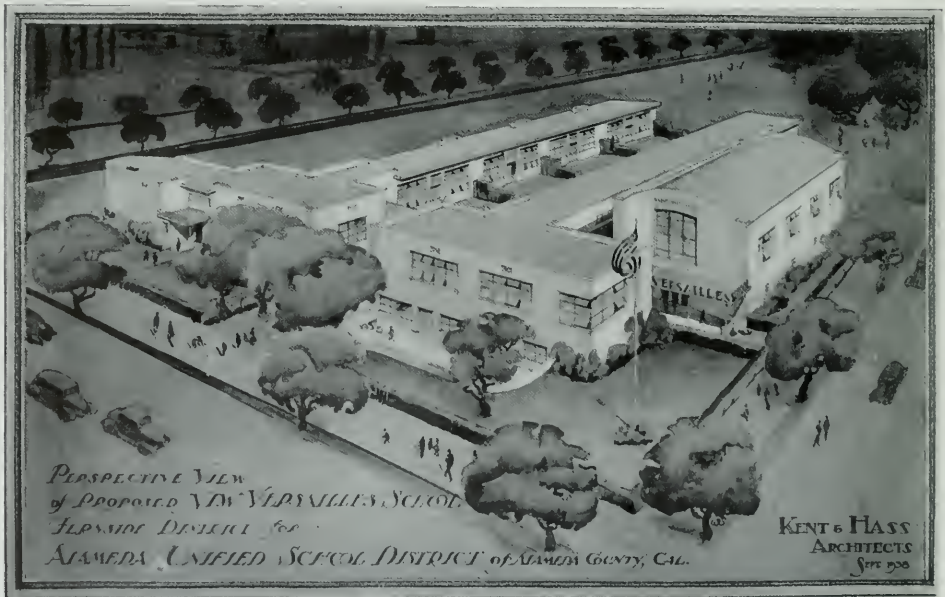

PERSPECTIVE, PROPOSED VERSAILLES SCHOOL, ALAMEDA, CALIFORNIA
 Kent and Hass, Architects

Particular attention has been given to interior color schemes. No two adjoining rooms are alike in color, and all are done in soft pastel tints with the woodwork painted in a slightly darker tone.

The linoleum floor covering is of a color which adds to the effectiveness of the room color scheme as a whole. Here is demonstrated that the old way of painting classrooms throughout a school in one monotonous color is most unnecessary and undesirable. Children live in these rooms many hours of the formative years of their lives, and they are influenced to an appreciable degree by harmony or lack of it in their classrooms.

The kindergarten is twenty-three feet by thirty-eight feet with two end bay-window alcove rooms, size sixteen feet by seventeen feet, which makes it possible for the teacher to arrange her pupils in different groups for the varied activities necessary in handling small children.

Every classroom contains the following features: Venetian blinds on all glass doors and windows, affording proper light control; built-in cabinets having dual control disappearing doors wherein ample provision is made for hats and coats with shelf space for packages, lunch boxes, etc.; a teachers locker cabinet; an all-metal drainboard, sink and running water; electric outlets for heating plates or other electrical equipment; a large inclined pinning board at one end of the room and a pinning space above and below the blackboards, each with a cork base; blackboard areas covering about two-thirds the length of one long wall; a large telechron clock; a loud speaker in connection with the school public address system; a direct fire

alarm system, connecting the school to the city fire department through the public address and broadcast system; a metal wall bracket supporting an American flag and staff; a thermometer and thermostat, controlling room temperature; direct semi-transparent light fixtures suspended from the ceiling, providing a soft daylight effect for night time or dark days; shelf space below the window line, varied in height in proper relation to the age of each classroom group; a heating unit concealed within the shelves with only a metal grille showing flush with the linoleum surface (this heating unit has a major control in the boiler room, assuring uniform temperature in each room); an air cooling system for summertime; movable desks and chairs of sizes suitable to the ages of the classroom groups.

The north end unit is a building slightly elevated above the level of the classrooms and containing the principal's office with windows overlooking the play yard, a business office, teachers' lunchroom, book and supply room, nurse's room and pupil rest room, study room and library, and a sound-proof room for audiometer and other special test purposes. The basement rooms in this section are devoted to lavatories, bicycle storage rooms, janitor's room, and boiler and heating equipment.

Plans provide for an auditorium, a gymnasium, and a parent-teacher's room to be added to this unit, and additional classroom units as population increases.

The authorities in charge of education in the City of Alameda and the architects who planned with them, are to be commended for creating the utmost in safety for the children and a practical and economical working plant.

PORTFOLIO OF SKETCHES BY GEORGE WARDNER



TELEGRAPH HILL, SAN FRANCISCO

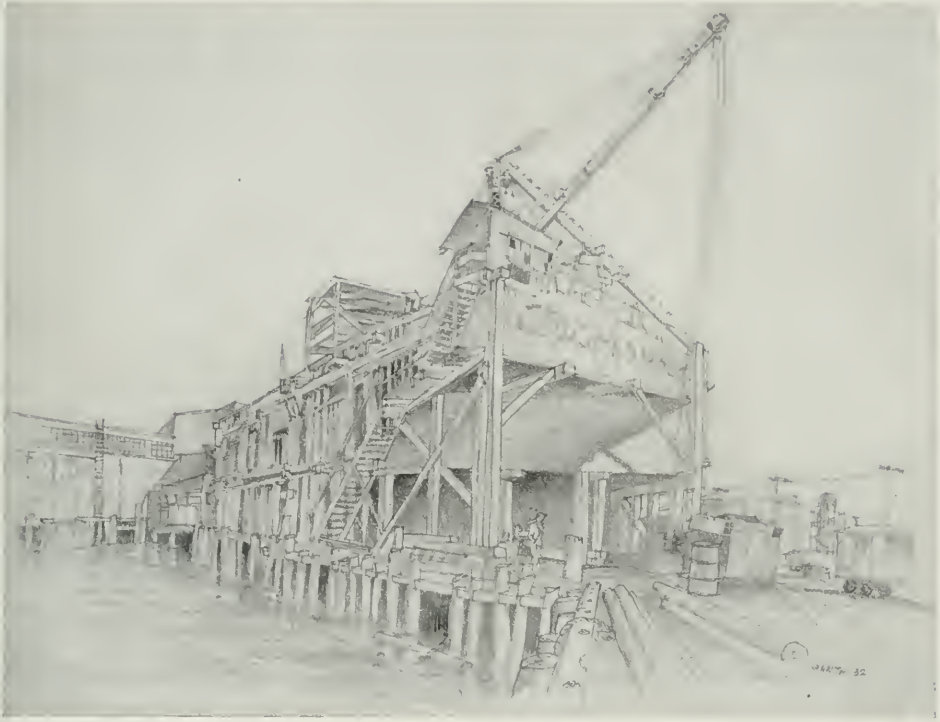

ON THE WATERFRONT, SAN FRANCISCO

A Young Architect's Sketches

WHILE the fine art of "sketching" almost comes under the head of a "lost art," there are fortunately a few architects who still enjoy it as a pleasant pastime. One of this number is George Wardner of Portland, whose sketches will be shared for the enjoyment of the readers of *Architect and Engineer*.

Wardner is a native Portlander, his academic training was at the University of Oregon and at Massachusetts Institute of Technology. Since graduation he has seen experience in Boston, San Francisco and Portland, in which latter city he now practices.

The sketches included in this series are from his portfolio, done as a hobby, though their manner manifests that his hobby is a serious one as well as an enjoyable one.

The drawings vary in manner from a rather free type to a very thoughtful and meticulous indication in the other extreme. In all, however, there is a sureness and certainty without a trace of tightness, that gives them a clean and refreshing feeling. His shadows are cool and transparent, his sense of perspective definitely sure, his compositions well considered.

We are confident all students of the pastime and profession of sketching, whether amateurs or oldsters, will find Mr. Wardner's drawings most interesting.

Portland, Oregon, June 8, 1939.

GLENN STANTON, A.I.A.

THESE SKETCHES ARE ARCHITECT'S HOBBY

George Wardner of Portland, Oregon, derives a great deal of pleasure drawing pictures of interesting buildings like those reproduced on this page.

Note his fine sense of definitely sure perspective and cool, transparent shadows.



WILLAMETTE "EAST BANK,"
Portland, Oregon

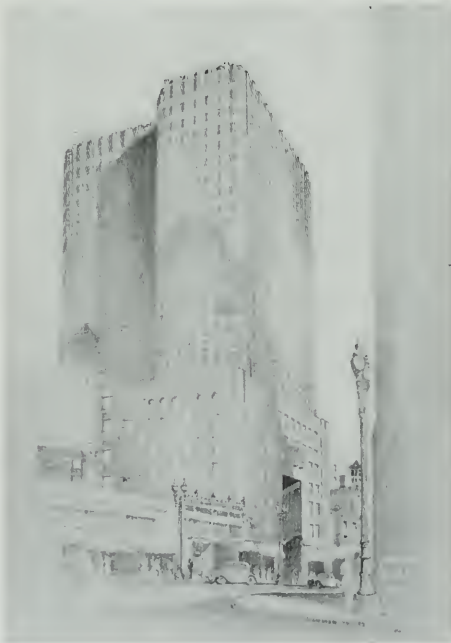

What San Franciscan would fail to recognize this faithful reproduction of 450 Sutter?



LOOKING UP POWELL STREET FROM MARKET,
SAN FRANCISCO

A HOME IN THE HILLS

By MARK DANIELS. Architect

IN writing of this home in the hills of suburban Santa Rosa, it is difficult indeed to resist the temptation to dwell upon the charm of the owners and the beauty of the location. The site is on the south slope of a hill close to the top, and is beautifully wooded with madrones, oaks and Douglas fir. There are few views in the country more enticing than the one from the Lieurance home that looks out over the City of Santa Rosa and the surrounding valley to the mountains on the south. Nestling in the valley, the City of Santa Rosa, with its extended orchards and cultivated fields, presents that essential element to landscape beauty, the result of human thought and order.

Specifications, or rather a detailed statement of the materials used, would be more interesting to those who are looking for information for themselves. The house has nine rooms, three baths, a powder room and lavatory and a two-car garage. The adjunct of a brick-paved terrace overlooking the view, the patio garden and other details so essential to a home, are hardly to be incorporated in the capacity of the house, yet function as units of it.

The exterior finish is brick veneer with stucco above the first floor, with the exception of the trophy room which is bricked to the roof. The smaller roofs over the porches and bay window are copper. The main roofs are interlocking tile of a heavy, substantial type. Being well out of town and in the edge of the forest country, it was felt that brick walls and tile roof were all but essential. Cast stone lintels were used over the entrance and on the windows of the trophy room. The walks are all of brick.

Interior finish varies from paper to plaster and from plaster to paneling. The living room is papered over plaster and ornamented with a cast stone mantel and hearth. The floors throughout the first floor are oak plank. The screen doors from the living room to the brick

terrace are of the disappearing, sliding type. The dining room is in panels and papered. The floors are oak plank. The stair hall with the vaulted ceiling and circular staircase is papered with a forest pattern. The stair rail is velour over wrought iron, the bannisters are wrought iron.

Mr. Lieurance has trophies which he brought back from his own shooting in Africa. This calls for a two-story height to the trophy room which is done in Port Orford cedar planks on walls running up to a redwood waxed and treated ceiling. The Port Orford cedar planks are stained in an ivory tone and wax rubbed. Windows of the gun case are leaded glass as are the book cases. The fireplace is handcut stone with the chimney breast running to the ceiling. The floors are again oak plank.

The strong modern tendency to gather in the kitchen to chat matters over called for a close proximity of the ice box and the very best and most modern of work table tops, which resulted in the placing of large tile, lined with orange strips on both the work table top and the splash-board back, all of which was fitted around the latest type of dishwasher. The kitchen is ventilated with a reversible electric fan and the passageways are so arranged to leave a small desk space for telephone and recipe books.

All bedrooms are papered on plaster; floors are again oak. The bathrooms throughout are tiled to a four-foot dado height. The sun deck is canvassed.

In general, the windows throughout are steel casement. Doors are flush, all piping is copper. The heating system is the latest oil fired, hot water General Electric plant with Modine convactor radiators.

No one knows just how his house is going to function until he moves in. The question as to whether one room will be more popular than another often is debatable where there



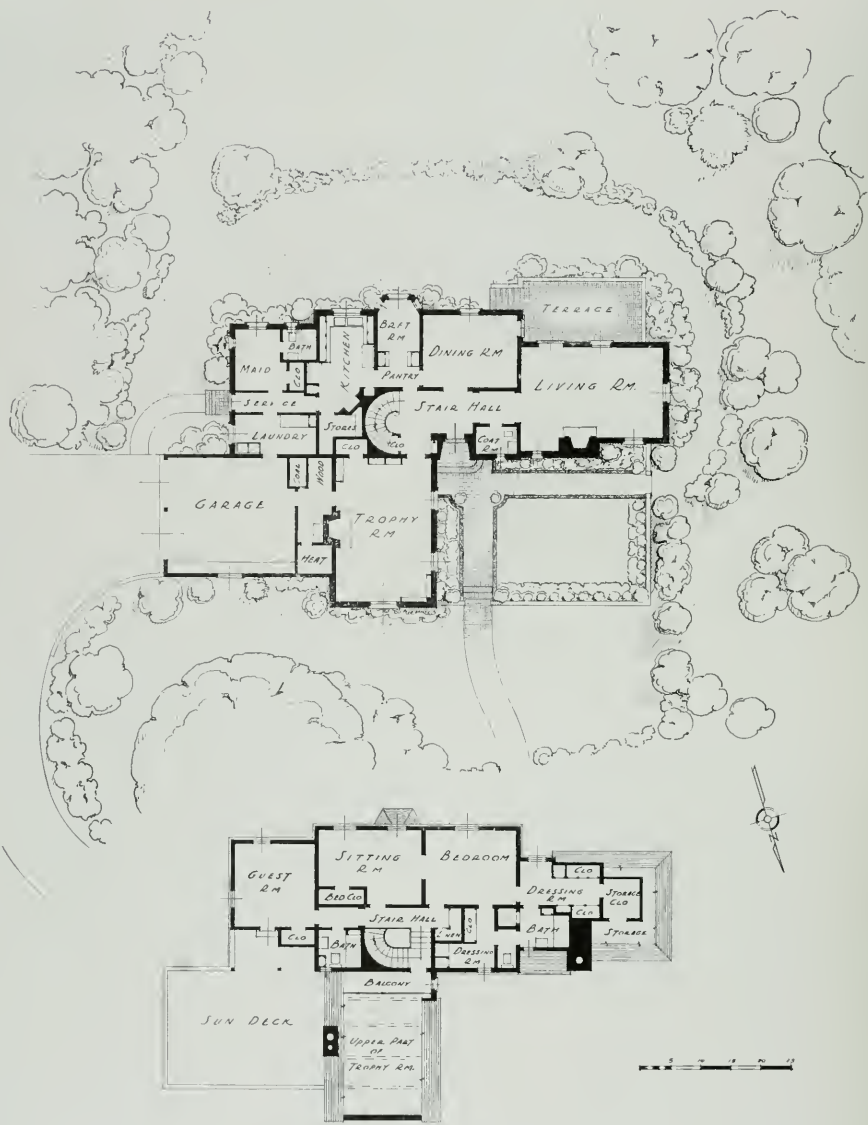

PLANS, RESIDENCE OF B. H. LIEURANCE, NEAR SANTA ROSA, CALIFORNIA
 MARK DANIELS, ARCHITECT



STREET VIEW, RESIDENCE OF B. H. LIEURANCE, NEAR SANTA ROSA, CALIFORNIA

Mark Daniels, Architect



LIVING ROOM WING AND TERRACE, RESIDENCE OF B. H. LIEURANCE

Mark Daniels, Architect

are two or more rooms that can be used for company. It happens that in the home of Mr. and Mrs. Lieurance the war is still on between the trophy room and the living room, with the odds a little in favor of the trophy room. Most people drift eventually to sitting there, even though they are surrounded by the heads of ferocious animals. There is an atmosphere in this room that invites leisure and conviviality. Altogether it would be difficult to find a place with such a setting, such views and so much of that "great, elusive, ever-sought-after quality, artistic charm."



REAR GARDEN AND TERRACE, RESIDENCE OF B. H. LIEURANCE,
NEAR SANTA ROSA, CALIFORNIA
Mark Daniels, Architect



TROPHY ROOM



DINING ROOM DETAIL

HOME PLANNING DO'S AND DON'TS

By CLEMENT W. FAIRWEATHER, F.A.I.A.

WHAT shall it be, that home of today? Ancient or Modern? Picturesque or streamlined? Aesthetic or practical? What principle shall guide the minds and hands of those who plan the house of nineteen thirty-nine?

Speculative builder who builds houses to sell will, of course, exploit the fad of the moment and market products which reflect the fashion of the day. Why shouldn't he? The sooner your radio or refrigerator get out of date, the better it is for trade and, after all, you can buy another one. But your home is a very different thing. "Probably this is the only time that we will ever build," you tell your architect, and you don't want to be stuck with a glass brick house a few years hence if glass brick houses just simply aren't being built any more. There's something reassuring about the thought that the little white house with the picket fence has stayed in fashion, off and on, for two hundred years.

Only by absorbing the inspiration of the past and adapting it to the needs of the present can beauty be created. Nothing worth while can be made if we think only in terms of our immediate point of view. We don't mean by that, we are opposed to modern thought with its practical aspects, but, after all, you have to think of the spiritual aspect of the home, if you hope to build something of enduring charm. You cannot have a home which will give you lasting happiness if in making it, your main pre-occupation is bath tubs and kitchen sinks or if you build it around a theory that the whole secret of successful planning centers around a mathematical computation of the number of steps Mother has to make in the course of preparing breakfast. We do so, know something about that, because our wife was away for four months recently and we can boil an egg against anybody, anywhere. Stove to sink, six elephant

pit-a-pats; sink to refrigerator, nine; back to table, seven; twenty-two times one hundred and eighty-four makes three miles or something.

Anyway, the busy mother doesn't always have time for proper exercise and while it is true that running 'round the kitch' is not as beneficial as taking the baby for a walk, after all, it isn't actually harmful. We realize that this statement will bring a lot of B.M.s. on our neck—and not in embrace either—but dears, you know yourselves that what with the beds, and the dishes and stringing the beans and your husbands along, you have to put baby out on the porch and forego the walk half of the time anyway, if you are to get simply anything done at all. Now, haven't you?

Of course, some of you may say, "Now lookit young man, we are past the baby stage and don't need those pit-a-pats." Ladies, we are in our fifties ourselves, though not past the age of romance, if any of you like our writing, and you know perfectly well that you are not past that age yourselves and how very important it is to keep slim.

We realize that one doesn't get anywhere don't-ing people, but at the risk of possible abuse, we will give you a few don'ts and if you will read them through carefully, we will then turn constructive and give you some do's.

DON'T try to get the cheapest plan: If that's what you want, you should have a round house and enter directly into the living room and each room from that, but you know perfectly well that a long, low rambling house with the windows sticking through the eaves is better—or am I wrong, and don't you?

DON'T try to eliminate all corridors. They add to the spaciousness of the house even if they do somewhat increase the cost.

DON'T insist on having the bathroom over the kitchen because it is cheaper so. If it works

out that way, it's very nice, of course, but there's no sense in having the bathroom where you don't want it, just to save a few feet of cast iron soil pipe.

DON'T pay too much attention to that fetish about having the house the proper width to save timber. The actual effect on the cost of this item is negligible and it is more important to be sure that the width of the dining room is adequate.

DON'T ignore the practical aspects when planning your home, but let them be your servant, not your master.

And now for a Do.

DO get a good architect to design your home. We say a GOOD architect advisedly because while the percentage of poor architects is very low, you know it would be "just your luck." So make inquiry and be particular. Get some fellow who has respect for the past, faith in the present and thought for his reputation in the future, and tell him your problem. Tell him that you must have two bedrooms and that you suspect that you should have three, because, after all, mother, while stubborn, is getting along in years; and tell him that if he can squeeze in an alcove at the front of the garage big enough to take a pram, it would be

nice because the garage will have a ramp and the kitchen door won't. Explain to him that the house must be set far enough back so that there will be a nice garden in front with holly-hocks and lilac and things like that, and

DO remember the gas and electrical gadgets, vacuum cleaners, electric toasters and shavers, gas ranges and oil burners, although, what with the price of gas what it is, maybe you should heat by gas. Oh, and

DO make him put in a base plug for a dishwasher because you know HE used to say that you had such nice hands and you never know, he might, and

DO remember to tell the architect about brass piping because that is terribly important if the water is hard or soft, we forget which, and

DO have a good time while you are building the house and be happy in it ever afterwards, and

DON'T take this article seriously, at least, not very.

If you will do all these do's, and not do all the don'ts and if you get most of the things you want, as we hope you will, you will have the real home of the past, of the present, and of the future.



GARDEN VIEW OF A COLONIAL BUNGALOW



SAN DIEGO'S NEW CIVIC CENTER

By RICHARD S. REQUA, Architect

PRIOR to the recent completion of San Diego's new Civic Center, possibly no city or county in the nation was in greater need of modern, adequate administrative quarters. The old courthouse, erected in 1890 when the community was a village of 20,000, had long been outmoded and overwhelmed by new and necessary departments and offices so that many of the bureaus had, for years, overflowed to office buildings, remodeled stores and garages. Similarly the old City Hall was an antiquated structure, so small that many important city departments had been forced to scatter to other quarters. It is estimated that the city and county spent \$50,000 annually in rentals for space required for administrative purposes.

Due to the stringent financial conditions in the early '30's, no real headway was made toward improvement of the Civic Center until 1935 when the Works Progress Administration

agreed to appropriate \$989,527 for a City and County Administration Building on the site. The city and county contributed \$105,600 as the sponsor's share and the Civic Center Committee started to work.

Plans and specifications were completed in February, 1936, and a WPA project for excavating for foundations, erection of construction facilities, driving of foundation piles and structural work on the foundation up to ground level, was completed in December, 1938, at a cost of \$329,000.

From this point on, construction of superstructure was let by contract at a price of \$627,069 for structural work, finished exterior, and roughing-in of plumbing, drainage, elevators, heating and other incidental items. This phase of the work was finished on January 10, 1938.

The main portion of the building extends



CITY AND COUNTY ADMINISTRATION BUILDING, SAN DIEGO, CALIFORNIA

Louis J. Gill, William Templeton Johnson, Richard S. Requa, Sam W. Hamill, Associated Architects

north and south of the central tower which is the dominant architectural feature. Wings at either end extend to the east. Ultimately, similar wings may be built to the west, forming an H-shaped plan when city and county growth requires additional space. The structure is 545 ft. long and 245 ft. across its widest section. Arrangement on the lot is such that there is ample space north and south of the building to permit erection of a Hall of Justice and an Operations Building, both proposed for future construction.

Architectural treatment of the exterior of the building is a pleasing combination of modern design with Spanish detail which definitely associates it with the historic architecture of the Southwest. Essentially an architectural concrete design, colored tile in interesting patterns has been used for covering the domes over the entrance to the wings, and for facing main entrances, borders around window groups and recessed panels in the top of the tower. Over the main portions of the building, Spanish roof tile in variegated shades of reds and browns contrast with the warm toned white

cement wash applied directly to the concrete walls, resulting in a colorful harmonious ensemble.

The building is constructed in five entirely separate sections, divided by expansion joints to prevent earthquake damage. The tower is an independent structure carried down 26 ft. below finish grade to firm subsoil. Other sections of the building rest on piles which vary in length from 32 to 35 ft., depending upon the depth of firm soil below the sand fill. A total of 1,521 piles, capped with concrete below water line and connected to form a continuous grid under each section of the building, form the solid, earthquake-resisting foundations. The tower foundation was placed on a bed of gravel and, after the foundation slab was laid, cement grout was forced under great pressure through holes in the slab to fill completely all voids in the gravel.

Except for the framing of the tile roof over the center portions of the building, the structure is entirely reinforced concrete—including all floor and roof slabs, interior walls and columns. The structural design, prepared by J. H.



COCKTAIL LOUNGE AND CIRCULAR BAR, MARK HOPKINS HOTEL, SAN FRANCISCO
 Note Treasure Island in the distance (left), Bay Bridge (right)

A NATURAL MURAL OF MATCHLESS BEAUTY

SAN Francisco's newest cocktail lounge is atop Hotel Mark Hopkins. From its lofty vantage one may view, on a clear day, the city and bordering land and sea for miles around. San Francisco Bay, the green Marin Hills and the exotic towers of the Exposition on Treasure Island all lie before the watcher's eyes, and closer, in bas relief are San Francisco's famous landmarks—Fisherman's Wharf, the colorful Latin Quarter, and the deep-curved roofs of Chinatown.

The interior of the lounge is quite as striking, in its own way, as the incomparable view that lies below its windows. Timothy Pflueger, architect, has used shades of jewel-red, grey, blue and pale pink in modern, yet skillfully harmonious, design. Every surface that could possibly cause reflection on the great windows has been considered and dealt with in texture and color. Lighting is recessed in the blue ceiling, and fabric is used on the walls to give a rich textural effect rather than a painted finish.

The bar, in gleaming black, is in contrast to

the padded and quilted pink leather panelling. The bar stools are also cushioned with the pink leather. Chairs and settees surrounding low black cocktail tables are upholstered in red, blue and pink hand-woven frieze.

The windows form 90 per cent of the wall space and are made of half-inch plate glass, built to withstand a one hundred-mile gale.

Upper
 Strip of
 Illuminated
 Windows
 Indicates
 "Top of the
 Mark"
 Cocktail
 Lounge





VIEW FROM "TOP OF THE MARK" COCKTAIL LOUNGE, SAN FRANCISCO

Timothy L. Pflueger, Architect

REGISTERED ARCHITECTS AND REGIONAL COMPETITIONS

Soon the Director of the Procurement Division, U. S. Treasury Department, will call for competitive plans from architects in the Pacific Coast Region for a Post Office building at Burlingame, California.

At the present moment a similar regional competition is in progress for a new Post Office, Court House and Custom House at Evansville, Indiana, and for which the official notice to architects reads: "This competition is open to all registered architects who are citizens of the United States of America and whose home offices are located within the confines of Region No. 7, which includes the following states: Ohio, Wisconsin, Indiana, Illinois and Michigan."

With further reference to this notice, the following official press release by the Treasury Department has stirred up a hornet's nest among Eastern architects and if the ruling applies to all regional competitions its effect locally is vital:

"Architects who are not registered but whose home office is within the region above mentioned, are eligible to enter this competition upon the submission of qualifications satisfactory to the (Treasury) Department."

Naturally this statement has led to some confusion inasmuch as all five states included in Region No. 7 have architectural registration. As registration has been encouraged and supported by the various Institute Chapters of State Architectural Societies in these states and in several instances has been accomplished only after years of effort, it is quite natural that those who have been interested in establishing a higher standard for the profession through registration should be very much concerned with any action that apparently encourages a departure from the established law.

Speaking for the architects in the State of Michigan, Clair W. Ditchy writes:

"It may be pointed out that an 'architect' not registered but with his home office in this region introduces a gentleman whom the profession hereabouts has been at some pains to suppress. The title 'architect' is now clearly defined and protected in the law of Michigan, and if one is not registered he is not legally an architect. The same may be true of Indiana and the other states concerned, but unfortunately I am not familiar with the details of their laws. But at any rate a principle is suggested which is contrary to the law of at least Michigan and Michigan architects among others are invited to subscribe to it.

"If the intention is to invite draftsmen and designers who are not architects, I believe this should be clearly stated."



RESIDENCE OF BEN H. O'CONNOR, SAN MARINO, CALIFORNIA
Ben H. O'Connor, Architect

ARCHITECT DESCRIBES HIS OWN HOME

By BEN H. O'CONNOR

WHEN an architect designs his own home he invites more than the usual amount of critical inspection, and when he attempts to write about it he finds himself in even greater danger. However, having taken the one step, I take the next as well.

Our house is my answer for the deep and narrow lot. It is planned to meet the requirements of a family of three, all of whom like to "back yard" as much as possible. In design, no studied attempt has been made to follow a traditional style, but dignity has been maintained through the use of simple forms and careful planning for architectural effect. The front door is sheltered by a covered porch which affords a wet weather connection to the garage. On entering the house one may reach the living room, kitchen and bedrooms directly from the entrance hall, a factor which saves many steps. The living room is simple but not

without interest. The fireplace with its adjoining bookcase is somewhat unusual in its treatment, as no effort has been made to provide a formal effect.

As the result of a desire to attain the great-



CORNER OF LIVING ROOM, RESIDENCE OF BEN H. O'CONNOR, SAN MARINO

est possible use of the garden, the garage was placed in front, entered from a forecourt. This not only avoids the usual long and narrow driveway, but is an invitation to guests to enter.

In the kitchen, a modern gas range and gas refrigerator were planned in for convenience and efficient cooking. A storage tank gas water heater provides an abundance of hot water, and a gas forced air unit supplies automatic heating comfort.

In the placing of all rooms care has been

taken to ensure sunshine, circulation and the best possible views afforded by the site. Privacy has also been attained in the room arrangement. Living room and dining room both face the rear garden, as does the pantry which is frequently used as a breakfast room, a wall panel becoming the table at such times. Other items of interest are the stair which is rather graceful with its slender rail and winding treads; the patio with a fireplace for outdoor meals; and a guest room which may be used either as servant's room or study.

WINNERS OF A SMALL CHURCH COMPETITION

ALL winners of prizes and mentions in the recent competition for A Small Church, conducted by the Department of Architecture, University of Notre Dame, reside in the East. They are: First prize to John W. Davis, Urbana, Ill.; second prize, Bernard E. Loshbough, Washington, D.C.; third prize, Geo. W. Edwards, Pittsburgh, Pa. Five contestants received mentions.

A number of designs were discarded early from consideration as these represented types that had been built many hundred times as the solution of a small church. Search was made for those designs that showed appreciation of the limitations of the problem in providing seating accommodations for two hundred.

The design by Mr. Davis was judged to be a good study of the problem and its exterior treatment was sufficiently simple and fresh without offering too great a shock to the

parishioners.

The second prize design of Mr. Loshbough had a delightful plan that attracted the jury from the beginning—a plan that would serve the purpose well for whatever services might be held in so small a church.

The third prize design of Mr. Edwards was simply planned but it was the opinion of the jury that further study of the sanctuary would have resulted in a revision of the roof slopes that would have provided just as dramatic a lighting of the altar without suggesting a theater gridiron.

The jury was composed of the Reverend Andrew Chapman, P.R., of Lafayette, Indiana, a frequent contributor to Liturgical Arts upon liturgy; Harold Maurer, of Maurer and Maurer, architects of South Bend, Indiana; T. Clifford Noonan, and Thomas E. Cooke, architects of Chicago.

PRIZE WINNING DESIGN BY JOHN W. DAVIS ON OPPOSITE PAGE

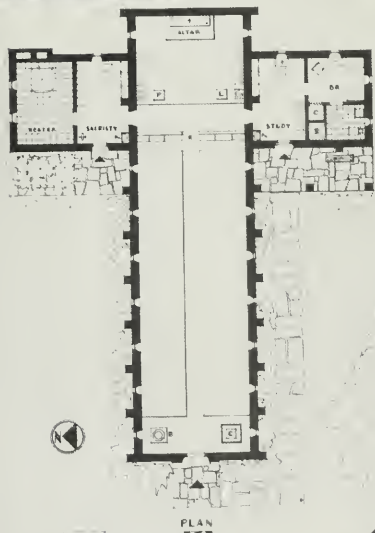
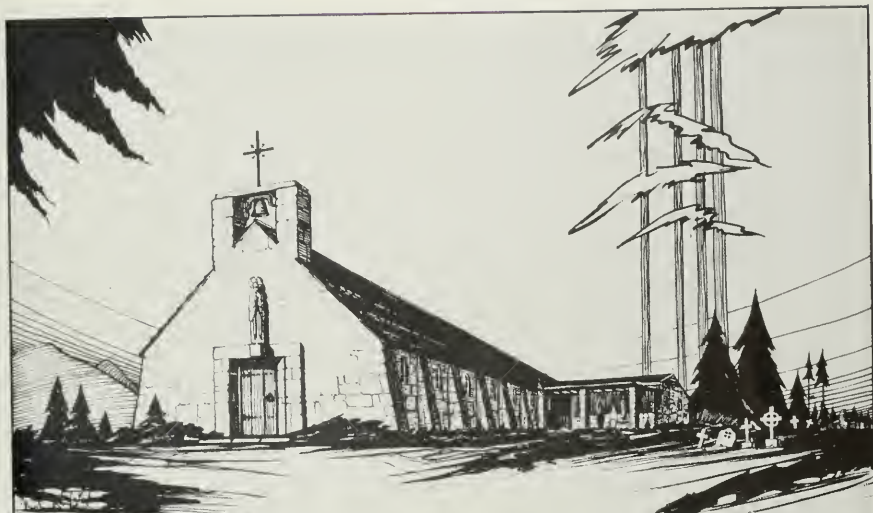

A
SMALL CHAPEL
In the
NORTH COUNTRY
OF NATIVE STONE & HAND-Hewn TIMBERS



INTERIOR - PERSPECTIVE



CUBAGE : TOTAL 24920 cu ft
A SMALL CHAPEL 24' x 21' x 7' 0"
B NAVE + PORCH 24' x 18' x 7' 0"
C NAVE + PORCH 24' x 18' x 7' 0"
D NAVE + PORCH 24' x 18' x 7' 0"

SECTION

DRG. EPLAND

AWARDED FIRST PRIZE IN COMPETITION FOR A SMALL CHURCH, SPONSORED BY THE DEPARTMENT OF ARCHITECTURE, UNIVERSITY OF NOTRE DAME.

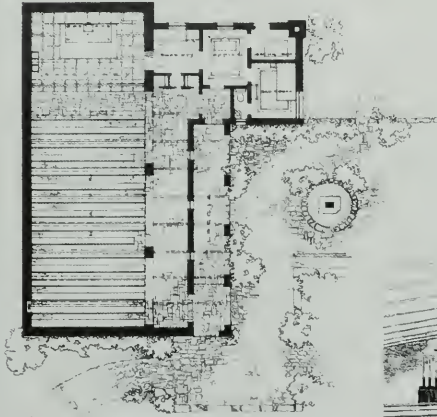
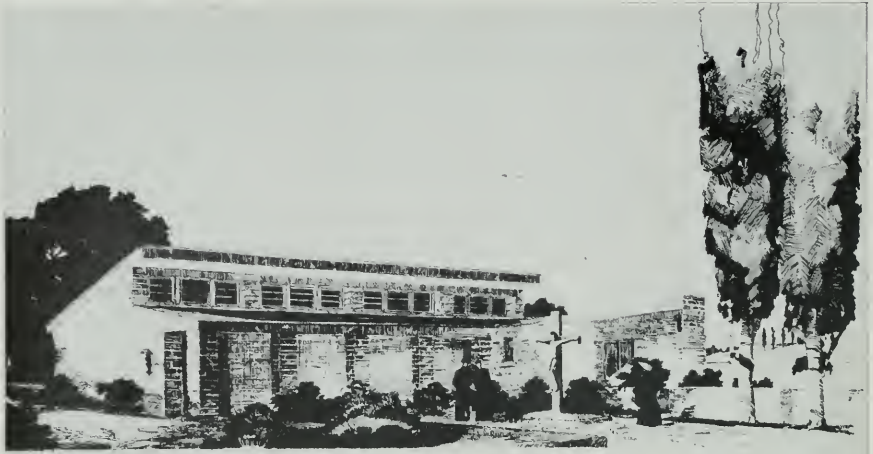

P L A N

DESIGNATION /
 CONTENTS
 CURVE OF CONTENT



I N T E R I O R

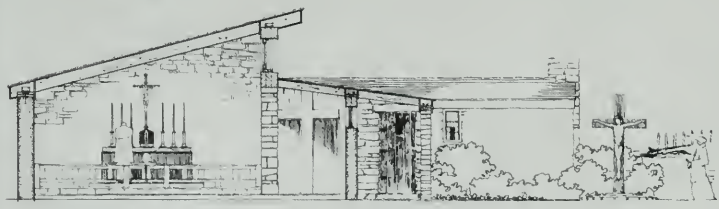

S E C T I O N

A C O U N T R Y C H A P E L

second Prize

AWARDED SECOND PRIZE IN SMALL CHURCH COMPETITION SPONSORED BY THE DEPARTMENT OF ARCHITECTURE, UNIVERSITY OF NOTRE DAME. SUBMITTED BY BERNARD E. LOSHBOUGH.

IMPORTANCE OF BATH ROOM MODERNIZATION IN APARTMENTS

By MILDRED BRENNAN

A RECENT survey by a real estate group disclosed that it's the bathroom that interests women the most when a new home or apartment is being considered. An old-fashioned, out-of-date bathroom will turn away prospective tenants, because they will naturally think the other rooms in the apartment are on a par with the bathroom.

Bathroom modernization, therefore, is one of the essential features of nearly every apartment house rehabilitation program. If corners are to be cut, they had better be found elsewhere; new bathroom equipment is almost invariably needed if the modernized units are to produce the revenue that will justify the expenditure on the building. To put it another way, if the building needs modernization at all, it will in all probability need new bathroom fixtures. The competitor with brand new bathroom fixtures has a sales argument that speaks for itself.

The important objective of modernization is to create an atmosphere of smartness and color combined with the best in sanitation, that will attract the tenant. The cost is not prohibitive. Prices are lower and quality is higher than in years.

The average American is acutely plumbing conscious and instantly recognizes an old bathtub, particularly the drab, utilitarian fixture of a decade ago. Bathtubs today may be obtained in 20 different models and styles. The plumbing industry has built greater utility, convenience and safety into this fixture. The modern tub is low, the newer models measuring only 16 inches from the floor to the rim, thus making it easy to step in and out. They have a wider, flatter bottom which lessens the danger of slipping, and adds to the pleasure of the shower.

Many of the new bathtubs have integral seats either at the ends, corners, or on the side. The seat does not take up more space,

and adds greatly to the convenience of the fixture. Made of porcelain enamel fused on rigid cast iron, the modern bathtub provides the greatest possible lustre and durability, two essentials of apartment hotel plumbing fixtures.

Improvements in the design of the bathtub have been paralleled by similar changes in the valves, waste controls, and fittings. Spouts are larger so that the tub fills more quickly. They are placed well above the rim of the fixture to prevent the possibility of water being siphoned out of the fixture in case of negative pressure in the supply line. Waste openings are larger to provide quicker drainage.

Apartment bathrooms are not considered modern if they are not equipped with showers. Available for the bathroom in the new apartment house, or the bathroom to be modernized, are showers to fit every budget, new and more economical showerheads, improved valves and controls, metal pre-fabricated shower cabinets, glass shower enclosures and doors, and handsome shower curtains in an infinite variety of designs and colors.

No other item of plumbing equipment is made in such a variety of styles and is offered at such a wide price range as the shower. Any showerless bathroom can be modernized easily and economically. Showers for the built-in tub can be fitted to the wall in a few minutes by an experienced plumber. No changing of the piping in the walls or marring of the plaster or tile is necessary. All that is required is the replacement of the spout on the tub with a new spout equipped to receive the shower riser. With the setting of two screws in the wall to anchor the fixture, and the fastening of the curtain rod, the installation is complete.

There has been a great improvement in shower heads from the standpoint of economy of water and ease of maintenance. The new midget heads are only $2\frac{1}{2}$ inches in diameter,

in contrast to the huge shower heads 6 or 8 inches in diameter in vogue years ago. Concentrating the water on the bather, the tiny head uses from 25 to 50 per cent less water with consequent economy in fuel for heating water. The midget shower heads may be adjusted to give a stream of varying intensity, and are practically non-clogging.

A slightly larger and de luxe head provides any kind of a stream desired from a stinging needle shower to a sluggish and soothing down-pour. Another innovation in shower equipment is a head mounted on a tube equipped with a ball and socket joint so that the stream of water may be directed on the body of the bather from any angle.

An important safety feature in showerbaths is the mixing valve, both of the thermostatic and pressure type, which provides protection against unexpected shocks resulting from a sudden change in the temperature or pressure of the water.

Shower cabinets in a wide variety of styles and sizes vie with over-the-tub showers in popularity. A recent development for stall showers is a shower stall floor of non-oxidizing rubber, skidproof, warm and comfortable to the feet, light in weight. This flexible floor is leakproof, easy to install and very economical. It makes possible the installation of a shower stall at low cost. Cabinets for showers are obtainable in light gauge steel or with walls and receptors of vitreous porcelain enamel. Apartment managers are finding that the installation of a shower, either in connection with the tub or in separate compartments, is a profitable addition.

Of all the plumbing fixtures in the bathroom, the lavatory is the most beautiful and offers the apartment manager the greatest leeway for making the bathrooms in his building distinctive and individual in design. More than 200 different kinds of lavatories are available today for the new apartment building, or the bathroom in the building to be modernized. Whether of wall, pedestal or leg style, lavatories have ample slab or shelf space, which

is a great convenience; and lavatories may also be had with roomy cabinets under the bowl—lots of room for the storage of even large bottles. For the small room where space is at a premium, compact lavatories are manufactured to fit into corners close to the wall and occupying very little room.

A great convenience on the new lavatories is the mixing faucet that gives tempered water, permitting the user to wash his hands in running water. Many owners, however, feel that automatic faucets or self-closing faucets, should be used, as they close as soon as pressure is released, which means a saving in water. Fittings that add so much to the attractiveness of lavatories today, are of brass, polished and plated with a heavy coating of chromium that may be cleaned with a damp cloth, and that defies the hard service encountered in apartments.

Because of the importance of the fixture, the closet for the apartment bathroom should be selected with great care. It is here that quality counts. Characteristics of the better closets are trapways providing freedom from stoppage, strong positive flushing action, a large water covered area in the bowl, and quiet operation.

One of the newest developments is the closet with tank and bowl in one piece. Because of its smart appearance, the one-piece closet is particularly recommended to the owner who wants to offer bathrooms that are a step ahead of those provided in competing apartments.

The close-coupled closet, the next preference of discriminating apartment owners, has the bowl set close under the tank, thereby eliminating the usual exposed pipe or flush elbow.

Where flush valves are used they should be equipped with vacuum breakers. The following are the new rules relative to submerged inlets and protective methods to be applied to prevent contamination of water supply, which were adopted by the Board of Standards and Appeals and became effective February 27:

Rule 1: Flush Valve Fixtures—Flush-valve controlled fixtures, with submerged inlets sup-

plied directly from the City Water Supply System (and not supplied from separate riser and tank), shall be equipped with an approved vacuum breaker in the supply line not less than four inches above the overflow level of the fixture, to prevent siphonage or backflow of contaminated water into the house distribution piping, and checked by the inspector.

Rule 2: Ball-cocks—Flush tanks operated by ball-cocks shall have an approved vacuum breaker located not less than one-half inch above the overflow outlet of the flush tank.

Rule 3: Submerged Inlets—Water supply inlets to fixtures shall be located at least one inch above the overflow level of the fixture, except when submerged inlets are absolutely essential for the proper functioning of a fixture.

Rules 4 to 9 inclusive apply to sterilizers, bidets, condensers, roof or suction tanks, and sump or well pumps.

An old-fashioned dingy wooden seat in your bathroom speaks louder than any sales talk you may give the prospective tenants, and it is talking against you. The better seats, either open front or closed, are made of hard rubber composition which is impervious to moisture and will not crack or chip. This seat offers the utmost in sanitary protection. Also available are sheet-covered seats in 18 different colors including pink, green, shades of blue and lavender, and mother of pearl.

And speaking of color—don't just speak of it—or think of it—but use it. Architects should place their clients in a position where they can show prospects apartments with bathrooms in a variety of color schemes. Let the color of the plumbing fixtures be the key color in the bathroom, and around that develop your plan for the rest of the room.

Among the variety of materials for the walls and floors of the bathroom are linoleum, waterproof wall paper, asbestos wainscoting, asphalt tile flooring, metal tile, rubber tile, and glass tile. They all have moisture-resisting qualities and are easily cleaned. The low cost of these materials, and their ease of application, make them desirable. Their most attractive feature for the apartment owner who is striving for the

individuality of each bathroom, is the fact that they come in many colors, shades and color combinations, that will harmonize with the color of the plumbing fixtures.

The three fixtures of the modern bathroom may be obtained in matched sets—each fixture having its own individuality, yet the color, the lines of the tub, the lavatory and the closet, as well as the chromium plated fittings—blending with each other to make a perfectly harmonious ensemble.

The ratio of bathrooms to other rooms in apartments is being stepped up. In many cases, owners will find it profitable to have additional bathrooms installed. Fortunately, bathrooms may be fitted into odd corners in the apartment, and if space does not permit, it is not essential to have all three fixtures in the one room. The tub and shower may be in one location—the lavatory and closet in another.

The planning of the bathroom so that the fixtures are in the best possible location is extremely important, of course. If possible, it is considered best not to put a bathtub under a window. The water closet should be given as much seclusion as possible, even if it is nothing more than along the wall away from the opening door. Experience teaches that the best location for the lavatory is near a window.

It is just as important to have plumbing fixtures correctly installed, as it is to buy good ones. Plumbing is the dynamic part of the house. It is here that quality counts, both in appearance and in performance. The hidden part of the plumbing—the pipe, valves, and fittings—are extremely important to the convenience and health of the occupants of a building. In order to be assured of trouble-free performance and low maintenance cost, the entire plumbing system including the fixtures must be installed under the supervision of an experienced plumbing contractor.

There are numerous accessories that can be installed in the apartment bathroom that mean comfort and convenience, that are a satisfaction to the tenant, but are not a drain on the money allotted for the improvement of the apartment hotel.

(Turn to Page 51)

INTERIOR
BUILDING FOR
I. MAGNIN & CO.
LOS ANGELES

Hunt & Chambers,
Architects

T. L. Pflueger,
Architect of Interior



CENTER ANCHORAGE OF SAN FRANCISCO BAY BRIDGE;
A POINT OF INTEREST AND COMMENT BY ENGINEERS

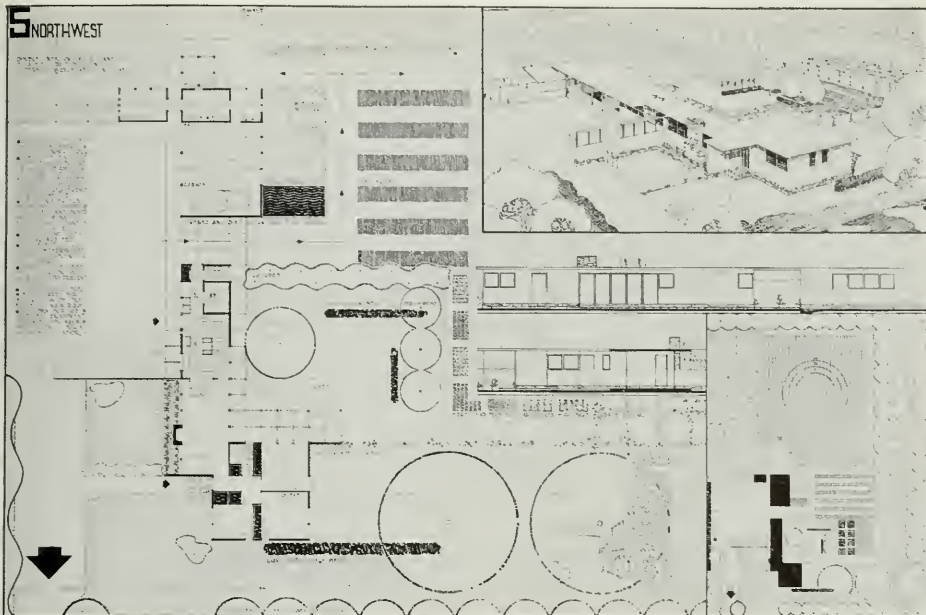

WINNING DESIGN IN PRODUCTIVE HOME ARCHITECTURAL COMPETITION

John E. Dinwiddie, Architect; Garrett Eckbo and Albert Hill, Collaborators

LOW COST SINGLE FAMILY DWELLING

San Francisco Architects Competition Winners

HERE are the winning designs of low cost single family dwellings for the Northwest section of the United States, submitted in a nationwide Productive Home Architectural Competition. The San Francisco winners are John Ekin Dinwiddie, architect and Garrett Eckbo and Albert Hill, collaborators; Francis E. Lloyd and Frederick L. Langhorst.

The plans were designed in accordance with the rules of the competition, to make it possible for moderate and low income families now living in the city to become owners of small garden homes within commuting distance of urban jobs.

The designs belong in the growing new "rurban"—rural plus urban—trend toward practical planned dwellings, which help carry part of their cost through vegetable gardens, poultry houses and sheds for small livestock, and kitchens designed for canning and preserving. Defense of the family against economic insecurity is the aim of the "rurban" architects. Under their plans the family cash income is provided by the husband's city job as in apartment or tenement life, but the family is enabled to save money and gain security by raising and processing food from its own land, using the modern household equipment.

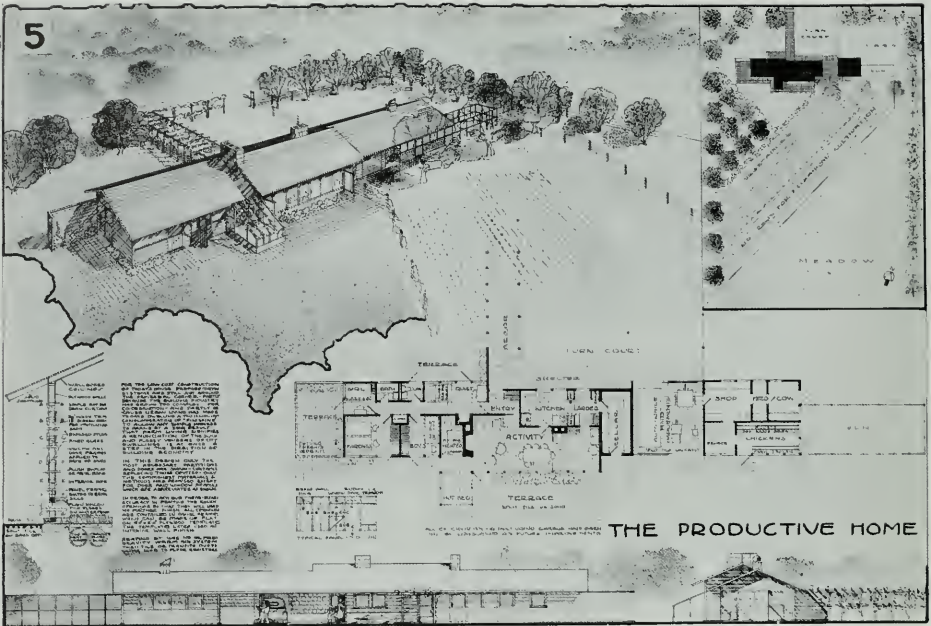

PRIZE WINNING DESIGN IN PRODUCTIVE HOME ARCHITECTURAL COMPETITION
 Frederick L. Langhorst, Architect

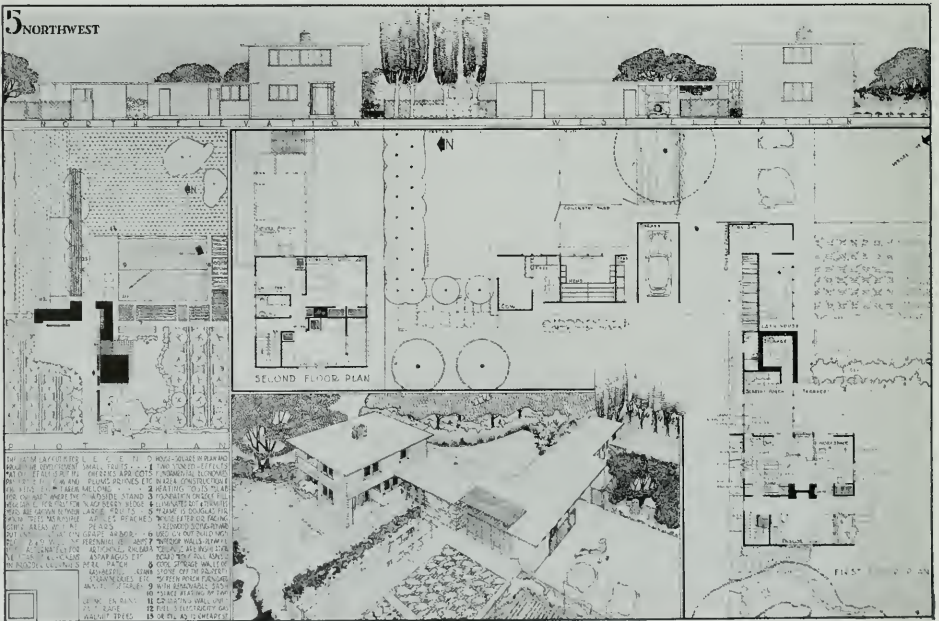

PRIZE WINNING DESIGN IN PRODUCTIVE HOME ARCHITECTURAL COMPETITION
 Francis E. Lloyd, Architect

Some Unique Requirements of London Building Regulations

By ROBINS FLEMING*

"THE Development of Construction under the London Building Acts," a history by H. G. Castleman of London building legislation from the Great Fire of 1666 to the Act of 1930, may be found in the March 1938 issue of *The Structural Engineer* (London), Vol. XVI, p. 111. A similar history of London building laws from those of Fitz-Ailwin, the Lord Mayor, in 1189 to December 1934 is given by H. Berry, "New Building Laws for London," in *The Municipal Journal* (London), issue of January 11, 1935, Vol. 44, p. 57. Mr. Berry says that the Act of 1667, which was the outcome of the

Great Fire, is the true ancestor of all subsequent legislation. It may here be stated that Henry Berry, who will be quoted more than once, is chairman of the London County Council Town Planning and Building Regulation Committee. He has taken a prominent part in London building legislation.

The Act is entitled, "An Act to consolidate the enactments relating to streets and buildings in London." The Act was inelastic. A "Code of Practice" was issued in 1932 as the basis for consideration for those seeking relief from certain of its provisions.

The "London Building Act (Amendment Act), 1935" replaced the 1930 Act. H. Berry, "New Building Laws for London," in *The Municipal Journal* of August 23, 1935, p. 1501, comments on it: "The Bill of which the new Act is the outcome, was one of modest dimensions, consisting of fifteen clauses and a schedule, but its effect, as far as London is concerned, is of quite a revolutionary nature, albeit beneficent. Instead of having to proceed by the difficult and hazardous method of amendment by an Act of Parliament, it will be possible in the future to issue—and if necessary, alter—by-laws."

"By-laws for the construction and conversion of buildings and furnace chimney shafts, made by the London County Council in pursuance of the London Building Act (Amendment) Act, 1935," became effective January 1, 1938. Directly under the heading are the words: "Attention is drawn to the Council's power of modification or waiver under Section 9 of the Act." This "power of waiver" is hard to understand by an engineer not acquainted with British practice. Parts of a paper, "Building Regulations" by C. Roland Woods, Barrister-at-Law, published in *The Structural Engineer* of November 1933 are here pertinent. Mr. Woods writes:

"It is essential, however, in any detailed examination of the subject to remember that

The successful plans of the San Francisco architects were made to integrate work space with living space. Each design has a large room combining living and dining space. Kitchen, laundry and canning space is planned near the center of family living. Bedrooms and a bathroom are provided in each home for the owner and his wife and his son and daughter. Other space in the productive area of the home is planned for sewing, weaving and a workshop. Shelter is designed with each home for a car, chickens, a cow and feed storage space. Carefully devised landscape plans call for gardens and orchards on the land surrounding the houses.

The judges were Frederick L. Ackerman of the New York City Housing Authority; Baker Brownell, head of the Department of Contemporary Thought, Northwestern University; Mrs. Eloise Davison of the New York Herald-Tribune Home Institute; Burnham Hoyt, architect, Denver, Colorado, and former Professor of Architecture, New York University; the Rt. Rev. Msgr. Luigi G. Ligutti, president of the National Catholic Rural Life Conference; Richard J. Neutra of Los Angeles, and Antonin Raymond of New York and Tokyo.

* With American Bridge Company, New York N. Y.

building in England and Wales is governed in four different ways, as follows:

1. By General Acts of Parliament, such as the Public Health Acts.
2. By local Acts of Parliament, such as the London Building Act.
3. By Subordinate Legislation.
4. By discretionary power under which waivers may be granted from by-laws or regulations or Acts in Existence."

The 159 By-laws of 1938, after a page of definitions (By-law 1), are divided into nine "Parts," as follows: I. Loading; II. Materials of Construction; III. Foundations and Sites of Buildings and Excavations Adjacent Thereto; IV. Walls and Piers; V. The Use of Structural Steel; VI. The Use of Reinforced Concrete; VII. The Construction of Chimney Shafts; VIII. Miscellaneous; IX. General.

A paragraph from a periodical in distant Calcutta is so to the point that it will be quoted: "The general by-laws cover the whole range of building construction, except timber, which is covered by the timber by-laws. In addition, a code of practice for arc welding acts as a guide for this method of construction. The difference between a code of practice and by-laws is that the latter have the force of law, whereas the former acts as a guide to applicants for "waiver," and also as a guide to the Council in granting a waiver. The steel code was first issued under similar conditions, and, its value having been proved in actual working, it has been embodied and modified in the by-laws. It is intended that after experience has been gained with the arc welding code, the same procedure shall take place with that also."* An Act of Parliament can be changed only by another Act. By-laws to suit new conditions that may arise can be altered or revised much more speedily.

A distinctive feature of the 1938 By-laws is the oft-repeated words, "to the satisfaction of the district surveyor." In an American code such a provision would be a cause of delay and at times a subject for controversy. Building officials of different cities have different opin-

ions. In the same city they are constantly being changed and the official at one time may not think on matters referred to him the same as his predecessor. The writer once had a marked experience along this line. Another distinctive feature is that references are made to appropriate British Standard Specifications and not reprinted in the text. It would be a convenience to those interested if these references were brought together and reprinted in a single volume which could be made an integral part of the code. This is done by the Pacific Coast building officials with their Uniform Building Code and its accompanying volume, "Specification Documents."

Under "Loading" it is observed that the superimposed loading specified for slabs is usually greater than that for beams. For rooms used for residential purposes it is 50 lb. per sq. ft. of floor area for slabs and 40 lb. for beams; for office floors above the entrance floor, 80 lb. for slabs and 40 lb. for beams; for the entrance floor, 80 lb. for both slabs and beams. For workshops and factories, "Loading to be provided for to be ascertained to the satisfaction of the district surveyor," but it is not to be less than 150 lb. per sq. ft. for slabs and 120 lb. for beams. For warehouses, book stores, stationery stores and the like, with the same proviso, the minimum load is 200 lb. per sq. ft. for both slabs and beams. Minimum superimposed loads are specified for individual slabs and beams. For all floors used as offices an addition of 20 lb. per sq. ft. must be made for internal partitions. A unique requirement is that for wind pressure on roofs inclined at an angle of more than 20 degrees. A pressure of 15 lb. per sq. ft. acting normal to the surface is to be assumed on the windward side and 10 lb. per sq. ft. of surface "acting separately and not simultaneously outwards on the leeward side." For construction other than for the roof the wind pressure acting vertically from the roof is to be assumed at 10 lb. per sq. ft. of covered area. Provision is to be made for a horizontal wind pressure of 15 lb. per sq. ft. (with certain exceptions) on the upper two-thirds of the building surface.

"Piling shall be to the satisfaction of the dis-

*The Calcutta Municipal Gazette, March 19, 1938, p. 642. "London's New Building Code," H. Berry.

trict surveyor." The intensity of pressure upon earth "shall not exceed that allowed by the district surveyor." Bearing values for different soils are given in a footnote but "only as a general guide." Elaborate rules are given for determining the thickness of walls. Allowable pressures on walls and piers of both brick and concrete are given in tables.

The basic unit working stress for structural steel that is made to comply with British Standard Specifications is 8 tons (one ton=2240 lb.) per sq. in. of net section in tension. For axial stress of shop rivets it is 5 tons and for field rivets, hot-driven and parts in close contact before riveting, it is 4 tons per sq. in. For the net section of bolts meeting certain requirements it is also 5 tons per sq. in. For the compression flange of beams laterally secured 8 tons per sq. in. is allowed. On the gross section of webs the maximum allowable shear is 5 tons per sq. in.; for bolts and rivets it varies from 4 tons for black bolts to 6 tons for shop rivets and turned bolts of driving fit. For bolts and rivets in bearing the allowable values are double those for shear. No column formula is given. The allowable load for shafts of columns and other compression members in tons per sq. in. is given in a table for ratios of effective column length to least radius of gyration, l/r , varying by 10, from 20 to 200. For an l/r of 20 the value given is 7.2; for an l/r of 150 it is 2.0; for an l/r of 160 it is 1.8 and for an l/r of 200 it is 1.2. The ratio of "effective" column length to actual length for different conditions of end restraint is also tabulated. Working unit stresses due to wind pressure may with certain limitations be increased $33\frac{1}{3}$ per cent.

Tables are given for permissible compression, bending, shear and bond stress in reinforced concrete columns. For tension in steel reinforcement 18,000 lb. per sq. in. is allowed, except for the helical reinforcement of a col-

umn where 13,500 is allowed. The modular ratio is taken at 15.

Among miscellaneous requirements it is noted that the height of every room (measured from floor to ceiling) "used for the purpose of an office or for habitation" shall be at least eight feet in the topmost story and not less than eight feet six inches in the stories below. It is also required that every such room "shall be provided with one or more windows directly opening into the open air." The superficial area of these windows must be equal to one-tenth of the area of the floor and one-half of the window surface must be arranged to be opened.

BATH ROOM MODERNIZATION

(Concluded from Page 45)

in plain colors or printed designs, and window curtains and shades to match; a tiny outlet for electric razor or curling iron built into the side of the medicine cabinet; a combination recessed soap dish and grab bar. This latter is built into the wall above the tub, and serves as a small safety bar in getting in and out of the tub. The soap container has a removable glass dish. L-shaped metal grab bars firmly anchored to the wall are a convenience to shower bathers, and minimize the danger of slipping while soaping the body.

Many new fabrics for shower curtains and wall materials of various compositions have been perfected and are on the market. These are non-absorbent, attractive in modern designs, and are very inexpensive.

Medicine cabinets in the modern vogue give the bathroom a well-groomed look. These should be spacious and well-lighted. Tubular lights are used in many of the modern medicine cabinets; and may be integral with the cabinet, or attached to the wall separately.

FEDERAL SUPPORT OF BUILDING PROGRAM

THE national defense program may redirect activity from one section of the construction industry to another, according to William Stanley Parker of Boston, chairman of the Committee on Industrial Relations of the American Institute of Architects.

"It would be highly unfortunate if any sudden deflation in Federally financed construction activity occurred," says Mr. Parker, who is in agreement with the views recently expressed by Marriner C. Eccles, chairman of the board of governors of the Federal Reserve System. "The future stability of our total national income will largely depend on the steadiness with which our public expenditures are administered. The Federal policy may well be a flexible one, increasing or decreasing moderately in counter relation to the fluctuations of private enterprise.

"Municipalities should adopt a policy of steady or stabilized expenditures which is consistent with their permitted method of financing and their statutory debt limitations. Such a policy, recently proposed by the Massachusetts State Planning Board, constitutes a new element in public spending plans."

The year 1939 should be more active in the building field than 1938, Mr. Parker feels. "Subsequent years should continue to improve if public officials adopt wise policies in the development of public expenditures and if private enterprises can to some extent base their policies on the community of interest rather than on separate individual pocket nerves. There appears to be less reason to assume that private enterprises can do this than that public officials can play their part effectively in the total economy. It is worth hoping for, however.

"Last year, the effect of the new Federal program had a definite tendency to provide employment for architects. The separate contracts are fairly substantial in their amount, but they will benefit a very small percentage of the profession. The benefit will be gratefully received even if there be a little grousing over the extra routine burdens involved in Public Works Administration procedure.

"Architects may reasonably complain in those cases where the Public Works Administration regional officers make it practically necessary to eliminate from their specifications the standard American Institute of Architects General Conditions. These conditions have been developed over a period of more than twenty years, five editions gradually developing a perfected form. Their elimination, where insisted upon, throws away all

the benefits of this long experience, making the work of architects and builders more difficult and uncertain. The sole gain is some questionable simplification of the work of the regional officers. The net result is a distinct loss and an unreasonable burden on the construction industry."

Industry relations in the small house field may be importantly affected by the decision of the Institute to develop a program of national cooperation, involving architects, material producers, and loaning agencies, for the purpose of improving the character of design, construction, and finance of small houses, Mr. Parker adds. "In no field of construction is cooperation to this end more to be desired," he asserts.

"Large scale rental housing, privately financed, is one year nearer than it was a year ago. Just how near it actually is remains to be seen. The Metropolitan Life Insurance Company is blazing the new trail which the Buhl Foundation started at Chatham Village a few years ago with encouraging results. A real estate operator recently was heard to express interest in this type of operation providing the underlying market conditions become somewhat more favorable. He naturally agreed that the crux of the problem lay in securing the equity financing.

"Last year also saw the final approval by insurance underwriters of a new form of fire insurance for buildings in the course of construction proposed by the Institute and the Associated General Contractors of America. This form permits coverage by a single policy taken out at the commencement of the work and based upon the completed value with a properly adjusted premium. It eliminates the routine burden and the risk involved in the older monthly reporting form, and represents a distinct advance. The new form is now available in New England, New Jersey, the District of Columbia, Pennsylvania, Delaware, Maryland, and the State of New York."

EARTHQUAKE CATALOG

The Seismological Society of America has issued as Volume 29, Number 1 of its Bulletin, a "Descriptive Catalog of Earthquakes of the Pacific Coast of the United States 1769 to 1928." This is a book of 297 pages and contains in it all records available. It contains reprints with revisions of the old Holden catalog and the McAdie catalog. It is available from the Secretary, Seismological Society of America, Bacon Hall, Berkeley, California, at a price of \$2.00.

With the Architects

UNIVERSITY AWARDS

The following awards in the Department of Architecture, University of Washington, were made at the recent close of the academic year: The Gold Medal of the A.I.A., with copy of Henry Adams' "Mont San Michel and Chartres," to George W. Hazen, who was also pledged to the scholastic honorary society of Phi Beta Kappa. Mr. Hazen holds a scholarship for advanced work in Architecture at the Massachusetts Institute of Technology; the Alpha Rho Chi medal for leadership and service, awarded to Delmar S. Mitchell who was also the recipient of the American Institute of Architects second award, a copy of "Mont San Michel and Chartres."

SOCIETY OF ARCHITECTURAL DRAFTSMEN

The Society of Architectural Draftsmen of Los Angeles has elected the following officers: Arthur E. Mann, president, 826 South Catalina, Los Angeles; Lonie Garten, vice-president; Arthur Rendon, secretary; Edward Frick, treasurer; Harry Hall, advisor; Glenn Balch, advisor. The Advisory Committee from the State Association of California Architects for the Architectural Draftsmen are George B. Allison, Gordon B. Kaufmann and Sylvanus B. Marston.

WILL PRACTICE AT SANTA MARIA

Paul O. Davis, formerly associated with Earl T. Heitschmidt and Charles O. Matcham, Los Angeles, has moved to Santa Maria where he becomes associated with Louis N. Crawford, architect of that city. The firm name will be Crawford and Davis, associated architects, No. 8 Gibson-Drexler Building.

EXHIBITS CHURCH WORK

Mounted photographs of Baptist churches in the Pacific Northwest, designed by Frederick V. Lockman of Seattle, were recently exhibited at the national convention of the American Baptist Home Missionary Society in Los Angeles.

PORTLAND ARCHITECT HONORED

Frederick Aandahl, prominent Portland architect, has been named a member of the Oregon State Board of Architectural Examiners, to succeed the late John E. Tourtellotte. The appointment was made by Governor Sprague.

FORM PARTNERSHIP

Walter L. Reichardt and Paul Robinson Hunter announce their association and the opening of an office for the general practice of architecture at 706 Architects Building Fifth and Figueroa Streets, Los Angeles.

PERSONAL

H. Guthrie Thursby, formerly at 425 Wilshire Boulevard, Santa Monica, is now located in the Lincoln Building, Santa Monica.

Sidney B. Hayslip, architect, of Portland, has moved from the Broadway-Oak Building to the Postal Building, 510 S. W. Third Street, Portland.

C. B. Freeman, architect, has established offices in the Postal Building, Portland, Oregon.

Ivan W. Meyer has resumed the practice of architecture with an office in the Fourth Avenue Building, Seattle, Wash.

Donald J. Stewart, architect, of Vancouver, B.C., has recently moved into new offices in the Central Building, Vancouver.

John B. Hessemer has joined the staff of Jones and Stanley, Seattle architects.

BEACH HOUSES

Designs for a series of beach houses to cost approximately \$2000 have been made by students of the College of Architecture and Fine Arts at the University of Southern California and more recently on display at the University in Los Angeles. Planned for week-end visits, the bungalow is laid out on a lot 40x100 ft. and designed for outdoor living, featuring plenty of air and sunshine and barbecue parties in sheltered nooks. When the sketches were completed the students combined them to make a unique community with a lagoon as the central theme.

SPOKANE SOCIETY ELECTS OFFICERS

At a postponed annual meeting, Spokane Society of Architects elected officers for the ensuing year. Henry C. Bertelsen, who has served as vice-president, was made president to succeed Noel E. Thompson. Kenneth Stormont was elected vice-president. Mr. Stormont is a graduate of the State College. Albert Harvey Funk was elected secretary-treasurer to succeed the late Roland M. Vantyne.

PIONEER FIRM CHANGES NAME

The firm of Bebb and Jones succeeds to the long established firm of Bebb and Gould, the latter firm having been dissolved following the death of Mr. Gould. John Paul Jones, Mr. Bebb's new associate, served more than 20 years with the original Seattle firm.

TACOMA ARCHITECTS TRAVEL

Members of the Tacoma Branch of the Washington State Chapter of Architects, held an enjoyable tour to McChord Field, Fort Lewis and the Narrows Bridge June 24. C. T. Pearson was in charge of the party.

SOUTHERN CALIFORNIA CHAPTER

Proposed amendments to the Chapter by-laws were voted by Southern California Chapter, American Institute of Architects, at its regular monthly meeting, June 13. Two of the amendments were affirmed, while the others failed to receive the required two-thirds majority.

Hopeful of a suitable solution of the Los Angeles Civic Center problem, Sumner Spaulding, chairman of the committee appointed to that activity, outlined conditions in the Civic Center as they are at present and said that there is a way to bring the buildings into proper balance. He stated that the city and county officials apparently are now ready to listen to what the architects have to say on this subject. Serving with Mr. Spaulding on the committee are Myron Hunt, John C. Austin, William Schuchardt and Ralph Flewelling.

Donald Kirby, chairman of the Chapter's publicity committee, reported that radio station K.M.P.C., Beverly Hills, would devote one-half hour each Monday evening, from 9:30 to 10:00 o'clock, to a round-table discussion of building. Questions will be answered and representatives of all branches of the industry will be invited to participate. The first discussion, held on June 12, was attended by Mr. Kirby, Captain Bingham of the Federal Housing Authority, and Earl Anderson of the Los Angeles Chamber of Commerce.

John Byers, new associate member, and Keith Marston, new junior associate member, were introduced by Eugene Weston, Jr., who presided at the meeting.

The regular July meeting was held on July 11 at the Barney Oldfield ranch.

OREGON CHAPTER

The regular June meeting of Oregon Chapter was held Tuesday, June 20, at Lloyd's clubhouse.

Before dinner a preview was given of a few excellent sketches by the last Ion Lewis Fellow, Ed. Hicks. A show will be held later in the summer.

Mr. Crowell reopened the question of Code revisions and asked for definite instructions as to the course to be pursued. After considerable discussion it was motioned by Morin, seconded by Brookman, that with the advent of a new commissioner of favorable disposition "this Chapter pass a resolution petitioning the City Council that a sufficient sum of money be appropriated in the near future to have all Portland City Codes bearing upon building construction rewritten, simplified and brought up to date by qualified persons." **The motion was put to vote and killed!**

The secretary was reproved for not making inquiry into Cleveland Chapter's action, as instructed at the January meeting. Reinstucted!

A new Associate member, Van Evera Bailey, was introduced.

New Ion Lewis Fellow, George Kotchik, felicitated. Took a bow for himself and co-fellow, Rollin Boles.

New State Board of Examiners' member, Aandahl, congratulated.

President Stanton spoke of the Executive Committee's correspondence relative to preservation of the old hotel at Jefferson. WPA Administrator Griffith has assured the Chapter that this venerable landmark will not be despoiled.

A letter from Northern California Chapter, asking the Chapter to serve as co-hosts for Architects' Day (October 11th) at the Golden Gate Exposition was read. It was moved by Dukehart, seconded by Brookman, that the invitation be accepted. Voted and ordered, the four Convention delegates to return by way of San Francisco and attend.

Secretary announced that Day W. Hilborn of Vancouver, Wn. had been admitted to Institute membership, assigned to Washington State Chapter because of geographical boundaries, but to attend our meetings as an unassigned member, to participate in local affairs. The secretary was instructed to write letter of felicitation.

President Stanton announced that with concurrence of the Executive Committee he had nominated Aimee Gorham as an Honorary Associate of this Chapter.

The Convention delegates were named as follows: Messrs. Stanton, Belluschi, Morin and Aandahl. The alternates are Messrs. Crowell, Brookman, Schneider and Kennedy.—R. M.

WASHINGTON STATE CHAPTER

The regular monthly meeting for May, held on the evening of May 4th, at the College Club, Seattle, was largely attended and after a preliminary exchange of greetings adjournment was made to the large dining room where a bountiful dinner was enjoyed. Music was contributed by a swing quartet from Roosevelt High School. The special guest, Guy Ardilouze from Paris, Delano and Aldrich Travelling Scholar, was introduced by President Naramore.

William Aitken being called upon for some remarks, made a fluent address descriptive of some of the good qualities of a member of the Chapter whose identity eventually was disclosed as C. H. Alden. Later during the dinner, another eloquent member, Harlan Thomas, was called upon and contributed to the eulogy by extended fictitious remarks not only with reference to Mr. Alden but to the latter's illustrious ancestor.

A letter was read from Mr. Munier, speaker at the last Chapter meeting, expressing appreciation and gratitude to the Chapter for the hospitality and kindness extended and from the School of Design in Chicago enclosing a Bulletin of Summer Courses.

Mr. Jacobsen, Chairman of the Committee on Civic Design and Planning, on being asked to report on the Pacific Northwest Regional Planning Conference re-

cently held at the Olympic Hotel, Seattle, mentioned the valuable opportunity for contact with those actively engaged in regional planning work in various parts of the country. Several Chapter members were found to have been in attendance. Harlan Thomas, Director of the School of Architecture at the University, reported on the work now being done there to provide instruction in City and Regional Planning through co-operative efforts of the University Schools of Architecture, Engineering and Social Science.

Mr. McClelland suggested that some provision be made for a school for new members and associates in the Chapter and it was voted that such a school be conducted by a committee with Mr. McClelland as chairman. Mr. Holmes made an interesting report on the New York Exposition with particular reference to the State of Washington Building and Vic Jones added interesting comments on both the New York and the San Francisco Expositions as a result of his visits.

ION LEWIS SCHOLARSHIP WINNERS

George C. Kotchik and Rollin H. Boles, Portland, have been awarded the 1939 Ion Lewis travelling scholarships. They departed for Europe July 1, where they will visit England, France, the Scandinavian countries, Germany and Italy.

The scholarship fund was established by Architect Ion Lewis, of the Portland firm of Whidden & Lewis, in 1930, prior to his death. Winners of travelling scholarships must be students or graduates of the University of Oregon Department of Architecture. Messrs. Kotchik and Boles are junior members of the Oregon Chapter, A.I.A. Mr. Kotchik is employed by Lawrence, Holford & Allyn, while Mr. Boles is employed by Architect A. Glenn Stanton. Both graduated from the University of Oregon in 1937.

Awards are made annually by the managing committee composed of Hollis Johnston, Dean Ellis F. Lawrence, secretary, and A. Glenn Stanton, chairman.

LANGLEY SCHOLARSHIP AWARDS FOR 1939

The Edward Langley Scholarships of the A.I.A. are annual awards made to qualified architectural draftsmen, architects, graduate students of architectural schools and teachers of architecture, in the United States or Canada, for study, research, or travel. Each award is accompanied by a grant consistent with the need and purpose of the recipient, insofar as the funds in hand permit.

This year forty-six applications for the scholarships were received. Thirty of the applicants were architectural draftsmen and architects. Their applications were received by the Regional Directors, who nominated nine draftsmen and two of the architects for the consideration of the Board Committee in charge of the awards. Sixteen of the applicants were graduate students and teachers of architecture.

From the eleven nominees of the Regional Directors

and the sixteen student and teacher applicants the Board Committee selected eight to whom they awarded scholarships.

Seven of the ten regional districts of the Institute were represented in the awards.

Of the eight recipients, five are architectural draftsmen, one is an architect, one is a teacher, and one a graduate student.

The Edward Langley scholarships were established in 1936, and since that time twenty-five awards have been made.

The 1939 awards are as follows:

Addison Erdman, Tarrytown, N. Y.; Martin S. Kermacy, Philadelphia, Pa.; Maynard Wm. Meyer, Pewaukee, Wis.; Charles A. Pearson, Jr., Bluefield, W. Va.; Earl William Pellerin, Detroit, Mich.; Donald P. Stevens, Denver, Colo.; James E. B. Walker, Providence, R. I.; Arthur Richard Williams, Normal, Ill.

SOUTHERN CALIFORNIA ENGINEERS

A sound motion picture showing the Golden Gate Bridge, was the outstanding feature of the 117th meeting of the Structural Engineers Association of Southern California June 7, President John E. Shield presiding.

Professor R. R. Martel of the California Institute of Technology introduced his undergraduate students who had been invited to attend as guests of the Association.

Professor D. M. Wilson of University of Southern California was called on to introduce himself and those senior engineers of U. S. C., who had also been invited to attend as guests of the Association.

President Shield started an innovation by asking each individual present to introduce the man on his left. It might be added that this method of introduction brought forth some impromptu and highly appreciated comedy.

Low Conant, one of the new Associate Members, presented an interesting paper on his new bending moment model, designed to read, "Bending Moments on All Types of Structures, Directly."

John Mendenhall, another new associate member, followed Mr. Conant's address, by presenting an illustrated talk on "Mountain Climbing as Practiced by the Sierra Club."

A. S. C. E. CONVENTION

Plans are well advanced for the 69th Annual A. S. C. E. convention to be held in San Francisco July 26-29. The program committee hopes to make this one of the outstanding conventions ever held by the Society. An excellent program has been prepared. With the added attraction of the San Francisco Exposition, success of the meeting seems assured.

George W. Pracy is general chairman of arrangements.

The events will include a dinner-dance July 26; ladies' tea and bus ride; dinner and entertainment at Treasure Island July 27, and structural and highway trip July 28, and a sanitary engineers' trip the same day.

W. MARBURY SOMERVELL

W. Marbury Somervell, formerly a prominent Seattle architect, active member of the A.I.A. and of the Washington State Chapter, passed away on April 2, at Cannes, France.

Mr. Somervell settled in 1904 as the representative of Heins and LaFarge of New York, the architects of St. James Cathedral in Seattle. At the conclusion of this project he practiced in Seattle under the firm name of Somervell and Cote, later practicing independently in Seattle, and in Vancouver under the firm name of Somervell and Putnam. Mr. Somervell, with Mr. Cote or independently, was the architect of many notable buildings in Seattle, among them the Providence, Minor and Orthopedic Hospitals, the Perry Hotel now the Columbus Hospital, the Henry Memorial Chapel at the Highlands, and many fine residences. His firm was also Associate Architects of the Alaska Yukon Pacific Exposition held in Seattle in 1909.

In 1918, Mr. Somervell left Seattle to serve in the army in the World War. His war service was in France as Major of Engineers and he was later assigned to the Chemical Warfare Service. He remained in France for a time after the war in the endeavor to promote reconstruction projects and later, returning to this country, practiced architecture in Los Angeles in association with his former partner, Mr. Putnam. He afterwards retired to devote himself to other forms of art, notably etching, in which he was particularly successful, and soon returned to France where he spent the remainder of his life.

JULIUS A. ZITTEL

Last month the dean of Spokane architects, Julius A. Zittel, passed away. Mr. Zittel was born in Germany, coming to the United States when he was thirteen. He studied architecture in Chicago and came to Spokane in 1887, entering the practice with Mr. Pruesse. After 1910 he carried on under his own name, designing many buildings in the Inland Empire.

He was an officer in the Washington State Society for many years.

In 1932 he closed his office and took over active management of the Spokane Hotel. His architectural library was donated to the Department of Architectural Engineering at the State College at that time.

EARL A. ROBERTS

Earl A. Roberts, architect of Seattle, passed away May 28 after a prolonged illness.

Mr. Roberts studied architecture at Mark Hopkins Institute, now known as the California School of Fine Arts, and resided in San Francisco for several years before going to Seattle 23 years ago. Among the outstanding buildings he designed are the Benjamin Frank-

lin Hotel, Commodore Apartments, Ambassador Apartments, Malloy Manor Apartments, Duchess Apartments in Seattle, and the Seattle Testing Station.

Surviving are his son, Donald, who was associated with him in the Lloyd Building.

INTERNATIONAL CONGRESS

The Fifteenth International Congress of Architects will be held in Washington, from September 24 to 30 in conjunction with the annual convention of the American Institute of Architects, September 25 to 28.

Certain fundamentals affect the meetings of these two bodies. The Institute has its usual business to transact, which must have the attention of the delegates, and yet the delegates will all want to attend the sessions of the Congress.

The real business of the Congress is the discussion of the subjects or themes that have been assigned by the permanent managing committee, which is known internationally as the "Comite' Permanent International des Architectes," a title commonly abbreviated to the C.P.I.A. It will be of interest to understand established Congress procedure.

These themes or subjects have been sent to the architects of all countries, in order to make it possible for those having particular interest in any one or perhaps all of them to send in written discussions of them. It is, of course, hoped that many American architects will send in such papers which may be written in any one of the five official languages, namely, English, French, German, Italian or Spanish. Upon their receipt, they are translated into English and given to a designated party for reading. It is his duty to review these papers, and at the beginning of the session to present his review.

After the presentation of this review, actual discussion of the Theme will be opened by a speaker from abroad, an international authority on the subject in question.

STRUCTURAL ENGINEERS' PICNIC

McNear's Beach in "Marvelous Marin County" was again the scene of an enjoyable outing by members and friends of the Structural Engineers Association of Northern California, June 24. Besides plenty to eat and drink, the picnickers played golf, tennis, baseball, tug-o'-war, swam in the ocean, fished, and told stories, some of which, by Bill Adrian, would never get by the censor. Members who took an active part in the success of the sixth annual outing included, besides Adrian, L. H. Nishkian, Bill Thomas, Gus Saph, Henry Powers, Harold Engle, Bill Tait, Pete Anderson, Haydite Charlie Lindgren, Milo Farwell, Phil Baker, Dave Robertson, Jess Rosenwald, Carl Schmidts, Van Rosen-dahl, Jim Mackie and George Washington.

ARCHITECTS' BULLETIN

Issued For

THE STATE ASSOCIATION OF CALIFORNIA ARCHITECTS

Northern Section

STATE ASSOCIATION MEMBER
OF THE
AMERICAN INSTITUTE OF ARCHITECTS

Editor

Harris C. Allen

Address all communications for publication in the Bulletin to the Editor (Harris C. Allen) 557 Market Street, Room 218, San Francisco, California.

Board of Control

Harris C. Allen Otto G. Hintermann
Harry Michelsen Wayne S. Hertzka

State Association Officers

President..... Sylvanus B. Marston, Pasadena
Vice-President..... Gwynn Officer, Berkeley
Secretary..... Wayne S. Hertzka, San Francisco
Treasurer..... Robert H. Orr, Los Angeles

Regional Director, A. I. A.

Albert J. Evers, San Francisco

Delegate Regional Director, Southern

California

Gordon B. Kaufmann, Los Angeles

Executive Board—Northern Section

Officers

President..... Gwynn Officer, Berkeley
Vice-Pres.... Ernest E. Weihe, San Francisco
Secretary.... Wayne S. Hertzka, San Francisco
Treasurer... Otto G. Hintermann, San Francisco

Directors

Harry J. Devine R. H. Reimers
Wm. J. Merchant Harold Weeks

Executive Board—Southern Section

Officers

President..... Sylvanus B. Marston
Vice-President..... Louis N. Crawford
Secretary..... Winsor Soule
Treasurer..... Robert H. Orr

Directors

Merrill W. Baird Abe Edelman
Harold C. Chambers George D. Riddle

Advisors—Northern Section

Harris C. Allen *San Francisco*
J. K. Ballantine, Jr. *(Secretary)*
Sam. Lightner Hymen
Wm. G. Merchant
Jas. F. McGuiness
Dodge A. Riedy
Harold H. Weeks
Ernest E. Weihe
Albert R. Williams
Fred. H. Reimers *(President)*
C. A. Caulkins *North Bay District*
Peter Sala *Lower San Joaquin District*
J. U. Cloudsley *(Secretary)*
Edw. W. Kress *Santa Clara Valley*
Mario Corbett *San Mateo*
Alden Cambell *Sacramento*
Ernest J. Kump *Upper San Joaquin*
Dole F. Thomsen *Palo Alto*
Norman W. Sexton *Marin*
Geo. P. Simonds *East Bay*
Chester Treichel *East Bay*
Gwynn Officer *Berkeley*
F. T. Georgeson *Redwood Empire*
Casebolt Dakin *Upper Sacramento*
Ralph Taylor *Lassen District*

Architectural Practice Act Unchanged

A THOROUGHLY disgruntled Senate, tired with working night and day, without pay in an overtime session, which was the longest on record, and obsessed with battles over Administration measures, made short work of professional Bills, including the Architectural Practice Act, which latter, although with a "Do-pass" recommendation from the Senate committee, and with no open legitimate opposition, was voted down about two to one.

We are back where we started, with the old Act due to be codified without change, and the State Board of Architectural Examiners minus the added authority they thought needed for proper enforcement of the Act. We have spent time and money, and have gained a little more experience.

The lesson that may be derived is a conviction of the futility of trying to convince individual legislators of the importance and necessity of professional regulation. Future activities should be directed to localized publicity and information, to the end that local constituents advise their representatives that their welfare requires such regulation.

It is a long, hard road; but it appears to be the only way to the "Promised Land."

Having passed the affiliation requirements for one delegate—one for the first 300; two for 300 to 500; and three for over 500 members in good standing—the State Association of California Architects is entitled to two delegates to the Institute Convention this year. It will be held in Washington, D. C., September 25 to 28, and will be synchronized with the Fifteenth International Congress of Architects, convening September 24 to 30.

Three themes are scheduled for discussion in the Congress: Town Planning, Technical Comparisons of Contemporary to Past Architecture, and Professional Aspects of Governmental Architectural Practice. A trip to Williamsburg, Va., follows, with a grand finale for Architects' Day at the New York World's Fair, set for October 2.

On account of the dates set for the above activities, the 1939 Convention of the State Association will be held later in the month of October than usual. The Executive Board has set October 26, 27 and 28, for the official days, in Santa Barbara at a time and place to be announced later.

As customary, a word is due at this time to remind Districts and present District Advisors that elections should be held not later than August 15, to conform with the Constitution and By-laws. With the desirability (as suggested above) that local bodies—Chambers of Commerce, Real Estate Boards, Civic Clubs, all local organizations of citizens—be informed and

convinced that professional regulation is for public welfare, and that the State Act should be strengthened to that end, District Advisors will have a definite objective for next year. They should be chosen with this work in mind.

DRAFTSMEN'S DINNER The dinner meeting of the California Society of Architectural Draftsmen (embracing draftswomen) at Veneto's restaurant on June 8 was a WOW. Eleven architects joined with the sixty or so active pencil-pushers in an intake and outflow of spirits that proved we are Brothers and Sisters under the skin, and the skin is not so thick if you go by skinfulls.

Two genial officers of the Society (James Stamos and Griffyd Partridge) presided in turn as Masters of Ceremonies, aided and abetted by the bright and beautiful Betty Boyter, than whom as a stringpuller (if not a skinfuller) there is none than whomer. All the architects were called on to speak their pieces, starting with Mark Daniels who took, as his text, the old-time Guild relationships and we didn't think Mark was as old as all that but it seems he has a grown son who practically bosses him around his own office, so it's no wonder Mark gets a bit discouraged at times (but you should see him other times). Then they played a game of "Information Please," and bombarded individuals—calling them out by name—with questions relating to architecture, and we regret to say the architects chosen did not prove their rights to a Certificate any too well but if some of these questions were put to you, the answers might not be so warm and indeed many of them had to be referred to Funk and Wagnalls.

Well, anyway, it was a grand evening and the first annual dinner of the Society set a swell standard for goodwill and good time.

(Correction—Harry Michelsen says a good draftsman does not push a pencil—he pulls it. Draftsmen ought to have a pull.)

THAT SMALL HOUSE PROBLEM

(By a member of the A. I. A.)

To suggest to a group of architects that there is a small house problem immediately produces widely conflicting opinions regarding its solution. That this is a real problem is fully recognized. We have the problem—have had it for many years—and to date nearly every one else is attempting a solution in some energetic fashion, according to his own selfish lights.

Architectural pens and others have written reams of material on this subject, but it is all quite varied in concept and tremendously diversified in its solution. A general criticism of most plans proposed is that they are too complicated to succeed. Simple measures augmented by some sane thinking can accomplish wonders.

The problem of the small house, as it confronts the architect, is not what to do about it, but frankly, how to get into the market the small house offers. Estimates

indicate that about 85 per cent of all residential building receives no architectural service. This is a high percentage, if true. This field is now being served by stock plan services, as well as by many other individual plan services prepared by unprofessional interests.

We are not now, and never have been, in the small house field to any extent as a profession. To say that others who have ideas of their own on this subject are in competition with us is a weak attempt to satisfy our ego. We are confronted with a far greater need for homes today than ever before. This is not news. People, individually and collectively, are doing something about it and are profiting by it.

The interest of architects as professional men in the small house field has been primarily to criticize what everybody else is doing. They do not offer any constructive plan or remedy toward its solution. The only professional effort that I know of to attempt to materially influence this situation nationally was the program of the Architects Small House Service Bureau whose ideals were set for them by the American Institute of Architects, which eventually excommunicated it at the Milwaukee Convention in 1935.

Following the Milwaukee episode, it was decided that small local groups of architects should be formed and be allowed to attack the problem on a modified service basis. As a result, we have plans of varying types now in operation in such cities as Buffalo, Washington, D.C., Boston, Indianapolis, Memphis, Detroit, and a number of other places. What success and popular acceptance they may obtain will be reflected directly by the number of detached dwelling units completed. To date, nothing spectacular has been reported and it is almost a safe conclusion that nothing will be reported. This is a natural situation because the architect profits less than others, particularly the building material and equipment industry.

I seriously question whether the architects as a profession really know to what extent other interests, particularly the lumber and cement industries, are entrenched in the promotion of the small house. A bird's eye view quickly reveals not only these industries, but also the various other groups of building material manufacturers, as well as publishers of various magazines and newspapers, state agricultural colleges, builders and general contractors, some real estate interests and a host of individuals, each exploiting its own product or interest. To this add the newer agencies—the various government housing bureaus.

From the above groups there come today many diversified plan services sponsored or supported by their respective interests. These varied interests found it necessary to establish and maintain these services as "selling tools" in their merchandising programs. The important thing about this is that these services, promoted and merchandised by their local dealers are so thoroughly entrenched and so popularly accepted by the public that the question of an architect goes un-

(Turn to Page 70)

REALTY DEALERS DISCUSS BUILDING CONDITIONS

A "BLUEPRINT PREVIEW," of a building revival featured the recent convention in Oakland of the California Real Estate Association.

Curiously, one of the major foundations for hope is quite afield from the direct business of selling real property and erecting homes and office buildings. "There are," pointed out State Secretary Willaman, "several basic indicators of real estate activity.

"First, there is the general housing shortage resulting from depression-period curtailment in building. New houses are needed.

"Second, of the millions of Exposition year tourists drawn to our State this summer, thousands unquestionably will remain here.

"Third, the valuable advertising programs of Californians, Inc., the All-Year Club of Southern California, the Golden Gate Exposition, the Sacramento Centennial, the California State Fair, and other organizations this year has been augmented by a most powerful ally—and that ally is the economy bloc of our 1939 Legislature!

"By holding governmental spending within reason and rejecting new tax proposals, the legislators are extending the hand of welcome to investors and industrialists who wish to enter the rich California field but have been restrained in the past by fear of constantly rising tax levies.

"Every new factory means far more than just a new manufacturing plant. It means new payrolls, new homes, new apartment houses. And so those factors combined—a sane tax program—local, State and National—a housing need, and a record tourist influx, give encouragement to every man engaged in the real estate business in California."

State Secretary Willaman's forecast of continued home-building activity in California appears to have a sound foundation—and all Californians will hope that the results will justify the glowing prospectus of his "blueprint preview"!

The Federal Housing Administration

One of the convention speakers was D. C. McGinness, District Director, Federal Housing Administration of Northern California, who said among other things: "Let's strike a balance, then, and see what the F.H.A. does for our economic life as a whole.

"For the builder it furnishes credit on the most favorable terms ever obtainable and provides a market for his product.

"For our home seekers it brings home-ownership within the reach of thousands of our citizens who would have never known its blessings.

"For lending institutions it provides an insured and profitable outlet for credit which had almost become

frozen and stagnant. It assures them of liquidity, or liquefaction, a condition infinitely more wholesome and satisfactory than that of putrefaction, after the orgies and indulgences of ten years ago under the practices of the old system of mortgage lending. If this system of mortgage lending has been revolutionized, let it be added that, and more important, it has been humanized. It has provided a broad and safe outlet for their dammed-up store of resources, reclassified their paper, making it as safe and far more profitable than government bonds.

"For the building industry it has produced three billion dollars in primary construction, to say nothing of the untold and fabulous amounts spent otherwise. For the country at large it has permitted hundreds of thousands of our citizens to own carefully designed and better built homes at a purchase price and on terms they can afford."

The following paragraphs are from an address by Herbert U. Nelson, Chicago, Executive Vice-President of the National Association of Real Estate Boards:

Important Amendments to F.H.A.

"Residential activity and construction for 1939 promises to exceed that of 1938, and, with F.H.A. legislation definitely settled, builders and developers can carry on with plans they have been holding in abeyance.

"The extensions and changes which our Association felt essential have been included in the amendments. F.H.A. is now in a position to go full steam ahead.

"Realtors of the country, by arousing public realization of the need of extending important F. H. A. provisions that would otherwise have died on July 1, have performed an important public service that is having national recognition.

"In brief, here are the high points included in the new law:"

1. The gross amount of permissible mortgage insurance under the Act is increased from three billion to four billion dollars at the discretion of the President.

2. Mortgage insurance on existing construction is limited to 25 per cent of the total amount of principal obligations to which insurance may be granted after July 1, 1939. After July 1, 1941, no further mortgage insurance will be granted on existing construction unless it has previously been covered by a mortgage insured by the Administrator.

3. The right to insure 90 per cent mortgages having a maturity not to exceed 25 years on new small owner-occupied houses having a total value of \$6,000 or less is made a permanent part of the law and is not subject to any fixed date of expiration.

4. Title I is extended for two years to July 1, 1941. Loans may not exceed \$2,500. Loans for modernization may not have a maturity in excess of three years and thirty-two days. Loans for new small dwellings up to \$2,500 may be insured if they bear such interest and have such maturity as may be prescribed by the Administrator. A premium charge not in excess of three-fourths of 1 per cent is provided for.

5. Mortgages on large-scale projects insurable under Section 207 may be granted 80 per cent mortgage insurance based on the value found by the Administrator as of the date of application for insurance. In no case, however, may the amount of mortgage exceed the cost of the completed physical improvements on the property or project. The Administrator's estimate of the cost of physical improvements is to be exclusive of public utilities and streets; taxes, interest and insurance during construction; organization and legal expenses and miscellaneous charges during or incidental to construction. Mortgages insured under Section 207 cannot bear interest in excess of 4 1/2 per cent.

6. Section 210 of the National Housing Act covering certain types of multiple dwellings is repealed.

7. In the case of large-scale projects insured under Section 207, the Administrator is required to obtain from the principal contractor a certification that laborers and mechanics employed in construction have been paid not less than the wages prevailing in the locality for work of a similar nature as determined by the Secretary of Labor.

Reconditioning Old Homes

"Merchandising of Old Homes" was the subject of an instructive address by O. A. Osmundsen, President of Highland Realty Company, Oakland. He said, in part:

"Homes are bought because of their livability, adaptable to the purchaser's wants and desires.

"The majority of old homes, when reconditioned, are better home values than the present new homes.

- (a) Because of location.
- (b) Seasoned timber.
- (c) Spacious and roomy, with homelike atmosphere.

"Reconditioning old homes is an art and a study. The amount to be spent must be governed by—

- (a) Value of home when reconditioned to equal market value of the average home of equal size on the street.
- (b) Size of home relative to the demand.
- (c) Type of buyer you desire to appeal to.
- (d) Neighborhood established.

"Illustration—An average three-bedroom bungalow of fifteen years, located on a street where the average newer three-bedroom home has a market value of \$7,250 and in a bungalow district.

"In planning to recondition this home to appeal to a young family, the question arises, 'Where to begin?'

"First, say this old home has a market value in its present status of \$5,000, and when it is modernized and put in perfect condition, it will have a market value equal to the newer average bungalow. Approximately \$1,000 should be spent on reconditioning it. How and where shall we spend this \$1,000? Because every home is bought for its livability as adapted to the purchaser, one should begin on the interior.

"Break these expenditures as follows:

Roof	\$ 65.00
Plumber	125.00
Tile	65.00
Plaster	35.00
Shades	25.00
Kitchen linoleum	35.00
Miscellaneous	20.00
Carpenter	160.00
Electrician	60.00
Cement	15.00
Paint	325.00
Floors	20.00
Garden	50.00
Total.....	\$1,000.00

"Now we have an old home modernized into a new life to itself, the community, and the purchaser, and a better investment than the average new one. It cost our client \$6,000 finished, sold for \$6,950 less selling commission of \$350, leaving a net profit to client of \$600. You can readily see that if you would do this for your client only three times a year with the same money you have made 30 per cent profit for him, besides you have made two commissions on each transaction, or namely six commissions.

"Merchandising old homes in this manner is profitable, and there is a great opportunity to you as brokers, for you will not only render a service to your clients and to the community, but also to your bank account."

Importance of Slum Clearance

"What Slum Clearance Means to the Realtor and Taxpayer," was the subject of a paper by Walter Fowler of the San Pedro Realty Board.

"We brokers and property owners are all well aware of the rising tide of taxes and any proposition that contemplates the exemption of 65 per cent of the wage-earning people from taxes on real property certainly is a proposition of such tremendous consequences that it is hard to believe that it has ever been seriously contemplated, but still that is the fact.

"It is apparent that the only reason that there has not been a movement against this (slum clearance) proposition is because the people in general are ignorant of the provisions of same, and the fact that no project under the housing authority has been completed, therefore, no one has felt the effects of same. It is illuminating to know that any place that this has been brought to a vote of the people it has been

(Turn to Page 63)

Estimator's Guide

Giving Cost of Building Materials, Wage Scale, Etc.

Amounts given are figuring prices and are made up from average quotations furnished by material houses to San Francisco contractors. 3% Sales Tax on all materials but not labor.

All prices and wages quoted are for San Francisco and the Bay District. There may be slight fluctuation of prices in the interior and southern part of the state. Freight cartage, at least, must be added in figuring country work.

Bond—1/2% amount of contract.

Brickwork—

Common \$40 to \$45 per 1000 laid, (according to class of work).
 Face, \$100 to \$110 per 1000 laid, (according to class of work).
 Brick Steps, using pressed brick, \$1.25 lin. ft.
 Brick Veneer on frame buildings, \$.75 sq. ft.
 Common f.o.b. cars, \$14.00 et yard. Cartage extra.
 Face, f.o.b. cars, \$45.00 to \$50.00 per 1000, carload lots.

HOLLOW TILE FIREPROOFING (f.o.b. job)

3x12x12 in. \$ 84.00 per M
 4x12x12 in. 94.50 per M
 6x12x12 in. 126.00 per M
 8x12x12 in. 225.00 per M

HOLLOW BUILDING TILE (f.o.b. job)

carload lots.
 8x12x5/2 \$ 94.50
 6x12x5/2 73.50

Building Paper—

1 ply per 1000 ft. roll \$3.50
 2 ply per 1000 ft. roll 5.00
 3 ply per 1000 ft. roll 6.25
 Brownskin, 500 ft. roll 4.50
 Brownskin, Pro-tect-o-mat, 1000 ft. roll 9.00
 Sisalraft, 500 ft. roll 5.00
 5ash cord com. No. 7 \$1.20 per 100 ft.
 5ash cord com. No. 8 1.50 per 100 ft.
 5ash cord spot No. 7 1.90 per 100 ft.
 5ash cord spot No. 8 2.25 per 100 ft.
 5ash weights cast iron, \$50.00 ton.
 Nails, \$3.50 base.
 5ash weights, \$45 per ton.

Concrete Aggregates—

Gravel (all sizes) \$1.45 per ton at bunker; delivered to any point in S. F. County \$1.85.
 Bunker Delivered
 Top sand \$1.45 \$1.85
 Concrete mix 1.45 1.85
 Crushed rock, 1/4 to 3/4 1.60 2.00
 Crushed rock, 3/4 to 1 1/2 1.60 2.00
 Roofing gravel 1.60 2.00
 City gravel 1.45 1.85
 River sand 1.40 1.80
 Delivered bank sand—\$1.00 per cubic yard at bunker or delivered.

SAND— Bunker Delivered
 River sand \$1.40 \$1.80
 Lapis (Nos. 2 & 4) 2.00 2.40
 Olympia Nos. 1 & 2 1.80 2.20
 Heidelberg plaster sand \$1.80 and \$2.20
 Del Monte white 50c per sack

CEMENT (all brands, cloth sacks) \$2.72 per bbl. f.o.b. car; deliv. \$2.90 per bbl., carload lots; less than carload lots, warehouse or delivered, 80c per sack. (Less 10c per sack returned, 2% 10th Prox.)

Common cement (all brands, paper sacks) carload lots \$2.52 per bbl. f.o.b. car; delivered, \$2.70; less than carloads delivered, 75c per sack. Discount on cloth sacks, 10c per sack. Cash discount on carload lots, 10c a barrel, 10th Prox.; cash discount less than carload lots, 2%.

Atlas White } 1 to 100 sacks, \$1.50 sack,
 Colveras White } warehouse or delivery; over 100
 Medusa White } sacks, \$1.25; 2% discount 10th
 of month.

Forms, Labors average \$40.00 per M.
 Average cost of concrete in place, exclusive of forms, 35c per cu. ft.; with forms, 60c.
 4-inch concrete basement floor 12/2c to 14c per sq. ft.
 Rat-proofing 7/2c
 Concrete Steps \$1.25 per lin. ft.

Dampproofing and Waterproofing—

Two-coat work, 20c per yard.
 Membrane waterproofing—4 layers of saturated felt, \$4.50 per square.
 Hot coating work, \$1.80 per square.
 Medusa Waterproofing, 15c per lb., San Francisco Warehouse.
 Tricoel waterproofing.
 (See representative.)

Electric Wiring—\$12.00 to \$15.00 per outlet for conduit work (including switches).
 Knob and tube average \$3.50 per outlet.

Elevators—

Prices vary according to capacity, speed and type. Consult elevator companies.
 Average cost of installing an automatic elevator in four-story building, \$2800; direct automatic, about \$2700.

Excavation—

Send, 60 cents; clay or shale \$1 per yard.
 Teams, \$12.00 per day.
 Trucks, \$22 to \$27.50 per day.
 Above figures are an average without water. Steam shovel work in large quantities, less; hard material, such as rock, will run considerably more.

Fire Escapes—

Ten-foot galvanized iron balcony, with stairs, \$115 installed on new buildings; \$140 on old buildings.

Floors—

Composition Floors—22c to 40c per sq. ft. In large quantities, 16c per sq. ft. laid.
Mosaic Floors—80c per sq. ft.
Dureflex Floor—23c to 30c sq. ft.
Rubber Tile—50c to 75c per sq. ft.
Terazzo Floors—45c to 60c per sq. ft.
Terazzo Steps—\$1.60 lin. ft.

Hardwood Flooring (delivered to building)—

	1 1/2" x 2 1/4"	3/8" x 2"	3/4" x 2"
	T&G	T&G	S&G Ed.
Clr. Qtd. Oak	\$141.00 M	\$109.00 M	\$133.50 M
Sel. Qtd. Oak	118.00 M	97.00 M	106.50 M
Clr. Pla. Oak	117.00 M	101.00 M	107.50 M
Sel. Pla. Oak	97.00 M	90.00 M	99.00 M
Clr. Maple	120.00 M	94.50 M	

Wage—Floor layers, \$10.00.
 Note—Above quotations are all board measure except last column which is sq. ft.

Glass (consult with manufacturers)—

Double strength window glass, 20c per square foot.
 Plate 75c per square foot (unglazed) in place, \$1.00.
 Art, \$1.00 up per square foot.
 Wire (for skylights), 40c per sq. foot.
 Obscure glass, 30c square foot.
 Glass bricks, \$2.40 per sq. ft., in place.
 Note—If not stipulated add extra for setting.

Heating—

Average, \$1.90 per sq. ft. of radiation, according to conditions.
 Warm air (gravity) average \$40 per register.
 Forced air, average \$60 per register.

Iron—Cost of ornamental iron, cast iron, etc., depends on designs.

Lumber (prices delivered to bldg. site).

No. 1 common \$29.00 per M
 No. 2 common 27.00 per M
 Select O. P. common 34.00 per M
 2x4 No. 3 form lumber 24.00 per M
 1x4 No. 2 flooring VG 55.00 per M
 1x4 No. 3 flooring VG 47.00 per M
 1x6 No. 2 flooring VG 60.00 per M
 1x4x4 and 6, No. 2 flooring 60.00 per M

Slash grain—

1x4 No. 2 flooring \$43.00 per M
 1x4 No. 3 flooring 40.00 per M
 No. 1 common run T. & C. 30.00 per M
 Lath 5.25 per M

Shingles (add cartage to price quoted):
 Redwood, No. 1 \$1.10 per bdle.
 Redwood, No. 290 per bdle.
 Red Cedar 1.10 per bdle.

Plywood—Douglas Fir (ad cartage)—

"Plyscord" sheathing (unsanded)
 5/16" 3-ply and 48"x96" \$32.50 per M
 "Plywall" (wallboard grade)—
 1/2" 3-ply 48"x96" \$35.00 per M
 "Plyform" (concrete form grade)—
 5/8" 5-ply 48"x96" \$100.00 per M
 Exterior Plywood Siding—
 7/16" 5-ply Fir \$90.00 per M
 Redwood \$100.00 per M

Millwork—Standard.

O. P. \$85.00 per 1000. R. W., \$90.00 per 1000 (delivered).
 Double hung box window frames, average with trim, \$6.50 and up, each.
 Doors, including trim (single panel, 1 3/4 in. Oregon pine) \$8.00 and up, each.
 Doors, including trim (five panel, 1 3/8 in. Oregon pine) \$6.00 each.
 Screen doors, \$3.50 each.
 Patent screen windows, 25c a sq. ft.
 Cases for kitchen pantries seven ft. high per lineal ft., \$8.00 each.
 Dining room cases, \$8.00 per lineal foot Rough and finish about 75c per sq. ft.
 Labor—Rough carpentry, warehouse heavy framing (average), \$17.50 per M.
 For smaller work average, \$35.00 to \$45.00 per 1000.

Marble—(See Dealers)

Painting—

Two-coat work	per yard	42c
Three-coat work	per yard	60c
Cold water painting	per yard	10c
Whitewashing	per yard	4c
Turpentine, 65c per gal., in 5 gal. cans, and 55c per gal. in drums.		
Raw Linseed Oil—86c gal. in bbls.		
Boiled Linseed Oil—89c gal. in bbls.		
Medusa Portland Cement Paint, 20c per lb.		

White Lead in oil

	Per Lb.	
1 ton lots, 100 lbs. net weight	11 1/4c	
500 lbs. and less than 1 ton	11 1/2c	
Less than 500 lb. lots	12c	

Red Lead and Litharge

1 ton lots, 100 lbs. net weight	11 1/4c
500 lbs. and less than 1 ton	11 1/2c
Less than 500 lb. lots	12c

Red Lead in oil

1 ton lots, 100 lbs. net weight	11c
500 lbs. and less than 1 ton	11 1/4c
Less than 500 lb. lots	12 1/4c

Note—Accessibility and conditions cause some variance in costs.

Patent Chimneys—

6-inch	\$1.25 lineal foot
8-inch	1.75 lineal foot
10-inch	2.25 lineal foot
12-inch	3.00 lineal foot

Plastering—Interior—

1 coat, brown mortar only, wood lath	Yard	\$0.60
2 coats, lime mortar hard finish, wood lath		.70
2 coats, hard wall plaster, wood lath		.72
3 coats, metal lath and plaster		1.25
Keene cement on metal lath		1.10
Ceilings with 3/4 hot roll channels metal lath (leath only)		1.10
Ceilings with 3/4 hot roll channels metal lath plastered		1.85
Single partition 3/4 channel lath 1 side (leath only)		.85

Single partition 3/4 channel lath 2 inches thick plastered	\$2.90
4-inch double partition 3/4 channel lath 2 sides (leath only)	1.70
4-inch double partition 3/4 channel lath 2 sides plastered	3.80
Thermax single partition; 1/4 channels; 2 1/4 overall partition width. Plastered both sides	2.50
Thermax double partition; 1 1/2 channels; 2 1/4 overall partition width. Plastered both sides	3.10
3 coats over 1" Thermax nailed to one side wood studs or joists	1.25
3 coats over 1" Thermax suspended to one side wood studs with spring sound isolation clip	1.40

Plastering—Exterior—

2 coats cement finish, brick or concrete wall	1.50
3 coats cement finish, No. 18 gauge wire mesh	1.00
Wood lath, \$7.50 to \$8.00 per 1000.	
2.5-lb. metal lath (dipped)	.17
2.5-lb. metal lath (galvanized)	.20
3-lb. metal lath (dipped)	.27
3-lb. metal lath (galvanized)	.28
3/4-inch hot roll channels, \$72 per ton.	
Finish plaster, \$18.90 ton; in paper sacks.	
Dealer's commission, \$1.00 off above quotations. \$13.85 (rebate 10c sack).	
Lime, f.o.b. warehouse, \$2.25 bbl.; cars, \$2.15 lime, bulk (ton 2000 lbs.), \$16.00 ton.	
Wall Board 5 ply, \$50.00 per M.	
Hydrate Lime, \$19.50 ton.	
Plasterers Wage Scale	\$1.67 per hour
Lathers Wage Scale	1.50 per hour
Hood Carriers Wage Scale	1.25 per hour
Composition Stucco—\$1.80 to \$2.00 sq. yard (applied).	

Plumbing—

From \$70.00 per fixture up, according to grade, quantity and runs.

Roofing—

"Standard" tar and gravel, \$6.50 per sq. for 30 sqs. or over.	
Less than 30 sqs. \$7.00 per sq.	
Tile, \$20.00 to \$35.00 per square.	
Redwood Shingles, \$7.50 per square in place.	
Copper, \$16.50 to \$18.00 per sq. in place.	
Cedar Shingles, \$8.00 per sq. in place.	
Reccoat, with Gravel, \$3.00 per sq.	
Asbestos Shingles, \$15 to \$25 per sq. laid.	

Slate, from \$25.00 per sq., according to color and thickness.	
Shakes—1x25" resawn	\$11.50 per sq
1/2x25" resawn	10.50 per sq
1/2x25" tapered	10.00 per sq

Above prices are for shakes in place.

Sheet Metal—

Windows—Metal, \$1.75 a sq. foot.
Fire doors (average), including hardware \$1.75 per sq. ft.

Sightlights—(not glazed)

Copper, 90c sq. ft. (flat).
Galvanized iron, 30c sq. ft. (flat).
Vented hip sightlights 60c sq. ft.

Steel—Structural

\$120 ton (erected), this quotation is an average for comparatively small quantities. Light truss work higher. Plain beams and column work in large quantities \$90 to \$100 per ton.

Steel Reinforcing—

\$80.00 to \$120.00 per ton, set.

Stones—

Granite, average, \$6.50 cu. foot in place.
Sandstone, average Blue, \$4.00. Boise \$3.00 sq. ft. in place.
Indiana Limestone, \$2.80 per sq. ft. in place.

Store Fronts—

Copper sash bars for store fronts, corner center and around sides, will average 75c per lineal foot.
Note—Consult with agents.

Tile—Floor, Wainscot, etc.— (See Dealers)

Asphalt Tile—18c to 28c per sq. ft. installed.

Wall Tile—

glazed terra cotta Wall Units (single faced) laid in place—approximate prices:	
2 x 6 x 12	\$1.00 sq. ft.
4 x 6 x 12	1.15 sq. ft.
2 x 8 x 16	1.10 sq. ft.
4 x 8 x 16	1.30 sq. ft.

Venetian Blinds—

40c per square foot and up. Installation extra.

THE BUILDERS' EXCHANGE OF SAN FRANCISCO STANDARD WAGE SCALE

For mechanics employed on construction work in the Bay Region. Effective September 1, 1937

CRAFT	Journeymen Mechanics
Asbestos Workers	\$ 8.00
Bricklayers (6h-5d)	10.50
Bricklayers' Hodcarriers (6h-5d)	6.75
Cabinet Workers (Outside) (5d)	8.00
Caisson Workers (Open)	6.40
Carpenters (8h-5d)	10.00
Cement Finishers (8h-5d)	10.00
Cork Insulation Workers (8h-5d)	9.00
Electric Workers (8h-5d)	11.00
Electrical Fixture Hangers	8.00
Elevator Constructors	10.40
Engineers, Portable & Hoisting	9.00
Glass Workers (8h-5d)	9.60
Hardwood Floormen	9.00
Housesmiths, Architectural Iron (Shop) (8h-5d)	9.00
Housesmiths, Architectural Iron (Outside) (8h-5d)	10.00
Housesmiths, Reinforced Concrete or Rodmen (8h-5d)	10.00
Iron Workers (Bridge and Structural) Including Engineers (8h-5d)	12.00

CRAFT	Journeymen Mechanics
Laborers, Building (8h-5d)	\$ 6.00
Laborers, Common (8h-5d)	6.00
Lathers, Channel Iron (6h-5d)	9.00
Lathers, All Others	9.00
Marble Setters (8h-5d)	10.50
Marble Setters' Helpers (8h-5d)	6.50
Millwrights	9.00
Model Makers (\$1.50 per hr-6h)	9.00
Modelers (\$2 per hr-6h)	12.00
Model Casters	7.20
Mosaic and Terrazzo Workers (Outside)	9.00
Painters (7h-5d)	8.75
Painters, Varnishers and Polishers (Outside)	9.00
Pile Drivers and Wharf Builders	9.00
File Drivers' Engineers	10.00
Plasterers (6h-5d)	10.00
Plasterers' Hodcarriers (6h-5d)	7.50
Plumbers (8h-5d)	11.00
Roofers, Composition (8h-5d)	9.00
Roofers, All Others (8h-5d)	8.00
Sheet Metal Workers (8h-5d)	10.00
Sprinkler Fitters	10.00

CRAFT	Journeymen Mechanics
Steam Fitters (8h-5d)	\$11.00
Stair Builders (8h-5d)	9.00
Stone Carriers, Soft and Granite (8h-5d)	8.00
Stone Setters, Soft and Granite	12.00
Stone Derricksmen	9.00
Tile Setters (8h-5d)	11.00
Tile Setters' Helpers (8h-5d)	6.50
Tile, Cork and Rubber (8h-5d)	9.00
Welders, Structural Steel Frame on Buildings	11.00
Welders, All Others on Buildings	9.00
Dump Truck Drivers, 2 yards or less	6.00
Dump Truck Drivers, 3 yards	7.00
Dump Truck Drivers, 4 yards	7.00
Dump Truck Drivers, 5 yards	7.00
Dump Truck Drivers, 6 yards	7.50
Truck Drivers of Concrete Mixer Trucks:	
2 yards or less	6.50
3 yards	7.50
4 yards	7.50
5 yards	7.50
6 yards	8.00

GENERAL WORKING CONDITIONS

- Eight hours shall constitute a day's work for all crafts except as otherwise noted.
- Plasterers' Hodcarriers, Bricklayers' Hodcarriers, Roofers' Laborers, and Engineers, Portable and Hoisting, shall start 15 minutes before other workmen, both at morning and at noon.
- Five days, consisting of not more than eight hours a day, on Monday to Friday inclusive, shall constitute a week's work.
- Transportation costs in excess of twenty-five cents each way shall be paid by the contractor.
- Overtime shall be paid as follows: For the first four hours after the first eight hours, time and one-half. All time thereafter shall be paid double time. Saturdays (except Laborers), Sundays and holidays, from 12 midnight of the preceding day, shall be paid double time.
- On Saturday, Laborers shall be paid straight time for an eight-hour day.
- Where two shifts are worked in any twenty-four hours, shift time shall be straight time. Where three shifts are worked, eight hour's pay shall be paid for seven hours on the second and third shifts, allowing one-half hour for lunch.
- All work, except as noted in paragraph 9, shall be performed between the hours of 8 a.m. and 5 p.m.
- In emergencies, or where premises cannot be vacated until the close of business, men then reporting for work shall work at straight time. Any work performed on such jobs after midnight shall be paid time and one-half up to four hours of overtime and double time thereafter, provided, that if a new crew is employed on Saturdays, Sundays or holidays which has not worked during the five preceding days, such crew shall be paid time and one-half.
- Recognized holidays to be: New Year's Day, Decoration Day, Fourth of July, Labor Day, Admission Day, Thanksgiving Day, Christmas Day.
- Men ordered to report for work, for whom no employment is provided, shall be entitled to two hours' pay.

HOUSING EXPERT SAYS HOME OWNERSHIP IS A MYTH—

HOME ownership is a myth, Dr. Robert W. Kelso, President of the Citizens Housing and Planning Council of Detroit, declared in an address on "The Social Need for Better Housing" at the Great Lakes and Illinois-Wisconsin Regional Meeting of the American Institute of Architects, in session at the University of Notre Dame.

"Public men and other leaders still talk of it as being necessary to the salvation of empires just as presidents and monarchs still talk of large families and still urge the couple on a thousand a year to have ten children," said Dr. Kelso, who is director of the Curriculum in Social Work of the Horace H. Rackham School of Graduate Studies at the University of Michigan.

"If the American public were less prone to be satisfied with the credistic morality of ages gone by and more inclined to think of the real, hard, cold facts of living in this present day, we would add to those wise commandments against theft, covetousness, and adultery a decree that thou shalt not as a people permit the human family to live in squalor.

"We have lived together in new America long enough to realize that the welfare of the individual citizen and home dweller is inextricably bound up with and dependent upon the common well being. We may

REALTY DEALERS DISCUSS BUILDING

(Concluded from Page 60)

turned down by large majorities, and some states and municipalities have turned the project down entirely. The further fact that the housing authority is building for sixty years in the future with the rapid changes which occur these days and that the fact that they are binding our children and our grandchildren to contracts which they might not care to fulfill, it seems futile, and further, because of the promises made by the governing bodies that our national income is to be raised to such an extent that in a few years there will be no poverty, therefore, tax-exempt and profitless competition with private business will not be necessary.

"I believe that the most dangerous aspects of this whole thing is the fact that if they endeavor to build enough of these rentals to take care of enough people to really do any housing good (for instance, the head of the Los Angeles County Authority made the statement that there are three hundred thousand families alone in Los Angeles County who would qualify) that the cost is prohibitive and the tax exemption and subsidies are ruinous; and if they only build enough to take care of a few, the damage is done by the threat to private builders, who will be afraid to go ahead and it will implant the false hope in all of the families in and around that price class who have not been fortunate enough to have been housed in these tax-exempt and profitless rentals, and will create a wave of discontent throughout the whole United States."

develop our laws on crime and upon the police power in the protection of the public health to a high degree of perfection, but we shall never get at the causes which drive the individual into anti-social conduct until we shall have done something that is constructive and preventative in the matter of the home conditions under which grown-ups have to live and in which children are to be born and brought up.

"Today home ownership is only an ideal, and for a good and increasing reason. That reason is the mobility of labor coupled with the uncertainty of income. The American laborer is almost nomadic in the sense that he must follow the job wherever it leads him. The average stay of an executive, working as most of us work for a national corporation, is said to be about two years in any one place. The average for the laborer is a matter of months.

"Home ownership is declining rapidly toward the vanishing point; and the lower cost housing in the future is housing for tenancy only and needs to be thought of in its construction, its financing, and its maintenance on a rent-house basis.

"We have no practice in this country of setting up a minimum standard in housing and requiring that no residence shall be allowed to fall below it. Poor families cannot buy new houses. They can seldom rent them. They are supposed to live in wasted areas, abandoned by their former occupants who have been able to move to something better. In this present year of grace decent homes available to low income families are practically non-existent.

"The social results of sub-standard living are an ugly story. Of course it is not the whole cause of disease, of delinquency, of family wreckage, of illegitimacy or even of city filth; but when these conditions are found invariably attendant upon sub-standard housing in wasted city areas, a reasoning man comes naturally to the conclusion that the two are closely related and that if by setting our national house in order we could reduce the sub-standard condition, we might by the same token reduce the social evils that go with it.

"Human tragedy, social wreckage, and civic loss are involved in slum conditions. A blighted residential area is always one of declining values and of tax delinquency, and the slums of a city are its most expensive luxury.

"So absolutely parallel are the lines of sub-standard housing and of social ill-being that there is no known exception to the results. The story is best illustrated by a spot map. Try this experiment for instance: Take an outline map of your city and insert a black-headed pin at every point from which a case of tuberculosis was reported to the board of health last year. Take another outline map just like the first and stick a red pin into every spot in which a juvenile delinquent was located. Take now a third map and spot every police

call; a fourth map showing every fire call, and finally a fifth map showing tax delinquency.

"Now line these finished maps up side by side on the wall. You will be surprised to find that you have a forest of these various colored pins all in the same parts of the city. And you will be still more surprised perhaps to discover that in sticking these pins in the maps you have carefully and accurately outlined the slum areas of your city. If you could take a composite photograph of all five it would show one single map of solid pins covering the sub-standard areas. There would be no blurred margins.

"There are those who say that the slum is a natural attendant of city life and they point to the fact that sinks of this kind have existed in all the cities of the world since the beginning of aggregate dwelling. This is, of course, true in the same way that it is true that dogs still have fleas and that mankind from the dawn of recollection to the present moment has always had lice. The fallacy in both instances lies in the assumption that since it has been there it must always be.

"Just as man has always been until lately a surface crawling creature, unable to fly, so it may well be that in the less obvious world of endless change man may cease to be the inchoate accidental dweller in milling mobs and become the inhabitant of cities organized and maintained reasonably upon the basis of knowledge that already exists concerning human needs as to health, safety, decency, convenience, and the beauty and amenity of his surroundings."

Positive coordinating action by the people of the United States is required to bring anything like order out of the existing housing chaos, Dr. Kelso asserted.

"The dweller himself cannot remove the sub-standard conditions in which he lives," he continued. "If he had the understanding and could get his fellows together he has not the means with which to do anything about it. A careful study of 1934 revealed the fact that somewhere in the neighborhood of 52 per cent of the city dwelling families of the United States were receiving less than \$1,000 a year total income.

"The situation can be very little better today and something like 10,000,000 workers have no job. Government is supporting them with direct and work relief and is struggling to find them housing—not standard housing by the way—but just housing at \$20 a month or less.

"At the other side of the picture the same governments are taking thousands upon thousands of properties for delinquent taxes. In Michigan they are getting set to sell these properties back to the land speculators who deal in them, and who, for the most part, allowed their taxes to become delinquent, at a very small fraction of a fairly low assessed valuation. When this result is accomplished we may expect the old lot-selling racket to start all over again. That is to say, we are still thinking normally and naturally in terms of property and vested interests. We are overlooking the common welfare."



*A service for you
...and your clients*

As the national leader in FHA financing, Bank of America's interest in better housing coincides with that of the architect and the engineer. Finer design and better construction mean a sounder investment for the home owner, a more satisfactory loan for the bank. Your interests, as well as those of your clients, will receive the friendliest consideration at Bank of America.

Bank of America
NATIONAL TRUST AND SAVINGS ASSOCIATION
Member Federal Deposit Insurance Corporation

BAXCO

CHROMATED ZINC CHLORIDE

PCZC

PRESSURE TREATED LUMBER
● **PROTECTS AGAINST DECAY**
AND TERMITE ATTACK

*Specify it in your home
Available through Lumber Dealers*

LOS ANGELES
601 W. 5th Street
Phone Michigan 6294

SAN FRANCISCO
333 Montgomery Street
Phone DOuglas 3883

J. H. Baxter & Co.

AGENTS FOR WEST COAST WOOD PRESERVING CO. SEATTLE, WASH.

MODERNIZED PRODUCTS

Brief Notes on New Materials and Equipment in the Building Industry.

240. LIGHTING FIXTURES

Chase Commercial Lighting Fixtures Catalog No. 13, is the title of a well prepared booklet on an important phase of modern commercial buildings—proper lighting fixtures. The Chase Brass and Copper Company have anticipated the need for such equipment and their new catalog covers this field. Send for your copy—use the coupon.

241. USES OF LEAD

Lead Industries Association have issued their July booklet which has some interesting data on the New York Exposition and the uses of lead in gasoline stations and for protecting submarine cables.

242. TERMITE PROTECTION

The J. H. Baxter Company have put out a booklet entitled, "It's Good Business to Build Your Home of Wood—" It describes the Baxter method of protecting wood against the inroads of termites, and other destructive elements. Send for a copy.

243. HOTEL PLUMBING

Another booklet by Crane Company illustrating new sanitary equipment for hotels and apartment hotels. These Crane booklets are always interesting and are intelligently compiled. This particular booklet is right up to the Crane standard.

244. NICKEL

"Inco" the magazine-booklet issued by The International Nickel Company, Vol. 16, No. 3, is worthy of special mention. It contains material of vital interest and is well illustrated. The contents covers a wide range of subject matter where the use of nickel is an important factor. The coupon will bring a ready response.

245. "SEALAIR" WINDOWS

The Kawneer Company have a new brochure which illustrates "Sealair Windows"—all-aluminum or bronze. The illustrations depict the various

types of residences and buildings to which these windows are particularly adaptable. Send for a copy.

246. COPPER AND BRASS

The Copper and Brass Research Association has dedicated its Bulletin for June to the New York Exposition and it carries some remarkable illustrations, and text devoted to description. Use the coupon.

247. ROOF GARDENS

The Celotex Corporation has a new booklet illustrating the manner of utilizing roof space. This is a most illuminating booklet for it has practical ideas that will enable anyone with roof space to create a garden or lounging place for sunny days. The coupon will bring you a copy; just clip and send it in.

248. NUTS TO YOU

Another little folder on anchorages for bolts, nuts, and screws by the Rawlplug Company. Some interesting facts illustrated here for the asking.

249. USEFUL TABLE

The International Nickel Company offers a table showing the Hardness Conversion ratio for nickel alloy steels. Made of celluloid and pocket size.

250. RUBBER CABLE

A booklet devoted to a detailed description of rubber insulated power cable has been recently put out by the Anaconda Copper Company. Contains tables of the standards for copper cables, and all the facts needed to present a complete and comprehensive picture of this type of electrical equipment.

251. FIRE RETARDENT

Another Celotex Corporation publication—an illustrated booklet on "Thermax" structural insulating slabs for fire resistive interiors. This should prove of interest to the home builder and to the profession at large. Send for your copy.

252. MONEL METAL

Monel metal is depicted in its many uses and applications throughout the nation in a brochure called the "Silver Kitchen" issued by The International Nickel Company. Use of Monel metal in the average American home is shown in detail.

253. BOOK OF FACTS

The Flexrock Company have issued a compact and interesting book named "Hand Book of Building Maintenance" and containing much useful and purposeful information. Send for your copy by using the coupon.

FREE FOR THE ASKING

Check items on coupon, paste on letter head or postal card, and mail to Architect and Engineer.

|
| Architect and Engineer
| 68 Post Street
| San Francisco, Calif.
|
| Please send me literature on the following
| items as checked below. This request
| places me under no obligation.
|
| 240 247
| 241 248
| 242 249
| 243 250
| 244 251
| 245 252
| 246 253
|
| My Name.....
|
| Name of Company.....
|
| Street.....
|
| City State.....

*Modern Homes are
Air-Conditioned by*

SELECTAIR

● DESIGNED and built by the S. T. Johnson Co., pioneer manufacturers of Oil Burners, this smart new air-conditioner combines in one compact unit every feature desired by home-owners, architects and engineers for economical heating, air-conditioning and ventilating the modern home. Year-round hot water. Forced air circulation for summer. Equipped with the popular BANKHEAT Pressure-Type Burner. Furnished in enamel with chrome trim.

Send for "Selectair" Bulletin & complete specifications

S. T. JOHNSON CO.

Oil Burners

940 Arlington Avenue, Oakland, California
401 Broad Street, Philadelphia, Pa.

● THERE'S A JOHNSON OIL BURNER FOR EVERY PURPOSE

COUNTRY HOME MODELS

Designs and models of country homes, art schools, and "ideal" tourist camps are on view at the eightieth annual exhibition of the New York Cooper Union Art Schools which is remaining open during the summer for World's Fair visitors.

Country homes for suburban New York feature a "living room in the garden." These homes, which can be constructed for approximately \$7,000, make use of a wide expanse of window space, usually concentrated on the side of the living room fronting on gardens and lawns to create an impression of "oneness" between the interior and outdoor surroundings.

One of the exhibits is a bungalow finished in white stucco comprising a large combination living room and dining room, which occupies more than half the floor space, a bedroom, kitchen and bath. A "bunching" effect has been avoided in designing the home, which is rectangular, by placing a white trellis in the garden and a wall of brown fieldstone around the building plot.

The end of the living room fronting on the garden and trellis is entirely glass-enclosed, while another side of the room is partly walled in by a fireplace and chimney of brown fieldstone. The remainder of this side and the section of the wall opposite the glass-enclosed end are opened up by window space extending halfway from the ceiling to the floor.

Another model, labeled "Artist's Retreat for Arizona" also emphasizes the use of glass in the sidewalls, and, in addition, introduces a novel arrangement of planning wherein the bedroom is a separate unit and connected with the rest of the house by a covered passageway similar to a porch. The combination living room and dining room is encircled on two sides by a glass screen fronting on a spacious lawn and garden.

All of the homes, according to Esmond Shaw, assistant art director of the Art Schools, have been conceived and planned by the students with a view to "happier living," minimum construction costs and architectural beauty.

A model of a "dream" art school, seven stories high and 70 per cent glass, is exhibited by Helmut Riehl of 65 Montrose Avenue, South Orange, N. J., and Wolfgang Kassner of 1082 Tinton Avenue, New York. The model, which weighs 130 pounds, is built on a scale of three-sixteenths of an inch to one foot and boasts a hidden built-in radio to add "mystery and glamour to the school" and an auditorium and stage lighted by a three-color, alternating, automatic lighting arrangement.

All sections of the model, which rests on a platform approximately four by four and one-half feet, are visible to the eye because of the open T-shaped construction, the use of glass between all floors, and a clever lighting system. A swimming pool, gymnasium and lockers are provided in the basement and a restaurant and recreation plot for the use of faculty and students is located on the roof. The first floor is reserved for administra-

A good investment—

is a well designed, well built,
structure, properly located.

Lindgren & Swinerton, Inc.

have been building substantial
buildings for over a half of a cen-
tury, are still building them and
will continue building them for
another half of a century.

Lindgren & Swinerton, Inc.

Standard Oil Building
San Francisco
619 H Street
Sacramento

605 W. Olympic Boulevard
Los Angeles
1723 Webster Street
Oakland

tion offices, and space on the second floor is allocated to a library, faculty lounge, student study rooms, foyer and exhibition hall. There is a supply store on the ground floor.

The typical floor of the art school, according to its designers, comprises one large drafting or workroom which accommodates seventy-five to one-hundred students, a second room which would take care of thirty-five to fifty students, and five smaller ones with a capacity of twenty-five students. Instructors' offices and locker space are also provided. During the two months' task of constructing the model, the student designers acquainted themselves with, and rigidly adhered to, building restrictions pertaining to sidewalks and distances from adjacent structures.

The tourist camps were designed for a location "somewhere in the West about a day's drive from adequate hotel accommodations." The site, one section of which fronts on a lake, is cut in two by an express highway. All plans included twenty two-room cabins and thirty one-room cabins with a parking lot for fifty cars with trailers and supplementary parking facilities for 100 cars. Provision is made for a restaurant and lunch counter to serve 125 persons, two filling stations with twelve gas pumps, a garage for lubrication and repairs, and lavatory buildings.

The best three designs, according to Mr. Shaw, differ principally in their arrangement of the cabins fronting the lake. All three placed the trailer camp on one side of the highway and the service station building, restaurant and cabins on the side nearest the lake. In the plan by Benjamin Zapolski, 2035 Creston Avenue, New York, the cabins are arranged in "U" shape with the tip of the "U" facing the lake front and the enclosed space to serve as a parking lot. Herbert Warrington, 1110 East 180th Street, New York, reverses Zapolski's "U"-shaped plan, while Fred Abmeier, 4638-66th Street, Woodside, L. I., has his cabins arranged in a staggered fashion to permit a view of the lake from each. In each design "car ports" are provided between cabins.

BIDS CALLED FOR FRIANT DAM

Bids for the construction of Friant Dam, advertised recently by the United States Bureau of Reclamation, will be opened at 10 a.m. August 23 in Room 378 of the Federal Building in Sacramento, it was announced recently by Walker R. Young, supervising engineer of the Central Valley Project.

Friant Dam, to be located on the upper San Joaquin River 20 miles northerly from Fresno, will be 300 feet high and 3,430 feet, or about two-thirds of a mile long. It will create a water conservation reservoir to be operated for supplemental irrigation and flood control in the San Joaquin Valley.

Friant will be a gravity-type concrete dam extending across the broad canyon on a straight axis with an over-

Your Clients Want Warmth and Economy

You render your clients an added service when you specify H. C. Little Oil-Burning Heating Equipment. All our units are engineered for maximum heating comfort at minimum cost. Cheap diesel fuel plus efficient, patented construction insure economy and satisfaction. The completeness of the line insures a unit for every purpose. If in doubt which unit to specify, write our engineering department without obligation.



FOR SMALLER HOMES

The New Dual Wall Register Floor Furnace is ideal for smaller homes. The two registers deliver uniform, controlled heat on both sides of the partition. Available with Manual or Full Automatic, Thermostatic Control—an exclusive H. C. Little feature. New in design, but with proved engineering principles and economy. For details write Dept. A.

H. C. Little Burner Co., Inc.
DEPT. "A," SAN RAFAEL, CALIF.

No Worry for the Architect

"—All acid proof drain pipe and fittings shall be ferro-silicon—CORROSIRON—"

[Write for this specification]



FEDERAL BUILDING • CIVIC CENTER • SAN FRANCISCO

Arthur Brown, Jr., Architect

CORROSIRON DRAIN LINES and FITTINGS and LABORATORY EQUIPMENT was specified because of its superior resistance to corrosion and wear.

Pacific Foundry Company, Ltd.

NEW YORK • 3100 NINETEENTH ST., SAN FRANCISCO • LOS ANGELES

"I chose Yale Hardware (for the B. H. Lieurance residence, Santa Rosa) because of its known high quality, accuracy and reliability."

MARK DANIELS, A.I.A.

MARSHALL-NEWELL Supply Co.

Spear and Mission Streets

San Francisco

DISTRIBUTORS FOR

**YALE
LOCKS AND HARDWARE**

STRUCTURAL STEEL

For Class A Buildings,
Bridges, etc.

JUDSON PACIFIC CO.

1200 SEVENTEENTH STREET
SAN FRANCISCO

Plants: San Francisco - Oakland

POMONA TILES

FOR
Bathrooms and Kitchens
in over 60 colors

Warehouses and Display Rooms

135 Tenth St. San Francisco
629-33 North La Brea Ave. Los Angeles
6106 Roosevelt Way Seattle

POMONA TILE MFG. CO.
PLANT — POMONA, CALIF.

flow spillway in the center. Six outlet conduits for river regulation will pass through the dam. Other outlets on either side will discharge into the Friant-Kern and Madera canals which will take off at the dam to carry water to thirsty lands of five counties.

Friant Dam will back up the San Joaquin River about 15 miles to create a reservoir with a gross storage capacity of 520,000 acre-feet of which the top 70,000 acre-feet is to be reserved for flood storage and the next 316,000 acre-feet will be active canal storage. The reservoir space below the outlets will be dead storage.

Present construction plans do not include a power plant at Friant Dam.

Mr. Young said the general contract will involve the placement of about 1,850,000 cubic yards of concrete, which is enough to surface a standard three-lane highway connecting San Francisco and Los Angeles.

Friant Dam is to be the second large dam of the vast Federal reclamation project which is designed to conserve and regulate the waters of the Sacramento and San Joaquin rivers in a coordinated program of navigation improvement, flood control, irrigation, salinity control and electric power generation for the Great Central Valley. A contract was awarded a year ago by the Bureau of Reclamation for Shasta Dam and power plant on the Sacramento River above Redding where operations have reached a stage of large-scale construction.

R. B. Williams, veteran of 27 years with the Bureau of Reclamation, including service at Boulder Dam and as construction engineer of the All-American Canal, has arrived in California from Washington, D. C., to become construction engineer of the Friant Division of the Central Valley Project. Mr. Williams will proceed to Friant after a conference with Mr. Young at the project headquarters in Sacramento.

Considerable work already has been done at Friant. In preliminary exploration about a mile of test holes has been driven at the dam site to prove the adequacy of the foundation rock. Surveys of the dam site and reservoir area are completed. Canal locations have been staked out from Friant, a distance of 72 miles on the 160-mile Friant-Kern and 13 miles on the 40-mile Madera Canal.

A Government camp to house Bureau of Reclamation engineers, clerks, inspectors and surveyors has been built a half mile downstream from the dam site adjacent to the existing town of Friant in Fresno County. The camp includes 28 single family residences, 25 duplex cottages and two air-cooled dormitories—all with garages—and an administration building, testing laboratory, warehouse and combined fire station-garage. Friant Camp has paved streets and modern water, sewer, electricity and gas systems. The general contractor will build a separate camp for his employees.

The call for bids for Friant Dam followed recent acquisition of the dam site and nearby gravel deposits by the Government from the Madera Irrigation District.

DEATHLESS SAFETY ISLANDS

The Chicago Park District is completing the experimental construction of a new type of divisional fin on the Outer Drive at 47th Street.

It features two new types of safety islands at the north and south ends of the fin. The north island has approaches made of white concrete and is so designed that cars would be deflected from the island proper if struck from an angle or off center, or stop the car by friction and gravity in case the island approach is straddled. The south island has approaches made of two parallel wire cables inclined from the pavement to the safety island with Federal yellow colored wood boards between these cables. Cars whose drivers are asleep or have their attention diverted would, upon driving on the device, cause the cables to sag, thereby further causing the wood boards to clack upon the pavement, which would give a sound warning to the drivers of their approaching danger.

Stretching between the above described islands and two turn-off islands at 47th Street extended are six separate strands of yielding cable, so arranged that it acts as a positive divisional fin without the dangers of fixed types of curbs used on ordinary divisional fins. Cars striking this new type of fin would be deflected back into their proper channel by the yielding cable and would not jump the curb, as is the custom on ordinary fins, which frequently cause drivers to lose control of their cars.

Experimentation of this installation has been carried on at the 23rd Street viaduct in the southbound drive. The tests were carried on to destruction. From these tests many new features have been added to this device.

A GUIDE TO THE GOLDEN STATE

"California, A Guide to the Golden State," the largest state guidebook in the American Guide Series, compiled and written by the Federal Writers' Project, has been published and is now on sale at all book stores, according to Walter McElroy, Acting Director of the Federal Writers' Project, Works Progress Administration in Northern California.

"California, A Guide to the Golden State," is the latest volume in the series of State guidebooks being compiled by the Federal Writers' throughout the United States. An omnibus volume of 850 pages, it pictorializes and dramatizes the history and achievements of California, in essay, tour and photograph.

Its 350,000 words serve as an impressive body of descriptive information about California. Forty-eight pages of photographs and a dozen maps illustrate the most stirring aspects of the State's many-sided activities and interests.

A valuable section of the book is composed entirely of a series of tours which criss-cross the main highways and enable the tourist to reach every point of interest within the State.

MILL WORK Interior Finish

Residence of B. H. LIEURANCE, near Santa Rosa
by

JAEKLE BROS.

Millwork • Sash • Doors • Glass
NAPA, CALIFORNIA



PRODUCTS

VAN ARSDALE-HARRIS CO.

ENGINEERS & CONTRACTORS

ACOUSTICAL TREATMENT - INSULATION
SOUND CONTROL

FIFTH & BRANNAN STS. SAN FRANCISCO, CALIF.
TELEPHONE GARfield 3600
DIVISION

VAN ARSDALE-HARRIS LUMBER CO., INC.

USE BASALITE

Light-weight, pre-fabricated Concrete building products for floors, walls, and roofs in your next building.

BASALT ROCK COMPANY, INC.

Napa, California

NOISE CONTROL— ON TREASURE ISLAND

STATE AUDITORIUM AND RADIO STUDIOS
BELL TELEPHONE SYSTEM EXHIBIT
SAN FRANCISCO RECREATION EXHIBIT
FEDERAL BUILDING THEATER

Furnished by—

WESTERN ASBESTOS CO.

Building Materials Mechanical Specialties
SACRAMENTO OAKLAND
SAN FRANCISCO

STANLEY

THE SYMBOL OF LEADERSHIP
IN DOOR HARDWARE FOR 90 YEARS

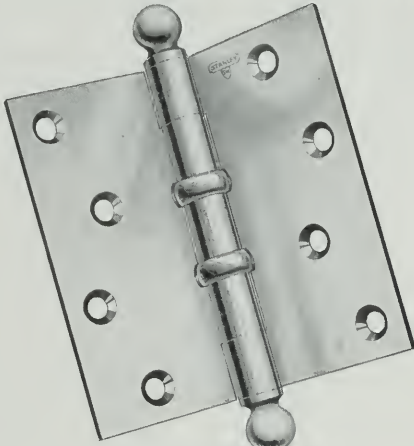

THE STANLEY WORKS
New Britain, Conn.

SAN FRANCISCO
576 Monadnock Bldg.

LOS ANGELES
407 American Bank Bldg.

SEATTLE
568 First Avenue, South

STANLEY

TRADEMARK

HARDWARE FOR CAREFREE DOORS

Dependable Building Materials

- Lumber
- Plywood
- Insulation
- Shingles
- Concrete form panels
- Building paper
- Shingle stains
- Wall board
- Termite control

"Goods of the Woods"



E. K. WOOD LUMBER CO.

LOS ANGELES • SAN FRANCISCO • OAKLAND

THAT SMALL HOUSE PROBLEM

(Concluded from Page 58)

headed. The merchandising methods employed by these manufacturers are logical and rational elements of their business and the continued operation of them puts us farther and farther out of the public mind.

This is not the only place we are losing ground with the public. I am informed that it is common practice in a number of eastern cities for operative builders to employ architects to prepare **plans and specifications only** for large projects. Do we call that practicing architecture? Those who do this sort of thing say it is, because they have the jobs. The rate at which we are losing ground because of practices herein mentioned will continue to further weaken us in the public mind. I recently heard our position humorously defined by a prominent Chicago architect something like this: "We are losing out in so many fields that before long one of us will be stuffed and placed on exhibition in a museum beside the buffalo and other declining species."

Earlier I said something about simple means and sane thinking. I think several facts must be stated and recognized, whether we like them or not.

First: We never have been in the small house field as a profession.

Second: By talent and training we are best equipped to render service in that field.

Third: If it be true that 85 per cent of all residential building receives no architectural service, it is logical and rational for architects to try to get activity into this field.

Fourth: Others now control this field through financially supported agencies established and operated for their particular benefit.

Fifth: These forces have not the slightest intention of relinquishing control of this field, but intend to promote their programs in even more intensive fashion.

Sixth: These interests are not in competition with architects because we have never been in control of this field, and the market they serve is unwilling to pay anything for architectural service.

ENTERS COMPETITION

Ivan M. Palmaw, member of the architectural firm of Beker, Stewart & Palmaw of Seattle, has been invited to participate in an international competition for the design of a Presidential Palace at Kovno, Lithuania. The competition closes August 1.

ARCHITECT APPOINTED DEAN

Walter R. McCornack, prominent Cleveland architect, will become dean of the School of Architecture at Massachusetts Institute of Technology next fall when William Emerson, head of the school for twenty years, retires.

ALAMEDA RESIDENCE

From plans by John B. Anthony, 462 Elwood Street, Oakland, a \$7,000 residence is being built on Fernside Boulevard, Alameda, for P. J. Swenson.

Interior and Exterior Plastering

for the B. H. Lieurance House
illustrated in this issue

by

RICHARD KEEHN

Plastering Contractor

Phone 2704-W

Santa Rosa, Calif.

E. AHLSTROM

General Contractor

for the B. H. Lieurance House
illustrated in this issue.

1015 ROYAL STREET
Santa Rosa, Calif.

THE HERMANN SAFE CO.

MANUFACTURERS AND DEALERS
OF
FIRE AND BURGLAR PROOF
SAFES AND VAULTS, SAFE-
DEPOSIT BOXES, ETC.

200 HOWARD STREET
SAN FRANCISCO
GARfield 3041 - 3042

FINE WATER COLORS AND PAPERS FOR ARCHITECTURAL RENDERINGS

H. S. CROCKER COMPANY, Inc.

720 MISSION STREET
MARKET STREET AT SECOND
SAN FRANCISCO

ILLUSTRATIONS OF SUPERIOR CONSTRUCTION



THIS large warehouse was designed by Norstrom & Anderson, Architects. The flexibility of Summerbell design is demonstrated by the flat roof obtained through the use of the superstructure. The integral framing of the truss and superstructure insures added rigidity to the entire roof structure.



**SUMMERBELL
ROOF STRUCTURES**
LOS ANGELES - OAKLAND - PHOENIX
TIMBER STRUCTURES, INC., PORTLAND

ROOFS OF WOOD—BUILT TO

ENDURE

WHO IS BLOCKING RECOVERY?

REPLYING to charges that selfish groups within the building industry are blocking recovery by arbitrarily maintaining high costs in defiance of public interest, Charles D. Maginnis of Boston, president of the American Institute of Architects, in an address at the University of Notre Dame June 24, suggested a nation-wide inquiry into the alleged abuses.

An aroused public is entitled to know whether the social aims of the Federal Government's vast slum clearance projects are being thwarted by artificially established costs, declared Mr. Maginnis, pledging co-operation of the nation's architects in any investigation that may be undertaken.

"So long as the causes of the depression remain inscrutable to the specialists, no interest can know the measure of its obligation to correct them," said Mr. Maginnis, who was the principal speaker at a banquet closing a two-day regional meeting of the Great Lakes and Illinois-Wisconsin Districts of the Institute.

Pacific Manufacturing Company

High Class Interior Finish
Quality Millwork

142 Sansome St. 6820 McKinley Ave.
San Francisco Los Angeles
GARfield 7755 THornwall 4196

1315 Seventh Street, Oakland
GLencourt 7850

Brick and Concrete Work
on B. H. Lieurance resi-
dence illustrated in this
issue

"Superior-Bilt"

by

Walter L. Olsen
Santa Rosa, Calif.



Golden Gate Atlas
TRANSIT
MIX CONCRETE
AND MORTAR

•
makes delivery of material to the job swift and inexpensive . . . minimizing the architect's supervision costs and assuring his client a dependable mix.

•
PACIFIC COAST
AGGREGATES, Inc.

16th and Harrison Streets
85 Second Street
San Francisco

Phone GARfield 1164

Hunter & Hudson

Consulting Engineers

DESIGNERS OF HEATING
AIR CONDITIONING
VENTILATING AND WIRING
SYSTEMS, MECHANICAL
AND ELECTRICAL EQUIP-
MENT OF BUILDINGS

41 SUTTER STREET
ROOM 710

San Francisco California

Robert W. Hunt Company
ENGINEERS

Inspection - Tests - Consultation
Schools and Other Structures
Are Built as Designed

*When Construction Materials are
Inspected at point of Manufacture
and during Erection by*

ROBERT W. HUNT COMPANY

*Cement, Concrete, Chemical, Metallurgical,
X-Ray and Physical Laboratories*

Chicago - New York - Pittsburgh
Los Angeles - All Large Cities
San Francisco, 251 Kearny Street

"The building industry is generally recognized as the most fundamental factor in the national economy. We had grown to think of it as the chief victim of the business slump. But there are now those who are bold enough to say that the impediments to the general recovery are a responsibility of the building industry itself, whose high costs of labor and materials are paralyzing long-term investment. Not only this, but it is charged that these costs are artificially established and maintained by its selfish groups in defiance of the national interest.

"This is so grave an indictment that no element associated with building should shrink from an examination of its merits. The public is now particularly aroused over the failure so far to accomplish the reduced costs of construction which are necessary to realize the social purpose of the slum-clearance projects on which government is spending vast sums.

"It is clearly entitled to know if and what conditions in the building industry are working against this beneficent enterprise and whether the industry has the capacity and the disposition to remove them. I am sufficiently confident of the sentiment of the architectural profession to promise the earnest participation of the American Institute of Architects in any comprehensive inquiry into this subject.

"It has been stated of my own profession by a critic of consequence that architects are not sufficiently sympathetic with the economic phases of the modern design. That is, to this extent at least, inaccurate—that we have brought the most stark and scientific principles to the solution of the slum problem and the small house.

"The architect, if that be his job, can be as passionate in the pursuit of triumphant economics as he is known to be in the essays of his imagination. It is to be noted that his professional relation to the housing projects exceptionally encouraged his search for new materials and more up-to-date methods, an enterprise in which he has found himself in many communities in discouraging conflict with conservative building laws.

*Ideal
Banking
Service*
**FOR
SALESMEN**

Traveling men, salesmen — men and women whose jobs prevent their calling at the bank in person, find our BANK-BY-MAIL Service ideal. They do their banking when most convenient, night or day and wherever there is mail service. Prompt. Reliable. Overnight to most points in California.

Write today...

for free Bank-by-Mail kit containing all necessary forms, return envelope and simple instructions.

**CROCKER FIRST
NATIONAL BANK**
OF SAN FRANCISCO
California's Oldest National Bank

Member Federal Deposit Insurance Corporation

**THE TORMEY
COMPANY**

GENERAL PAINTERS
AND DECORATORS

—
Phone UNderhill 1913

—
563 FULTON STREET
San Francisco

**Donovan Automatic
Awning Type
Windows**

Give 100% natural ventilation
and day-lighting control

•
**UNIVERSAL WINDOW
COMPANY**
Berkeley, California



CLIENTS will bless you for installing the Wesix "49'er" ELECTRIC BATHROOM HEATER. But try it first in your own home. Certain that you will like its forty-nine inches of INSTANT RADIANT HEAT and QUICK CIRCULATING HEAT, we are offering this smart new heater at factory cost to architects, for personal use! Limit one heater per architect. List price \$21.50. Please write on your regular letterhead, to: 1018 WESIX BLDG., SAN FRANCISCO

WESIX
WESIX ELECTRIC HEATER CO.



**HERRICK
IRON WORKS**

STRUCTURAL STEEL
REINFORCING STEEL

18TH AND CAMPBELL STS.
OAKLAND, CALIF.
Phone GLEncourt 1767

**FORDERER
CORNICER WORKS**

Manufacturers of

- Hollow Metal Products
- Interior Metal Trim
- Elevator Fronts and Cabs
- Metal Plaster Accessories
- Sanitary Metal Base
- Metal Cabinets
- Flat and Roll Metal Screens
- Commercial Refrigerators

269 POTRERO AVE.
San Francisco, Calif.
HEmlock 4100

"It is clear that modifications can frequently be effected in these local regulations without prejudice to reasonable standards of safety. It is this principle of security, however, which warns us that there cannot fairly be exacted from any industry costs of production, however beneficial to the general interest, which do not allow an adequate regard for its own protection and efficiency."

**COMMUNITY IMPROVEMENT
APPRAISAL**

Analysis of approximately 8,000 local reports submitted in an independent, nation-wide appraisal of the Federal Works Program disclosed a consensus of both large and small communities that the work performed was badly needed and of permanent value, that the workers themselves had been helped, and that the quality of their workmanship was good.

The United States Community Appraisal, inaugurated on January 24, 1938 and completed on January 23, 1939, was co-operatively sponsored by 11 agencies, and was conducted to determine the value of the types of projects operated by the Works Progress Administration and the efficiency of its methods of operation from the twin standpoints of (a) effect on the unemployed and (b) effect on the communities as a whole. The National Appraisal Committee after a study of the reports submitted by state and local officials, and outstanding citizens, presented the following:

"Of all the reports from the communities, large and small, specifically answering the various questions put to them—

"93% stated that the work performed was badly needed and of benefit;

"90%, that it was of permanent value;

"79%, that their own fiscal condition was improved by it;

"90%, that work relief had been better than the dole, both for individuals and communities;

"90%, that the health, recreation, education and other non-construction activities had been worthwhile;

Pitcher

**Improved
Disappearing Doors
Save 20% Space**

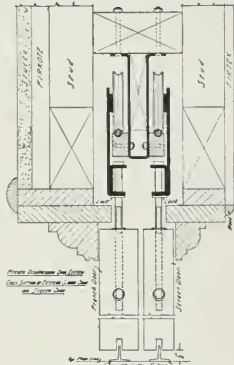

Joins with a 3 1/2" stud wall . . . steel studs . . . adjustable steel and wood track. Can be used for screen doors in connection with French doors. Send for detail drawing.

E. C. Pitcher Co.
557 Market Street
San Francisco

MADDEN

Installed the Plumbing
and Heating Equipment

in the
MASTICK SCHOOL,
ALAMEDA

Kent and Hass, Architects

**MADDEN PLUMBING &
HEATING CO.**

3103 SAN PABLO AVENUE
OAKLAND, CALIFORNIA

**"AMERICAN MARSH"
Redi-Vac Vacuum
Heating Pump**

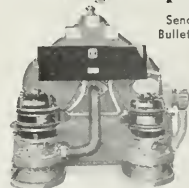

SIMONDS MACHINERY CO.
San Francisco Los Angeles
B16 Folsom St. 455 East Fourth St.



SANTA MARIA INN

Santa Maria, California

*On the Coast Highway
between*

Los Angeles and San Francisco

OVER NIGHT

or

JUST A MEAL

FRANK J. MCCOY, *Owner*
Geo. A. Thompson, *Manager*

El Encanto Hotel

Santa Barbara

*On the Riviera, above the
Old Mission*

Frank J. McCoy, *Owner*
Fred F. Pimental, *Manager*

Independent Iron Works

Structural Steel
Ornamental Iron
Steel Service Stations
Steel Tanks
Standard Steel Mill Buildings
Bridges

821 Fine Street

Oakland

Clinton Construction Co. of California

*General
Contractors*

923 Folsom Street
San Francisco
SUtter 3440

"90%, that community improvement had been advanced;

"80%, that the work had maintained the skills and employability of the workers;

"85%, that the quality of workmanship was good;

"75%, that the quality of the administration was good."

The appraisal, conducted in 42 states, was sponsored by the American Engineering Council, the American Institute of Architects, the American Municipal Association, the American Public Welfare Association, the American Society of Planning Officials, the National Aeronautic Association, the National Education Association (Department of Adult Education), the National Recreation Association, the U. S. Bureau of Public Roads, the U. S. Conference of Mayors, and the Works Program Administration.

The method followed was to have some state organization, such as a state league of municipalities, state planning board, state relief administration, or state university seek to gather from state officials, local officials and interested citizens answers to a series of questions concerning the Works Program for the needy. Afterwards a state-wide committee of leading citizens summarized the local answers and made recommendations. In all, more than 8,000 individual reports constituted the material upon which the various state appraisal reports were based. This part of the appraisal was completed in the late spring of 1938.

In the fall of 1938, the 11 national co-operating agencies named a National Appraisal Committee which evaluated and summarized the reports made by the State Appraisal Committees, prepared a nation-wide report enumerating its findings and making recommendations. These reports were arrived at by studying the various state committee reports and the 8,000 local opinions.

In its findings the National Appraisal Committee pointed out that the 8,000 opinions from communities and the reports of the 42 state committees "are exceedingly valuable be-

Ferro - Porcelain

FOR

A. CAPURRO BUILDING

Corner Polk and Washington Sts.

Martin Rist, Architect

Furnished and Installed by

FRANK ALLEN

Ferro-Porcelain Construction
320 MARKET ST., SAN FRANCISCO

Melrose Lumber & Supply Co.

LUMBER AND
MILL WORK

46th Ave. and E. 12th St.
Oakland
Phones: FRuitvale 0240 — 0251

ANDERSON & RINGROSE

General Contractors

320 Market Street, San Francisco
Phone GARfield 2245

HIGH GRADE MILLWORK
AND INTERIOR FINISH
SASH AND DOORS

LANNOM BROS. MFG. CO.

FIFTH AND MAGNOLIA STREETS
OAKLAND, CALIFORNIA
Telephone: TEmplebar 3663

MULLEN MFG. COMPANY

BANK, STORE AND OFFICE
FIXTURES—CABINET WORK
OF GUARANTEED QUALITY
CHURCH SEATING

Office and Factory:
60-80 RAUSCH ST., Bet. 7th and 8th Sts.,
San Francisco
Telephone UNDERhill 5815

G. P. W. JENSEN & SON

Building Construction

320 Market Street, San Francisco
Phone: CArfield 2444

DINWIDDIE CONSTRUCTION COMPANY

•
BUILDERS
•

CROCKER BUILDING
SAN FRANCISCO

Carl T. Doell Co.

Plumbing
Heating

Plumbing Contractor
Veterans Memorial Building
Oakland

467 21ST STREET
OAKLAND

Telephone CLencourt 8246

cause among other reasons (1) they constitute, so far as this committee knows, the only comprehensive survey of this sort in existence, averaging more than 150 communities for every state in the nation, and (2) they are not limited to favorable comments but contain much candid, constructive criticism designed to correct some points on which present operation is unsatisfactory and which may be used as a basis for improvement."

F. H. TAX BURDEN

(San Francisco Chronicle)

For more than five years this country has been the clinical subject for all manner of planning theory experiments conceived in the New Deal laboratory. Most of them, as originally applied, have failed outright, and the ultimate effect of those having resulted in some slight improvement to the patient is in doubt.

Most successful, of course, have been the shots administered in the form of prodigal spending; there is no question that such treatment will continue effective as to its direct objective so long as those who produce the stimulant—money—can continue to do so. The extent to which this producing can be prolonged is a cause of worry not only to those who direct the spending but more so to those who are doing the producing at the behest of the tax extortionist.

Some months ago the New Deal experimenters placed great stress on the good that was to come from the Federal Housing Project. None questioned the advantage that would accrue to the minimum wage earner should he gain improved living conditions, and, generally speaking, there was a belief that the burden on those who, in the final analysis, provide the Federal Government with its spending money would not be too great or too prolonged.

Now, however, comes a statement showing that, according to figures prepared by L. J. Towne, president of the A. L. Hartridge Company, engineers and contractors, "the burden on the taxpayer to meet the accepted idea of \$4 to \$7 monthly rent per room for the minimum wage earner

Louis C. Dunn, Inc.

GENERAL
CONTRACTORS

Monadnock Building
San Francisco

Phone: DOuglas 4632

Empire Construction Co., Ltd.

Builders



RUSS BUILDING
SAN FRANCISCO
SUtter 2989

Smith

Lumber Company
WHOLESALE - JOBBING - RETAIL
FACTORY AND BUILDING LUMBER
PLYWOODS - ROOFING

DISTRIBUTING YARDS

San Francisco	Oakland
•	19th Ave. &
4th & Channel	Estuary
MArket 0103	FRuitvale 3174

YOUR INQUIRIES SOLICITED

SISALKRAFT

REG. U. S. PAT. OFF.

"More than a
building paper"

THE SISALKRAFT CO.

205 West Wacker Drive
(Canal Station) Chicago, Ill.
55 New Montgomery Street
San Francisco, Calif.

ABBOT A. HANKS, INC.
Engineers & Chemists

INSPECTING — TESTING — CONSULTING
CONCRETE • STEEL • MATERIALS
CHEMICAL AND TESTING
LABORATORIES
• RESEARCH AND INVESTIGATION •

TESTS OF STRUCTURAL MATERIALS
DESIGN OF CONCRETE MIXES
SHOP AND ERECTION INSPECTION OF
STRUCTURES AND EQUIPMENT
INVESTIGATION OF STRUCTURES
AND MATERIALS
TESTS AND INVESTIGATION OF
FOUNDATION SOILS
FIRE RESISTANCE AND INSULATION
TESTS

624 Sacramento Street, San Francisco

VAUGHN - G. E. WITT Co.

Manufacturers and Distributors

Pump Governors	Oil Heaters
Safety Pump Governors	Relief Valves
Automatic Gas Regulating Valves	Oil Burner Governors
Gas Burning Equipment	Oil Burners
Vacuum Pump Governors	Oil Pumping Sets
Vacuum Regulating Valves	Oil Valves
Continuous Flow Steam Traps	Oil and Steam Strainers
Thermostats	Duplex Oil Pumps
Reducing Valves	Rotary Oil Pumps
	Boiler Feed Pumps
	Water Heaters
	Boiler Feed-Water Regulators

4224-2B Hollis St., Emeryville, Oakland

**VERMONT
MARBLE
COMPANY**

Producers and Finishers
of

**Domestic and Imported
Marbles**

San Francisco
Los Angeles
and
Tacoma, Wash.



MERCURY PRESS

We Print
**The ARCHITECT and
ENGINEER**

*"A Thing of Beauty
Is a Joy Forever"*

942 HOWARD STREET
SAN FRANCISCO

amounts to about half the actual cost of providing the housing facilities." The conclusion results from a study of costs as represented by the most recently completed multiple housing projects constructed and operated under supervision of the New York State Housing Board.

Result of the study is interpreted as showing a material margin in favor of 100 per cent equity financing on a low interest return such as that now being carried on in New York by the Metropolitan Life Insurance Company. The margin here is from \$2 to \$3 a room, and, according to the survey, is not in itself sufficient to offset other factors such as location, existing competitive housing and the like, provided such factors are unfavorable.

"Only when low cost financing is combined with sound judgment with respect to real estate problems as well as design and construction costs can such large scale operations hold any advantage over the marginal producer of housing," is the opinion of Towne. He finds, though, that "from a broad viewpoint of progress in housing all of the advantages appear to rest with large scale housing because of the better control of light and air and neighborhood conditions."

The conclusion holds further that while some hardship results to owners of displaced facilities, in the long run such a program is of benefit to the community at large, in addition to the hope offered for stimulation of the stagnant building industry.

**POSSIBLY SOME READER WILL
SEND HIM THE ANSWERS**

Editor Architect and Engineer

Sir:

Being a senior in college, I am naturally concerned with planning my future, I have majored in architecture, and am quite interested in continuing with graduate work and making architecture my chosen field in life as it has been in Princeton.

However, before deciding definitely to do so, I feel I should know more about architecture as it is actually practiced, and just what future it offers to a young man entering it today.

Therefore I am writing you in hopes that you will send me the following information:

1. How many architectural firms are there in the United States today?

**JOSEPH MUSTO
SONS-KEENAN
CO.**

**MARBLE
and ABRASIVES**

ONYX

535 NORTH POINT STREET
SAN FRANCISCO
1801 S. SOTO STREET
LOS ANGELES

**THE MOST COMPLETE LINE
OF STEELS AND STEEL BUILD-
ING MATERIALS MADE BY A
SINGLE PRODUCER**



See Sweet's Catalog File or write us for full information.

Republic Steel Corporation
General Offices: Cleveland, Ohio

Denver, Colo. . . . Continental Oil Bldg.
Los Angeles, Calif. . . . Edison Bldg.
Salt Lake City, Utah . . . Walker Bank Bldg.
San Francisco, Calif. . . . Rialto Bldg.
Seattle, Wash. . . . White-Henry-Stuart Bldg.

**JOHN
CASSARETTO**

—Since 1886—And Still Active—

Building Materials

READY MIX CONCRETE
ROCK - SAND - GRAVEL - LIME
CEMENT - PLASTER - MORTAR
METAL LATH - WOOD LATH
STUCCO - WIRE NETTING

Service Unexcelled

Bunkers
Sixth and Channel, San Francisco
Phones: GARfield 3176, GARfield 3177

2. Approximately how many men are employed in the field?
3. What is their average earning capacity?
4. What are the chances of getting "to the top" in architecture?
5. What do you think of the prospects of architecture in general during the next twenty or thirty years?

If you can let me know the answers to these questions, I shall be very grateful; and any additional information or advice will be appreciated.

Yours very truly,
BRUCE BALDWIN

Blair Tower, Princeton, N. J.

ARCHITECT AND ENGINEER

ARCHITECT

AND

ENGINEER

AUGUST 1939



SOUND CONSTRUCTION INSIDE AND OUT



Striking Beauty combines with Enduring Strength in this newly completed "Neo-Classic" Court House Annex, in San Mateo County, California—a monument of modern architecture and construction. ☆ Specified and used throughout were Golden Gate Cement, for Sound Construction, and *Plastercraft Products*—Empire Plaster, Milcor Lath, and Empire Studs—to assure permanent, pleasing interiors.

Of special interest are the historical bas-relief figures on the facade. Here again, where sharp uniform plaster waste moulds were required, Empire Plaster was specified. ☆ To be certain of Beauty, Strength, and Permanence on your next job, specify *Pacific Products*—a reliable source for over a third of a century.

Ask Your Building Materials Dealer

\$240,000 Court House Annex, Redwood City, California. Will H. Toepke, Architect; H. H. Larsen Company, General Contractors; Peter Bradley, Plastering Contractor.



PACIFIC PORTLAND CEMENT COMPANY

SAN FRANCISCO

• SEATTLE

COASTWIDE SERVICE

LOS ANGELES

• PORTLAND

RUNNING FIRE

by
MARK DANIELS, A.I.A.

California Architecture

A recent issue of a nationally circulated magazine, published in New York, stated that the visiting Englishman would find the "American Climate" quite different from the English climate. It is possible that this New Yorker had in mind the climate of New York and was guilty of mistaking conditions that obtain in that great city for the norm of all things in North America. That mistake has been made before.

In much the same way, we hear the phrase, "California Architecture." There is no more a definite "California Architecture" than there is an "American Climate." We may speak of an English Architecture, Spanish, French or Swiss architecture but neither domestic nor monumental architecture in California has arrived at a stage where we can point to a structure and say "That is California architecture."

It also has been said that domestic architecture in California is a goulash, a mixture of types of structures ranging from the Nomad tents of Arabia to the totem poles of Alaska. In a degree, that is to be expected. Archeologists, which modernists hold includes most of the passing generation of architects, agree that the six most potent factors influencing architectural style are geographical, geological, climatic, religious, social and historical. This being true, what might one expect to find, other than a variety that runs the entire gamut of styles, in a territory that has a thousand miles of coast line running mostly north and south, a coast line that would stretch from Rome to Copenhagen, from Marseilles to Edinburgh, from Istanbul to Warsaw? How could one expect to find architectural unity in a land that spans ten degrees of latitude, in an area that embraces the highest and lowest points in the United States, in an empire registering temperatures that vary from the torrid heat of the Sahara deserts to the chill winds that sweep perpetual snows? No, there is no such thing as "California Architecture."

Transportation

San Francisco has suffered for many years under a traffic problem that has worried and harried its inhabitants into gray hairs, dented fenders and bruised feelings. People traveling from Marin County to the Peninsula or the East Bay have somehow managed to swear their way across the town, around the Embarcadero and into another major highway.

We have had the McClintock Survey, we have tried to hire Charles Purcell and we have done everything to effect a rapid transportation system but put one into effect. Unfortunately, when we appeared to have solved the problem by hiring Charles Purcell, it was ruled that this was impossible. When a subway system was proposed, it was drowned out in the shouts of protest. Everyone has had a finger in the pie and no one has offered a workable solution for the problem. Everyone has a different idea and everyone insists that his idea is right.

I can close an eye, in fact both eyes, and visualize an overhead highway shooting along the Embarcadero and joining the San Francisco Bay and the Golden Gate bridges; no cars stopped for heavy trucks, no trucks stopped for heavy traffic and hardly a curse in a carload. I can visualize an automobile shooting across town from either the Golden Gate or Bay bridge to travel down the Bayshore or Skyline Boulevards. I can visualize, though I have to be almost asleep, persons traveling to downtown San Francisco in a quick and easy style, finding parking places and departing again just as rapidly. But always there comes before me the vision of sitting in my car at an intersection listening to the blatant horns of other motorists waiting for some x-x-x-x-x automobile or truck to get out of the way, wishing I had not brought the car because I could have made better time on foot.

But probably, if you or I barely suggested removing a sharp curb we would be drowned in a chorus of "You're ruining the character of the intersection, you can't do that—we'll fight to the death."

Introspection

I walked into the bar and ordered an Old Fashioned. Two men were sitting to one side, wreathed in smiles, and talking to each other in a most friendly way. Before long they were frowning, scowling and shaking fists at one another. A voice at my side said "Man is not man but men."

I turned and saw a little man with bright blue eyes.

"The dual personality of the individual is remarkable," he continued. "The most ancient Greeks visualized a satyr as possessing goat's legs and a human torso. The Romans recognized the plural character by their representation of the god Janus who looked both backward and forward. Shakespeare instilled Cassius with a kindly role and an evil character. Even in modern life we find this strange association—Clarence O'Brien, the man who just mixed your Old Fashioned, is running for the office of sheriff. . . ."

"Huh?," said I, and looked at the bartender.

. . . in November. Our modern interpretation of Dr. Jekyll and Mr. Hyde is even further evidence of both the fictional and actual existence of the duality of individual characters. Man reveals himself as a carnivorous beast one minute and an angelic cherub the next. This double personality may be laid to repressions, suppression, depressions or any other condition, and my personal views on the matter don't count. It is enough that man is not just one man, he is a plurality of man, a multitude of traits and a plethora of units within a unit; he believes one thing, thinks another and does still another until the basic individual becomes many individuals. This fact is further evidenced in animals, species of the lower order, and . . .

There was a pause and I watched a woman jiggle her feet to the tune on the phonograph. Then I found the man had disappeared and the bartender was walking towards me. After he had taken the money for both my drink and the little man's I decided the O'Brien would make a good sheriff.

(Turn to Page 76)

ARCHITECT AND ENGINEER

AUGUST, 1939

FRED W. JONES
Editor

MARK DANIELS
Associate Editor

E. N. KIERULFF
Ass't Editor

CONSULTING BOARD
OF EDITORS

Frontispiece

Architectural—

Arthur Brown, Jr.
Frederick H. Meyer
Timothy L. Pflueger
Will G. Corlett
Harry Michelson
John J. Donovan
Lewis P. Hobart
David C. Allison
Gordon B. Kaufmann
Harris C. Allen
Glenn Stanton
Paul R. Hunter
C. H. Alden

Engineering—

H. J. Brunnier
L. H. Nishkian
William Adrian
Wm. H. Popert
Homer N. Hadley
John J. Gould
Geo. E. Atkins

Business Manager—

L. B. Penhorwood

Advertising Manager—

J. Leslie Meek

Architects' Reports—

Vernon S. Yallop

THE ARCHITECT AND ENGINEER, INC., 68 Post Street, San Francisco, EXbrook 7182. President, K. P. Kierulff; vice-president, Frederick W. Jones; secretary, L. B. Penhorwood. Los Angeles office, 832 W. Fifth Street. Published on the 12th on each month. Entered as second class matter, November 2, 1905, at the Postoffice at San Francisco, California, under the Act of March 3, 1897. Subscriptions, United States and Pan America, \$3.00 a year; Foreign countries, \$5.00 a year; single copy, \$.50.

HOUSE FOR EUGENE AND CARLOTTA MONTEREY O'NEILL
Frederick L. Confer, Architect

Text

PLAYWRIGHT BUILDS UNIQUE CONCRETE HOME	19
THREE RECENT PROJECTS BY DOUGLAS D. STONE, ARCHITECT	23
ENGINEERED LIGHTING PROVIDES EFFECTIVE MERCHANDISE DISPLAY	27
Robert L. Dearborn and Wm. Pierce, Jr.	
NEW ANNEX TO REDWOOD CITY COURT HOUSE	31
Fred W. Jones	
AN ALL-CONCRETE HOME AT TREASURE ISLAND	34
E. Brovelli	
A HOST'S SHORE HOUSE IN CALIFORNIA	40
Henry H. Gutterson, Architect	
CONGRESS OF ARCHITECTS AND A.I.A. CONVENTION	45
SOUND CONTROL FOR OFFICE EFFICIENCY	47
Rex E. Hieronymus	
ENGINEERS' CONVENTION DESCRIBED BY EXECUTIVE	51
Franklin P. Ulrich, C. E.	

Illustrations

HOUSE FOR EUGENE AND CARLOTTA MONTEREY O'NEILL, SAN RAMON VALLEY, CALIFORNIA	19-21
Frederick L. Confer, Architect	
METROPOLITAN BUILDING, SACRAMENTO	22
Douglas D. Stone, Architect	
HASTING'S STORE, SAN FRANCISCO	23-25
Douglas D. Stone, Architect, Lou B. Malloy	
FIELDING HOTEL, SAN FRANCISCO	26
Douglas D. Stone, Architect, Lou B. Malloy	
COURT HOUSE ANNEX, REDWOOD CITY	31-33
W. H. Toepke, Architect	
"THE CALIFORNIAN" MODEL CONCRETE HOUSE, TREASURE ISLAND	35
ADDITION TO BROADWAY-HOLLYWOOD STORE, LOS ANGELES	39
John Parkinson and Donald B. Parkinson, Architects	
TRANSMITTER BUILDING, RADIO STATION KNX, LOS ANGELES	38-39
John Parkinson and Donald B. Parkinson, Architects	
HOUSE FOR MR. AND MRS. CARL W. REBMANN, BELVEDERE ISLAND	40-43
Henry H. Gutterson, Architect	
RESIDENCE OF L. P. SINZ, SOUTH PASADENA	46
Robert H. Ainsworth, Architect	

6x9'S

LAST YEAR AN *IDEA* THIS YEAR A *TREND!*

INTRODUCED just last year, Kraftile's idea of 6" x 9" tiling has more than clicked with Western home builders. These handsome tiles have established a *new trend* in kitchen and bathroom walls.

For specifications and complete information about 6 x 9's, mail coupon below.

"New Jobs Ahead"—For You?

Have you heard about Kraftile's "New Jobs Ahead" program for architects, contractors and tile dealers? Interest in home building is aroused by Master Kraftile advertising in *Sunset* magazine. Inquiries are solicited and followed up. Cooperation between architects and dealers is arranged.

For more data on this result-getting program, how it can make new jobs for you, mail coupon today.



"NEW JOBS AHEAD"—Write for details NOW!

KRAFTILE COMPANY, NILES, CALIFORNIA

Please send me further information about Master Kraftile 6 x 9's — also details about your "New Jobs Ahead" plan.

Name _____
Address _____
City _____ State _____

BLOSSOM COMPANIONS FOR BULBS

Plant them now for flowers next spring

By BERNIECE ASHDOWN
Landscape Architect

THERE is always something inspiring about the crisp vigor of spring blossoms. Their colors are fresh and strong, and their whole appearance suggests the enthusiasm of youth. It is this vivid quality of their color that presents such difficult problems to gardeners. There is something particularly distasteful about the rich golden of Forsythia combined with bright magenta Tulips; too often, the charm of dainty blue Forget-me-nots is lost because it is planted too near flowers of the dull purple shades; the sparkling freshness of pale yellow is wilted when it is combined with warm rose shades.

This fall, when you plan your spring bulb garden, avoid these disappointments by working to a definite picture scheme. In other words, select your bulbs and accompanying plants, not only for their individual beauty, but also for harmony one with another. Plant combinations which will complement each other and create a perfect unit picture in the garden.

In planning these planting schemes, one should begin with the background. If the garden has some spring flowering shrubs—and most gardens do—the color scheme should begin with them. For example, if the shrub is a weeping Forsythia, one might plant dainty blue Flax (*Linum perenne*) whose fragile nodding blossoms are enchanting. In front of this, plant early pale yellow tulips and white violas to complete the picture.

When a flowering Almond or Peach forms the background, try early pink and white tulips in combination with the fluffy softness of the shrubs. Use pale lavender violas as a ground cover and edge the bed with a neat border of pink and white English daisies.

White flowering shrubs, like flowering plum, etc., are lovely and allow a great deal of latitude in selecting suitable combinations. Bright toned red tulips over a carpet of English daisies, are unforgettable.

If you like violets, and who doesn't, you will want a whole bed of them. They are best planted by themselves, since they crowd other plants, but by all means don't miss the opportunity of giving them a background of white flowering shrubs and nodding snow drops (*Galanthus*).

In our enthusiasm for flowering shrubs, however, we should not neglect the possibilities of plain green backgrounds made by evergreen shrubs and trees which acquire fresh green high lights when their new growth begins. They have the advantage of harmonizing with flowers of any color.

Pansies are so well known that they are often spoken of as "common flower," but the better varieties, when given proper care, are rightfully classed among the aristocrats. Combined with hyacinths or tulips, they are superlatively beautiful. Yellow pansies with

brown centers lend a perfect accent to tulips like Grenadier. Another gay companion for orange yellow tulips is bright yellow primulas.

Purple and pink tulips are lovely together and still lovelier when accented by a border of viola Jersey Gem.

The deep yellow Alyssum (Basket of Gold) makes a vivid and beautiful companion for lavender tulips, such as "Dream." It is lovely too with the airy, pale yellow Inglescombe tulip.

The Pride of Inglescombe tulip, with pointed petals and edges that grow pink as it ages, is exquisite in a bed edged with pink and white English daisies.

Bright blue scillas, combined with yellow daffodils and edged with purple pansies are especially pretty.

If you have a spot near some white barked trees, try planting long drifts of Poeticus narcissus and heavenly blue grays hyacinths.

Anyone fortunate enough to have a Rose Daphne should plant some Clare Butt tulips and pink *Frimulas* near enough to be blooming companions.

Dogwoods make a delightful picture planted with pink tulips and creamy white pansies. Persian lilacs seem even more delicate when they hang over a bed of tall lavender tulips planted with double white Aribis.

Dark, so-called black tulips, should be given a place somewhere in the garden. The best known is La Tulipe Noire. The newer, Queen of the Night is lovely. Planted with pale yellow, pink or white Tulips, it acts as a charming accent.

Flowers from bulbs are never lovelier than they are when they are planted near water. If you have water in your garden, by all means do not pass up the opportunity of planting some near enough so that their blossoms will be reflected upon the surface.

Attractive bulb gardens are not difficult to create, and contrary to popular belief, do not have to be replanted every year. In fact, most bulbs produce better blossoms the second year than they do the first. None need to be replanted for three or four years or until they become crowded.

Make careful plans before you plant bulbs in your garden this fall, and you will have, next spring, not only the beauty of spring flowers, but the charm of perfectly composed pictures.

BROWN SPOTTED LAWNS

This is the time of year when ugly brown blotches begin to appear in green lawns. Gardeners should be on the lookout as these spots mar many an otherwise beautiful garden.

There are two causes for brown blotches. The first is a fungus disease called "brown patch," which attacks any lawn but it is especially fond of bent grasses. This type of spot is easily identified by its shape. Round bits of brown grass the size of silver dollars

first appear. Gradually spreading, they become a foot wide within a week.

To banish these spots and have a luscious green lawn again, water the entire lawn with a solution of one of the mercury compounds or brown patch preventatives, sold at garden stores. Follow the directions for brown patch on the package. One application is almost enough to stop the trouble.

The second cause of brown spots is an insect—the larval worm of the crambus moth. Brown spots caused by these worms are not round but irregular. If you've noticed swarms of moths settling on your lawn in the evening and the grass is spotted with irregular brown blotches, beware. The moths lay their eggs in the lawn and when the worms hatch they ravenously devour the grass roots. A hole dug an inch or two under the brown will probably show numerous worms at work. To get rid of these pests spread lead arsenate over the whole lawn at the rate of one pound to 100 square feet. Then water thoroughly. Wait two weeks and repeat if the spots haven't stopped spreading. One application, however, is usually enough. When the spreading stops, dig out the blotches and reseed or fill in the bare places with pieces of lawn taken from a less conspicuous part of the garden.

HOW ABOUT SAN FRANCISCO?

(Southwest Builder and Contractor)

Architects of the principal structures of the New York World's Fair, 1939, will have their work publicized wherever the mail of New York boosters goes, through the colorful World's Fair stamps in 54 designs depicting the principal sights of the Fair. The official stamps will have the names of the architects printed across the bottom.

INCLUDE TREES IN YOUR PLANS

DAVEY, ORIGINATOR OF TREE SURGERY, OFFERS FREE INSPECTION AND ESTIMATE.



SAN FRANCISCO Sutter 3377
Russ Bldg. FRESNO
Mattei Bldg. LOS ANGELES

Story Bldg. TUCKER 1929
Local phones in: Pasadena, Palo Alto,
Oakland, San Rafael, San Mateo

SKILL - KNOWLEDGE -
RESPONSIBILITY

ARCHITECT AND ENGINEER

Use **PennuERNON** .. not just window glass

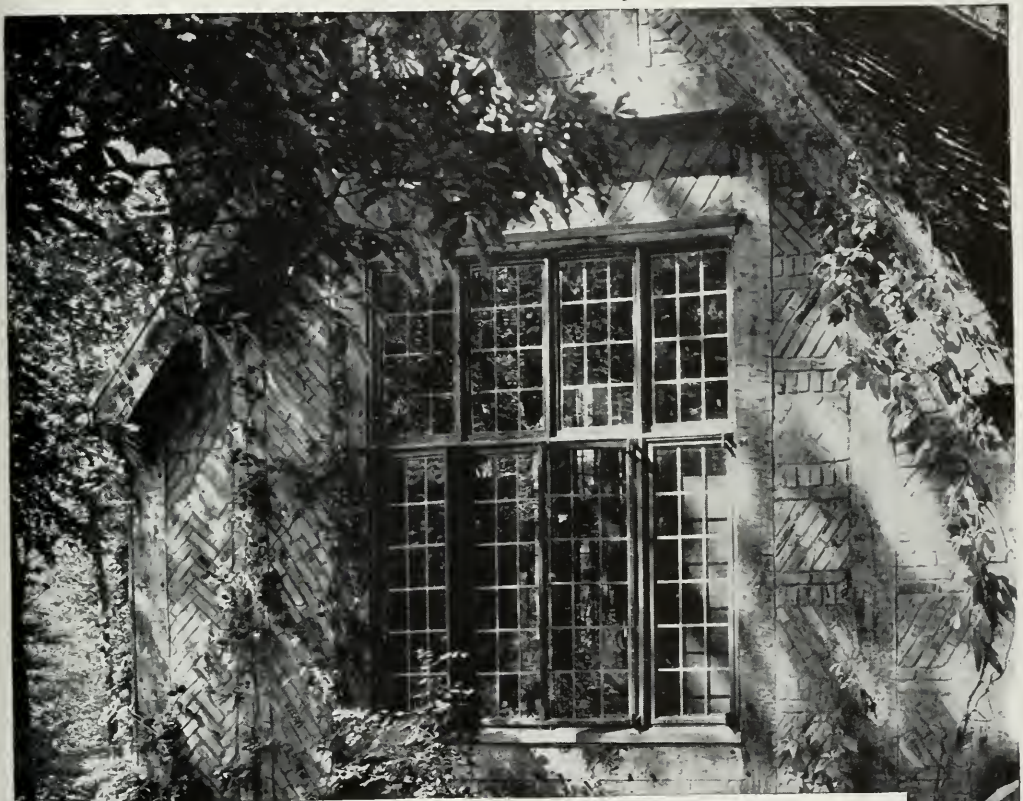

THE THIRD IN A SERIES OF INTERESTING WINDOW TREATMENTS

Architect . . . Franklin P. Hammond

The use of PennuERNON Window Glass assists greatly in the creation of distinguished windows. This fine glass is exceptionally clear, transparent, brilliant of finish, and reflective. Its close-knit surface texture resists wear and abrasion with unusual success. These qualities, combined with a new freedom from distorting defects, make PennuERNON Windows better windows for the modern home.

Distributed by

W. P. FULLER & CO.

Branches and dealers throughout the West

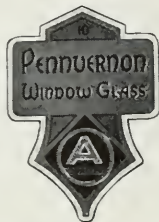

TWO BEAUTIFUL CALIFORNIA HOMES



Now architects can design livable, fire-safe, of the popular, modern trends, with practically and at comparatively low first cost—made

In the lovely Eugene O'Neill house, in the Mt. Diablo foothills, pictured above, a desired exterior treatment, made possible by the use of light weight BASALITE Concrete Masonry Units, led to the adoption of this type of construction, and the results have been most satisfying to the owners. Besides having a fire-safe home, the O'Neills have a livable, good looking house, outstanding for its matchless coloring and beautiful textures. Its structural stability and superior insulation are additional features obtained by the use of Basalite Concrete Units.

"BASALITE" CONCRETE UNITS ARE MANUFACTURED BY

BASALT ROCK COMPANY PLANT AT
NAPA, CAL.

BUILT OF BASALITE CONCRETE UNITS



quake resistive, termite-proof houses in any unlimited range of colors and surface textures possible by **BASALT MASONRY CONCRETE UNITS.**

In "The Californian," illustrated on this page, one sees a model house that was designed and built to answer the every need of present day home owners. The house has good design, structural stability, slow depreciation, splendid insulation, fire-safe, termite proof, lower upkeep costs, quiet—no outside noise or reflection from interior walls, and finally, reasonable first cost. The concrete walls and floors are **BASALITE UNITS**, permitting a wide choice of color and texture for the walls, both inside and out, and most any type of floor covering—hardwood, rugs, linoleum, rubber tile or terrazzo. Roof is Basalite cambered shingle tile, weathered shake color.

"BASALITE" CONCRETE UNITS ARE MANUFACTURED BY

BASALT ROCK COMPANY PLANT AT
NAPA, CAL.

CORRECT TEMPERATURES IN THESE OUTSTANDING BUILDINGS WITH "Control by Johnson"



Above: Terminal Bldg., San Francisco-Oakland Bay Bridge, Board of Consulting Architects, Pflueger-Donovan-Brown, architects, G. M. Simonson, consulting engineer, Scott Co., heating & ventilating contractors.
Below: Administration Bldg., San Francisco Airport. (Now being used for Golden Gate Exposition). G. W. Kelham, architect, Leland & Halsey, consulting engineers, W. A. Aschen, heating contractor.



Those who were responsible for planning and erecting these outstanding buildings on San Francisco's Bay established no precedent when they arranged for the installation of automatic temperature control "by Johnson." The control of hot water heating in the Administration Building and of steam radiators in the Terminal Building, together with an automatic time-flush system for toilets, is representative of Johnson installations up and down the Pacific Coast and all over the continent. Johnson automatic temperature control for heating, cooling, ventilating, air conditioning, and industrial processes, may be specified with complete confidence. Johnson engineers, pioneers in the industries which they serve, can tell you about their complete line of modern devices. Ask them for detailed information.

JOHNSON SERVICE COMPANY

MILWAUKEE, WIS., AND DIRECT BRANCH OFFICES IN PRINCIPAL CITIES

SKYSCRAPERS—ARE THEY DOOMED?

(Buildings and Building Management)

The furor caused by the recent wrecking of the old Capitol Building in Chicago proves beyond question that the American public's interest in skyscrapers, though it may have seemed dormant, is far from dead. Skyscrapers are an American institution, and the average American regards them with an odd mixture of pride and complacency.

So long as nothing threatens their continued existence, he takes them for granted, and gives no thought to the problems of their owners and managers. But, when a tall building actually comes down and is replaced with a small structure, he immediately wants to know why, and begins to speculate as to the future of the other skyscrapers. Newspapermen are no exception. Skyscrapers are headline news in any city.

This intense public interest in skyscrapers is a powerful force which might materially benefit the whole industry if properly directed. But the mass of comment on the passing of the Capitol Building was harmful rather than helpful. Newspaper and magazine stories saw only the obvious things—high taxes, high operating costs, low rents, vacancies. They implied that the combination of these factors had cut down the Capitol Building in its prime, and they left the inference that other skyscrapers must soon fall into the wreckers' hands. They did not point out that the Capitol Building had outlived its economic life, that it had long paid handsome dividends, and that it was never a well-planned building.

For this omission, the reporters and editors were no more responsible than the building owners and managers who neglected to correct them. There was a golden opportunity to lay the troubles of the skyscraper industry before the reading public, and this opportunity was fully utilized, without sufficient thought as to its ultimate consequences for the industry as a whole.

Actually, the skyscraper industry is in good condition. It has its troubles, of course, but it is pulling out of them consistently, and gaining in spite of general business conditions. Occupancy is increasing, rates are trending upward, and the operating ratio is slowly improving. New construction is underway where justified, and modernization is active throughout the country. The national convention just held at Del Monte was distinctly optimistic in tone.

These facts belie the current headlines, but unless building owners and managers change some of their public relations policies, such headlines will eventually nullify the public's interest in big buildings, and will cost the industry many desirable tenants. The possible benefits of more favorable publicity are worth some serious thought.

ARCHITECT AND ENGINEER

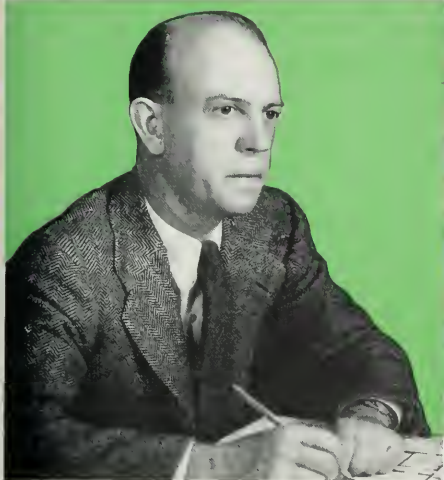

**"PLYWOOD
offers unlimited
opportunities for
simplified modern
structural and
decorative expressions
heretofore difficult
of execution in wood"**

...H. ROY KELLEY

H. ROY KELLEY of Los Angeles is one of America's outstanding residential architects. His designs have won many honors, awards and prizes, and he has served on the juries of awards of a number of important national architectural contests. His Life home last year was among the most popular of the group presented by this magazine. Mr. Kelley's homes are modern but not extreme, livable and charming, and he is quick to make extensive use of practical modern materials such as Douglas Fir Plywood.



In this beautiful residence for Mr. and Mrs. Ralph E. Phillips in San Marino, California, Mr. Kelley specified Douglas Fir Plywood for all interior cabinet work including the living room paneling shown directly above.

● Douglas Fir Plywood is one of the most versatile of all modern building materials. It is real lumber—engineered for greater size and strength. There is a grade for every purpose—wall and roof sheathing, sub-flooring, exterior siding, interior walls and ceilings, cabinet work and fine paneling, and concrete forms. Each grade is distinctively trade-marked to make specification and identification easy.

A new method using all of the grades of Douglas Fir Plywood is revolutionizing building practice. It is called Dri-Bilt with Plywood and is adaptable to

every type of residence. This method slashes building and supervisory time as much as 6 weeks... adds amazing strength and rigidity... and gives your client more house for his money.

The basic principle of the Dri-Bilt method is the use of the 4' x 8' standardized plywood panel as a module, which minimizes cutting, fitting, nailing and material requirements. For more information about this method and about Douglas Fir Plywood, consult Sweet's Catalog or write Douglas Fir Plywood Association, Tacoma Bldg., Tacoma, Wash., for free Dri-Bilt Manual.

F.H.A. has accepted Douglas Fir Plywood for home construction, and its use is approved in Uniform Building Code.



SPECIFY DOUGLAS FIR PLYWOOD BY THESE "GRADE TRADE-MARKS"

PLYMPANEL D.F.P.A.

EXT. - D.F.P.A.



DOUGLAS FIR PLYWOOD
Real Lumber
**MADE LARGER, LIGHTER
SPLIT-PROOF
STRONGER**

H A W S

Sanitary Drinking Fountains



For Public Buildings, Playgrounds
Theaters, Schools, Service Stations

Comply with requirements of the
American Public Health Association

Complete line of ELECTRIC WATER COOLERS
to meet varied conditions

HAW S DRINKING FAUCET CO
1808 HARMON STREET, BERKELEY, CALIF., U. S. A.

AGENTS IN THE FOLLOWING CITIES
NEW YORK • LOS ANGELES • SAN FRANCISCO
SEATTLE • SALT LAKE CITY • PORTLAND

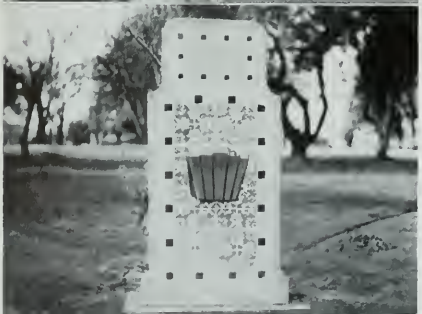
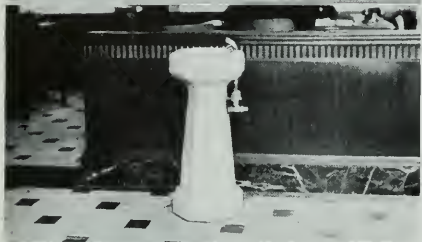
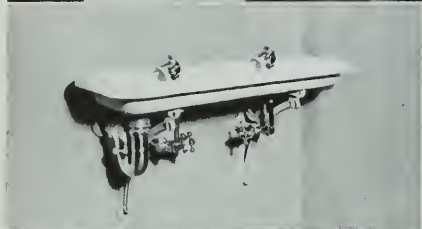



(1) The San Francisco office of the Portland Cement Association cooperated with the Basalt Rock Company, Napa, Calif., to build "The Californian." Cyril Doane, designer. Walls are of concrete masonry units, partly exposed and partly covered with reinforced portland cement stucco outside, and with reinforced cement plaster inside.

(2) Living room interior walls employ lightweight veneered concrete units having excellent acoustical properties.



Visit "The Californian"
A Modern Concrete Home at Treasure Island

STUDY this home when you go to the Fair. Take your clients along, or suggest that they see it. For here is a practical demonstration of the many advantages that have made concrete the fastest-growing type of home construction.

Concrete gives the architect full freedom in design, and a wide range of colors and surface textures with which to work.

It gives the owner a beautiful home at low first cost . . . protection against fire and storm,

termites and decay . . . minimum upkeep . . . freedom from such annoying faults as sagging walls, creaking floors and sticking doors and windows.

Let "The Californian" show you why it will pay to design your next houses in concrete. Write us for information on any phase of building with concrete.

PORTLAND CEMENT ASSOCIATION
 Dept. N7-6, 564 Market Street, San Francisco, Calif.
 Dept. 17-8, 816 West Fifth Street, Los Angeles, Calif.
 Dept. O7-2, 903 Seaboard Building, Seattle, Wash.

ALL-TILE DAIRY BUILDING AT SAN JOSE



Fully tiled facade of Royal Creamery, San Jose. Done in 6 x 9's, the face of the building is of Krafftile's carmel yellow. Borders are in night black. The entire aspect is one of neatness and reflects the sanitary conditions maintained in the dairy. Window sills, beveled and undecorated, contribute to the simplicity and cleanliness of this exterior. General contractor: H. A. Bridges; Tile contractor for exterior, Harry F. Rediker.



A band course of white in the white tile walls aids design in the main handling room of the Royal Creamery, San Jose. Walls are in Krafftile's shasta white 6 x 9's.

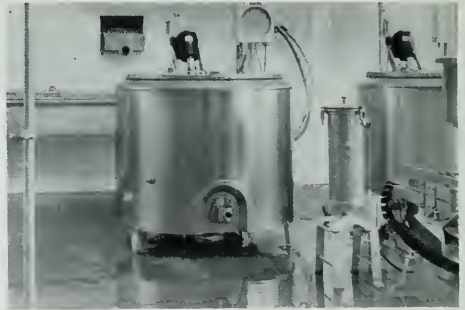

Hard usage of both floors and walls, together with need for ease of cleansing, reach a peak in dairy work. Long experience in such installation resulted in selection of Krafftile by Royal Creamery, San Jose, for its new building recently completed.

TREASURE ISLAND EXHIBIT HOME

You will enjoy an inspection trip through this Soule Uni-Bilt Steel Frame Home, on your visit to the Golden Gate International Exposition, at Treasure Island. It exemplifies the growing trend toward the use of Stainless Steel in many interesting and practical architectural applications.

... illustrates effective use of

U·S·S Stainless Steel

EMPLOYED liberally throughout this model home on Treasure Island is the newest in architectural metals — U·S·S Stainless Steel.

In the kitchen, all working surfaces, including the sink, stove, cabinet, and table tops, are of this permanently bright, easy-to-clean metal. In the living room, an attractive fireplace, and a small telephone cubicle in entrance hall, both of U·S·S Stainless Steel. In the bathroom, U·S·S Stainless trim around the shower door.

When you visit Treasure Island, be sure to see this attractive model house. It is literally packed with interesting, new architectural ideas. Notice how visitors cluster around each application of Stainless Steel. And listen to what they say about this lustrous quality metal.

You'll find stainless universally popular. Young and old alike admire its brilliant beauty and appreciate its ability to look new after years of service. After you have inspected this home, you'll agree that stainless provides new ways to make your designs more attractive, more desirable, easier to sell. Write today for complete data.

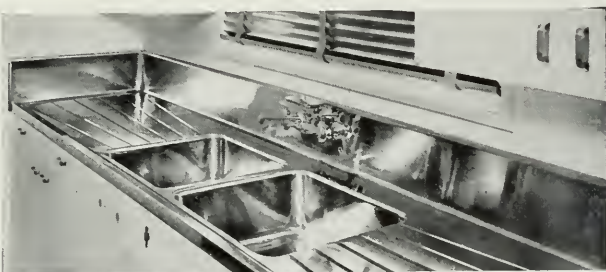

In the eyes of the modern home maker, this U·S·S Stainless Steel sink is one of the most desirable features of this model home. Cabinet, stove, and table are also topped with U·S·S Stainless.

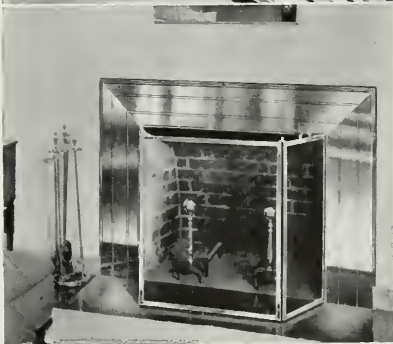

Used in this fireplace, U·S·S Stainless Steel, always easy to clean and resistant to the action of heat, will permanently enhance the beauty of this living room.



COLUMBIA STEEL COMPANY, San Francisco, Pacific Coast Distributors of U·S·S Stainless Steel

Produced by

AMERICAN STEEL & WIRE COMPANY, Cleveland, Chicago and New York

CARNEGIE-ILLINOIS STEEL CORPORATION, Pittsburgh and Chicago

NATIONAL TUBE COMPANY, Pittsburgh

Scully Steel Products Company, Chicago, Warehouse Distributors • United States Steel Products Company, New York, Export Distributors

UNITED STATES STEEL



Designed with early California ranch house adaptations by J. Upton Clowdsley, Stockton, Calif. Architect, this residence of Mr. D. R. Jacobs is planned for year-around comfort. General Contractor: H. H. Henning.

SAN FRANCISCO FAIR VISITORS: See the fascinating \$150,000 Gas Exhibit on Treasure Island in the Homes and Gardens Building.

Easy chair heating
CAREFREE WITH GAS

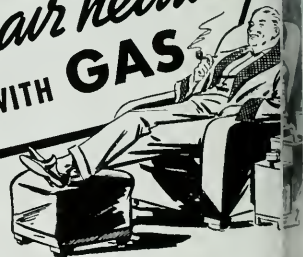

EASY CHAIR heating is workless heating, of course — and in this home the forced-air gas furnace does double duty. It is equipped with air filter and humidifier to “condition” heated air in winter, unheated air in summer. ☆ The automatic control is actuated by a thermostat in the living room and a master switch in the owner’s bedroom. ☆ Thus, during Stockton’s chilly winters and hot summers, the family enjoys uniform comfort with clean, economical gas equipment. ☆ Gas is also used for cooking and water heating. ☆ There are modern gas heating appliances ideally adapted to your needs—wherever your home, whatever its size. Your Gas Company invites free use of its technical advisory service.



LET GAS DO THE 4 BIG JOBS

HOUSE HEATING • WATER HEATING • COOKING • REFRIGERATION



AN INTERESTING item in "The Californian," concrete model home at Treasure Island, is the variety of surfaces provided over the concrete floor slab. The living room, for example, has an oak plank floor which adapts itself nicely to the Monterey furniture and the rugs. Other rooms have asphalt tile, carpet, linoleum and stained cement. The inside corridor is exposed cement, machine scored into a tile pattern, stained with Keramik stains, and finished with a transparent sealer and wax.

The loggias, pictured here, which partially enclose the patio, are also of cement, marked like flagstones, using wide joints filled with gray mortar. These are likewise treated with Keramik chemical stains in colors to harmonize with the surroundings. This treatment offers an acceptable and artistic method of handling the increasing number of concrete floors in modern houses, and offers a satisfactory coloring of porches, loggias, courts, stepping stones, and other exposed concrete surfaces.

Interesting Corners In "The Californian"

ONE OF THE OUTSTANDING
MODEL HOMES
ON TREASURE ISLAND



*A service for you
... and your clients*

As the national leader in FHA financing, Bank of America's interest in better housing coincides with that of the architect and the engineer. Finer design and better construction mean a sounder investment for the home owner, a more satisfactory loan for the bank. Your interests, as well as those of your clients, will receive the friendliest consideration at Bank of America.

Bank of America
NATIONAL TRUST AND SAVINGS ASSOCIATION
Member Federal Deposit Insurance Corporation

Keramik

Chemical Stains for Cement

were used in the

BASALITE MODEL HOME

"The Californian"

at Treasure Island



A. C. HORN PRODUCTS CO.

Fred Sumner, Manager

557 Market St., San Francisco

354 Hobart St., Oakland

Waterproofings • Hardeners • Colors • Protective Coatings

HERE'S
A BOOKLET
YOU CAN USE
PROFITABLY



In Selecting Entrance and Interior Doors Correctly

All in one catalog—Entrance Doors which are architecturally correct and meet any individual preference requirement—Interior Doors for any type of interior; includes the modern Streamliner which successfully combines strength, light weight, beauty and economy and provides numerous outstanding advantages—Garage Doors, the new economical overhead type WOCO Craw-Fir-Dor as well as conventional doors in many designs.

You shouldn't be without the important time- and money-saving facts contained in the No. 39 Wheeler Osgood Catalog if you plan, specify, build or sell. Write for your copy today.

WHEELER OSGOOD SALES CORPORATION

Factory and General Office: Tacoma, Washington
Branch Offices: Los Angeles - Dallas - Wichita - Tacoma - San Francisco
General Sales Offices: New York - Chicago
Stocks Carried in Principal Cities

The Country's Most Complete Line of Doors

the modern Hastings

STORE FIXTURES

1st Floor, Market St. Store

1st and 2nd Floors, Post and Kearny Store

Manufactured and Installed

by

S. KULCHAR & CO.

FINE CABINET WORKS

STORE AND BANK FIXTURES

MILL AND OFFICE

8TH AVENUE AND E. 10TH STREET

OAKLAND, CALIF.



BAXCO

CHROMATED ZINC CHLORIDE

CCG

PRESSURE TREATED LUMBER

● **PROTECTS AGAINST DECAY
AND TERMITE ATTACK**

Specify it in your home

Available through Lumber Dealers

LOS ANGELES

601 W. 5th Street
Phone Michigan 6294

SAN FRANCISCO

333 Montgomery Street
Phone DOuglas 3883

J. H. Baxter & Co.

AGENTS FOR WEST COAST WOOD PRESERVING CO. SEATTLE, WASH

Dependable Building Materials

- Lumber
- Plywood
- Insulation
- Shingles
- Concrete form panels
- Building paper
- Shingle stains
- Wall board
- Termite control

"Goods of the Woods"



E. K. WOOD LUMBER CO.

LOS ANGELES • SAN FRANCISCO • OAKLAND

LIGHTWEIGHT INTERLOCKING SHINGLE TILE



THE USE OF LIGHTWEIGHT INTERLOCKING SHINGLE TILE OFFERS YOU MORE THAN JUST A SUPERIOR PRODUCT. THIS VERSATILE MATERIAL WITH NO REPLACEMENT PROBLEM WILL RETAIN ITS ORIGINAL BEAUTY AND TEXTURE THROUGHOUT THE YEARS, WILL UPHOLD THE VALUE OF YOUR HOME INDEFINITELY.

GLADDING, McBEAN & CO.

SAN FRANCISCO • LOS ANGELES • PORTLAND • SEATTLE • SPOKANE • VANCOUVER, B. C.



Photo by Moulin

HOUSE FOR EUGENE AND CARLOTTA MONTEREY O'NEILL,
SAN RAMON VALLEY, CALIFORNIA
FREDERICK L. CONFER, ARCHITECT



HILLSIDE VIEW OF THE O'NEILL HOUSE, NEAR MT. DIABLO, CALIFORNIA

Frederick L. Confer, Architect

PLAYWRIGHT BUILDS UNIQUE CONCRETE HOME

EUGENE O'NEILL, playwright, and his wife, Carlotta Monterey, built this lovely home of concrete masonry units. Named "Tao House," it occupies a romantic site in the foothills of the San Ramon Valley at the base of grizzled Mt. Diablo.

The selection of light weight concrete units for the structural members of the house was determined because of their adaptability to the design. Slumped units were used for all exterior walls which accounts for the beautiful outside texture.

Mrs. O'Neill, working closely with the architect, Fred L. Confer, and the builder, Lloyd Simpson, helped to plan the house as best answered the family needs and the results have been most gratifying.

All exterior walls of Basalite concrete units are brush coated with white Portland cement paint, producing textured finish which, with the slightly irregular face of the wall units, creates a charming play of light and shadows on the walls.

Interior walls in the living room, dining room, study and guest room are treated similarly. In the living room and study and in two of the bedrooms, the walls are recessed for bookshelves.

The one-story section of the house is connected with the two-story wing by a tile-roofed walk while a walled rectangular patio encloses a neat lawn, fountain and flower beds.



ENTRANCE APPROACH, HOUSE FOR EUGENE AND CARLOTTA MONTEREY O'NEILL,
 SAN RAMON VALLEY, CALIFORNIA
 Frederick L. Confer, Architect

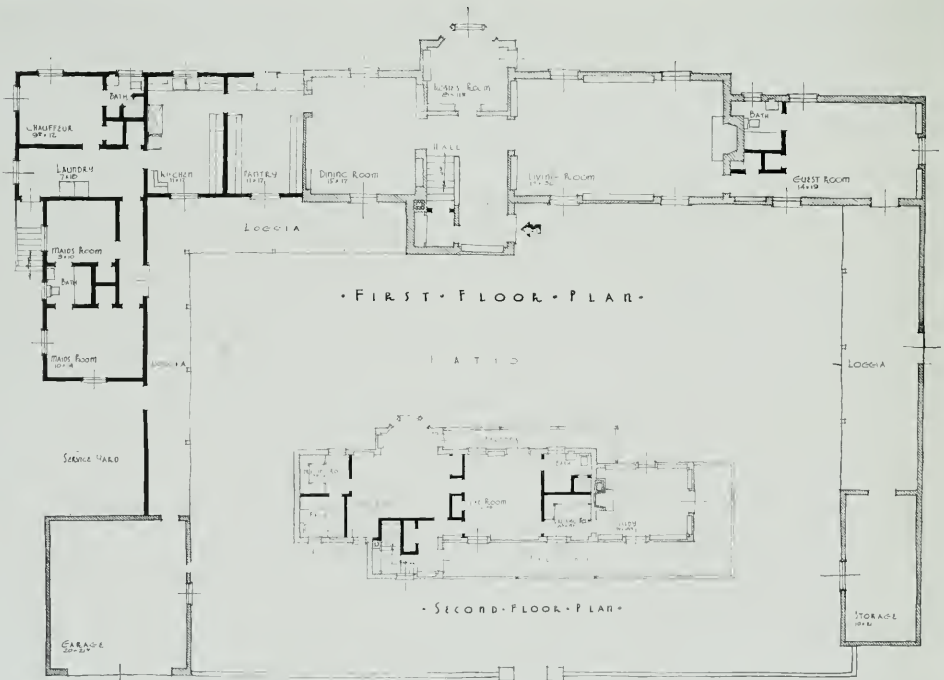

PLANS, HOUSE FOR EUGENE AND CARLOTTA MONTEREY O'NEILL,
 SAN RAMON VALLEY, CALIFORNIA
 Frederick L. Confer, Architect



GARDEN VIEW, HOUSE FOR EUGENE AND CARLOTTA MONTEREY O'NEILL,
SAN RAMON VALLEY, CALIFORNIA
Frederick L. Confer, Architect

BELOW—LIVING ROOM—THE CEILING IS DEEP BLUE





PERSPECTIVE, METROPOLITAN BUILDING, SACRAMENTO, CALIFORNIA
Douglas Dacre Stone, Architect, Lou B. Malloy

THREE RECENT PROJECTS BY DOUGLAS D. STONE

THE three projects pictured in the accompanying pages, while commercial, and handled along ultra-modern lines, differ materially in their individual treatment in that one of the buildings is entirely new, while the other two are modernization and expansion jobs, each with its particular problems to be worked out. Both alteration projects have already demonstrated the success of their undertaking.

The Metropolitan Building, planned for Sacramento, is well named, for the structure has all the marks of a big city office building. There are eleven stories designed to provide tenants with ample flexibility in office space, together with comfort and convenience. A two story ramp garage is a convenience tenants will appreciate. High speed, self leveling elevators, with a center opening pair of doors, will make for efficiency in loading and unloading.

The exterior of the building will be faced with terra cotta and bronze with a high granite base, lending distinction and dignity to the street frontage. A typical floor plan shows provision for maximum flexibility, making possible con-

venient lay-outs to suit individual needs. The entire building will be air conditioned.

The Hastings Store at Kearny and Post Streets, San Francisco, and the Fielding Hotel, are both typical examples of Stone modernization work. The architectural treatment of the outside of the Hastings Store, up to and including the second floor, is excellent but the general appearance of the two street facades has not been enhanced by the placarding of huge commercial signs across the front from story to story. In justice to the architects the display of signs was no part of their design.

The pictures, before and after, of the Fielding Hotel indicate a successful handling of a problem that called for the construction of additional floors and a modernized front without interference with the continued operation of the hotel. Fortunately when the original structure was built its designers anticipated the likelihood of additional stories and they therefore made structural provisions for carrying the weight of more floors. Since the improvements were completed the hotel has been filled to capacity.

PLAN, METROPOLITAN BUILDING, SACRAMENTO

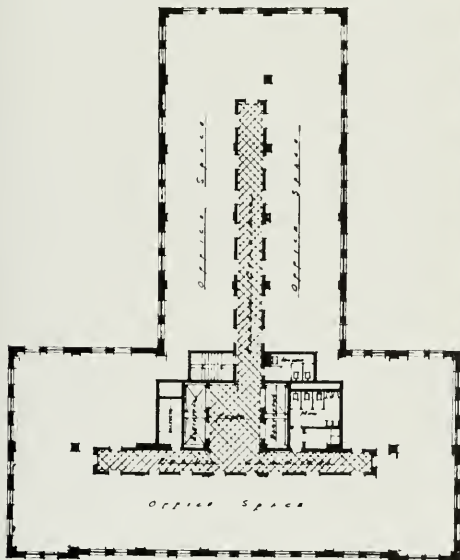

HASTING'S STORE, MARKET STREET, SAN FRANCISCO





HASTING'S STORE, POST AND KEARNY STREETS, SAN FRANCISCO
THE STORE AND EXTERIOR OF THE TWO LOWER STORIES REMODELED
Douglas Dacre Stone, Architect, Lou B. Malloy



HAT DEPARTMENT, HASTING'S POST STREET STORE, SAN FRANCISCO
SUIT DEPARTMENT BELOW

Fixtures by S. Kulcher & Co.





FIELDING HOTEL, GEARY STREET,
SAN FRANCISCO

Picture above shows original eight story building. Note wide cornice entirely eliminated in the modernized structure, shown at the right. Four floors and a pent house have been added, increasing room space about 40 per cent. The hotel remained open the entire period that the improvements were being made.

San Francisco Hotel is Modernized

DOUGLAS DACRE STONE, ARCHITECT
LOU B. MALLOY



Engineered Lighting Provides Effective Merchandise Display

By ROBERT L. DEARBORN and WM. PIERCE, JR.

THE SYSTEM of illumination employed in lighting the sales areas of Hastings new stores was designed to augment the new method of merchandise display that was worked out specifically for this firm.

The principle underlying this merchandise display method is to group and make available for easy inspection and selection all articles carried in stock. The means of doing this was to provide special display fixtures of convenient size and shape placed in systematic positions so that the customers have at all times within easy reach some group of attractive or novel merchandise. This inviting ease of inspection not only expedites sales but enables the customer to obtain quickly an accurate line on the quantity and quality of the articles he is interested in.

The purpose then of any lighting employed at these stores—besides the conventional principles of adequate illumination levels without glare, with economy of operation, architectural conformity, etc.—is to emphasize the **locations** of the individual display areas to carry out the general display principle.

This was accomplished to a marked degree on the first floor, which is devoted to the sale of shirts, neckwear, hose, shoes, hats, and small accessories. Samples of this merchandise are stacked on island cases placed systematically about the room. Concentrating and semi-concentrating mirrored-glass reflectors with crackled glass roundels were flush mounted in the ceiling and spaced to appear symmetric to

the room and still have a direct coverage of the island displays below. At some locations asymmetric types of reflectors were required to accomplish this result. The merchandise in the wall cases, mostly shirts, stacked in four tiers from waist level to above shoulder height, is illuminated by a continuous strip of "daylight" fluorescent lamps encased in specially designed reflectors. This resulted in a striking effect of high level daylight quality illumination around the sales area and added considerably, by reflection, to the general lighting in the room.

An architectural cove also using fluorescent daylight lamps and covering about two-thirds of the linear dimensions of the room was installed at a suitable distance from the ceiling to produce the necessary indirect component of illumination in the room. Also as an architectural feature and as an aid to general illumination, a ribbed and configurated glass soffit panel in bronze frame was placed in an archway separating two divisions of the main floor. Fluorescent lamps of the "daylight" type are used and colored fluorescent lamps may be used for special occasions.

Balanced wall and ceiling brightnesses have reduced sharp contrasts, eliminated glare and softened shadows. Light is directed where it will be most effective while providing for both function and architectural treatment with a minimum of waste energy.

An engineering analysis, considering the first floor as a unit, shows an average general illumination of 25 foot-candles with a maximum of 35 foot-candles and an average supplementary il-

Editor's Note—The authors are consultants in illuminating and electrical engineering and planned and supervised the lighting and electrical installation in the Hastings stores.

lumination of 50 foot-candles with a maximum of 125-foot-candles. The total connected load is 13 KW, an average of 3-1/3 watts per square foot. The system efficiency is quite high, exceeding 45% as a minimum average.

The suit department includes the entire second floor area. There are 27 island and recessed wall wardrobes, all individually illuminated by flush louvered reflector units, built into the ceiling. Windows on two exposures of the floor provide adequate general illumination to balance the direct lighting from the recessed units. Since daylight can be depended upon most of the year a considerable saving is effected over corresponding provision by artificial means. Supplementary indirect, concealed units will be used during dark winter days. The artificial lighting at the wardrobes is of the order of 20 to 30 foot-candles and increase in proportion to daylight conditions. A feature of the suit department illumination is the mirror alcove lighting. Especially designed for this installation, the reflectors are concealed above the soffit panels of configurated glass. Fluorescent, in combination with incandescent Mazda lamps, total 140 watts for each alcove and provide a quality of light which enables accurate color discrimination closely comparable to daylight. A customer may stand within a few inches of the triple mirrors and observe his full length, from toe to head, under practically uniform illumination. The average level in these alcoves is 80 foot-candles. It is interesting to note that one is not conscious of the quantity of light since glare is completely eliminated and surfaces are of low brightness. The connected load on this floor averages 2.5 watts per square foot.

The sportswear department occupies the third floor and is illuminated in the same way

as the second floor except for the fittings section. There, a softly diffused effect and perfectly uniform illumination of 20 foot-candles is provided by conventional indirect units. The credit office and bookkeeping department, occupying 940 square feet, adjoins the selling area and is indirectly lighted by luminous bowl indirect units to a level of 20 foot-candles. The connected load for the entire third floor is 3.6 watts per square foot.

Industrial type lighting is used for the fourth floor storerooms and the fifth floor tailor shop.

On the sixth floor are the executive, buyers', and general offices. Indirect lighting suffices over most of the offices. A novel method of louver design shields direct glare from the sun through a skylight (12' x 14') over the general office. The louver, developed from solar path calculations, proves to be more effective and efficient than translucent finishes or shades.

The same general principles were used in the illumination design for Hastings Market Street store. Decorative lighting effects of modern design are carefully coordinated to enhance the architectural treatment and conform to structural conditions. Recessed indirectly lighted coffers break the monotony of the large expanse of low ceiling on the second floor. These are over areas where high level illumination for merchandising is not required and where decorative treatment is desirable. A "corner ceiling" panel using new types of banded and configurated glass, fluorescent lamps, and a laboratory developed reflector system has proven to be both distinctive and efficient. A feature of the decorative luminous effects is that they also serve important functional requirements, thus improving the overall efficiency of the system.

SHOULD ARCHITECTS ENGAGE IN CONTRACTING?

By ROBERT H. ORR, A. I. A.

NOW since Architects Bill, S.B. 186, was killed in the Senate and the smoke of legislation has blown away we should take stock of what has happened, and why, during the past three or four sessions of the legislature where we have met the same fate.

For 1939 the bill as drafted by the State Board of Architectural Examiners and the Committee of the State Association of California Architects was fair and would have stabilized architectural practice in its relation to engineers, contractors and material men and would have allowed building to flow in proper channels without particularly affecting anybody except the unscrupulous. When changes were suggested and the architects, for sake of harmony, began to give way, thinking any kind of a change in the bill would be better than the present one, there was a grand attack by several groups to protect them, as they thought, from all kinds of imaginary impositions which they considered the bill contained.

Emerging out of the "Grand Father" age, "Architect and Builder," over years of practice the architects have sought and gradually eliminated certain practices with the object in view of discouraging any attempt on the part of the architects to usurp the prerogatives of the builder by the segregated contract methods or entering into the contracting business. It has appeared, in recent years, that architects with the segregated system in mind were getting fewer and fewer and recognizing that architecture was a profession and building a business, in the interest of fair play the architects were calling upon reputable firms of builders to

handle the construction work. Perhaps this trend is really in the wrong direction.

With the construction of an overwhelming amount of small work now under way, which neither gets into the architect's office nor the reputable contractors, there has entered into the construction field a multitude of contractors, many of whom cannot qualify for building under the requirements of an architect's plans and specification, hence they must, in order to exploit their existence as builders, steer a course away from the architect and in direct competition with him in that they must seek means of having plans prepared by others and by doing so revert back in a sense to the age of "Architect and Builder" which we thought was buried when the act to practice architecture came into effect.

If the owner is willing to invest in building enterprises, as many of them do, with an incompetent designer and an incompetent builder, how much better would he be with a competent designer though he be an inexperienced builder but one who is fitted to give better service because of his technical knowledge of building materials and building construction. In other words it would seem that the attempt to solve the small house problem for the architect has been leading in the wrong direction. Why not about face and solve the right of an architect to work out his existence and permit him to earn a living wage? To this end there should come about a reversal of policy for architects doing small house work or for the young architect that is beginning his practice. He should be encouraged and advised to enter

the contracting field as well as the practice of architecture. By doing so he will obtain a better knowledge of actual building and gain such proficiency that the command for his professional services will eventually permit him to withdraw into a more strictly professional practice.

Certainly there can be accomplished these objectives:

1. The young architect or the one who follows small house construction exclusively by combining the architectural fee, though it may be small at the beginning, and must be in the field of small house work, with that of the builder's profit would receive enough to compensate him for his services, even if the jobs are few. Under present competitive conditions, brought on by the speculative builder and the contractor who does his own designing, it is difficult for the young architect to earn a livelihood while building a professional practice for the future.
2. The young architect would in this way gain an experience in actual building methods and business management that would be invaluable to him in his after years of practice and he would be able to talk with authority upon building subjects and far more intelligently than those whose training is purely academic.
3. Then too the young architect may find that after all the business of building is more fitting to his ability to perform and more

lucrative than the practice of architecture and in that way there would be brought into the field of building a generation of master builders of a type that has been spoken of in ancient history and seldom found in the building industry of today.

This is not a mere fancy; it is a real issue that has been brought about by a short sighted policy and it must be met not merely by a challenge but by a well worked out policy of actually doing some constructive thinking and acting. The State Association of California Architects will do well to give this a place in their scheme of professional outlook for the betterment of architectural practice and building methods at the coming Convention.

This procedure would not in any way be a violation of professional practice and in order to encourage the young practitioner and help him on his way, a revolving fund should be set up by the State Association to pay for the contractors license which would be refunded as the business of the individual would permit.

It is suggested that constructive criticism be submitted by the members as a guide for future consideration. The State Association of California Architects, Southern Section, in executive session, has considered and is open to the suggestions made herein and will proceed to work out a program for presentation to the coming October Convention that will be fitting to the occasion, should the response of the membership to this article indicate sufficient interest in them.



COURT HOUSE ANNEX, REDWOOD CITY, SAN MATEO COUNTY, CALIFORNIA

William H. Toepke, Architect

NEW ANNEX TO REDWOOD CITY COURT HOUSE

IN THE recently completed Annex to the Redwood City Court House, San Mateo County, California, modern facilities for civic government efficiency have been provided. The building itself, designed by Wm. H. Toepke, is of Neo classic architecture, dignified and substantial in appearance, its facade embellished with bas-relief in full size—one group representing Father Junipero Serra and his Spanish and Indian followers; the other the Argonauts of '49.

The building is constructed of reinforced concrete, Golden Gate cement, with plywood forms and plaster waste moulds. All exterior walls are brush-coated and lightly sand-dashed.

The interior of the building is divided into offices for the various county officials with the Assessor and Tax Collector convenient to the public on the ground floor, and quarters for the District Attorney, Purchasing Agent, Treasurer and Controller on the second floor. An unusual feature of the Treasurer's office is a

"bandit barrier" which delivers money, checks, etc. through a bullet proof partition. On the third floor are the Supervisors' chamber, committee rooms and offices for the Building Inspector, Planning Commissioner and County Engineer.

The building covers a ground area 62 by 160 feet and adjoins the old court house, still in use. A feature of the interior equipment is a semi-automatic telephone system requiring no operator. Floors in the main corridor are terrazzo inlaid with brass strips to form patterns. All other floors are linoleum covered. Special attention has been given to the acoustical treatment of the different offices, the ceiling areas being treated with acoustical material.

The general contractors of the building were the H. H. Larsen Construction Company of San Francisco while the plastering and lathing was done by Peter Bradley.



COURT HOUSE ANNEX
REDWOOD CITY

W. H. TOEPKE,
ARCHITECT

Left page: Detail of facade, showing panel of figures in full size bas-relief. One of the panels depicting Father Junipero Serra and his Spanish and Indian followers, is shown in detail.



Right: Main office corridor.
Below: Supervisors' room.
Walls are treated with Empire acoustical plaster for sound control.



BUILDING REPORTS FOR JULY SHOW UPWARD SWING

IN response to repeated requests from subscribers for dependable information on actual monthly building trends in Northern California, the Architect and Engineer has compiled a summary of building activities for July from information contained in "Architects Reports," together with a breakdown of the estimated total expenditures under three classifications. A detailed item-by-item report is on file in this office for further reference if desired. It is planned to publish this summary as a regular monthly feature and later it will be possible to show some interesting and valuable comparisons of increase or decline in local building volume. The totals are taken from information gathered by "Architects Reports" own staff and includes projects reported under the headings: "Plans in Progress in Architects' Offices," "Plans Completed or Advertised for Bids," "Contracts Awarded." The territory covered is California as far south as Bakersfield and the State of Nevada. July summary shows a total building volume of \$22,526,746 for building construction jobs of \$10,000 or more. Naturally there is a preponderance of smaller work, from \$500 up to \$10,000, all of which was reported during the month but which is not included in this summary because of the immense amount of labor and time involved in tabulating, and lack of available space.

Plans in Progress	Estimated Cost
Churches	\$ 80,000.00
Public Buildings	1,383,000.00
Residences	88,500.00
Schools	1,865,000.00
Store Buildings	25,000.00
Theatre Buildings	146,000.00
	\$ 3,587,500.00
Plans Ready for Bids	
Public Buildings	\$5,556,500.00
Schools	267,000.00
Industrial Buildings	4,755,000.00
Residences	85,500.00
Store Buildings	108,000.00
Apartments	16,000.00
Office Buildings	40,000.00
	\$10,828,000.00
Contracts Awarded	
Apartments	\$ 148,000.00
Store Buildings	254,846.00
Schools	2,471,216.00
Public Buildings	2,322,981.00
Residences	516,842.00
Industrial Buildings	948,284.00
Mortuaries	56,000.00
Banks and Office Buildings	1,248,230.00
Churches	94,847.00
Clubs, Hotels and Theatres	50,000.00
	\$ 8,111,246.00
 Grand Total	 \$22,526,746.00



PALM SHADED
HAWAIIAN
BUILDING
AT
TREASURE
ISLAND



NIGHT VIEW OF "THE CALIFORNIAN"

ALL-CONCRETE MODEL HOME AT TREASURE ISLAND

By E. BROVELLI

"THE CALIFORNIAN" is the colorful name given a well designed and most interesting concrete home lately opened to the many thousand visitors at the Golden Gate International Exposition on Treasure Island. The name "Californian" is not only typical of its style but of the materials with which it is built. In using Basalite concrete blocks for both outside and inside wall construction, a California product, developed in one of the largest concrete plants in the state, at Napa, the designer, Cyril Doane of San Francisco, was able to demonstrate the practical efficiency of this material, structurally and ornately. The rambling type of building, as may be noted from the pictures, is typical of the California ranch house, symbolizing comfort, livability, permanence and beauty.

From the illustrations it will be noted that the floor plan is in the form of an open "U" or semi circle, providing an attractive patio and outdoor loggia, appointed with a grill and convenient seating arrangements, suggesting the enjoyment of the out-of-doors.

The outside wall construction is of two types. One wing is built of 7 inch electric welded steel mesh reinforced wall construction, plastered and stuccoed on the interior and exterior, respectively. The remainder of the exterior walls are the 8 inch internally reinforced column and beam Basalite construction, giving a wall thickness of 8 inches with units 4 inches high and 16 inches long. The mortar was allowed to exude at the joints and the entire structure was covered with a Spanish white cement paint, giving the masonry the appearance of old adobe.

An unusual treatment of the interior walls in the living and dining rooms consists of an acoustical veneer which not only presents an attractive, textured appearance but affords excellent sound absorbing and acoustical properties, the latter readily evidenced by a feeling of quietness upon entering the rooms. The interior finish of the remaining rooms show hard-wall plaster, painted, in the kitchen, and wall paper in the bedrooms.

The floor system in the living and dining rooms is concrete slab construction with Basa-



STREET VIEW, "THE CALIFORNIAN," MODEL HOME, GOLDEN GATE INTERNATIONAL EXPOSITION, TREASURE ISLAND

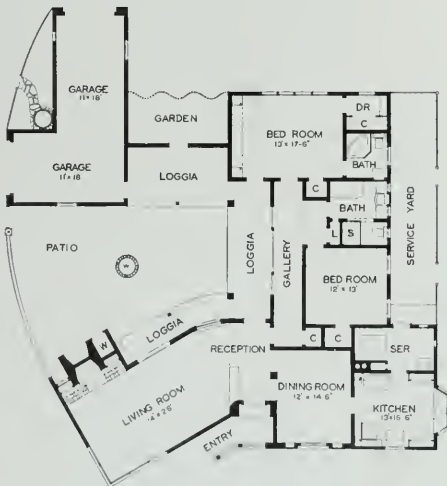

PLAN OF "THE CALIFORNIAN," MODEL HOME

lite concrete sleepers, to which are nailed the floor joists and finished with random hardwood plank. The remaining rooms are of finished concrete, the kitchen and bathrooms being covered with linoleum and the bedrooms with carpeting.

The roof is covered with Basalite cambered shingle tile, made of Portland Cement concrete, weathered shake design, the rugged appearance of which appropriately harmonizes with the structure and provides a permanent roof covering.

Visitors to this home leave through the two-car garage wherein may be inspected various masonry panels showing the structural and construction details of the system.

Advantages claimed for the type of construction as demonstrated in "The Californian" are proof against fire and termites, resistance to earth stresses and protection from excessive heat, cold and sound waves.



PATIO, "THE CALIFORNIAN," GOLDEN GATE INTERNATIONAL EXPOSITION, TREASURE ISLAND

LIVING ROOM, SHOWING TEXTURED WALLS OF ACOUSTICAL VENEER OVER CONCRETE UNITS





LOOKING TOWARDS THE DINING ROOM, "THE CALIFORNIAN" MODEL HOME, TREASURE ISLAND

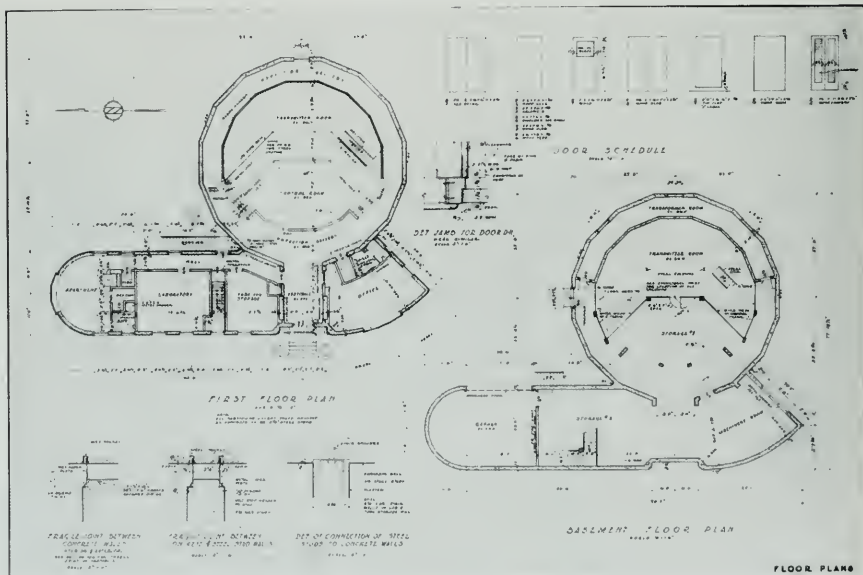

PLANS, TRANSMITTER STATION FOR RADIO STATION KNX, COLUMBIA BROADCASTING SYSTEM, LOS ANGELES

TWO INTERESTING PROJECTS IN SOUTHERN CALIFORNIA

PICTURE ON THE RIGHT SHOWS A RECENTLY COMPLETED ADDITION TO THE BROADWAY-HOLLYWOOD STORE FOR THE BROADWAY DEPARTMENT STORE, INC.

BELOW—TRANSMITTER BUILDING, RADIO STATION KNX, FOR THE COLUMBIA BROADCASTING SYSTEM, LOS ANGELES, CALIFORNIA

JOHN PARKINSON AND DONALD B. PARKINSON,
ARCHITECTS





A STUDY IN THATCHED ROOF, HOUSE FOR MR. AND MRS. CARL W. REBMANN,
BELVEDERE ISLAND, CALIFORNIA

A HOST'S SHORE HOUSE IN CALIFORNIA

By HENRY H. GUTTERSON, Architect

ON THE beautiful island of Belvedere, looking out the Golden Gate, stands this retreat, as envisioned by its owner, Carl Rebmann, San Francisco restaurateur. Memories of his childhood in the hill country of Germany were drawn upon and combined with long associations with and desire for a bit of the bay shore in selecting the romantic site. A wooded ravine emerging high above a private beach offered a house site that contained all that was important for recreation and inspiration. There were pungent eucalyptus and the native live oaks, bays, buckeyes and toyons for shelter and all manner of shore plants as the basis of a natural garden; there was the water with hosts of gulls, cormorants, ducks and pelicans in a natural fishing ground to provide entertainment—and there was as beautiful and varied a panorama as this world affords—Mt. Tamalpais on the north along the fog-capped hills dotted with small towns



VIEW FROM SOUTH

rising from the Richardson's Bay shore, and on the south that great new bridge spanning the strait and framing visions of the Orient beyond.

To utilize these assets and yet leave the native informality and charm for his many friends and his family was the task this client delegated to his architect. The precedents to be followed in building were indistinct as to detail but definitely tied to the simplicity and hospitality of rustic rural life. A release was sought from the artifice and confusion of the city. Finally certain furnishings and favored decorative effects were in mind to personalize the development.

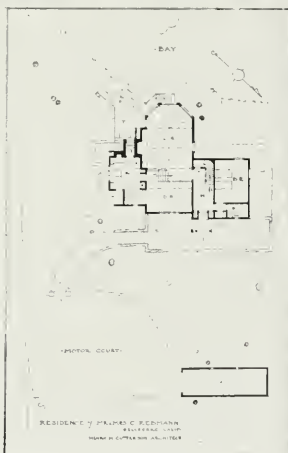

PLANS, HOUSE FOR
CARL W. REBMANN,
BELVEDERE
Henry H. Gutterson
Architect

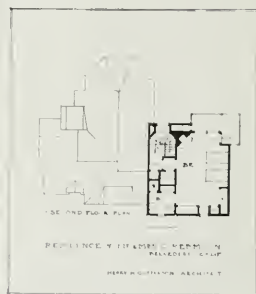

HOUSE OF MR. AND
MRS. CARL W.
REBMANN, BELVEDERE
ISLAND, CALIFORNIA

HENRY H. GUTTERSON,
ARCHITECT

THIS PAGE—RIGHT: DIN-
ING END OF LIVING
ROOM.

BELOW: LIVING ROOM
FIREPLACE.

OPPOSITE PAGE—TOP:
BAY END OF LIVING
ROOM.
BELOW: OWNER'S BED-
ROOM.



It became a task to compose such a unique ensemble but the owner's vision and tenacity of purpose finally overcame all of the difficulties inherent in getting plans, specifications and construction completed by means of patient, interpretive and cooperative efforts. The sand-blasting of rough newness in timber work and trim, the instruction to carpenters in the all but lost art of applying thatch roofs, the utilization of the local European gardeners for the laying of garden steps and stone work, and a general willingness of all concerned to find his viewpoint, led to success.

The living room, with its bay window, commands the panorama through three great openings. The massive fireplace of basalt blocks, (also sand blasted) is fitted with copper hood and special wrought iron equipment, and flanked by leather cushioned seats. The garden end is a dining space elevated to the level of the quaint kitchen. A bricked-in range with hood opening out through a high window, a roasting spit, an old-fashioned hand pump, quaint table set up in the leaded-glass bay window looking into the woods, and a red quarry tiled floor, characterize this room. Both living room and kitchen open onto the southwest terrace, prepared for out-of-door living.

The guest bedroom and bath are off the entrance hall on the first floor. Over it is the owner's apartment with sun balcony and fireplace to make it complete. Servants quarters, heating plant and work shop are in the basement, yet well above grade.

The exterior is a happy composite of timbered stucco, redwood boarding and used brick, crowned by a fire-proofed thatch of imported reeds reinforced with asbestos lining sheets and wired with copper to the frame. Its color is a tawny brown harmonizing with the earth colors and helping to hide the house away in its hollow. Needless to say it is very difficult to photograph—one of the best views being had only from the old fishing boat that lies on the placid water below.



A PAGE OF BOOK REVIEWS

ETCHINGS -- NEW YORK WORLD'S FAIR: Gordon W. Gilkey, M. F. A., Charles Scribner Sons Co., Fifth Avenue, New York, N. Y.; Kennedy and Company, Official Print Publishers, 785 Fifth Avenue, New York, \$5.00.

This constitutes, according to the official publishers, the only fine art record of the New York World's Fair. The harmony, design and beauty of this Exposition is brought out most vividly through the medium of the etcher's art in this volume.

It will remain as a living thing long after its buildings are gone, and its gardens erased. The pagantry built up as the Fair progressed in construction is here shown in a manner calculated to give the whole perspective of a gigantic undertaking in which beauty and utility have been happily combined.

STEEL SQUARE: by Townsend; American Technical Society, Chicago, Ill. \$1.50.

Another of the excellent series of technical hand books published by this society. Aptly gives the definite information always needed by the users of instruments of precision. Concise and clear in its application to the details surrounding the correct uses of the steel square, this book should prove of great value to the architect as well as to the members of the building trades.

BUILDING CODE OF CALIFORNIA: Edwin Bergstrom, Editor; Prepared for the California State Chamber of Commerce, San Francisco. Price \$5.00.

A new volume of the building code prepared through the contributions of the committees representing the American Institute of Architects, Northern and Southern California Chapters; the State Association of Architects (California); American Society of Civil Engineers, Northern and Southern California Chapters; General Contractors of San Francisco and the Southern California Chapter of the Associated General Contractors of America.

The work is based on accurate and detailed studies made by these

contributors and represents a vast amount of research and painstaking work. As a guide and reference book the code should be indispensable to the architectural and engineering professions and building trades. It will very materially assist in clearing up obscure rulings governing building in California, and the adherence to the specifications herein contained should lead to better building and freedom from much unnecessary controversy.

POISONOUS PLANTS OF THE UNITED STATES: By Walter Conrad Muenscher; Macmillan Publishing Co., 1939.

Mr. Muenscher has made a most comprehensive survey of plants poisonous to both dumb animals and humans. Plants are classified according to the family to which they belong and if one wishes one can find that the simple, unassuming English Ivy, (*Hedera helix*) is poisonous, that children have been poisoned by eating the berries and that in Europe animals have been poisoned by browsing on its leaves. In fact, we find that contact with the leaves occasionally develops "dermatitis with severe blistering and inflammation" among some individuals.

Whether or not one intends to put this information to some practical use, such as designing a garden wherein children and animals will not munch a poisonous leaf or eliminating certain plants from grazing grounds, it at least teaches everyone that it is unwise to munch heterogenous and unselected plants.

Mr. Muenscher takes pains to classify the types of poisoning, among which are dermatitis, photosensitization, cyanogenetic plants and so on far beyond my limited vocabulary. Certain plants are not poisonous (in the case of photosensitization) unless the individual eating them exposes his skin to the sun; under certain conditions animals could go on eating the poisonous St. John's wort indefinitely without becoming ill and again, on flexing his muscles in the sun, would suddenly find himself running a high temperature. Or again, you might absent-mindedly swallow a few leaves of *Prunus serotina* (wild black cherry) along with the

berries and suddenly find yourself with a pleasant dose of prussic acid in other words, you swallow leaves of a cyanogenetic plant, one that, under certain conditions, produces hydrocyanic acid.

In fact, the more I poke around in the book, the more I find. For instance, Socrates drank a brew of poison-hemlock (*Conium maculatum*). This was a rather refined plant poisoning, inasmuch as death is caused from a gradual paralysis of the lungs while the mind remains clear and the only evidence appears to be a general and gradual lessening of muscular power. In administering the more elite type of death, this should not be confused with water hemlock (*Cicuta maculata*) which produces violent convulsions and other uncomfortable symptoms.

Even over at Treasure Island we can find many causes of poisonous plants—the beautiful *Rhododendrons* in the Court of Flowers, for example, might cause, if eaten, convulsions and paralysis of the limbs. The *Oleanders* in the State area, if eaten, would probably produce "respiratory paralysis, and death."

There is no intention in this review of making the reader feel that death is stalking him in every flower bed, every tree and every branch that casually brushes his forehead or knocks the hat off his head. Far from it, it is more the intention to tell of the value of the book; and I do not think the average human would run out to his garden and make a stew of *Daphne*—in the first place it would be too bitter and in the second place it would hurt his garden, as well as his stomach.

But definite value does come in the matter of farming and landscape design. A rancher would like to eliminate those plants in his fields that are likely to cause poisoning through browsing. A gardener would not want to plant St. John's wort in his children's playground any more than a landscape architect would like to put a hedge of poison Hemlock around his client's stables. For anyone interested in gardens, gardening or plants the book is extremely valuable, practical and, in fact, almost a necessity.

CONGRESS OF ARCHITECTS AND A. I. A. CONVENTION

THE UNITED STATES is honored in having been selected as the place of meeting of the Fifteenth International Congress of Architects which will assemble at Washington, September 24, at the invitation of President Roosevelt.

The significance of this event has excited both the interest and the hospitable disposition of the architects of the country.

The hope is confidently entertained that a reasonable professional curiosity about the United States, its institutions and its architecture, stimulated by the immediate attraction of the great expositions at New York and San Francisco, will insure the presence of a significant representation of the architectural profession of other countries. Particularly now, when architectural thought is becoming more and more impatient of national boundaries, the opportunity to examine the essays of the profession in the characteristic problems of a new society may promise a valuable experience.

Themes for discussion at the Congress were chosen by the Comité Permanent International des Architectes because of their timeliness and immediate significance to the profession. They are grouped under three headings: Town Planning, Technical, and Professional.

The Washington program has been planned so that delegates may derive the most enjoyment and benefit from their visit. The Congress will officially convene on Sunday, September 24, with meeting of the Executive Committee (Bureau) of the Comité Permanent International des Architectes and a business session of the Comité, for members of the various Sections only. Registrations will begin on this day.

The annual convention of the American Institute of Architects will be held in Washington concurrently with the Congress.

The provisional program follows:

SUNDAY, SEPTEMBER 24

- 9:00 A. M. Executive Committee (Bureau) Comité Permanent International des Architectes.
- 10:00 A. M. Business session of the Comité, for members of the various Sections only.
- 11:00 A. M. Registration begins.

MONDAY, SEPTEMBER 25

- 11:00 A. M. Formal opening of the Congress, followed by luncheon.
- 2:00 P. M. Discussion of Theme I.

Town Planning

Theme I: Planning and Development of Rural Districts.

- a) A unit of land ownership, a farm, the first element in agricultural production.
- b) A country town, the group of buildings created by local, social, and economic needs.
- c) A rural district, the region affected by all the economic problems of the state or country.

5:30 P. M. Afternoon tea.

9:30 P. M. Reception by The American Institute of Architects.

TUESDAY, SEPTEMBER 26

9:30 A. M. Business session for discussion of Theme II.

Theme II: The Relation Between Population Density and Built-up Area.

- a) Low buildings and high coverage.
- b) High buildings and low coverage.

2:30 P. M. Visits to galleries, museums, and Government buildings.

5:00 P. M. Garden party and tea given for official delegates.

9:30 P. M. Reception of all delegates, their families, and friends at the Pan American Union Building.

WEDNESDAY, SEPTEMBER 27

9:30 A. M. Business session for discussion of Theme III.

Technical

Theme III: Contemporary Architecture Compared to the Architecture of the Past.

- a) From the technical point of view.
- b) From the aesthetic point of view.
- c) From the social point of view.

2:00 P. M. Business session for discussion of Theme IV.

Professional

Theme IV: Consequence of the Participation by Government, whether Federal or Local, and/or by Private Enterprise, in the Preparation of Plans and the Carrying Out of Building Operations.

- a) On architecture in general.
- b) On the normal practice of the profession.

8:00 P. M. Banquet tendered to the official delegates by the Government of the United States, which all participants may attend.

THURSDAY, SEPTEMBER 28

9:30 A. M. Business session for discussion of Theme V.

ARCHITECT IS GIVEN FREE HAND HERE



RESIDENCE OF L. P. SINZ, SOUTH PASADENA, CALIFORNIA
Robert H. Ainsworth, Architect

IN PLANNING this home, the architect was unusually free of restrictions governing layout and design. The property to be fitted was flat in contour and generous in size, leaving the problem one of creating an inviting, homelike atmosphere, based upon economical use of space into which the garden must play an important part. For that reason the living room and its adjoining sun porch, as well as the breakfast room and kitchen working space, opens directly to the garden, providing not only an inviting outlook from each of these rooms, but direct access to the porch for outdoor breakfasts and informal entertaining.

The kitchen space was planned with careful consideration for convenience. A gas range and quiet gas refrigerator were placed at either end of the counter and sink, and the breakfast group was located at the opposite end of the room to avoid all direct lines of travel and to provide early morning sunshine and unobstructed view of the garden. A gas unit furnace heats the rambling floor plan with finger-tip convenience, and a storage water heater assures plentiful hot water.



ALL-GAS KITCHEN

The guest room is so arranged that it may be readily converted into a library opening into the living room, thus providing another garden room for family activities.

Theme V: Should public authority be clothed with power to reject plans as artistically unsatisfactory rather than as at present for purely technical reasons only?

Study A: The architect's copyright.

Study B: Comparison of the remuneration received by architects in the different countries.

Dinner and night on river boat.

FRIDAY, SEPTEMBER 29

8:00 A. M. Breakfast on shore, then by bus to Williamsburg.

3:00 P. M. Visits to nearby places of interest, return to boat. Dinner on boat, depart for Washington.

SATURDAY, SEPTEMBER 30

8:00 A. M. Arrive in Washington. Breakfast on boat. Visit to Greenbelt.

SOUND CONTROL FOR OFFICE EFFICIENCY

By REX E. HIERONYMUS

THE overall benefit to be expected from an installation of acoustical treatment for quieting office noise will necessarily depend on a number of factors, such as the intensity of the original noise, the amount by which it is reduced, the number of people affected, and the extent to which the noise interferes with the various types of work carried on. In general, it may be said that noise quieting treatment is fully warranted in any general office space having the usual distribution of employees' desks, and containing typical noise sources, such as typewriters, telephones, accounting machines, street noise, and average conversation.

The typical general office space is finished throughout with materials which reflect over 95% of the energy of the sound that strikes them. When any sound is made in such a room, the sound waves are reflected back and forth hundreds of times by the interior surfaces, with two results. First, while the original sound is being produced, as by a typewriter in continuous operation, the room almost instantaneously becomes filled with reflected sound which has an intensity at every point in the room nearly as great as the intensity a foot or two away from the sound source. At points some distance away from the sound source, the intensity is many times greater than it would be if there were no reflecting surfaces. Second, even after the sound source is stopped, the reflected sound waves continue to travel through the room, and can be heard for several seconds before they die out to inaudibility. This persistence of sound is called reverberation.

These two effects combine to produce what may be called the "noisiness" of an office. This "noisiness" is partly physical and partly psychological. Physically, each employee is subjected to much more noise than that which reaches his ears in a direct line from the various noise sources in the room. This noise reaches him from all directions, regardless of the actual

location of the source, and still persists after the source is stopped. Psychologically, the employee has the impression, consciously or subconsciously, of being swallowed up in a sea of unnecessary noise which presses in on him from all sides, and which he is powerless to resist. His feeling of uneasiness is increased by the fact that it is difficult to localize individual noise sources, that is, estimate their direction and distance from him. To top it off, every noise is not only louder than it should be, but even lasts longer than it should, due to reverberation.

Treatment of the ceiling of an office with an efficient acoustical material alleviates the harmful psychological effects outlined above by changing the physical picture. In a properly treated office, the average sound intensity in the room is materially reduced, the intensity of any single sound source drops off much more rapidly as one moves away from it, with the result that distant noise sources are much less apparent than before, and the reverberation is reduced to the point that prolongation of individual noises is almost imperceptible. The employee now receives the impression that the noise in the room has not only been reduced in loudness, but "pushed back" away from him and that it now has a muffled, distant quality. The increased ease of localizing various noise sources makes it easier for him to subconsciously exclude them from his attention. He still hears noise, of course, but the office now seems to him "quiet" rather than "noisy." This contrast, both in the loudness and quality of office noise, very frequently elicits the statement by employees and office managers that "the noise seems to have been cut in half."

OFFICE ACOUSTICS A PAYING PROPOSITION

The physical and psychological effects of noise are definitely harmful, the expenditure of energy required by an office worker to combat these effects reduces his working efficiency. Tests made by the Aetna Life Insurance Company over a period of more than two years,

A paper by the author at the Del Monte convention of the National Association of Building Owners and Managers.

prove that quieting office noise with acoustical treatment pays for itself many times over, not only in increased efficiency, reduction of errors and decreased employee turnover and absences, but also in the less tangible but equally important asset of improved relations between employer and employee. The advantages of acoustical treatment from the building owner's and manager's standpoint, and its ability to pay for itself in increased rentals, are becoming increasingly evident in recent installations.

The relative noise quieting efficiency of an acoustical material is indicated by its "noise reduction coefficient" given in per cent. This coefficient is the average, to the nearest 5%, of the sound absorbing efficiencies of the material measured at the four sound frequencies 256, 512, 1024, and 2048 cycles per second. The degree of quieting achieved in a given office space depends both on the noise reduction coefficient of the material used, and on the per cent of the total wall, floor, and ceiling area which is treated. The quieting effect does not follow either of these factors directly, but instead reaches a point of diminishing return, when either the efficiency of the material or the area of treatment are increased beyond a certain point.

SMALL OFFICES WITH HIGH CEILINGS

It figures out, roughly, that for a general office space of 1000 sq. ft. floor area or more, and of average ceiling height, treatment of the entire ceiling with a material of 60% to 80% noise reduction coefficient gives the most satisfactory degree of quieting consistent with reasonable cost. Treatment of only part of the ceiling, or use of a less efficient material would be liable to give unsatisfactory quieting results. The use of a more efficient material, or treatment of walls in addition to the ceiling, would give more quieting, which, however, would not be proportional to the additional cost.

In the case of offices smaller than about 1000 sq. ft. or offices of about this size, but with high ceilings, the percentage of the ceiling area alone to the total interior area is small, and additional treatment on the walls is usually

necessary to get satisfactory results. For such wall treatment, a material having a coefficient as low as 50% is quite acceptable.

As stated above, acoustical treatment is of most value in general office spaces containing the usual noise sources. There are two other types of room in which it may not be as effective. One of these is the luxuriously furnished private office. In this case, the heavy carpet, the window drapes, and the overstuffed furniture all furnish considerably more sound absorption than the bare floor and walls and hard furniture in the general office, so that the private office is in effect already acoustically treated. The addition of acoustical material will therefore produce less change in the room than it would if there were no absorbent furnishings, and this change may not be enough to be considered satisfactory. Moreover, it is unlikely that there would be any noise sources in the private offices such as to set up an uncomfortably high noise level.

The other case is that of a room containing extremely noisy machines which set up a deafening noise level. Such a room should be quieted as far as possible by treating all the walls and ceilings with the most efficient material obtainable. Even so, it will probably be found that the room is still uncomfortably noisy, and it might be concluded that the treatment was useless. The point is that the maximum possible effect of acoustical material is limited, and one cannot expect to make a room really quiet with any amount of treatment if the noise sources in the room are too intense. The treatment is nevertheless very much worth while, as may be appreciated by a simple analogy with temperature. If the temperature on a summer day dropped from 100 to 90 degrees, it would still be an uncomfortably hot day, but the relief would certainly be appreciated.

The installed price per square foot of an acoustical installation will necessarily depend on a number of factors. The cost of the material itself will depend of course on the type and thickness. The installation cost will be governed by factors such as the size of the job, the method of erection, the condition of surfaces

to receive the treatment, ceiling heights and consequent scaffolding costs, the amount of cutting and fitting required, whether regular or overtime work, and the labor scale applying at the location of the job. Considering all types of acoustical materials on the market and all types of installation, prices may vary all the way from 25c to over \$1.00 per square foot, installed. For perforated cane tile, the most widely used acoustical material for office quieting, the installed price on the large majority of jobs is less than 40c per square foot.

Complete and unqualified paintability is one of the most important requirements for an acoustical material intended for office quieting, particularly in view of the present trend toward indirect lighting and the consequent necessity for high light reflection from the ceiling. If the material can be painted with any number of coats of standard oil paints, applied in the same manner as to an ordinary plaster surface, the cleaning problem is automatically taken care of. In other words, the maintenance problem simply reduces to the standard procedure of cleaning the paint or repainting at the customary intervals.

ADVISE ON HIGHER SOUND INSULATION

Practically all perforated cane tile installations in offices are made by spot cementing the tiles to existing plaster surfaces with permanently plastic heavy-bodied adhesive, or by nailing the tiles to wood furring strips. With careful work, as high as 80 to 90% salvage can be obtained for these methods of application. A few jobs are installed with a mechanical suspension system, in which case the salvagability is practically 100%.

The field of sound insulation and vibration isolation would require a small book for adequate coverage, but a few suggestions will be given. The transmission of air-borne sounds through walls and floors is covered quite thoroughly in a new pamphlet published by the Bureau of Standards "Building Materials and Structures, Report BMS 17, Sound Insulation of Wall and Floor Constructions." This may be obtained from the Superintendent of Documents, U. S. Government Printing Office, Washington, D. C.

"DON'TS" IN SOUND CONTROL

1. Don't expect too much from acoustical treatment. Treatment absorbs only the reflected sound waves, and has no effect on sound which travels directly from the source to the ear.
2. Don't expect acoustical treatment on a ceiling to prevent sound from passing over a part height partition. Remember that sound would easily pass over even if there were no ceiling at all.
3. Don't expect acoustical treatment to take the place of adequate sound insulating construction.
4. Don't practice false economy in considering only the first cost of an acoustical treatment. If it cannot be maintained as cheaply as the surface it replaces, a possible saving in first cost may be more than offset by increased maintenance cost, or possibly by a total loss of sound absorption due to painting.
5. Don't expect a highly sound insulating partition to perform satisfactorily when a thin door is placed in it. The overall sound insulation will be hardly any better than that of the door. The same applies to holes in a wall for pipes, outlet boxes, etc.
6. Don't expect high sound insulation from any door unless all the cracks are tightly sealed.
7. Don't try to get real improvement in sound insulation with half way methods. Good, solid auxiliary construction, and good workmanship are necessary. Remember sound travels through the points of least resistance in a wall.

Standard masonry, wood or steel stud partitions, plastered both sides, and standard masonry or concrete floor construction usually provide adequate insulation against air-borne sound for most conditions encountered in office buildings. When higher sound insulation in a partition is needed, the best method is to erect an auxiliary stud or masonry partition, spaced an inch or two from the existing partition, but not coming in contact with it at any point. The new partition should be plastered on the exposed side, although in some cases where only a slight improvement is needed, the exposed surface may be of plaster board or insulation board, left unplastered.

The best method of improving a floor for air-borne sound is to install an auxiliary plaster

ceiling below the existing ceiling. If possible, the new ceiling should be attached to wood joists or steel members which are anchored only into the side walls and not into the existing ceiling. If suspension is necessary, this should be by wires, or preferably by spring hangers such as the Holmes System. The more rigid the connection, and the greater the number of points at which connections are made, the less effective will be the auxiliary ceiling.

An auxiliary suspended ceiling will reduce the transmission of impact sounds such as footsteps, but better results can be obtained by the use of a resilient flooring material, such as carpet or cork tile. Hard flooring materials, such as asphalt tile give no appreciable improvement.

The sound insulation of a wall or ceiling cannot be sufficiently increased simply by applying an acoustical material to it. Auxiliary construction of substantial weight and rigidity is necessary.

REMEDIES FOR MACHINE NOISES

Where noise from a machine is transmitted by vibration through the building structure, the indicated remedy is to place a resilient mounting of cork, rubber, or steel springs under the machine. Where blocks of cork or rubber are used, a total area of load bearing surface should be used such that the load per square inch on the material is as high as possible without exceeding the elastic limit of that material. For typical machinery cork, this load limit varies from about 75 to 150 pounds per square inch, depending on the density of the cork. The greater the thickness of the block the more effective will be the isolation obtained.

A variety of manufactured rubber mountings applicable to all types of machines are furnished by several prominent manufacturers, all of whom have prepared complete data and recommendations for the use of the various units.

There is one point to watch out for in isolating machines, namely that although a resilient mounting may prevent transmission of vibration into the floor, it may at the same time allow the machine itself to vibrate too violently. This is

particularly liable to happen in the case of steel springs. In this case it is necessary to mount the machines on a heavy poured concrete base and then to mount the base on properly designed resilient mountings.

About the only simple and inexpensive way of improving the sound insulation of a door is to seal the cracks on all sides with rubber or felt gasketed stops and an automatic threshold closer at the bottom. Unfortunately this improvement is only slight. There is practically nothing that can be done with the door itself to increase its insulation except to increase its weight. It is usually easiest in the long run to take out a light panel door that is giving trouble, and substitute a solid flush door 1½ or 2 inches thick and see that the new door is tightly sealed around all edges. If still higher insulation is needed, double doors can be installed, or a specially designed sound insulating door furnished.

For high sound insulation, double or triple panes of glass, each at least ¼ inch thick and separated as far as possible, should be used, each pane being set in gaskets of felt or rubber. If the glazing is set in a double wall the two sides of which are structurally separated, this separation should be carried all the way through the window. That is, a separate rough buck and frame should be set in each side of the wall, and a pane set in each frame, with no rigid connection between the two sides.

The first precaution against duct noise is to avoid too high air velocities. In other words, don't try to get too much air through too small a duct. Second, the duct system should be carefully designed to avoid noise producing air turbulence at bends and splitters. If the air speed is less than about 1000 ft. per min., any noise loud enough to be disturbing will probably be that which is produced by the fan itself and telegraphed through the duct. In this case, lining the duct with a sound absorbing material for a distance of about 10 times the average cross sectional dimension of the duct will usually give satisfactory results. If lining the duct is impractical, a baffle chamber containing parallel or zigzag baffles of this material may be installed at the duct outlet.

ENGINEERS' CONVENTION DESCRIBED BY EXECUTIVE

By FRANKLIN P. ULRICH, C. E.*

THE American Society of Civil Engineers' Convention in San Francisco July 26 to 29 is now history. To those who saw the Convention, many items will always be outstanding; and to those who did not attend, another opportunity has slipped by, of mingling with fellow engineers. From the time that President Fred H. Fowler of the San Francisco Section, opened the Convention on Wednesday morning, until the last technical meeting and excursion on Friday afternoon, San Francisco, ("The City that knows how") really put on a convention.

The writer served with the committee on Registration and Reception and the highlights are written from the eyes of that committee. We were told we could expect 400 at the Convention but our goal was set at 1,500 and the Registration Committee ran a publicity campaign with that number as an objective. We were not disappointed,—the unofficial records show about 1,700 registrations. One of the main objectives of the Registration Committee was to eliminate that almost inevitable rush to register at the last minute. For weeks the Registration Committee had tackled this problem and what was the result—the largest attendance ever recorded and no one had to wait over a few minutes to obtain his registration button and ticket reservations.

The technical sessions were well attended, in fact attendance was larger than anticipated. In most cases, comfortable seats were available for all, and in order to enjoy a fine program, what could be more conducive on the receiving end, than to have the listeners comfortable? The sessions of the technical groups were very successful, and with prominent engineers presenting talks and papers, the expectation of worth-while talks was certainly fulfilled. The sessions were so numerous that it would be impossible to describe them in detail. They were carried out, with few exceptions, as printed in the program. Much favorable comment was heard on individual papers.

Just a few words on the various divisions. In general, the theme subjects were selected from large engineering projects or recent trends in engineering thought. In soil mechanics—earth dams and related problems was a suitable subject for consideration as the Fort Peck Dam slide was still a recent engineering problem.

In the Structural Division—earthquake-resistant design was an appropriate subject and particularly its application to large bridges. The Hydraulics and Irrigation Divisions considered various problems of irrigation, some of which have developed through engineering works like the Central Valley Project and Boulder Dam. The Waterways and Sanitary Divisions found that water supply and sewage disposal of our

large cities always present subjects of unusual interest.

In the Power Division, discussion was focused on concrete dams and various related problems while the City Planning and Highway Division found that present-day traffic provided an interesting theme subject for papers and discussion. Excursions by several of the divisions brought engineers in direct contact with some of the projects discussed in the technical meetings.

Not a small part in the success of the Convention can be attributed to the various social functions and individual group luncheons and dinners. The average layman somehow thinks of a civil engineer as a chap in high leather shoes, with dirty khaki trousers tucked inside of them, a khaki shirt and a slouch felt hat. What a surprise that person would have had if he could have looked into the Colonial Room of the St. Francis Hotel on the evening of July 26th. Engineers in dress clothes—ladies in formals,—hundreds of them—was this a group of engineers? It might seem a bit fantastic, but they were as much at ease as a group of society play boys. Such is the modern age!

Civil Engineers' Day on Treasure Island was another auspicious event of the Convention. The large crowds overtaxed the catering service at luncheon, but that old spirit of "knowing how" came to the rescue. Wires burned and trucks whizzed from San Francisco to provide roast duckling to the extra fifty who came at the last minute. An afternoon of viewing exhibits, followed by dinner and a floor show, brought the Civil Engineers' Day to a close.

Let's not forget—our tribute to the Ladies Committee for handling a part of the Convention which requires that feminine touch to make it perfect. Tea, luncheon, supper, with well conducted excursions in the Bay region, gave the visiting ladies an impression which will not be forgotten.

A person who works behind the scenes of such a convention, knows it takes a lot of hard work to make a convention click. The girls behind the registration desk deserve much credit and also the organizations and individuals who furnished those girls. Service from the Hotel St. Francis? A push of a button was as effective as rubbing Aladdin's Lamp. Every conceivable gadget, down to schoolroom accessories, appeared as if by magic!

And so, we draw the curtain across the setting of the 1939 Summer Convention of American Society of Civil Engineers at San Francisco. When the curtain rises again, the scenery will have been changed and another city will bring forth engineers who will try to focus the spirit of engineering into another three-day convention.

*F. P. Ulrich, Chief Seismological Field Survey, U. S. C. & G. S., Secretary, Structural Engineers' Association of Northern California.

TWO YEARS MORE OF MODERNIZATION

For the next two years the building industry may continue to benefit from the FHA Insured Modernization Loan Plan (Title I), because of new Federal legislation effective July 1.

FHA will continue to insure modernization loans made by qualified lending institutions. But the new amendments to Title I of the National Housing Act change several details of the plan. Industry will probably be most interested in the maximum amount which may be borrowed and in the number of years a loan may run.

The top loan is now \$2500. If the loan is to be used for alterations or repairs the longest term is three years. Both limits are in line with present lending practice. If the loan is to be used for constructing a new residential or farm building, the term may be as long as 10 years. This longer term, however, does not apply for other new construction such as garages, wayside stands, etc., which come under the three-year limit.

Another point of interest in the new amendments is the insurance premium charge ($\frac{3}{4}\%$ on modernization loans and $\frac{1}{2}\%$ if the loan is used for new residential construction). This charge is to be borne by the lending institution and does not increase the cost of the loan to the borrower. The maximum finance charge remains \$5 per \$100 for modernization loans and \$3.50 per \$100 for new residential construction under Title I.

As in the past, modernization loans will be available to responsible prospects with good credit standing who wish to fix up their homes by making repairs or certain "permanent" improvements. Renters, as well as owners, may modernize on this plan only if they hold sufficiently long leases.

The borrower, of course, must have a regular income in addition to good credit standing, for these loans are "income payment" loans. However, the dealer or workman who contracts for the job is not paid in installments. On the contrary, material and labor are paid for in cash with the proceeds of the loan. The customer repays the lending institution in installments which are figured according to his means. In this way the modernization loan plan can turn many a prospect into a "cash customer."

Repairs, redecorating, remodeling, landscaping, and various types of permanent installations and built-ins may be paid for with FHA-insured Modernization Loans. In addition, new structures may be built.

STATE BUILDING CODE

Copies of the Building Code for California, prepared for the State Chamber of Commerce, have been received by committee members.

The Code represents the work of more than one hundred highly qualified technical men and a code executive committee covering a period of ten years.

The State Chamber has brought about this valuable work through the efforts of the late Arthur S. Bent of Los Angeles, Fredrick J. Koster, Norman H. Sloane,

Charles S. Knight, Henry D. Dewell, engineer of San Francisco; Edwin Bergstrom, architect, and David J. Witmer, of Los Angeles, general chairman of the committee.

ALL-GLASS EXHIBIT AT THE FAIR

A new technique in presenting to the American public the latest creations of industry, is to be found in the all-glass exhibit of the Libbey-Owens-Ford Glass Company at the Golden Gate International Exposition.

This display of the modern uses for flat glass, most of which are developments of the past two decades in the glass industry, is a far cry from the glass blowers and other carnival effects of previous expositions. It is designed to awaken a new consciousness in this country of the possibilities of building and remodeling in glass. Its theme is practical showmanship. It has eye appeal and yet is designed so as to answer the questions of consumer and dealer. The businessman and home builder alike may learn by actual demonstration what the glass industry has to offer to improve his business and make his home more livable.

For the prospective home builder, the feature of the exhibit is the all-glass bathroom in color. The visitor is impressed by the practical uses of these new glass materials, seeing walls in two shades of blue vitrolite—the lower portion in cadet blue and the upper part, princess blue. A white vitrolux ceiling sheds diffused, but ample light. The large squares of vitrolux are supported by strips of decorative extrudalite, a lightweight metal sash.

The glass shower screen, surrounding the square tub, is of Blue Ridge polished flutex, in a new modern pattern, bent to provide a rounded corner. This type of screen assures privacy, and yet transmits needed light for the occupant and gives the bathroom a decorative smartness and cleanliness. The vanity has a quarter-inch plate glass mirror, with a three-quarter inch built-in shelf of plate glass. On the opposite wall is a lavatory backed by a clear plate glass mirror, with a mirrored recess for toiletries. The floor is covered with a rug of a new-type washable fabric in golden yellow. Both the vanity seat and chaise longue are covered to match the flooring and supported by bent plate glass, decorated with sandblasted polka dots.

One of the feature attractions of the exhibit is an all glass decorative table made by the Carvart Company of Los Angeles. The table is unique in construction in that it has no metal fittings. Assembly is attained by interlocking grooves in the glass. When edge-lighted, the table takes on the exquisite beauty of a fine-cut diamond, reflecting the lights and mirrors and colors of the entire exhibit. The table is set on a platform of black and ivory vitrolite. Its top is quarter-inch plate and the legs of one-inch plate glass. The top and legs are decorated with carved sandblasted designs representing approximately 405 hours of labor time. The base is of mirrored clear plate and the whole assembly rests on four globes of solid glass.

With the Architects

S. F. ARCHITECTURAL CLUB NOTES

The San Francisco Architectural Club's exhibit in the Homes and Gardens Building at Treasure Island is attracting considerable attention and favorable comment. Some interesting drawings adorn the walls of the booth.

The club is arranging for courses of study to be conducted in the club rooms at 130 Kearny Street, San Francisco, this fall. Classes will be formed in the following subjects:

Architectural Design—Mario Ciampi, architect, patron. Structural Engineering—C. Jefferson Sly, C. E., instructor. Architectural Detailing—Ira H. Springer, instructor. Specification Writing—Sidney A. Colton, architect, instructor. Estimating—Henry M. Snyder, instructor. Interior Decorating—Leland Hyde, instructor.

Organization meetings of the detailing, specification and interior decoration classes were held Thursday, August 10.

Organization meeting of the engineering class will be held Friday, August 25.

ENGINEER-CONSULTANT

James H. LeFeaver, civil engineer, for many years a consultant in the office of Julia Morgan, architect of San Francisco, announces the opening of an office as Building Consultant in the Merchants Exchange Building, San Francisco. Mr. LeFeaver's scope of advice will include physical examination of buildings, cost of reproduction, use expectancy, improvements and betterments.

WARREN P. SKILLINGS, ARCHITECT

Warren P. Skillings, architect of San Jose, passed away in a San Jose hospital early in August following a lingering illness. Mr. Skillings was born in Portland, Maine. He had practiced his profession in San Jose for more than 20 years, designing many of its finest residences. He was with Bliss and Faville of San Francisco, prior to moving to Santa Clara County. He was a member of Northern California Chapter, A.I.A.

MARKET BUILDING

E. A. Neumarkel, architect of San Francisco, has awarded a contract for construction of a one-story frame and stucco market building on San Bruno Avenue, San Francisco, for Joseph and James Muscat for \$10,000.

STORE AND OFFICE ALTERATIONS

The office of Charles F. Dean, Sacramento, has completed drawings for a \$37,000 alteration project for the California West States Life Insurance Company at 818 J Street, the old Elks Club Building. The work will include interior and exterior remodeling of the present three story structure.

DELANO & ALDRICH SCHOLARSHIP

Pierre Bailleau of Paris has been awarded the Delano and Aldrich Scholarship for this year.

Mr. Bailleau has won many of the prizes at the Ecole des Beaux Arts. He has 61 values in the first class and has twice been logiste for the Grand Prix de Rome. In him, the Paris Committee on Selection has continued the tradition of choosing brilliant students for this Scholarship.

SCHOOL LIBRARY

Henry C. Smith of San Francisco is preparing working drawings for a reinforced concrete library and agricultural shop building for the Hayward Union High School District. Bonds in the amount of \$150,000 have been voted.

PIEDMONT RESIDENCE

A \$17,000 ten-room residence is to be built in Piedmont for George N. Edwards from plans by Clarence W. Mayhew, 6026 Acacia Street, Oakland. The exterior will be brick veneer and stucco with wood sash and wood shake roof.

NOVIATIE BUILDING

Harry J. Devine, architect of Sacramento, has been commissioned to prepare plans for a one, two and three story reinforced concrete novitiate for the Sisters of Mercy at Auburn, California. The improvements will cost \$100,000.

GYMNASIUM AND CAFETERIA

Carl F. Gromme, Freitas Building, San Rafael, has awarded contracts for the construction of a one story reinforced concrete gymnasium and cafeteria in San Rafael for the Roman Catholic Archbishop of San Francisco, for \$45,000.

ARGENTINE ARCHITECT HERE

Luis V. Migone, Buenos Aires, Argentine, architect, representing the Argentine Government and Argentine Center Engineering, who attended the World's Congress of Automotive Engineers last month in New York, as a delegate, was a recent California visitor. At Los Angeles he inspected the new General Hospital.

Mr. Migone is supervising engineer of a 12,000,000-peso tuberculosis institute in Buenos Aires.

ARCHITECTS DISSOLVE PARTNERSHIP

The partnership of Spencer, Blanchard & Maher, architects, 369 Pine Street, San Francisco, has been dissolved, Messrs. Blanchard and Maher continuing their partnership while Mr. Spencer will practice independently. Both firms have retained offices in the building at 369 Pine Street.

PERSONAL

F. W. Bockermann and **W. Sam Chinn**, architects who have occupied quarters in the office of Thomas, Grainger & Thomas, Seattle, recently joined the examining staff of the Washington State office of the Federal Housing Administration in Seattle.

William G. Brust, architect, recently resumed active practice at his office, 732 Republic Building, Seattle.

W. George Lutz, formerly at 6314 1/2 San Vicente Boulevard, Los Angeles, announces the removal of his offices to 9012 W. Olympic Boulevard, Beverly Hills.

C. H. Purcell, State Highway Engineer, will not accept the post of consulting engineer tendered by the city of San Francisco to study and propose a solution of its traffic problems.

John W. Blackman, city engineer and director of public service of Long Beach since 1935, has tendered his resignation.

Leonard E. Cooke, architect, has been elected president of the City Planning Commission of Santa Barbara. **Roy Cheesman** is secretary.

C. K. Smithley, architect, has opened a new office at 9507 Santa Monica Boulevard, Beverly Hills.

Norman E. Fox, former Seattle architect, is now affiliated with Frank Wynkoop at Bakersfield.

Victor Steinbrueck, who recently completed a year's service with H. Elmer Kirkemo, architect, at Missoula, Mont., has returned to his home in Seattle.

Ivan W. Meyer, architect, of Seattle, spent July at Fort Lewis in annual encampment with the 41st Division of the National Guard. Mr. Meyer holds a commission as a captain.

William L. Painter of Graham & Painter, architects and engineers with offices in Seattle and New York, is spending part of the summer in charge of the Seattle office.

SEATTLE HOUSING AUTHORITY

Headquarters for the Seattle Housing Authority have been opened on the second floor of the 711-2nd-Ave. Building, formerly known as the Hoge Annex. The Authority will immediately sponsor a comprehensive survey of the housing needs of low-income groups. The field of activity includes all of the territory within the city limits of Seattle, plus all land bounded by a five-mile exterior perimeter line. A fund of \$3,000,000 has been granted the Authority by the National Housing Administration to carry on its work.

The Seattle Housing Authority is composed of George Coplen, Mrs. Frank D. Henderson, Charles W. Doyle, Kenneth J. Morford and Francis LeSourd. Five Seattle architects who make up the architectural advisory board, are John T. Jacobsen, William J. Bain, J. Lister Holmes, George Wellington Stoddard and William Aitkin.

STRUCTURAL ENGINEERS' FIELD DAY

The annual field day meet of the Structural Engineers Association of Southern California was held at the Brentwood Country Club, Brentwood Heights, July 7. The afternoon was taken up with golf, ping pong and swimming. The evening was devoted to dinner, awarding of prizes and entertainment.

The prizes as awarded for golf were as follows: First, low gross for members, Peter Horn; second, Ed Seaver. Low gross for guests: First, Marlo Imes, and second, Mr. Storey. High gross: Mr. Howland. The high fore-some: S. B. Barnes, Floyd Fisher, Lyle Barcume and William Moore. The blind bogey: Don S. Shugart and Mr. Small.

Following the awarding of the golf prizes, Ted Combs was given official title and prize for winning the ping pong tournament.

The four door prizes went to Messrs. Mendenhall, Sidney Bambegger, Glenn Cook and James Gibson.

EDWARD G. BOLLES, ARCHITECT

Edward G. Bolles, practicing architect in San Francisco for more than 40 years, died suddenly August 8 at his home, 775 Post Street, San Francisco, aged 68. Mr. Bolles was known throughout the state as architect of the once famed Tivoli Opera House and Poodle Dog Cafe. His last commission of importance was the Temple of Religion on Treasure Island.

Mr. Bolles, a native of Illinois, came to San Francisco in 1896. Besides the Temple of Religion and Tower of Peace at the Exposition, he designed the Christian Science Monitor Building.

Mr. Bolles is survived by one daughter, Mrs. Henry Wallace Richardson of Manila, and two sons, Captain L. G. Bolles and John S. Bolles, both of San Francisco.

LAMENT FOR THE TIMES

(From "Alabama")

Too much oats and too much wheat,
Too much corn and too much meat,
Too much cotton and too much oil,
Too many hours that we don't toil,
Too many highways, too many cars,
Too many people behind the bars.

Too much poverty and too much wealth,
Too many people in ill health,
Too many politics, too much booze,
Too many wearing high-heeled shoes,
Too many loafing, too many bets,
Too many failing to pay their debts.

Too many spending their dough on gas,
Too many talking of European sass,
Too many living beyond their means,
Too many buying canned corn and beans,
Too many sowing their crop of wild oats,
Too many candidates after votes.

Too many people who don't give a damn,
Too many looking to Uncle Sam,
Too many poets and too much prose,
Too many girls without underclothes,
Too much reform and too much law,
It's the darndest mess you ever saw.

LABOR CREATED BY FEDERAL LOANS

By ISADOR LUBIN, Commissioner of Labor Statistics

THE construction of public works has long been a first line of defense against unemployment in periods of depression. In judging the effectiveness of any program of public works as a means of reemployment, several groups of workers must be considered. First, there are the men who work on the job itself. They are carpenters, bricklayers, stone masons, ditch diggers, cement finishers, and a host of other skilled, semi-skilled and unskilled men who work with them. Second, there are the men in the factories who provide the brick, cement, lumber, and steel to be used on the job. Back of them are the miners, the loggers, and others who supply the raw materials for the factories; and last, there are the men on transportation systems which carry the materials to the factories and later to the job.

Employment of these secondary groups of workers is just as important in any reemployment program as the employment of men at the site of construction. For a great many types of public works the materials, man-hours, and transportation men are numerically more important than the men working at the site of the construction projects.

Employment of these secondary groups of workers is just as important in any reemployment program as the employment of men at the site of construction. For a great many types of public works the materials, man-hours, and transportation men are numerically more important than the men working at the site of the construction projects.

The vast majority of contractors and subcontractors working on construction projects financed in whole or in part by Federal funds, send monthly reports to the Bureau of Labor Statistics showing the number of employees, amounts of pay rolls, and man-hours worked at the site of each construction project. Each contractor also notifies the Bureau of the type and value of materials which he purchases for these projects as well as the source of his supplies. This provides a record of the total value of materials used in relation to the cost of the job and to the size of the site pay roll.

On the basis of the information furnished by the suppliers of these materials, the Bureau makes estimates of the number of man-hours of labor required in the manufacture and fabrication of these materials.

Beyond this labor consumed in the manufacturing of these products purchased by the contractor is other labor used in making the raw materials that went into their production. For steel, cement, lumber, brick, plumbing and heating supplies, electrical products, and sand and gravel, the Bureau has traced the record far back along the line to the original supplies of raw materials. Mines, railroads, factories, and shipping lines opened their records for the personal inspection of the agents of the Bureau so that these facts could be obtained.

The studies of the Bureau of Labor Statistics have now segregated the benefits to industry and employment arising from each major type of public works construction. They show what happens to men and machines when various types of public works construction projects are undertaken.

With the material from these surveys, it is possible to forecast with a reasonable degree of accuracy, the results which might be expected from new construction programs. For example, for each \$100,000,000 spent for non-Federal public works of the sort that were constructed under P.W.A., the Bureau estimates that there will be 34,400,000 hours of labor created at the construction site, and that 65,700,000 hours of work will be created in mines, forests, factories, and on transportation systems.

In addition to the number of hours of employment created in fabricating the materials, the Bureau's studies also show the dollar value of orders which factories may expect from different types of programs. For example, in a \$100,000,000 building construction program, iron and steel mills may expect orders valued at \$15,000,000; lumber and millwork firms, orders in the amount of \$5,300,000; brick and tile plants, orders in the amount of \$4,200,000, etc.

For every \$100,000,000 spent for self-liquidating transportation projects, approximately 47,500,000 hours will be created at the construction site and 66,900,000 hours in mines, forests, factories, and on transportation systems.

A rural electrification program of \$100,000,000 will create approximately 34,000,000 hours at the site and approximately 47,000,000 hours in mines, forests, factories, and on transportation systems.

The program would provide for the installation of approximately 460,000 miles of line. This would involve, among other things, the purchase of 9,200,000 poles, 1,150,000 meters, 1,000,000 transformers, 400 million pounds of copper, aluminum and steel. The program would serve a minimum of 1,150,000 rural families.

In addition to the foregoing, the construction of these new lines would, during the first six months they were energized, result in the installation of approximately \$115,000,000 of home wiring and the purchase of over \$230,000,000 of home electrical appliances purchased by the families receiving electric service for the first time. Since approximately one-half the cost of wiring represents labor (including that of the contractor) and one-half represents the cost of wiring materials, a market will be created by this program of over \$230,000,000 for appliances and approximately \$57,500,000 of wiring materials such as insulated copper conductor, outlets and switches. The figure on appliances is low; purchases during the second six month period would raise the total perhaps as much as 25 per cent.

Included in the appliances purchased during the first six months of service would be approximately the following totals:

- 1,000,000 radios
- 950,000 hand irons
- 550,000 washing machines
- 300,000 refrigerators
- 275,000 toasters
- 200,000 vacuum pumps
- 200,000 vacuum cleaners
- 100,000 small motors

So far we have been talking about the benefits the durable goods manufacturers receive from public works construction. The manufacturers and vendors of consumers' goods and services also benefit by public works expenditures. From its studies of family expenditures, the Bureau has determined approximately how wage earner families spend their earnings. It is estimated that a \$100,000,000 non-Federal construction program will show expenditures by wage earners of \$21,700,000 for food; \$10,700,000 for housing; and \$7,300,000 for clothing, etc.

The railway equipment program would create over 400,000,000 man hours of employment, one-fourth of which would be in the car shops. The bulk of the employment involved in car building would be of a skilled and semi-skilled nature. A rough estimate of the amounts of material involved in the program (assuming that one-fourth of the construction will be of locomotives) is 400 million man hours in which one-fourth will be in the car plants and the remainder outside of the car plants. Over 30 million tons of steel would be

employed, over 10 million tons of coal, 780,000 tons of lumber, 15,000 tons of paint, 60,000 tons of refractories. In addition to these there are a large number of machine tools, small tools, and electrical equipment which would be needed.

MILLION VEHICLES CROSS BRIDGE

The San Francisco-Oakland Bay Bridge reached a new high in traffic for July, when 1,093,502 vehicles crossed the span. Daily average was 35,274 vehicles and total revenues for the month amounted to \$466,771.30.

The Bay Bridge, exceeded only by the Delaware River and Triborough bridges in point of traffic, tops all toll bridges in revenues.

The July record traffic brought the amount of vehicles to cross the span from the opening day, November 12, 1936, to a total of 25,063,024.

Treasure Island-bound motorists added 242,191 vehicle to July's total. The bridge carries approximately 44 per cent of all paid admission visitors to the Exposition. Exclusive of these motorists, bridge traffic was 850,631.

Increase in the month's traffic over July, 1938 was 48 per cent, and over the preceding month of June, 22 per cent.

STORE BUILDING

Plans are being prepared by Earl R. MacDonald, 1710 Franklin Street, Oakland, for a one story steel and brick store building at Antioch for J. D. Donlan. There will be two stores with tile and plate glass front.

AN ESTIMATE OF THE EFFECT OF \$100,000,000 OF CONSTRUCTION CONTRACTS AWARDED FOR P.W.A. BUILDING PROJECTS

(Prepared in the Bureau of Labor Statistics, Division of Construction and Public Employment)

Expenditures for:		
Labor at site	\$29,300,000	29.3%
Material...	54,100,000	54.1%
Other expenses and profit	16,600,000	16.6%
Man-hours worked:		
At the construction site		34,400,000
In mines, forests, factories, transportation, and in administration		65,700,000
Value of material orders placed:		
ALL MATERIALS		\$54,100,000
Iron and steel products, not elsewhere classified		15,000,000
Lumber and millwork		5,300,000
Brick and hollow tile		4,200,000
Cement*		3,900,000
Heating and ventilating materials		3,600,000
Sand, gravel, and crushed stone**		3,100,000
Plumbing materials.. . . .		2,800,000
Electric wiring and fixtures		2,700,000
Marble, granite, slate, and other stone products		2,200,000
Electrical machinery, apparatus, and supplies		1,400,000
Wall plaster, wall board, and insulating board		1,100,000
Roofing materials, not elsewhere classified		900,000
Non-ferrous metals and their products.		800,000
Tiling, floor and wall, and terrazzo		600,000
Paints and varnishes.		400,000
Other materials		6,100,000

*Includes cement in concrete products.

**Includes sand and gravel in concrete products.

ARCHITECTS' BULLETIN

Issued For

THE STATE ASSOCIATION OF CALIFORNIA ARCHITECTS

Northern Section

STATE ASSOCIATION MEMBER
OF THE
AMERICAN INSTITUTE OF ARCHITECTS
Editor

Harris C. Allen

Address all communications for publication in the Bulletin to the Editor (Harris C. Allen) 557 Market Street, Room 218, San Francisco, California.

Board of Control

Harris C. Allen Otto G. Hintermann
Harry Michelsen Wayne S. Hertzka

State Association Officers

President.....Sylvanus B. Marston, Pasadena
Vice-President.....Gwynn Officer, Berkeley
Secretary.....Wayne S. Hertzka, San Francisco
Treasurer.....Robert H. Orr, Los Angeles

Regional Director, A. I. A.

Albert J. Evers, San Francisco

Delegate Regional Director, Southern

California

Gordon B. Kaufmann, Los Angeles

Executive Board—Northern Section

Officers

President.....Gwynn Officer, Berkeley
Vice-Pres.....Ernest E. Weihe, San Francisco
Secretary.....Wayne S. Hertzka, San Francisco
Treasurer.....Otto G. Hintermann, San Francisco

Directors

Harry J. Davine R. H. Reimers
Wm. J. Marchant Harold Weeks

Executive Board—Southern Section

Officers

President.....Sylvanus B. Marston
Vice-President.....Louis N. Crawford
Secretary.....Winsor Soule
Treasurer.....Robert H. Orr

Directors

Merrill W. Baird Abe Edelman
Harold C. Chambers George D. Riddle

Advisors—Northern Section

Harris C. Allen San Francisco
J. K. Ballantine, Jr. (Secretary)
Sam. Lightner Hyman
Wm. G. Marchant
Jas. F. McGuiness
Dodge A. Riedy
Harold H. Weeks
Ernest E. Weihe
Albert R. Williams
Fred. H. Reimers (President)
C. A. Caulkins North Bay District
Peter Sala Lower San Joaquin District
J. U. Cloudsley (Secretary)
Edw. W. Kress Santa Clara Valley
Mario Corbett San Mateo
Alden Cambell Sacramento
Ernest J. Kump Upper San Joaquin
Dole F. Thomsen Palo Alto
Norman W. Sexton Marin
Geo. P. Simonds East Bay
Chester Treichel East Bay
Gwynn Officer Berkeley
F. T. Georgeson Redwood Empire
Casebolt Dakin Upper Sacramento
Ralph Taylor Lassen District

Legislation and the Building Industry

ALTHOUGH State legislation is ended for this period, National legislation is still in process of determination which affects the building industry.

Efforts are being continued to renew PWA activities, either separately or in connection with other agencies. By the time this Bulletin is in print, some of these efforts may have materialized. The opinion has been expressed in such gatherings as our Building Industry Conference Board, that unless PWA is continued, architects and engineers, as well as contractors, will not be very busy in the near future.

The question of the "prevailing wage" in WPA work appears to be settled at this writing. While the labor unions are concerned over the effect upon their general wage scales, it is difficult to see any such possibility. The present ruling will eliminate bootlegging of skilled labor, and contractors believe it will lessen public competition with private industry.

The Association has urged support of the Bill, extending the program of the United States Housing Authority, passed by the Senate and at this writing still pending before a House Committee. This Bill is considered vital to the continuation of national and local housing programs.

THE BIDDING PROBLEM

At continuing meetings of the Building Industry Conference Board and a special committee, study and discussion of this unsettled and unsatisfactory question are active. Many points are being brought to light. A system which has been used for several years in Louisville, with apparent general success, is being considered, and may be proposed either intact or as a basis for a local system.

Among the contributions to the study of this matter was a list of items, proposed by Frederick Reimers, of San Francisco, which is as follows:

(Code of Practice for Building Industry—Proposed by Frederick H. Reimers)

Regulating of contractors, sub-contractors, materials concerns:

- 1—To prevent undermining architect or engineer in the mind of the owner, in order to have greater control of the work.
- 2—To prevent bidding on a job with the idea of substituting inferior material.
- 3—To prevent taking plans from architects' or engineers' offices without intention of bidding, or changing their minds, and not returning plans in time to replace them with other bidders.
- 4—To prevent possible collusion.
- 5—To prevent contractors acting as "brokers."
- 6—To prevent sub-contractors from withdrawing their bids after general bids are opened.
- 7—To ensure contractors' responsibility for supervision of their work and to prevent substitution of materials, poor workmanship, carelessness of subcontractors and workmen in relation to other work or materials.

Regulation of Bidding and Contract Procedure

- 1—To ensure open and ethical deposits of bids.
- 2—To eliminate competing bid deposits.
- 3—To relate bid deposits to public work requirements.
- 4—To protect low bidders against "back door" practices after bids are opened.
- 5—To require outside bidders to comply with local regulations.
- 6—To ensure confidence in proper conduct of bid deposit, by professional advice or management.

Cooperation by Architects and Engineers

- 1—To limit alternates to a reasonable number and to a reasonable difference in cost.
- 2—To ensure the awarding of contracts to low bidder, or if owner prefers a higher bidder to provide financial compensation to low bidder.
- 3—To ensure the inclusion of all subcontracts and regulations, in contract awarded to a high bidder.
- 4—To establish mutual ethical relations.

CONVENTION COMMITTEES

The following committees have been appointed for the 1939 Convention, State Association of California Architects, to be held at Santa Barbara October 26, 27, 28:

Registration and Credentials: Henry W. Howell, Chairman; Harold E. Burket, Louis N. Crawford, William A. Edwards, E. Keith Lockard.

Resolutions: John Frederick Murphy, Chairman; Wayne S. Hertzka, Samuel E. Lunden.

Ways and Means: E. Keith Lockard, Chairman; Robert H. Orr, Otto G. Hinterman.

Ladies Entertainment: Mrs. Henry W. Howell, Chairman; Mrs. R. W. Armitage, Mrs. C. L. Carjola, Mrs. R. W. Cheesman, Mrs. L. A. Cooke, Mrs. W. A. Williams, Miss Audrey Lockard, Mrs. J. Frederick Murphy, Mrs. Winsor Soule.

Entertainment: Lulah Maria Riggs, Chairman; E. Keith Lockard, Roy W. Cheesman, Chester L. Carjola.

Publicity: Leonard A. Cooke, Chairman; W. D. Peugh, Merrill W. Baird. For the Producers Council—J. W. Marlo, Pioneer Flintkote Co.; John Vandenberg, Blue Diamond Corporation; A. A. Baines, Gladding, McBean & Co.; J. H. Solvini, Johns-Manville Company.

Golf: Francis Boyd, Chairman; Harold E. Burket, William A. Edwards, John Vandenberg.

Convention Steering Committee: Winsor Soule, Chairman; Harold E. Burket, Robert H. Orr.

Convention General Committee: Winsor Soule, Chairman; R. W. Armitage, John C. Austin, Merrill W. Baird, F. C. Barienbrock, Harold E. Burket, C. L. Carjola, John Curtis Chambers, H. C. Chambers, Louis N. Crawford, Clarence Cullimore, Walter L. Culver, Jr., Hugh R. Davies, Pierpont Davis, Manfred M. DeAhna, Robt. V. Derrah, Ralph C. Flewelling, Breo Freeman, Leland F. Fuller, George E. Gable, Sam W. Hamill, Lester H.

Hibbard, Frank L. Hope, Jr., Myron Hunt, William Templeton Johnson, Donald B. Kirby, Samuel E. Lunden, Ben. H. O'Connor, Natt A. Piper, Theo L. Pletsch, George R. Postle, Scott Quintin, George D. Riddle, Lester G. Scherer, Cecil A. Schilling, Harold O. Sexsmith, A. R. Walker, Eugene Weston, Jr., Stanton Willard, Kenneth S. Wing, G. Stanley Wilson.

UNIFICATION

The following notes are taken from an informal talk by Leigh Hunt, State Association representative on the Board of Directors, A.I.A., at the recent Mid-West Architectural Conference at Notre Dame University:

"I have been asked to talk on the 'Unification Movement,' sponsored by the American Institute of Architects . . . what it is and just what this movement is expected to accomplish.

"First, why did certain leaders in the Institute think that the unification of the architectural profession was necessary?

"I have heard certain old timers, not only in Wisconsin, but in other states, tell tales and paint word pictures of the profession that were none too flattering. They stated that the architects were individualists, were suspicious and jealous of each other and without a trace of tolerance. There may have been some truth to these statements, for again goes the story that not many years ago if one architect saw another coming down the street, he would cross to the opposite side rather than meet him face to face.

"The American Institute of Architects' Chapters launched a program of expansion, state societies appeared and cooperation followed. Architects—well known ones—met the lesser known at meetings and picnics. They became friends, called one another by their first names and were heard to say, 'Bill is a swell chap—wish I had known him before.'

"We began to find in each other certain talents and abilities and found that our social contacts, especially in group meetings, were helping our profession to gain recognition from the public—not as eccentrics, but as professional men necessary to the development of any community.

"The history of the State Society shows us that it was conceived and the societies formed by Chapters in order that united action and legislation and code matters could be undertaken by the majority of the architects in the states. For many years at the A.I.A. conventions Unification had been discussed from the floor but it was not until the 1937 convention in Boston that a definite movement was made by the Institute to induce the State Societies to join as State Society members.

"A committee on Unification was created with one representative from each of the existing State Societies. This was continued at the 1938 convention in New Orleans and a Director for State Societies was provided for, this Director to be selected by the delegates of the

SAFETY PAYS—IN MANY WAYS

By George E. Sladek, Superintendent, Kraftile Company

convention meeting of State Societies and elected by the convention. This required a change in the by-laws so that new directorship has been without vote since appointment in New Orleans.

"This director has, however, attended all directors' meetings and has been given a budget for traveling expense.

"I was recently informed that the number of registered architects in states having registration was 14,800 in round numbers and that those practicing in states without laws would bring the total to 18,000. The Institute has approximately 3000 members, or one sixth of the total in the United States.

"Most of the better known names in architecture, are among those listed in the *Annuary* and the American Institute of Architects is generally recognized as the national organization of the profession.

"There has been much talk of making the Institute an all-inclusive national organization but due to corporate restrictions and other details which are of necessity slow of change, it was decided to invite State Societies to join the American Institute of Architects as State Society members so that at least for the present the Institute could represent the profession in national affairs without affecting the autonomy of the State Associations.

"The representative for the State Societies, in cooperation with the Committee on Unification and the Board, have worked hard since 1938 when there were but four State Associations affiliated with the Institute—Michigan, Ohio, California, (North and South) and Wisconsin, and eleven others not affiliated—Kentucky, Indiana, Alabama, Mississippi, Florida, Oklahoma, Kansas and Texas which are now changing by-laws necessary for affiliation. Kentucky is now a full fledged State Association member.

"Illinois is now voting on affiliation and Maryland, Delaware, New Jersey, Pennsylvania, Virginia and Nevada are to vote between now and September.

"Reports from the Committee on Unification and the State Society Representative were submitted to the Executive Board during May of this year and these reports indicate a keen interest of the architects in Unification and of their desire that the Institute be the national organization representing the architects of their country in national issues as their spokesman.

"It is now 82 years since the Institute was founded and our profession and the science of building have seen many changes since then.

"Architecture is both a profession and a business today and if we are to keep our place as leader of the construction industry we must increase our business efficiency without lowering our esthetic ability in order that we will be of ever increasing usefulness to the public.

"Unification of the architectural profession is needed today in order that the construction industry (the second largest industry in the United States) can have a strong leader to guide it to better days."

WHEN California industry in general was worried over the prospects of a high surcharge to the manual compensation rate in manufacturing plants where silicosis hazards were judged to exist, C. W. "Chuck" Kraft took charge of the Kraftile Company at Niles, California. That was three years ago, and then, too, there was a disposition merely to explain away such manufacturing conditions. Today at the Kraftile plant, control of such hazards is a routine part of the safety program.

Regardless of the merits of the then-current arguments as to the effect of clay dust on workers, the Kraftile Company took the attitude that prevailing dusty conditions could do no good to either men or product. Elimination of clay dust became a major point in a definite program of improvement of production. The Niles management felt that the most important items in the Rating Plan of the California Inspection Rating Bureau had to do with the observance of practices of good plant management. Such practices Mr. Kraft considered to be merely "good housekeeping," a matter of good supervision. This has paid for itself.

The next step was to try to realize actual savings to be made through individual effort and simultaneously to reduce silicosis hazard to a standard better than that provided by the Rating Plan of the Bureau. The Kraftile record of compensable accidents had not been good, and in order to make progress all along the safety front a safety organization was set up early in 1937. Based on the plan of the Industrial Rating Schedule for plants of from 50 to 150 employees, the safety organization included features of other plans that were studied and found adaptable.

The essential feature of the organized safety work is the safety committee composed of foremen. Supervisory authority thus exists for carrying out in each department the plans of the safety committee. In a small plant, this provides sufficient contact with the personnel; but Mr. Kraft doubts if any system will work unless a genuine interest is shown by management at the top.

Realizing that 98 per cent of all accidents are preventable and that 88 per cent are preventable by supervisory regulation, the management inaugurated education for supervisory employees. That effort had very gratifying results, proving again that safety pays in reduction in human suffering, in reduction in insurance cost, in greater efficiency and in better quality of product.

After organized accident prevention work had been carried on for a six-month period under the approved safety plan, a reduction in compensation premiums of 10 per cent was earned. In a small plant this would hardly pay for the effort of carrying on a really effective program, but—this is only the start. Reportable acci-

dents were reduced from 21 in 1936 to 7 in 1937, four of which occurred before the Safety Plan was started in March of 1937.

Swinging rapidly into the spirit of the thing, the plant was entered in a nationwide Kraft Safety Contest with other plants of comparable size but of diverse operations and with years of safety training. The contest ended on April 30, 1938, and Kraftfile tied for first with no lost-time accidents. A second contest ending in April of this year found Kraftfile again at the top.

There have been no lost-time accidents at the Kraftfile plant since February 8, 1937—a period of more than two years. During this time, compensation costs have been reduced 25 per cent through lowered rates and a dividend of 45 per cent of the 1936 premium.

Backing up the efforts of the safety committee in ferreting out unsafe practices and conditions, the management authorized compliance with their recommendations and did the work necessary to reduce the dust hazard in the plant to a minimum. Means of properly exhausting dusty operations and preventing dust contaminations at their sources were concentrated on. As a result, employees are able to work in comfort without wearing respirators and the dust content of the air in the plant has been reduced to less than the permissible maximum. Through a system of ducts the dust is conveyed to a point of safe disposal.

From a problem child three years ago, the plant has become a shining example of cleanliness and orderliness and is today something of a show place in the clay products industry. During 1938, in order to continue the progress made and to maintain the interest in safety work, an Inter-Department Safety Contest was initiated. Each department is graded primarily on the number of accidental injuries sustained in it. All injuries, however slight, are reported and counted in the rating. This is done on the theory that for each time even a first-aid case occurs, the same set of circumstances occurs a score of times without hurting any one. Injury demerits for departments are expressed in a percentage based on the number of employees. This gives a just allowance for differences in size of the competing departments.

The rating system is as follows:

Merits are given at the rate of one per man per month in each department having no lost-time accidents.

Demerits are given for lost-time accidents according to the schedule followed in the Kraft Interplant Safety Contest and are based upon how severe the injury is. In addition, all merits for the month are forfeited by a lost-time accident. Reportable accidents get five demerits each. First-aid cases get one demerit each.

Rating is on the proportion of demerits to merits. Thus, if a department has 16 men and 8 first-aid cases in one month, its rating will be 50 per cent, as would also a department which had two men and one first-aid case. If the department with 16 men had one reportable accident (5 demerits) and three first-aid cases (1 de-

merit each) its score would still be 50 per cent. The rating is cumulative from month to month. Ties are judged by an executive committee.

The Kraftfile management has demonstrated that the activities and advanced management practices of the large type of manufacturing plant can be adapted profitably to conditions in the small plant, while still retaining the advantages of that close personal contact between men and management which has taken on added importance under present-day conditions.

CHAPTER GOES FISHING

Southern California Chapter, A.I.A., held its second relaxation meeting at the Rainbow Angling Club in Azusa, August 8. An excellent trout dinner was the outstanding event of the day.

Preceding dinner, the Chapter's piscatorial committee, composed of Earl Heitschmidt, Charles Matcham, Ben O'Connor and H. Roy Kelley, was observed in action along the east bank of the lake. When darkness stopped the activities a report came in to the effect that the committee, with the help of its retinue, had brought five lively trout to gaff, while Arthur Hutchason and his son, Ross, duplicated this catch on the west bank.

Following dinner a round-table discussion of various and sundry subjects was held. President Eugene Weston, Jr., presided.

The following members and guests were present: R. H. Ainsworth, Edgar Maybury, H. Roy Kelley, Ben O'Connor, R. Van Deusen, Charles Matcham, Eldridge Miller, Paul Robinson Hunter, S. B. Marston, George Allison, Earl Heitschmidt, Arthur Hutchason, Ross Hutchason and Eugene Weston, Jr.

STATE BUILDERS CONVENTION

The California State Builders' Exchange, Ltd. is holding its annual convention at the Palace Hotel in San Francisco, September 21, 22 and 23, and it is inviting all builders exchanges and similar organizations throughout the country to participate.

Saturday, September 23, has been set aside as Builders' Exchange day at the Golden Gate International Exposition.

A program for the three days is being planned to include business and entertainment.

Headquarters will be established at the Palace Hotel.

AIR CONDITIONERS TO MEET

The first annual conference of the Heating and Air Conditioning Contractors Association of Southern California and similar groups from San Francisco, Sacramento and Fresno will be held at San Francisco August 18.

Estimator's Guide

Giving Cost of Building Materials, Wage Scale, Etc.

Amounts given are figuring prices and are made up from average quotations furnished by material houses to San Francisco contractors. 3% Sales Tax on all materials but not labor.

All prices and wages quoted are for San Francisco and the Bay District. There may be slight fluctuation of prices in the interior and southern part of the state. Freight cartage, at least, must be added in figuring country work.

Bond—1½% amount of contract.

Brickwork—

Common, \$40 to \$45 per 1000 laid, (according to class of work).

Face, \$100 to \$110 per 1000 laid, (according to class of work).

Brick Steps, using pressed brick, \$1.25 lin. ft.

Brick Veneer on frame buildings, \$.75 sq. ft.

Common f.o.b. cars, \$14.00 at yard. Cartage extra.

Face, f.o.b. cars, \$45.00 to \$50.00 per 1000, carload lots.

HOLLOW TILE FIREPROOFING (f.o.b. job)

3x12x12 in.	\$ 84.00 per M
4x12x12 in.	94.50 per M
6x12x12 in.	126.00 per M
8x12x12 in.	225.00 per M

HOLLOW BUILDING TILE (f.o.b. job)

carload lots.	
8x12x5½	\$ 94.50
6x12x5½	73.50

Building Paper—

1 ply per 1000 ft. roll	\$3.50
2 ply per 1000 ft. roll	5.00
3 ply per 1000 ft. roll	6.25
Brownskin, 500 ft. roll	4.50
Brownskin, Pro-fect-o-mat, 1000 ft. roll	9.00
Stialkret, 500 ft. roll	5.00
Sash cord com. No. 7	\$1.20 per 100 ft.
Sash cord com. No. 8	1.50 per 100 ft.
Sash cord spot No. 7	1.90 per 100 ft.
Sash cord spot No. 8	2.25 per 100 ft.
Sash weights cast iron, \$50.00 ton.	
Nails, \$3.50 base.	
Sash weights, \$45 per ton.	

Concrete Aggregates—

Gravel (all sizes) \$1.45 per ton at bunker; delivered to any point in S. F. County \$1.85.	
	Bunker Delivered
Top sand	\$1.45 1.85
Concrete mix	1.45 1.85
Crushed rock, ¼ to ¾	1.60 2.00
Crushed rock, ¾ to 1½	1.60 2.00
Roofing gravel	1.60 2.00
City gravel	1.45 1.85
River sand	1.40 1.80
Delivered bank sand—\$1.00 per cubic yard at bunker or delivered.	

SAND—

	Bunker Delivered
River sand	\$1.40 1.80
Lapis (Nos. 2 & 4)	2.00 2.40
Olympia, Nos. 1 & 2	1.80 2.20
Healdsburg plaster sand	\$1.80 and \$2.20
Del Monte white50c per sack

CEMENT (all brands, cloth sacks) \$2.72 per bbl. f.o.b. car.; deliv. \$2.90 per bbl., carload lots; less than carload lots, warehouse or delivered, 80c per sack. (Less 10c per sack returned, 2% 10th Prox.)

Common cement (all brands, paper sacks) carload lots \$2.52 per bbl. f.o.b. car.; delivered, \$2.70; less than carloads delivered, 75c per sack. Discount on cloth sacks, 10c per sack. Cash discount on carload lots, 10c a barrel, 10th Prox.; cash discount less than carload lots, 2%.

Atlas White } 1 to 100 sacks, \$1.50 sack,
Calaveras White } warehouse or delivery; over 100
Medusa White } sacks, \$1.25; 2% discount 10th
of month.

Forms, Labors average \$40.00 per M.

Average cost of concrete in place, exclusive of forms, 35c per cu. ft.; with forms, 60c.

4-inch concrete basement floor

.....12½c to 14c per sq. ft.

Rat-proofing

Concrete Steps

.....\$1.25 per lin. ft.

Dampproofing and Waterproofing—

Two-coat work, 20c per yard.

Membrane waterproofing—4 layers of saturated felt, \$4.50 per square.

Hot coating work, \$1.80 per square.

Medusa Waterproofing, 15c per lb., San Francisco Warehouse.

Tricocel waterproofing.

(See representative.)

Electric Wiring—\$12.00 to \$15.00 per outlet

for conduit work (including switches).

Knob and tube average \$3.50 per outlet.

Elevators—

Prices vary according to capacity, speed and type. Consult elevator companies. Average cost of installing an automatic elevator in four-story building, \$2800; direct automatic, about \$2700.

Excavation—

Sand, 60 cents; clay or shale \$1 per yard.

Teams, \$12.00 per day.

Trucks, \$22 to \$27.50 per day.

Above figures are an average without water. Steam shovel work in large quantities, less; hard material, such as rock, will run considerably more.

Fire Escapes—

Ten-foot galvanized iron balcony, with stairs, \$115 installed on new buildings; \$140 on old buildings.

Floors—

Composition Floors—22c to 40c per sq. ft.

In large quantities, 16c per sq. ft. laid.

Mosaic Floors—80c per sq. ft.

Duralflex Floor—23c to 30c per sq. ft.

Rubber Tile—50c to 75c per sq. ft.

Terazzo Floors—45c to 60c per sq. ft.

Terazzo Steps—\$1.60 lin. ft.

Hardwood Flooring (delivered to building)—

	1½x2¼"	¾x2"	¾x2"
	T&G	T&G	Sq. Ed.
Clr. Old. Oak	\$141.00 M	\$109.00 M	\$133.50 M
Sel. Old. Oak	118.00 M	97.00 M	106.50 M
Clr. Pla. Oak	117.00 M	101.00 M	107.50 M
Sel. Pla. Oak	97.00 M	90.00 M	99.00 M
Clr. Maple	120.00 M	94.50 M	

Wage—Floor layers, \$10.00.

Note—Above quotations are all board measure except last column which is sq. ft.

Glass (consult with manufacturers)—

Double strength window glass, 20c per square foot.

Plate 75c per square foot (unglazed) in place, \$1.00.

Art. \$1.00 up per square foot.

Wire (for skylights), 40c per sq. foot.

Obscure glass, 30c square foot.

Glass bricks, \$2.40 per sq. ft., in place.

Note—If not stipulated add extra for setting.

Heating—

Average, \$1.90 per sq. ft. of radiation according to conditions.

Warm air (gravity) average \$40 per register.

Forced air, average \$60 per register.

Iron—Cost of ornamental iron, cast iron

etc., depends on designs.

Lumber (prices delivered to bldg. site).

No. 1 common	\$29.00 per M
No. 2 common	27.00 per M
Select O. P. common	34.00 per M
2x4 No. 3 form lumber	24.00 per M
1x4 No. 3 flooring VG	55.00 per M
1x4 No. 3 flooring VG	47.00 per M
1x6 No. 2 flooring VG	60.00 per M
1¼x4 and 6, No. 2 flooring	60.00 per M

Slash grain—

1x4 No. 2 flooring	\$43.00 per M
1x4 No. 3 flooring	40.00 per M
No. 1 common run T. & G.	30.00 per M
Lath	5.25 per M

Shingles (add cartage to price quoted)—

Redwood, No. 1	\$1.10 per bble.
Redwood, No. 290 per bble.
Red Cedar	1.10 per bble.

Plywood—Douglas Fir (ad cartage)—

"Plyscord" sheathing (unsanded) 5/16" 3-ply and 48"x96"	\$32.50 per M
"Plywall" (wallboard grade)— ¼" 3-ply 48"x96"	35.00 per M
"Plyform" (concrete form grade)— ¾" 5-ply 48"x96"	100.00 per M
Exterior Plywood Siding— 7/16" 5-ply Fir	\$9.00 per M
Redwood	\$100.00 per M

Millwork—Standard.

O. P. \$85.00 per 1000. R. W., \$90.00 per 1000 (delivered).

Double hung box window frames, average with trim, \$6.50 and up, each.

Doors, including trim (single panel, 1¾ in. Oregon pine) \$8.00 and up, each.

Doors, including trim (five panel, 1¾ in. Oregon pine) \$6.00 each.

Screen doors, \$3.50 each.

Patent screen windows, 25c a sq. ft.

Cases for kitchen pantries seven ft. high per lineal ft., \$8.00 each.

Dining room cases, \$8.00 per lineal foot. Rough and finish about 75c per sq. ft.

Labor—Rough carpentry, warehouse heavy framing (average), \$17.50 per M.

For smaller work average, \$35.00 to \$45.00 per 1000.

Marble—(See Dealers)

Painting—

Two-coat work	per yard	42c
Three-coat work	per yard	60c
Cold water painting	per yard	10c
Whitewashing	per yard	4c
Turpentine, 65c per gal., in 5 gal. cans, and 55c per gal. in drums.		
Raw Linseed Oil—79c gal. in light drums.		
Boiled Linseed Oil—82c gal. in drums and 72c in 5 gal. cans.		

White Lead in oil

1 ton lots, 100 lbs. net weight.....	Per lb.	1 1/4c
500 lbs. and less than 1 ton.....		1 1/2c
Less than 500 lb. lots.....		12c

Red Lead and litharge

1 ton lots, 100 lbs. net weight.....	1 1/4c
500 lbs. and less than 1 ton.....	1 1/2c
Less than 500 lb. lots.....	12c

Red Lead in oil

1 ton lots, 100 lbs. net weight.....	1c
500 lbs. and less than 1 ton.....	1 1/4c
Less than 500 lb. lots.....	12 1/4c

Note—Availability and conditions cause some variance in costs.

Patent Chimneys—

6-inch	\$1.25	lineal foot
8-inch	1.75	lineal foot
10-inch	2.25	lineal foot
12-inch	3.00	lineal foot

Plastering—Interior—

1 coat, brown mortar only, wood lath	Yard	\$0.60
2 coats, lime mortar hard finish, wood lath70
2 coats, hard wall plaster, wood lath72
3 coats, metal lath and plaster		1.25
Keene cement on metal lath.....		1.30
Ceilings with 3/4 hot roll channels metal lath (lath only)		1.10
Ceilings with 3/4 hot roll channels metal lath plastered		1.85
Single partition 3/4 channel lath 1 side (lath only)85

Single partition 3/4 channel lath 2 inches thick plastered	\$2.90
4-inch double partition 3/4 channel lath 2 sides (lath only)	1.70
4-inch double partition 3/4 channel lath 2 sides plastered	3.80
Thermax single partition; 1" channels; 2 1/4" overall partition width. Plastered both sides	2.50
Thermax double partition; 1" channels; 3 1/4" overall partition width. Plastered both sides	3.10
3 coats over 1" Thermax nailed to one side wood studs or joists	1.25
3 coats over 1" Thermax suspended to one side wood studs with spring sound isolation clip	1.40

Plastering—Exterior—

2 coats cement finish, brick or concrete wall	\$1.00
3 coats cement finish, No. 18 gauge wire mesh	1.50
Wood lath, \$7.50 to \$8.00 per 1000.....	
2.5-lb. metal lath (dipped)17
2.5-lb. metal lath (galvanized)20
3.4-lb. metal lath (dipped)22
3.4-lb. metal lath (galvanized)28
3/4-inch hot roll channels, \$72 per ton.	
Finish plaster, \$19.90 ton; in paper sacks.	
Dealer's commission, \$1.00 off above quotations. \$13.85 (rebate 10c sack).	
Lime, f.o.b. warehouse, \$2.25 bbl; cars, \$2.15	
Lime, bulk (ton 2000)	\$16.00 ton.
Wall Board 5 ply, \$50.00 per M.	
Hydrate Lime, \$19.50 ton.	
Plasterers' Wage Scale	\$1.67 per hour
Lathers' Wage Scale	1.50 per hour
Hoist Carriers' Wage Scale	1.25 per hour
Composition Stucco—\$1.80 to \$2.00 sq. yard (applied).	

Plumbing—

From \$70.00 per fixture up, according to grade quantity and runs.

Roofing—

"Standard" tar and gravel, \$6.50 per sq. for 30 sqs. or over.
 Less than 30 sqs. \$7.00 per sq.
 Tile, \$20.00 to \$35.00 per square.
 Redwood Shingles, \$7.50 per square in place.
 Copper, \$16.50 to \$18.00 per sq. in place.
 Cedar Shingles, \$8.00 per sq. in place.
 Recoat, with Gravel, \$3.00 per sq.
 Asbestos Shingles, \$15 to \$25 per sq laid.

Slate, from \$25.00 per sq., according to color and thickness.	
Shakes—1x25" resawn	\$11.50 per sq.
1/2x25" resawn	10.50 per sq.
1/2x25" tapered	10.00 per sq.
Above prices are for shakes in place.	

Sheet Metal—

Windows—Metal, \$1.75 a sq. foot.
 Fire doors (average), including hardware, \$1.75 per sq. ft.

Skylights—(not glazed)

Copper, 90c sq. ft. (flat).
 Galvanized iron, 30c sq. ft. (flat).
 Vented hip skylights 60c sq. ft.

Steel—Structural

\$120 ton (erected), this quotation is an average for comparatively small quantities. Light truss work higher. Plain beams and column work in large quantities \$90 to \$100 per ton.

Steel Reinforcing—

\$80.00 to \$120.00 per ton, set.

Stone—

Granite, average, \$6.50 cu. foot in place.
 Sandstone, average Blue, \$4.00. Boise, \$3.00 sq. ft. in place.
 Indiana Limestone, \$2.80 per sq. ft. in place.

Store Fronts—

Copper sash bars for store fronts, corner, center and around sides, will average 75c per lineal foot.
 Note—Consult with agents.

Tile—Floor, Wainscot, etc.— (See Dealers)

Asphalt Tile—18c to 28c per sq. ft. installed.

Wall Tile—

Glazed Terra Cotta Wall Units (single faced) laid in place—approximate prices:
 2 x 6 x 12

1.00 sq. ft.

4 x 6 x 12

1.15 sq. ft.

2 x 8 x 16

1.10 sq. ft.

4 x 8 x 16

1.30 sq. ft.

Veneen Blinds—

40c per square foot and up. Installation extra.

THE BUILDERS' EXCHANGE OF SAN FRANCISCO STANDARD WAGE SCALE

For mechanics employed on construction work in the Bay Region. Effective September 1, 1937

CRAFT	Journeymen Mechanics
Asbestos Workers	\$ 8.00
Bricklayers (8h-5d)	10.50
Bricklayers' Hodcarriers (6h-5d)	6.75
Cabinet Workers (Outside) (5d)	8.00
Caisson Workers (Open)	6.40
Carpenters (8h-5d)	10.00
Cement Finishers (8h-5d)	10.00
Cork Insulation Workers (8h-5d)	9.00
Electric Workers (8h-5d)	11.00
Electrical Fixture Hangers	8.00
Elevator Constructors	10.40
Engineers, Portable & Hoisting	6.00
Glass Workers (8h-5d)	9.68
Hardwood Floormen	9.00
Housesmiths, Architectural Iron (Shop) (8h-5d)	9.00
Housesmiths, Architectural Iron (Outside) (8h-5d)	10.00
Housesmiths, Reinforced Concrete or Rodmen (8h-5d)	10.00
Iron Workers (Bridge and Structural) Including Engineers (8h-5d)	12.00

CRAFT	Journeymen Mechanics
Laborers, Building (8h-5d)	\$ 6.00
Laborers, Common (8h-5d)	6.00
Lathers, Chanson Iron (8h-5d)	9.00
Lathers, All Others	9.00
Marble Setters (8h-5d)	10.50
Marble Setters' Helpers (8h-5d)	6.50
Millwrights	9.00
Model Makers (\$1.50 per hr-6h)	9.00
Modelers (\$2 per hr-6h)	12.00
Model Casters	7.20
Mosaic and Terrazzo Workers (Outside)	9.00
Painters (8h-5d)	8.75
Painters, Varnishers and Polishers (Outside)	9.00
Pile Drivers and Wharf Builders	9.00
File Drivers' Engineers	10.00
Plasterers (6h-5d)	10.00
Plasterers' Hodcarriers (6h-5d)	7.50
Plumbers (8h-5d)	11.00
Roofers, Composition (8h-5d)	9.00
Roofers, All Others (8h-5d)	8.00
Sheet Metal Workers (8h-5d)	10.00
Sprinkler Fitters	10.00

CRAFT	Journeymen Mechanics
Steam Fitters (8h-5d)	\$11.00
Stair Builders (8h-5d)	9.00
Stone Cutters, Soft and Granite (8h-5d)	8.00
Stone Setters, Soft and Granite	12.00
Stone Derrickmen	9.00
Tile Setters (8h-5d)	11.00
Tile Setters' Helpers (8h-5d)	6.50
Tile, Cork and Rubber (8h-5d)	9.00
Welders, Structural Steel Frame on Buildings	11.00
Welders, All Others on Buildings	9.00
Dump Truck Drivers, 2 yards or less	6.00
Dump Truck Drivers, 3 yards	6.50
Dump Truck Drivers, 4 yards	7.00
Dump Truck Drivers, 5 yards	7.50
Dump Truck Drivers, 6 yards	7.00
Truck Drivers of Concrete Mixer Trucks:	
2 yards or less	6.50
3 yards	7.00
4 yards	7.50
5 yards	7.50
6 yards	8.00

GENERAL WORKING CONDITIONS

- Eight hours shall constitute a day's work for all crafts except as otherwise noted.
- Plasterers', Hodcarriers', Bricklayers', Hodcarriers', Roofers', Laborers, and Engineers, Portable and Hoisting shall start 15 minutes before other workmen, both at morning and at noon.
- Five days, consisting of not more than eight hours a day, on Monday to Friday inclusive, shall constitute a week's work.
- Transportation costs in excess of twenty-five cents each way shall be paid by the contractor.
- Overtime shall be paid as follows: For the first four hours after the first eight hours, time and one-half. All time thereafter shall be paid

- double time. Saturdays (except Laborers), Sundays and holidays, from 12 midnight of the preceding day, shall be paid double time.
- On Saturday, Laborers shall be paid straight time for an eight-hour day.
- Where two shifts are worked in any twenty-four hours, shift time shall be straight time. Where three shifts are worked, eight hours' pay shall be paid for seven hours on the second and third shifts, allowing one-half hour for lunch.
- All work, except as noted in paragraph 9, shall be performed between the hours of 8 a.m. and 5 p.m.
- In emergencies, or where premises cannot be vacated until the close of business, men then

- reporting for work shall work at straight time. Any work performed on such jobs after midnight shall be paid time and one-half up to four hours of overtime and double time thereafter, provided, that if a new crew is employed on Saturdays, Sundays or holidays which has not worked during the five preceding days, such crew shall be paid time and one-half.
- Recognized holidays to be: New Year's Day, Decoration Day, Fourth of July, Labor Day, Admission Day, Thanksgiving Day, Christmas Day.
- If men ordered to report for work, for whom no employment is provided, shall be entitled to two hours' pay.

"BUILDING MERCHANTS" COULD SOLVE HOUSING PROBLEMS

THE key to small house construction at low cost is "a group of high class building merchants" able to assemble land and buy it on the best cash price basis, a report to the American Institute of Architects by Emery Stanford Hall, Fellow of the Institute, declares. The chief indictment of the small house offered for sale today is that no skilled organized knowledge has been put into the building operation, the report says.

Economies and other advantages made possible by "building merchant" cooperation would allow the family with moderate means to buy a well-styled, personalized home, produced at quantity production prices, at the same time adequately remunerating all the personnel involved in the construction, it is asserted.

Such a program would completely divorce finance from building and would employ the best architectural talent to plan the arrangement and use of the land to greater advantage.

"The architects for such an organization would be instructed to study social and market demands for buildings, and to design buildings adapted to wholesale production and calculated to anticipate the requirements of prospective buyers," the report explains.

"The building merchant can work on a sufficiently large scale to support a strong financial organization of the kind that can establish large credit so as to be able to obtain money for emergency needs, promptly, and at reasonably low rates of interest, buy for cash, and sell on the extended payment plan.

"To insure the highest degree of production efficiency, the architects would be required to undertake exhaustive research as to cost, character, quality, and availability of materials suited for use in the project in hand. In other words, they would be expected to know the building material market and the exact installed cost and adaptability to purpose of the various products that are offered.

"Contrary to common practice in small house construction, each building unit can and should be carefully designed, both from an artistic and a practical standpoint, and very competently and completely detailed. Every item entering into the building should be numbered and listed, showing exact cutting diagrams and placement position. Not a single item should be left to cut-and-try methods. The quantity survey should be prepared so completely and be so exactly correct as to leave no element of doubt in the mind of the competent bidder.

"With this data assembled, the architect would take bids and let contracts to separate trade contractors; would supervise construction; audit accounts, and finally issue certificates of completion. Buildings thus designed and completed could then be sold by the building merchant on a definitely understood margin of profit, on

either a cash basis or an extended payment plan, according to customer needs. Building securities backed by such a set-up would form the most reliable type of investment.

"Building operations would be on sufficiently large scale to enable the employment and adequate remuneration of the very best impartial technical skill. Because of the size of the operation, this service can be provided and yet not add a prohibitive unit charge against any single building.

"The employment of the best unbiased technical services is not a luxury but a real essential in small house building. The chief indictment of the small house that is offered on the market today is that no skilled organized knowledge has been mixed with the material.

"The plan would permit of comprehensive plot-planning and the possibility of deed restrictions to insure the permanent character of the neighborhood, and the building of customer good-will, all to the end of assuring permanently satisfactory neighborhood conditions. Permanency in neighborhood conditions spells stability of investment.

"Architects, in the case of large group planning, can produce a wide variety of attractive designs to suit all needs and at the same time devise interchangeable standards for unit parts, in this way effecting great saving in production costs. It should be observed that worth while standards must be based on exhaustive research involving a prohibitive expense if spread on a single building unit, but not a noticeable overhead per unit, on a large collection of units.

"By letting contracts direct to the separate trade contractors, the waste incident to the employment of the broker-general contractor is saved. This system facilitates the careful selection of bidders on the basis of established integrity, technical competency, character of equipment, and financial responsibility. No contract should be awarded to any separate trade-contractor who has not himself, or through his manager, mastered the trade or trades on which he, or it, assumes to execute a contract. Of course a reputation for honesty is essential to any business transaction.

"Impartial technical supervision of a large project which is made up of small units planned with uniform parts of established standard, can be handled through the suggested program with a high degree of efficiency at a reasonably small cost per unit. Also, the certificate of the competent impartial architect, working under conditions as described, amounts to a certain guarantee to the merchant in building that the merchandise which he has to offer to his customers is of a kind he can stand back of. At the same time, it is an assurance to the prospective buyer that he is getting exactly what is represented at a correctly fair price.

"Guaranteed quantity surveys and cutting lists fur-

USHA Favors Segregated Bids for Low Rent Housing Projects

THE \$800,000,000 slum-clearance and low-rent rehousing program, now going forward on a national scale under direction of the United States Housing Authority, is of such a decentralized nature that sole responsibility for initiating, letting of contracts, constructing and managing the projects rests on the shoulders of the local housing authority in the locality where the development is built.

Contractors who are successful in bidding on any low-rent rehousing project will be responsible only to the local housing authority which, in every case, will award all contracts.

Nathan Straus, Administrator of the United States Housing Authority, emphasized that while the USHA retains a certain degree of supervision over local authorities in the development of housing projects from the acquisition of land to the selection of tenants, this will not extend beyond the limits needed to assure compliance with the details of both the United States Housing Act and the loan contract under which the USHA lends the local housing authority 90 per cent of the total development cost of the low-rental rehousing project. At no time should this supervision lead to additional costs which might be reflected in higher bids by contractors.

In the interest of cooperation between the Federal and local agencies, Administrator Straus has designated a USHA Construction Adviser to act in a purely advisory capacity and render service and suggestions to the local authority on the site of each housing project. But the Adviser is specifically prohibited at all times from giving orders to the contractor.

While the USHA will review the plans and specifica-

nished with the architect's plans, as is done in England, eliminates uncertainty and would completely eliminate the waste incident to each bidder taking off his quantities, as has been the custom in this country. This practice would also operate as an effective check on the collusive hold-up which is so often correlative of contractors' association quantity surveys.

"Where quantity surveys are made by contractors' organizations, the contractor is usually required to file his bid with his association. Despite all disclaimers of intent, eventually such a practice is bound to fruit in collusion between bidding contractors. It should be understood that fair competition is essential to keeping the cost of building where it ought to be. Fair competition can only be had when the quantity and quality of materials and workmanship are alike exactly known by all bidders, and secret bids are, in each case, submitted to the architect in charge without any intermediary contractors' association."

tions for the project and furnish technical assistance, responsibility for design and specifications and for observance of all the loan contract requirements rests with the local housing authority.

At the same time, while the USHA is permitted to observe and review all work, materials, payrolls and other relevant records and data, all instructions and approvals with respect to the work shall be given to the contractor only by the local authority or the architect.

Under the policy of the USHA all work will be performed on a "Fixed Price Contract" basis. In addition the USHA recommends that local housing authorities divide their projects into several sections, in order that bids may be made on each section in addition to the entire contract. This will enable smaller contractors, who would be unable to undertake such mammoth developments as are most low-rent housing projects under the USHA program, to bid on a part of the contract, thereby encouraging wider competition among several bidders.

In preparing the form of contract documents recommended by the United States Housing Authority for use by the local authorities, the standard forms of contract documents approved by the American Institute of Architects have been generally followed with only such modifications or additions as are required to conform to Federal or State statutes and the policies of the United States Housing Authority.

Thus, the forms approved by the USHA for use on low-rental housing projects compare in simplicity to the requirements used generally by private industry.

When advertising for bids, the local housing authority will allow prospective bidders ample time to examine the contract documents and to inspect the site for the purpose of preparing their estimates. Likewise, a reasonable time will be given in which to complete the contract work. The USHA has recommended that bidders be given an opportunity to specify (within a limited range) a shorter time in which they may elect to complete the contract. In evaluating bids, consideration would be given to any shorter time that might be specified by the bidder and his bid price will be reduced for the purpose of evaluating his bid by a stated amount for each day less than the time specified by the local authority.

In general, the successful bidder will be required to furnish a payment and performance bond in an amount equal to 50 per cent of the contract price.

Of particular interest to contractors is the approved method for their payment by the local authority. Partial payments will be made as the work progresses on not later than the fifteenth day of each month for work done during the preceding calendar month on esti-

(Turn to Page 66)

MODERNIZED PRODUCTS

Brief Notes on New Materials and Equipment in the Building Industry.

254. "PHANTOM DOORMAN"

The Yale-Towne Mfg. Company have issued a small folder on their new product, "The Phantom Doorman," illustrating the main features and details of this particular product which is a departure in modern door hardware. The coupon will bring you data.

255. GALVANIZED METAL

"Galv-A-Niel," a new quick and economical treatment for old and new galvanized metal is detailed in a folder put out by the Mar-Nell Chemical Company. This should prove of more than considerable interest to the profession and building trades.

256. LOG CABINS

The National Lumber Manufacturers Association have issued a booklet, interesting and delightful. It is called Vacation Cabins, built with log cabin siding. Pictures of several log houses, week-end cabins and mountain hunting and fishing lodges are included and small scale plans accompany each picture. Send for your copy by clipping the coupon.

257. MARBLE

From the Vermont Marble Company comes a new brochure entitled "Modernize With Marble"; it contains some worthwhile and timely information upon the important subject of using the proper marble in the proper place.

258. POWER UNITS

Diesel Electric Power is illustrated in a booklet put out by the Buda Company. Plants in public and semi-public buildings are shown and the details of these power units given. The coupon will bring your copy.

259-60. MAGNET WIRE

The Anaconda Copper Company have a new catalogue on magnet wire

and coils which has a world of useful informative data with tables and specifications. The proper insulation of these important wires is given considerable space and detail.

The same company have also issued a small hand book giving much of the same detail in a condensed form for pocket use in the field. The coupon will bring both of these useful books to you.

261. IRON VALVES

There is a new comer in this page this month — Jenkins Brothers have sent a booklet on their 125 lb. iron valves. The booklet has been titled "The Inside Story." There is much of interest contained therein. Send for it.

262. MONEL METAL

The International Nickel Company have a brochure on monel metal, "K" Monel, Inconel and "Z" Nickel. Send for your copy by using the coupon.

263. PINE INTERIORS

Typical American rooms are being shown in a small folder put out by the Western Pine Association. Their previous books and pamphlets have been exceedingly interesting, as is the present one.

264. HARDWARE

Yale locks and builders hardware for use in hospitals for mental defectives is the subject matter of a very fine brochure issued by the Yale-Towne Mfg. Co. Considerable detail and some specifications as well as drawings and sketches. Send for your copy by using the coupon.

265. DOUGLAS FIR DOORS

A new catalogue of "Tru-Fit" Douglas fir doors has arrived and has been found to contain excellent information with detailed sketches and specifications. This catalogue is from the Douglas Fir Door Institute. The coupon will bring your copy.

266. "ARCO-FLAME"

The American Radiator and Standard Sanitary Company have sent us their new folder on "Arco-Flame." Full details and illustrations are contained in the pages of a very interesting and well arranged folder.

267. LIGHTING

New modern lighting equipment is illustrated in the broadside just received from the Pittsburgh Reflector Company. Here some of the newest and most modern advances in lighting fixtures are illustrated. Send for a copy.

FREE FOR THE ASKING

Check items on coupon, paste on letter head or postal card, and mail to Architect and Engineer.

Architect and Engineer
68 Post Street
San Francisco, Calif.

Please send me literature on the following items as checked below. This request places me under no obligation.

254 <input type="checkbox"/>	262 <input type="checkbox"/>
255 <input type="checkbox"/>	263 <input type="checkbox"/>
256 <input type="checkbox"/>	264 <input type="checkbox"/>
257 <input type="checkbox"/>	265 <input type="checkbox"/>
258 <input type="checkbox"/>	266 <input type="checkbox"/>
259-60 <input type="checkbox"/>	267 <input type="checkbox"/>
261 <input type="checkbox"/>	

My Name.....

Name of Company.....

Street.....

City..... State.....

AQULUX 85

NEW Oil Burning Water Heating Unit

This powerful and compact vertical unit, beautiful in appearance, is designed to supply hot water at a minimum cost in the modern home. It can also be used to supply heat and hot water automatically for small homes without the necessity for basement installation. Complete data on this new "package unit" now ready.

Burns No. 3 C. S. G.
fuel or Diesel oil

S. T. JOHNSON CO.

940 ARLINGTON, OAKLAND, CALIF.
401 N. BRDAD ST., PHILADELPHIA, PA.



SEGREGATED BIDS, U. S. HOUSING

(Continued from Page 64)

mates certified to by the architect and signed by the authority. Such estimates must be submitted at least ten days in advance of the date set for payment.

In making these partial payments the local authority will retain 10 per cent of the estimated amount until final completion and acceptance of all the work. If, however, after 50 per cent of the work has been completed, the architect certifies that satisfactory progress is being made, the remaining payments will be made in full.

Payments to the contractor will be made on the certification of the architect or the local authority without the necessity of obtaining the approval of such payments by the USHA prior to their being made. Under the procedure set up, it is contemplated that sufficient funds will be advanced by the USHA so that all payments to the contractor can be made promptly when due, and the financial procedure has been so worked out that requests by the local authority for the advance of funds under the loan agreement with the USHA can be acted on without any delays, eight hours after its receipt by the USHA. By this means, it is believed that the contractor will be saved from any inconvenience which might be occasioned by delay in making partial payments under his contract.

Meanwhile, to insure that the \$800,000,000 program will go forward without needless delays, agreements are being reached between the local housing authorities (with the aid and advice of the USHA) and local building and trades labor councils throughout the country aimed at preventing a stoppage of operations because of labor disputes. Such agreements have already been signed with more than 60 building trades councils of the American Federation of Labor and with more than 160 local unions.

These agreements, widely hailed as an outstanding accomplishment, provide:

1. That in case jurisdictional disputes arise on any project, there will be no stoppage of work until such time as the Building and Construction Trades Department of the A. F. of L., the local housing authority and the USHA have had full opportunity to adjust the differences between the trades; and

2. That wage rates in effect at the time work is commenced on any contract unit of a low-rent housing project of the USHA program shall remain in effect until completion of the project.

In line with the policy of decentralization of the United States Housing Act, the United States Housing Authority has recommended to the local authorities a simple and expeditious procedure for the construction of low-rent housing projects. Under these procedures, it is expected that contractors should experience no more difficulty in preparing their bids and performing work under their contracts for low-rent housing projects than they would encounter in bidding and working on a private contract of similar size.

A good investment—

is a well designed, well built,
structure, properly located.

Lindgren & Swinerton, Inc.

have been building substantial
buildings for over a half of a cen-
tury, are still building them and
will continue building them for
another half of a century.

Lindgren & Swinerton, Inc.

Standard Oil Building
San Francisco
619 H Street
Sacramento

605 W. Olympic Boulevard
Los Angeles
1723 Webster Street
Oakland

ALL-WELDED GIRDER TEST

Completion in England of successful tests of an all-welded model of a plate girder which will contribute to a better understanding of many engineering problems encountered in building the full size all-welded structures employed in skyscrapers, bridges, ships and houses, is reported by the Welding Research Committee of the Engineering Foundation.

The cost of experimenting with models weighing less than sixty pounds is but a fraction of that entailed in using the ordinary girder weighing more than 7,000 pounds, it is explained, making it possible to investigate a wider variety of designs and methods of fabrication. The results of such studies will lead to more economical and safer constructions, the report declares.

Data obtained from the tests are extremely important today, it is pointed out, because of the increased demand for all-welded structures in pre-fabricated homes, low cost housing projects, shipbuilding and other forms of construction. This trend is attributed to the fact that the all-welded structures are lighter, cheaper, as strong or stronger than the riveted type.

In the shipbuilding industry, for example, statistics compiled by the American Bureau of Shipping for the American Welding Society reveal that, in 1938, 138 of the 155 vessels under 300 feet constructed were all-welded. In 1930, of the nearly 120 vessels built, less than five were all-welded. In recent years larger ships, including 18,000-ton oil tankers, have been all-welded.

The model used in the experiments weighed fifty-eight pounds, or 1/125th as much as its prototype. It was fashioned of fourteen-gauge steel and was eight feet two inches long with a depth of nine and one-quarter inches.

Most important result of the tests from the point of view of the building industry was the substantiation of the belief in welding circles that external loading releases, in a considerable degree, residual strains and stresses in correctly designed all-welded mild steel structures.

Engineers have long been critical of all-welded girders, it is explained, doubting their ability to hold up under heavy external loadings because of the strains and stresses put into the girders themselves by the welding process. The experiments revealed that as far as static loads were concerned, their application relieved these inner strains and stresses.

"By means of electric arc, or fusion welding, the maintenance of geometrical similarity between steel models and the full sized construction is greatly facilitated, provided that the difficult operation of welding thin gauge metal has first been successfully mastered," the report says.

"Models made by this process are particularly apt and useful. Not only may the welding procedures and

A Forced - Air Furnace For Smaller Homes

BURNS CHEAP DIESEL OIL

In the next moderate size house you design, specify the New H. C. Little "Cottage" Furnace Burner Unit with Fan — and give your client one of the most economical heating units on the market today.

ADDED FEATURES

- Quicker, more complete circulation of warm air.
- Rapid removal of cold air.
- Increased efficiency.
- Greater uniformity of heat in every room.
- "Dead Air," and hot or cold zones eliminated.
- Easy, low cost installation.
- Low upkeep cost.

For complete details write
Dept. A 1.



H. C. Little Burner Co.

Dept. A1

San Rafael

California

No Worry for the Architect

*"—All acid proof drain pipe and fittings
shall be ferro-silicon—CORROSIRON—"*

[Write for this specification]



FEDERAL BUILDING • CIVIC CENTER • SAN FRANCISCO

Arthur Brown, Jr., Architect

CORROSIRON DRAIN LINES and FITTINGS
and LABORATORY EQUIPMENT was specified because of its superior resistance to corrosion and wear.

Pacific Foundry Company, Ltd.

NEW YORK • 3100 NINETEENTH ST., SAN FRANCISCO • LOS ANGELES

The Electric Wiring

in the new

Modern Hastings

INSTALLED BY

Edward J. Lynch Electric Co.

2080 SUTTER ST., SAN FRANCISCO

Telephone Fillmore 1210

EDWARD J. LYNCH, JR.

EDWARD W. SCOTT

POMONA TILES

FOR

**Bathrooms and Kitchens
in over 60 colors**

Warehouses and Display Rooms

135 Tenth St. San Francisco

629-33 North La Brea Ave. Los Angeles

6106 Roosevelt Way Seattle

POMONA TILE MFG. CO.
PLANT — POMONA, CALIF.

STRUCTURAL STEEL

For Class A Buildings,
Bridges, etc.

JUDSON PACIFIC CO.

1200 SEVENTEENTH STREET
SAN FRANCISCO

Plants: San Francisco - Oakland

A Permanent Exposition
of the newest ideas
in home planning
and equipment.



THE BUILDING MATERIAL EXHIBIT

Architects Bldg. • Fifth & Figueroa • Los Angeles • MU-6306

the resulting residual strains and stresses be exactly estimated but also the behavior of the finished product under pre-determined loads may be predicted.

"Tests with the model proved that correct welding procedures applicable to electric arc welding in naval architecture and structural and mechanical engineering may be quickly studied at small cost, thus enabling a more intensive program of research pointed toward obtaining more economical and safer structures."

REDISCOVERY OF MARBLE

The American Institute of Architects in its recently issued structural research bulletin "rediscovers" that marble is a "decorative and social necessity in the home," because it insures harmony in the natural blending of color tones and does away with the periodic expense of conditioning which most other materials require. It is good to know that the A.I.A. research bureau places its stamp of approval on marble for home decoration after trying scores of imitation, "just-as-good" and what have you products.

If there is one thing in the home that strikes to the very heart strings of the entire family it is the fireplace. The stage setting misfits that can be had in department stores and come knocked down ready to set up against a wall, with papier mache or some other equally frail material as a backing for a thin strip of wall paper in a marble design for the facing, just don't fill the bill. The well-informed home seeker or builder knows his fireplace and he wants something that radiates both heat and cheerfulness, with a bit of color and a lot of stability and honesty about it.

To supplement this rediscovery of marble for the facing of fireplaces and for other uses in the home, there is now available Research Bulletin No. 29 of Vermont Marble, known as Mantels of Marble.

\$4,000,000 CEMENT BUILDING

The Henry J. Kaiser Company of San Francisco, bidding as the Permanente Corporation on the entire 5,800,000 barrels of low heat cement for Shasta Dam, for which proposals have been asked, have already started on a \$4,000,000 cement plant near Cupertino, Santa Clara County, regardless of objections cited by property owners that the plant would prove a nuisance. A permit has been granted by the Board of Supervisors of Santa Clara County for operation of the plant.

NEW QUARTERS

George W. Groves and William A. Reese, Jr., architects, have moved to newly equipped quarters in Room 804, Textile Tower, Seattle. Plans for new residences are moving steadily along their boards. They also handle a fair volume of commercial work.

HELPING DISTRESSED HOME OWNERS

Collections from borrowers and sales of homes by the Home Owners' Loan Corporation set an all-time record during the first six months of 1939 and closed a fiscal year which showed the Corporation making decisive progress in its dual functions of rehabilitating distressed home owners and liquidating the properties it has been forced to acquire.

Collections in June were 100.3 per cent of the monthly billings and for the six-month period were nearly 97 per cent—far above the 93.8 per cent figure for the first six months of 1937 and 89.3 per cent for the first six months of 1938, and topping the previous high figure of the last six months of 1937, which was 96.5 per cent, according to Charles A. Jones, General Manager of the Corporation.

The sale of homes was still more significant, as a barometer of business conditions and recovery in the real estate market, Mr. Jones reported. A record sale of 4,638 homes in June brought the cumulative sales by the Corporation to a figure of 55,303. During the fiscal year, the Corporation disposed of 37,771 properties, as compared to 17,532 sold prior to June 30, 1938. Approximately 20,700 sales were made in the last six months of 1939.

"Borrowers of the Corporation have paid back approximately \$615,000,000 of their principal indebtedness," said Mr. Jones. "More than 84 per cent of our active accounts are in satisfactory condition—current or less than three months in arrears, or in a liquidating class, which means such borrowers are meeting all current bills and making regular monthly payments on their arrearages.

"About 726,000 of our borrowers—all of whom were facing the loss of their homes a few years ago—now are clearly on their way to home ownership, or already have paid up their accounts in full. More than 125,000 others have kept their accounts open for a period ranging from three to six years and the great majority will 'come through.'

"Congress gave the Corporation a double job—of rehabilitating home owners and liquidating the losses inevitable in foreclosures. Both are being met. As was to be expected, the Corporation has sustained capital losses on the properties it has acquired and sold, but

Lighting Fixtures

for ALL THREE new HASTINGS stores in San Francisco were produced by us in collaboration with Robert L. Dearborn, Lighting Engineer

WESTERN LIGHTING FIXTURE CO.

Designers and Manufacturers of
DISTINCTIVE LIGHTING FIXTURES

Store - Theater - Commercial

70 IVY ST., SAN FRANCISCO
WM. H. HOLLOPETER

HEMLOCK 5390
E. J. FLETCHER



PRODUCTS

VAN ARSDALE-HARRIS CO.

ENGINEERS & CONTRACTORS

ACOUSTICAL TREATMENT - INSULATION
SOUND CONTROL

FIFTH & BRANNAN STS. SAN FRANCISCO, CALIF.
TELEPHONE GARfield 3600
DIVISION

VAN ARSDALE-HARRIS LUMBER CO., INC.

NOISE CONTROL— ON TREASURE ISLAND

STATE AUDITORIUM AND RADIO STUDIOS
BELL TELEPHONE SYSTEM EXHIBIT
SAN FRANCISCO RECREATION EXHIBIT
FEDERAL BUILDING THEATER

Furnished by—

WESTERN ASBESTOS CO.

Building Materials *Mechanical Specialties*
SACRAMENTO OAKLAND
SAN FRANCISCO

The HASTING'S floors are the **NEWEST** idea in LINOLEUM

PABCO MARBLED SQUARES

individual • colorful • decorative • do not
show dirt or foot marks • seams are invisible •
any 9" area can be replaced, if damaged • factors
of definite importance to every building owner . . .

TURNER RESILIENT FLOORS, INC.

141 NEW MONTGOMERY ST., SAN FRANCISCO

EXBROOK 8369

MODERN EFFICIENCY *demands* WIRING ADEQUACY



Streamlined automobiles of 1939 type would be of little use on roads adequate for the horse and buggy. No one questions the wisdom of highway development's keeping pace with automobile development.

Yet many expect the electrical highway in commercial buildings to accommodate 1939 traffic with wiring barely adequate ten or fifteen years ago.

Tremendous increase in use of electrically driven office machinery, beauty parlor equipment, and scores of other devices, together with the growing demand for better light, is bringing many building owners to shocked realization that their comparatively new buildings fail to attract tenants because of electrical inadequacy.

The architect may not feel that the responsibility is his, but unless he has suggested, in fact strongly urged, liberal wiring provision at the time of building, some criticism is sure to fall upon him.

Include wiring adequacy in your recommendations.

•
See the electrical exhibits at the Palace of Electricity and Communications at the Golden Gate International Exposition

•

PACIFIC COAST ELECTRICAL BUREAU

447 SUTTER STREET • SAN FRANCISCO, CALIFORNIA

not because it has failed to retrieve the money represented in the loans it made. The loss of principal and interest incurred in extending leniency to borrowers who failed to rehabilitate themselves, large tax delinquencies, the costs of foreclosure and of reconditioning properties which deteriorated over a period of years, are written into our capital losses.

"We still have more than 87,000 properties on our books. The great majority are rented, awaiting sale. Most of the rest are being repaired and remodeled to make them attractive to the home seeking public. We are making sales as fast as the market warrants. The fact that we have been disposing of properties at the rate of more than 4,000 a month recently, without affecting the stability of that market, speaks well for business conditions throughout the country. If our figures on both collections and sales can be taken as a barometer, they are considerably better than in the best period of 1937."

HASTINGS MERCHANDISE DISPLAY

In creating the Modern Hastings Stores, the very finest talent and craftsmanship were called upon to make the interiors attractive, inviting and convenient for sales efficiency. B. R. Paradise, store specialist, is responsible for many of the new ideas that have been carried out in store plan and arrangement.

The first and second floors of the Post and Kearny store present beauty in woodwork and display fixtures, as well as ideal merchandise arrangement. These fixtures were manufactured and installed by the Oakland firm of S. Kulchar & Company who have served bay-region architects and leading store owners for many years. The first floor fixtures in the Market Street store were also made and installed by Kulchar.

Resilient floors throughout the Post-Kearny and the Market Street stores, are of factory die-cut Pabco linoleum installed by Turner Resilient Floor Company, J. A. Mancini, San Francisco manager, who personally supervised the installation of the individual pieces, all in the latest modern design.

HASTINGS ELECTRICAL INSTALLATION

Modern Hastings includes the very latest lighting installation and electrical equipment. The intricate system for lighting, signal and service was installed by the Edward J. Lynch Electric Co. of San Francisco. This firm specializes in wiring installations for large commercial and public buildings, in addition to a general electric service for residences.

The splendid indirect lighting fixtures in the Hastings Stores were manufactured by the Western Lighting Fixture Company—a San Francisco firm specializing in store, theater and commercial lighting. The fixtures were produced in collaboration with Robert L. Dearborn, lighting engineer.

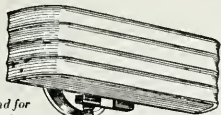

Send for
catalog
"The Charm
of a Light-
Conditioned
Home"

YOU'VE NEVER HAD SUCH EYE COMFORT

Until you've had this fixture installed over the basin in your kitchen or over the mirror in your bathroom you'll never know the true meaning of eye comfort. It is designed by Lightolier to give exceptionally fine illumination with no glare, whatsoever. May we show it to you? We have it on display in our store!

INCANDESCENT SUPPLY COMPANY

726 MISSION STREET, SAN FRANCISCO

THE HERMANN SAFE CO.

MANUFACTURERS AND DEALERS
OF
FIRE AND BURGLAR PROOF
SAFES AND VAULTS. SAFE-
DEPOSIT BOXES, ETC.

200 HOWARD STREET
SAN FRANCISCO
GARfield 3041 - 3042

FINE WATER COLORS AND PAPERS FOR ARCHITECTURAL RENDERINGS

H. S. CROCKER COMPANY, Inc.

720 MISSION STREET
MARKET STREET AT SECOND
SAN FRANCISCO

ILLUSTRATIONS OF SUPERIOR CONSTRUCTION



Lamella Roof design is based on theory supported by tests. Every Lamella Roof in the West is designed to meet the actual requirements of the location in which it will be built. A full size Lamella Roof, shown in this picture, was tested for all types of vertical and lateral load. The tests showed that the method of analysis was in all cases well on the side of safety.



**SUMMERBELL
ROOF STRUCTURES**
LOS ANGELES • OAKLAND • PHOENIX
TIMBER STRUCTURES, INC., PORTLAND

ROOFS OF WOOD—BUILT TO ENDURE

HOUSING—MORE OUTDOOR RECREATION SPACE NEEDED

AROUSED by the nation-wide interest in housing and reflecting on the expensive sins of omission in the past, the Society of Recreation Workers of America requested the National Recreation Association to appoint a committee to draw up standards for outdoor recreation space in housing developments. The problem, as the report presents it, is that in entire neighborhoods which are now being created with dwellings which will last for generations, there is promise of the provision of adequate light, air and open lawn areas but little indication of adequate open space to be permanently dedicated to recreation use. It holds that unless this tendency is corrected, cities with such housing developments will be obligated to acquire recreation areas later at great cost. Responsibility for seeing that recreation needs are not overlooked in the planning of new housing

Pacific Manufacturing Company

High Class Interior Finish
Quality Millwork

142 Sansome St. San Francisco GARfield 7755
6820 McKinley Ave. Los Angeles THornwall 4196

1315 Seventh Street, Oakland
GLEncourt 7850

MEDUSA PORTLAND CEMENT PAINT

A Damp Proof Paint which bonds with
Concrete and Masonry Surfaces
Particularly popular for swimming pools



Gunn, Carle & Co.
SAN FRANCISCO
20 Potrero Ave. UNDERhill 5480



Golden Gate Atlas
TRANSIT
MIX CONCRETE
AND MORTAR

•
makes delivery of material to the job swift and inexpensive . . . minimizing the architect's supervision costs and assuring his client a dependable mix.

•
PACIFIC COAST
AGGREGATES, Inc.

16th and Harrison Streets
85 Second Street
San Francisco

Phone GA 6field 1164

Hunter & Hudson

Consulting Engineers
DESIGNERS OF HEATING
AIR CONDITIONING
VENTILATING AND WIRING
SYSTEMS, MECHANICAL
AND ELECTRICAL EQUIP-
MENT OF BUILDINGS

41 SUTTER STREET
ROOM 710

San Francisco California

Robert W. Hunt Company
ENGINEERS

Inspection - Tests - Consultation
Schools and Other Structures
Are Built as Designed

*When Construction Materials are
Inspected at point of Manufacture
and during Erection by*

ROBERT W. HUNT COMPANY

*Cement, Concrete, Chemical, Metallurgical,
X-Ray and Physical Laboratories*

Chicago - New York - Pittsburgh
Los Angeles - All Large Cities
San Francisco, 251 Kearny Street

developments is shared in common by subdividers, public housing authorities, city planning commissions, recreation departments, city councils, school authorities, and the taxpayers.

The committee presents the following recommendations:

1. In the initial conception of any housing project, due consideration for the recreational needs of the people to be housed, in consultation with local authorities responsible for city recreation service.

2. Play lots within each block or for each group of dwellings except in developments where backyards are provided for individual families.

3. Within each neighborhood whether composed in part or entirely of the housing development—an adequate, properly situated playground.

4. A playfield for young people and adults within easy reach of every housing development.

5. Wherever practicable, utilization of space not occupied by buildings for informal recreation.

6. Consideration of indoor recreational facilities.

7. Consideration of the problems of operation, maintenance and leadership.

Viewing the problem as fundamentally one of planning, the report voices three principles that underlie its recommendations. These are: first, that provision of recreation areas in housing projects is primarily a problem of city and neighborhood planning; second, that intelligent provision of outdoor recreation areas demands an understanding of their types, essential functions and requirements as to size, location, design and facilities and third, that the need for indoor recreation facilities must also be considered and that they must be planned in relation to the outdoor features. Furthermore, it is essential that methods of financing and administering areas and facilities be considered.

The bulk of the report is given to an elaboration of the three types of areas which it holds to be essential neighborhood features related to housing developments. These are play lots, playgrounds and playfields. It is stated that the playground, school and indoor recreation center "which



Our Bank-by-Mail Service extends the facilities of this old, metropolitan Bank to every point where mail is delivered. Both checking and savings accounts may be conducted with utmost safety and convenience.

Write today...

for free Bank-by-Mail kit containing all necessary forms, return envelope and simple instructions.



Member Federal Deposit Insurance Corporation

THE TORMEY
COMPANY

GENERAL PAINTERS
AND DECORATORS

—
Phone UNderhill 1913

—
563 FULTON STREET
San Francisco

Donovan Automatic
Awning Type
Windows

Give 100% natural ventilation
and day-lighting control

•
UNIVERSAL WINDOW
COMPANY

Berkeley, California



CLIENTS will bless you for installing the Wesix "49'er" **ELECTRIC BATHROOM HEATER**. But *try it first in your own home*. Certain that you will like its forty-nine inches of **INSTANT RADIANT HEAT** and **QUICK CIRCULATING HEAT**, we are offering this smart new heater at *factory cost to architects*, for personal use. Limit one heater per architect. List price \$21.50. Please write on your regular letterhead, to: **1018 WESIX BLDG., SAN FRANCISCO**

WESIX

WESIX ELECTRIC HEATER CO.

**HERRICK
IRON WORKS**

**STRUCTURAL STEEL
REINFORCING STEEL**

18TH AND CAMPBELL STS.
OAKLAND, CALIF.
Phone Glencourt 1767

**FORDERER
CORNICES WORKS**

Manufacturers of

- Hollow Metal Products
- Interior Metal Trim
- Elevator Fronts and Cabs
- Metal Plaster Accessories
- Sanitary Metal Base
- Metal Cabinets
- Flat and Roll Metal Screens
- Commercial Refrigerators

269 POTRERO AVE.
San Francisco, Calif.
HEmlock 4100

serve as a focus of the neighborhood and its common life" are the basic elements in the planning of city neighborhoods.

NATIONAL HOUSING ACT

THE President's signature of the National Housing Act amendments of 1939 (FHA) should assure a continuation of home construction activities during coming weeks at a pace well ahead of last year.

Enactment by Congress and approval by the President of legislation extending certain FHA functions which were due to expire on June 30, 1939, should remove any doubt as to the continued availability of the liberal financing facilities offered by FHA.

Principal features of the amended Act are:

1. Authorization for the President to increase to \$4,000,000,000 the amount of outstanding mortgage insurance obligations the FHA may have at one time. The present limitation is \$3,000,000,000, and the outstanding principal obligation at this time is approximately \$1,400,000,000, not including approximately \$400,000,000 in outstanding commitments to insure.

2. Continuing of the FHA's authority to insure mortgages on existing construction until July 1, 1941. Homes financed with FHA-insured mortgages will continue to be eligible for FHA financing indefinitely.

3. Requirement that in the refinancing of mortgages the applicant for insurance must file a certificate that the mortgage holder has refused to grant him equally favorable terms.

4. Extension indefinitely of the authority of the FHA to insure mortgages on small homes involving mortgages of not more than \$5,400 for terms up to 25 years. Under the old bill the maximum maturity of 25 years reverted to 20 years, as of July 1st.

5. Authorization to continue insurance of lending institutions against loss on property improvement loans up to \$2,500 each with a new provision empowering the Administrator to charge an insurance premium not in excess of three-fourths of one per cent to offset a portion of operating expenses and losses.

Pitcher

**Improved
Disappearing Doors
Save 20% Space**

Joins with a 3/4" stud wall . . . steel studs
. . . adjustable steel and wood track.
Can be used for screen doors in connection
with French doors. Send for detail drawing.

E. C. Pitcher Co.
557 Market Street
San Francisco

Copper Halftones
in this issue

Made by

**Continental Engraving
& Color Plate
Co.**

156 Second Street
San Francisco

**"AMERICAN MARSH"
Redi-Vac Vacuum
Heating Pump**

Send for
Bulletin 441

SIMONS MACHINERY CO.
San Francisco 816 Folsom St. Los Angeles 465 East Fourth St.



SANTA MARIA INN

Santa Maria, California

*On the Coast Highway
between*

Los Angeles and San Francisco

OVER NIGHT

or

JUST A MEAL

FRANK J. MCCOY, *Owner*
Geo. A. Thompson, *Manager*

El Encanto Hotel

Santa Barbara

*On the Riviera, above the
Old Mission*

Frank J. McCoy, *Owner*
Fred F. Pimental, *Manager*

Independent Iron Works

Structural Steel
Ornamental Iron
Steel Service Stations
Steel Tanks
Standard Steel Mill Buildings
Bridges

821 Pine Street

Oakland

Clinton Construction Co. of California

*General
Contractors*

923 Folsom Street
San Francisco
SUtter 3440

6. Establishment of a prevailing wage scale to be determined by the Secretary of Labor on large-scale projects (Section 207).

7. Revision of the conditions under which insurance may be granted on mortgages covering large-scale projects.

8. Repeal of Section 210 under which the Administrator was authorized to insure mortgages under special conditions in the price range up to \$200,000.

COMPETITION WINNERS

The jury in the Smithsonian Art Gallery architectural competition has recommended the names of Eliel Saarinen, Eero Saarinen and Robert Swanson of Bloomfield Hills, Michigan, as winners. These architects will be commissioned to prepare the working plans and superintend construction of the proposed new museum, at an estimated cost of \$4,000,000.

The second prize of \$3,500 was awarded to Percival Goodman of New York.

Each of the other eight contestants will receive an honorarium prize of \$1,000. These are:

Paul P. Crete, Philadelphia, Pennsylvania.

Philip L. Goodwin, New York City.

Harry F. Manning, Chicago, Illinois. (David K. Carlson, associated.)

James A. Mitchell, Pittsburgh, Pennsylvania. (Dahlen K. Ritchey, associated.)

Eliot F. Noyes, Cambridge, Massachusetts. (Robert W. Kenney, associated.)

G. Holmes Perkins, Cambridge, Massachusetts.

Peter and Stubbins, Boston, Massachusetts.

Edward D. Stone, New York City.

The principal of the winning architectural group, Eliel Saarinen, has already distinguished himself professionally, having designed the passenger station, Helsingfors, Finland; won the second prize design in the Tribune Tower Competition, Chicago, and is architect for Cranbrook Village, Cranbrook, Michigan.

ALLEN STRUCTURAL PORCELAIN PANS

The ultimate in porcelain enamel construction.

Details and specifications
now available.

FRANK ALLEN

Ferro-Porcelain Construction
320 MARKET ST., SAN FRANCISCO

Melrose Lumber & Supply Co.

LUMBER AND
MILL WORK

46th Ave. and E. 12th St.
Oakland

Phones: FRuitvale 0240 — 0251

ANDERSON & RINGROSE

General Contractors

320 Market Street, San Francisco

Phone GARfield 2245

HIGH GRADE MILLWORK
AND INTERIOR FINISH
SASH AND DOORS

LANNOM BROS. MFG. CO.

FIFTH AND MAGNOLIA STREETS
OAKLAND, CALIFORNIA

Telephone: TEmplebar 3663

MULLEN MFG. COMPANY

BANK, STORE AND OFFICE
FIXTURES—CABINET WORK
OF GUARANTEED QUALITY
CHURCH SEATING

Office and Factory:
60-80 RAUSCH ST., Bet. 7th and 8th Sts.
San Francisco
Telephone UNderhill 5B15

G. P. W. JENSEN & SON

Building Construction

320 Market Street, San Francisco
Phone: GARfield 2444

DINWIDDIE CONSTRUCTION COMPANY

•
BUILDERS
•

CROCKER BUILDING
SAN FRANCISCO

Carl T. Doell Co.

*Plumbing
Heating*

Plumbing Contractor
Veterans Memorial Building
Oakland

467 21ST STREET
OAKLAND

Telephone GLencourt 8246

10,400,000 TONS OF GRAVEL AND SAND
FOR SHASTA DAM

A contract for one of the largest gravel processing jobs ever undertaken by the Bureau of Reclamation has been awarded to an Oakland firm by Secretary of the Interior Harold L. Ickes for the preparation of concrete aggregates for Shasta Dam, Central Valley project, California.

The successful bid of \$4,413,520, submitted by the Columbia Construction Company, Inc., was the lowest of four proposals.

An estimated 7,600,000 tons of gravel and 2,800,000 tons of sand will be required for the manufacture of concrete at Shasta Dam. This gravel and sand will be obtained from the North Kutras tract located at a bend in the Sacramento River just east of Redding, Shasta County, about 12 miles downstream from the dam site.

This contract involves clearing the areas to be stripped of all trees, brush, and other objectionable surface materials; construction of a large processing plant; excavating and processing the gravel and sand; building railroad tracks to connect with the main line of the Southern Pacific Railroad Company; loading aggregates into cars; and transporting the material to an interchange yard on the main line. The interchange yard will be located near Middle Creek, 2½ miles above Redding.

Washed and graded aggregates will be stock-piled in five sizes, one of sand and four of gravel. The gravel will vary from 3, 16-inch to 6-inch in size.

The Bureau of Reclamation will provide for transportation of the sand and gravel in steel gondola-type cars from the interchange yard to Coram, which is just downstream from the dam site. The graded gravel and sand will be delivered at Coram to the Pacific Constructors, Inc., the general contractor now engaged in excavation operations at Shasta Dam. Pacific Constructors will manufacture and place the concrete.

It is estimated that the maximum daily delivery to be required when

Louis C. Dunn, Inc.

GENERAL
CONTRACTORS

Monadnock Building
San Francisco

Phone: DOuglas 4632

Empire Construction Co., Ltd.

Builders



RUSS BUILDING
SAN FRANCISCO
SUtter 2989

Smith
Lumber Company
WHOLESALE - JOBBING - RETAIL
FACTORY AND BUILDING LUMBER
PLYWOODS - ROOFING

DISTRIBUTING YARDS

San Francisco | Oakland
• | 19th Ave. &
4th & Channel | Estuary
Market 0103 | FRuitvale 3174

YOUR INQUIRIES SOLICITED

SISALKRAFT
REG. U. S. PAT. OFF.

“More than a
building paper”

THE SISALKRAFT CO.

205 West Wacker Drive
(Canal Station) Chicago, Ill.
55 New Montgomery Street
San Francisco, Calif.

ABBOT A. HANKS, INC.
Engineers & Chemists

INSPECTING — TESTING — CONSULTING
 CONCRETE • STEEL • MATERIALS
 CHEMICAL AND TESTING
 LABORATORIES
 • RESEARCH AND INVESTIGATION •

TESTS OF STRUCTURAL MATERIALS
 DESIGN OF CONCRETE MIXES
 SHOP AND ERECTION INSPECTION OF
 STRUCTURES AND EQUIPMENT
 INVESTIGATION OF STRUCTURES
 AND MATERIALS
 TESTS AND INVESTIGATION OF
 FOUNDATION SOILS
 FIRE RESISTANCE AND INSULATION
 TESTS

624 Sacramento Street, San Francisco

VAUGHN - G. E. WITT Co.

Manufacturers and Distributors

Pump Governors	Oil Heaters
Safety Pump Governors	Relief Valves
Automatic Gas Regulating Valves	Oil Burner Governors
Gas Burning Equipment	Oil Burners
Vacuum Pump Governors	Oil Pumping Sets
Vacuum Regulating Valves	Oil Valves
Continuous Flow Steam Traps	Oil and Steam Strainers
Thermostats	Duplex Oil Pumps
Reducing Valves	Rotary Oil Pumps
	Boiler Feed Pumps
	Water Heaters
	Boiler Feed-Water Regulators

4224-28 Hollis St., Emeryville, Oakland

**VERMONT
 MARBLE
 COMPANY**

Producers and Finishers
 of

Domestic and Imported
 Marbles

San Francisco
 Los Angeles
 and
 Tacoma, Wash.



MERCURY DRESS

We Print
 The ARCHITECT and
 ENGINEER

"A Thing of Beauty
 Is a Joy Forever"

942 HOWARD STREET
 SAN FRANCISCO

concrete operations at the dam reach a peak, probably in 1942, will be about 16,000 tons of gravel and 6,000 tons of sand, calling for four or five trains of about 80 cars each day.

RUNNING FIRE

(Concluded from Page 1)

In Defense of Lipstick

Ruby lips are an integral part of feminine beauty. When the Greek belles of history and romance found their oscular skin becoming pale, they took a certain stain and brightened their lips. If Helen had had a pale mouth, Paris would not have been so intrigued by them, and Mark Anthony would undoubtedly have lingered less had Cleo not stained her seductive Cupid's bow. Certainly there must have been a reason for these heartthrobs of history to paint up—and that must have been because it made them more beautiful—and who am I to refute tradition and experience—rather would I uphold them and enjoy more fully the use of my eyes.

Of course I cannot fully appreciate the advent of green shades, black shades and ones to suit one's dress. I would prefer to think of woman as possessing those crimson lips permanently, not like a chameleon, even if it comes off on my face—but then I close my eyes.

Too, with extreme minor adjustments, a severe, straight mouth may be turned into a pleasing one. And the plainness and simplicity of an otherwise drab physiognomy needs a touch of color—like an oasis in the desert. It really falls in the category of fenestration.

The modern custom of having lipstick leave its owner easily is due to three reasons:

The manufacturer can sell more lipstick;

It gives woman a sense of superiority to see her brand on a man;

Presidents of corporations can hire secretaries with naturally red lips while their underlings have to take the applied variety. This keeps the lesser fry in line because no minor business executive wants to have his boss walk in while he's busily wiping his face and hiding his handkerchief.

**JOSEPH MUSTO
 SONS-KEENAN
 CO.**

**MARBLE
 and ABRASIVES**

ONYX

535 NORTH POINT STREET
 SAN FRANCISCO
 1801 S. SOTO STREET
 LOS ANGELES

THE MOST COMPLETE LINE
 OF STEELS AND STEEL BUILD-
 ING MATERIALS MADE BY A
 SINGLE PRODUCER



See Sweet's Catalog File or write us for full information.

Republic Steel Corporation

General Offices: Cleveland, Ohio

Denver, Colo. . . Continental Oil Bldg.
 Los Angeles, Calif. . . Edison Bldg.
 Salt Lake City, Utah . . Walker Bank Bldg.
 San Francisco, Calif. . . Rialto Bldg.
 Seattle, Wash. . . White-Henry-Stuart Bldg.

**JOHN
 CASSARETTO**

—Since 1886—And Still Active—

Building Materials

READY MIX CONCRETE
 ROCK - SAND - GRAVEL - LIME
 CEMENT - PLASTER - MORTAR
 METAL LATH - WOOD LATH
 STUCCO - WIRE NETTING

Service Unexcelled

Bunkers
 Sixth and Channel, San Francisco
 Phones: GARfield 3176, GARfield 3177

**Puget Sound
 Number**

●
**ARCHITECT
 and
 ENGINEER**

●
 CHAS. H. ALLEN, F.A.I.A.
 Guest Editor

ARCHITECT
AND
ENGINEER

SEPTEMBER 1939

FOR SWIMMING POOL CONSTRUCTION



Tan Plastic Cement Assures PERMANENCE, BEAUTY, AND ECONOMY

In specifying cement for swimming pools, the all-important factors are waterproof qualities, plasticity, and pleasing tone. That's why Golden Gate Tan Plastic Cement enjoys an outstanding reputation throughout the West for sound construction of pools, and other waterproof projects.

Due to the exceeding plasticity of Tan Plastic Cement it pours rapidly into the form, massing solidly around the reinforcing mesh, and creates smooth, even surfaces. Impervious to moisture when correctly used, due to special patented manufacturing process. Expense is eliminated — no waterproof processing or coating necessary.

For sound construction on your next job specify Golden Gate Tan Plastic Cement and be sure.

LEADING
ARCHITECTS *
SPECIFY IT

COMPETENT
BUILDERS *
USE IT

RELIABLE
DEALERS
HANDLE IT



Terrace Plunge,
Good Housekeeping—
Exposition Display House
in
Woodside Hills,
on the San Francisco Peninsula

Gardiner A. Dailey, *Architect*
Suburban Builders, Inc., *Builders*
David D. Bohannon, *Developer*

GOLDEN GATE TAN PLASTIC
CEMENT SPECIFIED AND USED
IN SWIMMING POOL

PACIFIC PORTLAND CEMENT COMPANY

SAN FRANCISCO • SEATTLE

COASTWIDE SERVICE

LOS ANGELES • PORTLAND

RUNNING FIRE

by
MARK DANIELS, A.I.A.

How High Is the Sky?

Mr. Ralph Adams Cram delivered himself of another series of fine, penetrating and enlightening comments a few days ago, this time dwelling on the skyscraper. His doubt as to the economy in time expended in the use, and money expended on the construction, of the modern skyscraper seemed very well founded. Most architects have slowly, though reluctantly, arrived at the same conclusion.

His suggestion that the design of such towering structures be influenced by long consideration of the pictures they will present when they become ruins, either from a rain of bombs or a reign of anarchy, appeals strongly to me, for most of us agree with Mr. Cram that one or both of these forms of destruction is the destiny of the skyscraper.

As an institution that is unsocial in the extreme, what with its separation of the workers in isolated cubicles that are artificially lighted and ventilated, Mr. Cram classes the scraper as tops. He also questions the economy of travelling one thousand feet vertically as against the same distance horizontally.

All his arguments against the skyscraper are logical enough but there is one point that puzzles me. How high is a skyscraper? The Empire State building is a skyscraper in New York. So is the Shell Building in San Francisco. What would the latter be called if it stood next to Rockefeller Center in New York? What it would be called if it were in Kookuk, Iowa. I cannot presume to say. To Huns, termites and other such vermin heaven only knows what it would seem to be.

To an architect of the mental horizon of Mr. Cram the difference between a skyscraper and a tall building may be quite obvious but many of us need more specific definitions.

* * *

The Seer

I'm a crystal gazer!

Didn't this column warn Mr. William Randolph Hearst not to tamper with OUR funny pages in his papers? And didn't he make haste to restore the drawings to

their original sizes as a result of the ruckus that followed as per predictions? Was not Europe warned that the ever increasing publicity given to Herr Hitler would eventually put Mussolini's nose out of joint? And did I not say that some time another war might catch the little paperhanger (or house painter, as he boasts) in a uniform, thus putting one of his arms in jeopardy?

Well, the war is on, der Fuehrer is in a uniform and the arm is in jeopardy. Also, there is quite some chance that the little paperhanger may soon be back at his walls again, minus one arm. There is also the possibility that, with the spread of disease incident to poor food and war, he may have acquired the seven-year itch. How sad, how sad!

* * *

Another "Hant"

From the moment of the first pencil mark on my first job I was haunted by the fear that I might make some dire mistake. When the plans were finished there was the haunting fear that I had left something out. There were nightmares when I thought the roof had been omitted, the foundations overlooked, even down to such minor details as leaving out the main staircase or the kitchen. When the job was finished I was haunted with the fear that I would never get another, which, I hear you say, I unfortunately did.

For a quarter of a century this went on until I realized (so quick am I) that all walks in life have their especial "hants." Inventors fear their improvements will be surpassed the next day; engineers that they have left out a strut; doctors that the missing forceps are sewn up in the last patient. There is no line of endeavor free from "hants." The nearest to such freedom is the successful patent medicine that has no competitor, but even these have their weak spots.

Some years ago there appeared on the market a liquid called "No-Kink." It would lay the curly wool of the curliest-headed negro as straight as string. It sold amongst the negroes like lipstick among the debutantes, like Odorono in the dancing schools, like haggis

amongst the Scotch. It sold like wildfire and has made millions for the owner of the formula. It had no competitor. At last here was something without a "hant."

Maybe so, but I do not envy the owner of that formula if it occurs to him that the geneticists may yet discover some way successfully to cross breed the Chinese and the negro races.

* * *

Lost Opportunities

Shortly after the fire in San Francisco my offices were on the tenth floor of the Monadnock Building, facing on Market Street. There was a six-foot cornice outside the window and when there was a parade we would all lean far out to watch the show in the street ten stories below. Amongst the boys of the staff was a renderer who had been a scenic artist in St. Petersburg. He was a dyed-in-the-wool Russian.

One day I leaned out to watch the floats go by. I turned my head to speak to the artist who was leaning out the next window. He said, "What a swell place to throw a bomb!"

News has come to us that Hitler has been flying over the fronts in Poland. We have read that he flew over Austria, Czecho-Slovakia and Jugoslavia. What torture this must have been to him! Think of flying over Prague with her six bridges over the Moldau, over Budapest with the dome and towers of her parliament house, and the steeple of St. Mathias church, glistening targets in the sun; over Vienna with her parks and playgrounds and the lacey spires of St. Stephens, and not being able to throw a bomb. It must have been agony to der Fuehrer to see the thousands of children in the parks along the Ringstrasse and he helpless to blast them to bits.

But at last his turn has come. If he is lucky he can throw a bomb into the palace Square in Warsaw when the children are playing around the centuries-old monument to Sigismund and if his aim is good he may blow a thousand to kingdom come. No wonder nothing

(Turn to Page 76)

ARCHITECT AND ENGINEER

SEPTEMBER, 1939

FRED W. JONES
Editor

MARK DANIELS
Associate Editor

E. N. KIERULFF
Ass't Editor

CHARLES H. ALDEN, F.A.I.A.
Guest Editor

CONSULTING BOARD
OF EDITORS

Architectural—

Arthur Brown Jr.
Frederick H. Meyer
Timothy L. Pflueger
Will G. Corlett
Harry Michelsen
John J. Donovan
Lewis P. Hobart
David C. Allison
Gordon B. Kaufmann
Harris C. Allen
Glenn Stanton
Paul R. Hunter

Engineering—

H. J. Brunnier
L. H. Nishkian
William Adrian
Wm. H. Popert
Homer N. Hadley
John J. Gould
Geo. E. Atkins

Business Manager—

L. B. Penhorwood

Advertising Manager—

J. Leslie Meek

Architects' Reports—

Vernon S. Yallop

THE ARCHITECT AND ENGINEER, INC., 68 Post Street, San Francisco, EXbrook 7182. President, K. P. Kierulff; vice-president, Frederick W. Jones; secretary, L. B. Penhorwood. Los Angeles office, 832 W. Fifth Street. Published on the 12th on each month. Entered as second class matter, November 2, 1905, at the Postoffice at San Francisco, California, under the Act of March 3, 1897. Subscriptions, United States and Pan America, \$3.00 a year; Foreign countries, \$5.00 a year; single copy, \$.50.

Frontispiece

BELLINGHAM HIGH SCHOOL, BELLINGHAM, WASHINGTON
F. A. Naramore, Architect

Text

- RECENT ARCHITECTURE IN THE PUGET SOUND COUNTRY 19
Charles H. Alden, F.A.I.A.
- SIX STORY GARAGE IN OFFICE BUILDING SOLVES
PARKING PROBLEM 39
- A.I.A. PRESIDENT SALUTES SUPERVISING ARCHITECT'S
OFFICE 41
Charles D. Maginnis, F.A.I.A.
- ARCHITECTS SHOULD KNOW THEIR BUILDING MATERIALS 43
Paul Schweikher
- EARTHQUAKE STUDIES FOR PIT RIVER BRIDGE 45
J. L. Savage, M.A.S.C.E.
- CONTEMPORARY STYLE SEEN IN WOODSIDE HILLS
MODEL HOME 47
- MODERN DESIGN EXPRESSIVE OF TRUE BEAUTY AND
SIMPLICITY 51
George W. Walker
- ARCHITECTS' CONGRESS AND INSTITUTE CONVENTION . 53
- RELATION OF THE ARCHITECT TO THE MANUFACTURER . 57
Robert H. Orr, A.I.A.
- "LABOR'S STAKE IN U. S. PUBLIC HOUSING" 61
Warren Jay Vinton

Illustrations

- RECENT ARCHITECTURE IN THE PUGET SOUND COUNTRY 19-38
- | | |
|-----------------------------------|-----------------------------------|
| City Hall, Bellingham, Wash. | Reimann Studio, Seattle |
| Lincoln School, Mount Vernon | Library, Pacific Lutheran College |
| Meridian Grade School, Bellingham | Nan Fullerton Stuart Chapel |
| National Guard Armory, Seattle | United Brethren Church, Seattle |
| Sick's Baseball Park, Seattle | Residence of Herbert Schoenfeld |
| Pacific National Bank, Seattle | Residence of F. C. Stanton |
| Washington Mutual Savings Bank | House for Fritz Miller |
| Seattle Trust & Savings Bank | Residence of Dr. Loren G. Schroot |
| Eastman Kodak Stores, Seattle | Residence of Paul Thiry |
| Klopfenstein's Store, Seattle | Puget Sound House |
| Royal Crown Cola Plant, Seattle | |
- GOOD HOUSEKEEPING MODEL HOME, WOODSIDE HILLS,
MENLO PARK, CALIFORNIA 47-50
Gardner A. Dailey, Architect



SPECIFY THESE PRE-TILED PARTITIONS

- and save $\frac{1}{3}$ on labor costs

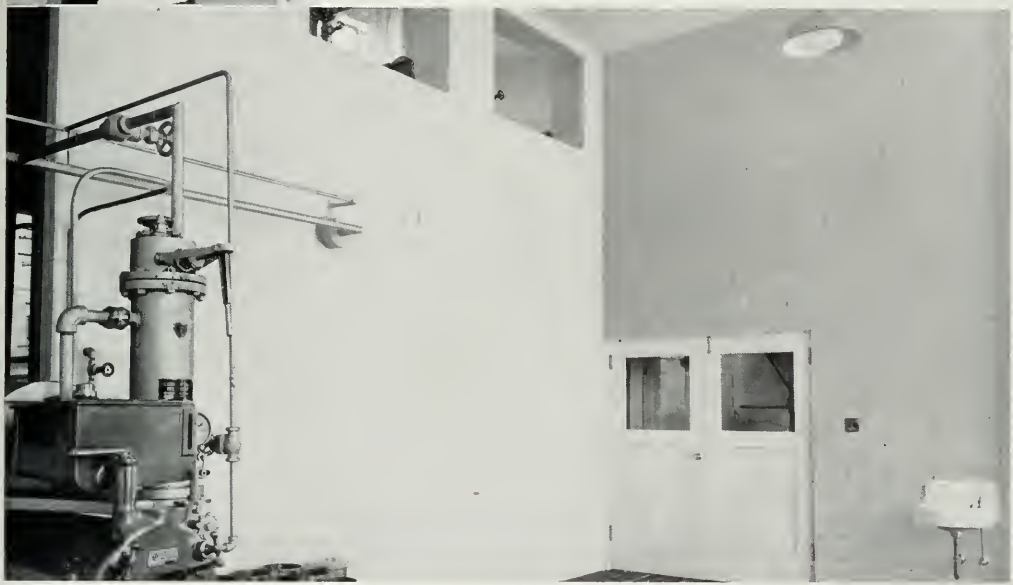

Willowbrook Creamery Company at Oakland, California. E. S. Campomenosi, general contractor

KRRAFTILE TERRA COTTA Wall Units are already finished on one or both sides with a smart, semi-matt Kraftile glaze. Thus, the partition *tiles itself* as it is erected.

Building time is reduced proportionately. Labor costs average about one-third less. Only one craft works on the entire operation.

The everlasting Kraftile surface saves building owners no end of upkeep expense. A hasty going-over with a damp cloth is all the cleaning it ever needs.

Kraftile Wall Units are *precision-sized* to within 1/16 inch. Made in standard 6 x 12 and 8 x 16 sizes and shapes. Easily reinforced for earthquake resistance to meet California State Code.

Kraftile Wall Units are setting new standards of utility and economy in schools, hospitals, food products plants, and public buildings in 21 of the states and Canada. Kraftile engineers worked closely with the builders of many of these jobs — this experience is available to you.

**FREE HANDBOOK FOR
ARCHITECTS AND BUILDERS**

KRAFTILE COMPANY — Niles, California
Please send me without cost or obligation
"Handbook of Specifications and Suggestions
on Glazed Terra Cotta Wall Units"

Name _____
Address _____
City _____
State _____

KRAFTILE TERRA COTTA WALL UNITS

CHRYSANTHEMUMS

Color Bombs for Autumn Gardens

By BERNIECE ASHDOWN
Landscape Architect

CHRYSANTHEMUMS supply indispensable color to any well planned garden. They come in a multitude of varieties and include all of the best fall hues, unequaled for brilliance and harmony of tone.

They may be divided into three general classes: the old-fashioned hardy type; the Early-flowering type; the so-called Greenhouse type and the new Cascade type.

Many of the old-fashioned types are not listed by name, but only by color. They include Pompon single and semi-double forms in colors running from lavender-pink to deep russet tones, and include yellow and white. They bloom in October and November.

Kengai or Cascade Chrysanthemums have a very special value for hanging baskets, etc., but require a great deal of specialized care. They are rather expensive, considering their brief blooming season, but for everyday gardeners as well as for the connoisseur, their beauty makes them well worth their price.

The Early-flowering varieties bloom in September, thus eliminating the dangers of frost damage in Northern climates. They come in a multitude of glorious colors which are clear and vivid. The new hybrid Korean chrysanthemums in shades of crimson pink and bronze are enjoying unusual popularity. They are hardier than most varieties.

The Florist or Greenhouse Chrysanthemums are apt to bloom late in the season and therefore require some special protection from autumn storms and cold.

Chrysanthemums may also be classified according to the character of their blossoms: The Pompon, with round button shaped flowers; the Anemone or grilled form; the Ragged-fringed types; those with incurled florets; the Reflexed types with florets curving outward from the center, and last, the Novelty types.

While the hardy garden varieties grow easily, the choicer types require considerable care and skill. All of them, however, repay generously for any extra care or attention. Since the Chrysanthemum is a gross feeder, it exhausts the available food in the soil very quickly, so it is wise to divide and reset the plants each year. Then, too, the clumps are apt to become over-crowded, causing the quality of the flowers to decrease.

They do best in a very rich medium heavy loam to which has been added generous amounts of a complete plant food. At various times during the growing season, applications of nitrogen add vigor to their growth.

Chrysanthemums should never be allowed to become dry. If they are, their stems become hard, leaves leathery and ultimately, their blossoms will be undersized. Overhead sprinkling is the best method of irrigation, but should be discontinued as soon as the color shows in the buds.

Although they require a great deal of water, good drainage is absolutely essential. At no time should water be allowed to stand on the ground around them.

In late summer it is wise to mulch the plants with well rotted manure and soak the ground thoroughly in order to carry the additional plant food to the roots.

During the summer months in hot dry localities, chrysanthemums should be given partial shade. In cooler sections of the country this is not necessary.

Chrysanthemums may be propagated from seed, cuttings, suckers, or by dividing the roots. Many people with limited facilities find it practical to buy new plants of the more difficult varieties from the nurseries each spring.

Korean types are easily raised from seed. If sown in a seed box in March, they will bloom the following fall. Cuttings should be made in the early Spring and rotted in coarse sand in a shaded cold frame.

Spring is the best time to divide and set new plants, thus giving them a chance to establish their roots before the blooming season. Set the plants from one to two feet apart.

All chrysanthemums need support, therefore stakes should be placed with each plant and the flowering stalks tied to them as they grow. Early in the spring, gardeners who desire giant blossoms should obtain some good healthy plants of the varieties especially suited to this purpose. Keep all side shoots pinched off, allowing only the main stalks to grow undisturbed. (Some varieties will grow five feet tall, so stakes amply tall, should be provided.)

When, in the fall a cluster of buds are formed at the apex of the stem, carefully remove all but the strongest one, thus throwing all of the strength into one blossom. Because of their late blooming season, these plants will need some sort of protection against frost and storms.

If tall stemmed single flowers are not desired, and one wishes to produce a mass of showy bloom, the tops may be nipped out of the plants in the spring and again at two-month intervals until September. This not only shortens the length of the stems, but encourages them to produce more blossoms.

Chrysanthemums are not unusually susceptible to disease and pests, but occasionally they are attacked. The best insurance against damage by insects and pests, is to have good vigorous plants. In case of plant lice, hose the leaves off with the full force of water or spray with a good strong tobacco solution. For leaf-eating insects, such as worms, caterpillars, and grasshoppers, etc., spray with arsenate of lead. Red spider, an almost microscopic insect which feeds upon the leaves and turns them white, is best controlled by hosing the leaves off thoroughly and dusting with sulphur. Rust may be prevented by selecting healthy cuttings with

which to start the plants and being sure, if you buy new plants, that they are healthy.

Although rather fussy to raise, chrysanthemums when finally brought into bloom are very amiable. One may, being careful not to disturb the roots too much, transplant whole plants into pots, etc., and bring them into the house for sensational effects in decoration.

Many plants will be at their prime at Thanksgiving time and are apt to last long after.

Below are listed some of the better varieties for general use:

Large Flowered		(White)
Chiefton Vermont Pink Turner		White Cap Sam Caswell (novelty);
(Bronze)		Pompons (Pink)
Bronze Turner Wm. H. Waite (Red)		Button Rose Captain Cook Lillian Doty
Mrs. G. G. Mason		
(Yellow)		(Red)
Yellow Turner Golden Nagirroc Col. Appleton		Anna L. Morgan Red Doty
(White)		(Yellow)
Wm. Turner		Baby Yellow Doty
Hardy Garden Types		(White)
Butler's Caprice Lilac Cap		White Gem Baby Marguerite
(Bronze)		Anemone Flowered (Pink)
Bronze Buckingham		Tronesta Coed
(Red)		(Bronze)
Baby Portola H. Marie Totty (Yellow)		Titian Beauty (Red)
Yellow Cap Lizzie Adcock Old Gold		Red Bird (White) Godfrie's Perfection

THE ARCHITECT OF TODAY

JOHN N. RICHARDS, A.I.A., in "Building."
Being an architect of this era is very different than it was twenty or thirty years ago. Today's architect has forgotten his high and mighty attitude of the past age in order to keep up with the moving parade of events. The practice of architecture is no longer merely a profession. It has become a business and profession combined.

The modern architect knows the details of the building industry. He knows about costs, financing, engineering items. He realizes that he is a business man dealing with other business men. The latter are interested only in how well he and his organization can handle their problems.

Today's architect is a practical man and is able to advise any kind of a client. Beautiful drawings and artistic designs are not enough to make a man a good architect these days. Granted, they are important, but not as important as a sound knowledge of the building as a whole.

The modern architect studies every available angle of the problem to present his client with the best final solution of the problem possible. He may have his high hopes matured some, because of finances available for the project, but his client will receive dollar for dollar in value at the completion of the work.

A registered architect gives his experience gained from his college training and his

(Turn to Page 12)

HERE'S THE *New Trend* IN INTERIOR FINISH

APPROVED BY MILLIONS AT THE NEW YORK WORLD'S FAIR



A century dining room with its Celotex Key Joint Units above plaster dado.

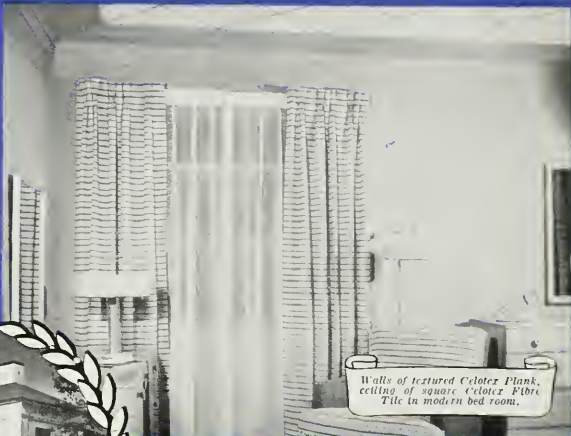

Walls of textured Celotex Plank, ceiling of square Celotex Fibre Tile in modern bed room.



Celotex Exhibit House No. 17 in "The Town of Tomorrow" at New York World's Fair 1939.



Celotex Key Joint Units applied typically, with ceiling of Celotex Fibre Tile.



Living room has Celotex Insulating Cane Board walls and ceiling paneled with Celotex Molding.

CELOTEX

REG. U. S. PAT. OFF.

INTERIOR FINISH PRODUCTS

LES DISTRIBUTORS THROUGHOUT THE WORLD

FROM Manitowoc and Miami—from Passaic and Pasadena—from New London and New Orleans they come, and look, and go back to tell their friends about the *NEW TREND* in interior finish! Celotex Exhibit House No. 17 in "The Town of Tomorrow," designed by architects Henry Otis Chapman, Jr. and Harold W. Beder, is teaching America *what can be done* with Celotex Insulating Interior Finish Products, to decorate and insulate at one low cost.

New colors and textures in Celotex Plank, Tile, and Moldings—plus the important adaptability of Celotex Key Joint Units to open framing in new construction—give architects a limitless range of decorative possibilities in working with these increasingly popular materials.

All Celotex Cane Fibre Interior Finish Products are proofed against termites and dry rot by the exclusive, patented Ferox Process—and are guaranteed in writing for the life of the building!* Mail the coupon for complete information!

* This guarantee, when issued, applies only within Continental United States.

The word Celotex is a brand name identifying a group of products marketed by The Celotex Corporation.

THE CELOTEX CORPORATION
919 N. Michigan Ave., Chicago, Illinois

Please send complete information about Celotex Insulating Interior Finish Products.

Name.....

Address.....

City..... County..... State.....

A.P. 9-209

○ Spacious Windows



Good Housekeeping Woodside Hills Exposition House on The Model Homes Tour, San Francisco World's Fair, Gardner A. Dailey, Architect.

○ distinguish this sunny World's Fair home

Glass—in larger areas—adds immeasurably to the comfort and charm of the modern residence—expresses the architectural ingenuity of today.

Modern design prescribes the use of more and larger windows—picture windows—corner windows—to make homes light, lively and livable. With glass used amply and more adroitly

than ever before, its quality becomes a matter of supreme importance.

It is wise to specify L·O·F Polished Plate Glass. This finer glass is noted for its exceptional freedom from imperfections. It is accurately ground to eliminate waviness and distortion—then polished to a mirror-like brilliance.

Libbey-Owens-Ford Glass Company, Toledo, O.



LIBBEY·OWENS·FORD

Polished Plate Glass

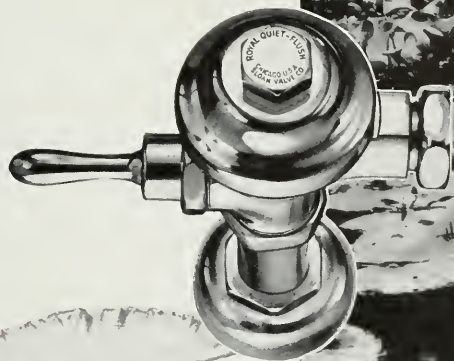

QUIET WATER

● Why have noisy flush valves? They can be absolutely quiet. Indeed—Sloan *Quiet-Flush* Valves are absolutely quiet. When operated, the flow of water through a Sloan *Quiet-Flush* Valve makes scarcely a murmur. . . . In comparison with any other flush valve—they are absolutely quiet. And this *Quiet-Flush* equipment is available to all Sloan Royal, Star, Crown and Naval valves.

● What is more—*any* Sloan flush valve in the above models may be made absolutely quiet—regardless of when installed. Merely replace the present stop valve with the Sloan *Quiet-Flush* stop, then insert in the valve itself a new type guide and seat. This simple change, readily made by any master plumber, reduces the roar of rushing water to a whisper—and virtually makes the old valve a brand new installation.

● A new descriptive folder, with cross-sectional views showing how this miracle of quietness is accomplished—will be sent you upon request.

See our comprehensive Catalog in Sweets

SLOAN VALVE COMPANY • CHICAGO
4300 WEST LAKE STREET



SLOAN *Quiet Flush* VALVES

"STYLES" IN ARCHITECTURE

Writers differ in accepting as a "style" the so termed "American design." European authorities insist there can be no styles except those which have had their origin abroad and from which any changes in this country are but developments. However, many Americans have taken the opposite view, the following by Carlton P. Campbell of Detroit being a typical example:

"As our people grow more cultured, our Midwest 'frontier architecture' is being replaced by beauty in public buildings, homes and business structures.

"Beauty and utility also are entering the low-cost housing field, with the government itself leading the way by employing more architects each year to draft new and better home styles.

"America has led in the post-war development of new types of architecture contrary to the popular belief that the new 'functional' styles originated in Europe.

"A truly American design is one that looks first to the use to which the structure will be put and then to the creating of a front for it. All former types of architecture, except possibly the Colonial, stressed the outside first, and then tried to fit the interior into the scheme.

"Because it is practical and frugal, the American Colonial style has become the basis for over half of today's so-called modern types of home architecture. Development of steel and reinforced concrete, of course, made possible the skyscrapers—another American contribution.

"As far back as 1908 Frank Lloyd Wright and Louis Sullivan, noted American architects, were creating designs as modern as those of today. European students saw their value, copied them—and American architects then went to Europe and brought back the same ideas in that round-about fashion.

"Today's popular home styles are based on Early American Colonial, Georgian, Greek Revival and Gothic while in the public and commercial fields the Classical Renaissance and Gothic predominate.

"We've modernized them all, however, and their influence is being felt in other fields—even in furniture, automobiles and typewriters."

Talbot F. Hamlin, Librarian of the Columbia University School of Architecture, is quoted as saying that "too much importance is given to architectural styles. It is the beauty of a building that counts. And Architectural beauty is not a matter of styles," he says, and continues: "You read of Colonial houses and English houses and Normandy houses and Gothic churches and the charm of this style and the loveliness of that style. All of that has nothing to do with architecture. We are done with all that parroting of the past; mere copying of what our ancestors did is at best only

attempting to recover something that has gone; and because the styles we are taught were produced by people no longer living, and for kinds of life that have passed forever with the coming of the machine, we can never even copy them with perfect sincerity."

THE LIVABLE BASEMENT

Editor Architect and Engineer
San Francisco, California

With the modern heating systems now installed in new homes, enabling the owner to build recreation rooms in the basement, why not discard the living room?

A dining room could be made out of the living room. The kitchen could be moved to the space that the dining room now occupies. As the kitchen is usually a small room, it could be made into a bunkroom.

Guests could be entertained in the recreation room, thus, only one room would be needed to be tidied, instead of all the rooms, before and after the guests depart.

ANOTHER PLAN: Why cannot the kitchen, dining room and recreation room be in the basement? The first floor plan could be utilized only for sleeping quarters, bathrooms, and one large room for a library.

In the breakfast nook of the larger homes, I would like to see a small cabinet encased above the table in which could be kept the following items: Sugar bowl, creamer, salt and pepper shakers and napkins enclosed in napkin rings. Having such a cabinet with the most necessary food items, would enable the homemaker to enjoy her meals undisturbed.

These plans are my ideas of less work.

Very truly yours,

JENNIE USHLER,

Detroit, Michigan.

PUBLICITY FOR THE ARCHITECT

The forthcoming International Congress of Architects will be a greater and infinitely more potent means of focussing attention upon the profession.

Attention to mass advertisement by architects will always be of great value, and is needed. At a recent luncheon of architects one of the guests told of the remark of the editor of a certain weekly magazine to an architect who tried to sell him on the idea of an article describing how architects work and just what is their contribution to the public welfare. The editor said, "The public isn't interested. They think of an architect as a sleek, handsome smoothie who seduces the heroine in the fourth chapter."

That may or may not be a true picture of what the public, as a whole, thinks. But some of it is true. A word here and there to build up the idea that the profession is strong and virile will do no harm.—Federal Architect.

UNIVERSITIES PLEASE NOTE

Editor, Architect and Engineer, San Francisco, Calif.

Dear Sir:

On Page 76 of your July 1939 issue you print a letter from a young man of Princeton, inquiring as to the prospects and advantages offered by the architectural profession, for which he is preparing.

By a curious coincidence, one of the answers, and a potent one, is given in your account on Page 58 of the same issue, of a dinner meeting of the California Society of Architectural Draftsmen, I quote—"The dinner meeting of the California Society of Architectural Draftsmen (embracing draftswomen) at Veneto's restaurant on June 8th was a WOW."

Perhaps the diversion indicated in the parenthesis above could be suggested to the inquiring student as one of the inducements offered by the architectural profession. Princeton might even offer a course in "Embracing Draftswomen."

Yours for contented draftsmen,

J. S. COLE, Architect.

Seattle, Wash.

MORE ABOUT PIGEON NUISANCE

The July Architect and Engineer printed a solution to pigeon soiling of buildings as developed in the office of Albert F. Roller, architect of San Francisco.

Another remedy is proposed in the following letter by Charles Cressey, architect of Laguna Beach, Calif., addressed to Bert H. White of the Liberty Bank of Buffalo, N. Y., who first wrote this magazine for advice in ridding one of his client's buildings of the nuisance:

Mr. Bert H. White,

Dear Sir:

I read your letter on "Pigeon Soiling of Buildings" in the July issue of Architect and Engineer, San Francisco, and suggest that you first try the treatment I have found successful with linnets and sparrows, before adopting more costly and disfiguring methods. At best, guards and screens are undesirable and accumulate almost as much dust, leaves and filth as do the birds.

A few years ago I spotted small wads of cotton, soaked in "Oil of Citronella," (familiar in insect pest control) in the file eaves and roofing places of an apartment house. The experiment was a complete success and lasted in effect most of two seasons. Even later the birds avoided nesting at the spots first treated—and again deserted the building on another application of the oil. The back-flop of friend sparrow, making his usual happy landing is something new in aviation. The oil odor seems intolerable to the birds. With ingenuity you can reach strategic spots inaccessible to ladders, by bamboo pole, or throwing. Perhaps a painters spray tube would make quick work of a large job for a while. The reaction of pigeons I cannot predict, but the trial is easy to make. Feeding the birds at one spot regularly and trapping is effective. Architect A. F. Roller makes conservative suggestions for permanent guards, in above journal. From wide-open beach experience, congratulate offended customers, that your pigeons are not pelicans!

Very truly,
CHARLES CRESSEY, Architect.



Consider these MAINTENANCE SAVINGS!



Kawneer
ENTRANCE DOORS
ARCHITECTURAL PORCELAIN ENAMEL

BY SPECIFYING Kawneer products, architects and builders are now erecting commercial buildings—and other types as well—on which exterior maintenance expense is drastically reduced, *on which no exterior painting will ever be required!* For Kawneer building products are sturdily fabricated with time-defying, attractive, non-ferrous metals which cannot rust, rot, warp, swell or shrink.

Investigate this new upkeep economy. Plan now to incorporate Kawneer products in your next building or residence. Illustrated booklets and data available. Write THE KAWNEER COMPANY, BERKELEY, CALIF.

FAMOUS KAWNEER FEATURES:
Kawneer Store Fronts—firm, resilient grip on plate glass in show windows, which reduces breakage to the minimum.
Sealair Windows—always operate easily, extremely low infiltration, appeal-

ing satin finish, admit more daylight.
Kawneer Entrance Doors—attractive and practical, can't sag. *K. Z. S. Architectural Porcelain Enamel* (glass fused with steel)—27 appealing standard colors, satin finish, modern, easy to keep clean.

Kawneer

THE KAWNEER COMPANY, NILES, MICHIGAN. BRANCHES: NEW YORK, CHICAGO, BERKELEY, CAL. DISTRIBUTORS IN PRINCIPAL CITIES.

HIGHLAND CEDAR PRODUCTS

ARE manufactured from the finest old growth cedar timber grown on the Pacific Coast today. Our plant is modern in every respect and equipped with the best of machinery — our employees are skilled craftsmen of many years experience.

We operate the latest type cross circulation kilns, assuring uniform moisture content.

Grades, grain, texture, always uniform.

HIGHLAND CEDAR PANELS

Knotty and clear, vertical and flat grain panels up to 30 inches in width.

HIGHLAND CEDAR EXTERIOR TRIM AND SIDING

Any design, pattern or size desired up to 36 inches in width, 24 feet in length.

HIGHLAND CEDAR BATTENS AND MOULDING

Any size or pattern— Stock or Special Design.

HIGHLAND CEDAR SHINGLES

All standard grades and sizes for roofing and side walls.

Stained shingles also supplied.

WILLIAM HULBERT MILL CO.
EVERETT, WASHINGTON

"Anything in Cedar"



STANLEY "Multichrome" Cabinet Hardware

Knob Pull



MC1485
Knob Pull



MC1484

Drawer or Cabinet Pull MC4478

with your choice of

RED...BLACK...IVORY...BLUE...GREEN

Its beauty is made permanent by wrought brass (with a choice of steel or brass in hinges), with heavy chromium plate and an insert of color that cannot peel or fade no matter how often it is cleaned. Send for descriptive folder. The Stanley Works, New Britain, Conn. Los Angeles Office: 407 American Bank Building; San Francisco: 818 Monadnock Building; Seattle: 568 First Avenue, South.

STANLEY

TRADE MARK

HARDWARE FOR CAREFREE DOORS

Cabinet Spring Latches



MC1299½
for flush doors
MC1299¾
for lipped doors

Cabinet Hinges



MC1522
(Wrought Steel)
MC1522½
(Wrought Brass)

Cabinet Hinges



MC1521
(Wrought Steel)
MC1521½
(Wrought Brass)

Drawer or Cabinet Pull



MC1488

BAXCO

CHROMATED ZINC CHLORIDE

CLC

PRESSURE TREATED LUMBER

● **PROTECTS AGAINST DECAY AND TERMITE ATTACK**

Specify it in your home
Available through Lumber Dealers

LOS ANGELES
601 W. 5th Street
Phone MIchigan 6294

SAN FRANCISCO
333 Montgomery Street
Phone DOuglas 3883

J.H. Baxter & Co.

AGENTS FOR WEST COAST WOOD PRESERVING CO., SEATTLE, WASH.

MODERN HOME



☆
*Natural setting
Natural gas*

THAT this house, of advanced contemporary style, includes gas heating, gas cooking and gas water-heating almost goes without saying. ☆ Modern automatic gas heating is as much a part of today's planning as are functional design and liberal use of steel and glass. Hot water, automatically supplied, heads the list of necessities, and gas cookery is preferred by nine out of ten women. Thus, architect and client usually find themselves in complete accord on specifying "All Gas."



Residence of Mr. and Mrs. Henwar Rodakiewicz, Los Angeles. Designed for one-acre canyon lot by Architect R. M. Schindler. Automatic forced-air gas furnace. (Note built-in gas range in kitchen view at right.)



LET **GAS** DO THE 4 BIG JOBS

THE MODERN FUEL

HOUSE HEATING • WATER HEATING • COOKING • REFRIGERATION



SALESMAN CAN HELP ARCHITECTS

PAUL HUNTER In Pencil Points

The "Salesmen Interviewed Thursdays 10:00-12:00" and "Salesmen seen by appointment only" notices are familiar signs in architectural offices. And, generally speaking, they are observed about as carefully as signs in cool and shady spots which read "Keep Off the Grass," but which really serve as something to hang your hat on as you stretch out full length on the lawn. Both types of signs were undoubtedly a good idea at first and persist now as traditions, but wherever the grass is green there are sure to be visitors.

From the office boy period on, most architectural men grow up in a more or less close contact with salesmen and come to know them either as good fellows who are allowed out in the drafting room and who pass around cigars and stories, or as nuisances who all but have to be assisted out of the office with a shove.

Of course, there is the hail-fellow-well-met, who strides through the door full of animal spirits and who is not to be daunted by any ordinary kind of sales resistance. There is the personal obligation type that lures the unwary into accepting a luncheon engagement or two and a few knick-knacks, and then expects one to "play ball." The gossipy type is usually amusing and a refreshing change, but while you may enjoy hearing what happened out on the job to your competitor, Jim Smith, when the client found he'd forgotten to provide space for the fishing poles, nevertheless, you shudder to think what stories are being carried around about you. One of the most difficult to handle is the aggressive type who doesn't understand why he can't get into this office, and have his material specified, which not only costs less but is far better than what is being used at present.

The most deadly type to date is the combination or two-man team. This consists of a high gear promotion man, whose part is to break the ice and keep the conversation going along briskly until the moment is ripe for the "engineer" or technically trained man to join in with the specific data. The one not talking carefully watches the effect of the discussion on the architect, and if it does not progress favorably, he tries one attack after another until either a touchdown is made or the game is called off.

A wide acquaintanceship with good salesmen is one of the best assets any architect can have. It might be hard to describe the perfect salesman, but I know several who would measure up favorably. First of all, they are good business friends who are exceedingly well-informed in their particular lines; they don't use sales promotion methods, but instead they offer advice about costs and the use of their materials and equipment . . . they are honest in advising against the use of their materials in a doubtful location . . . and they have a knack of dropping in at the right time without being called. . . .

THE ARCHITECT OF TODAY

(Continued from Page 4)

practical knowledge. He is, in a sense, a psychologist, because he must analyze his client's building, whether it be a simple house or a large industrial plant.

He is well informed on how improvements are open to all new ideas. He studies these improvements and learns of their operation from demonstrations by factory representatives. He is therefore in a position to specify the best and most up-to-date equipment and materials possible.

He is civic-minded. He has a knowledge of city planning, group planning and large scale planning. He is able to visualize solutions from a small house to a World's Fair.

While he has a good ground knowledge of past architecture, he thinks of his building, in its final conception, as fitting into the pattern of the future. Whether he be building in brick, stone, or wood, he will endeavor to do something creditable to his profession and create in spirit.

"ALL DOLLED UP"

Buildings with little or no ornament, and the simplest materials, may often be more beautiful than those of the most expensive marbles tricked over with the most lavish carving of ornament and sculpture. The difference between being well dressed and being "all dolled up" is enormous, and oftentimes the best-dressed person is the most simply dressed person. The same is true of buildings.—Talbot Hamlin.

This new Primer means *fewer paint Coats* yet better protection

Actually you *save one coat!* With the new Fuller Pure Prepared Primer, two coats outlast three applied the old-fashioned way. Radically different from any paint primer you've ever used! Different because the penetration into the wood is "controlled." Leaves a film of uniform strength—not "spotty." That means less chance for cracking, flaking, or blistering. Whether painting or repainting—next time use Fuller Pure Prepared Primer!

**PURE PREPARED
PRIMER**

**FULLER
PAINTS**
they last



Many out-of-town business men use our Bank-by-Mail Service for the advantages which this strong, metropolitan Bank affords. No matter where they live, this service is as convenient to them as the nearest mail box.

Write today...

for free Bank-by-Mail kit containing all necessary forms, return envelope and simple instructions.





NEW BEAUTY FOR OLD

Here is "before and after" evidence of the versatility of N. Clark & Sons Ceramic Veneer in adaptation to building modernization. The architects, DeLongchamps & O'Brien, have combined good design with modern materials to bring architectural charm to one of Reno's older buildings, as well as to appropriately preserve for permanent record the good name of one of Nevada's oldest and most respected families.

Modern transition, from unattractiveness to the newest building trend, is exemplified by the application of N. Clark & Sons Adhesion Type Ceramic Veneer . . . the latest development in a two-toned light cheerful color glaze. The Chas. W. Mapes Building here shown, is one of many old buildings throughout the West which have been brought apace with modern merchandising demands for attractive building exteriors, by the use of N. Clark & Sons Ceramic Veneer. Textures, designs and colors are available to meet every architectural requirement.

N • CLARK & SONS 116 NATOMA STREET
SAN FRANCISCO
LOS ANGELES • SALT LAKE CITY • PORTLAND

PRODUCERS OF QUALITY ARCHITECTURAL CLAY PRODUCTS

H A W S

Sanitary Drinking Fountains



For Public Buildings, Playgrounds,
Theaters, Schools, Service Stations

Comply with requirements of the
American Public Health Association

Complete line of ELECTRIC WATER COOLERS
to meet varied conditions

HAW S DRINKING FAUCET CO.
1808 HARMON STREET, BERKELEY, CALIF., U. S. A.

AGENTS IN THE FOLLOWING CITIES
NEW YORK • LOS ANGELES • SAN FRANCISCO
SEATTLE • SALT LAKE CITY • PORTLAND

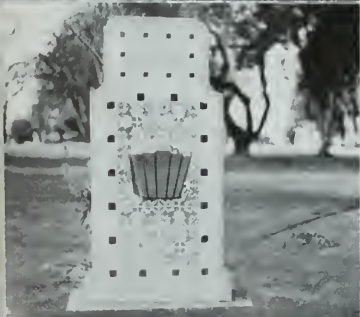
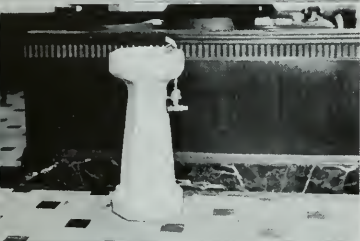
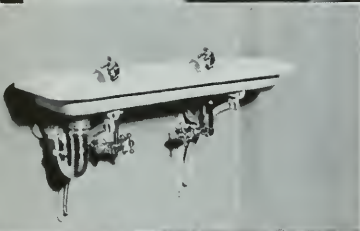

Dance floor or sales floor . . .

**NAIRN LINOLEUM MEETS THE ARCHITECT'S
EVERY REQUIREMENT**



Planet Room in the Bellevue-Stratford Hotel, Philadelphia. An attractive dance floor—plain-color Nairn Sealex Linoleum, with appropriate custom-cut Nairn Insets.

**Smart and modern . . . smooth
and sanitary . . . quiet and
resilient . . . economical and
long wearing!**

MORE than any other type of floor-covering, Nairn Sealex Linoleum gives a store that sleek, modern appearance which is so important today. Available in a wide range of attractive solid-color and marbled designs, it is adaptable to *any* type of decorative scheme.

And the practical features of Nairn Sealex Linoleum have client-appeal *plus*. A perfectly smooth, sanitary surface—easy to keep spotlessly clean. Quiet and comfortable underfoot. And years of heaviest-duty service with no costly refinishing!

Installed by authorized contractors, Nairn Sealex Linoleum is guaranteed for the full value of workmanship and materials. Write for free booklet No. C-94, giving many helpful suggestions for store, restaurant and club interiors.

CONGOLEUM-NAIRN INC., KEARNY, N. J.

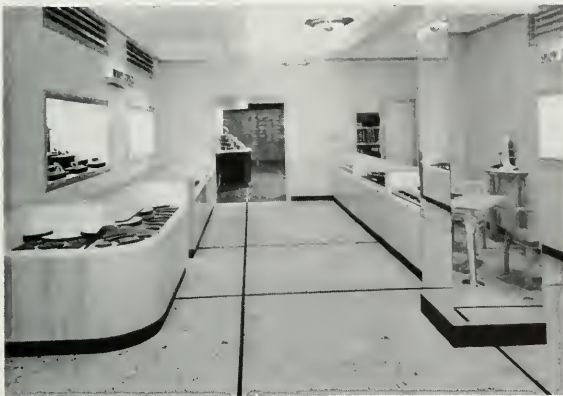

Above and to the right, you see two Nairn Sealex Floors, "Personal-ized" with contrasting ready-cut Nairn Feature Strips, in the New York City showrooms of Wolfshiein and Sachs, Inc.

* Trademark Registered, U. S. Pat. Office.

NAIRN
TRADEMARK REGISTERED
LINOLEUM
Floors and Walls





BELLINGHAM HIGH SCHOOL, BELLINGHAM, WASHINGTON
F. A. NARAMORE, ARCHITECT



CITY HALL, BELLINGHAM, WASHINGTON

Leonard W. Bindon, Architect

This new municipal building for Bellingham, besides the usual Council Chamber with auxiliary rooms, provides housing for the various other city departments, with garage space and police pistol range in basement. The stone exterior has a base of granite and travertine from Montana gives effective treatment to the walls of the foyer.

RECENT ARCHITECTURE IN THE PUGET SOUND COUNTRY

By CHARLES H. ALDEN, F.A.I.A.

DURING the interim of a little over a year since examples of Puget Sound architecture with other architectural developments in the State of Washington appeared in the pages of this magazine, there have been encouraging signs of a return to more normal building conditions and while no great activity has been evident except on governmental projects, designed and built under control of bureaus in Washington, D. C., there have been indications of more healthy participation in the development of local effort with increased financing from private sources.

The Public Works Administration has continued with its valuable contributions to make possible some much needed public buildings, fundamentally with local architectural design and supervision, and the Federal Housing Administration has been and is still active in promoting residence building by Puget Sound architects to meet adequately the local conditions, but a return to more complete dependence on private endeavor with a thorough study of the local requirements of the problem, seems to be in the ascendency.

The city of Bellingham, at the extreme north of the Puget Sound Country, was particularly benefited by financial aid from the Public Works Administration. The new City Hall, now well on its way toward completion, will be a worthy civic monument, replacing an old structure inadequate for this important community. The new building, of reinforced concrete, is faced with Wilkeson sandstone, a State product which has given dignity to many important buildings in the Pacific Northwest. Bellingham has also several new school buildings, similarly financed, in addition to the high school illustrated in the State of Washington article of last year. One of these other schools recently completed, is illustrated. Passing southward along Puget Sound, we have another interesting example of school architecture at Mt. Vernon. All these structures, designed and with construction supervised by Puget Sound architects, give evidence of careful attention to modern school requirements.



LINCOLN ELEMENTARY SCHOOL, MOUNT VERNON, WASHINGTON
 A. N. Torbitt, Architect

The exterior walls are reinforced concrete poured with joints occurring in the recessed strips. The outside walls have cement surfaces treated with waterproof paint. Interior surfaces of outside walls are furred and plastered. The floors are maple and linoleum over concrete.

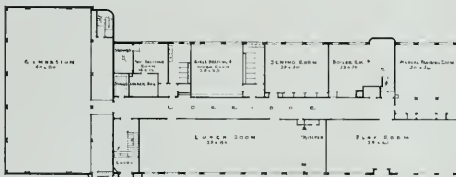

GROUND FLOOR PLAN
 LINCOLN ELEMENTARY SCHOOL, MOUNT VERNON, WASH.
 ARCH. N. TORBITT

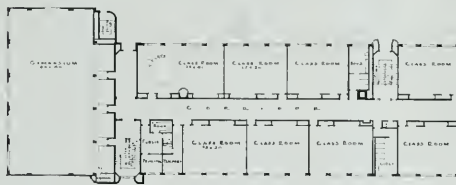

FIRST FLOOR PLAN
 LINCOLN ELEMENTARY SCHOOL, MOUNT VERNON, WASH.
 ARCH. N. TORBITT

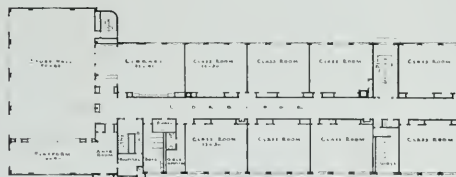

SECOND FLOOR PLAN
 LINCOLN ELEMENTARY SCHOOL, MOUNT VERNON, WASH.
 ARCH. N. TORBITT

In Seattle there are two recent buildings of public importance which present interesting contrasts in architectural treatment and building accomplishment. One, a new armory for the National Guard Field Artillery, was finally realized after many years of persistent effort. The largest armory on the Pacific Coast, this has, beside its drill hall an acre and a half in area, provision for most efficiently meeting all practical requirements of the Field Artillery Regiment, Field Artillery Headquarters and the Headquarters Battery. While the building is essentially a concrete structure, apart from the steel columns and trusses supporting the roof of the drill hall, brick is introduced in the exterior walls to add variety to the architectural effect. This was a Public Works Administration project.

Differing in some interesting respects from the armory, Seattle has another recent structure of public importance, a new Ball Park. This, also of concrete construction, was financed entirely with private funds and distinguished for speed not only in its planning but



MERIDIAN GRADE SCHOOL, BELLINGHAM, WASHINGTON
Leonard W. Bindon, Architect



NATIONAL GUARD ARMORY, SEATTLE, WASHINGTON
A. M. Young and F. A. Naramore, Architects

A particularly valuable feature of the drill hall is the quietness obtained by use of end wood block flooring and the thorough acoustic correction on the wall and ceiling.



SICK'S BASEBALL PARK AND STADIUM, SEATTLE, WASHINGTON

William Aitken, Architect

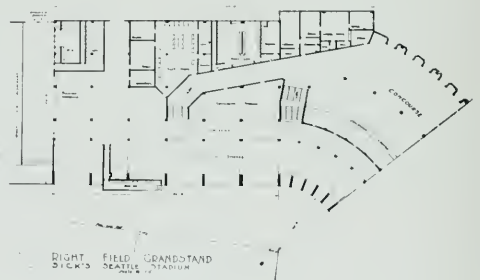
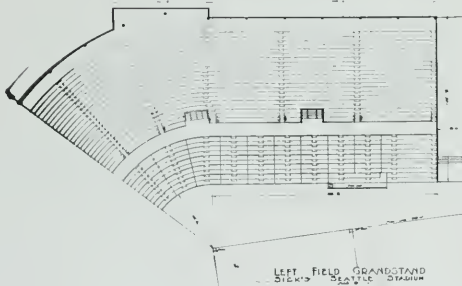
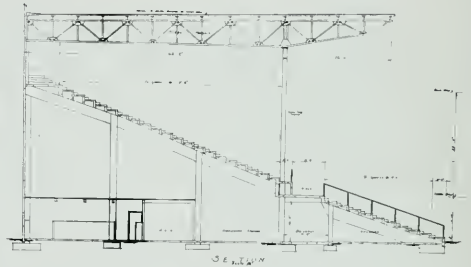
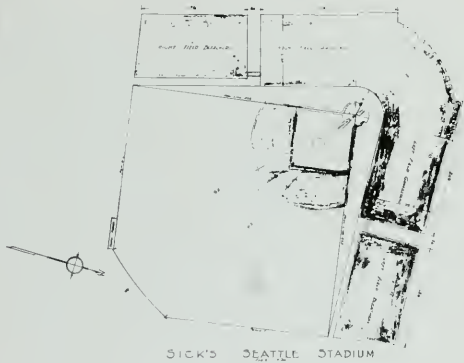

PLANS AND SECTION OF GRANDSTAND, SEATTLE BASEBALL PARK

particularly in its construction, fifty-one days only having elapsed from the breaking of ground to completion. Otherwise in contrast with the armory, no attempt was made to give variety to the exterior wall treatment. It was left simple, giving an opportunity to see how architectural a blank wall can be with embellishment of simple lettering only to indicate its function. The small accessory buildings in the foreground are given simple architectural treatment in harmony with the main structure. The haste in design and construction in no way detracted from the practical requirements of the problem. Every provision was made for the adequate handling of the crowds, all securing admission to the grounds being promptly and comfortably seated with a perfect view of the arena and means of egress provided to avoid confusion and inconvenience.

As another indication of healthy business recovery in Seattle, there are new bank buildings, indicating confidence on the part of financial institutions. The recently opened Pacific National Bank Building is an example of complete remodelling of a structure giving an entirely new architectural design. A more extensive bank remodelling now under way on another prominent downtown corner of Seattle involved the cutting down of a five-story building to a three-story height, leaving a structure of appropriate architectural character, exclusively for the bank's needs. Another bank illustrated involved the remodelling of the ground floor of an office building, with a development similar to other modernizations of ground floor streets frontages for commercial purposes.

While the P.W.A. has made possible many works of commendable architectural character, it is the W.P.A. which is now making possible a particularly distinguished contribution to the aesthetic, cultural and recreational attractiveness of Seattle in the construction of the University of Washington Arboretum. A joint effort with the University and Arboretum Foundation, this will provide a well located park area two hundred and sixty acres in extent with collections of trees and smaller varieties of plant life, bird sanctuaries and other natural

attractions. While this is mainly a landscape and garden development, full attention was given to the limited opportunity for architectural expression in the gate lodge which is so important a feature at the entrance and is so much in keeping with the character of this notable project.

Architectural treatment of commercial and manufacturing establishments is a particularly commendable phase of architectural expression which seems to be getting more recognition as having practical as well as merely aesthetic value. The new bottling plant of the Royal Crown Cola appears to be eminently satisfactory as a pleasing architectural solution of the business requirements of the problem. In this attractive building, manufacturing, sales business and appeal to public interest are all effectively served, the manufacturing operations carried on in the building being displayed to view from the street and made a main feature of the design.

While the creation of entirely new buildings makes the more satisfactory appeal to the architect, the economy often effected by the remodelling of existing work furnishes today an extensive field for architectural effort. An extreme example of what can be architecturally accomplished in the remodelling of an unsightly frame structure is illustrated in Mr. Reimanns' housing for his business activities. In carrying out the work from the architect's designs, he has abundantly displayed his skill in craftsmanship and made a notable contribution to the aesthetic appearance of a city street.

Churches and buildings for higher institutions of learning financed from private sources have been recently built in this Puget Sound Country despite the business depression. Churches have a general tendency to adhere to or be influenced by historic styles of architecture but the practical requirements often tend to operate against conservatism. One of these edifices illustrated here reflects the traditional gothic while the other is expressive of the new departure in design. An attractive college building appears in the illustrations as an architectural



PACIFIC NATIONAL BANK, SEATTLE, WASHINGTON

C. A. Merriam, Architect

The fine effects of detail and color, particularly in the interior of this building, do not appear in the photographic illustrations.



PACIFIC NATIONAL BANK, SEATTLE, WASHINGTON

C. A. Merriam, Architect



WASHINGTON MUTUAL SAVINGS BANK, SEATTLE
C. A. Merriam, Architect



SEATTLE TRUST & SAVINGS BANK, SEATTLE, WASHINGTON
McClelland & Jones, Architects



EASTMAN KODAK STORES, SEATTLE, WASHINGTON
 McClelland & Jones, Architects

The fine color of the wall surface and indirect lighting from behind the gold letters, give this store front a particularly distinguished character.



KLOPFENSTEIN'S STORE, SEATTLE, WASHINGTON
 McClelland & Jones, Architects



BOTTLING PLANT FOR ROYAL CROWN COLA, SEATTLE, WASHINGTON
William J. Bain, Architect

example from the more southerly portion of the Puget Sound country, the new library of the Pacific Lutheran College, south of Tacoma. It is a well planned building with an attractive brick exterior.

While somewhat lacking in remunerative attractions for the architect, residential architecture is more closely expressive of life and also particularly responsive to changes in architectural development. The varied conditions af-

fecting the problem; site, climate and cost with fundamentally the needs and desires of the owner and natural inclinations of the architect in his method of solving his problem, produce a wide variety of results ranging from the traditional colonial to an extreme modernistic expression. There is, of course, greater opportunity in the larger houses where expense is not so vital a factor than in the small or medium sized "low-up-keep" dwelling which is now so

much in demand and calls for much ingenuity in planning. As an example of particularly successful planning, the small house illustrated, on a small steeply sloping lot with a view of Puget Sound to the rear, was awarded first prize in a competition conducted by the House and Garden magazine.

In the Puget Sound country, the mild climate, hilly topography and scenic attractions suggest for residential building a distinctive type of architectural treatment, so much so that a Seattle mentor in aesthetic expression, Dr. Fuller, President and Director of the Seattle Art Museum, was led to suggest that as we have had the "Cape Cod House" and the "Modernistic" to suit local conditions, there should be



REIMANN STUDIO, SEATTLE, BEFORE REMODELLING



REIMANN STUDIO, SEATTLE, AFTER REMODELLING

Edwin J. Ivey, Architect



LIBRARY, PACIFIC LUTHERAN COLLEGE, PARKLAND, WASHINGTON
 E. J. Breseman and Heath, Gove & Bell, Associate Architects

developed a "Puget Sound House" presenting architectural characteristics peculiar to the Puget Sound region. This prompted three agencies particularly interested in residential development: an extensive owner of residential property; a leading department store giving particular attention to house furnishings and decoration; and one of Seattle's leading financial institutions, to definitely promote this idea and there are now five selected residential architects designing these houses in cooperation with the decorators and furnishers, these to be essentially livable houses suited to the locality. As one of these architects expressed it, "The 'Puget Sound House' should not be a copy nor an adaptation but an original house typed definitely for Puget Sound Climate and View." This suggests absence of or limitation of overhanging eaves and providing ample window openings to give as much light in the house as possible. Steep roofs are not essential since there is little or no snow to necessitate them, neither should the roof be flat as in areas with little rainfall. Extensive porches are not desirable, but there should be accessibility to gar-

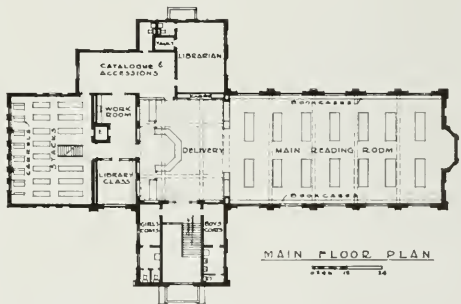
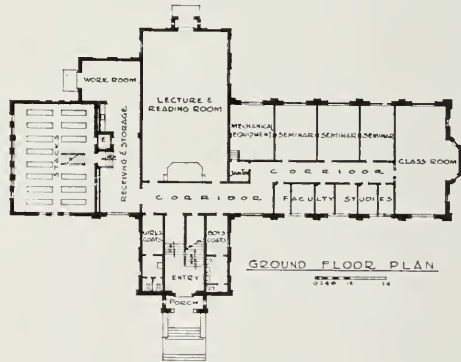

QUAINT CHURCH OF TRADITIONAL GOTHIC



NAN FULLERTON STUART MEMORIAL CHAPEL,
CARNATION, WASHINGTON
Frederick V. Lockman, Architect

The walls of this church are of concrete faced with split faced granite. In the interior the warm tones of buff and brown give a pleasing contrast to the cool blues and greens of the stained glass windows.

INTERIOR, NAN FULLERTON
STUART MEMORIAL CHAPEL,
CARNATION, WASHINGTON
Frederick V. Lockman, Architect



A DEPARTURE IN CHURCH ARCHITECTURE



UNITED BRETHREN CHURCH, SEATTLE
Smith, Carroll & Johanson, Architects

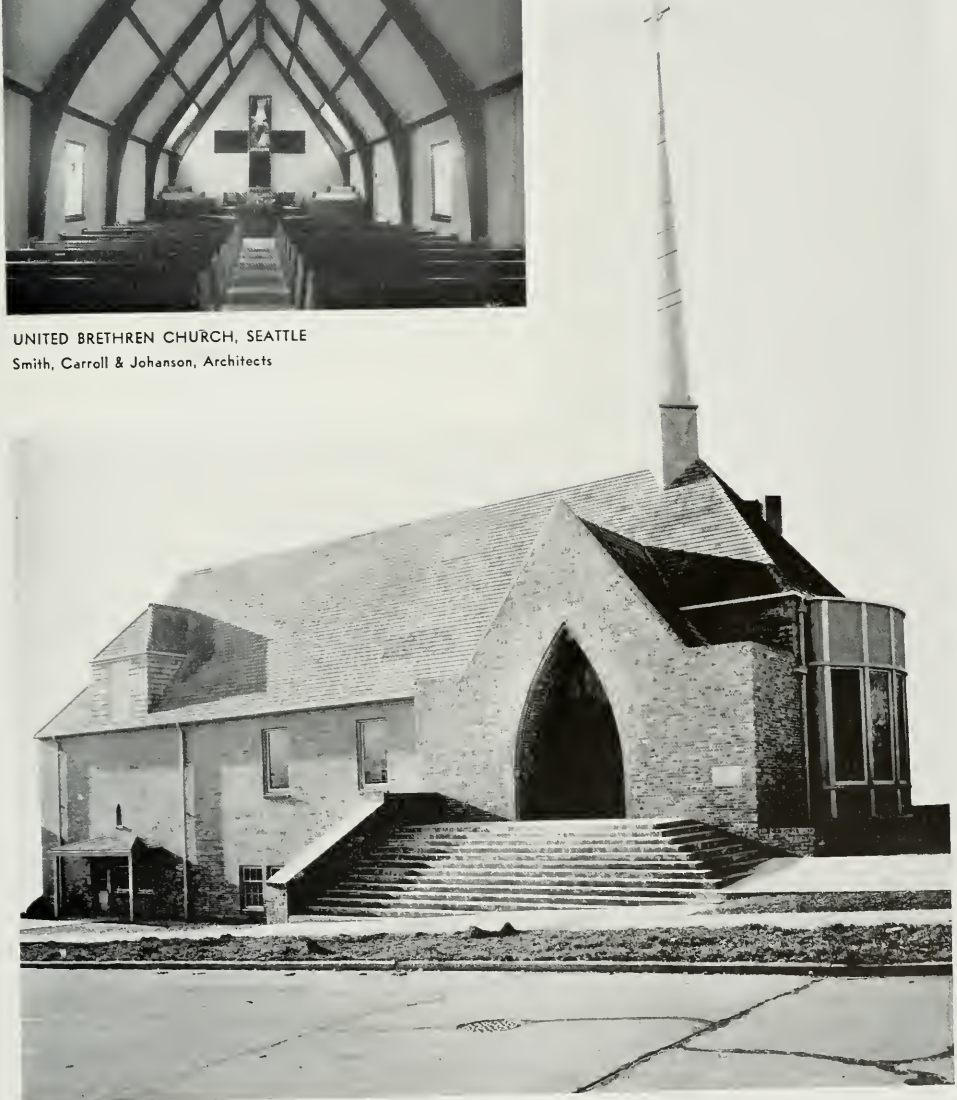

UNITED BRETHREN CHURCH, SEATTLE, WASHINGTON
Smith, Carroll & Johanson, Architects



RESIDENCE OF HERBERT SCHOENFELD, SEATTLE, WASHINGTON

William J. Bain, Architect

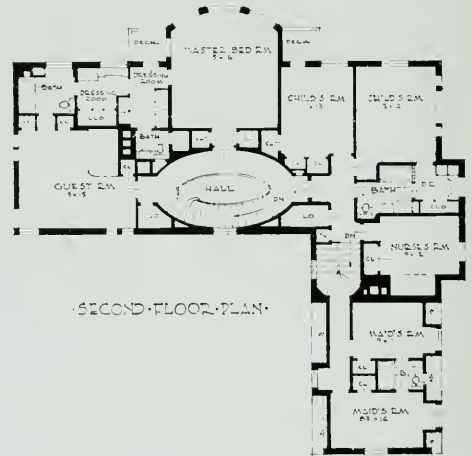
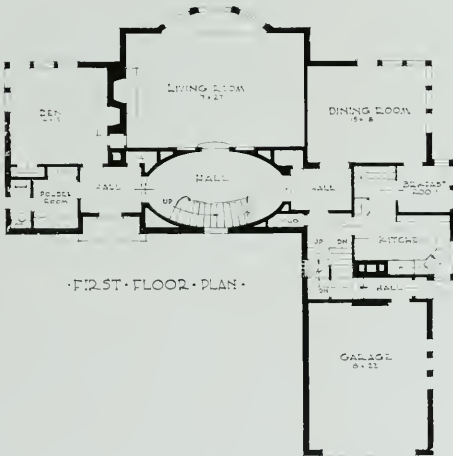



RESIDENCE OF F. C. STANTON, BELLINGHAM, WASHINGTON

F. C. Stanton, Architect

The slope of the lot to the rear gives an opportunity for a garage in the basement, extending under the terrace and easily accessible from the stairs leading down from the upper floors. Privacy from the street is obtained by the position of the stairs and use of gridded windows on the front.

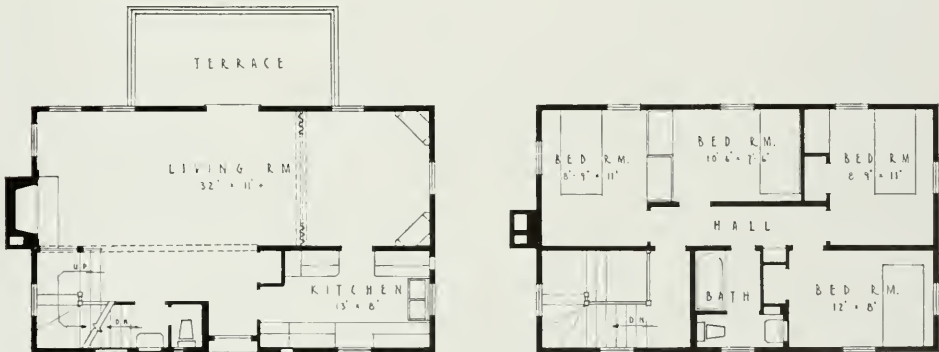

**Beautiful Home
in a Lovely Setting
Reminiscent of
Colonial Days**

dens, so prominent a feature of residential life on Puget Sound.

Such efforts are indicative of what should be done everywhere to suit the local conditions and the result from the Puget Sound examples will be awaited with interest. Besides these accomplishments in the development of residential architecture, many other hopeful signs in other phases of architectural expression should promote general optimism for the future.



DETAIL OF ENTRANCE, HOUSE FOR FRITZ MILLER



HOUSE FOR FRITZ MILLER, SEATTLE, WASHINGTON
Arthur L. Loveless and Lester Fey, Architects



WEST ELEVATION, RESIDENCE OF DR. LOREN G. SCHROAT,
SEATTLE, WASHINGTON

Photos by Poole Studios

Paul Thiry, and Alban Shay, Architects

This house is on high ground sloping east from the rear of the lot to Lake Washington and is planned to take full advantage of the magnificent view of the lake and Cascade Mountains beyond. It is a fine example of the modern expression in planning and designing.

PLANS, RESIDENCE OF
DR. LOREN G. SCHROAT

Paul Thiry and Alban Shay, Architects





EAST ELEVATION, RESIDENCE OF DR. LOREN G. SCHROAT,
SEATTLE, WASHINGTON
Paul Thiry, and Alban Shay, Architects

Photo by Poole Studios



LIVING ROOM, RESIDENCE OF DR. LOREN G. SCHROAT,
SEATTLE, WASHINGTON
Paul Thiry, and Alban Shay, Architects



NORTH ELEVATION, RESIDENCE OF PAUL THIRY, SEATTLE, WASHINGTON
Paul Thiry, and Alban Shay, Architects

Photo by Poole Studios



ENTRANCE HALL, RESIDENCE OF PAUL THIRY, SEATTLE, WASHINGTON



BIRDSEYE VIEW, RESIDENCE OF PAUL THIRY



LIVING ROOM, RESIDENCE OF PAUL THIRY, SEATTLE

Paul Thiry, and Alban Shay, Architects



PUGET SOUND HOUSE

Arthur Loveless and Lester Fey, Architects

6 STORY GARAGE IN OFFICE BUILDING SOLVES PARKING PROBLEM

SOME years ago Rockefeller Center in New York made a parking lot of a sizeable area in the south block of the development, ultimately destined to be the site of one of the office building units. The place immediately began to do a rushing business. Soon the Rockefeller Center management took note of the fact that frequently by noon the attendants had to hang out the "Sorry, no more room" sign. It was something to think about.

The result of this brow-wrinkling by the management, says Buildings and Building Management, is New York's first large combined office structure and parking garage, thirteenth unit of Rockefeller Center, which will be ready for occupancy in its entirety by October 1. Fifteen stories high, it contains a six-story garage, with a capacity of 800 cars, as well as 196,991 sq. ft. of net rentable office space.

This addition to the long list of architectural and engineering feats at Rockefeller Center is designed to answer the parking problem in a congested area and is consequently of considerable interest to owners of central properties in the metropolitan cities of the United States, for lack of car parking facilities is admittedly one of the principal factors in the decentralization trend.

With the evidence for the need of parking space which the success of the parking lot supplied, Rockefeller Center sought permission to construct the new type of commercial building. This required the approval of the City Board of Standards and Appeals. The argument was that in addition to the urgent need of parking for the Center's permanent tenant population of 25,000, the garage section of the building would also be available to the general public, thereby helping to relieve the vital traffic problems of mid-town Manhattan. Approval was granted last year and construction was begun in November, 1938.

To all outside appearance the structure resembles the other buildings in the Center, since street frontage is lined with shops, and the building has the same limestone finish as its twelve companions. The only differences are the two ground-level entrances to the garage and a large expanse of a special new glass product on the south side to provide light.

The garage is of the D'Humy motor ramp parking type and occupies three floors below street level, the street level, and the second and third floors above street level. The space utilized is, however, only the western portion of the ground area of the building. The 48th Street entrance consists of three double lanes, each 20 feet wide, and the 49th Street entrance of two double lanes of similar width. Doors are automatically operated by entering cars. The degree of incline of the ramps is about 12 per cent, as compared with the 17 per cent found in the usual garage ramp. Park spaces for individual cars are 7 feet 2 inches wide.

The garage is equipped with the latest innovations, both scientific and mechanical. One of these is a series of brass firemen's poles for the use of garage attendants so they can furnish "service with a slide." They are exactly like the firemen's slides in fire stations throughout America that have fascinated several generations of boys. These are staggered from floor to floor so there is no single drop of more than one floor. A ventilating system throughout the garage changes the air completely four times every hour. A special room is provided for the comfort of chauffeurs. Special elevators have been provided for use of attendants, whose headquarters are on the upper garage floor. The entire main floor is tiled in an attractive color scheme, with traffic lanes shown in tile on the floor. Compressed air is provided for tires and there are facilities for car wash-

ing, but gasoline and oil must be obtained elsewhere.

The garage is known as the Rockefeller Center Garage. Parking rates are:

Midnight to 10 A. M.

50c for first 6 hours; 10c per hour for next 2 hours; 5c for each hour thereafter.

10 A. M. to Midnight

50c for first 4 hours; 10c per hour for next 2 hours; 5c per hour thereafter.

On Saturdays and holidays the same rates apply, with a 75-minute after 10 a. m.

Indirect artificial illumination has been provided for the lower four floors, including the ground floor space. In order to provide natural light for the two upper floors the largest window of its type in the country has been installed. This is a huge panel, 200 feet long and two stories high, on the southern exposure. The store front side of the building, on the northern exposure, is faced on the first two

stories with a continuous panel of plate glass.

On the fourth floor of the building, extending to the fifth, is a huge modern gymnasium, equipped with the latest facilities, for the use of Rockefeller Center, Inc. A physical director will be in charge.

A large portion of the office space in the new structure will be occupied by commercial and financial interests.

The new building is the second of three final units announced by Mr. Rockefeller in 1938 in a \$12,000,000 program to complete Rockefeller Center. The first of the buildings was for the Associated Press and located on the north tier of the Center. The third and last one, is to be a tall office building on the Sixth Avenue and 48th Street corner. Construction has not yet begun on this building.

The garage and office unit was designed by Reinhard and Hofmeister, Harrison and Fouilhoux, Rockefeller Center architects.



PUGET SOUND HOUSE
J. Lister Holmes, Architect

A.I.A. PRESIDENT SALUTES SUPERVISING ARCHITECT'S OFFICE

By CHARLES D. MAGINNIS, F.A.I.A.

IT IS a great pleasure to salute the Supervising Architect's Office. As I looked forward to this meeting with you I was reminded how very different your daily professional life is from mine. I was enviously aware that with you the practice of architecture is a more abstract business than it is with me. In your comparatively cloistered detachment, you no doubt miss some of the drama of the individual practitioner but there must be compensation in that serene perspective in which you are accustomed to regard your public. It is one of the occasional experiences of the private architect that he must deal with an actual and corporeal client with all the psychological complications which that idea has the faculty to convey.

The successful introduction of this valuable personage into the architectural process involves, as most of you know, a delicate and tortuous technique which singularly is not taught in the Schools and is not too confidently acquired afterwards. When he is finally captured, one lives with him in an attitude of anxious deference which is never wholly free from the apprehension of his formidable displeasure. One of the most harrowing moments of my experience is when I am face to face with my client in the presence of a leak, which, I admit, is too often. The persuasion of my innocence avails nothing, I find, at such a time. I am as completely convicted as if I had introduced the leak as an element of my design, and until the pestiferous phenomenon is removed my proud building is merely a whited sepulchre.

I am not implying that the news of leakages never percolates into the Supervising Architect's Office, but merely that, in the security of its nebulosity, it is not an event which has the capacity to reduce any identifiable member of it to an uncomfortable sense of kinship with the humble worm. And yet I am not wholly unmindful of the critical potentialities of the

120,000,000 units of our citizenry which you serve so that I know there is room in your bosoms for troubles which are not entirely domestic.

Once I rashly entered on the adventure of building a house for myself. It was only at the end of this enterprise that I thoroughly realized how important it is to hire an architect. Up till then my wife had always been vividly and influentially identified with the affairs of the home, but my complete adequacy to deal with this particular problem seemed reasonably indicated so that I was left completely to myself. It was not long before I began to feel about for that economic friction which is seldom absent from the atmosphere of clients, but I was conscious of nothing but a great softness all around me. In this predicament, I was compelled to create a client histrionically but I found him too ineffectively sympathetic. When I would invite him, for instance, to entertain the idea of paving the sitting-room with a scrumptious Greek marble he would protest he thought it in the circumstances worthy of a particularly drunken sailor, but if my professional pride could be gratified in no less opulent terms I might go ahead. With successive encounters of this dangerous character we stumbled on till we became prostrate under a pyramid of bills from which we were extricated only with painful difficulty. Since then I have held the realistic client in a new respect.

In more serious and fitting vein let me thank you on behalf of the Institute of Architects, for so hospitably including me in this hour of rejoicing over the long and honorable history of your office. It is my wish that my presence here should imply more than a mere community of interest. It should convey to you a thoughtful acknowledgement from the whole profession of the efficiency with which the office has sustained the cause of Government architecture. It would be unreasonable if the architects of America were not deeply concerned that, in the quality of its products no less than in the

*An address at the 103rd anniversary dinner of the Supervising Architects Office, Washington, D. C.

high plane of its administration, such an agency as yours should be worthy of the best architectural tradition. Nor need it be thought singular that this solicitude should have developed apprehension that, with all its admitted competency, any undue comprehensiveness of its interest might well represent a denial of opportunity to talents both worthy and eager to serve the nation. If, in recent years, this feeling has been expressed more anxiously, more passionately, it has been the voice of a profession at tragical disadvantage with the times.

It is particularly gratifying to me, therefore, that I address you at a moment when the Treasury Department, taking considerate and sympathetic account of these circumstances, has provided for a measure of recognition of the private architects of the country through a system of regional competitions.

This gesture, as you are aware, has been received with marked satisfaction by the profession and with the hope that it may make for such results as will encourage the Department to identify the architect as responsibly as possible with his finished product.

In view of the esteem in which American architecture is held abroad this recognition comes felicitously on the eve of the first meeting in this country of the International Congress of Architects under the auspices of the United States Government. We are all greatly interested in this visitation which, incidentally, will bring the Federal aspect of Washington under a new and critical scrutiny. Our people are intelligently convinced of the beauty of the Washington scene and of the debt we owe to the men of an older day who perceived the vision of it. We must not be surprised, however, if the incorrigible classicality of its archi-

ture provoked only an oblique politeness from the more sophisticated of our visitors who have embraced the new architectural philosophies. Nor should we permit ourselves to be disturbed by an attitude which, after all, is not unfamiliar even here. We are all trying very thoughtfully to determine the measure of our present obligation to history or whether we have any which should prevent our consigning it utterly to the waste-basket. Meantime, architecture is so inscrutable an interest that it reminds me of an incident which recently happened in Cambridge. A member of the crew had boasted of getting high marks and, on being pressed, admitted it was in Sanscrit. The following morning two athletic young men called on Professor Lanman to express an interest in his subject. The professor, excited by the implications of intellectuality from so strange a quarter, showed them his choicest books. When they were leaving presently, Mrs. Lanman was just in time to overhear one of them exclaim, — "Hell! it's a language!"

I find myself uncomfortably close here to the verge of controversy and I must sheer off. The President of The Institute should deal discreetly with his private and fallible opinions on matters which will in all likelihood soon settle themselves. It is to be assumed that he is not oblivious to the fact that the material world has changed considerably since the days of Mr. Mills and that the circumstance deserves its due acknowledgment. Nevertheless, he is moved to express the hope that in this accommodation the men who shape the architecture of Government may not be persuaded to put too light an estimate upon the merit of a tradition which has given so gracious and distinguished a countenance to our National Capital.

ARCHITECTS SHOULD KNOW THEIR BUILDING MATERIALS

By PAUL SCHWEIKHER in *Monthly Bulletin*,
Illinois Society of Architects

THE past ten years of increasing political and economic confusion, though devastating to the quantity of building as a whole, appear to have had some salutary effect upon the quality. Industrial and commercial building, reduced in great part to that amount required by immediate needs, is more disposed to a simple pattern of enclosure—while reduction of private residential building induces consideration of low-cost apartments and single family dwellings in which eclecticism in style and taste must give way to frugal and more efficient shelter.

Cost limitation alone may not be taken as assurance of an architecture pertinent to modern life. In fact, too often in the past, projects both large and small which imposed severe economic restrictions as initial factors in design, have been regarded as unworthy of the architect and have been abandoned to whatever fate callous minds would subject them.

There are more recent instances, however, where the sobering effect of curtailed budget has been an incentive rather than a deterrent and has produced thoughtful and careful arrangement of space with directness of purpose and economy of line and surface.

Then too, there is little doubt that the principles of organic architecture originally proposed by Louis Sullivan have gained increasing significance and acceptance, for it is easier, within a limited budget, to justify a building as an expression and embodiment of the life and structure within, than it is to attempt to justify it as an authentic reproduction of a past style.

Perhaps no single factor is responsible for the renewed energy which has been imparted to architecture in this country. The fact remains that plan, as a part of the whole, is less cluttered and inhibited by eclectic imposition than heretofore.

It is through material that plan is effected and through the correlation of both that build-

ing gains validity as architecture. No real vitality can accrue to plan as a part nor building as a whole until material is used with the same clarity and assurance of purpose exhibited by its counterpart, plan.

However, examination of examples of this new and promising architecture in terms of material alone continues to reveal, in the majority of instances, either a total disregard of material, so long as it accomplishes support or division of one kind or another, or an uninformed enthusiasm for the material itself that disregards both its purpose and that of the structure which it was intended to serve. The result in either case is bizarre.

Even materials having a direct structural purpose, that is, supporting members such as steel and concrete columns, beams and slabs, are seldom integrated with the design as a whole. It continues to be general practice to arrange space with only a casual regard as to the manner in which that space can be enclosed. Actual analysis of the supporting framework is deferred until the design, if so it may be called, is completed. Meanwhile, material is imbued with infinite size, shape and elasticity. The result is invariably awkward. The skeleton must be clothed and all manner of false work is resorted to.

It might be that false ceilings, walls and pilasters can be and are converted to other uses than that of hiding the imperfections of ill-conceived and poorly thought-out structural systems. Even assuming that waste space so contrived is partially excused by the presence of conduit, ducts, pipes and other paraphernalia, the next question is why these materials, too, are not thought of as part of the design. If because of imperfect material, or technique, then it is time that both material and technique pertaining to this work were perfected. This should not be too stringent a requirement where improved technique has become a byword of production. At any rate, it is not re-

assuring to observe the clean flowing lines of a new architecture knowing it to be held together by a maze of rusty wires and hooks.

Materials comprising the shell of a building appear to suffer not only from lack of sympathetic handling by this same casual acquaintance with their properties, but often add to it that particularly invidious artifice of pretending to perform work of which they are incapable.

Glass brick, chromium plated metals, photographic panels of marble and wood, antiqued asbestos and neon lights are measured out by the yard. Veneer, justification of its use still denied, continues in vain attempts to simulate construction based upon the solid mass of the material. Glass, tile, brick and stone bond together as beams or columns to span unbelievable chasms, or to carry impossible loads. Monolithic slabs of wood twist and turn to all shapes and sizes.

To contribute to the general confusion is added another popular misuse of material—that of applied ornamentation. This is contrived by the rather simple expedient of juxtaposing, one with the other, all known and available materials at random over all available surfaces.

It is not the fault of the materials industries if they are misled at times to believe that this new artificiality is what architecture needs and wants.

The manufacturers of finished hardware and electric light fixtures constitute outstanding examples of this mis-direction. A variety of horizontal and vertical striations and set-backs available in brilliant colors and trimmed in chromium is the standard vocabulary.

And it is only by the authority of good advertising that the kitchen and the bath are considered the best rooms in the modern house.

Here are materials of equipment that are in urgent need of the architect's attention. First, however, he must know them—better, even, than the mixture of the concrete forming the foundation of his building.

Knowledge alone of the properties of materials might not be sufficient to prompt honest

treatment, but knowledge of the inherent character of material—its mass and structure as well as color, texture and adaptability to building—should be sufficient to produce a sympathy with that material and a desire to integrate it with the building as a whole, such as to prohibit all artifice, however ingenious.

The school is the place in which the fundamentals of such knowledge should be acquired and it is to be hoped that courses in the fundamentals will soon become a mandatory part of architectural curriculum.

It is difficult to believe that any one individual may have the capacity or life span to accomplish a full and sympathetic understanding of all the materials now available, nor should it be necessary. Stone, wood and brick, aided by lead, copper and tile, were sufficient to express with considerable eloquence the variety of the architecture of the Chinese and Japanese, the Egyptians, Persians and Mayans, as well as the life of these peoples embodied in their architecture.

Further, it is questionable as to whether more than a select few materials actually belong to building at all—certainly those materials which have no other justification for existence than a facility for representing something which they are not, should be rejected without hesitation or further consideration.

It is apparent from what has been said that no attempt is made to suggest a formula or method in the use of material in modern design—least of all to recommend any one or group of materials—rather only to point out the present irresponsible and unsympathetic use of material and the need for careful and considerate application to the subject, in the hope of developing a true sensitivity and feeling for this medium of structure.

It is better as a whole to be satisfied with a closer acquaintance with a few basic materials, and to concentrate on these with the same sincerity and honesty given to present-day plan, that an integration of plan, material and ultimate building may become a truly representative architecture.

EARTHQUAKE STUDIES FOR PIT RIVER BRIDGE

By J. L. SAVAGE, M.A.S.C.E.

Design of the Pit River Bridge, with its concrete piers 360 ft. in height, called for a painstaking study of the possible effects of earthquake. Fundamental investigations were undertaken along a number of lines, and numerous stress analyses of the proposed structure were made, based on actual accelerometer records obtained during quakes whose destructive intensity is a matter of record. This work, says the author, has led to new conceptions of earthquake effect and to better design methods. Mr. Savage's article, which was on the program of the Structural Division at the 1939 Annual Convention of the American Society of Civil Engineers in San Francisco, is a brief synopsis of the methods employed and the results obtained in these investigations.

CONSTRUCTION of Shasta Reservoir, a unit of the Central Valley project in northern California, involves the relocation of the Southern Pacific Railroad and of U. S. Highway 99. The relocated railroad and highway will cross the Pit River arm of the reservoir on a double-deck, steel cantilever bridge that requires concrete piers of 360-ft. maximum height and of over 300-ft. submerged height. These high submerged piers, as well as the steel superstructure, have been designed with due regard to earthquake effects, which are found to have an important bearing on the stresses.

The early discussions of earthquake effects in their relation to the design of the Pit River Bridge led to the following tentative conclusions:

1. The effect of submergence of the piers should be considered.
2. The assumption of a fixed percentage of gravity as a measure of earthquake intensity may give adequate strength in parts of the structure but entirely inadequate strength in other parts.
3. A better criterion would be to use the accelerograms of actual earthquakes and investigate mathematically the effects of these earthquakes on the structure.
4. The mathematical investigations should not only be based on the assumption of elastic action but should also consider the case of a pier rotating at the base.

As a result of these tentative conclusions three fundamental investigations were undertaken as follows: (1) The effect of submergence on the apparent or virtual mass of a pier; (2) earthquake effects in a bridge on elastic piers

fixed at the base; and (3) the stability of a rigid pier rotating at the base. These investigations have led to new conceptions of earthquake effect and to better design methods. They explain why piers and similar structures, although not originally designed to withstand earthquakes, are often little affected by them. They show that if actual recorded earthquake acceleration intensities are applied as a steady force to the Pit River Bridge piers, the resultant generally will fall outside the base, indicating failure. However, if this assumption were correct many bridge piers and similar structures in the vicinity of the Long Beach, Calif., earthquake of March 10, 1933, and of the Helena, Mont., earthquake of October 31, 1935, would have failed, which was not the case.

Mathematical analyses, supplemented by shaking-table investigations, lead to the conclusion that any lateral earth movement tending to tip the pier, reverses its direction before the mass of the pier can follow such movement, and that this restoring effect takes place as soon as the lateral movement is of sufficient magnitude to throw the resultant force toward the edge of the base. Under these conditions the pier no longer behaves like an elastic structure fixed at the base. On the contrary, it acts as a rigid structure rotating at the base.

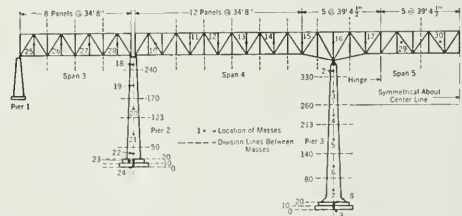

The design criteria that resulted from these studies can be summarized as follows for the Pit River Bridge:

1. Design the pier base with strength and stability for the usual lateral loads, such as wind and traction forces, without any consideration of earthquake effects.

2. Design the pier above the base for lateral earthquake forces of such intensity that the resultant is at the edge of the base. While these design criteria are for piers only, the investigations were extended to include the superstructure in its entirety.

The virtual mass may be found experimentally simply by letting a model of the body oscillate slowly as a pendulum, first in air and then in fluid, and comparing the periods; it can also be determined mathematically in simple cases. As an example of the importance of this factor, it is of interest to note that the virtual mass for Pier 3, submerged and moving "broad-side," is more than twice the mass of the submerged pier.

In the case of a bridge pier of slightly varying width it has been found experimentally that the two horizontal principal additional virtual masses may, for practical purposes, be taken as the fluid contained in the circular truncated cones constructed over the broadest and narrowest vertical projections, respectively, of the pier. The additional virtual mass in any other direction is the sum of the vector projections of the two principal virtual mass vectors on the desired direction.

The vertical virtual mass to be used in the determination of the restoring moments for a tilted submerged pier under full uplift can safely be taken merely as the mass of the buoyed structure. The effect of skin friction on the behavior of a submerged pier must not be confused with the concept of virtual mass, but must be included in the equation of motion as a viscous damping effect. However, with the velocities and displacements involved in connection with pier displacements during earthquakes, it is doubtful if this damping is of great consequence. It would be on the side of safety to ignore it.

In the stability investigations of a submerged pier, considered as a rigid body, the concept of "virtual rotary inertia" also becomes of importance. For practical purposes, when small displacements are to be dealt with, the rotary moment of inertia about a line in the base plane perpendicular to the plane of rotation may with sufficient accuracy be taken simply as the polar moment of inertia of the total virtual mass.

If the structure is subjected to a steady transverse acceleration it will be bent into a certain pattern, distinct from the mode patterns, but the coefficients of the several modes are to be determined by fitting this pattern by a series of the modes in a manner similar to that employed in the development of a Fourier series. The amplitude of vibration in each mode during the quake is proportional to a quantity determined by the natural frequency of the mode and the characteristics of the quake. These quantities can be calculated from the action, or obtained from experiments performed on a torsion pendulum. Displacement curves are required for operation of the torsion pendulum but these are readily obtained from the accelerometer records by double integration.

It was found in the course of the studies that the restoring moment necessary at the section between the base and the foundation may become greater than can be delivered by the weight of the pier and the attached structures. For this reason the base plate will lift off the foundation to an extent depending on the dimensions of the pier, the magnitude of the ground displacement and the frequency of the motion. Therefore, the analysis in which the pier is treated as a cantilever fixed at the base will be valid only if the pier is actually anchored to the foundation.

It is interesting to see what will happen if the crack is allowed to open. In order to investigate the stability in this case it is assumed that the pier shaft is absolutely rigid, and that it will begin to rotate about some line perpendicular to the motion of the foundation, and located in the base plane of the pier plate. The

(Turn to Page 50)



CONTEMPORARY STYLE SEEN IN WOODSIDE HILLS MODEL HOME

AN interpretation of today's mode of living is expressed in the design of Good Housekeeping Model Home in Woodside Hills, west of Atherton, San Mateo County, California, and one of the most discussed houses in the group of thirty Exposition model homes built within the past year to interest World's Fair visitors, as well as our own people, in California home life. Gardner A. Dailey, the architect, has successfully made this house a direct translation of the needs of modern country in-and-outdoor life.

A sense of openness and freedom between the interior and the surrounding countryside is expressed in the plan through the clever use of sliding panels in every room. These panels slide on tracks for minimum interference with the drapes. They are low enough to the floor to permit of a sweeping view of the surrounding country. And incidentally the sliding windows do not protrude and monopolize terrace space. Little or no sense of separation is to be felt between rooms which seem to "flow" into one another. This "space sense" symbolizes the liberty of movement which our modern country life demands.

Countless details of the architecture lend veracity to the architect's motif. The overhanging eaves, for instance, accomplish two objectives: they serve as visors to remove the sky glare from the rooms; and they create a shadow line, lending color to the exterior.

The house has twelve rooms—all on one level—with garden room connected by a covered patio. Adjacent to the garden room—wind-protected by it, and by the main wing of the house—is an 18 by 40 foot swimming pool.

Underwater lighting has been provided for night swimming.

Heat absorbing window glass, an automatic telephone exchange serving fourteen telephones, fluorescent daylight tube lighting, air conditioning and an aluminum coated built-up roof are just a few of the many interesting details of the home.

The grounds, nearly two acres, are marked with a pair of large oak trees, between which the house was constructed. These oaks were made centers of life in the garden. One shelters the main garden terrace, directly above the covered walk connecting the house with the garden room. The other has at its base a natural garden terrace done in redwood cobbles, surrounded by shade-loving plants such as azaleas, begonias and ferns. The lines of the garden have been kept simple and sweeping in character to blend with the rolling hills.

The landscape architecture is by Thomas D. Church; the builders, Suburban Builders, Inc., co-sponsored by Good Housekeeping Studio and David D. Bohannon, developer of Woodside Hills.



PLAN, GOOD HOUSEKEEPING MODEL HOME. WOODSIDE HILLS, MENLO PARK

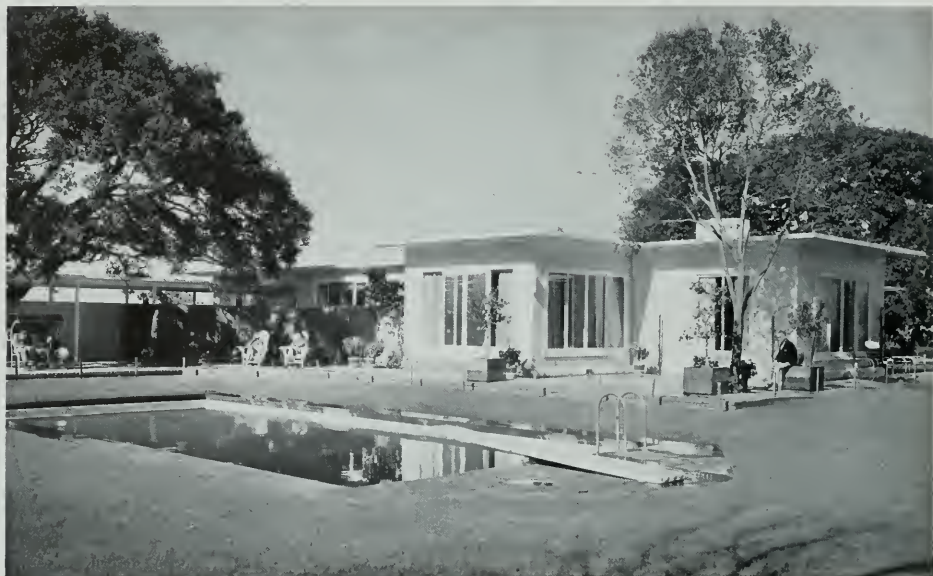

SWIMMING POOL, GOOD HOUSEKEEPING HOME, WOODSIDE HILLS,
MENLO PARK

Gardner A. Dailey, Architect



GARDEN VIEW, GOOD HOUSEKEEPING HOME, WOODSIDE HILLS,
MENLO PARK

Gardner A. Dailey, Architect



NIGHT VIEW, GOOD HOUSEKEEPING HOME, WOODSIDE HILLS,
MENLO PARK

Gardner A. Dailey, Architect



Picture windows lend out-of-door atmosphere to this room which overlooks flower covered terrace. The windows are aklo plate, a heat-absorbing glass that reduces sun-ray heat and minimizes glare.

DINING ROOM, GOOD HOUSEKEEPING HOME, WOODSIDE HILLS,
MENLO PARK

Gardner A. Dailey, Architect



LIVING ROOM, GOOD HOUSEKEEPING HOME, WOODSIDE HILLS,
CALIFORNIA

Gardner M. Dailey, Architect

Earthquake Studies for Pit River Bridge

(Continued from Page 46)

actual instantaneous axis of rotation can be determined as the center of the foundation reactions during the rotation, and will depend on the rigidity of the base plate and the foundation. The rotary moment of inertia about the base now becomes of major importance in the stability considerations, whereas it is of little importance, and as a rule entirely neglected, when the pier is treated as a flexible cantilever fixed at the base. The rotary inertia in itself will oppose the various impressed motions of the foundation so that the center of percussion will remain practically stationary during the quake.

The laws of mechanics governing rigid body translation and rotation about an axis lead to the conclusion that the stability of high piers is only slightly affected by earthquakes that have proved destructive to other types of structures. It is then only the question of

strength which is involved. The forces that act on the various portions of the pier during the accelerated motion are very easily determined mathematically under the above-stated assumptions. It can be shown that the axis of rotation lying in the base plane will be sufficiently inside the edge of the base plate to keep the reactions well below the permissible bearing pressure on good rock foundation. In determining tilt of the pier, it is necessary to consider both the deformation of the base plate in compression, bending, and shear, and the deformation of the contact area of the foundation itself under normal and shear forces. This part of the work resembles the problem encountered in roller bearings.

An interesting result of the investigation should be mentioned—namely, that the maximum displacement at the top of geometrically similar piers during the same earthquake is practically independent of the height.

MODERN DESIGN EXPRESSION OF TRUE BEAUTY AND SIMPLICITY

By GEORGE W. WALKER

NO change in the history of mankind has been so abrupt or revolutionary as the change through which we have been passing in the last decade.

Air-conditioning . . . electricity . . . high speed transportation . . . instantaneous communication . . . motion pictures . . . athletics . . . radio . . . television . . . flight—all these have made deep impression upon our lives and habits.

We are living in an age of motion, of swift transition, of short cuts and high pressure.

Indelibly, this age is making its mark upon our dress, our speech, our manners, our eating and drinking, our humor, our amusements, our engineering and all phases of our daily living.

And further, the age has expressed itself in our furniture, decorations, motor cars, kitchen utensils, radios—just as every other period has expressed itself.

Out of the period in which we are living has grown a new form of art, or design. And industry, suddenly has discovered that it is most valuable.

For want of a better name, we must call it **Modern Art**, for it is contemporary with the times in which we are living. And it is here to stay.

It is generally believed by those who are qualified to express opinions on art that our present era of Modern Design is having as vital an effect upon the lives and habits of people everywhere as were such important periods as the Tudor, the Renaissance, the Georgian, the Colonial, the French Provincial, the Federal or the Regency.

Please, however, don't confuse Modern Design with the Modernistic or other freakish forms of art that have manifested themselves within recent years. Modernistic designs and other freakish style fads have been definitely outmoded.

Modern, or Contemporary Design is based on the age-old principle that true beauty finds its fullest expression in utter simplicity.

Modernistic Design, on the contrary, generally embodies frills and furbelows and "Gingerbread." It is complicated—and true lines of beauty, if any, are therefore subordinated or lost. Modernistic Design is as out-of-date, from present day standpoints, as the bustles and frills and feathers which characterized women's wear of the so-called Gay Nineties.

Even today, there is a tendency on the part of stylists of women's wear to stray away from the basic principle that true beauty grows out of simplicity of line and design—but this can in no way be considered a trend. Rather, the tendency toward modified bustles and frills and feathers, which has manifested itself of late, is a passing fancy—a flash-in-the-pan.

The real trend in style, not only in women's apparel, but in the multitudes of products now in use, is toward the gracefully simple lines that combine to bring real beauty.

Is Modern Art, or Design, salable, when applied to a product? Most emphatically, it is!

Could you sell Anna Held products in Joan Crawford's time? Most emphatically—no!

Today's buyer is style-conscious—and today's buyer has already definitely and completely expressed his preference for the products that are styled along the lines of modern beauty—the products whose design is in keeping with the best principles of our present day.

Take two products of equal value and quality but of different degrees of beauty. The result is a foregone conclusion. The buyer invariably chooses the more attractive of the two.

For example, the old dishpan comes into the studio of the industrial stylist, or designer. He goes into action—and then the pan emerges—a smart, new container, perhaps with bands of color. As a rule, the "styled" dishpan doesn't cost any more to make—or any more to sell

—than its ugly predecessor. Which would the housewife select? The answer is obvious.

For many years, kitchen cannisters were just kitchen cannisters. They were round and they were painted with flower scenes to make them appear attractive. But the cannister that belongs in the modern house must have entirely different lines. It must hold more and it must be possessed of a simple beauty and grace. Because they are "styled" — and hence possessed of plenty of eye appeal—more kitchen cannisters are being sold today than ever before.

This business of applying the best principles of modern art to everyday products is a comparatively new one. It's not more than ten years old.

And it's not quite as simple as it seems, because it consists of far more than just creating "pretty pictures."

This business of "lifting the faces" of America's products is art—plus engineering—plus salesmanship — plus constant study of the trends of buyer preference.

SLUM CLEARANCE BRINGS BUILDING TOTALS TO NEW HIGH

Building throughout Northern California, South to Bakersfield and the State of Nevada, took another spurt in August and according to Architects Reports the month was one of the best of the year. There was a considerable gain in apartment house construction, due probably to the start of one of the principal Federal Housing projects. Plans are in progress for a row of 2 story houses and apartment buildings in the Potrero Hill District of San Francisco which will run close to the two million dollar mark. In the "Plans in Progress" column there was a slight drop in volume from the previous month but in "Projects out for Bids" public

work showed a gain for the month of nearly \$1,000,000. Government buildings also made a substantial gain under the "Contracts Awarded" classification. The total volume of public work was \$14,123,000.

Building construction in all classifications for August, according to the records of Architects Reports, amounted to \$32,560,603 as against \$22,526,746 for July, a net gain of \$10,033,857. The total for the two months was \$53,087,349.

Classification of the three major divisions with the totals of important items in each, follows:

Plans in Progress	
Apartments	\$ 1,707,000
Residences	55,000
City, County & State	337,000
Schools & Colleges	2,292,000
Office Buildings	56,500
Theaters	440,000
Churches & Mausoleums	149,000
Stores & Markets	62,000
Industrial Buildings	100,000 \$ 5,198,500
<hr/>	
Projects out for Bids but not Awarded	
Apartments	\$ 77,500
Residences	173,000
Government Buildings	6,406,366
Schools & Colleges	207,277

City, County & State	482,500	
Industrial Buildings	1,030,000	
Hospitals, Theaters, Churches	230,000	\$ 8,606,643

Contracts Awarded		
Apartments	\$ 321,100	
Residences	355,700	
Government Buildings	14,123,760	
Schools & Colleges	1,399,147	
City, County & State	174,363	
Office Buildings	1,176,483	
Stores & Markets	259,055	
Industrial Buildings	667,600	
Hospitals, Theaters, Churches	278,252	\$18,755,460
<hr/>		
		\$32,560,603

ARCHITECTS' CONGRESS AND INSTITUTE CONVENTION

ARCHITECTS of many nations will convene in Washington September 24 for the Fifteenth International Congress of Architects. The organization meets for the first time in the New World at the invitation of the Congress of the United States and President Roosevelt.

The seventy-first convention of the American Institute of Architects will be held concurrently with the Congress, and will be attended by delegates representing 15,000 American architects. The sessions of both bodies will last one week and are expected to attract the largest number of architects ever assembled in this country. Housing experts, city planners, and authorities in allied fields will participate in the proceedings of the Congress and the convention.

World problems of planning, population, contemporary architecture, government participation in building, and the function of public authority in determining the artistic worth of proposed structures, feature the agenda of the Congress, announced by the Committee on Organization appointed by Secretary of State Hull.

The Congress will have five official languages—English, French, German, Italian, and Spanish. Papers may be submitted, and discussions may be conducted in any one of these tongues. The Government of the United States, the American Institute of Architects, and the American section of the Comité Permanent International des Architectes will act as hosts.

Following a day of committee meetings and other events, including a reception at the Corcoran Gallery of Art, the Congress will formally open at noon on Monday, September 25, in the auditorium of the Department of Labor Building, with an address of welcome by Charles D. Maginnis of Boston, who has been elected president of the Congress. Monday evening there will be an official reception by the United States Government at the Pan American Union building and in the adjacent gardens, with members of the United States Congress, and of the Diplomatic Corps, as well as other dignitaries present.

Emile Maigrot of Paris, France, will preside at the first discussion of the opening session of the Congress on Tuesday, September 26, at 9:30 a.m. "Planning and Development of Rural Districts" will be the theme. The secretary will be Harvey Wiley Corbett of New York City, and the reporter-general will be Gilmore D. Clarke of White Plains, N. Y.

Professor Albert Calza Bini of the Ecole Supérieure d'Architecture, Naples, Italy, will be president at the second discussion on Tuesday morning, at which the theme will be "The Relation Between Population Density and Built-Up Area." John A. Holabird of Chicago will be secretary and Frederick Bigger of Pittsburgh, reporter-general.

The Architect's Copyright will be the theme of the second session on September 26 at 2:30 p.m. David J. Witmer of Los Angeles will be secretary and Frederick V. Murphy of Washington, D. C., reporter-general. The president of this session has not yet been chosen.

W. Curtis Greene, England, will be president of the third session on Wednesday morning, September 27, when the theme will be "Contemporary Architecture Compared to the Architecture of the Past." William A. Delano of New York will be secretary, and George Howe of Philadelphia, reporter-general.

"Comparison of the Remuneration Received by Architects in the Different Countries" will be the theme of the fourth session on Wednesday afternoon. J. Otis Post of New York will be secretary and John P. B. Sinkler of Philadelphia, reporter-general. The president of this session is yet unnamed.

A special session of the Congress at 5:30 p.m. on Wednesday will be devoted to lectures on "Light and Architecture" illustrated by motion pictures in color. Leading architects will explain the use of light at the New York World's Fair and the Golden Gate International Exposition.

Two themes will be discussed at the fifth session on Thursday morning, September 28. One is "The Consequence of the Participation by Government, Whether Federal or Local, and/or by Private Enterprise, in the Preparation of Plans and the Carrying Out of Building Operations." The other is "Should Public Authority be Clothed with Power to Reject Plans as Artistically Unsatisfactory Rather Than as at Present for Purely Technical Reasons Only?"

Dr. Frederico E. Mariscal of Mexico City, Mexico, will preside at the discussion of the first theme, with Arthur Brown, Jr., of San Francisco as secretary and Charles Butler of New York as reporter-general. Henri Labelle, Canada, will preside at the discussion of the second theme, with J. Monroe Hewlett of New York as secretary and William Emerson of Boston as reporter-general. Action on resolutions Thursday afternoon will conclude the formal business of the Congress.

The following have accepted the invitation of the American Institute of Architects to open discussion of the various themes: Sverre Pedersen, Norway; Emile Maigrot, France; Henry van de Velde, Belgium; Uno Aahren, Sweden; H. S. Goodhart-Rendel, England; Alberto Calza Bini, Italy; Carlos Contreras, Mexico; Percy Erskine Nobbs, Canada.

Past presidents of the American Institute of Architects will act as vice presidents at all sessions. The secretaries and reporters-general are all Fellows of the Institute.

Many schools of architecture in Europe and in North

and South America are sending delegations consisting of faculty members and students to the Congress, in connection with which a special meeting of the Association of Collegiate Schools of Architecture will be held.

Several exhibitions are scheduled by a committee on exhibitions, of which Julian C. Levi of New York is chairman. One will portray "The Architecture of the Americas," and another, "Representative Post-War Architecture in the United States."

An elaborate program of social events, visits to housing projects, to Williamsburg, Va., and other places of historic and architectural interest; luncheons, and receptions, in which representatives of the Federal Government will participate, has been arranged. The official banquet will be held at 8 p.m. on September 27, when the delegates will be the guests of the government of the United States. Several meetings of the Comité Permanent International des Architectes of which Paul Vischer of Basle, Switzerland, is president, will be held.

Monday, October 2, will be observed as Architects' Day at the New York World's Fair. Ceremonies in honor of the foreign architects have been arranged by a New York committee headed by Stephen F. Voorhees, chairman of the Fair Board of Design and a past president of the Institute. The Golden Gate International Exposition has designated October 11 as Architects' Day.

C. C. Zantzing of Philadelphia will be secretary-general of the Congress and Dr. Andrew C. Simonpietri of Washington, secretary. The Committee on Organization is headed by Mr. Maginnis, who is also president of the Institute. Other members are: Dr. Warren Kelchner, Department of State; Louis A. Simon, Supervising Architect, Treasury Department; Edwin Bergstrom, Los Angeles; Harvey Wiley Corbett, New York, and Richmond H. Shreve of New York. U. Grant-Smith of Washington is honorary secretary of the committee. Mr. Shreve is the executive officer of the Congress.

Secretary Hull, with the approval of President Roosevelt, has appointed eight delegates to represent the United States officially at the Congress. They are Mr. Maginnis, Mr. Simon, Mr. Bergstrom, Mr. Corbett, Mr. Shreve, Mr. Voorhees, Mr. Zantzing, and George Oakley Totten, Jr., of Washington. Mr. Maginnis is chairman of the delegation.

ENGINEERS STUDY WATER RESOURCES

A broad study of land and water use in the Sacramento Valley, in correlation to the Central Valley Project, is being undertaken by the United States Bureau of Reclamation.

Associate Engineer S. P. McCasland, working out of the Sacramento office of the Bureau, is in charge of the investigation which will extend to all parts of the valley.

The study will cover available water resources, and their conservation; lands adaptable to irrigation and possible crops to be grown on such lands; and methods of conveying water to various areas of use.

Walker R. Young, supervising engineer of the Central Valley Project, said the investigation will include two phases—first, a consideration of the irrigation potentialities of the Sacramento Valley under ultimate development of its water resources; and second, a determination of the extent to which the demands for water can be met by Shasta Reservoir, principal feature of the project now under construction by the Bureau of Reclamation.

GAS APPLIANCES TESTING LABORATORY

Ceremonies marking the laying of foundations for a new \$40,000 Pacific Coast branch testing laboratory to be erected by the American Gas Association, were held in August at the site of the building, 1425 Grande Vista Avenue, Los Angeles. Gas appliance manufacturers and utility executives from up and down the Coast took part in the ceremony, at the end of which a commemorative plaque was placed at the front entrance of the building.

The American Gas Association Testing Laboratories were founded by the gas industry to provide a central agency for the testing of gas appliances—ranges, water heaters, and househeating equipment—in order to insure uniform standards of safety, efficiency and structural quality. A main laboratory is situated in Cleveland, Ohio, and since 1930 a branch laboratory has been maintained at Los Angeles. Growth of the gas appliance manufacturing industry on the Pacific Coast has been so rapid that the Association found it necessary to build new and permanent quarters here.

According to W. H. Vogan, supervisor of the Pacific Coast branch, 90 gas appliance manufacturers are now using the facilities of the laboratory, as compared with 75 four years ago. During the last year, 851 appliances and accessories were tested here. This represents the largest number ever to pass through the local branch, and is three times the volume of 1935.

The new laboratory, a one-story structure covering an area of 100 x 91½ feet, will be built of reinforced concrete and stucco over a steel frame. The exterior design is modern, the only decoration being four large porcelain replicas of the famous American Gas Association Testing Laboratories' "Blue Star Seal" set in the front and sides of the building.

Laboratories for testing appliances are situated in the rear half of the building and are arranged in a manner similar to the Cleveland laboratory. One room is devoted to the testing of central heating equipment, another to gas ranges, and a third to gas water heaters. A staff of 20, including 17 graduate engineers, is required to handle the work that passes through the laboratory.

With the Architects

STORES AND APARTMENTS

Excavating is under way for a five story reinforced concrete store and apartment building at Bancroft Street, near Telegraph Avenue, Berkeley, for R. E. Lucas. The architect, John B. Anthony, 462 Elwood Street, Oakland, states that the building will contain 10 two and 3 room apartments and a number of stores. The mechanical equipment will include freight and passenger elevators, steam heat with oil burners and electric refrigeration. The improvements will cost \$70,000.

FEDERAL HOUSING PROJECT

Plans are in progress for the first Federal Housing project in San Francisco. The architects are Frederick H. Meyer, John Bakewell, Jr., and Warren C. Perry. The project consists of a row of two story houses to accommodate 212 families and a group of two story apartment buildings to house 88 families. Location of the improvements is the Potrero Hill District. Funds available amount to \$1,657,000.

FACTORY AND OFFICE BUILDING

A one story reinforced concrete factory and office building is to be constructed at Ford and Derby Streets, Oakland, from plans by W. H. Ellison, structural engineer, Pacific Building, San Francisco. Bids have been taken and work will start shortly. The building will cover ground area, 800 x 100 feet.

ALBERT R. WILLIAMS BUSY

New work in the office of Albert R. Williams, 251 Post Street, San Francisco, includes the remodeling of the Maxwell House Coffee Shop on Broadway, near 13th Street, Oakland, at an estimated cost of \$15,000; restaurant remodeling for Geo. Racomi at 168 O'Farrell Street, San Francisco, and a \$15,000 residence in Piedmont for W. W. Taylor.

ORINDA RESIDENCE

Irwin M. Johnson, 2219 Seventh Avenue, Oakland, has completed working drawings for a \$12,000 house at Orinda for an unnamed client. There will be seven rooms and three baths, steel sash, shake roof, gas and hot air heating. The same architect has awarded a contract to Geo. Windsor for the construction of a six room house in Alameda for Ralph C. Warmster.

\$15,000 RESIDENCE

Claude B. Barton, 522 Grand Avenue, Oakland, has completed plans and bids are being taken for the construction of an eight room house in the Upper Piedmont Estates, Alameda County, for an unnamed client. The house will have brick veneer exterior, shingle roof, hardwood floors, steel sash and gas hot air heating.

VISIT BOTH FAIRS

William J. Bain, Seattle, accompanied by Mrs. Bain, has returned from an enjoyable trip East. In Washington, D. C., Mr. Bain, who is a member of the architects' advisory committee to the Housing Authority of the City of Seattle, conferred with officials of the United States Housing Authority, regarding requirements for low-income group housing. The Bains visited both fairs en route and were much impressed with their architecture.

NEW RAILROAD ARCHITECT

J. T. Beem, architect, of Los Angeles, has been appointed architect for the Union Pacific Railroad Company in Los Angeles, with headquarters at 422 W. Sixth Street. Mr. Beem has been engaged in architectural and engineering work in the South since 1930, most of that time with Allison & Allison of Los Angeles, and J. H. Davis of Long Beach. R. J. Wirth was formerly architect for the Union Pacific.

PWA REGIONAL OFFICES MERGED

The Pacific Northwest regional offices of PWA have been merged with the California region, and offices for the entire West Coast are now maintained in San Francisco.

The personnel has been reduced about one-half.

TWO ALASKA BUILDINGS

B. Marcus Priteca of Seattle is the architect for two commercial projects now under construction at Fairbanks, Alaska. The work includes the new Lacey Street Theatre, estimated to cost \$100,000, and the KFAR radio station, estimated to cost \$20,000. Both buildings are of concrete construction.

WASHINGTON STATE SOCIETY

Plans for fall and winter activities were discussed at the autumn meeting of the Washington State Society of Architects Thursday evening, Sept. 14, in Seattle, President Harry G. Hammond presiding. Harry E. Nordquist, 704 Textile Tower, Seattle, is secretary of the Society, James M. Taylor Jr. is vice-president, and John E. Kelly Jr. is treasurer.

LITHUANIAN COMPETITION

Final date of submission of complete plans in international architectural competition for the design of a proposed President's Palace at Kovno, Lithuania, has been extended to Nov. 1, according to Ivna Michael Palmaw, Seattle, who is entered in the competition.

NEW CHAPTER MEMBER

Clare Moffitt, architect of Seattle, has recently been elected a member of the Washington State Chapter, A.I.A.

neers have taken a prominent part.

The prolonged abuses, misuses and waste of materials is still predominant in the lumber industry. Does the steel industry cart away tons of short lengths, distorted pieces, misfits and flawed members after the fabrication of a steel structure? Do the clay products manufacturers find that much of their work does not fit the setters details or does marble and stone have to be fitted piece by piece after coming from the cutters hands? The manufacturer who fails to match the march of progress in conservation of materials, the designer who does not know the proper value and use of materials, the owner who fails to recognize that technical advice is an asset instead of a cost, and the hoard of cut and fit craftsmen who are guided entirely by the use of tools are a fit combination to contribute to the waste of any building material.

It is true that in forms for monolithic construction there has been great waste of lumber but that is gradually being overcome by patented devices and standard forms.

It cannot be said that architects have not been culpable as well as others. Architects are like all other groups, progress is made inexcusably slow. Take for example our building codes. Why should every municipality have a different one? How many cities will adopt the "Building Code for California?" These questions are answered only by years of promotion and by the combined effort of all groups in the building industry.

To any one that follows closely legislative and other matters it must be conceded that co-operation is not effective between the lumber industry and the architects. They circularize us with fine letters, beautiful pamphlets, use books and the like which they extend with one hand while in the other are stock plans and plan books telling how to build without the aid of an architect. In legislative councils they are antagonistic to the architects interest. Antagonism sometimes leads to contempt. Contempt for the use of any material while there are other materials that may be substituted can lead to discrimination and discrimination in the use of materials is neither good for the architect, the consumer nor the manufacturer.

The State Association of California Architects is an organization whose purpose is: "This Association is established to advance the science and art of architecture; to encourage architectural education; to maintain the honor and dignity of the profession of architecture; to enlighten the public in relation to the province of architecture in the body politic; to advocate proper legislation and to oppose improper legislation affecting architectural practice; to support the State Board of Architectural Examiners; to co-operate with other professional associations, and to cultivate social intercourse among its members."

And like all other organizations it would not be worthy of membership if it did not afford protection. Protection from unlawful encroachment upon its professional

practice; protection from monopolistic combinations that tend to thwart free enterprise.

There lies just ahead of us a great opportunity for amalgamating our interests. Some manufacturers have already seized upon its fundamental application. In our search for the proper outlet for expression "live and let live" we intuitively turn to the work being done by The Producers' Council. Here is an organization of manufacturers and associations of manufacturers whose interest is to uphold standards and promote objectives for the betterment of their industry, and in doing so they recognize the value of the architect and engineer.

1. "To promote better mutual understanding between architects, engineers, contractors and producers of building materials.
2. "To make more effective the services rendered by each in relation to the other and to the public.
3. "To promote in various ways the legitimate interest of the producers.
4. "To uphold standards in building which will encourage the production of dependable materials, good construction, meritorious architecture and sound trade practices."

The architects can well afford to hold fast to any organization of this type, for in promoting the interest of the manufacturer they take into account those contributing organizations, middle men, if you please, between the producer and the consumer; those who plan and specify and supervise the use of vast quantities of manufactured materials.

HOUSING ACT IS CODIFIED

Attention is directed to the fact that the California State Housing Act has been codified and is now part of the Health and Safety Code enacted at the recent session of the Legislature. There were no substantive changes brought about in the codifying process, but there has been a complete rearrangement and renumbering of the sections, together with several clarifications of the Act as written at present. However, A. B. 2121 did amend the Law in certain details having to do with ceiling heights and garage construction in apartment houses and hotels, and those amendments are embodied in the Code.

The new edition of the Housing Law will be available in the near future in pamphlet form and is now in course of preparation at the State Printing Office. Distribution will be through the Supervisor of Documents, Capitol Building, Sacramento. The issue will have a complete new index prepared by the State Division of Immigration and Housing and will include a table of contents, and cross reference tables to the present Law. It will also embody, in addition to present drawings and diagrams, a set of tables on garage construction requirements and illustrations on proper plumbing layouts, all of which are intended to aid in applying the Act.

ARCHITECTS' BULLETIN

Issued For

THE STATE ASSOCIATION OF CALIFORNIA ARCHITECTS

Northern Section

STATE ASSOCIATION MEMBER
OF THE
AMERICAN INSTITUTE OF ARCHITECTS
Editor

Harris C. Allen

Address all communications for publication
in the Bulletin to the Editor (Harris C.
Allen) 557 Market Street, Room 218, San
Francisco, California.

Board of Control

Harris C. Allen Otto G. Hintermann
Harry Michelsen Wayne S. Hertzka

State Association Officers

President..... Sylvanus B. Marston, Pasadena
Vice-President..... Gwynn Officer, Berkeley
Secretary..... Wayne S. Hertzka, San Francisco
Treasurer..... Robert H. Orr, Los Angeles

Regional Director, A. I. A.

Albert J. Evers, San Francisco

Delegate Regional Director, Southern
California

Gordon B. Kaufmann, Los Angeles

Executive Board—Northern Section

Officers

President..... Gwynn Officer, Berkeley
Vice-President..... Ernest E. Weihe, San Francisco
Secretary..... Wayne S. Hertzka, San Francisco
Treasurer..... Otto G. Hintermann, San Francisco

Directors

Harry J. Devine R. H. Reimers
Wm. J. Merchant Harold Weeks

Executive Board—Southern Section

Officers

President..... Sylvanus B. Marston
Vice-President..... Louis N. Crawford
Secretary..... Winsor Soule
Treasurer..... Robert H. Orr

Directors

Merrill W. Baird Abe Edelman
Harold C. Chambers George D. Riddle

Advisors—Northern Section

Harris C. Allen *San Francisco*
J. K. Ballantine, Jr. *(Secretary)*
Sam. Lightner Hyman
Wm. G. Merchant
Jas. F. McGuiness
Dodge A. Riedy
Harold H. Weeks
Ernest E. Weihe
Albert R. Williams
Fred. H. Reimers *(President)*
C. A. Caulkins *North Bay District*
Peter Sala *Lower San Joaquin*
 District
J. U. Cloudsley *(Secretary)*
Edw. W. Kress *Santa Clara Valley*
Mario Corbett *San Mateo*
Alden Cambell *Sacramento*
Ernest J. Kump *Upper San Joaquin*
Dole F. Thomsen *Palo Alto*
Norman W. Sexton *Marin*
Geo. P. Simonds *East Bay*
Chester Treichel *East Bay*
Gwynn Officer *Berkeley*
F. T. Georgeson *Redwood Empire*
Casebolt Dakin *Upper Sacramento*
Ralph Taylor *Lassen District*

Building Cost Inquiry

THE recent statement* by assistant Attorney General Thurman Arnold, to the National Economic Committee, should be seriously considered by all branches of the Building Industry.

This deals with agreements and restraints which had the effect of increasing building costs, and the general plan of the Department of Justice to prosecute on a nation-wide scale, and simultaneously, the various combinations which are "creating the log jam in the building industry."

Unreasonable restraints of trade, he says, have not only maintained high prices in bad times, but also increased them when times improved. Such procedure resulted, for instance, in the ridiculous spectacle of rises in building costs amounting in some cities to 25%, which choked off the building boom of 1936-7.

He lists: 1.—The fixing of prices by producers of building materials, through patents, control of supply of raw materials, law suits, various devices to discipline distributors and competitors.

2.—Collusion between distributors to fix price standards, with the boycott as chief weapon, against both manufacturers and other distributors.

3.—Systems of restraint by contractors, through coercion, collusion, boycott, closed markets, secret control of bid depositories or quantity surveys.

4.—Restraint by Labor through ill-timed (but not illegal) demands for increases in wages and reductions in hours, jurisdictional disputes, boycotts by collusion with contractors, opposition to use of new products or processes.

5.—Restraint by local legislation tending to limit competition or to erect protective tariffs.

Other sources of high construction costs are referred to, such as poor credit facilities, inflated land values, fees and charges—on everything from building permits to title recording.

Mr. Arnold points out that, going beyond mere prosecution, affirmative action will be needed to develop more efficient organizations, improve financing, reduce seasonality and correct wasteful practices.

His objective is to establish a free and independent economy in the building industry; to ensure lower prices through increasing volume. With such a program the building industry as a whole should be in hearty accordance. And, unfortunately, the indictment can not be denied, although it certainly does not apply universally, and many parties are compelled in these restraints by conditions beyond their control.

The American policy calls for fair and free competition, with equal opportunity and the spur of individual incentive. If Attorney General Arnold can bring the industry nearer to this ideal, without turning prosecution into persecution, he will be doing a national service.

*Published in full in the New York Times, Saturday, July 8, 1939

ADVISORS

The Stockton District held its annual election at the regular meeting on July 31st and Howard G. Bissell was elected advisor for the coming year.

At a meeting of the San Francisco District (S. F. Society of Architects) on August 8th, the following advisors were elected:

Harris C. Allen, John K. Ballantine, Mario J. Campi, Conrad T. Kett, William H. Knowles, Vincent Raney, Frederick H. Reimers, Dodge A. Riedy, Roland I. Stringham and Ernest E. Weihe. The advisors elected Frederick H. Reimers president and John K. Ballantine secretary.

The very constructive suggestion was made (to be acted on, at an early meeting of the San Francisco advisors) that an official delegate from the San Francisco Society be appointed to cooperate with each of the local organizations interested in building—the construction section of the San Francisco and State Chambers of Commerce, the City Art and Planning Commissions, the San Francisco Federation of Arts, the Builders' Exchange, the Real Estate Board, the Commonwealth Club; as with the Building Industry Conference Board, in which a delegate has represented the Society for some years.

ARCHITECTS' DAY

October 11th has been designated as the official Architects' Day at the Golden Gate International Exposition. Plans are being made jointly by the Association and the Northern California Chapter of the Institute for a complete program, which will probably end with a dinner on Treasure Island to combine the usual pre-convention meeting of the Northern Section, and recognition of visiting architects. It is probable that at least some of the foreign delegates to the International Congress of Architects at Washington will extend their visit to San Francisco, and some Eastern architects also may take this opportunity to see our Fair.

THE TREASURY

In view of the heavy calls upon our treasury this year, and in appreciation of the sterling services of the retiring treasurer who made it possible for the Association to meet the occasion, a reminder is in order that subscriptions for this year are still welcome. If you have overlooked this privilege, send in your \$5.00 before the October convention.

1939 CONVENTION

The Annual State Convention will be held in Santa Barbara October 26, 27 and 28. Headquarters this year will be at the Santa Barbara Biltmore Hotel—one of the most beautiful caravansaries in the country, which has received Honor Awards both State and National.

Hotel rates are on the American plan, \$10.00 per person, per day for single room, \$9.00 for double room. The Biltmore Company also operates the Mar Monte

Hotel with rates on the European plan at \$4.00 for single room, \$6.00 or \$7.00 for double room. Santa Barbara architects will furnish transportation between the two hotels.

When the convention program has been finally decided, complete information will be sent to all members.

PLANNING THE HOMESITE

Pointing out that the urban family lives in a neighborhood as well as in a house and that therefore good residential building must begin with community planning, Nathan Straus, Administrator of the United States Housing Authority, has announced the publication of "Planning the Site," described as the first authoritative manual on community site planning ever issued in this country.

The principles and practices presented are drawn from the experience of technicians in designing over 250 USHA-assisted public housing projects now under way in every section of the country and in communities of all sizes. Illustrated with 35 diagrams and 5 plates, the manual is designed to serve as a textbook to architects to improve quality and cut costs of large-scale housing projects, private as well as public.

Of special value to planners are the case studies of actual USHA-assisted project sites, showing the preliminary plan, next the revised plan, improved, and finally, the approved plan with buildings placed at strategic intervals, service drives cut to a minimum, advantage taken of topography and climatic conditions.

"Three major elements," the manual states, "go into the making of a housing project—and, buildings, and people." The land and the buildings should be designed to serve as a "satisfactory frame for the lives of the people."

The publication includes a checking list for use of architects in developing site plans. The list summarizes the factors which should be considered in the preparation of the site plan, outlining in brief statements the best planning practices developed to date.

Copies of the bulletin may be obtained from the Superintendent of Documents, the United States Government Printing Office, Washington, D. C., at 60c each.

WINNER OF REGIONAL COMPETITION

William B. Ittner, of St. Louis, has been named as winner of the first in the series of eleven regional competitions for Federal buildings, announced in the June issue. The program was for a proposed Post Office and Court House for the City of Leavenworth, Kansas, with a cost limit of \$250,000.

Architects who received Honorable Mention were: Arthur R. Mann and Robert E. Mann, of Hutchinson, Kansas; Joseph D. Murphy and Kenneth Wischmeyer, Charles Lorenz, Associate, of St. Louis, Missouri; and Robert B. Bloomgarten and D. Kent Frohwerk of Kansas City, Missouri.

"LABOR'S STAKE IN U. S. PUBLIC HOUSING"

By WARREN JAY VINTON

IN the development of public housing in America, labor has played a significant role. Without the vision and the realistic approach, which characterized labor's participation in the early stages of the public housing program, we would today still be talking and writing about housing instead of building homes for workers' families. This I say as one who has closely observed the growth of the public housing movement, as one who has had a hand in both the formulation and administration of the present program.

When I said that labor played a significant role in the development of public housing in America, I meant that labor not only contributed to the housing movement, but was a decisive factor. Let us go back a few years and trace the development of a national movement which only six or seven short years ago was no more than a discussion topic for a handful of housing "experts."

Among the various efforts during the early days of the New Deal, we find several attempts at developing a public housing program. There was the Housing Division of the PWA, and the Rural and Suburban Divisions of the Resettlement Administration. The Housing Division built 51 low-rent projects for some 20,000 families in 37 cities throughout the country. Suburban Resettlement built the three well-known Greenbelt towns, and Rural Resettlement provided homes for farmers and stranded workers.

But these early public housing activities were conducted as emergency measures. They were only the beginning of a comprehensive program to meet America's housing needs, to establish public responsibility for housing.

It was labor's proposals for a public housing program that helped crystallize the experiences of those early efforts. In the resolution passed at the annual convention of the American Federation of Labor, held at Atlantic City in October, 1935, we saw the first outlines of the present program. It was my privilege to work in close collaboration with your committee at that time and also to help further at the Tampa convention the following year.

Here, for the first time, we had general acceptance of public responsibility for the housing of families for whom private enterprise cannot provide decent homes. The 1935 resolution served to formulate a program out of the confusion which was natural in early thinking on so complex a social, economic and technical problem as housing. Although the public housing program in America was 20 years behind that of European countries, once we discovered the basis for common agree-

ment, it was possible to make real headway. And the present program of the United State Housing Authority, a program which is completely decentralized, which places the initiative and responsibility directly in the hands of local communities, is the program which grew out of this early formulation by your convention, representing organized labor in America.

Labor has been a vital force in the development of this program of the USHA. Let us see, in the light of its operation during the past few years, what it specifically means to labor.

What are labor's main concerns? If we state the main objectives of organized labor, we will immediately have a gauge against which to measure the value and importance of the public housing program to labor.

Labor's first concern is employment at wages and working conditions that will protect and extend the gains made through years of struggle and sacrifice. In the public housing program, you have written the provisions which are today protecting those standards.

In addition to the jobs provided at the building site, public housing puts people to work in the heavy industries producing materials and equipment, in shipping, in offices, and in drafting rooms. For every two men employed at the site, three get jobs in these other fields of work.

By increasing wages you raise your standard of living, true. But, if at the same time you get better value for your rent payments, you also raise your living standards. It is, therefore, a second major concern of labor to obtain better homes where you can raise your families in healthful surroundings, and above all at rents that you can afford.

Low-income workers today cannot afford to live in a decent home, and yet this is a fundamental necessity for a happy family life. Wages are not high enough to pay for a safe and sanitary dwelling in addition to adequate food, clothing, medical care and other necessities of life. In the Housing Act, Congress recognized this and provided a subsidy to make it possible for low-income families to live in decent homes. This subsidy bridges the gap between what the family can afford to pay and what it costs to operate dwellings built under the program. Contributed by both the Federal government and the locality, this subsidy results in low rents that low-income families can afford.

The need for aid in supplying decent housing for low income families is the result of the same underlying social and economic conditions which cause millions of children to suffer from disease because of under nourishment, despite the tremendous technological improvements in the production of food stuffs. It is the result of the same factors that deprive millions of people of

Abstract of a paper read before the Massachusetts Federation of Labor, Boston, August 9.

adequate medical care, even where there is an oversupply of physicians and despite the amazing strides in the science of medicine.

Now, for the first time in the history of civilization, we are able to produce more than we can consume. That is, we have the necessary resources, man power and machines, but we have not yet solved the distribution problem. Public housing, as a method of improving American economic life by distributing income more equitably, is one way to solve that problem.

Housing aid puts more purchasing power at the disposal of those who need it most, making it available for purchasing the fundamental requirement of every family—a decent home. Public housing is thus one of the most potent weapons in solving this basic economic problem of our time—that of securing a just and equitable distribution of the national income. On the one hand it provides more employment at fair wages, and on the other augments the purchasing power of families of low income by the subsidies which it pays for their benefit.

In addition to providing homes for low-income families, the Housing Act requires the elimination of slums. For every dwelling built under the public housing program, a slum shack must be torn down, boarded up or repaired to come within the housing standards set by the Act. Instead of growing ever larger, this means that our slums are beginning to disappear. With the slum will go the high disease and death rates, the crime and juvenile delinquency and the fatalities that result from fires in these areas all over the country.

The third major concern of labor is the general well-being of the nation as a whole. Without a healthy and prosperous economy, redistribution of wealth is meaningless, nor, as we have learned during the last decade, can wage standards be maintained.

The money spent in housing percolates through practically every phase of our economy. From the production of raw materials in forests, quarries and mines, through the various processes in plants, mills and shops throughout the country, and finally in shipping to the building site, private enterprise is stimulated. Through building operations the dollar turns over more often than in any other industry. And, as this process goes on, idle capital and idle machines are put to work and jobs are created all along the line.

If we stopped to analyze what happens to the wages paid through housing we would see local merchants busily ringing up sales for food, for clothing, for household furnishings, etc. And the work created by these sales means jobs for boot and shoe workers, for textile, for furniture and other workers.

And all this is accomplished through the established agencies of private enterprise, and at a relatively small actual public expenditure. Public housing is a productive undertaking. It greases the wheels of our entire economy.

These then are the three main concerns of labor, and

the public housing program provides direct benefits in every case. It provides jobs, it provides better homes, and it helps build an economy under which labor may protect and extend its gains.

But in 1935 labor was not content with merely outlining a program. Had that been so we would be no further along now than we were then. No, labor, being realistic as it always must be, took steps to attain those objectives. It is those very provisions of your resolution which called for action on the part of labor that I want particularly to stress.

In carrying out those portions of the resolution dealing with organization of labor housing committees and representation in community housing activities, labor worked hard throughout the country, and labor in Massachusetts did its full part. Labor took those provisions seriously and the results speak for themselves. In Massachusetts you have done far better than the rest of the country in this respect, with labor well represented on eight of your ten housing authorities.

In the United States as a whole there are some 250 local housing authorities, compared with 15,000 such bodies in the much smaller country, England. In Massachusetts today there are only 10 local housing authorities, only five of them really active, while there should be 50. Certainly there are slums that need clearing in all of our cities. Certainly there are tens of thousands of families that need decent homes. And most certainly there is need for more jobs for our building trades and other workers.

I say, and I say it with the deepest conviction, that the future of public housing in America depends in large part on labor. I say this because housing is so integral a part of all those principles for which labor stands.

DISTINGUISHED VISITOR

The reception given by Carl Gould, Jr. and Miss Anne Gould for Professor Frederick Godley, F. A. I. A. and Mrs. Godley at the Women's University Club, Seattle, August 15, and to which members of the Washington State Chapter were invited, was a very pleasant occasion, giving an opportunity of meeting the distinguished guests who were making a brief visit to Seattle on a trip to the Pacific Coast. Professor Godley is head of the School of Architecture at Yale University and Mrs. Godley, a prominent member of the Garden Club of America, is on the committee for Gardens of Tomorrow at the New York World's Fair.

FIELD HOUSE BUILDING

The Marysville Union High School District has had plans drawn by Charles F. Dean, architect of Sacramento, for a \$25,000 one story frame field house with steel roof trusses. Bids have been taken and are under advisement.

Estimator's Guide

Giving Cost of Building Materials, Wage Scale, Etc.

Amounts given are figuring prices and are made up from average quotations furnished by material houses to San Francisco contractors. 3% Sales Tax on all materials but not labor.

All prices and wages quoted are for San Francisco and the Bay District. There may be slight fluctuation of prices in the interior and southern part of the state. Freight cartage at least, must be added in figuring country work.

Bond— $1\frac{1}{2}\%$ amount of contract.

Brick-work—

Common, \$40 to \$45 per 1000 laid, (according to class of work).

Face, \$100 to \$110 per 1000 laid, (according to class of work).

Brick Steps, using pressed brick \$1.25 lin. ft.

Brick Veneer on frame buildings, \$.75 sq. ft.

Common f.o.b. cars, \$14.00 at yard. Cartage extra.

Face, f.o.b. cars, \$45.00 to \$50.00 per 1000 carload lots.

HOLLOW TILE FIREPROOFING (f.o.b. job)

3x12x12 in.	\$ 84.00 per M
4x12x12 in.	94.50 per M
6x12x12 in.	126.00 per M
8x12x12 in.	225.00 per M

HOLLOW BUILDING TILE (f.o.b. job)

carload lots.	
8x12x5 $\frac{1}{2}$	\$ 94.50
6x12x5 $\frac{1}{2}$	73.50

Building Paper—

1 ply per 1000 ft. roll	\$3.50
2 ply per 1000 ft. roll	5.00
3 ply per 1000 ft. roll	6.25
Brownskin, 500 ft. roll	4.50
Brownskin, Protecto-mat, 1000 ft. roll	9.00
Sisalcraft, 500 ft. roll	5.00
Sash cord com. No. 7	\$1.20 per 100 ft.
Sash cord com. No. 8	1.50 per 100 ft.
Sash cord spot No. 7	1.90 per 100 ft.
Sash cord spot No. 8	2.25 per 100 ft.
Sash weights cast iron, 550.00 ton.	
Nails, \$1.50 base.	
Sash weights, \$45 per ton.	

Concrete Aggregates—

Gravel (all sizes) \$1.45 per ton at bunker; delivered to any point in S. F. County \$1.85.

	Bunker	Delivered
Top sand	\$1.45	\$1.85
Concrete mix	1.45	1.85
Crushed rock, $\frac{1}{4}$ to $\frac{3}{4}$	1.60	2.00
Crushed rock, $\frac{3}{4}$ to 1 $\frac{1}{2}$	1.60	2.00
Roofing gravel	1.60	2.00
City gravel	1.45	1.85
River sand	1.40	1.80

Delivered bank sand—\$1.00 per cubic yard at bunker or delivered.

SAND—

	Bunker	Delivered
River sand	\$1.40	\$1.80
Lepis (Nos. 2 & 4)	2.00	2.40
Olympia Nos. 1 & 2	1.80	2.20
Healdsburg plaster sand	\$1.80 and \$2.20	
Del Monte white	50c per sack	

CEMENT (all brands, cloth sacks) \$2.72 per bbl. f.o.b. car; deliv. \$2.90 per bbl., carload lots; less than carload lots, warehouse or delivered, 80c per sack. (Less 10c per sack returned, 2% 10th Prox.)

Common cement (all brands, paper sacks) carload lots \$2.52 per bbl. f.o.b. car; delivered, \$2.70; less than carloads delivered, 75c per sack. Discount on cloth sacks, 10c per sack. Cash discount on carload lots, 10c a barrel, 10th Prox.; cash discount less than carload lots, 2%.

Atlas White 1 to 100 sacks, \$1.50 sack, warehouse or delivery; over 100 Medusa White sacks, \$1.25; 2% discount 10th of month.

Forms, Labors average \$40.00 per M.

Average cost of concrete in place, exclusive of forms, 35c per cu. ft.; with forms, 60c.

4-inch concrete basement floor

Ret-proofing

Concrete Steps

Dampproofing and Waterproofing—

Two-coat work, 20c per yard.

Membrane waterproofing—4 layers of saturated felt, \$4.50 per square.

Hot coating work, \$1.80 per square.

Medusa Waterproofing, 15c per lb., San Francisco Warehouse.

Tricocel waterproofing.

(See representative.)

Electric Wiring—\$12.00 to \$15.00 per outlet

for conduit work (including switches). Knob and tube average \$3.50 per outlet.

Elevators—

Prices vary according to capacity, speed and type. Consult elevator companies. Average cost of installing an automatic elevator in four-story building, \$2800; direct automatic, about \$2700.

Excavation—

Sand, 60 cents; clay or shale \$1 per yard.

Teams, \$12.00 per day.

Trucks, \$22 to \$27.50 per day.

Above figures are an average without water. Steam shovel work in large quantities, less; hard material, such as rock, will run considerably more.

Fire Escapes—

Ten-foot galvanized iron balcony, with stairs, \$115 installed on new buildings; \$140 on old buildings.

Floors—

Composition Floors—22c to 40c per sq. ft.

In large quantities, 16c per sq. ft. laid.

Mosaic Floors—80c per sq. ft.

Dureflex Floor—23c to 30c sq. ft.

Rubber Tile—50c to 75c per sq. ft.

Terazo Floors—45c to 60c per sq. ft.

Terazo Steps—\$1.60 lin. ft.

Hardwood Flooring (delivered to building)—

	1 $\frac{1}{2}$ "x4"	1 $\frac{3}{4}$ "x2"	1 $\frac{3}{4}$ "x2"
Clr. Qtd. Oak	\$141.00 M	\$109.00 M	\$133.50 M
Sel. Qtd. Oak	118.00 M	97.00 M	106.50 M
Clr. Pia. Oak	117.00 M	101.00 M	107.50 M
Sel. Pia. Oak	97.00 M	90.00 M	99.00 M
Clr. Maple	120.00 M	94.50 M	

Wage—Floor layers, \$10.00.
Note—Above quotations are all board measure except last column which is sq. ft.

Glass (consult with manufacturers)—

Double strength window glass, 20c per square foot.

Plate 75c per square foot (unglazed) in place, \$1.00.

Art \$1.00 up per square foot.

Wire (for skylights), 40c per sq. foot.

Obscure glass, 30c square foot.

Glass bricks, \$2.40 per sq. ft., in place.

Note—If not stipulated add extra for setting.

Heating—

Average, \$1.90 per sq. ft. of radiation according to conditions.

Warm air (gravity) average \$40 per register.

Forced air average \$60 per register.

Iron—Cost of ornamental iron, cast iron, etc., depends on designs.

Lumber (prices delivered to bldg. site).

No. 1 common	\$29.00 per M
No. 2 common	27.00 per M
Select O. P. common	34.00 per M
2x4 No. 3 form lumber	24.00 per M
1x4 No. 2 flooring VG	55.00 per M
1x4 No. 3 flooring VG	47.00 per M
1x6 No. 2 flooring VG	60.00 per M
1 $\frac{1}{4}$ x4 and 6, No. 2 flooring	60.00 per M

Slash grain—

1x4 No. 2 flooring	\$43.00 per M
1x4 No. 3 flooring	40.00 per M
No. 1 common run T. & G.	30.00 per M

Lath

Shingles (add cartage to price quoted)—

Redwood, No. 1

Redwood, No. 2

Red Cedar

Plywood—Douglas Fir (ad cartage)—

"Plyscord" sheathing (unsanded) 5/16" 3-ply and 48"x96"	\$32.50 per M
"Plywood" (walboard grade)	30.00 per M
1/4" 3-ply 48"x96"	35.00 per M
"Plyform" (concrete form grade)—3/8" 5-ply 48"x96"	\$100.00 per M
Exterior Plywood Siding—7/16" 5-ply Fir	\$ 90.00 per M
Redwood	\$100.00 per M

Millwork—Standard.

O. P. \$85.00 per 1000. R. W., \$90.00 per 1000 (delivered).

Double hung box window frames, average with trim, \$6.50 and up, each.

Doors, including trim (single panel, 1 $\frac{3}{4}$ in. Oregon pine) \$8.00 and up, each.

Doors, including trim (five panel, 1 $\frac{3}{8}$ in. Oregon pine) \$6.00 each.

Screen doors, \$3.50 each.

Patent screen windows, 25c a sq. ft.

Cases for kitchen pantries seven ft. high per lineal ft., \$8.00 each.

Dining room cases, \$8.00 per lineal foot. Rough and finish about 75c per sq. ft.

Labor—Rough carpentry warehouse heavy framing (average), \$17.50 per M. For smaller work average, \$35.00 to \$45.00 per 1000.

Marble—(See Dealers)

Painting—

Two-coat work	per yard	42c
Three-coat work	per yard	60c
Cold water painting	per yard	10c
Whitewashing	per yard	4c
Turpentine, 65c per gal., in 5 gal. cans, and 55c per gal. in drums.		
Raw Linseed Oil—79c gal. in light drums.		
Boiled Linseed Oil—82c gal. in drums and 72c in 5 gal. cans.		

White Lead in oil

	Per Lb.	
1 ton lots, 100 lbs. net weight	11/4c	
500 lbs. and less than 1 ton	11/2c	
Less than 500 lb. lots	12c	

Red Lead and litharge

1 ton lots, 100 lbs. net weight	11/4c
500 lbs. and less than 1 ton	11/2c
Less than 500 lb. lots	12c

Red Lead in oil

1 ton lots, 100 lbs. net weight	11c
500 lbs. and less than 1 ton	11/4c
Less than 500 lb. lots	12/4c

Note—Accessibility and conditions cause some variance in costs.

Patent Chimneys—

6-inch	\$1.25 lineal foot
8-inch	1.75 lineal foot
10-inch	2.25 lineal foot
12-inch	3.00 lineal foot

Plastering—Interior—

	Yard
1 coat, brown mortar only, wood lath	\$0.60
2 coats, lime mortar hard finish, wood lath70
2 coats, hard wall plaster, wood lath72
3 coats, metal lath and plaster	1.25
Keene cement on metal lath	1.30
Ceilings with 3/4 hot roll channels metal lath (lathed only)	1.10
Ceilings with 3/4 hot roll channels metal lath plastered	1.85
Single partition 3/4 channel lath 1 side (lath only)85

Single partition 3/4 channel lath 2 inches thick plastered	\$2.90
4 inch double partition 3/4 channel lath 2 sides (lath only)	1.70
4-inch double partition 3/4 channel lath 2 sides plastered	3.80
Thermax single partition; 1" channels; 2 1/4" overall partition width. Plastered both sides	2.50
Thermax double partition; 1" channels; 4 1/2" overall partition width. Plastered both sides	3.10
3 coats over 1" Thermax nailed to one side wood studs or joists	1.25
3 coats over 1" Thermax suspended to one side wood studs with spring sound insulation clip	1.40

Plastering—Exterior—

2 coats cement finish, brick or concrete wall	\$1.00
3 coats cement finish, No. 18 gauge wire mesh	1.50
Wood lath, \$7.50 to \$8.00 per 100017
2.5-lb. metal lath (dipped)20
2.5-lb. metal lath (galvanized)22
3.4-lb. metal lath (dipped)20
3.4-lb. metal lath (galvanized)28
3/4-inch hot roll channels, \$72 per ton. One side finish plaster, \$18.90 ton; in paper sacks. Dealer's commission, \$1.00 off above quotations. (\$1.85 rebate 10c sack).	
Lime, f.o.b. warehouse \$2.25 bbl.; cars, \$2.15	
Wall, bulk (ton 2000 lbs.), \$16.00 ton.	
Lim Board 5 ply, \$50.00 per M.	
Hydrate Lime, \$19.50 ton.	
Plasterers' Wage Scale	\$1.67 per hour
Lathers' Wage Scale	1.50 per hour
Had Carriers Wage Scale	1.25 per hour

Composition Stucco—\$1.80 to \$2.00 sq. yard (applied).

Plumbing—

From \$70.00 per fixture up, according to grade quantity and runs.

Roofing—

"Standard" tar and gravel, \$6.50 per sq. for 30 sqs. or over.
 Less than 30 sqs. \$7.00 per sq.
 Tile, \$20.00 to \$35.00 per square.
 Redwood Shingles, \$7.50 per square in place.
 Copper, \$16.50 to \$18.00 per sq. in place
 Cedar Shingles, \$8.00 per sq. in place.
 Recoat, with Gravel, \$3.00 per sq.
 Asbestos Shingles, \$15 to \$25 per sq laid.

Slate, from \$25.00 per sq., according to color and thickness.
 Shakes—1x25", resawn

Sheet Metal—

Windows—Metal, \$1.75 a sq. foot.
 Fire doors (average), including hardware \$1.75 per sq. ft.

Skylights—(not glazed)

Copper, 90c sq. ft. (flat).
 Galvanized iron, 30c sq. ft. (flat).
 Vented hip skylights 60c sq. ft.

Steel—Structural

\$120 ton (erected), this quotation is an average for comparatively small quantities. Light truss work higher. Plain beams and column work in large quantities \$90 to \$100 per ton.

Steel Reinforcing—

\$80.00 to \$120.00 per ton, set.

Stone—

Granite, average, \$6.50 cu. foot in place
 Sandstone, average Blue, \$4.00, Boise \$3.00 sq. ft. in place.
 Indiana Limestone, \$2.80 per sq. ft. in place.

Store Fronts—

Copper sash bars for store fronts, corner center and around sides, will average 75c per lineal foot.
 Note—Consult with agents.

Tile—Floor, Wainscot, etc.—(See Dealers)

Asphalt Tile—18c to 28c per sq. ft. installed.

Wall Tile—

Glazed Terra Cotta Wall Units (single faced) laid in place—approximate prices:
 2 x 6 x 12

Venetian Blinds—

40c per square foot and up. Installation extra.

THE BUILDERS' EXCHANGE OF SAN FRANCISCO STANDARD WAGE SCALE

For mechanics employed on construction work in the Bay Region. Effective September 1, 1937

CRAFT	Journeyman Mechanics
Asbestos Workers (6h-5d)	8.00
Bricklayers (6h-5d)	10.50
Bricklayers' Hodcarriers (6h-5d)	6.75
Cabinet Workers (Outside) (5d)	8.00
Calison Workers (Open)	6.40
Carpenters (8h-5d)	10.00
Cement Finishers (8h-5d)	10.00
Cork Insulation Workers (8h-5d)	9.00
Electric Workers (8h-5d)	11.00
Hardwood Floormen	10.40
Elevator Constructors	8.00
Engineers, Portable & Hoisting	9.00
Glass Workers (8h-5d)	9.68
Hardwood Floormen	9.00
Housemiths, Architectural Iron (Shop) (8h-5d)	9.00
Housemiths, Architectural Iron (Outside) (8h-5d)	10.00
Housemiths, Reinforced Concrete or Rodmen (8h-5d)	10.00
Iron Workers (Bridge and Structural) Including Engineers (8h-5d)	12.00

CRAFT	Journeyman Mechanics
Laborers, Building (8h-5d)	6.00
Laborers, Common (8h-5d)	6.00
Lathers, Channel Iron (6h-5d)	9.00
Lathers, All Others	9.00
Marble Setters (8h-5d)	10.50
Marble Setters' Helpers (8h-5d)	6.50
Millwrights	9.00
Model Makers (\$1.50 per hr-6h)	9.00
Modelers (\$2 per hr-6h)	12.00
Model Casters	7.20
Mosaic and Terrazzo Workers (Outside)	9.00
Painters (7h-5d)	8.75
Painters, Varnishers and Polishers (Outside)	9.00
Pile Drivers and Wharf Builders	9.00
File Drivers' Engineers	10.00
Plasterers (6h-5d)	10.00
Plasterers' Hodcarriers (6h-5d)	7.50
Plumbers (8h-5d)	11.00
Roofers, Composition (8h-5d)	9.00
Roofers, All Others (8h-5d)	8.00
Sheet Metal Workers (8h-5d)	10.00
Sprinkler Fitters	10.00

CRAFT	Journeyman Mechanics
Steam Fitters (8h-5d)	\$11.00
Stair Builders (8h-5d)	9.00
Stone Cutters, Soft and Granite (8h-5d)	8.00
Stone Setters, Soft and Granite	12.00
Stone Derrickmen	9.00
Tile Setters (8h-5d)	11.00
Tile Setters' Helpers (8h-5d)	6.50
Tile, Cork and Rubber (8h-5d)	9.00
Welders, Structural Steel Frame on Buildings 11.00	
Welders, All Others on Buildings	9.00
Dump Truck Drivers, 2 yards or less	6.00
Dump Truck Drivers, 3 yards	6.50
Dump Truck Drivers, 4 yards	7.00
Dump Truck Drivers, 5 yards	7.00
Dump Truck Drivers, 6 yards	7.50
Truck Drivers of Concrete Mixer Trucks: 2 yards or less	6.50
3 yards	7.00
4 yards	7.50
5 yards	7.50
6 yards	8.00

GENERAL WORKING CONDITIONS

- Eight hours shall constitute a day's work for all crafts except as otherwise noted.
- Plasterers' Hodcarriers, Bricklayers' Hodcarriers, Roofers' Laborers, and Engineers, Portable and Hoisting, shall start 15 minutes before other workmen, both at morning and at noon.
- Five days, consisting of not more than eight hours a day, on Monday to Friday inclusive, shall constitute a week's work.
- Transportation costs in excess of twenty-five cents each way shall be paid by the contractor.
- Overtime shall be paid as follows: For the first four hours after the first eight hours, time and one-half. All time thereafter shall be paid

- double time, Saturdays (except Laborers), Sundays and holidays, from 12 midnight of the preceding day, shall be paid double time.
- On Saturday, Laborers shall be paid straight time for an eight-hour day.
- Where two shifts are worked in any twenty-four hours, shift time shall be straight time. Where three shifts are worked, eight hour's pay shall be paid for seven hours on the second and third shifts, allowing one-half hour for lunch.
- All work, except as noted in paragraph 9, shall be performed between the hours of 8 a.m. and 5 p.m.
- In emergencies, or where premises cannot be vacated until the close of business, men then

- reporting for work shall work at straight time. Any work performed on such jobs after midnight shall be paid time and one-half up to four hours of overtime and double time thereafter, provided, that if a new crew is employed on Saturdays, Sundays or holidays which has not worked during the five preceding days, such crew shall be paid time and one-half.
- Recognized holidays to be: New Year's Day, Decoration Day, Fourth of July, Labor Day, Admission Day, Thanksgiving Day, Christmas Day.
- Men ordered to report for work, for whom no employment is provided, shall be entitled to two hours pay.

MODERNIZED PRODUCTS

Brief Notes on New Materials and Equipment in the Building Industry.

268. GLASS BLOCK

Owens-Illinois Glass Company, through the medium of a little folder, illustrate the features of their new Glass Block which, according to the literature, admits light and retards heat. Decorative possibilities of this material are claimed for its use in residence construction. Send for a copy.

269. VENTILATOR

A new-type ventilator is being offered by the Winco Ventilator Company. It offers a solution to the problem of getting an adequate supply of air where glass block is used in construction. Made of stainless steel it is also screened so as to be rust-proof and insect-proof. A copy may be had by sending in the coupon.

270. CARRIERS

The J. A. Zurn Manufacturing Company have issued a catalogue to cover their line of carriers for all types of wall fixtures. The catalogue gives a detailed list and has in addition blue-prints to further illustrate.

271. "CELLOWARE"

Bathroom fixtures in "Celloware" are described and illustrated in a brochure put out by The B & T Floor Company. This product appears to be one of the plastic group although its composition is not specifically named in the company's brochure. From the illustrations this new material is colorful and more or less striking.

272. KITCHENS

A "Kitchen Planning" Manual by Westinghouse contains some very interesting features and details. Diagrams and plans are included and the chief fundamentals of good kitchen planning are incorporated. Send for your copy by using the coupon below.

273. FOR FLOORS

Flexrock Company have a new booklet illustrating their "Acid Resistant Floor Resurfacer." It is characterized in this booklet as being harder than concrete and tighter than rubber. The name "Rockflux" has been given this product.

274. FOR MODERNIZING

A method of modernizing old wood sided buildings is described in a pamphlet from the Rok-Hesive Corporation. Specifications are included for the compound which is put up in dry powder form to be mixed with cold water. Send for a copy of this pamphlet—the coupon insures prompt attention.

275. BETTER KITCHENS

The Pacific Coast Electrical Bureau has issued a booklet on the modern kitchen. "What's being done to America's kitchens." Here the newest appliances are illustrated and diagramed. The most up-to-date cabinets and cupboards are shown and the latest in electrical equipment.

276. CONCRETE HIGHWAYS

The magazine-booklet "Concrete Highways and Public Improvements" issued by the Portland Cement Association, July-August number, has some excellent material illustrating what is being done in highway and other public work.

277. STEEL PRODUCTS

The August issue of "Steel Facts" published by the American Iron and Steel Institute, contains as it always does, interesting material relative to the iron and steel industry and gives information on the latest advances and improvements in iron and steel products.

278. STAINLESS STEEL

"Electromet Review" the booklet brought out by the Electro Metallurgical Company has some facts regarding the use of stainless steel in food products preparation. Of great importance is the rust resisting qualities of this steel and this makes it invaluable in the food products industry. Send for a copy. Use the coupon.

279. BATH FIXTURES

Another of Crane Company's very fine booklets on bathroom fixtures and planning has just been received. Exceptionally well illustrated this booklet has some real new ideas for modernizing bathrooms.

280. HOME HEATING

Home heating systems are discussed in a brochure issued by the same company. Here Crane goes into the important features of proper heating units for homes of various size and gives much detail as to appliances and controls. The coupon will bring your copy.

281. SHOWER DOORS

Shand and Jurs Company have an attractive booklet which gives in a rather unique manner illustrations of their shower doors and tub enclosures. Metal, tile and glass are combined to give some very striking effects in the pictures seen in this booklet. The coupon will bring you a copy.

FREE FOR THE ASKING

Check items on coupon, paste on letter head or postal card, and mail to Architect and Engineer.

Architect and Engineer
68 Post Street
San Francisco, Calif.

Please send me literature on the following items as checked below. This request places me under no obligation.

268 <input type="checkbox"/>	275 <input type="checkbox"/>
269 <input type="checkbox"/>	276 <input type="checkbox"/>
270 <input type="checkbox"/>	277 <input type="checkbox"/>
271 <input type="checkbox"/>	278 <input type="checkbox"/>
272 <input type="checkbox"/>	279 <input type="checkbox"/>
273 <input type="checkbox"/>	280 <input type="checkbox"/>
274 <input type="checkbox"/>	281 <input type="checkbox"/>

My Name.....

Name of Company.....

Street.....

City..... State.....



TWO VIEWS OF BOILER ROOM, ASSEMBLY PLANT OF FORD MOTOR COMPANY, SEATTLE, WASHINGTON, SHOWING KRAFTILE ENAMEL BRICK INSTALLATION

Albert Kahn, Inc., Architects; Clinton Construction Company, General Contractors; Harry Johnson, Masonry Contractor

FOR IMPROVED BUILDING CONDITIONS

At the forty-eighth meeting of the Central Coast Council of the California State Chamber of Commerce, held at the Empire Hotel, San Francisco, August 24, Harry M. Michelsen, architect and chairman of the Construction Congress Group, advocated five ways in which the State Chamber may be helpful in improving conditions in the construction industry, as follows:

1. Continue its policy for economical taxation.
2. Encourage new building enterprises, inasmuch as reliable sources state that costs are now lower than they were in 1929.
3. Encourage the banks to allow their surplus deposits to flow into investments for building construction.
4. Renew its efforts in encouraging new businesses and enterprises in the State of California.
5. Establish a closer relationship with organized labor, with the result that greater efficiency in the construction of buildings will be promoted.

Mr. Michelsen's recommendations were unanimously approved.

Mr. L. H. Nishkian reported that the California Building Code had been printed and that copies are now available to all interested groups throughout the State. The Code contains minimum requirements and standard practices for economic construction of buildings to safeguard against earthquake dangers. Representatives of State and national associations have highly commended the Chamber in the development of the Code.



*A service for you
...and your clients*

As the national leader in FHA financing, Bank of America's interest in better housing coincides with that of the architect and the engineer. Finer design and better construction mean a sounder investment for the home owner, a more satisfactory loan for the bank. Your interests, as well as those of your clients, will receive the friendliest consideration at Bank of America.

Bank of America
NATIONAL TRUST & SAVINGS ASSOCIATION
Member Federal Deposit Insurance Corporation

REGIONAL COMPETITION FOR BURLINGAME POST OFFICE

ANNOUNCEMENT is made of the fourth project of a series of Regional Architectural Competitions for Federal Buildings, by W. E. Reynolds, Commissioner, Public Buildings Administration (formerly Public Buildings Branch, Procurement Division, Treasury Department).

Architects of the three states of Region No. 11 are invited to enter a competition for the design of a Post Office Building for the City of Burlingame, California, with an estimated cost of \$150,000.

This competition is open to all registered architects who are citizens of the United States of America and whose home offices are located within the confines of Region No. 11 which consists of the following states: California, Nevada and Arizona.

Architects whose home offices are within the region above mentioned and in states having no registration law, and who are not registered in other states, are eligible to enter this competition upon the submission of qualifications satisfactory to the Commissioner of the Public Buildings Administration. The material for such submission consists of one or more photographs and a sufficient number of prints of working drawings to indicate the character of a building designed and executed by the applicant and considered by the Professional Advisor as being comparable to the building which forms the subject of this competition.

No employee of the Federal Government or of the Government of the District of Columbia is eligible to enter this competition. The term "employee" includes not only those employed on a salary basis but also any architect who, during the time that this competition is in progress, has a contract for professional services with the Federal Works Agency.

If a design is submitted by a firm, the copy of the current registration certificate, or other evidence of qualification mentioned above, must be furnished by at least one member of the firm.

The author of the winning design for the Burlingame project will receive \$1,500 for this distinction and will be paid an additional \$1,500 in his capacity as consultant during the preparation of working drawings and specifications which will be prepared in the Public Buildings Administration of the Federal Works Agency.

In order that all eligible architects of the Eleventh Region may be free to compete, it has been arranged to draw a jury of award from neighboring districts.

Drawings called for are to be in pencil, free from rendering, thus keeping to a reasonable minimum the labor involved in the competition drawings.

Copies of the program are now available and may be had on request by letter or wire. The letters or telegrams should be addressed as follows: "Commissioner of Public Buildings, Public Buildings Administration, Federal Works Agency, Washington, D. C." Applications by letter should have the envelope conspicuously

marked with the words "Architectural Competition." And included with the letter of application from the registered architect there should be a photographic copy of the applicant's current certificate of registration or a statement from a qualified state officer attesting to the applicant's registration status; in the case of unregistered architects, they should submit with the letter of application evidence of qualifications mentioned above. Applications by telegram should state that copy of current certificate, or evidence of qualifications, has been mailed. Action on the application will be subject to the receipt of such certificate or other acceptable evidence as described.

Attention is invited to the fact that a registration certificate which is not dated the current year or is not otherwise validated as being for the current period cannot be accepted as evidence of registration.

In the second regional competition for a Post Office and Court House at Evansville, Indiana, Harry F. Manning of Chicago, was recommended by the jury as the winner.

ENGINEERS' SHASTA DAM EXCURSION

Members of the San Francisco Section, American Society of Civil Engineers, have been invited to inspect construction work in the Shasta Dam area. Started just a year ago, the works include railroad bridges in several stages of completion, tunnels, culverts and grading upon which is employed very large earth-moving equipment; highway relocation requiring grade separation and bridges; and the excavated dam site. Enroute a real "ghost town" having all the lure of early California will be visited.

Those making the trip will leave San Francisco via Southern Pacific Ferry for train No. 20, at 9:00 p.m., Friday, September 29, arriving in Redding at 4:27 a.m. Saturday. Pullmans will be set out.

Breakfast will be at Hotel Redding at 7:00 a. m. Saturday.

Transportation to the site will be provided by the Reclamation Service and several contractors. Lunch will be served at the dam site and early dinner at Delta, the upper end of the construction work.

CONGRESS OF ARCHITECTS POSTPONED

The Fifteenth International Congress of Architects, which was to have been held in Washington, D.C., September 24 to 30, has been indefinitely postponed because of the war in Europe, it is announced by Richmond H. Shreve of New York, executive officer of the Congress. The postponement was decided upon at a meeting of the Congress Committee on Organization, of which Charles D. Maginnis of Boston is chairman.

"While plans for the Congress had been completed, an adequate representation of the nations of the world was impossible, owing to the course of events in

Europe," Mr. Shreve said. Perhaps one-third of the several hundred delegates expected are already on their way. They will attend the seventy-first convention of the American Institute of Architects, scheduled to be held in Washington during the same week.

"The foreign group attending the Institute's sessions will be comprised chiefly of representatives of Canada and South American countries. Sir Raymond Unwin of England and Jacques Greber of France are already in America. The State Department has cabled notice of postponement to all countries which have named delegates. Numerous events planned in connection with the Congress, including an official banquet in Washington on Wednesday, September 27, and trips to historic places will be carried out under the auspices of the Institute."

The Congress was to have convened for the first time in the New World at the invitation of the Congress of the United States and President Roosevelt. Invitations to participate had been issued by the Department of State to fifty foreign governments and to more than 100 foreign architectural societies. Mr. Maginnis, who is president of the American Institute of Architects, had been chosen president of the Congress, and Clarence C. Zantzing of Philadelphia, secretary-general.

Mr. Maginnis had also been designated as chairman of a delegation to represent the United States officially. The other members are: Louis A. Simon, Washington, D.C.; Edwin Bergstrom, Los Angeles; Harvey Wiley Corbett, New York; Mr. Shreve; George Oakley Toten, Jr., Washington, D.C.; Stephen F. Voorhees, New York; Mr. Zantzing.

FOUR MILLION DIFFERENCE IN FRIANT DAM BIDS

Five bids for the construction of Friant Dam, varying from a low of \$8,715,358.50 to a high of \$12,483,173.50, are under consideration by the United States Bureau of Reclamation and a contract probably will be awarded before the end of this month.

Walker R. Young, supervising engineer of the Central Valley Project, said work can be started on the big dam on the upper San Joaquin River by early November, provided the bids are found to be regular and satisfactory to the Government.

The proposals are as follows:

Griffith Co. and Bent Co., 418 South Pecan Street, Los Angeles	\$ 8,715,358.50
Shasta Construction Co., San Francisco	9,105,760.00
West Coast Constructors, Inc., Los Angeles	9,197,169.50
Winston Bros. Co., The Arundel Corp., D. W. Thurston, American Concrete & Steel Pipe Corp., and L. E. Dixon Co., Los Angeles	12,368,660.00
Friant Construction Co., San Francisco	12,483,173.50

The Friant specifications provide that the successful bidder must start work within 30 days after receipt from

the Bureau of Reclamation of an official notice to proceed with construction. The contractor will be allowed 1,200 calendar days, or about three years and three months, to complete the job which is located 20 miles north of Fresno and about 21 miles east of Madera.

The bids are for performing all work, including furnishing labor and equipment, for the construction of Friant Dam, which will be 300 feet high and 3,430 feet long. The bids do not include the furnishing of materials which are to become part of the completed structure. The Government will purchase separately through competitive bidding such items as cement, structural and reinforcing steel, pipe, metalwork, and machinery.

The Friant contract will involve the excavation of about 770,000 cubic yards of earth and rock to prepare the dam site foundation; stripping 600,000 cubic yards of overburden from a sand and gravel deposit downstream from the dam site; handling 3,222,000 tons of sand and gravel; manufacture and placement of 1,850,000 cubic yards of concrete in the dam and 57,000 cubic yards of concrete in appurtenant structures; installation of 3,300,000 pounds of reinforcement bars, about 3,800,000 pounds of gates and valves, 3,400,000 pounds of tubing and fittings, and 3,000,000 pounds of pipe, machinery and miscellaneous metalwork.

All labor will be hired directly by the contractor.

NEVADA ARCHITECTS ORGANIZE

The architects of the State of Nevada have finally organized themselves into an association. At a meeting in Reno, July 26, the Nevada State Association of Architects, with eighteen charter members, was formed.

The main objectives of the Association will be: "To cultivate a thorough knowledge of the scientific and practical efficiency of the profession, to facilitate the interchange of ideas, encourage discussion of problems and to emphasize obligations to the society."

Officers elected are: C. W. McMillan, president; Russell Mills, vice-president; Edward S. Parsons, secretary; William W. Leaves, treasurer. The temporary Board of Directors includes the officers and George Probasco, Lawrence Guling, Howard H. Brandis, George Ferris, all of Reno, and Herbert H. Swinburne, Carson City.

"REMODELED MAIN STREET"

Results of an architectural competition that netted the eight winners a total of \$2500 was exhibited during the month at the San Francisco Architectural Club Galleries in International Hall on Treasure Island.

Subject of the exhibit was the remodeling of an obsolete block on "Main Street," not the whole of it, but merely two facade units, one-story and two-story, and the inside of a second floor beauty parlor.

On the jury were leading Pacific Coast architects, including Donald B. Parkinson, Timothy Pflueger, George Stoddard, William Wurster, Walter Church, Stiles Clements, Gardner Dailey, Gordon Kaufmann.

No Worry for the Architect

"—All acid proof drain pipe and fittings shall be ferro-silicon—CORROSTON—"

[Write for this specification]



FEDERAL BUILDING • CIVIC CENTER • SAN FRANCISCO

Arthur Brown, Jr., Architect

CORROSTON DRAIN LINES and FITTINGS and LABORATORY EQUIPMENT was specified because of its superior resistance to corrosion and wear.

Pacific Foundry Company, Ltd.

NEW YORK • 3100 NINETEENTH ST., SAN FRANCISCO • LOS ANGELES

FOR CLIENTS WHO WANT OIL HEAT

AT ITS BEST

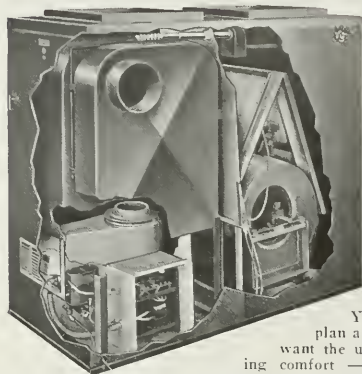

Your clients who plan a large home and want the ultimate in heating comfort — without price penalty — will be interested in the H. C. Little Automatic Oil-Burning Furnace pictured above. Some advantages are quiet, rapid, uniform heat circulation — four large spun glass filters giving clean, humidified air — Automatic, Thermostatic Control with Electric Ignition — economical operation with low-cost Diesel oil — 120,000 BTU per hour OUTPUT — patented "Proved-in-Use," construction. Write Dept. A-2 for complete details.

H·C·LITTLE BURNER CO.

Dept. A-2, San Rafael, Calif.

Dealers Everywhere

A good investment—

is a well designed, well built, structure, properly located.

Lindgren & Swinerton, Inc.

have been building substantial buildings for over a half of a century, are still building them and will continue building them for another half of a century.

Lindgren & Swinerton, Inc.

Standard Oil Building
San Francisco

605 W. Olympic Boulevard
Los Angeles

619 H Street
Sacramento

1723 Webster Street
Oakland

AQULUX 85

NEW Oil Burning Water Heating Unit

This powerful and compact vertical unit, beautiful in appearance, is designed to supply hot water at minimum cost in the modern home. It can also be used to supply heat and hot water automatically for small homes without the necessity for basement installation. Complete data on this new "package unit" now ready.

Burns No. 3 C. S. G. fuel or Diesel oil

S. T. JOHNSON CO.

940 ARLINGTON, OAKLAND, CALIF.
401 N. BROAD ST., PHILADELPHIA, PA.

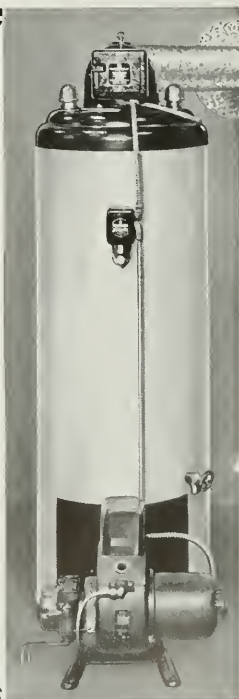

U.S.
O
PRODUCTS

VAN ARSDALE-HARRIS Co.
ENGINEERS & CONTRACTORS

ACOUSTICAL TREATMENT - INSULATION
SOUND CONTROL

FIFTH & BRANNAN STS. SAN FRANCISCO, CALIF.
TELEPHONE GARfield 3600
DIVISION

VAN ARSDALE-HARRIS LUMBER CO., INC.

POMONA TILES

FOR

**Bathrooms and Kitchens
in over 60 colors**

Warehouses and Display Rooms

135 Tenth St. San Francisco
629-33 North La Brea Ave. Los Angeles
6106 Roosevelt Way Seattle

POMONA TILE MFG. CO.
PLANT — POMONA, CALIF.

STRUCTURAL STEEL

For Class A Buildings,
Bridges, etc.

JUDSON PACIFIC CO.

1200 SEVENTEENTH STREET
SAN FRANCISCO

Plants: San Francisco - Oakland

**A Permanent Exposition
of the newest ideas
in home planning
and equipment.**



THE BUILDING MATERIAL EXHIBIT

Architects Bldg. • Fifth & Figueroa • Los Angeles • MU-6306

BATHROOM ACCIDENT RATIO LOW

Fewer fatal and non-fatal accidents occur in bathrooms than almost any other rooms in the house, the National Safety Council reports in the 1939 edition of "Accident Facts," a statistical yearbook.

The Council analyzed 4600 home accidents occurring in Chicago. The study disclosed the following rating of the various rooms in the house with respect to the number of accidents:

Stairs and steps	23 per cent
Yard	19 per cent
Kitchen	18 per cent
Living room	9 per cent
Porch	7 per cent
Bedroom	7 per cent
Basement	6 per cent

Other rooms, including dining room, bathroom, pantry, vestibule, and hallways 11 per cent

The findings of the National Safety Council check with a study of accidents made by the Metropolitan Life Insurance Company which indicated that the bathroom accounts for less than one-half of 1 per cent of household accidents.

As a means of still further reducing the number of accidents in bathrooms, the Plumbing and Heating Industries Bureau suggests the replacement of high tubs on legs with the modern low streamlined baths only 16 inches from floor to rim; the replacement of china faucet handles with metal handles; and the installation of grab-bars over the tub, particularly if there is a shower.

NEW BOOKS

ETCHINGS—NEW YORK WORLD'S FAIR: Gordon W. Gilkey, M.F.A., Charles Scribners Sons Co., Fifth Avenue, New York, N.Y.; Kennedy and Company, Official Print Publishers, 785 Fifth Avenue, New York. \$5.00.

This constitutes, according to the official publishers, the only fine art record of the New York World's Fair. The harmony, design and beauty of this Exposition is brought out most vividly through the medium of the etcher's art in this volume.

It will remain as a living thing long after its buildings are gone, and its gardens erased. This pageantry built up as the Fair progressed in construction is here shown in a manner calculated to give the whole perspective of a gigantic undertaking in which beauty and utility have been happily combined.

STEEL SQUARE: by Townsend; American Technical Society, Chicago, Ill. \$1.50.

Another of the excellent series of technical hand books published by this society. Aptly gives the definite information always needed by the users of instruments of precision. Concise and clear in its application to the details surrounding the correct use of the steel square, this book should prove of great value to the architect as well as to the members of the building trades.

ARCHITECTS' DAY OCTOBER 11

Plans are well under way for the observance of "Architects' Day" at the Golden Gate International Exposition, October 11th. On this occasion the Northern California Chapter, A.I.A., and the State Association of California Architects, Northern Section, will jointly act as host.

Appropriate to the fact that the Exposition is dedicated to the eleven Western States, all Chapters of the Institute in this area have been invited to participate. Each, in turn, has been asked to stimulate and promote the interest of architects in its locality.

The day is expected to arouse more than local interest as it definitely has been made a part of the program for the entertainment of delegates, following the 15th International Congress of Architects and the parallel Convention of the Institute in Washington, D. C. A country-wide tour, which will include the two Expositions, will doubtless bring many of the delegates to San Francisco on "Architects' Day."

A large and active committee under the direction of Wm. H. Knowles is busily engaged in perfecting details of the program and events for the day. These, broadly, include sightseeing to points of interest within the city, and guidance of visitors about the Exposition so that each may find the utmost to enjoy during the day without loss of time from waste motions; the ceremony at the Exposition, distinguished by the presence of notable public and professional persons, and the closing feature—a cocktail and refreshment hour.

NORTHERN CALIFORNIA CHAPTER

The monthly meeting of the Northern California Chapter, A.I.A. was held at the Alexander Hamilton Hotel Tuesday, August 29, at 6:30 p. m., President James H. Mitchell presiding.

Members present: Messrs. Harris C. Allen, Wm. Clement Ambrose, C. A. Caulkins, Jr., Mario J. Ciampi, Edward R. French, Jr., Edward L. Frick, Irwin Johnson, Charles F. Maury, Chester H. Miller, James H. Mitchell, Irving F. Morrow, Roland I. Stringham, Ernest E. Weihe, Alfred C. Williams, John Davis Young.

Guest present: Mr. Vincent Raney.

Mr. Caulkins was welcomed to membership by Mr. Mitchell.

Announcement was made of the recent passing of Warren Skillings of San Jose, and Chester Cole of Chico and the Secretary was authorized to send notes of condolence.

Motion by Mr. Weihe, seconded by Mr. Allen, that Messrs. G. Frederic Ashley, Arthur Brown, Jr., Frederick H. Meyer and W. R. Yelland be elected as Alternate Delegates to the A.I.A. convention was passed.

Messrs. Weihe and Allen discussed the Unification Plan. It was suggested that our delegates contact the Southern California delegates before the convention, and that every possible effort be made to present a united California front when Unification is brought up at the convention.

—J. D. Y.

Dependable Building Materials

- Lumber
- Plywood
- Insulation
- Shingles
- Concrete form panels
- Building paper
- Shingle stains
- Wall board
- Termite control

"Goods of the Woods"



E. K. WOOD LUMBER CO.
LOS ANGELES • SAN FRANCISCO • OAKLAND

USE BASALITE

Light-weight, pre-fabricated Concrete building products for floors, walls, and roofs in your next building.

BASALT ROCK COMPANY, INC.
Napa, California

NOISE CONTROL— ON TREASURE ISLAND

STATE AUDITORIUM AND RADIO STUDIOS
BELL TELEPHONE SYSTEM EXHIBIT
SAN FRANCISCO RECREATION EXHIBIT
FEDERAL BUILDING THEATER

Furnished by—

WESTERN ASBESTOS CO.

Building Materials Mechanical Specialist
SACRAMENTO OAKLAND
SAN FRANCISCO

LET YOUR CLIENT BE THE JUDGE



Suggest adequate wiring in your plans. If your client cuts those specifications, you are cleared of any charge anyone may later make of poor electrical service in that building. Let him take the responsibility.

Every day a building is in use the occupants require twenty-four hour electrical service.

Because of the constant demand for electrical service for such a variety of uses, the wiring plan is of first importance in every building you are responsible for.

For commercial and industrial buildings, each wiring job requires specialized planning for you and the engineers working with you. For homes, our Red Seal Plan will provide a basic outline for your convenience.

Call at 447 Sutter Street, San Francisco, or telephone DOuglas 1556 for your copy of RED SEAL specifications.

•
*See the electrical exhibits at the Palace of
Electricity and Communications at the
Golden Gate International Exposition*

•
**PACIFIC COAST
ELECTRICAL BUREAU**

447 SUTTER STREET • SAN FRANCISCO, CALIFORNIA

NEW GLADDING, McBEAN PRODUCT

Gladding, McBean & Co. have taken over the manufacture, sale and distribution of vermiculite, a natural earth mica mined in Libby, Montana. This holding is of vast size and of the finest known mica in the world. Vermiculite is an exceedingly light weight, flaked siliceous mica of enduring quality, fireproof, no disintegration, no volume change, is everlasting, and has high thermal insulating value. In use it is expanded by heat (at 1800° F.) between 14 and 16 times its original dimension, then segregated to its varying sizes for different uses. Expanded, it weighs 6 1/2 lbs. per cubic foot.

Its major use is for insulation of all kinds: heat control, cold storage, refrigeration, roofs, decks, fireproofing, light weight and nailing concrete, heating and ventilating ducts, boiler and pre-formed pipe covering, acoustic and insulating plasters, etc.

"Unicon" is the trade name for vermiculite used with Portland cement to make a light weight insulation concrete for varying uses. Mixtures are proportioned to the special use for which the material is applied. Unicon coverage for all mixes is one cubic yard for approximately 260 square feet, 1 inch thick in place. It can be applied in either damp or pouring mixtures.

JUNIOR SAFETY ENGINEER WANTED

Civil service employment opportunities as a junior safety engineer and inspector are soon to be available, according to information just released by Louis J. Kroeger, of the California State Personnel Board. The examination to be held October 10, is open to men only and the minimum entrance requirements are graduation from college in engineering and one year's experience in mechanical, mining or construction engineering or 6 months' experience in safety engineering.

The position pays a starting salary of \$170 per month and all applications must be on file by September 30. Information and application blanks may be obtained by writing the State Personnel Board, 1025 P Street, Sacramento.

The work as a Junior Safety Engineer and Inspector consists in part in inspecting the operations, working places, machinery, and equipment of industrial plants for unsafe practices and disease producing conditions.

CLARENCE R. WARD

Clarence R. Ward, pioneer architect of San Francisco, and prominent in civic affairs some years ago, died September 10 following a brief illness. He was at one time member of the firm of Meyers and Ward and later was associated with Harry Bluhme.

Many of San Francisco's large buildings were designed by Mr. Ward, who also created the largest building of the 1915 Exposition, the Machinery Palace. He was a board member of the Exposition and later president of the State Board of Architects.

Mr. Ward was a founder and the architect of the Family Club, and one of the club's first presidents.

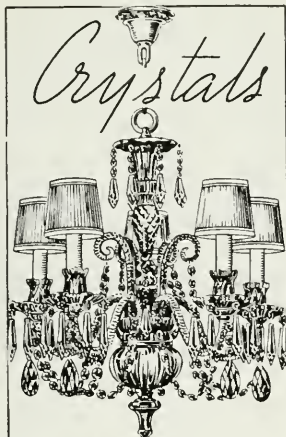

Nothing can be lovelier as a source of light than a Lightolier crystal fixture. Truly—luxury in lighting.

INCANDESCENT SUPPLY COMPANY
726 MISSION ST., SAN FRANCISCO



SUMMERBELL Trusses which are normally used to span wide buildings, are here shown spanning a bridge construction at Long Beach, California. The trusses were designed and erected by Summerbell. The piling and floor system was installed under general contract. This bridge—now complete and in use—is safe, strong, and entirely satisfactory. This job illustrates Summerbell's adaptability to an unusual problem.



SUMMERBELL ROOF STRUCTURES
LOS ANGELES • OAKLAND • PHOENIX
TIMBER STRUCTURES, INC., PORTLAND

ROOFS OF WOOD—BUILT TO ENDURE

THE HERMANN SAFE CO.

MANUFACTURERS AND DEALERS OF FIRE AND BURGLAR PROOF SAFES AND VAULTS, SAFE-DEPOSIT BOXES, ETC.

200 HOWARD STREET
SAN FRANCISCO
GARfield 3041 - 3042

CARBON MONOXIDE ON OUR HIGHWAYS
By J. P. Russell, M.D.

In a survey conducted in 1938 by the Industrial Hygiene Service, State Department of Public Health, in conjunction with the California Highway Patrol, State Department of Motor Vehicles, 1105 commercial motor vehicles of various types were tested during five-minute runs on the highway, under varying weather and road conditions, to determine the amount of carbon monoxide in the air breathed by the driver. Two per cent of these vehicles were found to be in a potentially dangerous condition, due to concentration in the driver's compartment of over 0.01 per cent of carbon monoxide, which may cause headache, sleepiness, weakness, faulty judgment, and impaired driving ability, if inhaled continuously over a period of six hours or longer.

In order to obtain a comparable series of tests on noncommercial motor vehicles, and to study more fully

Pacific Manufacturing Company

High Class Interior Finish
Quality Millwork

112 Sansome St. 6820 McKinley Ave.
San Francisco Los Angeles
GARfield 7755 THornwall 4196

1315 Seventh Street, Oakland
GLencourt 7850

FINE WATER COLORS AND PAPERS FOR ARCHITECTURAL RENDERINGS

H. S. CROCKER COMPANY, Inc.

720 MISSION STREET
MARKET STREET AT SECOND
SAN FRANCISCO

GABOT'S "COLLOPAKES"

Especially Blues, Greens and Reds Surpass all Other Paints in Weather Resistance.



Gunn, Carle & Co.

SAN FRANCISCO
20 Potrero Ave. UNDERhill 5480



Golden Gate Atlas
TRANSIT
MIX CONCRETE
AND MORTAR

•
makes delivery of material to the job swift and inexpensive . . . minimizing the architect's supervision costs and assuring his client a dependable mix.

•
PACIFIC COAST
AGGREGATES, Inc.

16th and Harrison Streets
85 Second Street
San Francisco

Phone GARfield 1164

Hunter & Hudson

Consulting Engineers

DESIGNERS OF HEATING
AIR CONDITIONING
VENTILATING AND WIRING
SYSTEMS, MECHANICAL
AND ELECTRICAL EQUIP-
MENT OF BUILDINGS

41 SUTTER STREET
ROOM 710

San Francisco California

Robert W. Hunt Company

ENGINEERS

Inspection • Tests • Consultation

Schools and Other Structures
Are Built as Designed

*When Construction Materials are
Inspected at point of Manufacture
and during Erection by*

ROBERT W. HUNT COMPANY

*Cement, Concrete, Chemical, Metallurgical,
X-Ray and Physical Laboratories*

Chicago - New York - Pittsburgh
Los Angeles - All Large Cities
San Francisco, 251 Kearny Street

the relationship of certain relevant factors, such as length of exhaust pipe, and driving with windows open and closed, to the amount of gas entering the car, a similar survey has been made of 1005 passenger automobiles.

The four-mile section of U. S. Highway No. 70, between Blythe, California, and the plant quarantine station at the state line, was selected as the location for the survey. The majority of automobiles entering Blythe from either direction have been run continuously for several hours. It is under such conditions of prolonged exposure, that the driver and passengers are most likely to experience the toxic effects of relatively low concentrations of carbon monoxide in the car. Several instances have been reported in which the occupants of an automobile reaching Blythe, after a continuous three or four-hour run, have gotten out of the car, walked a short distance, and collapsed, due to partial carbon monoxide asphyxia.

Automobiles to be tested were taken at random. The tester entered the car with the carbon monoxide indicator, and rode to the other end of a four-mile test run, making a continuous reading of the carbon monoxide concentration at the driver's breathing level, while the car was driven at a normal speed. Comparative readings were taken with windows open and closed. Cordial cooperation was obtained from drivers and passengers of all cars included in the survey.

When the concentration of carbon monoxide in the car was found to be 0.01 per cent or higher, the source of the trouble was located by checking along the exhaust system with the car at a standstill and the engine idling. Large defects, such as broken mufflers and missing tail pipes, were obvious on visual inspection. Small leaks in the exhaust line, unnoticeable on casual inspection, were immediately apparent when the flexible hose attached to the carbon monoxide indicator was held at these points. Defects were pointed out to the driver, with recommendations for repairs.

Of the 1005 automobiles in which determinations of carbon monoxide concentration were made, thirty cars,

INCLUDE TREES
IN YOUR PLANS

DAVEY, ORIGINATOR OF TREE SURGERY, OFFERS FREE INSPECTION

AND ESTIMATE.



SAN FRANCISCO
Russ Bldg. SUTter 3377

FRESNO
Mottei Bldg.

LOS ANGELES
Story Bldg. TUCKer 1929

Local phones in: Pasadena, Palo Alto,
Oakland, San Rafael, San Mateo

SKILL - KNOWLEDGE -
RESPONSIBILITY

THE TORMEY
COMPANY

GENERAL PAINTERS
AND DECORATORS

—
Phone UNderhill 1913

—
563 FULTON STREET
San Francisco

Donovan Automatic
Awning Type
Windows

Give 100% natural ventilation
and day-lighting control

•
UNIVERSAL WINDOW
COMPANY
Berkeley, California



SANTA MARIA INN

Santa Maria, California

*On the Coast Highway
between*

Los Angeles and San Francisco

OVER NIGHT

or

JUST A MEAL

FRANK J. MCCOY, *Owner*

Geo. A. Thompson, *Manager*

El Encanto Hotel

Santa Barbara

*On the Riviera, above the
Old Mission*

Frank J. McCoy, *Owner*

Fred F. Pimental, *Manager*

Independent Iron Works

Structural Steel

Ornamental Iron

Steel Service Stations

Steel Tanks

Standard Steel Mill Buildings

Bridges



821 Pine Street

Oakland

Clinton Construction Co.

of California

*General -
Contractors*



923 Folsom Street

San Francisco

SUtter 3440

before losing consciousness. Inspection of the wrecked car showed a blown-out exhaust gasket and several small holes in the dash. Undoubtedly, engine gases caused partial asphyxiation of the driver.

The following conclusions were reached:

1. Carbon monoxide asphyxiation is responsible for many otherwise inexplicable highway accidents.

2. The underlying cause of this hazard is the escape of exhaust gases from leaks in the exhaust system and their entrance into the car in dangerous quantities.

3. The exhaust systems of motor vehicles should be checked carefully and frequently to detect any defects from which gases may escape before reaching the outlet. Immediate correction of such defects is essential to the safety of the motoring public, as well as of the driver and passengers in the defective car.

4. Exhaust pipes should be extended to the extreme rear end of the automobile, to provide for unobstructed discharge and dissipation of exhaust gases.

5. Mufflers should be constructed of heavy metal, capable of withstanding ordinary wear and tear and the corrosive gases. Rigid gas-tight connections should be provided between the muffler and exhaust pipes.

6. Keeping windows open while driving is not in itself insurance against carbon monoxide asphyxia.

7. There is little, if any danger of carbon monoxide asphyxiation while driving along the highway, regardless of weather or road conditions or window adjustments, provided the exhaust system is free from leaks. — From California State Department of Public Health Bulletin.

UNLICENSED ARCHITECT'S
SERVICES INVALID

An architect entered into a contract to prepare plans and specifications and superintend the construction of an apartment house to cost between \$30,000 and \$40,000. He represented himself to be an architect and capable of undertaking all such services, and signed all the plans and specifications

ALLEN STRUCTURAL PORCELAIN PANS

The ultimate in porcelain enamel construction.

Details and specifications now available.

FRANK ALLEN

Ferro-Porcelain Construction

320 MARKET ST., SAN FRANCISCO

Melrose Lumber & Supply Co.



LUMBER AND
MILL WORK



46th Ave. and E. 12th St.
Oakland

Phones: FRuitvale 0240 — 0251

ANDERSON & RINGROSE

General Contractors

320 Market Street, San Francisco

Phone GARfield 2245

HIGH GRADE MILLWORK
AND INTERIOR FINISH
SASH AND DOORS

LANNOM BROS. MFG. CO.

FIFTH AND MAGNOLIA STREETS
OAKLAND, CALIFORNIA

Telephone: TEMplebar 3663

MULLEN MFG. COMPANY

BANK, STORE AND OFFICE
FIXTURES—CABINET WORK
OF GUARANTEED QUALITY
CHURCH SEATING

Office and Factory:
60-80 RAUSCH ST., Bet. 7th and 8th Sts.
San Francisco
Telephone UNderhill 5815

G. P. W. JENSEN & SON

Building Construction

320 Market Street, San Francisco
Phone: GARfield 2444

DINWIDDIE CONSTRUCTION COMPANY

•
BUILDERS
•

CROCKER BUILDING
SAN FRANCISCO

Carl T. Doell Co.

*Plumbing
Heating*

Plumbing Contractor
Veterans Memorial Building
Oakland

467 21ST STREET
OAKLAND
Telephone GLEncourt 8246

as architect. Although his compensation was to be 10 per cent of the total cost of the building, when the plans and specifications had been drawn and his supervision of the work finished, the owner refused to pay him anything in addition to a small amount that he had already advanced, having learned in the meantime that the architect was not duly licensed under the state law. The architect started suit against the owner for the balance claimed as due him.

The architect claimed that the building had been accepted upon its completion as being planned and constructed with a reasonable degree of skill and substantially free from defects, and that therefore the owner should be compelled to pay the balance of fees in accordance with the contract.

The court, however, refused to listen to the architect's argument when it learned that he was not duly licensed and held that even acceptance of the building by the owner would not render the contract legal, and permit recovery of his fees. In so deciding the court said: "The state statutes do not in express terms make the mere rendering of architectural services by one not holding a license certificate illegal, nor do they in express terms make a contract for such services by one not holding a license certificate unlawful and unenforceable, but the language of the act manifestly expresses the legislative intent that it shall be unlawful for one not holding a license certificate to assume the professional title of architect and as such, enter into a contract to render architectural services. This is what this architect did with reference to the construction of the building. We think there is no escape from the conclusion that the contract for architectural services in this case was illegal and void and wholly unenforceable, leaving the architect and the owner without legal right of recovery thereon." — Stanwood v. Wise, 132 Wash. 295; 232 Pac. 309, 42 A. L. R. 219.

HEATING EXPOSITION

The Sixth International Heating and Ventilating Exposition will be held in Lakeside Hall, Cleveland, Ohio, Jan-

Louis C. Dunn, Inc.

GENERAL
CONTRACTORS

Monadnock Building
San Francisco

Phone: DOuglas 4632

Empire Construction Co., Ltd.

Builders



RUSS BUILDING
SAN FRANCISCO
SUtter 2989

Smith

Lumber Company

WHOLESALE - JOBBING - RETAIL
FACTORY AND BUILDING LUMBER
PLYWOODS - ROOFING

DISTRIBUTING YARDS

San Francisco | Oakland
• | 19th Ave. &
4th & Channel | Estuary
Market 0103 | FRUITvale 3174

YOUR INQUIRIES SOLICITED

SISALKRAFT

REG. U. S. PAT. OFF.

"More than a
building paper"

THE SISALKRAFT CO.

265 West Wacker Drive
(Canal Station) Chicago, Ill.
55 New Montgomery Street
San Francisco, Calif.

ABBOT A. HANKS, INC.
Engineers & Chemists

INSPECTING — TESTING — CONSULTING
CONCRETE • STEEL • MATERIALS
CHEMICAL AND TESTING
LABORATORIES
• RESEARCH AND INVESTIGATION •

TESTS OF STRUCTURAL MATERIALS
DESIGN OF CONCRETE MIXES
SHOP AND ERECTION INSPECTION OF
STRUCTURES AND EQUIPMENT
INVESTIGATION OF STRUCTURES
AND MATERIALS
TESTS AND INVESTIGATION OF
FOUNDATION SOILS
FIRE RESISTANCE AND INSULATION
TESTS

624 Sacramento Street, San Francisco

VAUGHN - G. E. WITT Co.

Manufacturers and Distributors

Pump Governors	Oil Heaters
Safety Pump Governors	Relief Valves
Automatic Gas Regulating Valves	Oil Burner Governors
Gas Burning Equipment	Oil Burners
Vacuum Pump Governors	Oil Pumping Sets
Vacuum Regulating Valves	Oil Valves
Continuous Flow Steam Traps	Oil and Steam Strainers
Thermostats	Duplex Oil Pumps
Reducing Valves	Rotary Oil Pumps
	Boiler Feed Pumps
	Water Heaters
	Boiler Feed-Water Regulators

4224-28 Hollis St., Emeryville, Oakland

**VERMONT
MARBLE
COMPANY**

Producers and Finishers
of

Domestic and Imported
Marbles

San Francisco
Los Angeles
and
Tacoma, Wash.



MERCURY PRESS

We Print
The ARCHITECT and
ENGINEER

"A Thing of Beauty
Is a Joy Forever"

942 HOWARD STREET
SAN FRANCISCO

uary 22 to 26, 1940. The exposition is held under the auspices of the American Society of Heating and Ventilating Engineers.

More than half of the space in the huge exposition hall has been engaged by exhibitors who have taken part in the five previous expositions, the first of which was held at Philadelphia in 1930. Subsequent presentations have been at Cleveland in 1932, New York in 1934, Chicago in 1936, and New York in 1938.

Success of the exposition since its inception in 1930 has involved several important related factors. First, the industries represented are well integrated and the scope of their exhibition is comprehensive, including every type of system and equipment for conditioning the temperature and humidity of every form of interior, from factory to home. Then too, the economic conditions of these industries have been fairly stable, and increasing adoption of air conditioning equipment during the past ten years has given a boom impetus to some sections.

Further, the exposition is looked upon as a market place where competitive equipment can be compared side by side, and much of it can be studied in actual operation. Attendance is made up of building owners and operators, architects and engineers, also contractors and dealers in the heating, ventilating, air conditioning and allied industries. Public utilities are well represented. Out of a total attendance of 40,000 at the last exposition, held two years ago, over 19,000 were executive and administrative personnel, more than 7,000 were in construction fields, 6,000 were engineering or technical men, and 4,000 were engaged in factory or building operation. From the public utilities alone, more than 2,000 representatives attended. Admission is by invitation or by registration. Badges of members of the professional societies co-operating in the event serve also to secure admittance.

Central heating will be represented by exhibits of apparatus and materials designed to provide economical heating and humidification of buildings of every type. Combustion will

**JOSEPH MUSTO
SONS-KEENAN
CO.**

**MARBLE
and ABRASIVES**

ONYX

535 NORTH POINT STREET
SAN FRANCISCO
1801 S. SOTO STREET
LOS ANGELES

THE MOST COMPLETE LINE
OF STEELS AND STEEL BUILDING
MATERIALS MADE BY A
SINGLE PRODUCER



See Sweet's Catalog File or write us for full information.

Republic Steel Corporation
General Offices: Cleveland, Ohio

Denver, Colo. . . Continental Oil Bldg.
Los Angeles, Calif. . . Edison Bldg.
Salt Lake City, Utah . . Walker Bank Bldg.
San Francisco, Calif. . . Rialto Bldg.
Seattle, Wash. . White-Henry-Stuart Bldg.

**JOHN
CASSARETTO**

—Since 1886—And Still Active—

Building Materials

READY MIX CONCRETE
ROCK SAND - GRAVEL - LIME
CEMENT - PLASTER - MORTAR
METAL LATH - WOOD LATH
STUCCO - WIRE NETTING

Service Unexcelled

Bunkers
Sixth and Channel, San Francisco
Phones: GARfield 3176, GARfield 3177

be considered from the standpoint of the fuels utilized, including oil, gas, and coal.

RUNNING FIRE

(Continued from Page 1)

could longer delay his entry into Poland. The strain was too great. For years he had looked over the cornice and seen the parade of humanity and happiness go by and could not throw a bomb. A man can stand about so much. He had reached the limit of self restraint. His hands were itching; his bombs were getting hot. The children were growing up. So he threw his bomb. Then another, and another, and another.

